

OMRON

Handheld 2D Code Reader

V400-H101/201

User's Manual

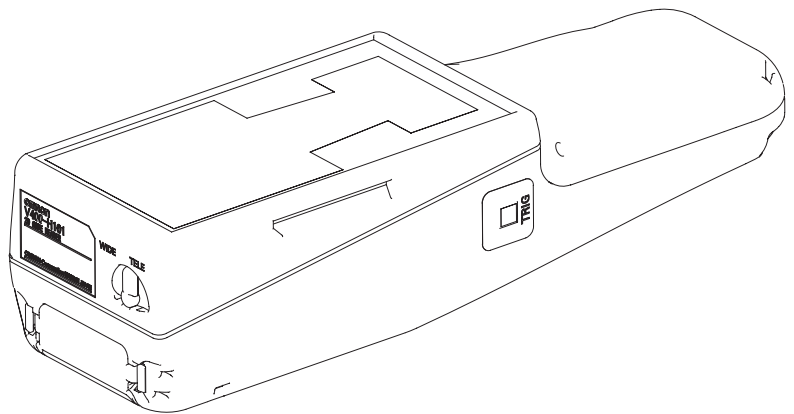
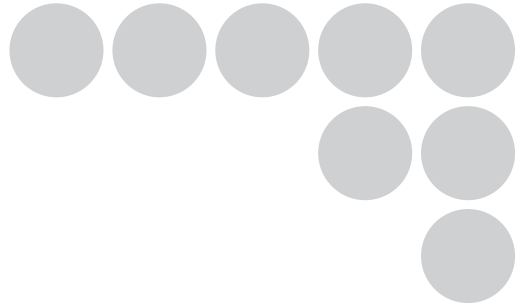

Cat. No. Z222-E1-01

Introduction

Thank you for purchasing the OMRON V400-H101/H201.
This manual describes the functions, performance, and application methods of the V400-H101/H201.

This manual is intended for personnel with knowledge of electrical systems. Be sure to read and understand this manual thoroughly before using the product, and keep this manual in an easily accessible location for quick reference when required.

Introduction	Application Considerations (Read and understand this information first.)	Introduction
Section 1	Product Overview	Section 1
Section 2	Installation and Connections	Section 2
Section 3	Reading 2D Code	Section 3
Section 4	System Settings	Section 4
Section 5	Troubleshooting	Section 5
Appendices	Specifications and Dimensions	Appendices

Handheld 2D Code Reader User's Manual

V400-H101/201

READ AND UNDERSTAND THIS DOCUMENT

Please read and understand this document before using the products. Please consult your OMRON representative if you have any questions or comments.

WARRANTY

OMRON's exclusive warranty is that the products are free from defects in materials and workmanship for a period of one year (or other period if specified) from date of sale by OMRON.

OMRON MAKES NO WARRANTY OR REPRESENTATION, EXPRESS OR IMPLIED, REGARDING NON-INFRINGEMENT, MERCHANTABILITY, OR FITNESS FOR PARTICULAR PURPOSE OF THE PRODUCTS. ANY BUYER OR USER ACKNOWLEDGES THAT THE BUYER OR USER ALONE HAS DETERMINED THAT THE PRODUCTS WILL SUITABLY MEET THE REQUIREMENTS OF THEIR INTENDED USE. OMRON DISCLAIMS ALL OTHER WARRANTIES, EXPRESS OR IMPLIED.

LIMITATIONS OF LIABILITY

OMRON SHALL NOT BE RESPONSIBLE FOR SPECIAL, INDIRECT, OR CONSEQUENTIAL DAMAGES, LOSS OF PROFITS OR COMMERCIAL LOSS IN ANY WAY CONNECTED WITH THE PRODUCTS, WHETHER SUCH CLAIM IS BASED ON CONTRACT, WARRANTY, NEGLIGENCE, OR STRICT LIABILITY.

In no event shall responsibility of OMRON for any act exceed the individual price of the product on which liability is asserted.

IN NO EVENT SHALL OMRON BE RESPONSIBLE FOR WARRANTY, REPAIR, OR OTHER CLAIMS REGARDING THE PRODUCTS UNLESS OMRON'S ANALYSIS CONFIRMS THAT THE PRODUCTS WERE PROPERLY HANDLED, STORED, INSTALLED, AND MAINTAINED AND NOT SUBJECT TO CONTAMINATION, ABUSE, MISUSE, OR INAPPROPRIATE MODIFICATION OR REPAIR.

SUITABILITY FOR USE

THE PRODUCTS CONTAINED IN THIS DOCUMENT ARE NOT SAFETY RATED. THEY ARE NOT DESIGNED OR RATED FOR ENSURING SAFETY OF PERSONS, AND SHOULD NOT BE RELIED UPON AS A SAFETY COMPONENT OR PROTECTIVE DEVICE FOR SUCH PURPOSES. Please refer to separate catalogs for OMRON's safety rated products.

OMRON shall not be responsible for conformity with any standards, codes, or regulations that apply to the combination of products in the customer's application or use of the product.

At the customer's request, OMRON will provide applicable third party certification documents identifying ratings and limitations of use that apply to the products. This information by itself is not sufficient for a complete determination of the suitability of the products in combination with the end product, machine, system, or other application or use.

The following are some examples of applications for which particular attention must be given. This is not intended to be an exhaustive list of all possible uses of the products, nor is it intended to imply that the uses listed may be suitable for the products:

- Outdoor use, uses involving potential chemical contamination or electrical interference, or conditions or uses not described in this document.

- Nuclear energy control systems, combustion systems, railroad systems, aviation systems, medical equipment, amusement machines, vehicles, safety equipment, and installations subject to separate industry or government regulations.
- Systems, machines, and equipment that could present a risk to life or property.

Please know and observe all prohibitions of use applicable to the products.

NEVER USE THE PRODUCTS FOR AN APPLICATION INVOLVING SERIOUS RISK TO LIFE OR PROPERTY WITHOUT ENSURING THAT THE SYSTEM AS A WHOLE HAS BEEN DESIGNED TO ADDRESS THE RISKS, AND THAT THE OMRON PRODUCT IS PROPERLY RATED AND INSTALLED FOR THE INTENDED USE WITHIN THE OVERALL EQUIPMENT OR SYSTEM.

PERFORMANCE DATA

Performance data given in this document is provided as a guide for the user in determining suitability and does not constitute a warranty. It may represent the result of OMRON's test conditions, and the users must correlate it to actual application requirements. Actual performance is subject to the OMRON Warranty and Limitations of Liability.

CHANGE IN SPECIFICATIONS

Product specifications and accessories may be changed at any time based on improvements and other reasons.

It is our practice to change model numbers when published ratings or features are changed, or when significant construction changes are made. However, some specifications of the product may be changed without any notice. When in doubt, special model numbers may be assigned to fix or establish key specifications for your application on your request. Please consult with your OMRON representative at any time to confirm actual specifications of purchased products.

DIMENSIONS AND WEIGHTS

Dimensions and weights are nominal and are not to be used for manufacturing purposes, even when tolerances are shown.

ERRORS AND OMISSIONS

The information in this document has been carefully checked and is believed to be accurate; however, no responsibility is assumed for clerical, typographical, or proofreading errors, or omissions.

PROGRAMMABLE PRODUCTS

OMRON shall not be responsible for the user's programming of a programmable product, or any consequence thereof.

COPYRIGHT AND COPY PERMISSION

This document shall not be copied for sales or promotions without permission.

This document is protected by copyright and is intended solely for use in conjunction with the product. Please notify us before copying or reproducing this document in any manner, for any other purpose. If copying or transmitting this document to another, please copy or transmit it in its entirety.

Meanings of Signal Words

In this manual, precautions are indicated using the following symbols and signal words to ensure safe use of the V400-H101/H201. The precautions indicated by these symbols and signal words are important for safety and must be observed.



WARNING

Indicates a potentially hazardous situation which, if not avoided, will result in minor or moderate injury, or may result in serious injury or death. Additionally there may be significant property damage.

Meanings of Alert Symbols



Indicates the possibility of explosion under specific conditions.



Indicates general prohibitions for which there is no specific symbol.

Alert Statements in this Manual

● WARNINGS



WARNING

This product is not designed or rated for ensuring safety of persons and cannot be used in safety applications designed to either directly or indirectly detect persons. Do not use it for such purposes.



A lithium battery is built into the Controller and may occasionally combust, explode, or burn if not treated properly, which may occasionally result in serious injury. Dispose of the Controller as industrial waste, and never disassemble, apply pressure that would deform, heat to 100°C or higher, or incinerate the Controller.



Regulations and Standards

The V400-H101/H201 complies with the international regulations and standards listed below.

EC Directives	EMC Directive:No.89/336/EEC
EN Standards (European Standards)	EN61326: 1997, +A1: 1998 +A2: 2001 (EMI: Class A) Power line: 10 m max. Signal line: 30 m max.

Precautions for Safe Use

Observe the following precautions to ensure safe use of the product.

■ Installation Environment Precautions

- Do not use the product in environments with flammable or explosive gases.
- Do not install outdoors.

■ Power Supply and Wiring Precautions

- Use the product with the power supply voltages specified in this manual.
- Use the cables specified in this manual.
- Keep the power supply cable as short as possible (10 m maximum).
- Use a DC power supply with countermeasures against high-voltage spikes (safe extra low-voltage circuits on the secondary side).

 p.26

■ Other Precautions

- Do not attempt to disassemble, repair, or modify the product. Doing so may cause product failure or a fire.
- If the product becomes extremely hot, or abnormal odors or smoke occurs, stop using the product immediately, turn OFF the power, and consult with your OMRON representative.
- Dispose of the product as industrial waste.
- Do not apply pressure or deform the product when disposing of it.

Precautions for Correct Use

Always observe the following precautions to prevent operation failures, malfunctions, and adverse effects on performance and equipment.

■ Operating Environment

Do not install the product in the following locations:

- Locations subject to ambient temperature that exceeds the rated temperature range
- Locations subject to rapid changes in temperature (causing condensation)
- Locations subject to relative humidity that exceeds the rated humidity range
- Locations subject to corrosive or flammable gases
- Locations subject to dust, salt, or metallic powder
- Locations subject to direct vibration or shock outside the specified ranges
- Locations subject to direct sunlight
- Locations subject to oil or chemical spray

■ Installation and Handling of Components

- Use the cables specified in this manual.

 p.18

■ Connecting and Removing Cables

- Do not connect a cable to the Handheld 2D Code Reader if the other end of the cable is connected to a personal computer or a Programmable Controller.
- To prevent damage from static electricity, use a wrist strap or another device for preventing electrostatic charges when touching terminals or signal lines inside connectors.

■ Memory Cards

- Do not remove the Memory Card when the Memory Card indicator is lit. Doing so may result in damage to the Memory Card or the Handheld 2D Code Reader.
- OMRON shall not be responsible in any way for damage or loss of Memory Card data as a result of mishandling.

 p.29

■ Turning OFF the Power Supply

- Do not turn OFF the power supply while a message is being displayed indicating that processing is being performed. Data in memory will be destroyed, and the product may not operate correctly the next time it is started.

How to Use This Manual

Page Format

Section Title

Outline

Move to the Setting Screen.

Screen display

Index label

Provides the section number and subject matter. Can be used to immediately open the desired page.

Describes the settings.

Section 4
System Settings

Section 4
Creating Setting Files Using the 2DCR Config

46 V400-H101/201
User's Manual

48 V400-H101/201
User's Manual

Creating Setting Files Using the 2DCR Config

Create the data setting file for loading setting data to the Handheld 2D Code Reader. Make the settings for the communications conditions, functions, and display conversion.

Select **Setting Reader - Create Setting Data** from the menu.

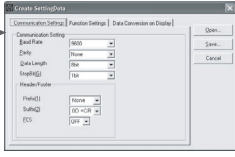

- **Open**
Opens the previously created data setting file for editing.
- **Save**
Saves the created data setting file.

 **CHECK!**
To save data to the Memory Card, create a folder with the name **SETTINGS**, and save. The Handheld 2D Code Reader's setting mode cannot start if the data is saved in a folder of a different name.

Communications Settings

The settings shown in the following table are set in the Communications Settings Tab Page in the Create Setting Data Window.

Setting Item	Settings
Baud Rate	9600*, 19,200, or 38,400
Parity	None*, odd, or even
Data Length	7 bits or 8 bits*
Stop Bit	1 bit* or 2 bits
Header/Footer	Prefix: None*, 02 <STX> or 1B <ESC> Suffix: 03 <ETX>, 0A <LF>, 0D <CR>, or 0D0A <CR><LF> FCS: ON or OFF*

The asterisks indicate default settings.

Procedure and additional explanations

Information useful during the operation and reference pages are provided here with special marks to indicate the kind of information being provided.



*This page does not actually exist in this manual.

Visual Aids



Indicates points that are important in using product functions or in application procedures.

CHECK!



Indicates page numbers providing related information.



Indicates helpful information when a problem occurs and explanations of technical terms.

Internet Information

Information on the Handheld 2D Code Reader is available on the Internet.
Contact the OMRON representative nearest you regarding the website address.

Table of Contents

Introduction	2
Application Considerations (Read and understand this information first.)	2
Meanings of Signal Words	4
Regulations and Standards	5
Precautions for Safe Use	5
Precautions for Correct Use	6
How to Use This Manual	7
Visual Aids	7
Internet Information	8
Table of Contents	9
<hr/>	
Section 1 Product Overview	11
Features	12
Operation Overview	15
<hr/>	
Section 2 Installation and Connections	17
Basic System Configuration	18
Component Names and Functions	19
Cable	20
Power Supply	26
Contactor (Optional)	27
Stand (Optional)	28
Memory Cards	29

Section 3 Reading 2D Code	31
Basic Operation	32
Startup	33
Reading 2D Code	34
Outputting Results	35
Functions	37
Section 4 System Settings	39
Overview	40
Installing the 2DCR Configear	41
Communications Using the 2DCR Configear	43
Creating Setting Files Using the 2DCR Configear	46
Uploading from the Memory Card	52
Section 5 Troubleshooting	55
Troubleshooting	56
Appendices	57
Maintenance	58
Specifications and Dimensions	59
ASCII Table	64
FCS Calculation Method	65
Data Capacity Tables	67
Revision History	70

Section 1

Product Overview

This section provides an introduction to the Handheld 2D Code Reader's features, functions, basic configuration, and operation flow.

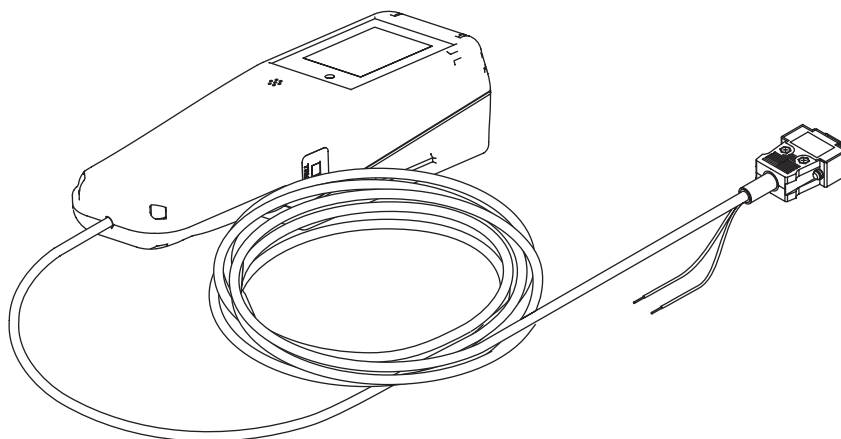

▣ Features	12
▣ Operation Overview	15

Features



The 2D Code Reader is designed to read two-dimensional code. A built-in monitor and zoom lens are ideal for reading directly marked 2D code. A Memory Card Slot is also provided along with a range of useful functions.

Readable Codes

Readable codes	DataMatrix	QR Code
		
Readable sizes (symbol size)	<ul style="list-style-type: none"> ECC200 10 × 10 to 64 × 64 8 × 18 to 16 × 48 	Model 1 or 2 21 × 21 to 57 × 57 (Version 1 to Version 10)

Zoom Lens (Manual)

The zoom lever can be used to change the field of view, enabling a variety of applications with a single Unit. Two lens variations provide wide-angle and telescopic views, covering all viewing needs from paper level to complicated code.

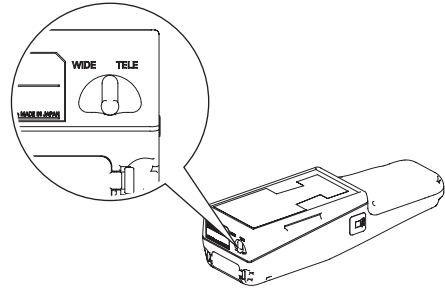

Dual System Lighting

Coaxial lighting and oblique lighting are provided in a single Unit. The type of the lighting is automatically selected.

- V400-H101 RGB 3 color coaxial, red oblique lighting
- V400-H201 Red coaxial, red oblique lighting

Workpieces with different optical characteristics can be read with a single Unit, and workpieces with a range of direct markings can also be read.

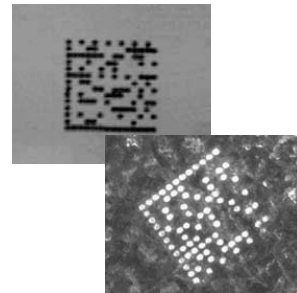

Liquid Crystal Display

The Handheld 2D Code Reader is equipped with a 1.8-inch Liquid Crystal Monitor, enabling you to view an image of positioning while reading.

The Handheld 2D Code Reader enables confirmation of read data and images, previously not possible with handheld readers.

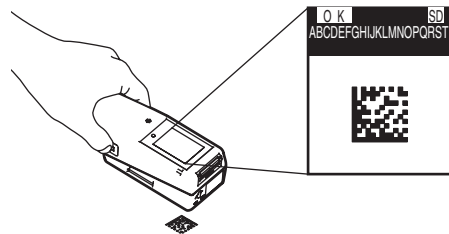

Memory Card Slot

A Memory Card slot is provided to back up settings on Memory Cards and upload data from Memory Cards. A function is also provided for saving 2D code data that was read as files in the Memory Card.

 p.29

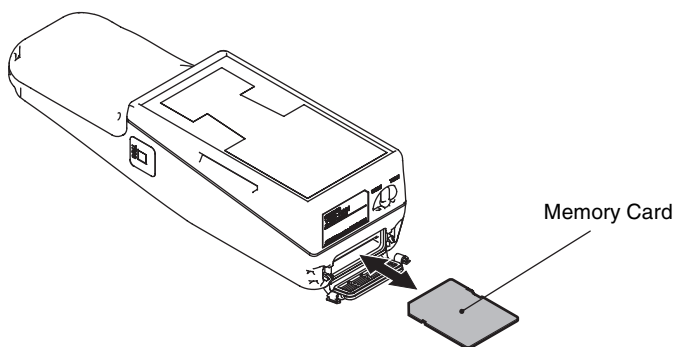

Useful Functions

■ Data Conversion on Display

This function converts data that is read and displays it as a separate text string.

 p.49

■ Data Accumulation

This function writes data that is read to the Memory Card.

 p.48

Operation Overview

Installation and Connections

 Section 2 p.17

Prepare the required components and connect them.

Main Peripheral Devices

- Cable
- Power supply device
- Contactor
- Stand

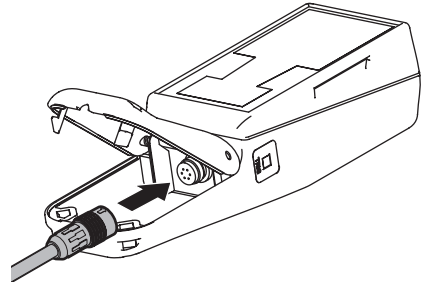

Reading 2D Code

 Section 3 p.31

Turn ON the power and press the trigger buttons to read the code.

- Reading method
- Field of view setting
- Display details

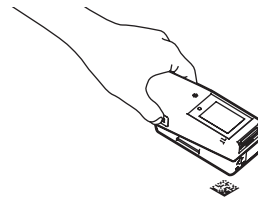

System Settings

 Section 4 p.39

Basic settings for the Handheld 2D Code Reader are not required, but settings must be changed using the Special Tool 2DCR Configear under the following circumstances.

- To change the communication conditions (See note.)
- To use various functions

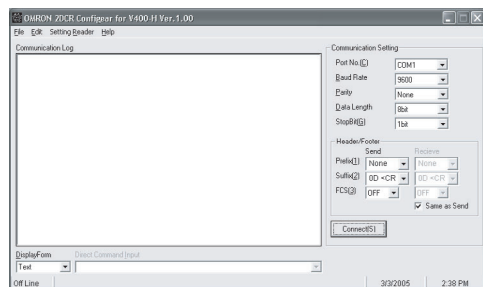

These settings can be changed in the Handheld 2D Code Reader using a Memory Card or the communications functions of the 2DCR Configear.

Note: The default settings are as follows:

Baud rate: 9,600 bps; Parity: None; Data length: 8 bits; Stop bits: 1 bit

MEMO

Section 2

Installation and Connections

This section describes the methods used to connect cables and perform other installation procedures and connections.

☒ Basic System Configuration	18
☒ Component Names and Functions	19
☒ Cable	20
☒ Power Supply	26
☒ Contactor (Optional)	27
☒ Stand (Optional)	28
☒ Memory Cards	29





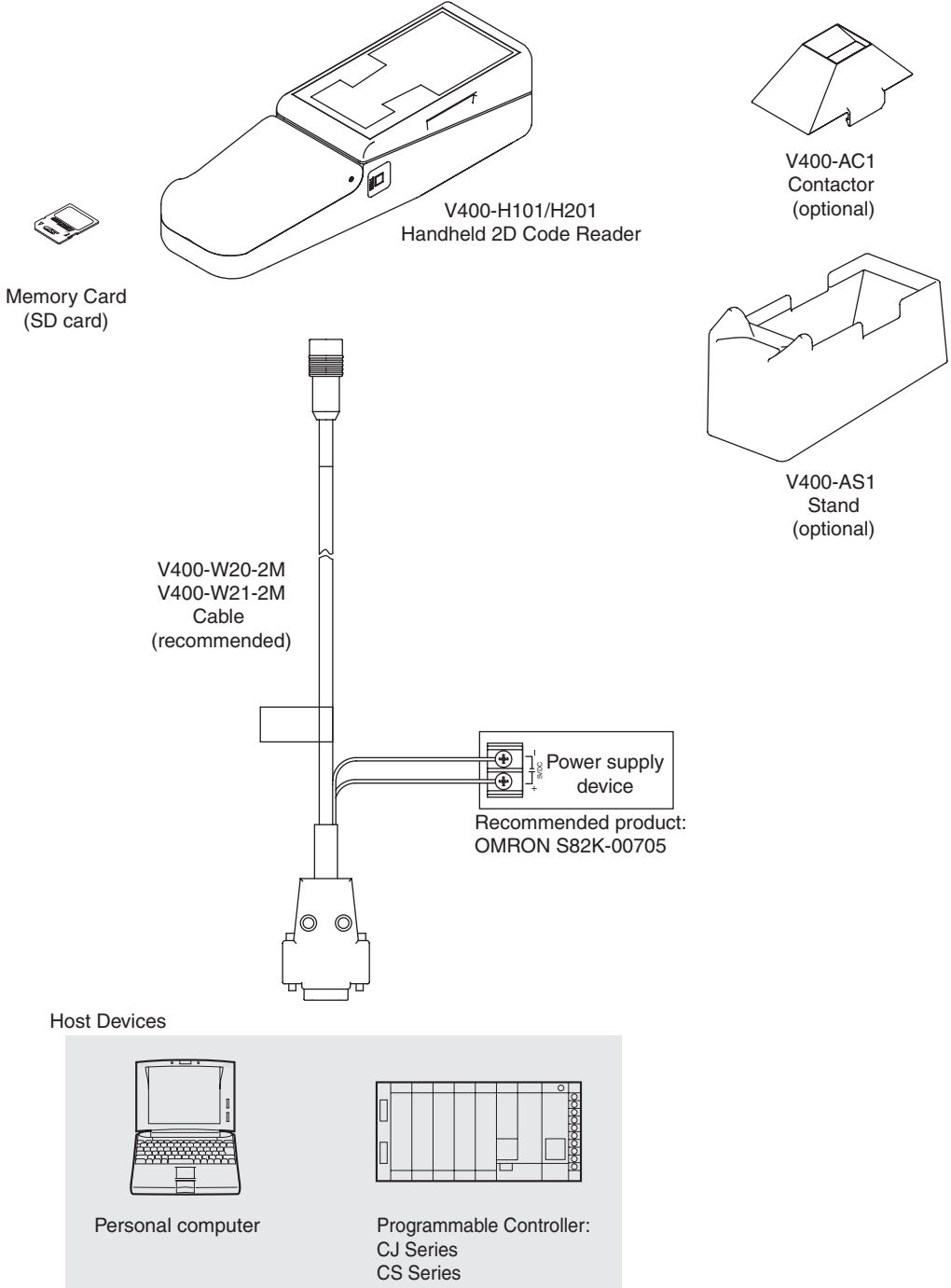

Basic System Configuration

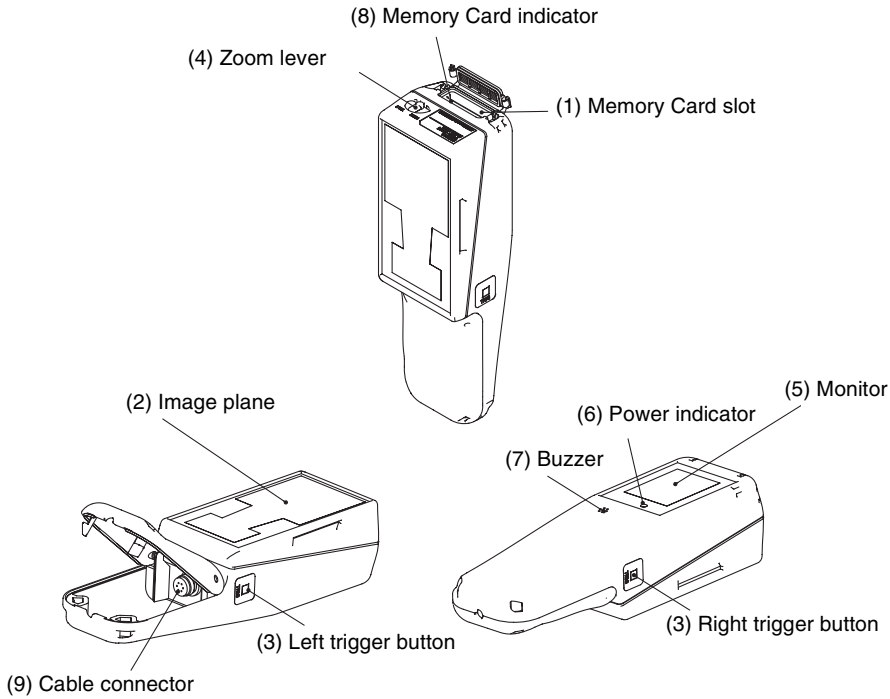
The basic system configuration is shown in the following diagram.



Component Names and Functions



Name	Details
(1) Memory Card slot	Slot for inserting Memory Card.
(2) Image plane	Camera image plane
(3) Trigger buttons (Right, Left)	Cancels sleep state for a trigger input or when setting mode is entered.  p.34
(4) Zoom lever	Changes the field of view.
(5) Monitor	Displays the read image/results, and other data.  p.35
(6) Power indicator	Lit when power is first turned ON and remains lit during operation.  p.35
(7) Buzzer	A high- or low-tone buzzer sounds depending on the operation.  p.33
(8) Memory Card indicator	Lit while the Memory Card is being accessed. (Do not remove the Memory Card if the indicator is lit.)  p.35
(9) Cable connector	Connects to a V400-W20-2M or V400-W21-2M Cable.  p.22

Cable

The Cables are specifically designed for the V400. Using other Cables may damage the devices.

Connecting a Personal Computer (V400-W21-2M Cable)

V400-H101/H201
Handheld 2D Code Reader

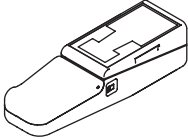

V400-W21-2M
Cable

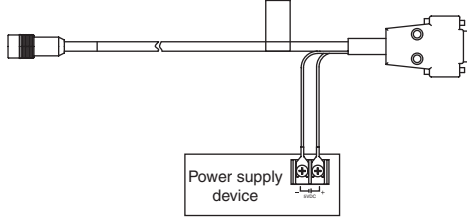

Host device



Personal computer

Recommended product:
OMRON S82K-00705

● Connector

The connector used for V400-W21-2M Cable is a D-sub, 9-pin connector (female).

The connector is compatible with the connection port on the IBM PC/AT or compatible.

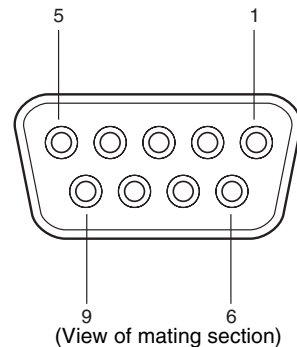
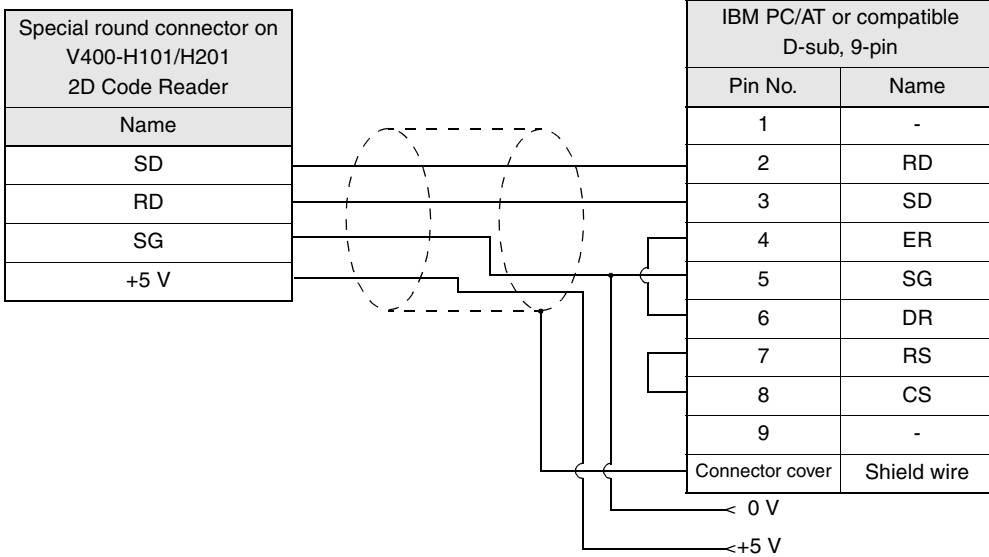

Connecting a Programmable Controller (V400-W20-2M Cable)

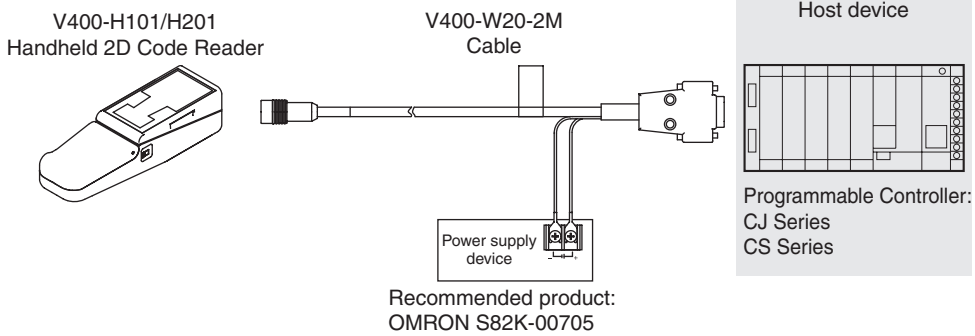

● Connector

The connector used for V400-W20-2M Cable is a D-sub, 9-pin connector (male).

The connector is compatible with the connection port on OMRON CJ-series and CS-series Programmable Controller.

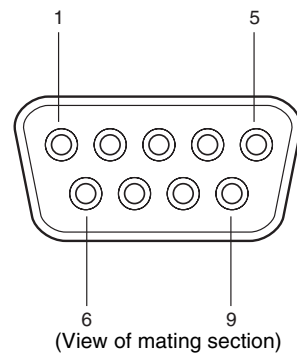
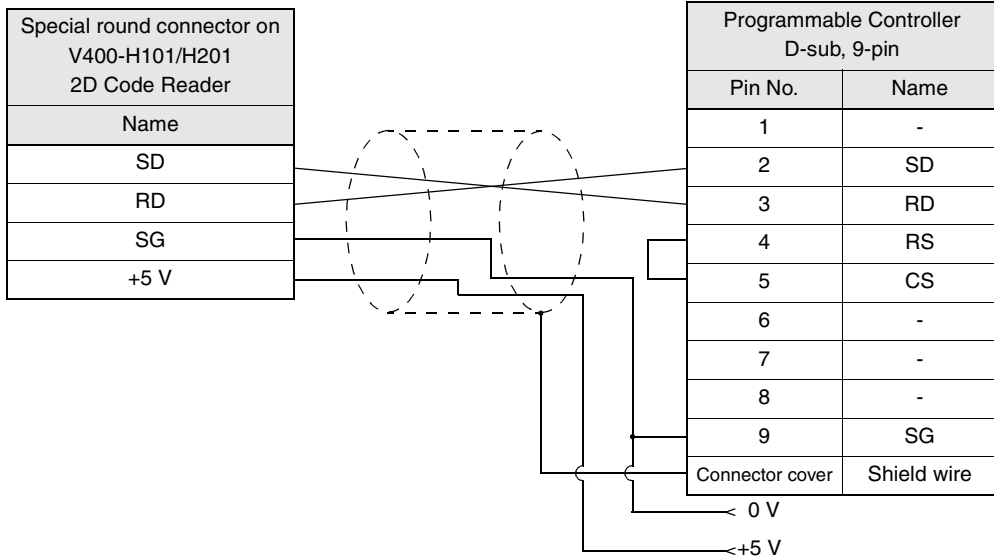

Connecting Cables to the Handheld 2D Code Reader



Connect one end of the cable to a personal computer or Programmable Controller before connecting the other end of the cable to the Handheld 2D Code Reader.

CHECK!

1. Attach the provided ferrite cores to the cable.

Attach the ferrite cores in two locations; one at the Handheld 2D Code Reader end of the cable, and the other at the host device end of the cable.

Close the ferrite cores until a click is heard. Separate from the power lines.

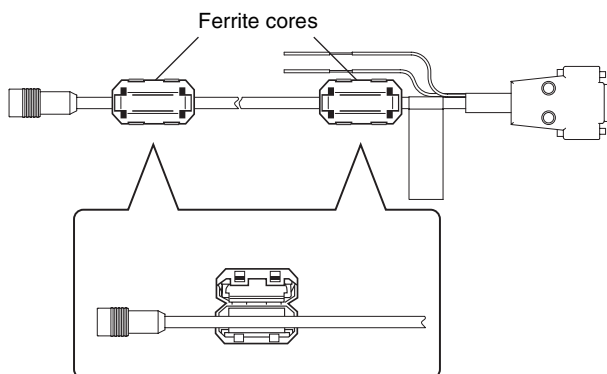

2. Connect the cable.

Grasp the cable plug (part A). Line up the alignment mark on the plug with the alignment mark on the Handheld 2D Code Reader connector and push the plug in straight.

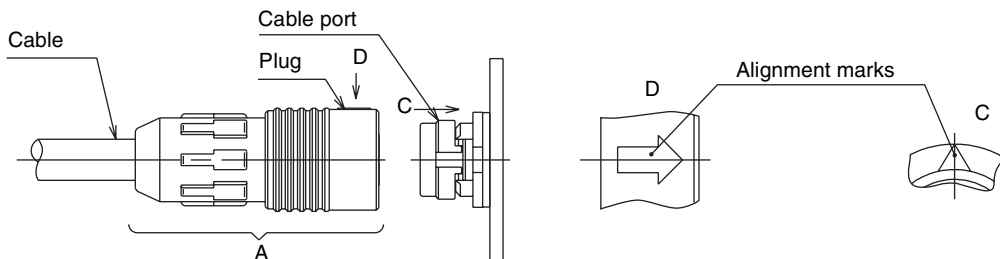
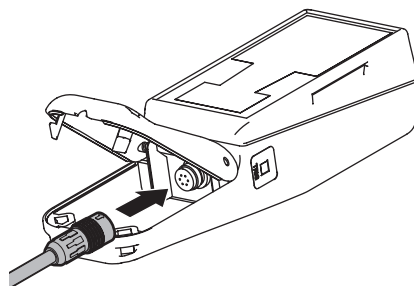



Use a force of no more than 15 to 20 N to plug in the connector. Pull gently on the cable (approximately 10 N) to make sure the connector is securely connected. After the connector is plugged in, do not apply a force of more than 30 N to the connector in the following directions. Excessive force will damage the connector.

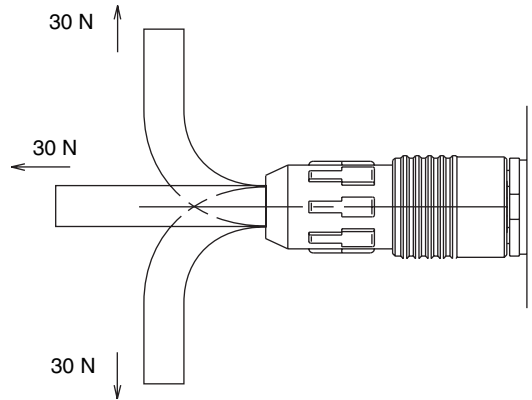

-
3. Place the cable in the groove provided for it in the case.

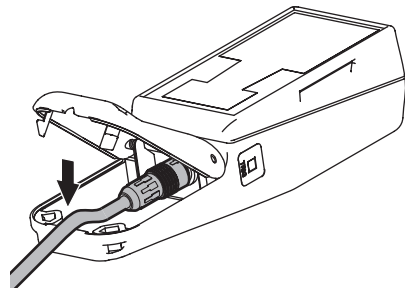

-
4. Close the cover.



Keep fingers clear when closing the case to prevent the case closing on them.

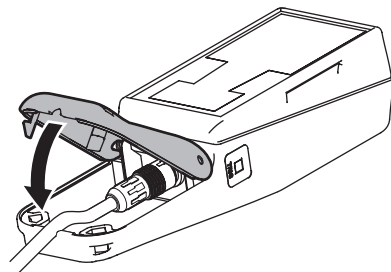

Disconnecting the Cable from the Handheld 2D Code Reader

1. Disconnect the cable connector from the host device.



2. Open the cover.

Press down on the indentations on both sides of the cover as you open it.



Do not apply excessive force to the cover.

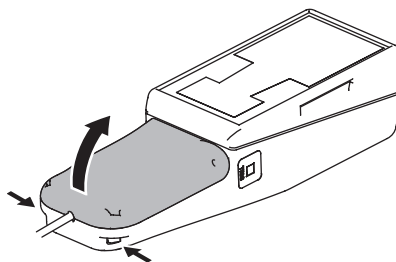

3. Disconnect the cable.

Grasp the coupling (part B) on the plug and pull the plug out straight as shown in the diagram below.

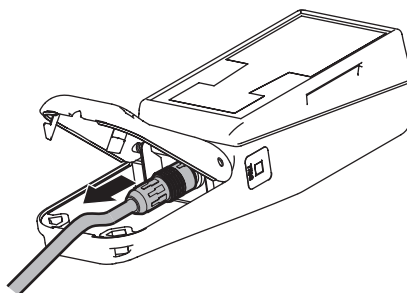
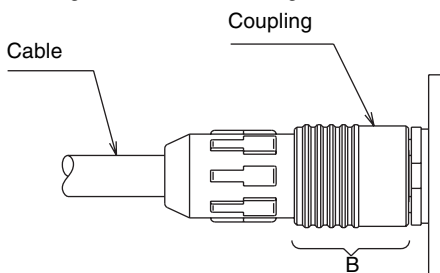

4. Close the cover.



Keep fingers clear when closing the case to prevent the case closing on them.

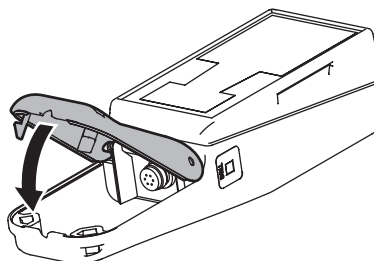

Connecting the Cable to the Host Device

1. Connect the cable connector to the RS-232C interface on the host device, making sure that the connector is oriented correctly and not inserted at an angle. Secure the connector using the screws on both sides of the connector.

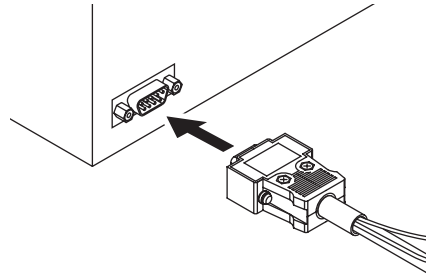

Removing the Cable from the Host Device

1. Remove the cable.
Loosen the screws on both sides of the connector and pull the connector out straight.



CHECK!

Be sure to loosen the screws on both sides of the connector sufficiently before removing the connector and do not use excessive force.

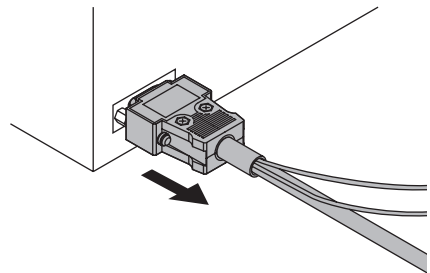

Power Supply

Power must be supplied to the V400-H101/H201 via the cable. Wire the power supply independently of other devices. In particular, keep the power supply wired separately from inductive loads. Use a power supply that meets the following requirements.

Power Supply Requirements

Output current	Power supply voltage
1 A min.	5 VDC \pm 10%

Recommended Power Supply

Model
S82K-00705



Use a DC power supply with safe extra-low-voltage circuits to prevent high voltage. If UL recognition is required for the overall system, use a UL Class II DC power supply.

CHECK!

■ Connection Method

Wire the power supply cables as shown in the following diagram.

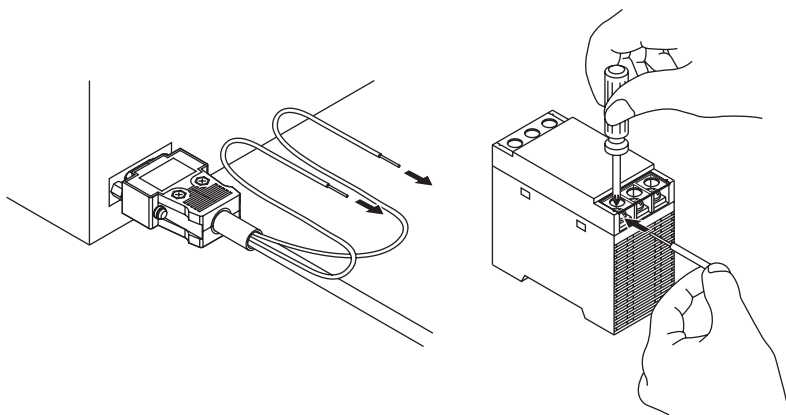

Connect the brown wire to the positive (+) side of the power supply and connect the blue wire to the negative (-) side of the power supply.

CHECK!

Contactor (Optional)

The Contactor functions as a guide for the distance from the image plane to the code to be read. By making contact with the read code, the read distance can be easily aligned.

Mounting Procedure

1. Align the grips on the Contactor with the grooves on the Handheld 2D Code Reader to mount it.



CHECK!

Mount by clicking the notches of the grips into the grooves of the Handheld 2D Code Reader.

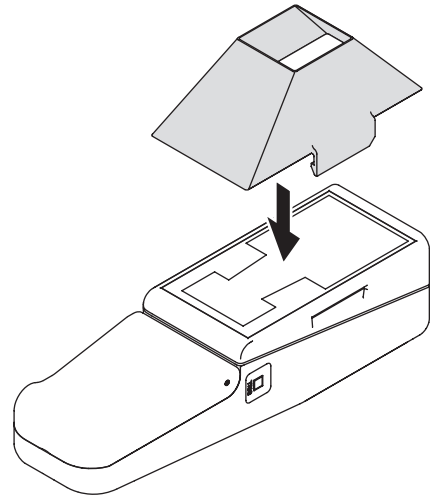

Removal Procedure

1. Remove the grips of the Contactor from the grooves on the Handheld 2D Code Reader pulling in the direction of the arrow shown in the diagram on the right



CHECK!

Do not use excessive force when removing the Contactor grips from the grooves.

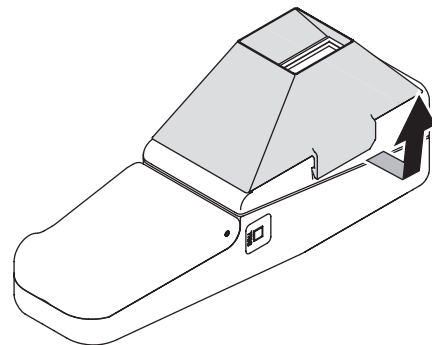

Stand (Optional)

The Stand is for holding the V400-H101/H201.

Mounting Procedure

1. Use two M4 screws to mount the Stand.

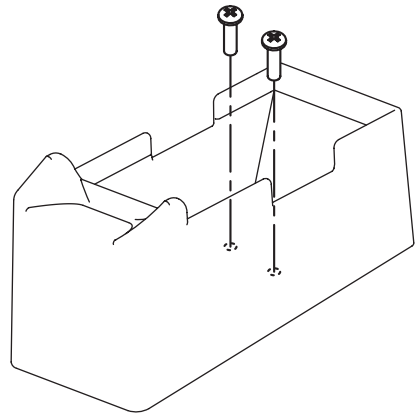
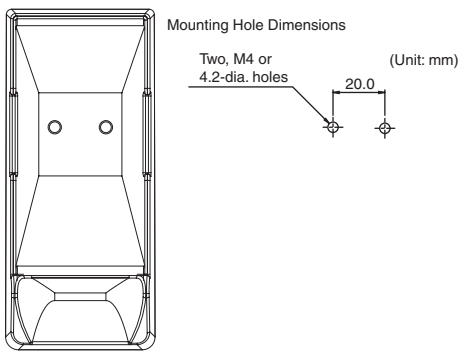

Placing the Handheld 2D Code Reader on the Stand

1. Place the Handheld 2D Code Reader in the Stand as shown in the diagram on the right.

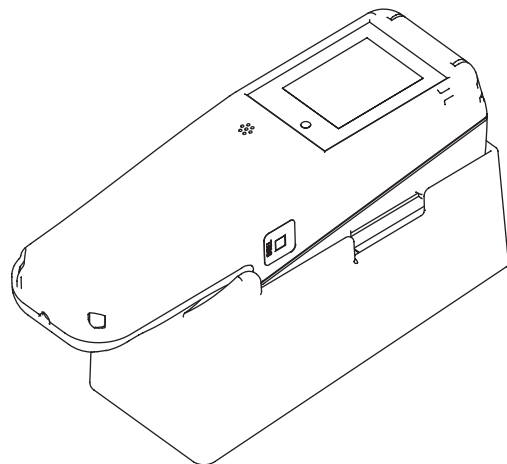

CHECK!

The Stand is designed to be placed on a horizontal surface. Do not mount the Stand to a wall or other similar surface.

Memory Cards

The Handheld 2D Code Reader uses Memory Cards to upload or backup setting data and data to be read. SD Memory Cards are supported.

- Conforms to SD Memory Card "Physical Layer Specification 1.01"
- File format: FAT16

Save the data to the Memory Card, insert the Memory Card in the personal computer, and upload the data to easily backup the data to the personal computer. SD Memory Cards are provided with a write prohibit switch to prohibit writing to or formatting of the Memory Card. When the switch is set to LOCK, data cannot be written to or deleted from the Memory Card, and the Memory Card cannot be formatted. These functions are possible by setting the switch to the unlocked state.

Inserting the Memory Card

1. Open the Memory Card slot cover.



Lift the cover gently, without using excessive force.

CHECK!

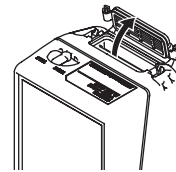

2. Position the Memory Card in the correct direction and insert in the slot until a click is heard.



Insert the Memory Card in the direction with the label side facing the same direction as the monitor of the Handheld 2D Code Reader.

CHECK!

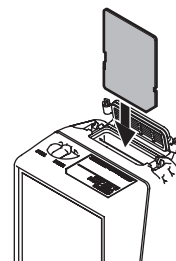

3. Close the Memory Card slot cover.

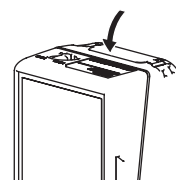

Removing Memory Cards

1. Open the Memory Card slot cover.



Lift the cover gently, without using excessive force.

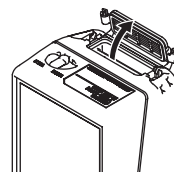

2. Make sure that the indicator on the Memory Card slot is not lit.



Do not remove the Memory Card while the indicator is lit. Doing so may damage the Memory Card and the Handheld 2D Code Reader.

3. Push the Memory Card in gently until a click is heard.

The Memory Card will eject slightly.

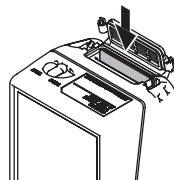

4. Pull out the Memory Card straight.

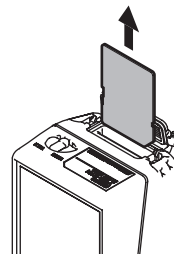



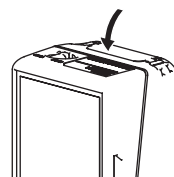

5. Close the Memory Card slot cover.



Section 3

Reading 2D Code

This section provides information required for reading 2D code.

 Basic Operation	32
 Startup	33
 Reading 2D Code	34
 Outputting Results	35
 Functions	37

Basic Operation

Startup

 p.33

Turn ON the power to the power supply device and start the Handheld 2D Code Reader.



Reading 2D Code

 p.34

Press the trigger buttons and keep pressed while moving the Handheld 2D Code Reader close to the 2D code.

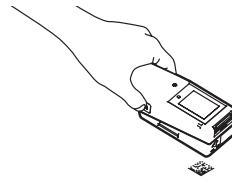

Outputting Results

 p.35

The read data is output to the monitor and RS-232C communications.



CHECK!

If no operation is performed during a fixed interval, the Handheld 2D Code Reader will enter a sleep state. Pressing the trigger buttons will release the sleep state.

Functions

 p.37

The following functions are provided with the Handheld 2D Code Reader.

- Sleep
- Data Conversion on Display
- Data Accumulation

Startup

When the power of the power supply device is turned ON, the screen on the right will be displayed, the power indicator will light, and the buzzer will sound.



■ Buzzer

The buzzer will sound under the following conditions.

- When starting the V400
- When reading is successful
- When operating in setting mode



CHECK!

When the buzzer is set to OFF, the buzzer will not sound for any operation.

Reading 2D Code

■ Trigger Buttons

The trigger buttons on the left and right side of the Handheld 2D Code Reader perform the same operations. When a trigger button is pressed, the 2D Code Reader will start reading code.

■ Trigger Mode

Triggers can be input two different ways. Select the input method to suit the required application.

◆ Level Trigger (Default)

Press and hold the trigger button to read code continuously until code is successfully read or until the trigger button is released.

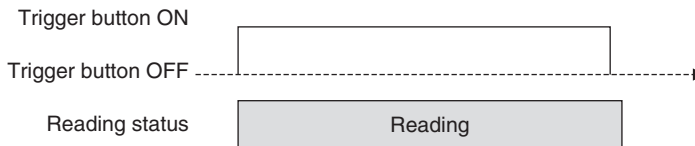

◆ Alternate Trigger

Press the trigger button once to read code continuously until code is successfully read or until the trigger button is pressed again.

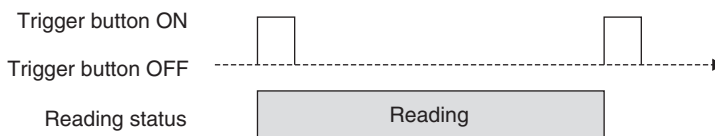

■ Zoom Lever

The zoom lever is used to change the field of vision to suit the size of the code to be read.

Model	Setting range
V400-H101	5 mm (TELE) to 10 mm (WIDE)
V400-H201	15 mm (TELE) to 30 mm (WIDE)

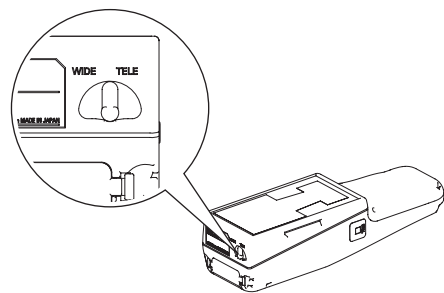

Outputting Results

■ Monitor Description

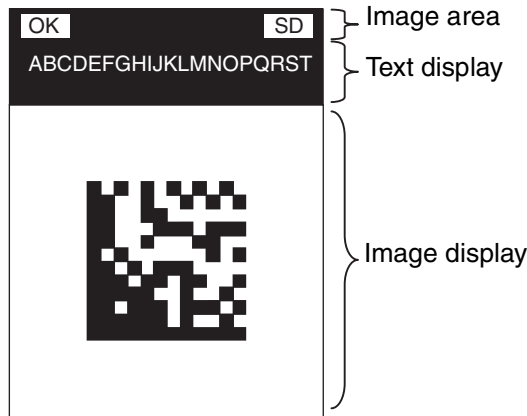

◆ Image Area

This area indicates whether reading was successful and Memory Card status.

Item	Details
OK	Displayed in green on the top left side of the screen when 2D codes are read successfully.
Memory Card	Displays the SD mark when a Memory Card is inserted. Displays the SD mark in red when the Memory Card is active to indicate that the Memory Card is being accessed.

◆ Text Display

This area displays reading results and data converted by the display conversion function. Up to 38 characters can be displayed.

◆ Image Display

This area displays images taken by the Camera.

■ LED Indicators

Indicator	Location	Details
Power	On the bottom of the monitor	Lit when power is turned ON, and remains lit during operation
Memory Card	Beside the Memory Card slot	Lit when the Memory Card is being accessed. Do not remove the Memory Card while this indicator is lit.

■ RS-232C Communications Output

◆ Output for Successful Readings

Read data is output in the following format.

Header	Read data	Footer
--------	-----------	--------

◆ Output for Unsuccessful Readings

Nothing is output with the default setting.

An error code output, however, can be set for unsuccessful readings. (See note.)

Note: NG output setting

When the NG output is set to ON, the output contents can be changed.

Output contents when NG output is ON:

- The NG mark is displayed on the monitor in red.
- The data ?E000 is sent via RS-232C communications.

Header	?E000	Footer
--------	-------	--------

Functions

■ Sleep

The Handheld 2D Code Reader is equipped with a sleep function for reducing power consumption. The Code Reader is automatically set to sleep when operation is not performed for a specified period of time.

- 30 Seconds Lapsed (Default Setting)

Press either of the trigger buttons to return to resume normal operating status from sleep status.

■ Data Conversion on Display

Normally, 2D code data that is read is displayed as is on the monitor. This function compares the read data, converts into separate text strings and displays the converted data.

 p.49



Example display when function is OFF



Example display when function is ON

■ Data Accumulation

The read data is not only output via RS-232C communications, but is created as a file in the Memory Card and saved in CSV format.





 p.48

MEMO

Section 4

System Settings

This section describes the methods used to install and set the 2DCR Configear software.

 Overview	40
 Installing the 2DCR Configear	41
 Communications Using the 2DCR Configear	43
 Creating Setting Files Using the 2DCR Configear	46
 Uploading from the Memory Card	52

Overview

Installing the Setting Software

 p.41

Obtain the 2DCR Configear application software from the Internet and install it on a personal computer.

Creating the Setting File

 p.46

Create the setting file using the 2DCR Configear.
Specify the required settings using the 2DCR Configear, and create as a file.

The following items can be set.

1. Communications settings
2. Function settings

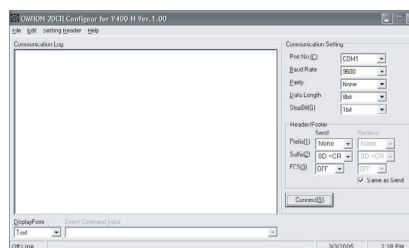

Uploading Data

 p.52

Upload the created setting data to the Handheld 2D Code Reader.

The following two loading methods are available.

- Using the Memory Card
- Using the 2DCR Configear

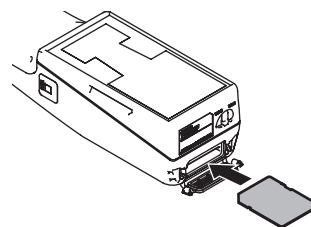

Installing the 2DCR Configear

Obtain the 2DCR Configear and install it on a personal computer.

Contact the OMRON representative nearest you regarding the 2DCR Configear.

1. Open the setup.exe file downloaded from the Sensing Web website.
The following window will be displayed.
2. Click the **OK** Button.

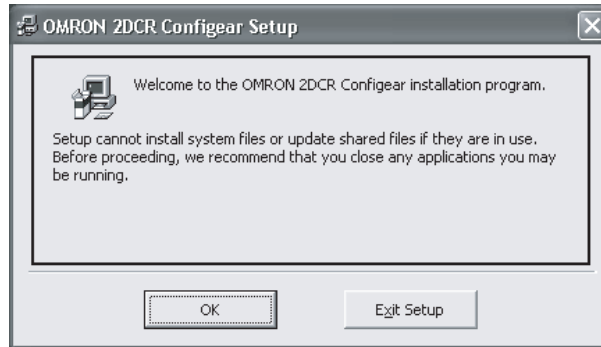

3. Click the  Button.

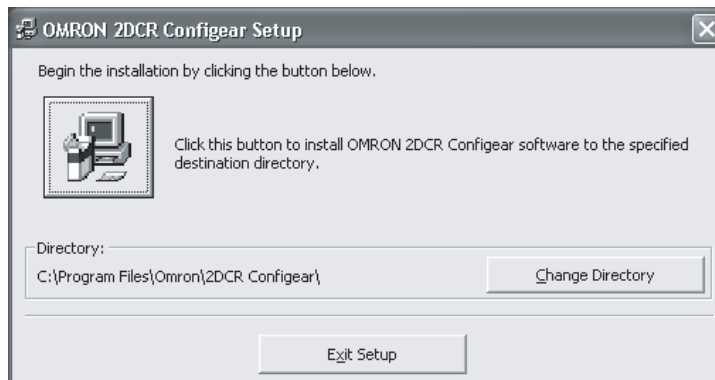

4. Click the **Continue** Button.

Setup will start when the **Continue** Button is clicked.

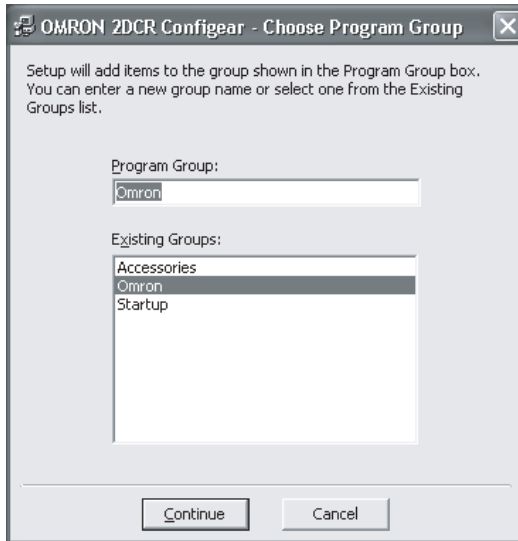

5. Click the **OK** Button.



Communications Using the 2DCR Configear

The 2DCR Configear can be used to communicate with the Handheld 2D Code Reader.

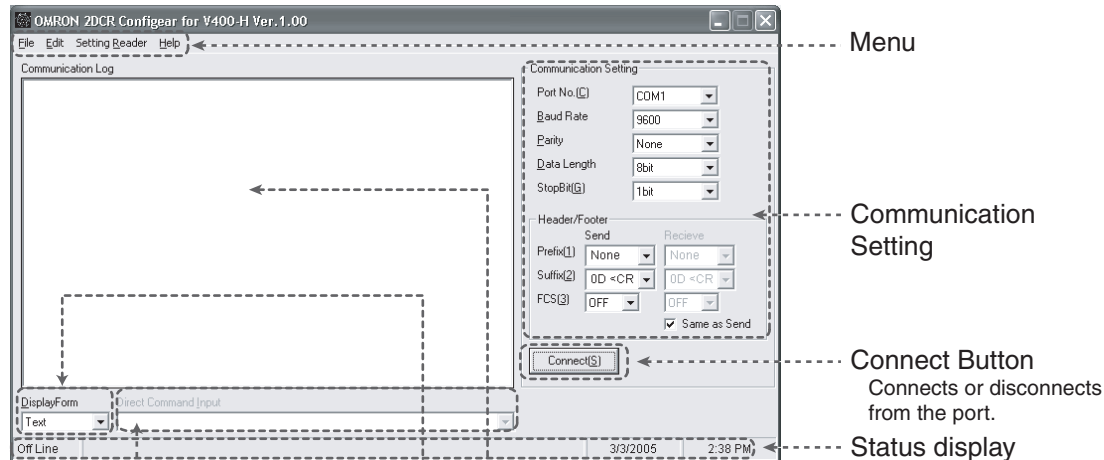

Direct Command Input
Sends the input text string to the Handheld 2D Code Reader.

Display Form
Selects the communication log display format as either text format or hexadecimal.

■ Communication Setting

The following items can be set.

Setting item		Settings	
Port No.		COM1* to COM 9	
Baud Rate		9,600* , 19,200, or 38,400	
Parity		None* , odd, or even	
Data Length		7 bits or 8 bits*	
Stop Bit		1sbit* or 2 bits	
Header/Footer	Prefix	Send	None* , 02 <STX>, or 1B <ESC>
		Receive	None* , 02 <STX>, or 1B <ESC>
	Suffix	Send	03 <ETX>, 0A <LF>, 0D <CR>* , or 0D0A <CR+LF>
		Receive	03 <ETX>, 0A <LF>, 0D <CR>* or 0D0A <CR+LF>
	FCS	Send	ON or OFF*
		Receive	ON or OFF*
Same as Send		Sets the header, footer, and FCS for receiving to the same settings as for sending.	

The default settings are indicated with an asterisk.

Operation is not possible when the port is connected.

■ Menu

◆ File

Save Log...

Saves the data displayed in the communication log as a text file.

Save Environment

Saves the settings made in the communications settings.

End

Ends the 2DCR Configear.

◆ Edit

Copy Log

Copies the log displayed in the communication log to the clipboard.

Erase Log

Deletes the log displayed in the communication log.

◆ Setting Reader

Create Data...

Creates the data setting file for loading set data to the Handheld 2D Code Reader.



p.46

Auto Scan

Automatically obtains the conditions required for communicating with the Handheld 2D Code Reader.

Operation is not possible when the port is connected.

Send Setting

Sends the data setting file from the host to the Handheld 2D Code Reader.

Operation is not possible when the port is disconnected.

Receive Setting

Sends the setting data for the Handheld 2D Code Reader to the host.

Operation is not possible when the port is disconnected.

Set Date, Time

Sends the clock time of the personal computer in which 2DCR Configear is installed to the Handheld 2D Code Reader.

Operation is not possible when the port is disconnected.



CHECK!

The clock is factory set to Japanese Standard Time.

◆ Help

Version

Displays the software version of the 2DCR Configear installed.

■ Buttons

◆ Connect

Connects or disconnects the port.

■ Display Form

Selects the format for displaying data in the communication log.

Either text display or hexadecimal display can be selected. (Default setting: Text display)

■ Direct Command Input

Sends the input text string to the Handheld 2D Code Reader.

Operation is not possible when the port is disconnected.

■ Status Display

◆ On Line/Off Line

Indicates the port status (On Line: Connected; Off Line: Disconnected)

◆ COM1 9600,n,8,1

Displays the current communications conditions.

This is not displayed when the port is disconnected.

◆ 26/1/2005

Displays the current date.

◆ 9:27

Displays the current time.

Creating Setting Files Using the 2DCR Configear

Create the data setting file for loading setting data to the Handheld 2D Code Reader. Make the settings for the communications conditions, functions, and display conversion.

► Select **Setting Reader - Create Data...** from the menu.

The following window for creating the setting data file will be displayed.

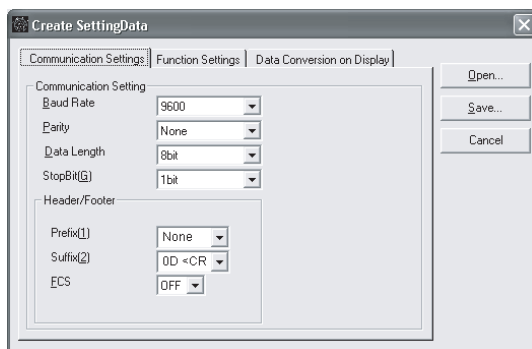

■ Open

Opens the previously created data setting file for editing.

■ Save

Saves the created data setting file.



To save data to the Memory Card, create a folder with the name *SETTINGS*, and save. The Handheld 2D Code Reader's setting mode cannot start if the data is saved in a folder of a different name.

CHECK!

Communication Settings

The settings shown in the following table are set in the Communication Settings Tab Page in the Create Setting Data Window.

Setting item	Settings
Baud Rate	9600* , 19,200, or 38,400
Parity	None* , odd, or even
Data Length	7 bits or 8 bits*
Stop Bit	1 bit* or 2 bits
Header/Footer	Prefix None* , 02 <STX> or 1B <ESC>
	Suffix 03 <ETX>, 0A <LF>, 0D<CR>* , or 0D0A <CR+LF>
	FCS ON or OFF*

The asterisks indicate default settings.

The format when FCS is ON is as follows:

Header (Prefix)	Read data	FCS (2 bytes)	Footer (Suffix)
-----------------	-----------	---------------	-----------------



CHECK!

For details on FCS calculation methods, refer to *FCS Calculation Method*.



p.65

Function Settings

Make the following settings in the Initialize Tab of the Create Setting Data Window.

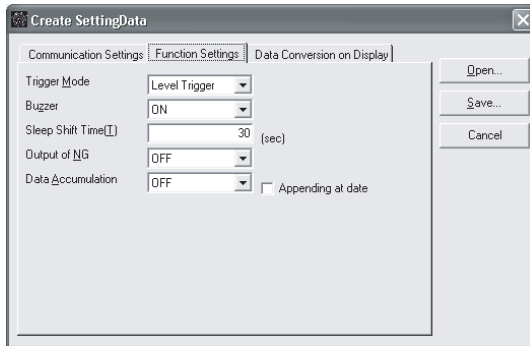

Setting item	Settings
Trigger Mode	Level Trigger* or Alternate
Buzzer	ON* or OFF
Sleep Shift Time	Between 30 sec* and 120 sec
Output of NG	ON or OFF*
Data Accumulation	OFF* or ON

The asterisks indicate default settings.

■ Data Accumulation

Set whether to collect data.

The Memory Card must be inserted in the Handheld 2D Code Reader to use this function.

When this function is ON, read data will be saved in a file with the following name in the Memory Card's READDATA folder. The READDATA folder will be automatically generated if it does not already exist.

READ****.csv

Note. The digits indicated by **** start at 0000 and increment by 1 for approximately each 400 kilobytes.

After reading is completed, the data is written to the Memory Card, which will take several seconds.

When *Appending at date* is selected, the date and time will be added to the read data.

Example of Saved File

```

ABC0001,2005/01/27,12:48:30
ABC0003,2005/01/27,12:51:02
ABC0109,2005/01/27,12:59:41
ABC0075,2005/01/27,12:59:47
    
```

{
{
{

Data Date Time
 (Y/M/D)

Data Conversion on Display

Click the **Data Conversion on Display** Tab in the Create Setting Data Window to convert a CSV file for display.

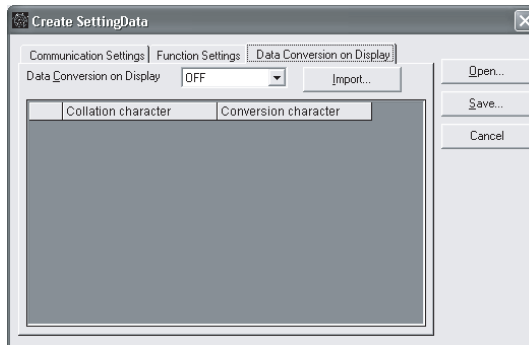

◆ Setting Method

1. Create the CSV file for the display conversion function.

To use this function, CSV files for display conversion must be created using separate spreadsheet software or a text editor for the personal computer.

The following formatting restrictions apply.

- File: CSV format (comma delimited)
- Maximum No. of records: 1,000
- Maximum No. of comparison characters: 19
- Maximum No. of conversion characters: 19
- Comment row: Add a semicolon (;) to the beginning of the row.

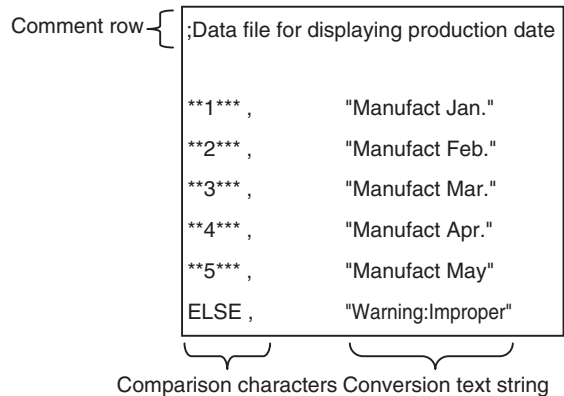

Enter comparison text and conversion text in each row.

The symbols and text in the following table function as special characters with specific meanings.

Symbol	Name	Details
*	Wild card	Any data OK
!a	Alphabet	Any lower-case character OK
!A	Alphabet	Any upper-case character OK
!n	Numeric value	Any numeral OK
ELSE	Condition for no match	Enter at end.



Comparison Principle

With display conversion, comparison is performed with the data contained in the file, and the display contents is changed to the registered text strings for characters that match. Matching processing is performed in order starting from the beginning of the file. Once a match is found, no further comparisons are made, i.e., matching processing is affected by the entry order. Therefore, when comparing complicated patterns, make sure that the optimum order is used.

2. Click the Import Button.

Import the created file to the 2DCR Configear to convert the created file to a format that can be uploaded to the Handheld 2D Code Reader

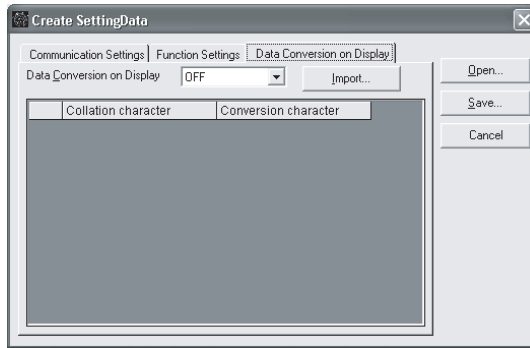

3. Select the CSV file to be uploaded and click the **Open** Button.

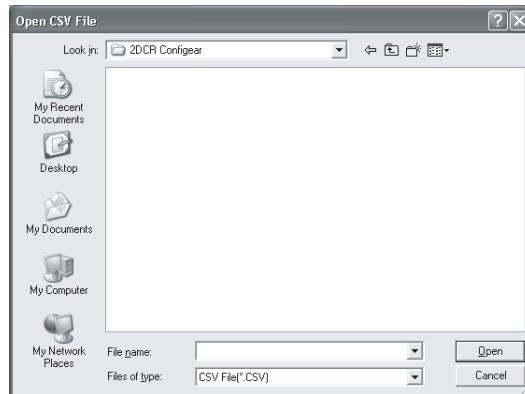

4. The CSV file will be read and displayed as shown in the following diagram.

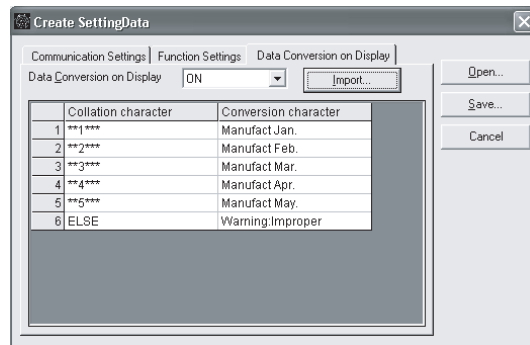

5. Select **ON** in Data Conversion on Display field.

Saving

1. Save the settings.

Click the **Save** Button, specify the save destination for the data settings in the Save Setting Data Window, and then click the **Save** Button.

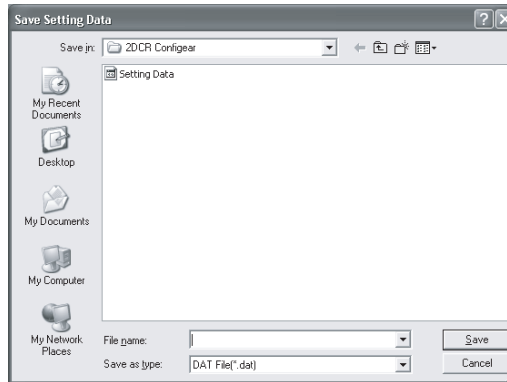

2. Exit the 2DCR Configear.

Click **File - End** to exit the 2DCR Configear.

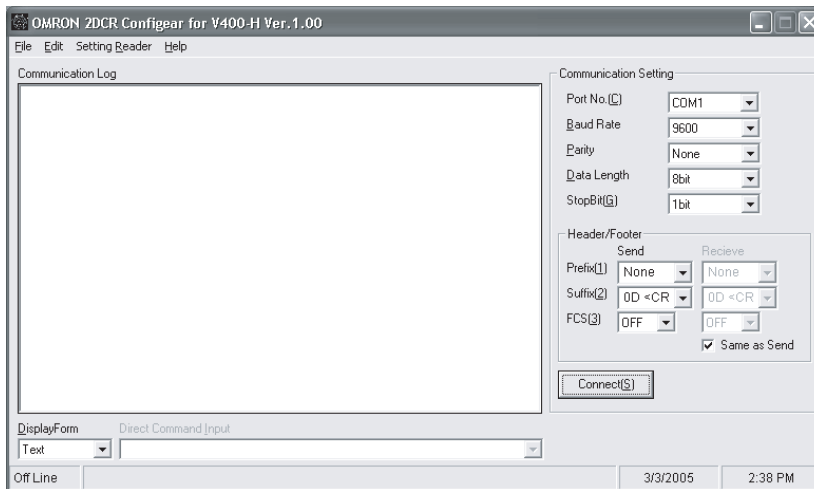

Uploading from the Memory Card

The Memory Card can be used to upload the setting data to the Handheld 2D Code Reader.

Starting Setting Mode

1. Save the data setting file to the Memory Card.

To save data to the Memory Card, create a folder named **SETTINGS**, and save the data in this folder. If another folder is used, setting mode will not function correctly.



To save data to the Memory Card, create a folder named **SETTINGS**, and save the data in this folder. If a folder other than **SETTINGS** is used, setting mode will not start even if the following operations are performed.

CHECK!

2. Start setting mode.

Keeping the right and left trigger buttons pressed, insert the Memory Card into the Memory Card slot.

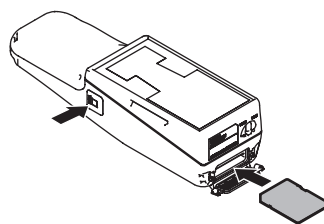

The setting mode menu window will be displayed.

Trigger Button Operations in Setting Mode

Use the trigger buttons to select (or move) items and confirm (execute) selections.

In setting mode, the function of the left and right trigger buttons are different.

Left: Selection button (Select)

Right: Confirmation button (Execute)



Uploading Setting Data to the 2D Code Reader

1. Select *Upload Settings*.

In the menu window, press the left trigger button and select *Upload Settings*.
After selection, press the right trigger button to confirm the setting.

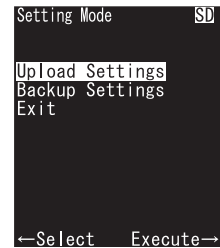

The file selection window will be displayed.

2. Select the data setting file.

In the file selection window, press the left trigger button and select the data setting file to be used.
After selection, press the right trigger button to confirm the setting.

The contents of the SETTINGS folder in the Memory Card will be displayed.



After the load window is displayed, the save selection window will be displayed.

3. Save the setting data.

In the save selection window, press the left trigger button and select *YES*.
After selection, press the right trigger button to confirm the setting and save the data.

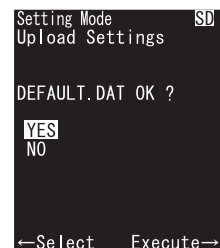

After the save window is displayed, the menu window will be displayed.

4. Exit setting mode.

In the menu window, press the left trigger button and select *Exit*.
After selection, press the right trigger button to exit setting mode.

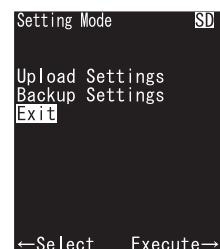

Backing Up 2D Code Reader Data

1. Select **Backup Settings**.

In the menu window, press the left trigger button and select **Backup Settings**.
After selection, press the right trigger button to confirm the setting.

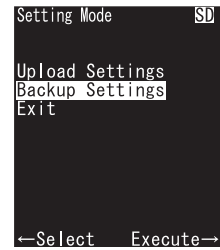

▼
The save selection window will be displayed.

2. Save the setting data.

In the save selection window, press the left trigger button and select **YES**.
After selection, press the right trigger button to confirm the setting and save the data.



The setting data file will be backed up in the SETTINGS folder in the Memory Card.

CHECK! The SETTINGS folder will be automatically created if it does not already exist. The file name will be SETTINGS.DAT.



▼
After the save window is displayed, the menu window will be displayed.

3. Exit setting mode.

In the menu window, press the left trigger button and select **Exit**.
After selection, press the right trigger button to exit setting mode.

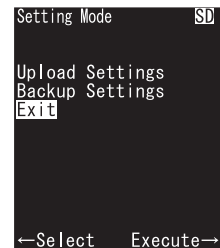

Section 5

Troubleshooting

This section explains the countermeasures to take when reading cannot be executed correctly or when a problem occurs.





 Troubleshooting

56

Troubleshooting

Status	Cause and countermeasures	Page
The POWER indicator is not lit.	The power supply is not connected properly. Not enough power is available.	p.26
The video monitor image is not clear.	Some pixels on the monitor may not light and some may always light. This is a result of the monitor's construction and does not indicate a malfunction.	-
Cannot write data to Memory Card	The write-protect switch on the Memory Card is ON. The Memory Card capacity is insufficient. The Memory Card is damaged. The Memory Card has not been formatted. The Memory Card is the wrong type.	-
The saved data is corrupted.	The Memory Card was removed while it was being accessed.	p.35
The time stamp on saved data is not correct.	The clock is not set correctly. The clock is factory set to Japanese Standard Time. Set the clock as required.	p.44
Cannot communicate with the host device.	The cable model is incorrect. The cable connections are loose. The communications settings are not correct.	p.20 p.43

Appendices

 Maintenance	58
 Specifications and Dimensions	59
 ASCII Table	64
 FCS Calculation Method	65
 Data Capacity Tables	67

Maintenance

Handling the Handheld 2D Code Reader

- Do not touch the lens or monitor with your fingers or any pointed object.
- Do not use the Handheld 2D Code Reader in locations subject to dust or other contaminants.

Inspection

To maintain the Handheld 2D Code Reader in optimum condition, perform the following inspections regularly.

- Use a lens cloth or air brush to clean the lens and monitor.
- Use a soft cloth to clean other parts of the Handheld 2D Code Reader.

Inspection items	Details	Required tools
Power supply	The voltage measured at the power supply terminals on the terminal block must be 5 VDC_10%.	Multimeter
Ambient operating temperature	The ambient operating temperature must be between 0 and 40°C.	Thermometer
Ambient operating humidity	The ambient operating humidity must be between 35% and 85%.	Hygrometer



CHECK!

- Turn OFF the power and take safety precautions before conducting maintenance or inspections.
- Do not use thinners or benzene.

Specifications and Dimensions

Handheld 2D Code Reader

■ V400-H101/H201

(Unit: mm)

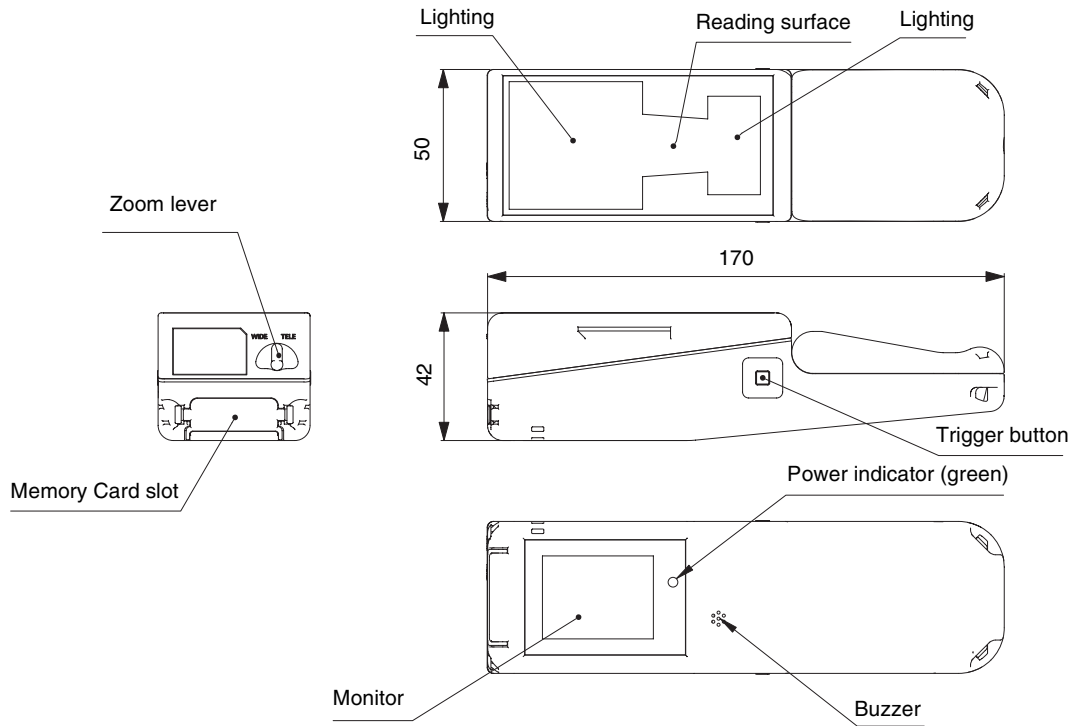

	V400-H101	V400-H201
Field of vision	5 to 10 mm	15 to 30mm
Working distance	40 mm (contact with the code when the Contactor is mounted)	
Power supply voltage	5 VDC±10%	
Current consumption	1 A max.	
Serial interface	RS-232C	
Applicable code	DataMatrix ECC200 10 × 10 to 64 × 64, 8 × 18 to 16 × 48 QR Code Model 1.2 21 × 21 to 57 × 57 (Ver. 1 to 10)	
Operating method	Pushbutton control using the trigger buttons	
Settings	Uploading settings from the Memory Card or using communications.	
Memory Card	SD card	
Monitor	1.8-inch TFT liquid crystal image and read data display.	
Indicators	Power indicator and Memory Card access indicator	
Ambient temperature	Operating: 0 to 40°C Storage: -25 to 60°C	
Ambient humidity	35% to 85% (with no condensation)	
Ambient environment	No corrosive gases	
Vibration resistance	10 to 150 Hz; half-amplitude: 0.35 mm (max. acceleration: 50 m ² /s)	
Shock resistance	150m ² /s 3 times in 6 directions	
Weight	Approx. 200 g	
Degree of protection	IEC 60529 (IP64)	
Materials	Case: ABS; Optical surface: PC; Surfaces: PMMA	

Cables

■ V400-W20-2M/V400-W21-2M

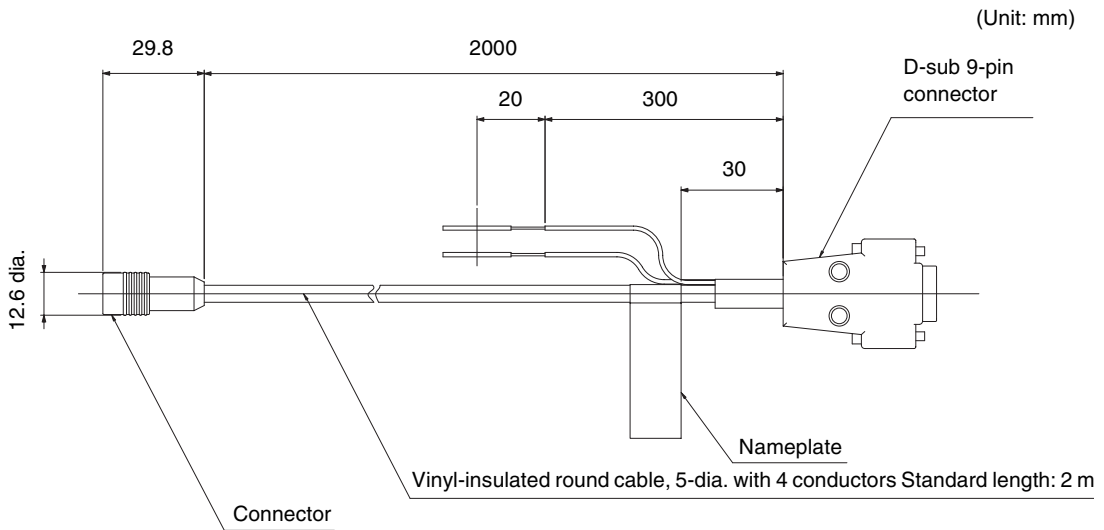

	V400-W20-2M	V400-W21-2M
Interface connector	D-sub, 9-pin, male	D-sub, 9-pin, female
Ambient temperature	Operating: 0 to 40°C Storage: -25 to 60°C	
Ambient humidity	35% to 85% (with no condensation)	
Ambient environment	No corrosive gases	
Materials	Cable sheath: Heat-resistant vinyl chloride Special connector: PPS, PBT, POM D-sub connector: ABS	
Minimum bending radius	30 mm	
Weight	Approx. 100 g	

Contactor

■ V400-AC1

(Unit: mm)

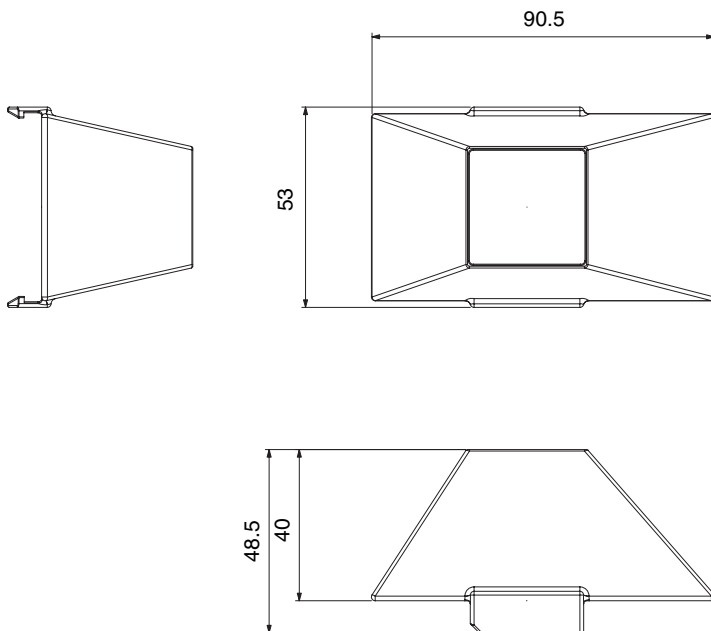

	V400-AC1
Material	POM (antistatic grade)
Weight	Approx. 20 g

Stand

■ V400-AS1

(Unit: mm)

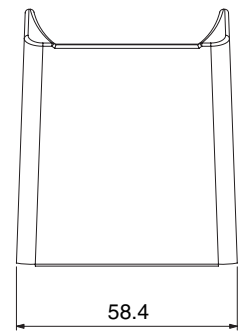
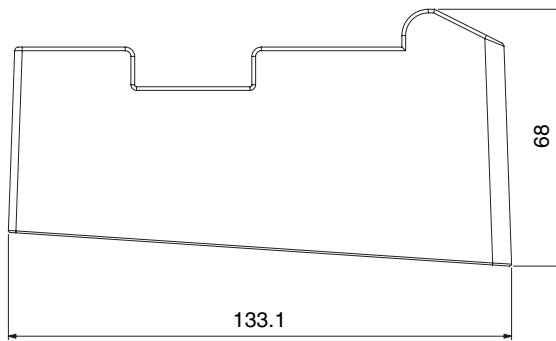
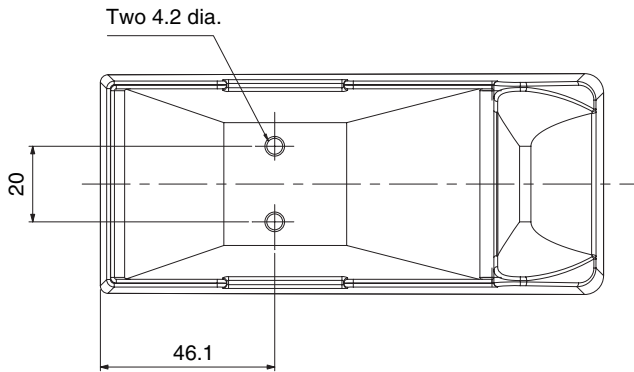

V400-AS1	
Material	ABS
Weight	Approx. 100 g

ASCII Table

Data read with no-protocol commands using the serial communications interface is output as 2 characters of ASCII. The ASCII characters correspond to the following characters.

Examples:

- When the read data is A, 41 is output.
- When the data read is T, 54 is output.

Upper 4 bits

		0	1	2	3	4	5	6	7
Lower 4 bits	0		D _E		0	@	P	`	p
	1	S _H	D ₁	!	1	A	Q	a	q
	2	S _X	D ₂	”	2	B	R	b	r
	3	E _X	D ₃	#	3	C	S	c	s
	4	E _T	D ₄	\$	4	D	T	d	t
	5	E _Q	N _K	%	5	E	U	e	u
	6	A _K	S _N	&	6	F	V	f	v
	7	B _L	E _B	'	7	G	W	g	w
	8	B _S	C _N	(8	H	X	h	x
	9	H _T	E _M)	9	I	Y	i	y
	A	L _F	S _B	*	:	J	Z	j	z
	B	H _M	E _C	+	;	K	[k	{
	C	C _L	→	,	<	L	¥	l	!
	D	C _R	←	-	=	M]	m	}
	E	S _O	↓	.	>	N	^	n	~
	F	S _I	↑	/	?	O	_	o	

FCS Calculation Method

■ FCS Calculation Method

The FCS (Frame Check Sequence) is the result of taking the XOR for each byte between the header and footer (8 bits) and converting it to 2 characters of ASCII. The FCS can be attached to output data to improve the reliability of communications.

Each time data is received, the host calculates the FCS and checks it against the FCS attached to the sent data so that the send data can be checked for errors.

■ Calculation Example for Sending FCS

Sample read data: ABCDEFG

The details of the read data and calculation method are as follows:

- Read data

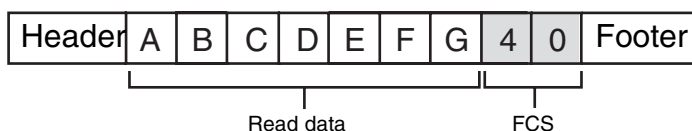

- Calculation method

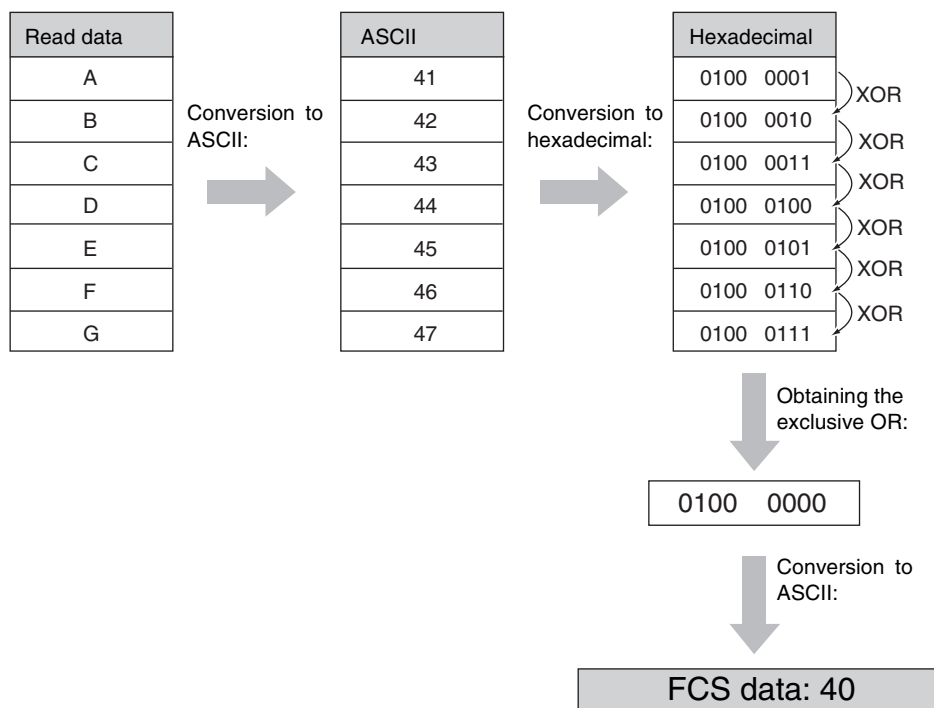

■ Calculation Programming Example for Sending FCS

DATA\$	Sample data string
L	Data length
CODE\$	Data character
A	Exclusive OR

```

100      * * * * * CALCULATE FCS * * * * *
110      * FCSSET
120      L=LEN(DATA$)
130      A=0
140      FOR J=1 TO L
150      CODE$=MID$(DATA$,J,1)
160      A=ASC(CODE$)XOR A
170      NEXT J
180      FCS$=HEX$(A)
190      IF LEN(FCS$)=1 THEN FCS$="0"+FCS$
200      RETURN
    
```

■ FCS Check Subroutine Example for Received Data

```

1000     * * * * * FCSHECK * * * * *
1010     * FCSHECK
1020     Q=0:FCCK$="OK"
1030     PRINT RESPONSE $
1040     LENG$=LEN(RESPONSE$)-3
1050     FCSP$=MID$(RESPONSE$,LENG$+1,2)           'FCS in response data
1060     FOR J=1 TO LENG$                          'Calculation range of FCS
1070     Q=ASC(MID$(RESPONSE$,J,1))XOR Q
1080     NEXT J
1090     FCSD$=HEX$(Q)
1100     IF LEN(FCSD$)=1 THEN FCSD$="0"+FCSD$       'FCS calculated in a program
1110     IF FCSD$ < > FCSP$ THEN FCCK$="ERR"
1120     PRINT "FCSD$=";FCSD$;"FCSP$=";FCSP$;       'FCS received correctly: OK
                                                "FCCK$=";"FCCK$=" 'FCS not received correctly: ERR
1130     RETURN
    
```

Data Capacity Tables

The maximum quantity of information that can be stored depends on the symbol size of the code. Also the maximum data capacity in relation to the amount of information carried by the code depends on the character type and the arrangement and combination of characters. The relation between the symbol size (number of cells) and data capacity is shown in the following table.

■ DataMatrix

◆ DataMatrix ECC200

In the following diagram, the symbol size is 12 x 12.

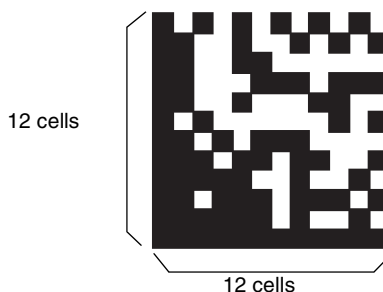

Symbol size	Data capacity				
	Numerals	Alphanumerics	Alphanumerics and symbols	2-byte characters	1-byte Japanese characters
10 × 10	6	3	3	-	1
12 × 12	10	6	5	1	3
14 × 14	16	10	9	3	6
16 × 16	24	16	14	5	10
18 × 18	36	25	22	8	16
20 × 20	44	31	28	10	20
22 × 22	60	43	38	14	28
24 × 24	72	52	46	17	34
26 × 26	88	64	57	21	42
32 × 32	124	91	81	30	60
36 × 36	172	127	113	42	84
40 × 40	228	169	150	56	112
44 × 44	288	214	190	72	142
48 × 48	348	259	230	86	172
52 × 52	408	304	270	101	202
64 × 64	560	418	372	139	278
8 × 18	10	6	5	1	3
8 × 32	20	13	12	4	8
12 × 26	32	22	20	7	14
12 × 36	44	31	28	10	20
16 × 36	64	46	41	15	30
16 × 48	98	72	64	23	47

■ QR Code

◆ QR Code (Model 2)

In the following diagram, the symbol size is 21 x 21 (Version 1).

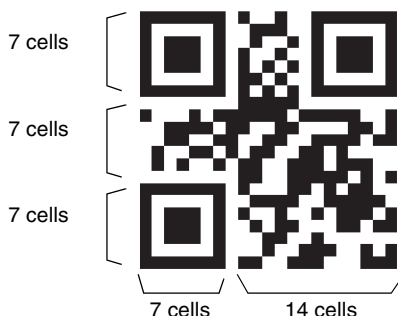

Symbol size (version)	Error correction level (ECC level)	Data capacity			
		Numerals	Alphanumeric characters (uppercase)	8-bit bytes	2-byte Japanese characters
21 × 21 (Version 1)	L (7%)	41	25	17	10
	M (15%)	34	20	14	8
	Q (25%)	27	16	11	7
	H (30%)	17	10	7	4
25 × 25 (Version 2)	L (7%)	77	47	32	20
	M (15%)	63	38	26	16
	Q (25%)	48	29	20	12
	H (30%)	34	20	14	8
29 × 29 (Version 3)	L (7%)	127	77	53	32
	M (15%)	101	61	42	26
	Q (25%)	77	47	32	20
	H (30%)	58	35	24	15
33 × 33 (Version 4)	L (7%)	187	114	78	48
	M (15%)	149	90	62	38
	Q (25%)	111	67	46	28
	H (30%)	82	50	34	21
37 × 37 (Version 5)	L (7%)	255	154	106	65
	M (15%)	202	122	84	52
	Q (25%)	144	87	60	37
	H (30%)	106	64	44	27
41 × 41 (Version 6)	L (7%)	322	195	134	82
	M (15%)	255	154	106	65
	Q (25%)	178	108	74	45
	H (30%)	139	84	58	36

Symbol size (version)	Error correction level (ECC level)	Data capacity			
		Numerals	Alphanumeric characters (uppercase)	8-bit bytes	2-byte Japanese characters
45 × 45 (Version 7)	L (7%)	370	224	154	95
	M (15%)	293	178	122	75
	Q (25%)	207	125	86	53
	H (30%)	154	93	64	39
49 × 49 (Version 8)	L (7%)	461	279	192	118
	M (15%)	365	221	152	93
	Q (25%)	259	157	108	66
	H (30%)	202	122	84	52
53 × 53 (Version 9)	L (7%)	552	335	230	141
	M (15%)	432	262	180	111
	Q (25%)	312	189	130	80
	H (30%)	235	143	98	60
57 × 57 (Version 10)	L (7%)	652	395	271	167
	M (15%)	513	311	213	131
	Q (25%)	364	221	151	93
	H (30%)	288	174	119	74

Source: 2D Codes, Basic Specifications for QR Code (JIS X 0510)



Maximum Data Capacity

Even with the same 2D code, the maximum quantity of information that can be stored depends on the symbol size of the code. In other words, the symbol size must be increased to increase the data capacity. The data capacity also depends on the type of characters used for the information contained in the code. With QR and DataMatrix Code, the maximum number of characters for the same symbol size will be greatest for numbers only and then for alphanumerics, and will be the least with 2-byte characters. The data capacity also depends on the character type, and the order and combination of characters used.

Revision History

A manual revision code appears as a suffix to the catalog number at the bottom of the front and rear pages.

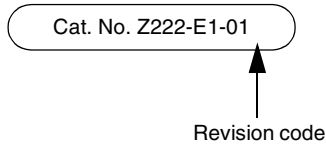

Revision code	Date	Revised contents
01	March 2005	Original production

This document provides information mainly for selecting suitable models. Please read the Instruction Sheet carefully for information that the user must understand and accept before purchase, including information on warranty, limitations of liability, and precautions.

OMRON Corporation
Industrial Automation Company

Application Sensors Division
Sensing Devices and Components Division H.Q.

Shiokoji Horikawa, Shimogyo-ku,
Kyoto, 600-8530 Japan
Tel: (81)75-344-7068/Fax: (81)75-344-7107

Regional Headquarters

OMRON EUROPE B.V.

Sensor Business Unit,
Carl-Benz-Str. 4, D-71154 Nufringen,
Germany
Tel: (49)7032-811-0/Fax: (49)7032-811-199

OMRON ELECTRONICS LLC

1 East Commerce Drive, Schaumburg, IL 60173
U.S.A.
Tel: (1)847-843-7900/Fax: (1)847-843-8568

OMRON ASIA PACIFIC PTE. LTD.

83 Clemenceau Avenue,
#11-01, UE Square,
239920 Singapore
Tel: (65)6835-3011/Fax: (65)6835-2711

OMRON CHINA CO., LTD. BEIJING OFFICE

Room 1028, Office Building,
Beijing Capital Times Square,
No. 88 West Chang'an Road,
Beijing, 100031 China
Tel: (86)10-8391-3005/Fax: (86)10-8391-3688

Authorized Distributor: