

Ultraviolet power monitor/illumination monitor

F3UV

Monitoring output state of UV (ultraviolet light)/illumination light source

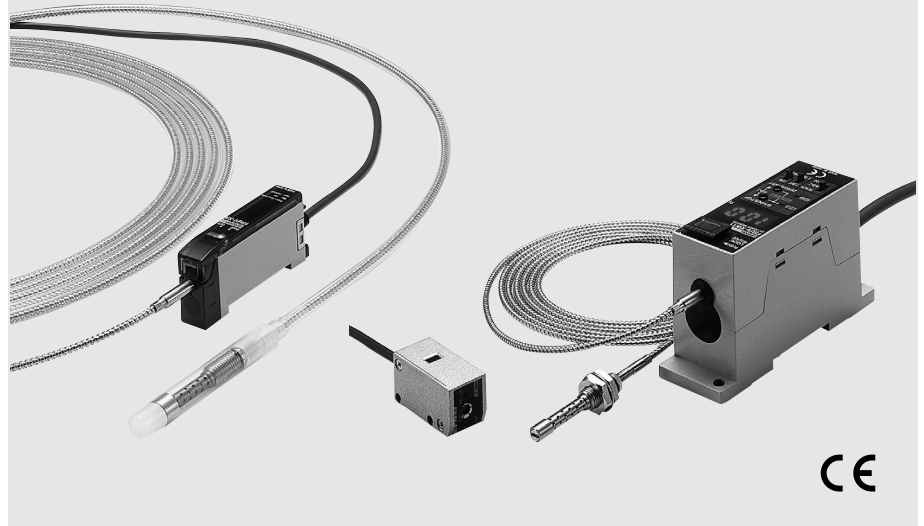

Features

Optical Fiber Type

Can be used as ultraviolet power monitor/illumination monitor

Fiber Units

● UV Power Monitor

Heat resistance applications

Head can resist heat up to 300°C (using F3UV-HM) Converts harmful ultraviolet light into visible light

Case is made of ozone-proof and heatproof stainless steel (SUS303).

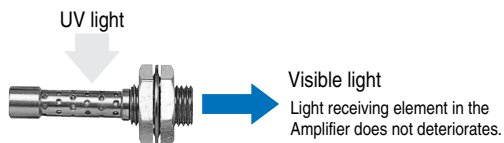

F32-300, F32-70

F3UV-XW11/41, F3UV-XA

● During projection monitoring

Monitors projected light through fiber unit.



F32-300, F32-70

F3UV-XW11/41, F3UV-XA

Waterproof applications

Head can resist heat up to 150°C
(using F3UV-HM) Converts harmful
ultraviolet light into visible light

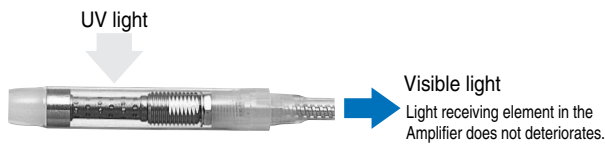

(Fiber unit not required)

F3UV-XW11/41, F3UV-XA

Application

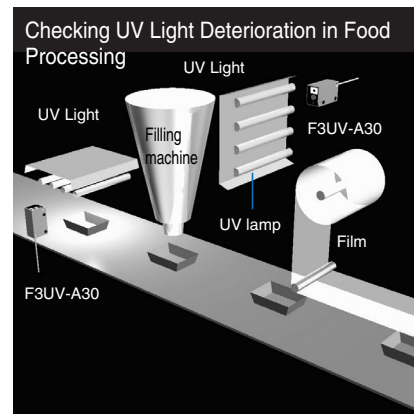
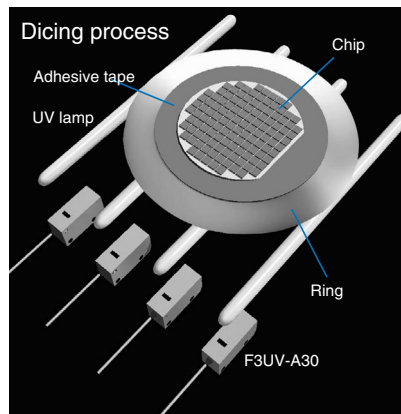
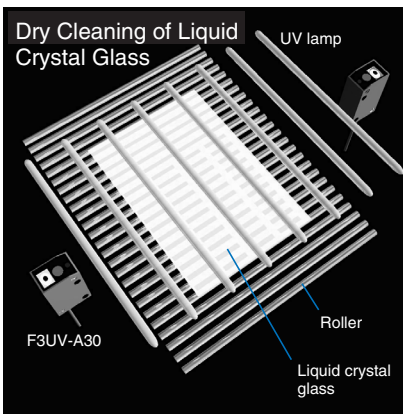
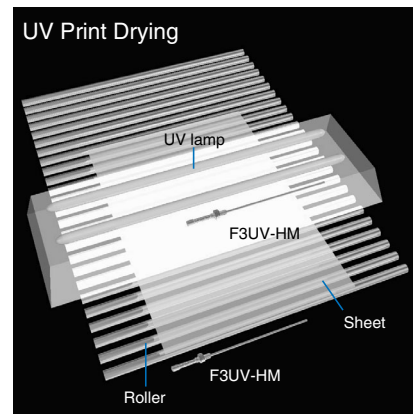
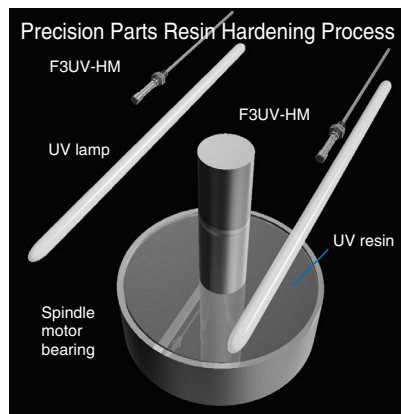
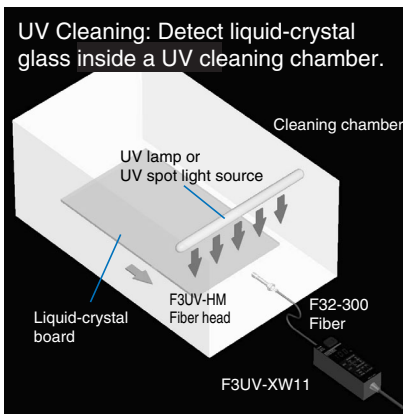

Features

Optical Fiber Type

Amplifier Units

- F3UV-XW Series

Digital % display for easy visualization of measured values

7-segment digital % display

Easy teaching scheme

Button teaching is possible for zero-point setting and sensitivity setting.

Output form can be selected.

Two outputs: current/voltage output + decision output

- F3UV-XA

Sensitivity control scheme

Fine adjustment possible with 8-revolution dial.

Verify output form with operation indicator lamp

Illuminates at approximate range of 4 to 5 V

Built-in Amplifier Type

(Cannot be used as illumination monitor)

About 1/10th the cost

The price is about 1/10th the price of a dedicated measuring instrument

Protective Structure to Prevent UV Deterioration.

A zinc die-cast case and synthetic quartz glass for the light receiving window.

Protective tubes and covers available as options.

(Option)

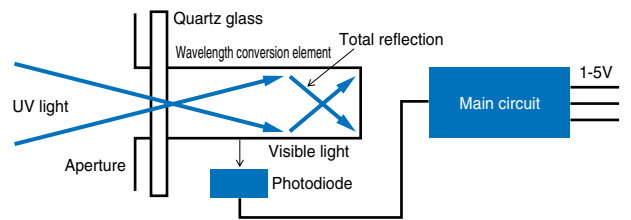

Monitor UV Light Output Status with an Operation Indicator.

(Lit at approx. 4 to 5 V.)

With control for sensitivity adjustment

Filter Cover (reduced by 1/6.5) Available.





Ordering Information

Built-in Amplifier Type

Sensors

Shape	Intensity range of incident light	Output	Model
	1 to 30 mW/cm ²	Analog voltage output (1 to 5 V)	F3UV-A30
	0.2 to 3 mW/cm ²		F3UV-A03



Accessories (Sold Separately)

Shape	Name	Model
	Protective Tube (Protects the cord.)	F39-CU1M
	Protective Cover (Protects the display.)	F39-HU2
	1/6.5 Filtering Cover	F39-HU1
	Mounting Brackets	F39-L9

Optical Fiber Type



Sensors

Amplifier Unit

Shape	Connection method	Output	Output form	Model
	Pre-wired	Evaluation output Answer-back output Current/voltage analog output	NPN output	F3UV-XW11 *
			PNP output	F3UV-XW41
		Analog voltage output	---	F3UV-XA

* A model with 5 times higher sensitivity is also available.

Head Unit (can only be used as UV power monitor)

Shape	Wavelength range of incident light	Max. temperature	Model	Remarks
 *1	200 to 370 nm	300°C ^{*2}	F3UV-HM	Includes two M8 nuts and one mounting plate.
 *3		150°C	F3UV-HT 5m F3UV-HT 10 m	Waterproof and chemical-resistant Teflon cover ^{*4} For the mounting procedure, see "Please use correctly". For the incoming light power range, please inquire separately.





*1. The fiber unit is required for connection to the amplifier unit.

*2. Use within the operating temperature range of the fiber unit you are using.

*3. Can be directly connected to the amplifier unit.

*4. Teflon is a registered trademark of the Dupon Company and the Mitsui Dupon Chemical Company for their fluoride resin.

Fiber Units

Compatible Amplifier Units	Compatible Head Units	Shape ^{*1}	Max. temperature	Intensity range of incident light ^{*2}	Model	Quantity
F3UV-XW11 F3UV-XW41	F3UV-HM ^{*3}	 M4 screw	300°C	10 to 300 mW/cm ²	F32-300	1 pc.
		 M4 screw	70°C		F32-70	
F3UV-XA		 M4 screw	300°C	30 to 300 mW/cm ²	F32-300	
		 M4 screw	70°C		F32-70	

*1. The values given are for a standard UV light source with a central wavelength of 360 nm, measured with a standard illumination meter (and for use in combination with the specified Amplifier and Head Unit). The power range is one for which teaching to 100% is possible.

*2. For the fiber length, please inquire separately.

*3. Not required when using as an illumination monitor.

Accessories (Order Separately)

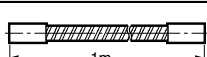
Shape	Name	Model	Quantity	Applicable Fiber Units
	Protective Tube (Protects the fiber.)	F39-FU1M	1 pc.	F32-70

Rating/performance

Built-in Amplifier Type

Main Unit

Item	Model	F3UV-A30	F3UV-A0
Intensity range of incident light ^{*1}		1 to 30 mW/cm ²	0.2 to 3 mW/cm ²
Wavelength range of incident light		200 to 370 nm	
P indicator		Green LED	
Operation indicator		Orange LED (illuminates at an output of approximately 4 to 5 V)	
Sensitivity adjuster		One-turn adjuster	
Supply voltage		12 to 24 VDC ±10%	
Current consumption		15 mA max.	
Response time ^{*2}		300 ms max.	400 ms max.
Output ^{*3}		1 to 5 V (offset voltage of 0.2 V or higher)	
Connection impedance		100 k min.	
Repetition precision		±2% F.S. max.	
Temperature drift		0.2% of F.S./°C max.	
Ambient illuminance ^{*4}		Fluorescent light 1,000 lx max.	Fluorescent light 500 lx max.
Ambient temperature		-10° to 70°C	
Ambient humidity		35% to 85%	
Ambient temperature		-25° to 80°C	
Insulation resistance		20 M min. at 500 VDC	
Dielectric strength		1,000 VAC for 1 min.	
Vibration resistance		10 to 150 Hz, half amplitude of 0.1 mm in 3 directions: X, Y, and Z, 8 min x 10 sweeps each	
Shock resistance		150 m/s ² , 3 times each in ±X, ±Y, and ±Z directions	
Protective structure		IEC Standard IP30	
Connection method		Pre-wired models (standard length: 2 m)	
Weight (Packed state)		78 g	
Material	Case	Zinc diecast	
	Window:	Synthetic quartz glass	
Accessories		Instruction manual	

- *1. Using a standard UV light source and UV illumination meter in a power range for which analog output can be set to 5 V.
- *2. The response time is the rise time of the output signal to 10 to 90%.
- *3. An output voltage up to 6 V can be output. Adjust the sensitivity so that the output is less than 5 V. The output is 0.2 to 1 V when there is no incident UV light.
- *4. This value is the illumination at the receiver window maintaining an offset voltage of 1 V max. with the fluorescent light.

Accessories (Order Separately)

Protective Tube (Protects the cord.)

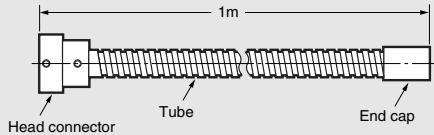
Item	Model	F39-CU1M
Shape		
Ambient temperature		Operating/storage: -40 to +100°C (must use in operating temperature range of sensor)
Ambient humidity		Operating: 35% to 85% Storage: 35% to 95%
Bending radius		24 ±5mm
Tensile strength		Gap between head connector/end cap and tube: 2 Nm or less, tube: 2 Nm or less
Compression load		Tube: 9.8 Nm (lateral pressure load)
Material	Head connector	Brass nickel plating
	End cap	Brass nickel plating
	Tube	Stainless steel (SUS304)
Accessories		M2 screws

Optical Fiber Type

Sensors
Amplifier Units

Item	Model	F3UV-XW11 ^{*1}	F3UV-XW41	F3UV-XA
Power supply voltage		12 to 24 VDC ±10%		
Current consumption		75 mA max.		15 mA max.
Out-put	Analog output	Current (4 to 20 mA)/Voltage (1 to 5 V) (when using light intensity monitor and light intensity integration mode)		Voltage (1 to 5 V) (offset voltage of 0.2 V or less)
	Discrimination output	NPN open collector output, 100 mA or less, residual voltage 1 V or less (when using light intensity monitor and light intensity integration mode)	PNP open collector output, 100 mA or less, residual voltage 2 V or less (when using light intensity monitor and light intensity integration mode)	---
	Answer-back output	NPN open collector output, 100 mA or less, residual voltage 1 V or less (when using light intensity monitor and light intensity integration mode)	PNP open collector output, 100 mA or less, residual voltage 2 V or less (when using light intensity monitor and light intensity integration mode)	---
In-puts	Remote teaching input	When ON: 0 V short circuit (short circuit current of 1 mA or less) When OFF: Open circuit (open or 9 V or higher and 24 V or less)	When ON: Power supply voltage short circuit or 9 V or higher and 24 V or less (short circuit current of 3 mA or less) When OFF: Open circuit (open or 1.5 V or less)	---
	Reset input	When ON: 0 V short circuit (short circuit current of 1 mA or less) When OFF: Open circuit (open or 9 V or higher and 24 V or less)	When ON: Power supply voltage short circuit or 9 V or higher and 24 V or less (short circuit current of 3 mA or less) When OFF: Open circuit (open or 1.5 V or less)	---
Protective circuits		Protection from load short-circuit and reversed power supply connection		
Response time ^{*2}		500 ms max.		300 ms max.
Sensitivity setting		Teaching		8-revolution dial type
Indicator lamp		Measurement/teaching indicator lamp (green/red) Operation indicator lamp (orange) 7 segment digital percent display (red) 7 segment digital threshold value display (red)		Power display (green) Operation display (orange)
Repetition precision		±2% F.S. max.		
Ambient illuminance		Fluorescent light 1,000 lx max. ^{*3}		Fluorescent light 1,000 lx max. ^{*4}
Temperature drift		±0.1% of F.S./°C max		0.2% of F.S./°C max.
Ambient temperature		Operating: -25 to +55°C, Storage: -40 to +70°C (with no icing or condensation)		
Ambient humidity		Operating/storage: 35% to 85% RH		
Insulation resistance		20 M min. at 500 VDC		
Dielectric strength		Lead wires to case: 1,000 V AC 50/60 Hz		
Vibration resistance		10 to 150 Hz, half amplitude of 0.1 mm, or 15 m/s ² , 2h each in X, Y, and Z directions		
Shock resistance		150 m/s ² , 3 times each in X, Y, and Z directions		
Protective structure		IEC Standard IP30		IEC 60529 IP50
Connection method		Pre-wired models (standard length: 2 m)		
Weight (Packed state)		Approx. 270 g		Approx. 60 g
Material		ABS		
Accessories		Instruction manual		Operation manual, adjustment driver, clamps

*1. A model with 5 times the sensitivity is also available.

*2. Response time: 10% to 90% of rise and fall time of analog output signal.

*3. An analog output of up to 6 V (or 24 mA) can be output. The output is 1 V (or 4 mA) when there is no incident UV light.

*4. Shows value at which offset voltage can maintain 1 V or less using fluorescent lamp.

Note: 1. Analog output outputs up to approximately 6 V (24 mA). Outputs 1 V (4 mA) when there is no incoming light.

2. F.S. stands for full scale. For a current output, full scale is 16 mA (4 to 20 mA).
Voltage output: 4 V (1 to 5 V)

3. Definition of the luminous energy integral: The physical unit of the luminous energy integral is energy (J: joules) and this value is calculated by multiplying the UV intensity (mV) by the time of exposure (s), but it is dimensionless when this sensor's analog output value (V) is used for the UV intensity. The integral is measured with an 11 ms sampling time.

Head unit

Item	Model	F3UV-HM	F3UV-HT (both 5m and 10m)
Wavelength range of incident light		200 to 370 nm	
Temperature drift		-0.15%/°C max.	
Ambient temperature		Operating/Storage: -40° to 300°C (with no icing or condensation)	Operating/Storage: -40° to 150°C (with no icing or condensation)
Ambient humidity		Operating/Storage: 35% to 85% RH (with no icing or condensation)	
Vibration resistance		10 to 55 Hz, half amplitude of 0.75 mm or 100 m/s ²	
Shock resistance		500 m/s ²	
Weight (Packed state)		30 g	5 m cable: approximately 170 g, 10 m cable: approximately 380 g
Material	Protective casing	Stainless steel (SUS303)	Fluoresin
	Fluorescent fiber path	Functional fluoroglass	
Accessories		M8 nut and mounting bracket	---

Optical Fiber Type

Sensors

Fiber Units

Item	Model	F32-300	F32-70
Ambient temperature	Operation	-40° to 300°C ^{*1}	-40° to 70°C
	Storage	-40° to 110°C	-40° to 70°C
		(with no icing or condensation)	
Ambient humidity		Operating: 35% to 85% RH, storage: 35% to 95% RH (with no icing or condensation)	
Permissible bending radius		25 mm min.	
Fiber sheath material		SUS	Black polyethylene
Protective structure		IEC 60529 IP67	
Standard fiber length		2 m ^{*2}	

*1. Heat-resistance temperatures vary depending on the fiber part. See the dimensions for details.

*2. For the fiber length, please inquire separately.

Accessories (Order Separately)

Protective Tube (Protects the Fiber.)

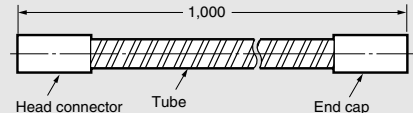
Item	Model	F39-FU1M
Shape		
Ambient temperature		-40° to 150°C for operating or storage Fiber inserted inside must be used within its operating temperature range.
Ambient humidity		Operating: 35% to 85% RH, storage: 35% to 95% RH
Bending radius		30 mm min.
Tensile strength		Between tube and head connector or end cap: 1.5 Nm or less Tube: 2 Nm or less
Compression load		Tube: 29.4 N max.
Material	Head connector	Brass nickel plating
	End cap	Brass nickel plating
	Tube	Stainless steel (SUS304)

Characteristic data (typical)

Built-in Amplifier Type

Output Characteristics

F3UV-A30 (output characteristics when output at 30 mW/cm² is set to 5 V)

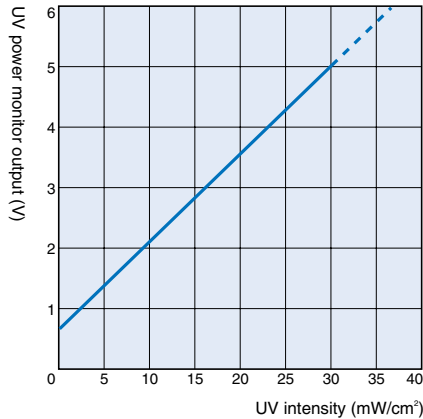

F3UV-A03 (output characteristics when output at 3 mW/cm² is set to 5 V)

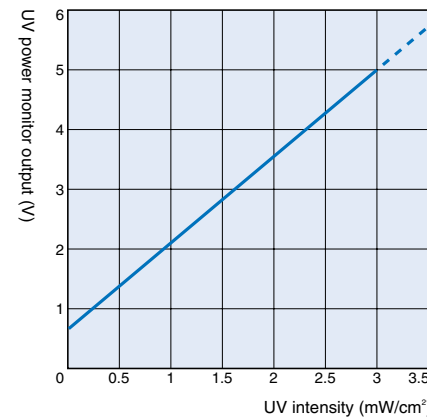

Angular Characteristics (Y-direction)

F3UV-A30/-A03

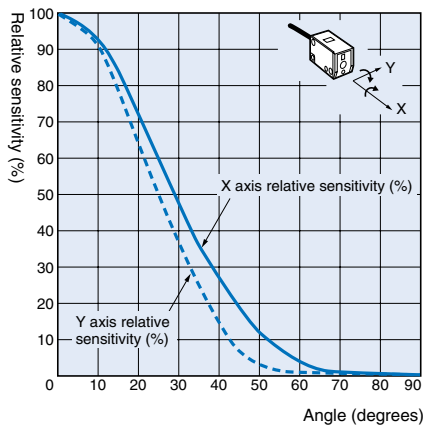

F3UV-A30/A03 + F39-HU1 (exposure cover option)

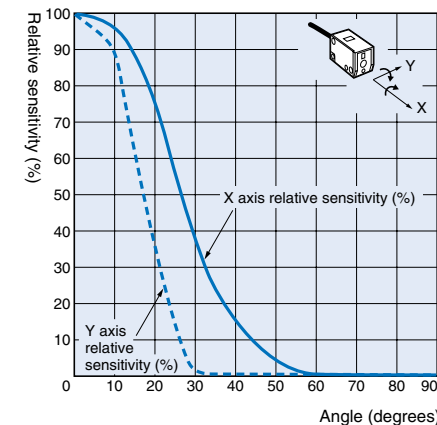

General

Sensitivity Characteristics

All F3UV Models

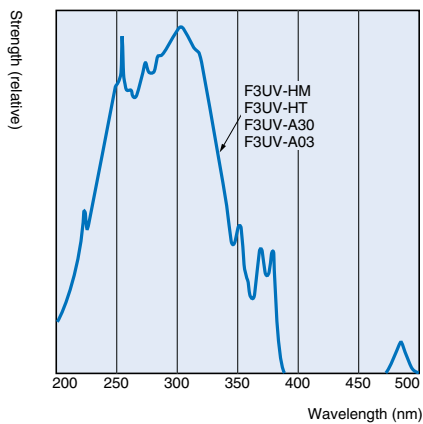

When used as illumination monitor

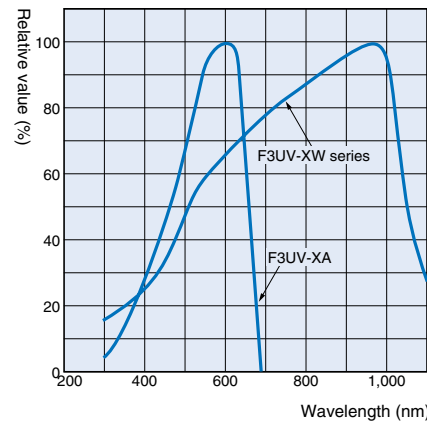

Optical Fiber Type

Output Characteristics

F3UV-XW□1 + F3UV-HM + F32-300 (output characteristics at 300 mW/cm² when sensitivity is set)

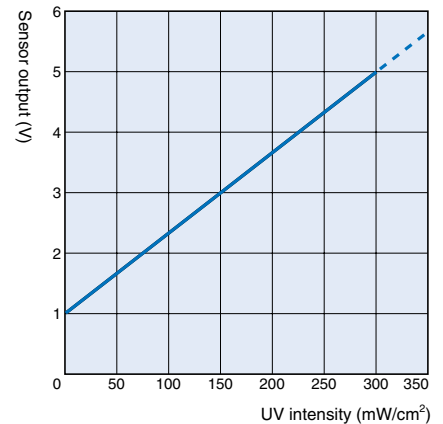

F3UV-XA + F3UV-HM + F32-300 (output characteristics at 300 mW/cm² when sensitivity is set)

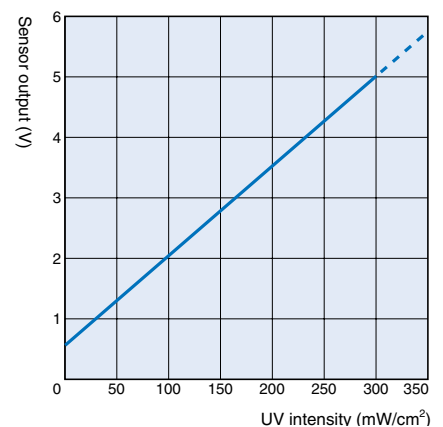

Angle characteristics (Y direction)

F3UV-HM/-HT

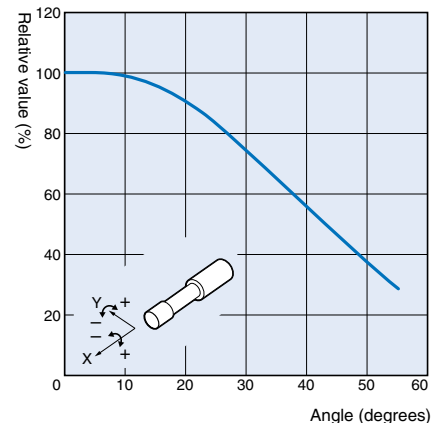

Note: X-direction output fluctuation is ±10% F.S. or less through 360° revolution

Connected with controller

Built-in Amplifier Type

Analog Indications such as Voltage or Current Signals

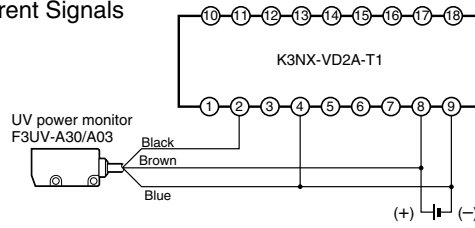

Input/output stage circuit schematic

Built-in Amplifier Type

Optical Fiber Type

F3UV-A30, F3UV-A03

F3UV-XA

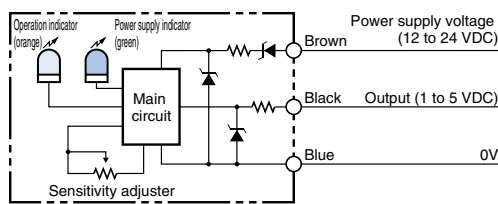

Optical Fiber Type

F3UV-XW11 (NPN output)

F3UV-XW41 (PNP output)

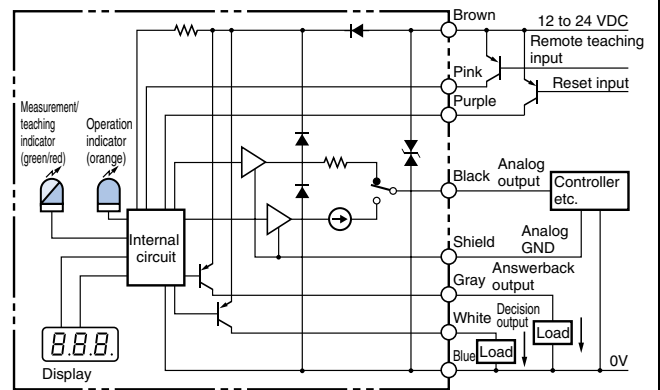
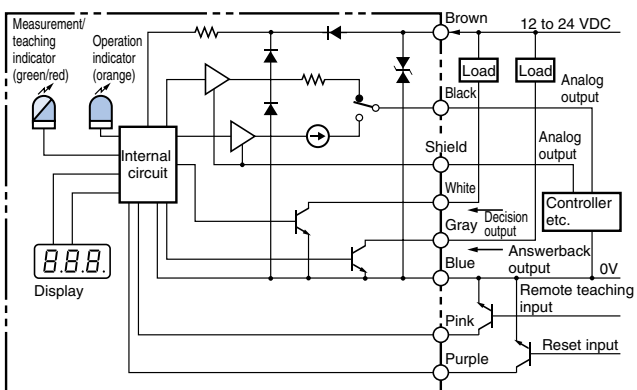

Part Names/Functions

Optical Fiber Type

● F3UV-XW11/XW41

- Measurement/teaching indicator:
 - Illuminated green: Teaching OK
 - RUN
 - Flashing red : Teaching error
 - Illuminated red: Start light intensity integration
- Operation indicator:
 - Illuminated orange: Judgement output ON
- Processing mode switch:
 - Light intensity monitor mode
 - TEACH: Zero point setting/ Sensitivity setting
 - ADJ: Threshold adjustment
 - RUN: Measure light intensity
 - Light intensity integral mode
 - TEACH: Start/Stop integration
 - RUN (ADJ): Light intensity integral
- Output selection switch:
 - I OUT: Current output (4 to 20 mA)
 - V OUT: Voltage output (1 to 5 V)
- Operation mode switch:
 - MON: Light intensity monitor mode
 - ITG: Light intensity integral mode



- Fiber lock
- Digital display: (Display % value and HI/LO)
- Sensitivity setting/threshold up
 - Light intensity monitor mode (MON)
 - TEACH: Sensitivity setting
 - ADJ: Threshold adjustment (Up button)
 - Light intensity integral mode (ITG)
 - TEACH: Stop integration
- Zero point setting/threshold down:
 - Light intensity monitor mode (MON)
 - TEACH: zero point setting
 - ADJ: Threshold adjustment (Down button)
 - Light intensity integral mode (ITG)
 - TEACH: Start integration

● F3UV-XA

- Power supply indicator (green): Light up by power on
- Sensitivity adjuster: Adjustment of sensitivity
- Operate indicator (orange): Analog output value lights up by 4 to 5 V.
- Memory board: Indicate sensitivity adjuster position



Functions

Name	Functions
Light monitor function (with current/voltage output switch function)	Displays the digital (%) value corresponding to the incident light intensity and outputs the analog and judgement outputs. Analog output Decision output ON OFF
	Calculates the light intensity integral value (I) from the incident light intensity (P) and time (T) using the following equation: $I = P \times T$. Also outputs the integral's analog output simultaneously and displays the digital (%) value. (Output ON at 100%.)
Remote teaching function	In light monitor mode or light intensity integration mode, teaching is performed by pulse signal input.

Built-in Amplifier Type

● F3UV-A30/A03

- Operate indicator (orange): Analog output value lights up by 4 to 5 V.
- Power supply indicator (green): Light up by power on.
- Sensitivity adjuster: Adjustment of sensitivity



Functions

Name	Functions	
Display function	P indicator	Lit green when power supply is ON.
	Operation indicator	Lit orange when the analog output is between 4 and 5 V.
Output function	Analog output	Outputs voltage proportional to incoming light intensity. (Offset voltage of 0.2 V or higher)
Sensitivity adjustment function		Sensitivity can be set to the desired level with this one-turn adjuster.

Operation

● F3UV-A30/A03

Sensitivity adjustment method

During initial setup or when UV light source is replaced, adjust the analog output to 4 to 5 V as follows.

(Sensitivity adjustment)

After installing the sensor, adjust the sensitivity with the sensitivity control.

When the analog output is within the range of 4 to 5 V, the orange operation indicator lamp illuminates. Once it illuminates, fine adjust the output to the required voltage.

(If the UV light intensity is too high)

If the analog output is 5.0 V or higher when the sensitivity control is set to MIN (all the way to the left), the UV light intensity exceeds the sensor specification. Either use the optional F39-HU1 Exposure Cover, or move the sensor away from the UV lamp.

(If the UV light intensity is too low)

If the analog output is 5.0 V or lower when the sensitivity control is set to MAX (all the way to the right), the UV light intensity is lower than the sensor specification. Move the sensor closer to the UV lamp.

● F3UV-XW11/XW41

Basic Operating Procedures

- (1) Install the Amplifier Unit.
- (2) Connect the Fiber Unit to the Amplifier Unit.
- (3) Turn ON the power supply.
- (4) Select an operating mode with the operation mode switch.
(Light intensity monitor mode or light intensity integral mode)
- (5) When using the analog output, select current or voltage output with the output selection switch.
- (6) Set the processing mode switch to TEACH and perform the teaching operation.
 - Light Intensity Monitor Mode
Perform the zero-point setting when the indicator is not lit and make the sensitivity setting when the indicator is lit. (Perform the sensitivity setting after the temperature has stabilized.)
 - Light Intensity Integral Mode
Use the start setting at the start of illumination and the stop setting when completed.
Teaching can be performed by pressing the buttons or with codes.
- (7) When changing the threshold value in light intensity monitor mode, set the processing mode switch to ADJ and adjust the threshold value. The judgement output will go ON if the light intensity is below the threshold value. The threshold value is set to 50 at the factory.
- (8) Set the processing mode switch to RUN to start measurement. In light intensity integral mode, start integration with the Reset input.

For detailed operation procedures, see the product manual.

● F3UV-XA

Sensitivity adjustment method

During initial setup or when UV light source is replaced, adjust the control output to any value between 4 and 5 V using the sensitivity control. After that, you can monitor weakening of the UV light source intensity by monitoring the control output value.

(Sensitivity adjustment)

After installing and securing the sensor, adjust the sensitivity with the sensitivity control. When the control output value is within the range of 4 to 5 V, the orange operation indicator lamp illuminates. (The sensor output goes up to approximately 6 V, and thus the operation indicator lamp does not illuminate if the sensitivity is too high.) Adjustment is easier if you verify that the operation indicator lamp is illuminated and then fine-adjust the sensitivity to the desired value while viewing the voltmeter display.

(If the UV light intensity is too high)

If the analog output is 5.0 V or higher when the sensitivity control is set to MIN (all the way to the left), or if the analog output does not decrease when the sensor is moved away from the UV lamp, the UV light intensity exceeds the sensor specification. Move the sensor further away from the UV lamp

(If the UV light intensity is too low)

If the analog output is 5.0 V or lower when the sensitivity control is set to MAX (all the way to the right), the UV light intensity is lower than the sensor specification. Move the sensor closer to the UV lamp.

Precautions

Important

Be sure to observe the precautions listed here. These precautions are essential for safe operation.

- (1) Do not disassemble, repair, or modify this product.
- (2) Do not short-circuit the two ends of the load.
- (3) Do not install the amplifier unit in a location where it will be exposed to ultraviolet light.

Correct Use

F3UV general

Wiring Considerations

Connection

- (1) Ensure that the power supply voltage is below the maximum voltage before turning the power ON.
- (2) Ensure that the terminal polarity and wiring are correct.
- (3) Use a cable with 0.3 mm² or greater wires and which is no more than 5 m in length, and test operation before using.

Power Supply

Do not use the system until 1 second has elapsed after turning on the power and it is in a detection-capable state. If the F3UV and the unit on which it is installed are connected to separate power sources, be sure to turn on the F3UV power first.

During use

Mounting the sensor

Ultraviolet light is harmful. Ensure the UV lamp is off when you install it.

Sensitivity setting

Temperature drift may cause the analog output value to change. If the temperature is rising, wait until it has stabilized sufficiently to set the sensitivity.

Output characteristics

If the analog output is not proportional to the ultraviolet illuminance of another manufacturer's illuminance meter, the following problems are possible.

- (1) If the distance between the lamp and the sensor was changed to adjust the ultraviolet illuminance, the values sometimes differ due to differing angles of view in the sensor receiver and in the other manufacturer's illuminance meter receiver.
- (2) If the illumination power of the UV lamp was changed to adjust the ultraviolet illuminance, accurate monitoring may not be possible due to insufficient stability of the UV lamp. Wait until the UV lamp has sufficiently stabilized and then perform the measurement.
- (3) If the temperature rises due to the UV lamp, wait until the sensor temperature stabilizes sufficiently and then perform the measurement.
- (4) If the sensor and the illuminance meter have different sized receiver areas, the values sometimes differ due to uneven illuminance on the receiver surface.

Miscellaneous

Cleaning

Do not use thinners. Use a soft cloth or blower brush to remove dust and dirt from the receiver window.

F3UV-A30/-A03

Mounting dimensions

(Installation strength)

Screws for mounting the sensor should be tightened to a torque of no more than 0.49 Nm.

(Protection against ultraviolet light)

The indicator lamps and cables on the sensor are not protected against ultraviolet light. If the indicator lamps and cables will be exposed to ultraviolet light, use the F39-HU2 and F39-CU1 to protect these parts.

Use protective gear if ultraviolet light will directly enter your field of vision or shine on your skin while mounting and adjusting the sensor.

F3UV-XW11/XW41/XA

Mounting

Mounting procedure

- (1) Mounting strength * The torque for tightening screws when installing the sensor should be no more than 0.49 Nm.
- (2) Using a DIN rail
(Mounting)

- 1. Hook the top of the Unit onto the DIN Track.

- 2. Snap the bottom of the Unit onto the DIN Track.

Note: Do not reverse steps 1 and 2.

(Removal)

When removing the Unit from the DIN Track, pull the mounting hook forward to release it.

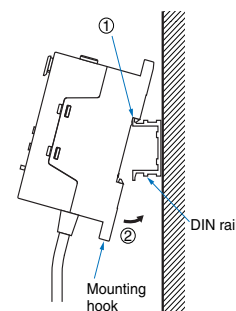

*F3UV-XW11/XW41 only

Protection against ultraviolet light

This amplifier is not protected against ultraviolet light.

Do not install the amplifier unit in a location where it will be exposed to ultraviolet light.

Fiber Unit/Base Unit

Mounting

Mounting the head unit when using as an ultraviolet power monitor

When installing the head unit, turn off the ultraviolet light and install in safe conditions.

The torque for tightening screws on the fiber unit should not exceed 0.78 Nm.

(F3UV-HM)

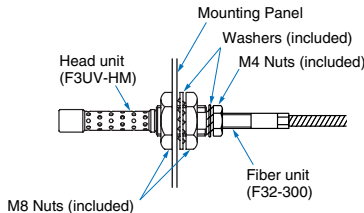

(F3UV-HT)

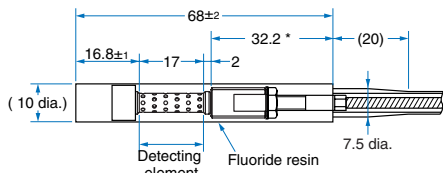

* When using mounting bracket, please use within this dimensions.

Mounting the fiber unit when using as an illumination monitor

As with a regular fiber unit, attach using a an M4 locking nut.

When connecting to an amplifier unit

The quality of the connection between the Fiber Unit and Amplifier Unit has a major impact on the operating characteristics, so be sure to connect these Units securely.

(1) Cutting the Fiber (F32-70 only)

Insert the fiber into the hole of the cutting tool and set the tool at the desired length.

Press down the blade and cut the fiber. Do not stop when the fiber is only partially cut; make one clean cut

Once a hole has been used to cut a fiber, do not use that hole again. The cut surface may not be clean enough and the detection characteristics may be degraded.

(2) Installing the Fiber

With the lock button in the release position, insert the fiber into the Unit and press the button until you hear a click. This click is the sound of the fiber being locked.

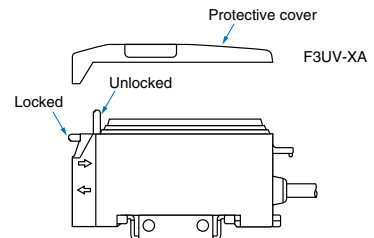
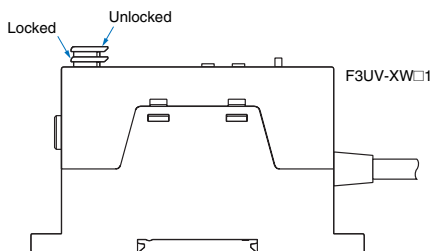

(3) Fiber removal

Press the lock button again. The lock will be released, the lock button will pop up, and it will be possible to remove the fiber.

Do not force the lock button up by pulling on it. (To maintain the fiber's characteristics, check whether the lock is out of place.)

(4) Fiber Insertion Location

When inserting the Fiber Unit into the Amplifier Unit, always insert the Fiber Unit completely as shown in the following diagram.

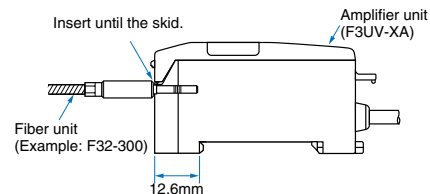
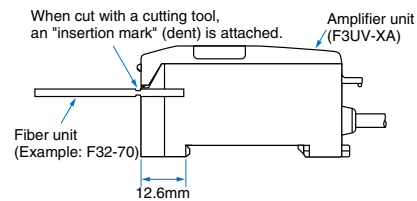
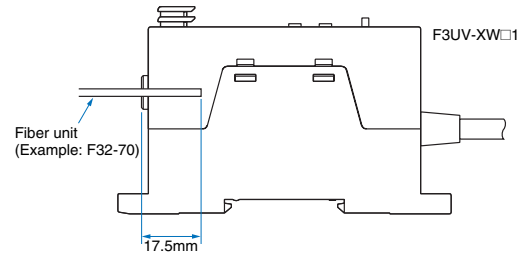
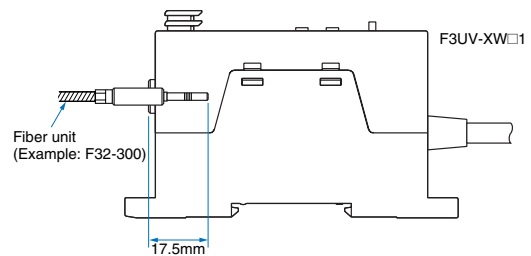

(5) Fiber Unit Installation/Removal Precautions

Install and remove the Fiber Unit only when the ambient temperature is between -40 and 40°C.

(6) Protecting the Fiber Unit

If the outer sheathing of a Fiber Unit other than the F32-300 is exposed to UV light, protect the fiber by covering it with the F39-FU1M Protective Tube.

Dimensions (Unit: mm)

Built-in Amplifier Type

Sensors

F39UV-A30/-A03

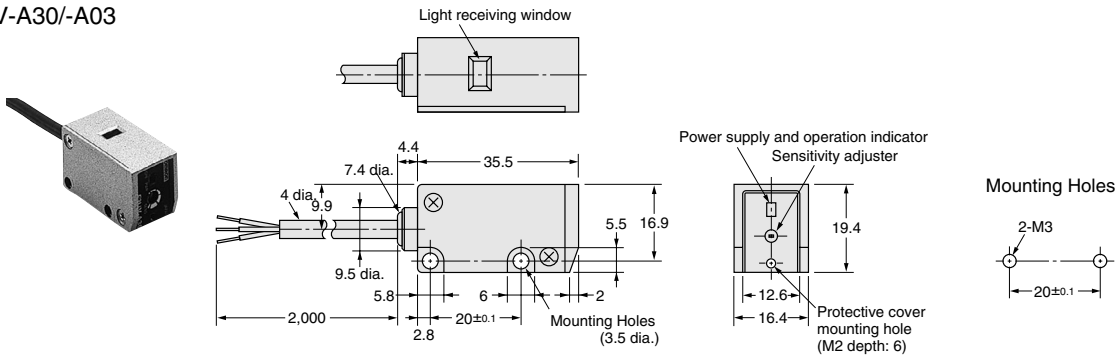

Accessories (Order Separately)

Protective Tube (Protects Cord.)

F39-CU1M

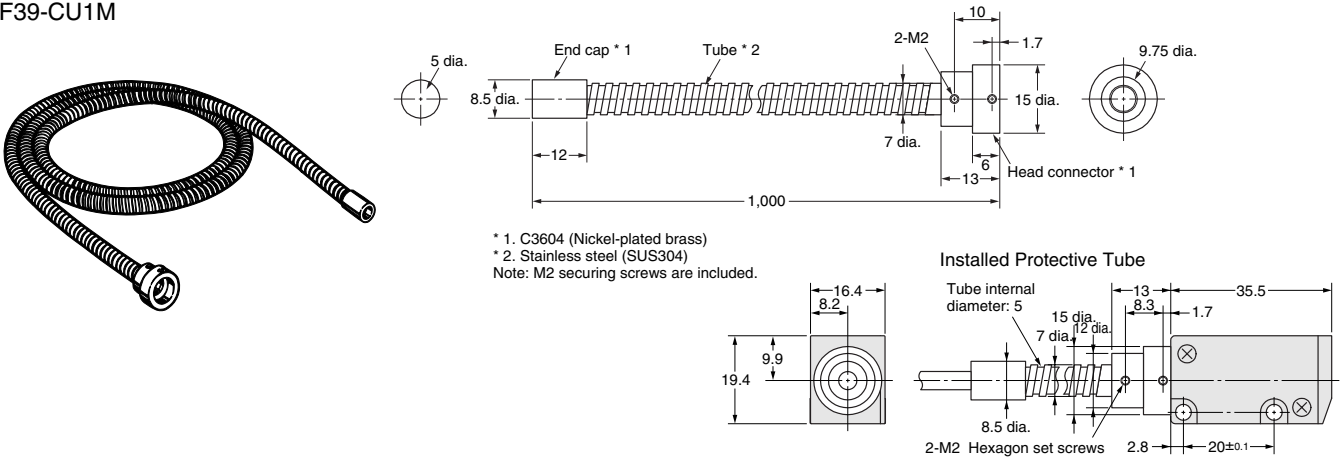

Protective Cover (Protects the display.)

F39-HU2

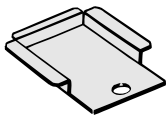

Material: Stainless steel (SUS304-CSP)
t = 0.2

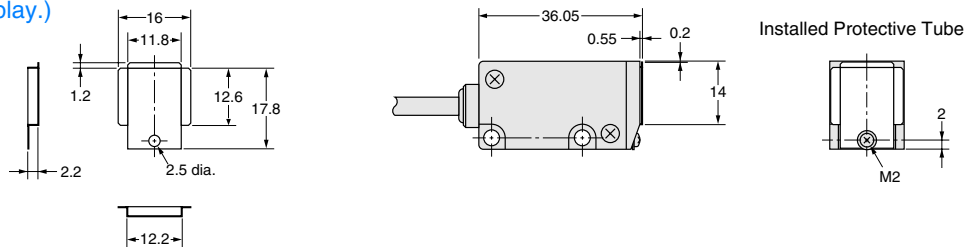

1/6.5 Filtering Cover

F39-HU1

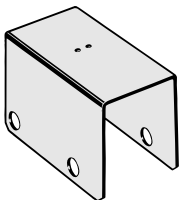

Material: Stainless steel (SUS304-CSP)
t = 0.2

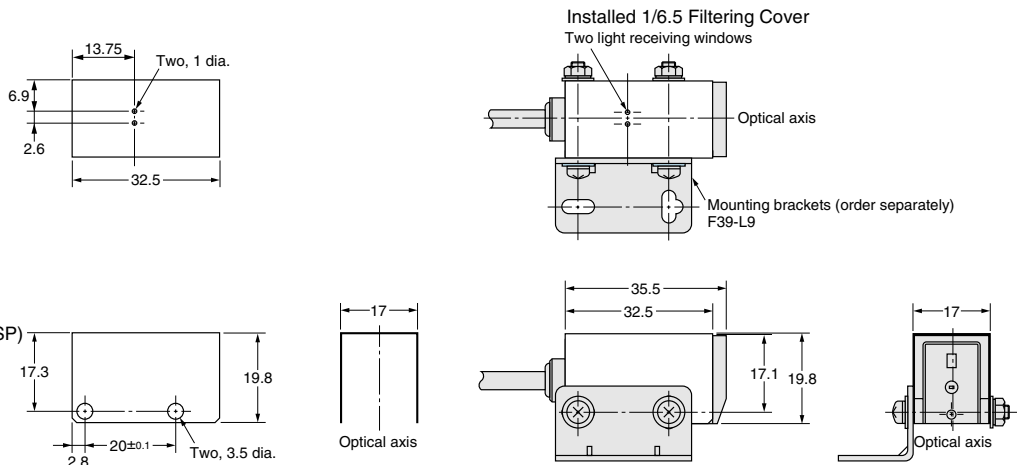

Mounting Brackets

Optical Fiber Type

Sensors

Amplifier Units

F3UV-XW11/XW41

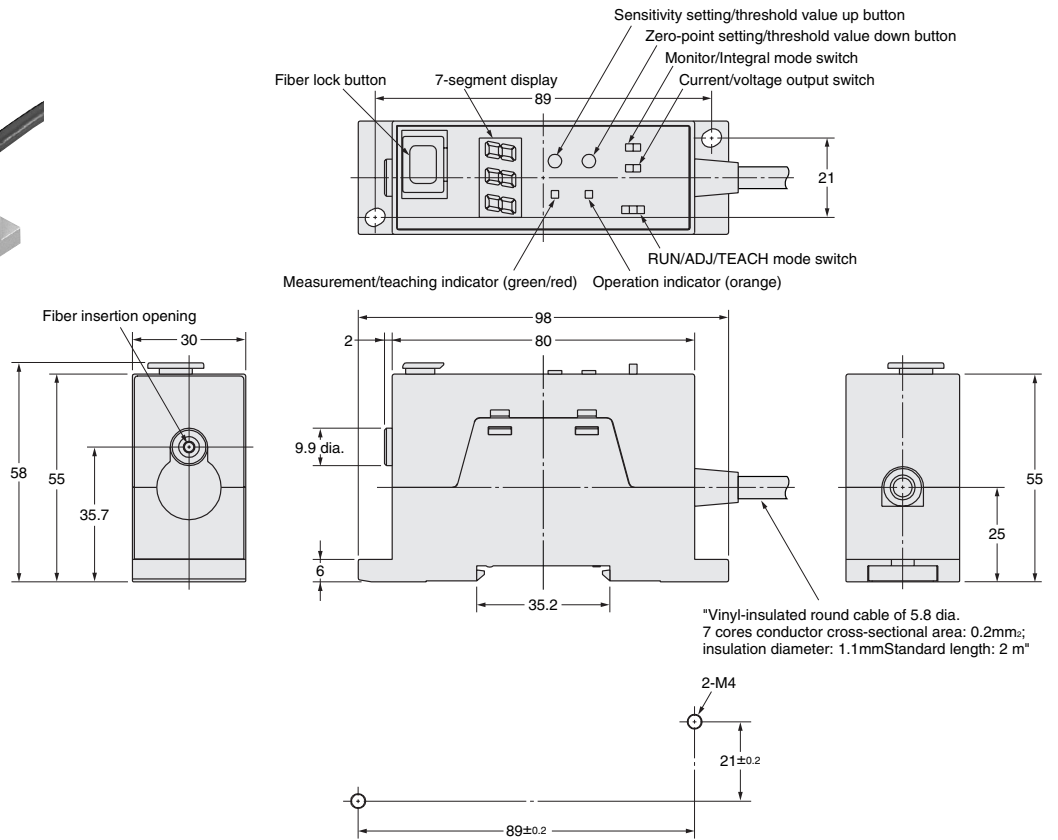
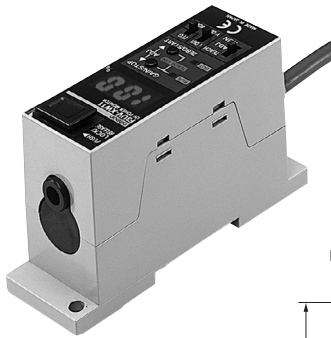

Amplifier Units

F3UV-XA

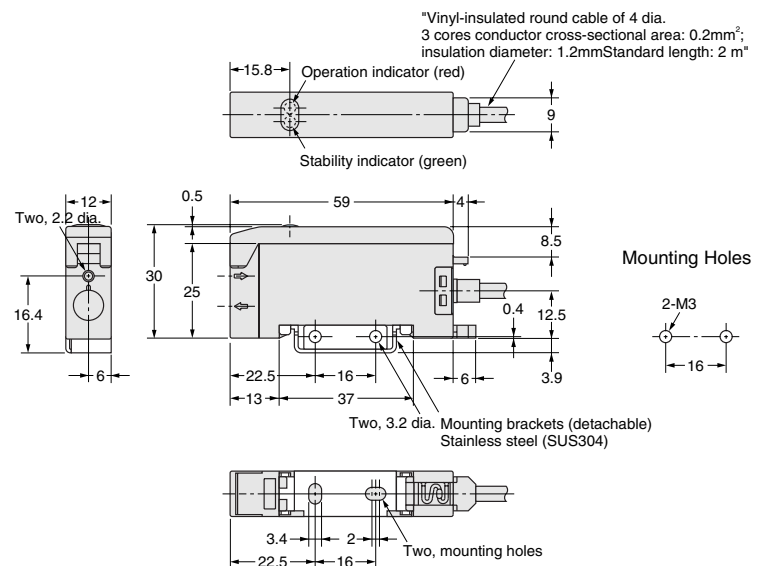

Head Unit

F3UV-HM

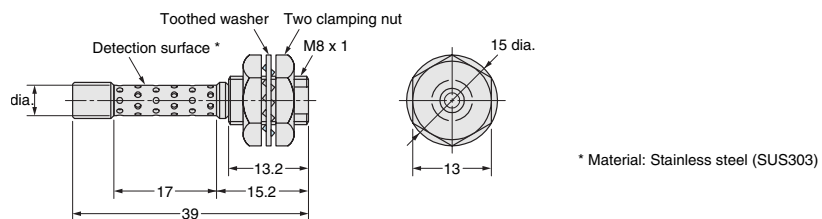

Head Unit

F3UV-HT 5m

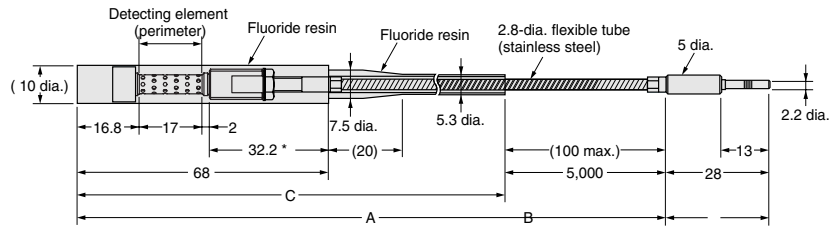

Note 1. Heat resistance temperature is 150°C for part A and 110°C for part B (part inserted in unit).
 2. Protective structure is IP67 only for part C (fluororesin part)

F3UV-HT 10 m

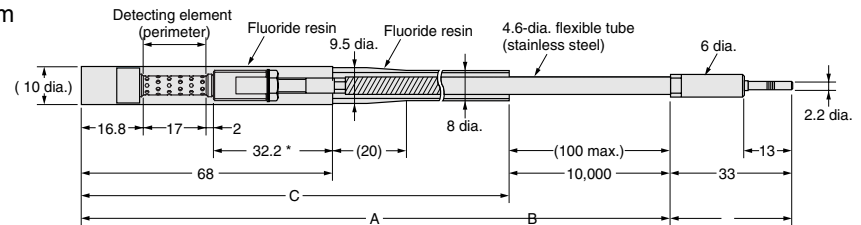

Note 1. Heat resistance temperature is 150°C for part A and 110°C for part B (part inserted in unit).
 2. Protective structure is IP67 only for part C (fluororesin part)



Fiber Units

F32-300

Dimensions when F3UV-HM and F32-300 are connected

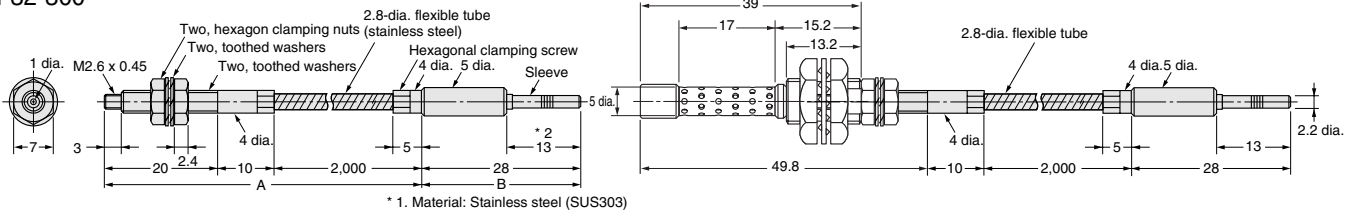

Note: Heat resistance temperature is 300°C for part A and 110°C for part B (part inserted in unit). However, take care that parts inserted in unit (parts marked are within operating temperature range of amplifier.

Fiber Units

F32-70

Dimensions when F3UV-HM and F32-70 are connected

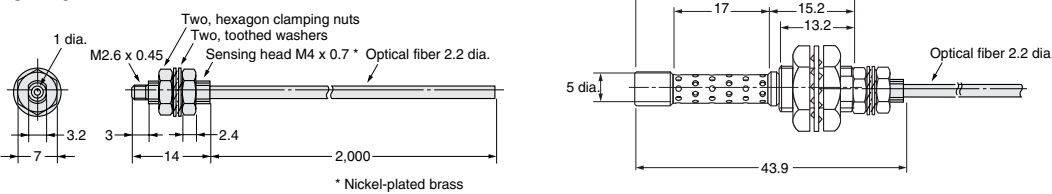

Note: indicates that free-cutting is possible. Free-cutting is not possible on units that are not marked with .

Accessories (Order Separately)

Protective Tube (Protects the Fiber.)

F39-FU1M

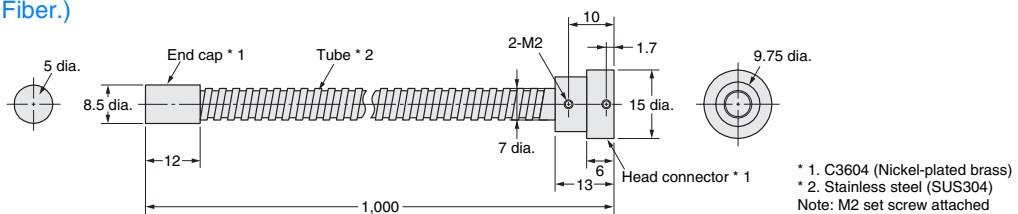
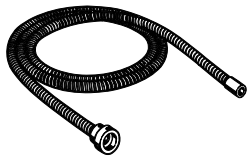

* 1. C3604 (Nickel-plated brass)
 * 2. Stainless steel (SUS304)
 Note: M2 set screw attached

ALL DIMENSIONS SHOWN ARE IN MILLIMETERS.
 To convert millimeters into inches, multiply by 0.03937. To convert grams into ounces, multiply by 0.03527.