

Transparent bottle sensor

E3S-CR62/67

Ideal for detecting transparent glass and plastic containers



Features

Stable operation even if container interval is shortened for higher productivity.

Stable detection of 5 mm gaps that previous regression reflection models were unable to detect because of a speed increase for higher productivity.

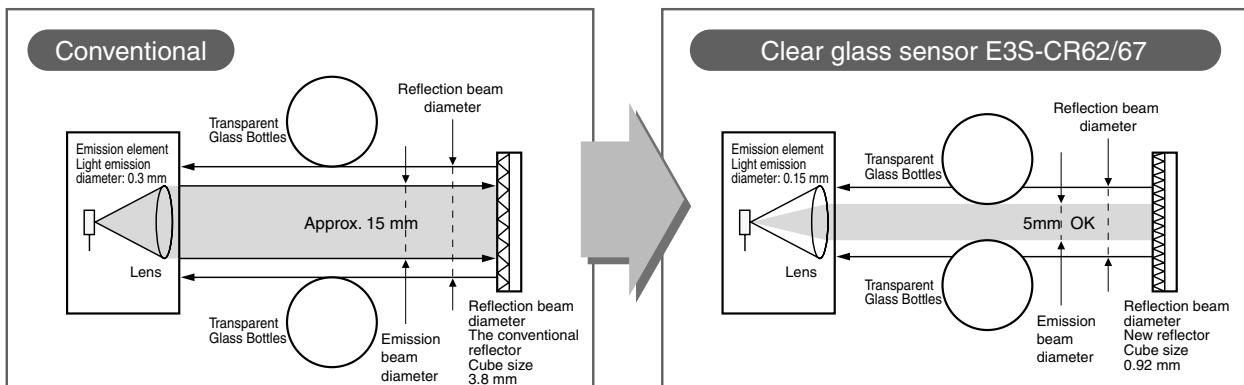
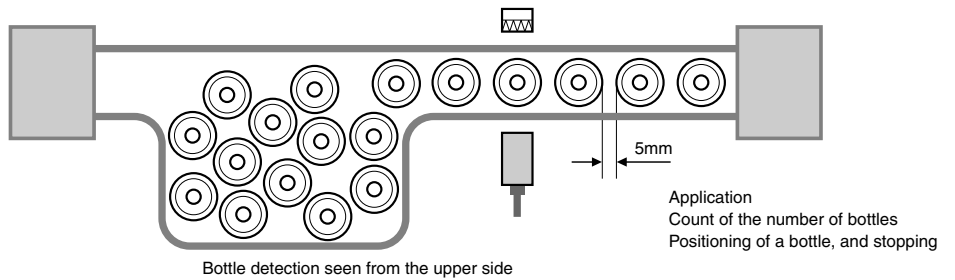

Application

Narrow pin interval detection
Stable detection of 5 mm gaps that are not detectable by previous regression reflection models.

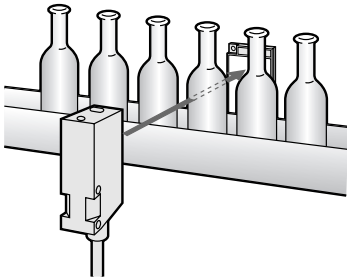

Wide detection range. Stable detection even at long distances.
Use of hyper-point LED as light source (1/2 light emission diameter of previous models) enables stable long-distance detection.

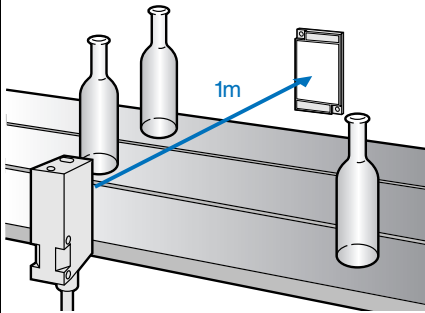

Stable detection of ampules and other small containers.
Visible spotlight for easy adjustment.

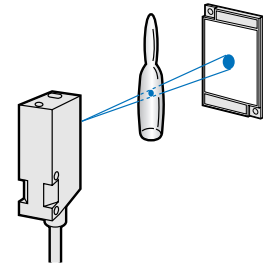

Features

We significantly increased the S/N ratio to enable a stable detection of PET bottles and various other transparent containers

Problem 1

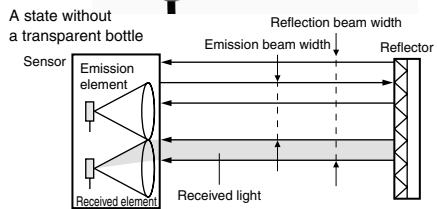
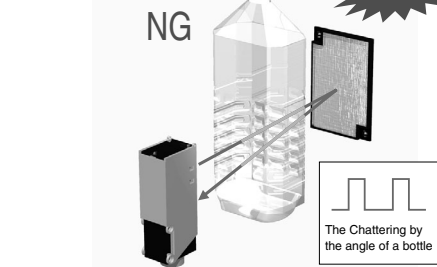

Problem 2

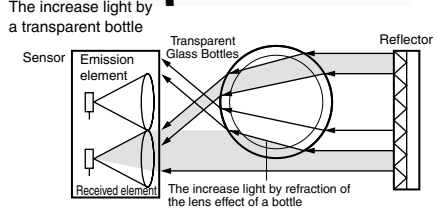
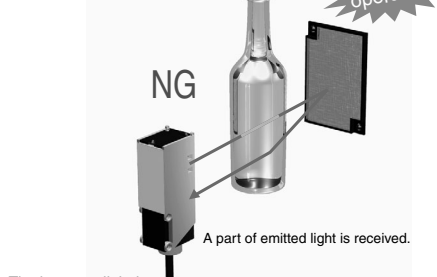

Clear glass sensor E3S-CR62/67

Adoption of the coaxial retroreflective model

Stable detection can be carried out also to the transparent bottle of various form and surface states. A state without a transparent bottle

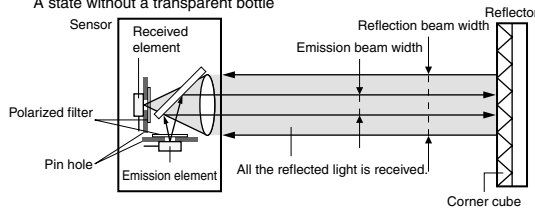

Light is certainly intercepted by the transparent bottle.

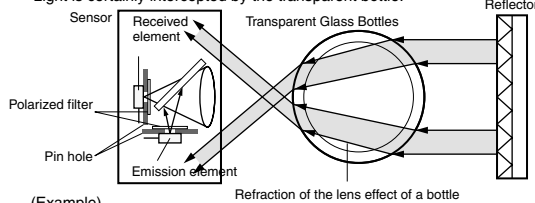

(Example)

Using E39-R6 (The characteristic in a short distance)

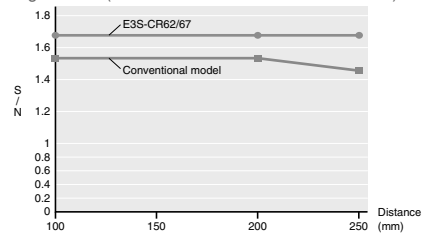

Using E39-R1 (The characteristic in a long distance)

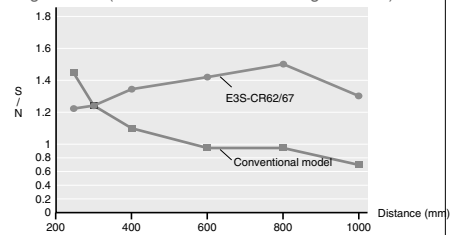

Ordering Information

Sensors

 Red light

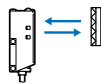
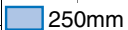
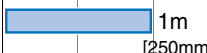
Sensor type	Shape	Connection method	Sensing distance		Model
			Reflector E39-R6	Reflector E39-R1	
Retroreflective Models		Pre-wired type	 250mm	 1m [250mm]	E3S-CR62-C
		Connector type			E3S-CR67-C

* Values in parentheses indicate the minimum required distance between the sensor and reflector.

Accessories (Order Separately)

Reflectors



Name	Sensing distance	Model	Quantity	Remarks
Reflectors	250 mm	E39-R6	1	---
	1 m (250 mm) *	E39-R1	1	

* Values in parentheses indicate the minimum required distance between the sensor and reflector.

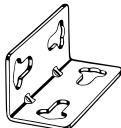
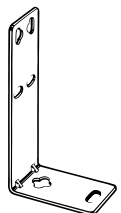
Mounting Brackets

Shape	Model	Quantity	Remarks
	E39-L103	1	Supplied with the product.
	E39-L87	1	---

Sensor I/O Connectors

Cable	Shape	Cable length		Model
Standard cable	Straight 	2 m	3-wire type	XS2F-D421-DC0-A
		5 m		XS2F-D421-GC0-A
	L-shape 	2 m		XS2F-D422-DC0-A
		5 m		XS2F-D422-GC0-A

Rating/performance

Item	Sensor type	Retroreflective Models (M.S.R. function)	
	Model	E3S-CR62-C	E3S-CR67-C
Sensing distance	250 mm (When using the E39-R6), 1 m (250 mm)*1 (When using the E39-R1)		
Standard sensing object	30 mm dia. X 150 mm glass tube (thickness: 1.8 mm)		
Directional angle	2 to 6°		
Light source (wave length)	Red LED (660 nm)		
Power supply voltage	10 to 30 VDC, ripple (p-p) : 10 % max.		
Current consumption	40 mA max.		
Control output	Load supply voltage: 30 VDC or less; load current 100 mA or less (residual voltage: NPN output 1.2 V or less, PNP output 2 V or less); open collector model (NPN/PNP output switching) light ON / dark ON switching		
Protective circuits	Load short protection, reverse connection protection, mutual interference protection function		
Response time	Operation or reset: 1 ms max.		
Sensitivity adjustment	2-turn endless adjuster (with indicator)		
Ambient illuminance	Incandescent lamp: 5,000 lux max. Sunlight 10,000 lux max.		
Ambient temperature	Operating: -25°C to 55°C, Storage: -40°C to 70°C (with no icing or condensation)		
Ambient humidity	Operating: 35% to 85% RH, Storage: 35% to 95% RH (with no icing or condensation)		
Insulation resistance	20 M min. at 500 VDC		
Dielectric strength	1,000 VAC at 50/60 Hz for 1 minute		
Vibration resistance	Destruction: 10 to 2,000 Hz, 1.5 mm double amplitude or 300 m/s ² (approx. 30G) for 0.5 hrs each in x, y, and Z directions		
Shock resistance	1000 m/s ² (approx. 100G) 3 times each in X, Y, and Z directions		
Protective structure	IEC Standard IP67 NEMA 6P (restricted to indoor use) *2		IEC Standard IP67 NEMA 6P (restricted to indoor use)
Connection method	Pre-wired models (standard length: 2 m)		Connector type
Weight (Packed state)	Approx. 115 g		Approx. 80 g
Material	Case	Zinc diecast	
	Lens	Acrylics	
	Display operation panel	Polyethyl sulfon	
	Mounting Brackets	Stainless steel (SUS304)	
Accessories	Brackets (with screws), adjustment driver, operation manual		

*1. Values in parentheses indicate the minimum required distance between the sensor and reflector.

*2. NEMA (National Electrical Manufacturers Association) Standard

Output Circuit Diagram

NPN output

Model	Operating status of output transistor	Timing chart	Mode selection switch	Output circuit
E3S-CR62-C E3S-CR67-C	Light ON	Incident Interrupted Light indicator (red) ON OFF Output transistor ON OFF Load (Relay) Operate Reset (Between brown and black)	L ON (LIGHT ON)	<p>* Please make a changeover switch into the NPN side.</p> <p>Connector Pin arrangement</p> <p>Note: Pin 2 is not used.</p>
	Dark ON	Incident Interrupted Light indicator (red) ON OFF Output transistor ON OFF Load (Relay) Operate Reset (Between brown and black)	D ON (DARK ON)	<p>* Please make a changeover switch into the NPN side.</p> <p>Connector Pin arrangement</p> <p>Note: Pin 2 is not used.</p>

PNP output

Model	Operating status of output transistor	Timing chart	Mode selection switch	Output circuit
E3S-CR62-C E3S-CR67-C	Light ON	Incident Interrupted Light indicator (red) ON OFF Output transistor ON OFF Load (Relay) Operate Reset (Between blue and black)	L ON (LIGHT ON)	<p>* Please make a changeover switch into the NPN side.</p> <p>Connector Pin arrangement</p> <p>Note: Pin 2 is not used.</p>
	Dark ON	Incident Interrupted Light indicator (red) ON OFF Output transistor ON OFF Load (Relay) Operate Reset (Between blue and black)	D ON (DARK ON)	<p>* Please make a changeover switch into the NPN side.</p> <p>Connector Pin arrangement</p> <p>Note: Pin 2 is not used.</p>

Connectors (Sensor I/O connectors)

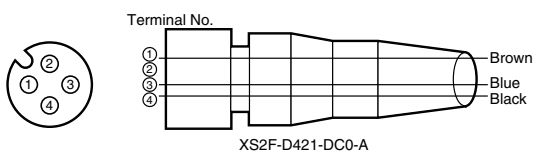

Class	Wire, outer	Connector pin	Application
For DC	Brown	①	+V
	-	②	-
	Blue	③	0V
	Black	④	Output

Note: Pin 2 is open.

Nomenclature

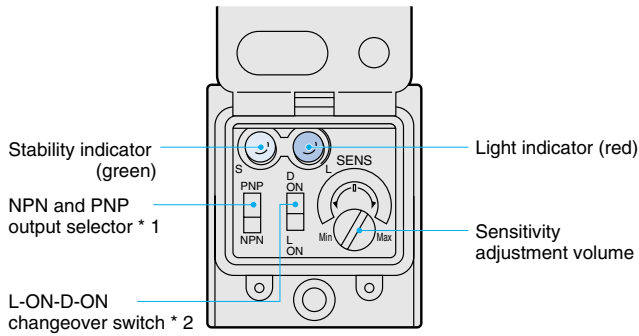

*1. Output transistor switching is possible by means of NPN/PNP output switch.
 *2. Operation mode can be switched using L ON/D ON switch.

Operation

Sensitivity adjustment

The light source switch and reflective plate can be moved horizontally and vertically to set them in the center of the illumination area of the red incident light indicator lamp, allowing the operator to check whether the green stability indicator lamp is illuminated.

Sensing object	Detection state	Sensitivity adjuster	Indicator state	Adjustment procedure	
Transparent pin or glass plate	Without sensing object		ON Stability indicator (green)	ON Light indicator (red)	Turn sensitivity control from minimum to maximum and set at point where incoming light stabilizes.
Opaque object	Object detected, object not detected		ON Stability indicator (green)	ON Light indicator (red)	If the object is larger than the lens diameter, set the sensitivity control to the maximum setting. If the object is the same size or smaller, turn the sensitivity control from minimum to maximum and set at point where incoming light stabilizes.

Precautions

Correct Use

Design

Fuzzy mutual interference prevention

- If the light source switches for the reflective plates are arranged in a row, light from a neighboring light source switch may be received, causing erroneous light reception signals and errors.
- The fuzzy reciprocal interference prevention function monitors interference light for a certain period of time before illumination, and gathers data on the strength of the interference light and the frequency of incidence. It then determines the risk of error due to these two factors using fuzzy logic and controls the timing of illumination to reduce the risk.

(When risk is low)

- Light is emitted after interfering light is gone.

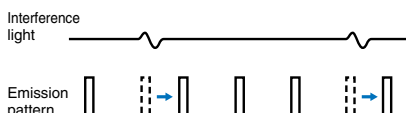

(In case of high risk)

- Light is emitted after shifting to a gap of interfering light.

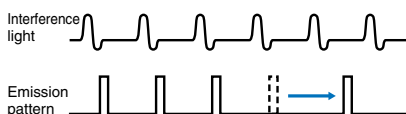

Bottles

In some cases, factors such as the shape of a bottle prevent stable detection. Please confirm that a correct detection is performed before use.

Wiring Considerations

Cable

- An oil resistant cable is used to ensure oil resistance. Avoid repeated bending of the cable.
- The bending radius should be 25 mm or more.

Avoiding Malfunctions

When using a photoelectric switch with an inverter or sub-motor, be sure to connect FG (frame ground pin) and G (ground pin). If not connected, errors may result.

Installation

Sensor installation

- When installing a photoelectric switch, avoid tapping with a hammer. This may damage the water resistance function.
- Use an M4 screw, tightened to a torque of no more than 1.18 Nm.

(When using the mounting bracket)

- To set the sensor on the mechanical axis, use the optical axis locking holes.
- When it is not possible to mount on the mechanical shift, move the photoelectric switch vertically or horizontally so that it is located in the center of the area illuminated by the incident light indicator lamp. Verify that the stability indicator lamp is on.

(Direct installation)

Install the photoelectric switch as shown in the following diagram.

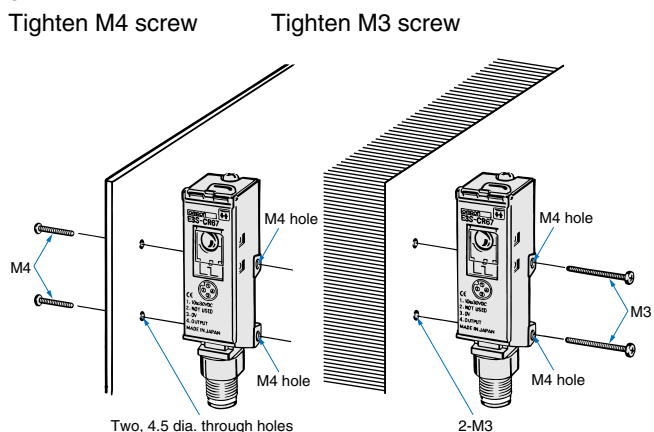

- For adjustment

Light axis adjustment

Adjust the optical axis of the clamp to the direction of detection object approach. The optical axis of the photoelectric switch is the same as the mounting axis of the clamp, enabling easy adjustment.

Optical axis locking hole

By fitting screws into the optical axis locking holes, the mounting bracket is set onto the mounting shaft of the mounting bracket.

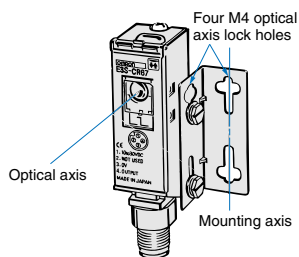

Dimensions (Unit: mm)

Sensors

Retroreflective Models

Pre-wired
E3S-CR62-C

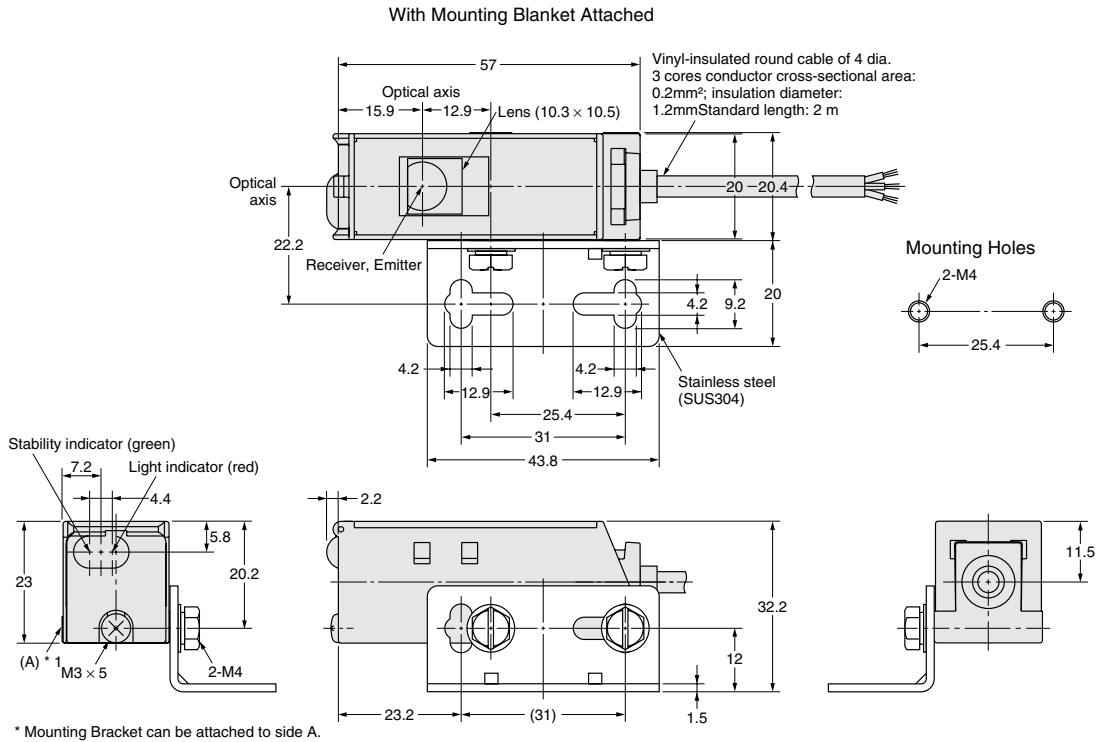

Connector type
E3S-CR67-C

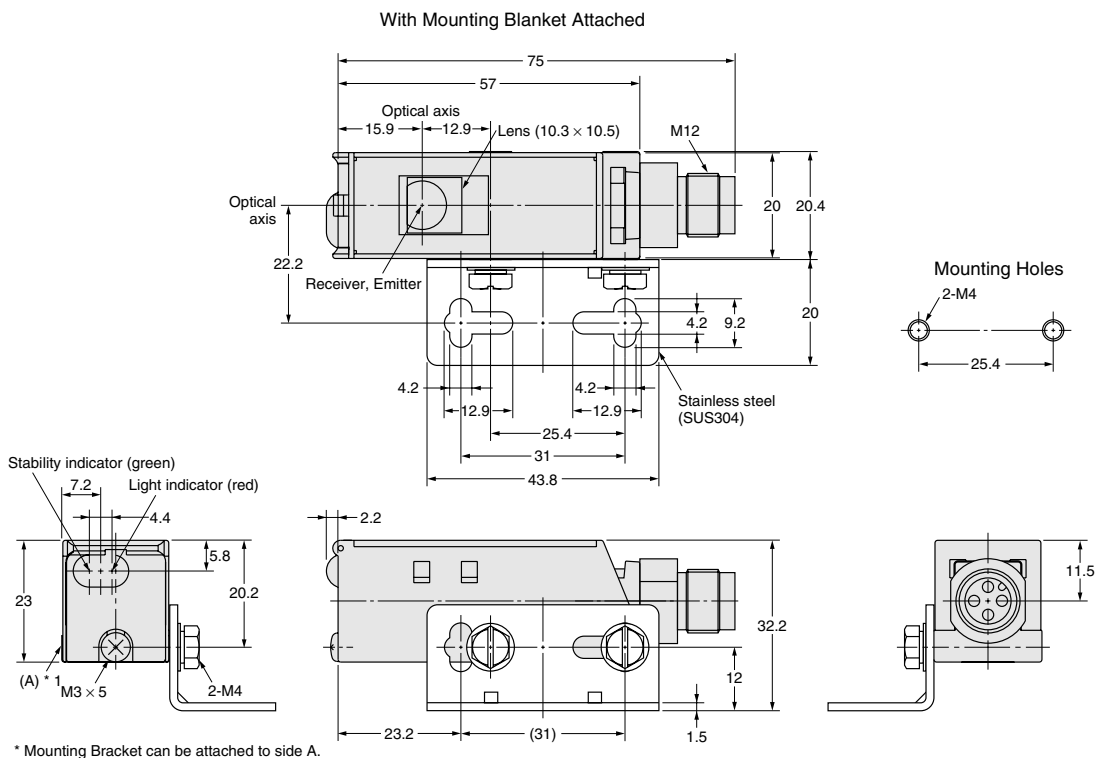

Accessories (Order Separately)

H-3

ALL DIMENSIONS SHOWN ARE IN MILLIMETERS.
To convert millimeters into inches, multiply by 0.03937. To convert grams into ounces, multiply by 0.03527.