

ZS-MDC (Ver 2.0)

Smart Sensors

Multi-Controller

USER'S MANUAL

OMRON

INTRODUCTION	APPLICATION CONSIDERATIONS (Please Read)	Introduction
SECTION 1	FEATURES	Section 1
SECTION 2	INSTALLATION & CONNECTION	Section 2
SECTION 3	SETUP	Section 3
SECTION 4	APPLICATION SETTING EXAMPLES	Section 4
SECTION 5	APPENDIX	Section 5

User's Manual

Smart Sensors
Multi-Controller ZS-MDC

READ AND UNDERSTAND THIS DOCUMENT

Please read and understand this document before using the products. Please consult your OMRON representative if you have any questions or comments.

WARRANTY

OMRON's exclusive warranty is that the products are free from defects in materials and workmanship for a period of one year (or other period if specified) from date of sale by OMRON.

OMRON MAKES NO WARRANTY OR REPRESENTATION, EXPRESS OR IMPLIED, REGARDING NON-INFRINGEMENT, MERCHANTABILITY, OR FITNESS FOR PARTICULAR PURPOSE OF THE PRODUCTS. ANY BUYER OR USER ACKNOWLEDGES THAT THE BUYER OR USER ALONE HAS DETERMINED THAT THE PRODUCTS WILL SUITABLY MEET THE REQUIREMENTS OF THEIR INTENDED USE. OMRON DISCLAIMS ALL OTHER WARRANTIES, EXPRESS OR IMPLIED.

LIMITATIONS OF LIABILITY

OMRON SHALL NOT BE RESPONSIBLE FOR SPECIAL, INDIRECT, OR CONSEQUENTIAL DAMAGES, LOSS OF PROFITS OR COMMERCIAL LOSS IN ANY WAY CONNECTED WITH THE PRODUCTS, WHETHER SUCH CLAIM IS BASED ON CONTRACT, WARRANTY, NEGLIGENCE, OR STRICT LIABILITY.

In no event shall responsibility of OMRON for any act exceed the individual price of the product on which liability is asserted.

IN NO EVENT SHALL OMRON BE RESPONSIBLE FOR WARRANTY, REPAIR, OR OTHER CLAIMS REGARDING THE PRODUCTS UNLESS OMRON'S ANALYSIS CONFIRMS THAT THE PRODUCTS WERE PROPERLY HANDLED, STORED, INSTALLED, AND MAINTAINED AND NOT SUBJECT TO CONTAMINATION, ABUSE, MISUSE, OR INAPPROPRIATE MODIFICATION OR REPAIR.

SUITABILITY FOR USE

THE PRODUCTS CONTAINED IN THIS DOCUMENT ARE NOT SAFETY RATED. THEY ARE NOT DESIGNED OR RATED FOR ENSURING SAFETY OF PERSONS, AND SHOULD NOT BE RELIED UPON AS A SAFETY COMPONENT OR PROTECTIVE DEVICE FOR SUCH PURPOSES.

Please refer to separate catalogs for OMRON's safety rated products.

OMRON shall not be responsible for conformity with any standards, codes, or regulations that apply to the combination of products in the customer's application or use of the product.

At the customer's request, OMRON will provide applicable third party certification documents identifying ratings and limitations of use that apply to the products. This information by itself is not sufficient for a complete determination of the suitability of the products in combination with the end product, machine, system, or other application or use.

The following are some examples of applications for which particular attention must be given. This is not intended to be an exhaustive list of all possible uses of the products, nor is it intended to imply that the uses listed may be suitable for the products:

- Outdoor use, uses involving potential chemical contamination or electrical interference, or conditions or uses not described in this document.
- Nuclear energy control systems, combustion systems, railroad systems, aviation systems, medical equipment, amusement machines, vehicles, safety equipment, and installations subject to separate industry or government regulations.
- Systems, machines, and equipment that could present a risk to life or property.

Please know and observe all prohibitions of use applicable to the products.

NEVER USE THE PRODUCTS FOR AN APPLICATION INVOLVING SERIOUS RISK TO LIFE OR PROPERTY WITHOUT ENSURING THAT THE SYSTEM AS A WHOLE HAS BEEN DESIGNED TO ADDRESS THE RISKS, AND THAT THE OMRON PRODUCT IS PROPERLY RATED AND INSTALLED FOR THE INTENDED USE WITHIN THE OVERALL EQUIPMENT OR SYSTEM.

PERFORMANCE DATA

Performance data given in this document is provided as a guide for the user in determining suitability and does not constitute a warranty. It may represent the result of OMRON's test conditions, and the users must correlate it to actual application requirements. Actual performance is subject to the OMRON Warranty and Limitations of Liability.

CHANGE IN SPECIFICATIONS

Product specifications and accessories may be changed at any time based on improvements and other reasons.

It is our practice to change model numbers when published ratings or features are changed, or when significant construction changes are made. However, some specifications of the product may be changed without any notice. When in doubt, special model numbers may be assigned to fix or establish key specifications for your application on your request. Please consult with your OMRON representative at any time to confirm actual specifications of purchased products.

DIMENSIONS AND WEIGHTS

Dimensions and weights are nominal and are not to be used for manufacturing purposes, even when tolerances are shown.

ERRORS AND OMISSIONS

The information in this document has been carefully checked and is believed to be accurate; however, no responsibility is assumed for clerical, typographical, or proofreading errors, or omissions.

PROGRAMMABLE PRODUCTS

OMRON shall not be responsible for the user's programming of a programmable product, or any consequence thereof.

COPYRIGHT AND COPY PERMISSION

This document shall not be copied for sales or promotions without permission.

This document is protected by copyright and is intended solely for use in conjunction with the product. Please notify us before copying or reproducing this document in any manner, for any other purpose. If copying or transmitting this document to another, please copy or transmit it in its entirety.

Precautions for Safe Use

Please observe the following precautions for safe use of the products.

(1) Installation Environment

- Do not use the product in environments where it can be exposed to inflammable/explosive gas.
- To secure the safety of operation and maintenance, do not install the product close to high-voltage devices and power devices.

(2) Power Supply and Wiring

- The supply voltage must be within the rated range (DC24V±10%).
- Reverse connection of the power supply is not allowed.
- Open-collector outputs should not be short-circuited.
- Use the power supply within the rated load.
- High-voltage lines and power lines must be wired separately from this product. Wiring them together or placing them in the same duct may cause induction, resulting in malfunction or damage.

(3) Others

- Do not attempt to dismantle, repair, or modify the product.
- Dispose of this product as industrial waste.

Precautions for Correct Use

Please observe the following precautions to prevent failure to operate, malfunctions, or undesirable effects on product performance.

(1) Installation Site

Do not install the product in locations subjected to the following conditions:

- Ambient temperature outside the rating
- Rapid temperature fluctuations (causing condensation)
- Relative humidity outside the range of 35 to 85%
- Presence of corrosive or flammable gases
- Presence of dust, salt, or iron particles
- Direct vibration or shock
- Reflection of intense light (such as other laser beams or electric arc-welding machines)
- Direct sunlight or near heaters
- Water, oil, or chemical fumes or spray
- Strong magnetic or electric field

(2) Power Supply and Wiring

- When using a commercially available switching regulator, make sure that the FG terminal is grounded.
- If surge currents are present in the power lines, connect surge absorbers that suit the operating environment.
- Before turning ON the power after the product is connected, make sure that the power supply voltage is correct, there are no incorrect connections (e.g. load short-circuit) and the load current is appropriate. Incorrect wiring may result in breakdown of the product.
- Before connecting/disconnecting the Peripheral device, make sure that the Multi-Controller is turned OFF. The Multi-Controller may break down if the Peripheral device is connected or disconnected while the power is ON.
- Use only combinations with Sensor Controllers specified in this manual.

(3) Orientation when Installing the Multi-Controller

To improve heat radiation, install the Multi-Controller only in the orientation shown below.

Right

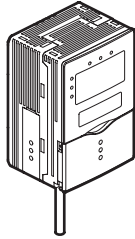

Do not install the Multi-Controller in the following orientations.

Wrong

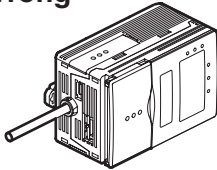

Wrong

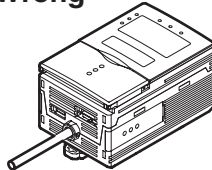

(4) Warming Up

After turning ON the power supply, allow the product to stand for at least 30 minutes before use. The circuits are still unstable immediately after the power supply is turned ON, so measured values may fluctuate gradually.

(5) Maintenance and Inspection

Do not use thinner, benzene, acetone or kerosene to clean the Multi-Controller.

Editor's Note

Page Format

Title of each section

Header

Overview

Cross-header

Overview of the cross-header

Index label

Indicates the section number and title.

Movement through menus up to setting items

Explanation of options

Section 3
Setting the Sensor Controller to Obtain Sensing Information from

Setting the Sensor Controller to Obtain Sensing Information from

Set which gang-mounted Sensor Controller to obtain information from, and which logic operations are to be performed on that information.

Setting Assignments

Assign the channel to perform logic operation on.

Setting	Description
INPUT A (input A)	Assigns the target Sensor Controller to input A. Range: None, 1CH onwards (largest CH of gang-mounted Sensor Controllers) (default: 1CH. Note that range becomes "None" if 1CH does not exist.)
INPUT B (input B)	Assigns the target Sensor Controller to input B. Range: None, 1CH onwards (largest CH of gang-mounted Sensor Controllers) (default: 2CH. Note that range becomes "None" if 2CH does not exist.)
INPUT C (input C)	Assigns the target Sensor Controller to input C. Range: None, 1CH onwards (largest CH of gang-mounted Sensor Controllers) (default: 3CH. Note that range becomes "None" if 3CH does not exist.)
INPUT D (input D)	Assigns the target Sensor Controller to input D. Range: None, 1CH onwards (largest CH of gang-mounted Sensor Controllers) (default: 4CH. Note that range becomes "None" if 4CH does not exist.)

Setting Logic Operation Methods

Set how logic operations are to be performed on the tasks and CH specified by the assignment settings.

Setting	Description
OFF	Expressions are not set.
CH	Logic operations are not performed, and the measured value of a specific CH is input as it is. Select the target CH.

CHECK!

Inputs do not undergo logical operation when "None" is set. Example: The operation "B" is performed when "None" is set to input A, "3CH" is assigned to input B and A-B is selected.

ZS-MDC
User's Manual 3-15

Supplementary Explanation

Helpful information regarding operation and reference pages are introduced here using symbols.



*This page has been made purely for explanatory purposes and does not exist.

■ Meaning of Symbols

Menu items that are displayed on the Multi-Controller LCD screen, and windows, dialog boxes and other GUI elements displayed on the PC are indicated enclosed by brackets [].

■ Visual Aids



Indicates points that are important to ensure full product performance, such as operational precautions and application procedures.

CHECK!



Indicates pages where related information can be found.



Indicates information helpful in operation.

MEMO

Contents

Precautions for Safe Use	5
Precautions for Correct Use	6
Editor's Note	8
Page Format	8
Contents	11
Section 1 FEATURES	1-1
Multi-Controller Features	1-2
Multi-Controller Applications	1-4
Basic Configuration	1-7
Part Names and Functions	1-8
Section 2 INSTALLATION & CONNECTION	2-1
About Installation and Connection	2-2
Multi-Controller	2-3
Attaching the ferrite core	2-3
Installing the Multi-Controller	2-4
About the I/O cable	2-10
Section 3 SETUP	3-1
Setting Flow	3-2
About Setup	3-4
Basic Knowledge for Operation	3-4
List of Setting Items	3-9
Selecting Tasks	3-13
Setting the Sensor Controller to Obtain Sensing Information from	3-14
Setting Assignments	3-14
Setting Logic Operation Methods	3-15
Setting I/O Assignments	3-16
Switching banks by external signal input	3-16
Changing Output Assignments	3-17
Changing Linear Output Assignments	3-17
About Digital Output	3-17

Section 4 APPLICATION SETTING EXAMPLES	4-1
Measuring the Thickness of Multiple Points (sandwiched thickness)	4-2
Measuring the Relative Difference between Steps	4-5
Measuring the Reference Difference between Steps	4-8
Measuring Flatness	4-10
Measuring the Average Height	4-12
Measuring the Twist of a Workpiece	4-14
Measuring the Warp of a Workpiece	4-17
Section 5 APPENDIX	5-1
Troubleshooting	5-2
Error Messages and Countermeasures	5-3
Q&A	5-4
Glossary	5-5
Specifications and External Dimensions	5-6
Multi-Controller	5-6
Panel Mount Adapters	5-9
RS-232C Cable for Connecting to a Personal Computer	5-10
Controller Link Unit	5-11
Version Up Information	5-12
Index	5-13
Revision History	5-16

Section 1

FEATURES

☒ Multi-Controller Features	1-2
☒ Multi-Controller Applications	1-4
☒ Basic Configuration	1-7
☒ Part Names and Functions	1-8

Multi-Controller Features

The Multi-Controller is a dedicated controller that gets and performs logical operations on data obtained from multiple Sensor Controllers. This Multi-Controller features completely digital-based, data corruption-free logic operation capabilities, and outstanding operability and convenience.

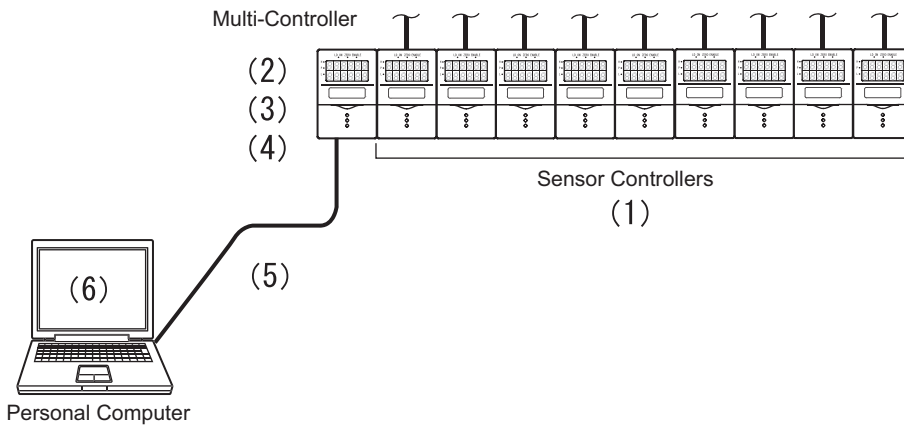

(1) Supports Connection to Up to 9 Sensor Controllers

Logic operations can be performed on gang-mounted controllers. Information can be collected and logic operations performed on information from up to nine Sensor Controllers, which makes the Multi-Controller ideal for multi-point measurement applications.

(2) Wide Range of Logic Operation Functions

Dedicated expressions such as sandwiched thickness, step and average are provided in the setup menu. Up to four types of expressions can be stored to memory as “tasks,” which allows you to easily achieve multi-point measurement applications for performing advanced operations such as measurement of workpiece waviness, flexure, twist, and warp.

 List of Setup Items p.3-9

(3) Completely Digitally Based Logic Operation Processing

Logic operations are batch-executed digitally on controller information. Even in multi-point measurement applications, corruption-free measurement results can be output.

(4) Same Compact Size as Sensor Controller

- The Multi-Controller is the same compact size as the Sensor Controller, which means that it can be installed at a wide range of sites.



External Dimensions p.5-6

- A wide range of processing functions (e.g. filter and hold) the same as those on a Sensor Controller are incorporated on the Multi-Controller, enabling processing of logic operations matched to specific applications.



List of Setup Items p.3-9

(5) USB Connection

A USB port (Full-Speed USB2.0 specification-compliant) is provided as standard on the Multi-Controller. This enables the results of operations between Sensor Controllers to be easily loaded to a personal computer.

(6) Dedicated Software “SmartMonitor Zero”

The “SmartMonitor Zero” software for setting up and monitoring multi-window displays and logging is provided (Sold separately). This software also supports the display and setup of data such as monitoring of waveforms and designation of area that is not possible on the Sensor Controller alone.

Multi-Controller Applications

● Measurement of Workpiece Thickness at Multiple Locations

Sensor Heads can be placed so as to sandwich the workpiece and measure its thickness. Logic operations can be performed not only on one location but on multiple locations to calculate the difference in the measurement result.

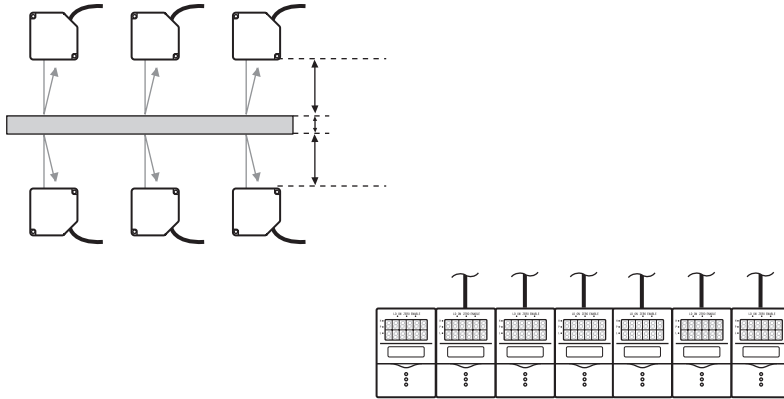

● Measurement of Stepped Workpieces

Logic operations can be performed on measured values obtained from multiple Sensor Controllers to measure steps in stepped workpieces.

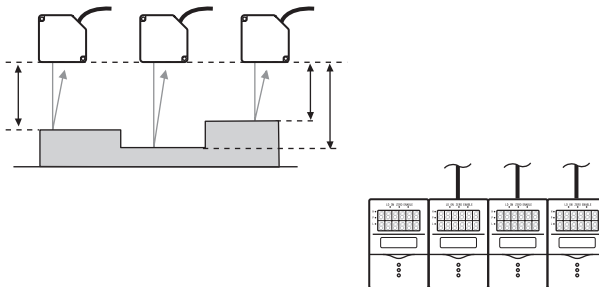

● Measurement of Average Workpiece Height

Logic operations can be performed on measured values obtained from multiple Sensor Controllers to measure the average height of workpieces.

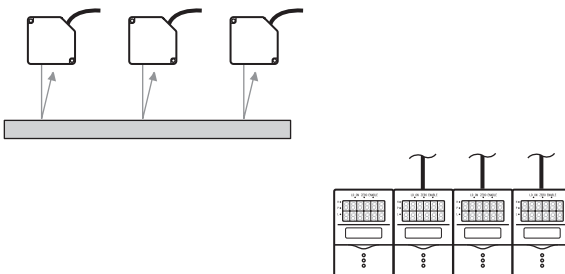

● **Measurement of Workpiece Flatness**

Logic operations can be performed on measured values obtained from multiple Sensor Controllers to measure the flatness of workpieces.

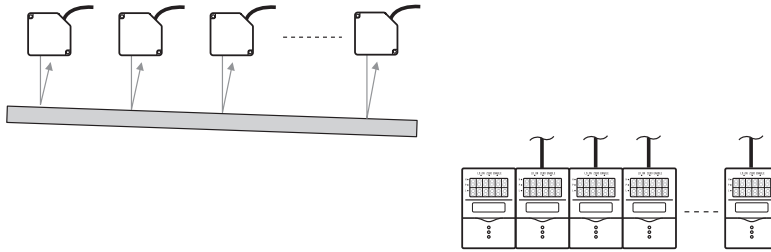

● **Measurement of Workpiece Strain**

Logic operations can be performed on measured values obtained from multiple Sensor Controllers to measure the waviness, flexure, twist, and warp of steel plate and other workpieces.

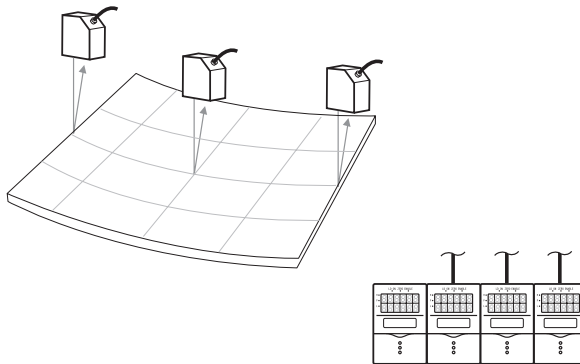

● **Batch-acquisition of Multi-point Measurement Data**

Communications commands can be used to batch-acquire the measurement results of gang-mounted Sensor Controllers.

 About Digital Output p.3-17

You can also use the optional software “SmartMonitor Zero” to batch-display on the digital displays and batch-log measurement results.

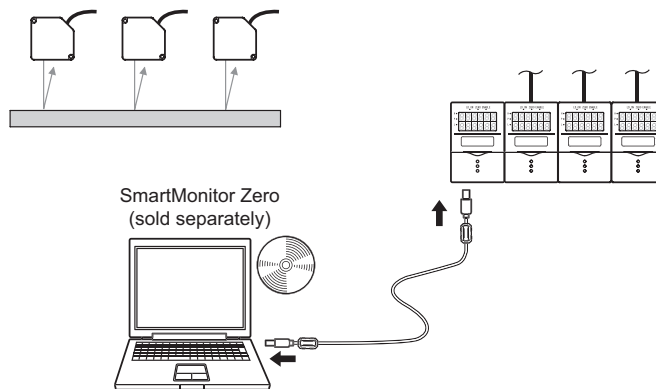

Moreover, connecting a personal computer pre-installed with SmartMonitor Zero to the Multi-Controller allows you to perform the following.

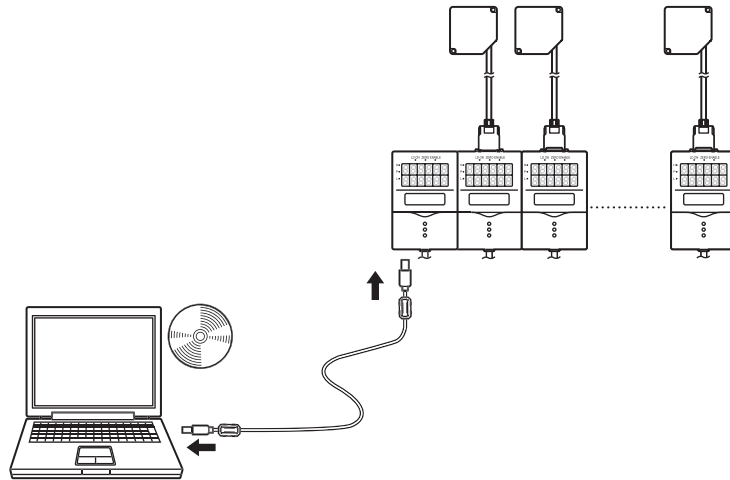

● **Gang-mounted Sensor Controllers can be set up.**

The measurement conditions of each Sensor Controller can be set up, and settings saved, read or copied.

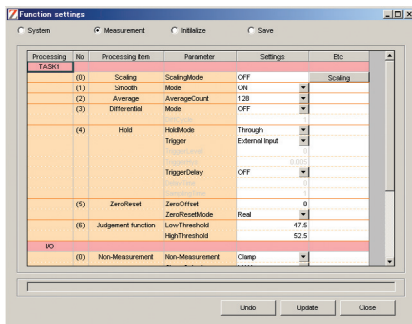

* The screen shown here may differ from the actual screen.

● **The state of gang-mounted Sensor Controllers can be monitored.**

The operating state of each Sensor Controller can be batch-monitored. The waveforms of each Sensor Controller can be displayed simultaneously.

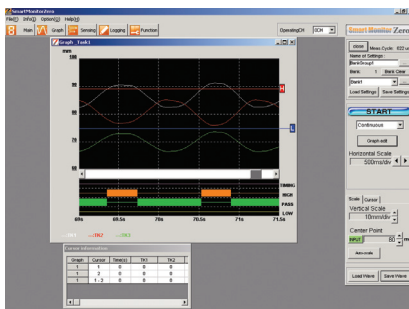

* The screen shown here may differ from the actual screen.

Basic Configuration

The figure below shows the Basic Configuration of the ZS Series.

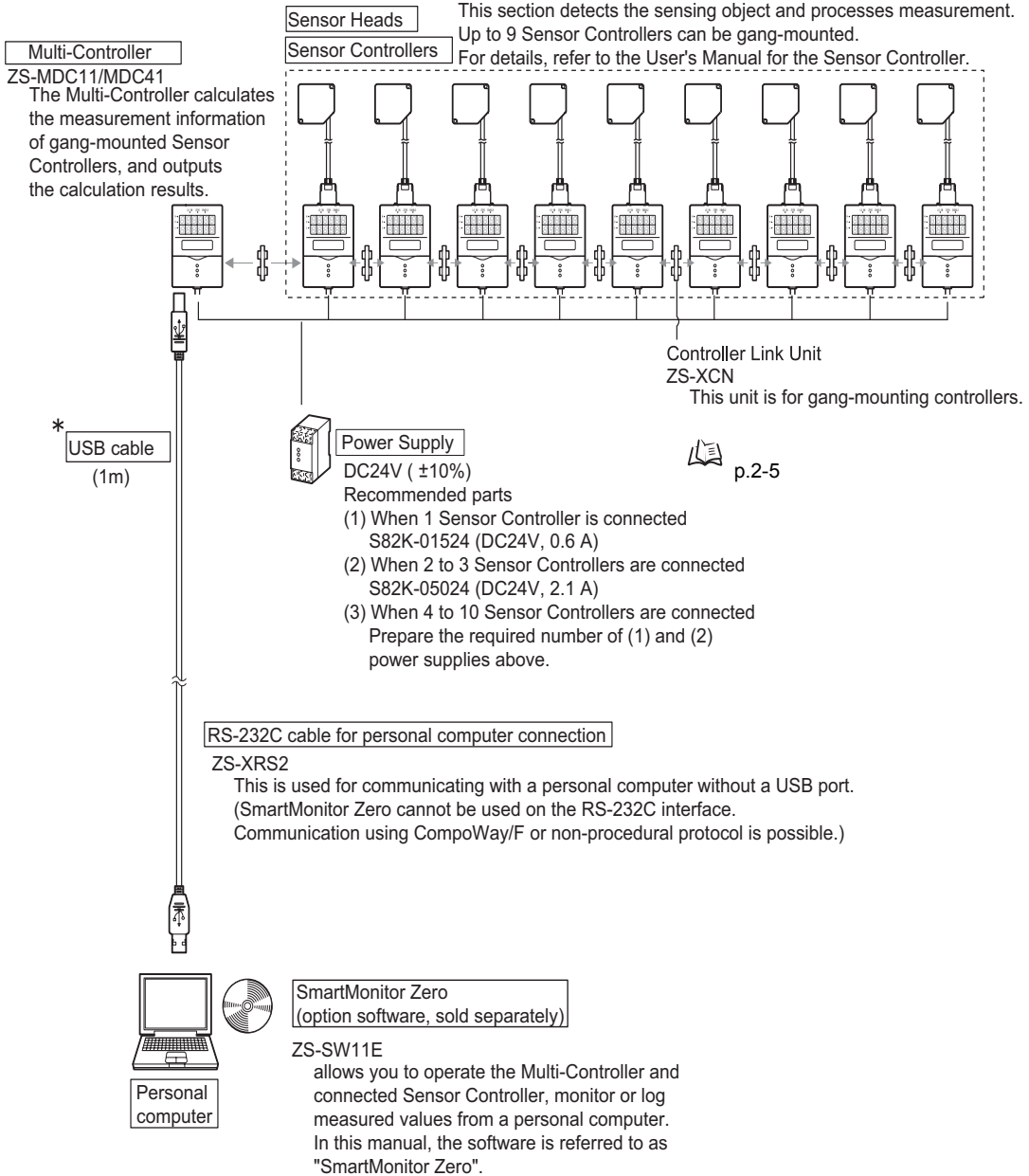

Part Names and Functions

The following describes the names and functions of parts on the Multi-Controller.

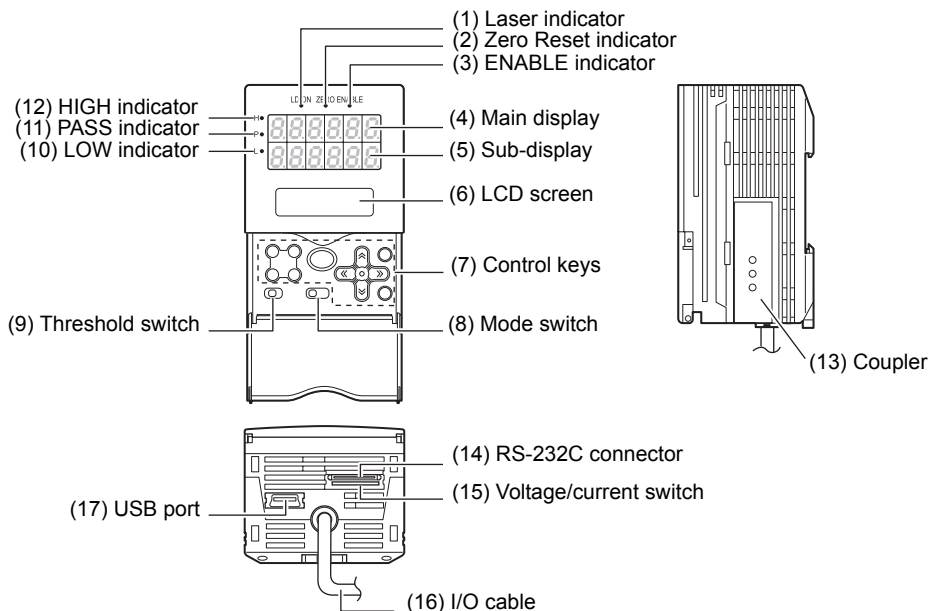

(1) Laser indicator

Does not lit.

(2) Zero Reset indicator

The Zero Reset indicator lits when the zero reset function is enabled on the Multi-Controller.

(3) ENABLE indicator

The ENABLE indicator lits when the Multi-Controller is ready for measurement. It goes off when measurement is not possible (e.g. when the light amount received by the sensor on the operation target CH is excessive or insufficient, when the measuring range is exceeded, when the Sensor Head is not connected, or when measurement is not being performed in the FUN mode).

(4) Main Display

The Main Display shows measured values after operations have been performed.

(5) Sub-display

The sub-display shows thresholds and additional information during measurement.

(6) LCD screen

RUN mode : Displays additional information for the main display and the setup menu for display related information.

TEACH mode : Displays the menu for setting up the thresholds.

FUN mode : Displays the measurement condition setup menu.

(7) Control keys

The Control Keys are for setting measurement conditions and other information. The functions assigned to the Control Keys change according to the operating mode.



Displays and Key Operations p.3-5

(8) Mode Switch

The Mode Switch selects the operating mode.

RUN mode : Select this mode when performing regular measurement.

TEACH mode : Select this mode when setting the judgment thresholds.

FUN mode : Select this mode when setting measurement conditions.

(9) Threshold Selector Switch

The Threshold Selector switch selects whether to set (or display) the HIGH or LOW threshold.

(10) LOW indicator

The LOW indicator lits when the condition “measured value < LOW threshold” is satisfied.

(11) PASS indicator

The PASS indicator lits when the condition “LOW threshold ≤ measured value ≤ HIGH threshold” is satisfied.

(12) HIGH indicator

The HIGH indicator lits when the condition “HIGH threshold < measured value” is satisfied.

(13) Coupler

This connector is for connecting the Multi-Controller to the Sensor Controller.

(14) RS-232C connector

Connect the RS-232 cable when you are connecting the Multi-Controller to a personal computer that does not have a USB port.

(15) Voltage/Current switch

The Voltage/Current switch selects between voltage output and current output.



CHECK!

Before operating this switch, make sure that the Multi-Controller is turned OFF. Also, make sure that the load connected to “linear output wire (co-axial) — linear GND wire” satisfies the rating of the set state (voltage or current output) before turning the Multi-Controller ON. Otherwise, the Multi-Controller may be damaged.



Rating of connected load (I/O Circuit Diagrams) p.2-12

(16) I/O Cable

The I/O cable connects the Sensor Controller to the power supply and external devices, such as timing sensors or programmable controllers.

(17) USB port

Connect the USB cable to the USB port to connect to a personal computer.

MEMO

Section 2

INSTALLATION & CONNECTION

☒ About Installation and Connection	2-2
☒ Multi-Controller	2-3
Attaching the ferrite core	2-3
Installing the Multi-Controller	2-4
☒ About the I/O cable	2-10

About Installation and Connection

■ Checking the installation environment

Read “Precautions for Safe Use” at the beginning of this manual, and check the installation environment.

■ Checking the installation site

Read “Precautions for Correct Use” at the beginning of this manual, and check the installation site.

■ About the power supply

Before installing and connecting the Multi-Controller, be sure to turn it OFF. Also read “Precautions for Safe Use” and “Precautions for Correct Use” at the beginning of this manual, and check the power supply and wiring.

Multi-Controller

This section describes installation of the Multi-Controller and connection of the I/O cable.



Before connecting/disconnecting peripheral devices, make sure that the Multi-Controller is turned OFF. The Multi-Controller may break down if the Multi-Controller is connected or disconnected while the power is ON.

Attaching the ferrite core

Attach the ferrite core (provided with the Multi-Controller) to the I/O cable of the Multi-Controller.

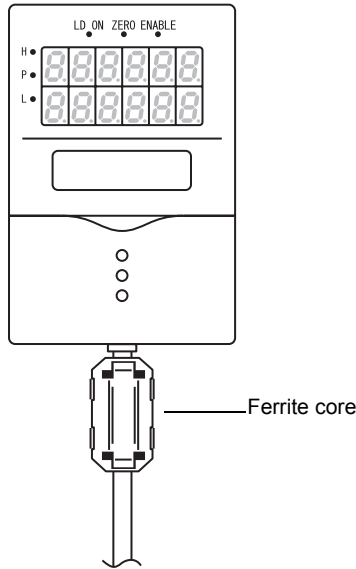

Installing the Multi-Controller

The Multi-Controller performs logical operations on the sensing information obtained from multiple connected Sensor Controllers. Up to 9 Sensor Controllers can be gang-mounted. For details on the Sensor Controller and Sensor Heads, refer to the User's Manual for the Sensor Controller.



Provide power to all connected Sensor Controllers.

CHECK!

■ About channel No. when controllers are gang-mounted

When performing operation from SmartMonitor Zero or an external device, select the controller to be set up by its channel No. The following shows how channel Nos. are assigned when Sensor Controllers are gang-mounted.

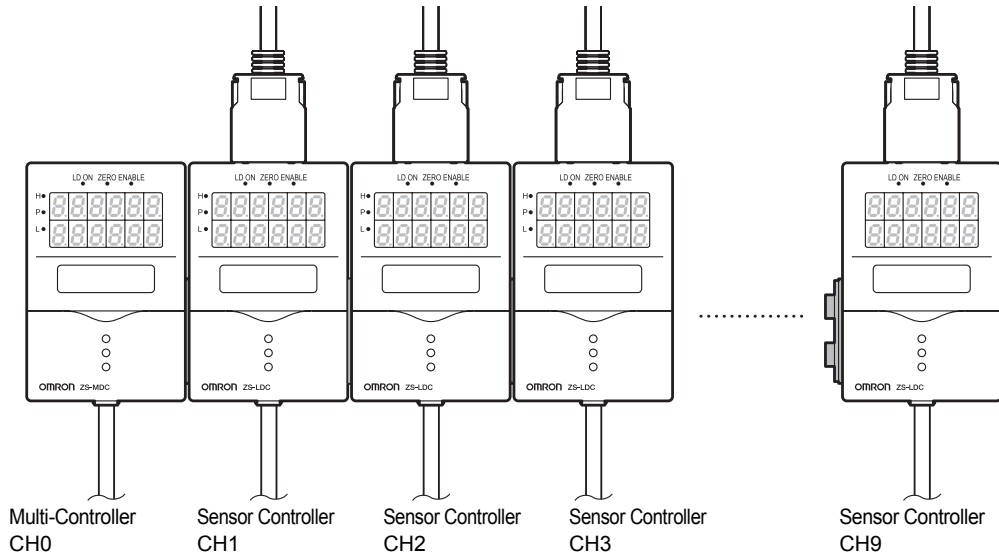

■ Installing on the DIN track

The following describes how to attach the 35 mm wide DIN track by quick, easy operation.

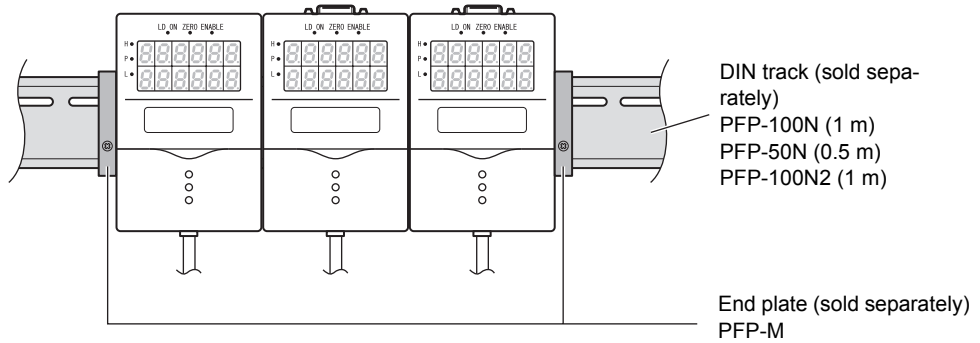

● Installation procedure

The following describes how to install the Multi-Controller and Sensor Controller on the DIN track.

- 1. Hook the connector end of the Sensor Controller onto the DIN track.**

- 2. Push the Multi-Controller down onto the DIN track until the hook on the I/O cable side is locked.**

Push down until you hear it snap into place.

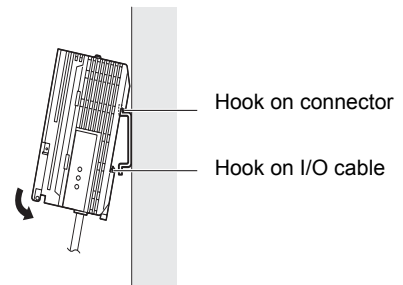

Always hook the connector end of the Multi-Controller on the DIN track first. Hooking the I/O cable end on the DIN track first may impair the mounting strength of the DIN track attachment.

3. Open the connector cover on the controller.

Slide the cover to remove.

4. Insert the Controller Link Unit into the connector on the Multi-Controller.



The connectors are designed to be connected in a particular direction. Insert the connector in the direction so that the indented section of the Controller Link Unit in the figure on the right matches the connector protrusion on the Data Storage Unit.

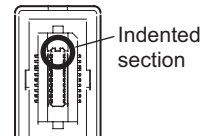
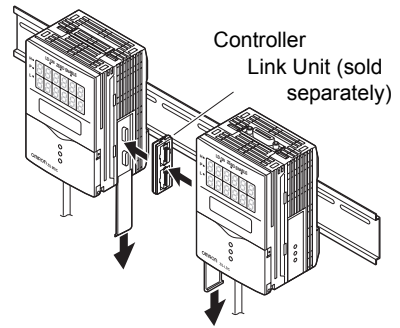

5. Slide the Sensor Controller to insert to the Controller Link Unit connector.

● **Removal procedure**

The following describes how to remove the Multi-Controller and Sensor Controller from the DIN track.

1. Slide and remove the Sensor Controller from the connector on the Controller Link Unit.

2. Slide the Controller Link Unit and remove from the connector on the Multi-Controller.

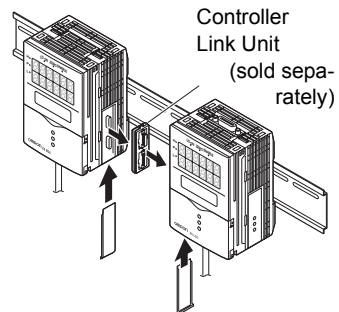

3. Install the cover on the coupler of the controller.

4. Pull the hook on the I/O cable end downwards.

5. Lift up the Sensor Controller from the I/O cable end, and remove it from the DIN track.

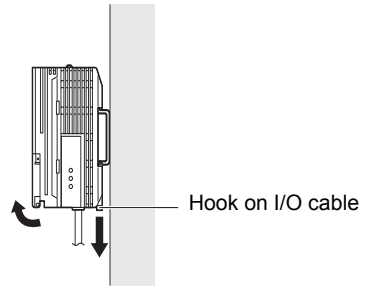

■ Mounting on a panel

The optional Panel Mount Adapters (ZS-XPM1/XPM2) can be used to mount the Multi-Controller on a panel.

 Panel Mount Adapters p.5-9

1. Install the Multi-Controller and Sensor Controller on the DIN track.

 p.2-5

 When mounting on a panel, be sure to install the DIN track on the rear side of the Multi-Controller for support.
CHECK!

2. Push out the Multi-Controller and Sensor Controller from the rear of the panel towards the front.

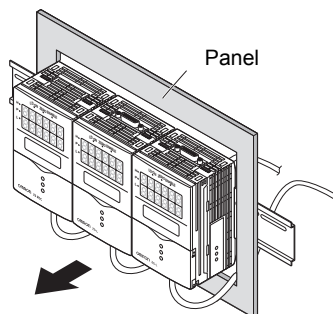

3. Install the small Mount Adapters on the four holes on the Multi-Controller and Sensor Controller.

 Install the small Mount Adapters on all gang-mounted Multi-Controllers and Sensor Controllers.
CHECK!

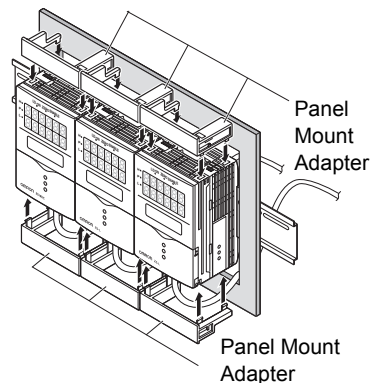

4. Install the long Mount Adapters on the two holes on the small Mount Adapter.



CHECK!

Install the long Mount Adapters only on both sides of gang-mounted controllers.

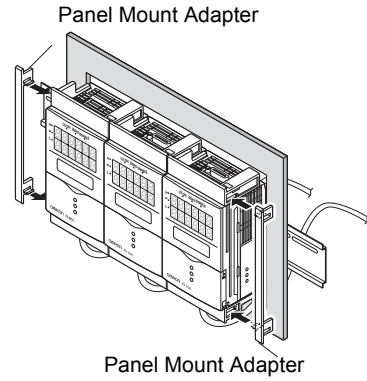

5. Install the Multi-Controller and Sensor Controller with Panel Mount Adapters attached onto the panel from the front.



CHECK!

Take care not to pinch the I/O cable.

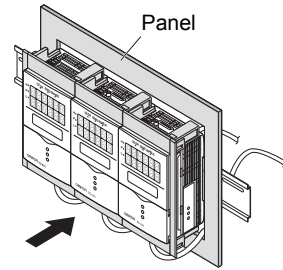

6. Hook the hooks of the mounting fixture onto the two holes of the small Mount Adapters and tighten the screws.



CHECK!

Attach two mounting fixtures each on all gang-mounted Multi-Controllers and Sensor Controllers.

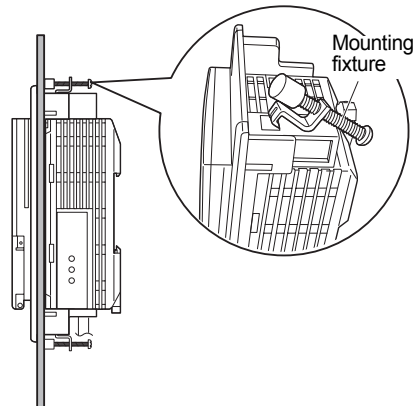

7. Make sure that the Multi-Controller and Sensor Controllers are firmly fixed on the panel.

About the I/O cable

■ Wiring the I/O cable

The following shows the leads that comprise the I/O cable.

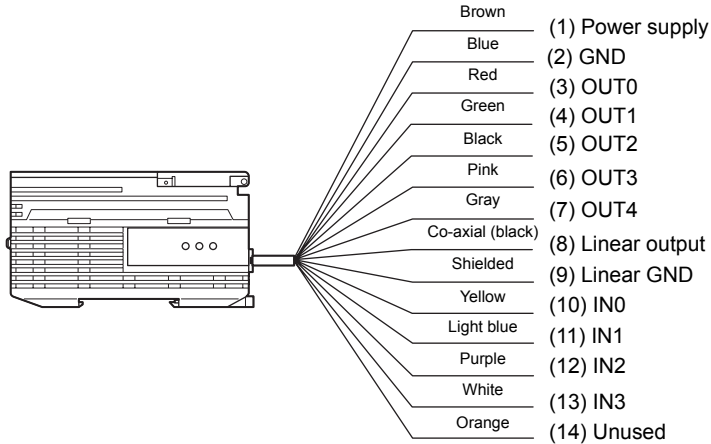

(1) Power supply

This connects the 24 VDC ($\pm 10\%$) power supply. When using a Multi-Controller with a PNP output, the power supply terminal is also the common I/O terminal for all I/O except for the linear output. Supply power from a DC power supply unit that has a countermeasure (safety ultra-low voltage circuit) built-in for preventing high voltages from occurring.

 Recommended power supply unit p.1-7

Wire the power supply separately from other devices. Wiring them together or placing them in the same duct may cause induction, resulting in malfunction or damage.



Supply power simultaneously to all gang-mounted controllers to be used.
When power is turned ON individually, the channels will not be recognized normally.

(2) GND

The GND terminal is the 0V power supply terminal. When using a Multi-Controller with an NPN output, the GND terminal is also the common I/O terminal for all I/O except for the linear output.

(3) OUT0 (HIGH output)

This outputs judgment results (HIGH).

(4) OUT1 (PASS output)

This outputs judgment results (PASS).

(5) OUT2 (LOW output)

This outputs judgment results (LOW).

(6) OUT3 (ENABLE output)

This turns ON when the Multi-Controller is ready for measurement. This output is interlocked with the ENABLE indicator.

(7) OUT4 (BUSY output)

This turns ON during sampling with the hold function enabled. It allows you to check whether or not the self-trigger is functioning correctly. It also turns ON during bank switching.

(8) Linear output

The linear output outputs a current or voltage in accordance with the measured value.

(9) Linear GND

The linear GND terminal is the 0V terminal for the linear output.



This ground wire must be grounded separately from the other ground wires. Always ground the linear output terminal even when linear output is not used.

(10) to (13) IN0 to IN3

The following input signal assignments can be selected.

- Signal assignments

Signal	When [Standard] is selected (default)	When [Bank] is selected
IN0	External trigger (timing) input	Bank input A
IN1	Reset input	Bank input B
IN2	Unused	Unused
IN3	Zero reset input	Zero reset input

Setting I/O Assignments p.3-16

- Signal functions

Signal Name	Description
External trigger (timing) input	This timing input is for signal input from external devices. Use it for hold function timing.
Reset input	This resets all executing measurements and outputs. While a reset is being input, judgment output conforms to the non-measurement setting. If this reset input switches ON while the hold function is used, the state in effect before the hold function was set will be restored.
Zero reset input	This is used to execute and clear a zero reset.
Bank input A, B	This is used for switching banks. Specify the bank No. in combinations of A and B.



For details on the timing charts of external I/O, refer to User's Manual for the Sensor Controller.

I/O Circuit Diagrams

NPN type (ZS-MDC11)

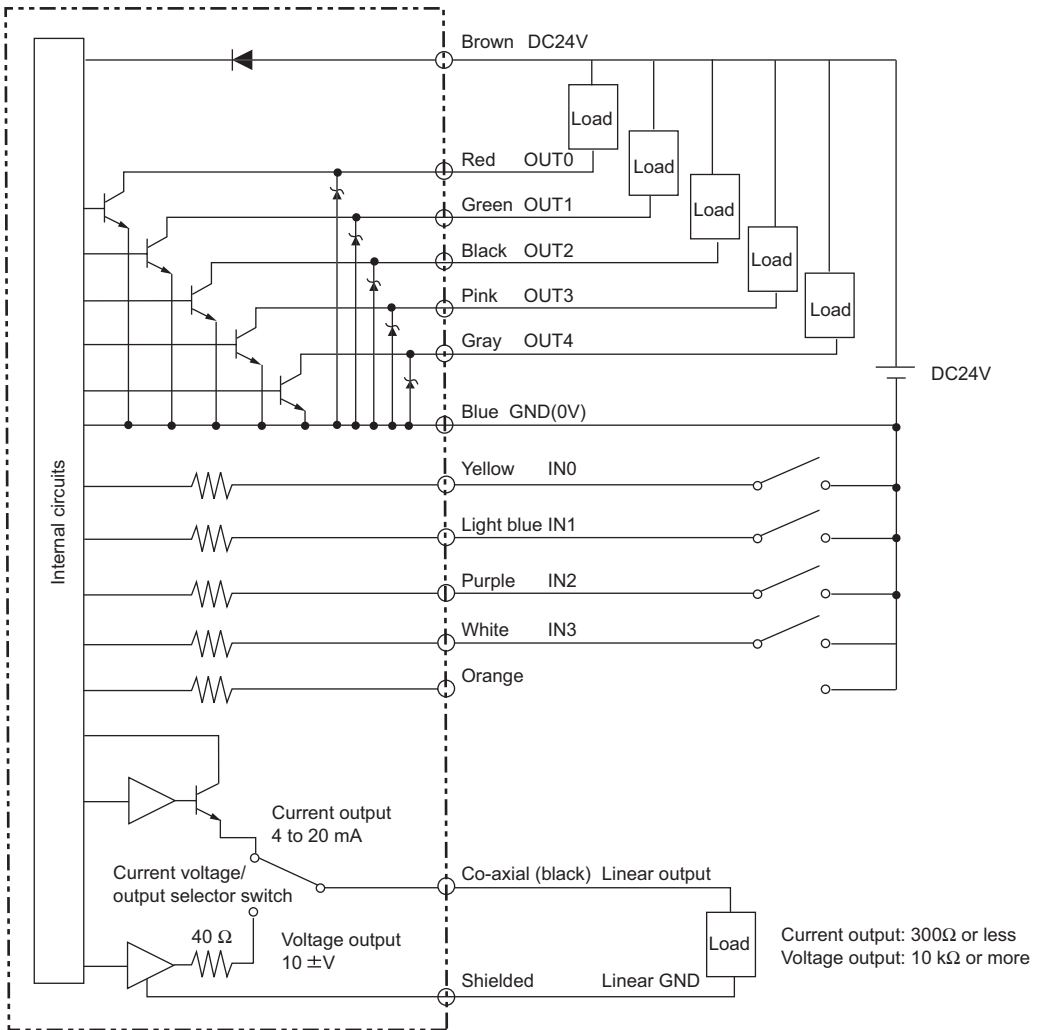

● PNP type (ZS-MDC41)

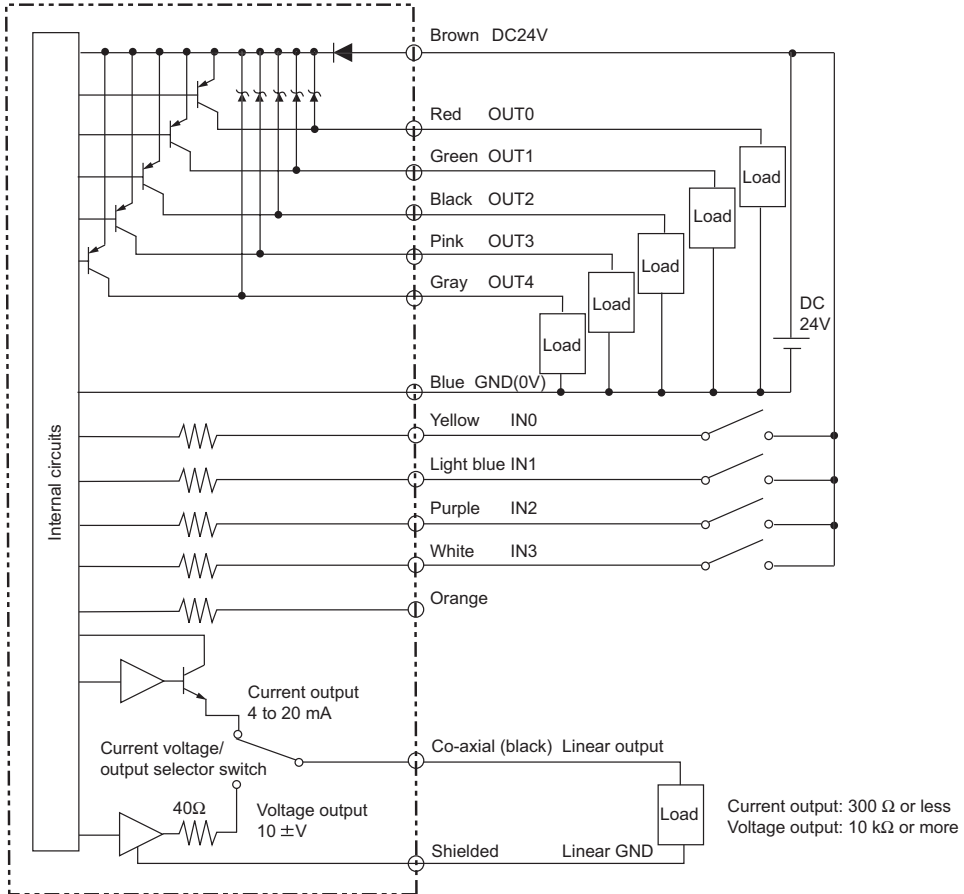

MEMO

Section 3

SETUP

☒	Setting Flow	3-2
☒	About Setup	3-4
	Basic Knowledge for Operation	3-4
	List of Setting Items	3-9
☒	Selecting Tasks	3-13
☒	Setting the Sensor Controller to Obtain Sensing Information from	3-14
	Setting Assignments	3-14
	Setting Logic Operation Methods	3-15
☒	Setting I/O Assignments	3-16
	Switching banks by external signal input	3-16
	Changing Output Assignments	3-17
	Changing Linear Output Assignments	3-17
	About Digital Output	3-17

Setting Flow

Preparation for Measurement

Installation and Connection

Gang-mount Sensor Controller to Multi-controller.



Section 2
Installation & Connection p.2-2

Power ON

Setting of Measurement Conditions

Setting the Sensor Controller to obtain sensing information from

Set the Sensor Controller to obtain sensing information from and operations to be performed.



p.3-14

Setting Filter Function

Set the filter conditions for processing measured information.



Sensor Controller User's Manual,
Section 3 Setup

Setting output processing

Set how measured information is to be processed for outputting the required values.



p.3-16
• Sensor Controller User's Manual,
Section 3 Setup

Setting the Threshold

Set the threshold value for judging measured values.



Sensor Controller User's Manual,
Section 3 Setup

Output Results

External I/O

Set how measured values are to be output.



Sensor Controller User's Manual,
Section 3 Setup

Save Setup

Save Setup Data

Save the data you have set.



Sensor Controller
User's Manual,
Section 3 Setup



CHECK!

After you have made or changed settings, be sure to save the setup data. All settings will be deleted if you turn the power OFF without saving the data.

When a Problem Occurs...



The Multi-Controller does not operate correctly.

Troubleshooting p.5-2



An error message has appeared

When [Error] is Displayed on the Main Display p.5-3



Want to know the meanings of terms

Glossary p.5-5

Applied Use of Functions

Setting Banks

Set up the banks.



Sensor Controller User's Manual,
Section 3 Setup

Set Up the System Environment

Set up the system environment.



Sensor Controller User's Manual,
Section 3 Setup

Additional Functions

Setting the Display Method

Set what is to be displayed on the Multi-Controller during measurement in the RUN mode.



Sensor Controller User's Manual,
Section 3 Setup

About Setup

The ZS-MDC Series can be set up on the Multi-Controller or on the SmartMonitor Zero software utility.

This manual describes setup on the Multi-Controller.

For details on how to set up the ZS-L Series on SmartMonitor Zero, refer to Help contained on the SmartMonitor Zero CD-ROM.

Basic Knowledge for Operation

The following describes basic operation of the Multi-Controller before you set up the ZS-L Series.

Switching Modes

The ZS-MDC has the following 3 operating modes. Switch to the desired mode before you start operation.

To switch the operating mode, use the Mode Switch.

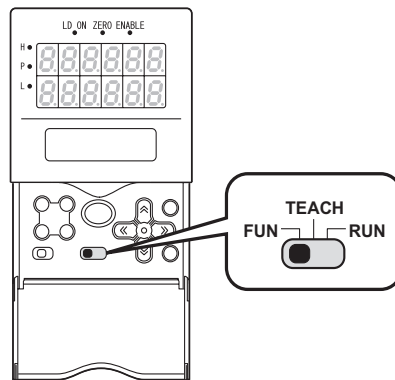

Mode	Description
FUN Mode	Mode for setting the measurement conditions
RUN mode	Normal operating mode
TEACH Mode	This mode is for setting the judgment threshold values.



When you switch the operating mode after changing the measurement conditions, you will be prompted to save the settings. Save the settings as required. If you turn off the Multi-Controller without saving these settings, the newly set measurement conditions will be cleared from memory. You can also save all the settings later on.



Sensor Controller User's Manual, Section 3 Setup

■ Displays and Key Operations

The Multi-Controller has digital displays and an LCD screen. The details displayed on these differ according to the operating mode.

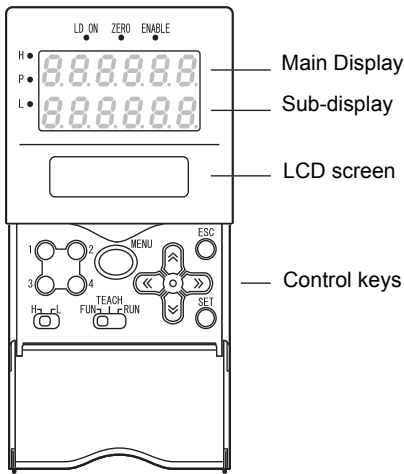

Alphabet characters that appear on the digital displays

A	B	C	D	E	F	G	H	I
R	b	c	d	E	F	G	h	i
J	K	L	M	N	O	P	Q	R
J	P	L	ñ	n	o	P	q	r
S	T	U	V	W	X	Y	Z	
S	t	U	v	Y	ü	y	z	

(1) FUN Mode

The LCD screen displays the setup menus.

The No. at the top of each menu corresponds to a function key.



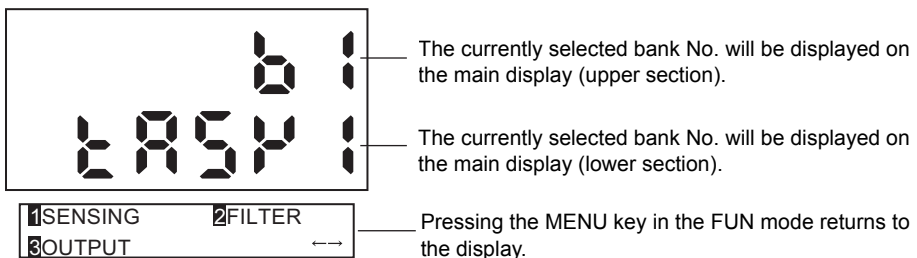

“←→” displayed at the top right of the LCD screen indicates that the setup menu is made up of two or more pages. Scroll pages by the LEFT or RIGHT key.

Top menu in FUN mode



Key Operations

Key	FUN Mode
Function keys 1 2 3 4	Directly sets the No. preceding the items displayed on the LCD screen.
←LEFT key →RIGHT key	The function changes depending on the settings. <ul style="list-style-type: none"> • Scrolls pages in list menus. • Selects the digit of numerical values.

Key		FUN Mode
↑ UP key ↓ DOWN key	 	Changes numerical values during numerical value input.
MENU key	MENU 	Displays the top menu of the FUN mode.
SET key	SET 	Applies the item you are setting up.
ESC key	ESC 	Returns to the previous menu.

The following example describes basic operations for changing the filter to [SMOOTH].

- 1. Press function key 2 representing [FILTER].**

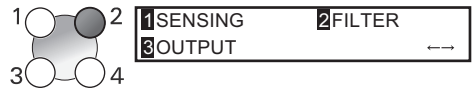

- 2. Press function key 1 representing [SMOOTH].**

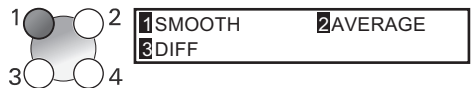

The currently selected No. is displayed flashing.

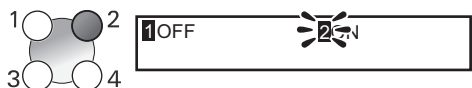

- 3. Press function key 2 representing [ON].**

The "Complete!" message is displayed.

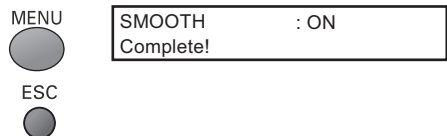

- 4. Press the MENU key to return to the top menu.**

Pressing the ESC key returns to the previous menu.

● **RUN Mode**

In this mode, measured values are displayed on the main display, and threshold values and other information are displayed on the sub-display.

Pressing the MENU key displays the display customize menu.

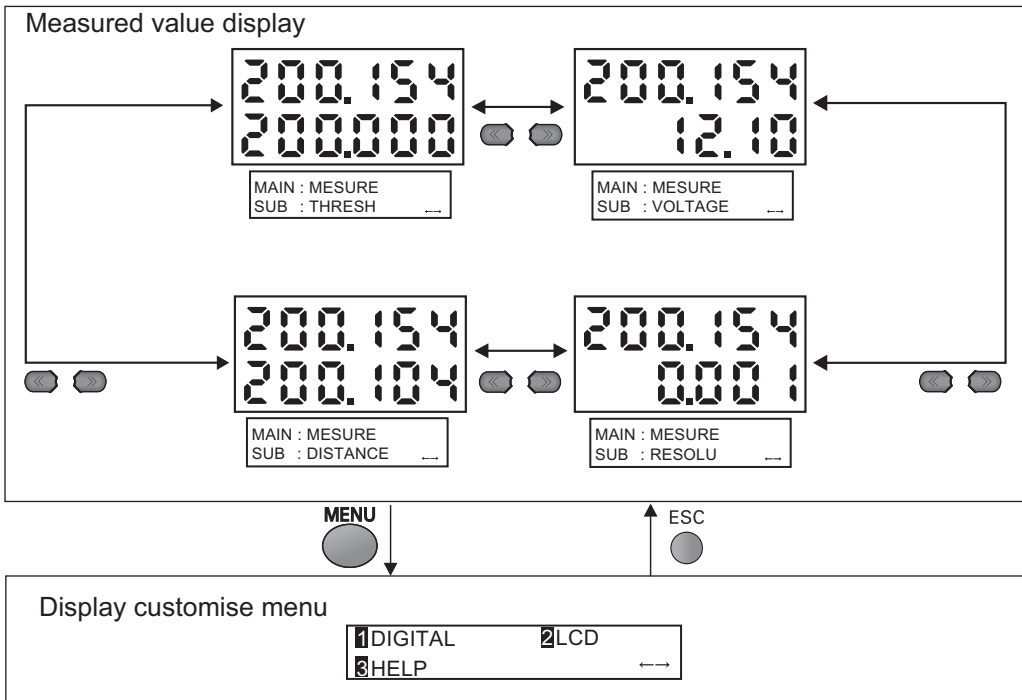





Details displayed on the sub-display

Display Details	Description
THRESH	Displays the HIGH/LOW threshold values according to the setting of the threshold switch.
VOLTAGE (CURRENT)	Displays the voltage (current) to be linearized. The display details change according to the setting of the current/voltage switch. (Values displayed here are reference values only. These values differ from actual linear output values.)
RESOLU	Displays the fluctuation width (peak to peak) of the measured value over a fixed amount of time.
DISTANCE	Displays the measured value before it is processed by hold or other functions.

Key Operations

Key	Measured Value Display	Display Customise Menu
Function keys 	Not used	Directly select functions.
←LEFT key →RIGHT key 	Changes sub-display content.	The function changes depending on the settings. • Scrolls pages in list menus. • Selects digits.







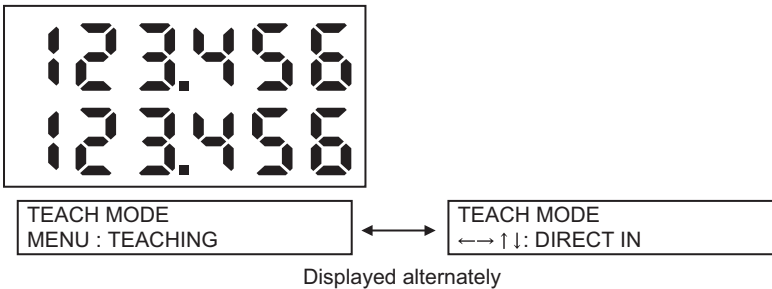

Key		Measured Value Display	Display Customize Menu
↑ UP key ↓DOWN key	 	↑ UP key: Executes trigger input. ↓DOWN key: Executes reset input.	The function changes depending on the settings. • Changes numerical values. • Changes text.
MENU key	MENU 	Displays the display customize menu.	Returns to the top of the display customize menu.
SET key	SET 	Executes a zero reset.	Applies numerical value settings.
ESC key	ESC 	Hold down for at least two seconds to cancel a zero reset.	Returns to the previous menu. When the top menu is displayed, returns to the measured value display.

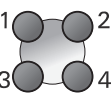
● **TEACH Mode**

In this mode, the measured value is displayed at all times on the main display. The threshold values are displayed on the sub-display. Which of the HIGH or LOW threshold values is displayed changes according to the setting of the threshold selector switch.



Key Operations

Key		TEACHING	DIRECT IN
Function keys		Not used	Not used
←LEFT key →RIGHT key	 	Not used	Selects the digit in the threshold numerical value.
↑ UP key ↓DOWN key	 	Not used	Changes the threshold numerical value.
MENU key	MENU 	Registers the measured value when this key is pressed as the threshold value.	Not used
SET key	SET 	Not used	Applies the newly set threshold value.
ESC key	ESC 	Not used	Cancels the newly set threshold value.

List of Setting Items



This manual describes only “FUN Mode-[SENSING]” functions unique to the Multi-Controller. Details of other functions are the same as those for the Sensor Controller. Refer to the Sensor Controller User's Manual.

■ FUN Mode

This is the mode for setting the measurement conditions. The items that can be set differ according to which task is selected. When TASK1 is selected, all items including items common to all tasks can be set. When a task other than TASK1 is selected, only items specific to that task can be set.

● When TASK1 is selected

FUN Mode		Settings	Default Value	Option/Range	Pages
SENSING		SEL CH	-	Input A to input I	p.3-14
		CALC	CH	OFF, CH (input A to input I), CALC (THICK, STEP, K+mX+nY, AVE, MAX-MIN)	p.3-15
FILTER		SMOOTH	ON	OFF, ON	-
		AVERAGE	1	1, 2, 4, 8, 16, 32, 64, 128, 256, 512, 1024, 2048, 4096	-
		DIFF	OFF	OFF, ON	-
OUTPUT		SCALING	OFF	OFF, ON (AUTO, MAN)	-
	HOLD	TYPE	OFF	OFF, PEAK, BOTTOM, P-P, AVERAGE, SAMPLE	-
		TRIGGER	EXT	EXT, SELF-UP, SELF-DN	-
		DELAY	OFF	OFF, ON (T-DELAY, T-TIME)	-
	ORESET	TYPE	REAL	REAL, HOLD	-
		OFFSET	0	-999.99 to 999.999	-

	Settings	Default Value	Option/Range	Pages	
I/O SET	NO-MEAS	CLAMP	KEEP, CLAMP	-	
	JUDGE	HYS	20 μm	0 to 999.999	-
		TIMER	OFF	OFF, OFF DELAY (1 to 5000ms), ON DELAY (1 to 5000ms), ONE SHOT (1 to 5000ms)	-
	ANALOG	FOCUS	OFF	OFF, ON	-
		ADJUST	OFF	OFF, ON (-999 to 999)	-
	INPUT	IN0	ON	OFF, ON	-
		IN1	ON	OFF, ON	
		IN2	ON	OFF, ON	
		IN3	ON	OFF, ON	
	I/O SET	IN	TASK	TASK (TASK1 to 4, ALL TASK, NONE), FUNC (NORMAL, BANK)	p.3-16
		OUT	TASK1	TASK1 to TASK4, NONE	
		ANALOG	TASK1	TASK1 to TASK4, NONE	
		DIGITAL	-	LOG1 to 9(NONE, INPUT A to INPUT I, TASK1 to TASK4)	
BANK	CHANGE	BANK1	BANK1, BANK2, BANK3, BANK4	-	
	CLEAR	-	(Initializes bank settings.)	-	
SYSTEM	SAVE	-	(Saves Multi-Controller settings.)	-	
	INIT	-	(Initializes Multi-Controller settings.)	-	
	INFO	CYCLE	-	(Displays the current measurement cycle.)	-
		VERSION	-	(Displays the Multi-Controller version.)	-
	COM (RS-232C)	LENGTH	8BIT	8BIT, 7BIT	-
		PARITY	NONE	NONE, ODD, EVEN	-
		STOP	1BIT	1BIT, 2BIT	-
		BAUDRAT	38400	9600, 19200, 38400, 57600, 115200	-
		DELIMIT	CR	CR, LF, CR+LF	-
	COM	MODE	COMPWAY	COMPWAY, NORMAL	-
		NODE	0	0 to 16	-
		KEYLOCK	OFF	OFF, ON	-
		ZERORST	OFF	OFF, ON	-
	LANGUAG	Japanese	Japanese, English	-	

● When other than TASK1 is selected

FUN Mode		Settings	Default Value	Option/Range	Pages
SENSING	CALC	CH	CH	OFF, CH(input A to input I), CALC (THICK, STEP, K+mX+nY, AVE, MAX-MIN)	p.3-15
		SMOOTH	ON	OFF, ON	-
		AVERAGE	1	1, 2, 4, 8, 16, 32, 64, 128, 256, 512, 1024, 2048, 4096	-
FILTER	DIFF	OFF	OFF	OFF, ON	-
		SCALING	OFF	OFF, ON (AUTO, MAN)	-
		HOLD	TYPE	OFF	OFF, PEAK, BOTTOM, P-P, AVERAGE, SAMPLE
TRIGGER	EXT		EXT, SELF-UP, SELF-DN	-	
DELAY	OFF		OFF, ON (T-DELAY, T-TIME)	-	
OUTPUT	ORESET	TYPE	REAL	REAL, HOLD	-
		OFFSET	0	-999.99 to 999.999	-
BANK	(same as when TASK1 is selected)				
SYSTEM	(same as when TASK1 is selected)				

■ RUN Mode

In the RUN mode, you can customize the details that are displayed in the digital displays.

To call the display customize menu, press the MENU key in the RUN mode.

RUN mode		Settings	Default Value	Option/Range	Pages
DIGITAL	DOT		3	0 to 5	-
	ECO		NORMAL	NORMAL, ECO, OFF	-
LCD	ON/OFF		ON	ON, AUTOOFF, OFF	-
	B.LIGHT		ON	ON, AUTOOFF, OFF	-
	CUSTOM		U-OFF D-OFF	U-ON/OFF, L-ON/OFF Upper section customize, lower section customize	-
	HELP		-	-	-

■ TEACH Mode

This is the mode for setting the threshold values

TEACH Mode		Settings	Default Value	Option/Range	Pages
	TEACHING		-	-	-
	DIRECT IN		-	-	

Selecting Tasks

By assigning expressions to “tasks,” you can process (multi-tasking) multiple logic operations (max. 4). After selecting the task in the task selection menu, make the various settings for the selected task in the respective setup menus. The currently selected task is displayed on the sub-display.

Press the ESC key with the FUN Mode-TOP menu displayed.

Setting	Description
TASK1	Selects TASK1 as the destination to store the expression to.
TASK2	Selects TASK2 as the destination to store the expression to.
TASK3	Selects TASK3 as the destination to store the expression to.
TASK4	Selects TASK4 as the destination to store the expression to.



CHECK!

- In the RUN and TEACH modes, the task to display can be selected. As function keys correspond to a stored task, press the function key of the task No. you want to display. (The currently selected task is displayed as “TKX” on the LCD display.)
 - The items that can be set in the FUN mode change according to the currently selected task. When TASK1 is selected, all items including items common to all tasks can be set. When a task other than TASK1 is selected, only items specific to that task can be set. Items common to all tasks are as follows:
 - SEL CH
 - NO-MEAS
 - JUDGE
 - ANALOG
 - IN
 - I/O SET
- BANK and SYSTEM can also be changed whichever task is selected.

Setting the Sensor Controller to Obtain Sensing Information from

Set which gang-mounted Sensor Controller to obtain information from, and which logic operations are to be performed on that information.

Setting Assignments

Assign the channel to perform logic operation on.

► FUNMode-[SENSING]-[SEL CH]

Setting	Description
INPUT A (input A)	Assigns the target Sensor Controller to input A. Range: None, 1CH onwards (largest CH of gang-mounted Sensor Controllers) (default: 1CH. Note that range becomes "None" if 1CH does not exist.)
INPUT B (input B)	Assigns the target Sensor Controller to input B. Range: None, 1CH onwards (largest CH of gang-mounted Sensor Controllers) (default: 2CH. Note that range becomes "None" if 2CH does not exist.)
INPUT C (input C)	Assigns the target Sensor Controller to input C. Range: None, 1CH onwards (largest CH of gang-mounted Sensor Controllers) (default: 3CH. Note that range becomes "None" if 3CH does not exist.)
INPUT D (input D)	Assigns the target Sensor Controller to input D. Range: None, 1CH onwards (largest CH of gang-mounted Sensor Controllers) (default: 4CH. Note that range becomes "None" if 4CH does not exist.)
INPUT E (input E)	Assigns the target Sensor Controller to input E. Range: None, 1CH onwards (largest CH of gang-mounted Sensor Controllers) (default: 5CH. Note that range becomes "None" if 5CH does not exist.)
INPUT F (input F)	Assigns the target Sensor Controller to input F. Range: None, 1CH onwards (largest CH of gang-mounted Sensor Controllers) (default: 6CH. Note that range becomes "None" if 6CH does not exist.)
INPUT G (input G)	Assigns the target Sensor Controller to input G. Range: None, 1CH onwards (largest CH of gang-mounted Sensor Controllers) (default: 7CH. Note that range becomes "None" if 7CH does not exist.)
INPUT H (input H)	Assigns the target Sensor Controller to input H. Range: None, 1CH onwards (largest CH of gang-mounted Sensor Controllers) (default: 8CH. Note that range becomes "None" if 8CH does not exist.)
INPUT I (input I)	Assigns the target Sensor Controller to input I. Range: None, 1CH onwards (largest CH of gang-mounted Sensor Controllers) (default: 9CH. Note that range becomes "None" if 9CH does not exist.)

Setting Logic Operation Methods

Set how logic operations are to be performed on the tasks and CH specified by the assignment settings.

► FUNMODE-[SENSING]-[CALC]

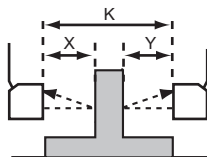
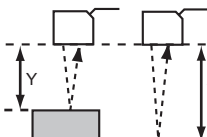
Setting		Description
OFF		Expressions are not set.
CH		Logic operations are not performed, and the measured value of a specific CH is input as it is. Select the target CH.
CALC	THICK K-(X+Y)	<p>Select this item to set the sandwiched thickness. (sandwiched measurement)</p> <ul style="list-style-type: none"> • Xrange: input A to input I, TASK1 to TASK4 • Yrange: input A to input I, TASK1 to TASK4 • The thickness input is automatically set. <p> During thickness input, the mode changes to the measurement mode, and the current thickness value is displayed on the main display. For this reason, during thickness input enter in a measurement ready state.</p> <p>CHECK!</p> 
	STEP X-Y	<p>Select this item to set step measurement. (step measurement)</p> <ul style="list-style-type: none"> • Xrange: input A to input I, TASK1 to TASK4 • Yrange: input A to input I, TASK1 to TASK4 
	K+mX+nY	<p>Select this to perform logic operations on X and Y with the coefficient freely set.</p> <ul style="list-style-type: none"> • K range: -999999 to 999999 • m range: -10.0 to 10.0 • n range: -10.0 to 10.0 • Xrange: input A to input I, TASK1 to TASK4 • Yrange: input A to input I, TASK1 to TASK4
	AVE (average height measurement)	<p>Select this item to average the values of input A to input I, and the values of TASK1 to TASK4.</p> <p>Set ON/OFF to each input and each TASK. The average of inputs set to ON and TASK is calculated.</p>
	MAX-MIN (flatness measurement)	<p>Select this item to subtract the maximum and minimum values by the values of input A to input I.</p> <p>Set ON/OFF to each input and each TASK. The average of inputs set to ON and TASK is calculated.</p>

 Inputs do not undergo logical operation when "None" is set. Example: The operation "-B" is performed when "None" is set to input A, "3CH" is assigned to input B and A-B is selected.

CHECK!

Setting I/O Assignments

Switching banks by external signal input

Set the task or function to the external input.



If you use SmartMonitor Zero, you can change the function assignments of IN2 and IN3 if [BANK] is selected. For details, refer to the Help for SmartMonitor Zero.

► FUN mode-[I/O SET]-[I/O SET]-[IN]

Setting		Description			
TASK		Select to task for enabling the external signal lead. Note, however, that reset input and bank inputs affects tasks at all times. Range: TASK1 to TASK4, TASK-ALL			
FUNC	NORMAL	Select this to use external input function as in standard applications so far (default value).			
		IN0	IN1	IN2	IN3
	External trigger (timing) input		Reset input	Unused	Zero reset input
	BANK	Select this to switch banks using external inputs.			
IN0		IN1	IN2	IN3	
Bank input A		Bank input B	Unused	Zero reset input	

For bank inputs A and B, the bank can be selected in the following combinations.

Bank to be Selected	Bank input A	Bank input B
BANK1	OFF	OFF
BANK2	OFF	ON
BANK3	ON	OFF
BANK4	ON	ON



- Bank switching is begun 0.5 seconds after the input state changes.
- At most it takes about 10 seconds to switch banks.
- During bank switching the BUSY output becomes ON.

Changing Output Assignments

► FUN mode-[I/O SET]-[I/O SET]-[OUT]

Setting	Description
TASK1 TASK2 TASK3 TASK4	The measurement value of the task selected here is output as the judgment result of the Multi-Controller.

Changing Linear Output Assignments

► FUN Mode-[I/O SET]-[I/O SET]-[ANALOG]

Setting	Description
TASK1 TASK2 TASK3 TASK4	The measurement value of the task selected here is linear-output from the Multi-Controller.

About Digital Output

► FUN Mode-[I/O SET]-[I/O SET]-[DIGITAL]-[LOG1 to 9]

Setting	Description
NONE Input A to input I TASK1 to TASK4	<p>Set this to batch-output multiple data to external devices using CompoWay/F or non-procedural commands.</p> <p>Assign to log 1 to 9 inputs A to I or TASK1 to 4 to be output. When a command is input, the inputs or tasks are output continuously in order from log 1 to 9. (The data of the nine channels can be batch-output when input A to I is set to log 1 to 9 with all inputs assigned.)</p> <p>For details on commands, refer to the "Communication Command Reference" (provided separately).</p> <p>When multi-channel waveforms are plotted or logging is performed on SmartMonitor Zero, the details set on SmartMonitor Zero are automatically reflected in this setting.</p>

MEMO

Section 4

APPLICATION SETTING EXAMPLES

☒ Measuring the Thickness of Multiple Points (sandwiched thickness)	4-2
☒ Measuring the Relative Difference between Steps	4-5
☒ Measuring the Reference Difference between Steps	4-8
☒ Measuring Flatness	4-10
☒ Measuring the Average Height	4-12
☒ Measuring the Twist of a Workpiece	4-14
☒ Measuring the Warp of a Workpiece	4-17

Measuring the Thickness of Multiple Points (sandwiched thickness)

This is an example of how to measure the sandwiched thickness at three places on a workpiece, and calculate the difference (max. value - min. value) of each measured thickness value. [THICK] and [MAX-MIN] are used as the operation modes.

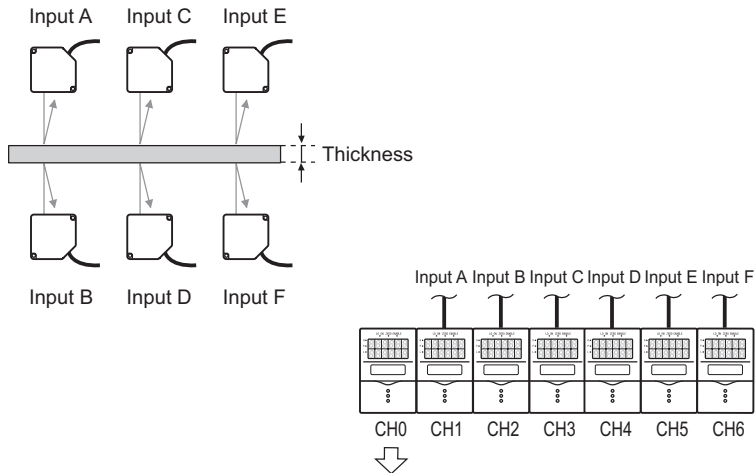

The operation and/or measurement results are output as judgement output or linear output.



For details on how to connect and install the Sensor Heads and Sensor Controllers, refer to the "ZS-L User's Manual".

CHECK!

► FUN Mode-[SENSING]-[SEL CH]

1. Assign the CH No. of the controller to inputs A to F to be used for the expression.



INPUT A:1CH
 INPUT B:2CH
 INPUT C:3CH
 INPUT D:4CH
 INPUT E:5CH
 INPUT F:6CH

▶ Press MENU key - ESC key.

2. Select [TASK1].



▶ [SENSING]-[CALC]-[CALC]-[THICK]

3. Set the expression of TASK1.



INPUT X: INPUT A

INPUT Y: INPUT B

4. Place a workpiece of known thickness at the rough sensor.

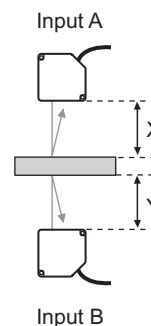

5. Select [THICK].



6. Enter the thickness of the workpiece.

The thickness of the workpiece you placed is displayed on the LCD. Enter the thickness value referring to the displayed value.

7. Press the SET Key to apply the setting.

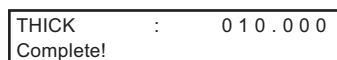

8. Following the same procedure as 2 to 7, set up TASK2 and TASK3.

(TASK2) Enter C to input X and D to input Y.

(TASK3) Enter E to input X and F to input Y.

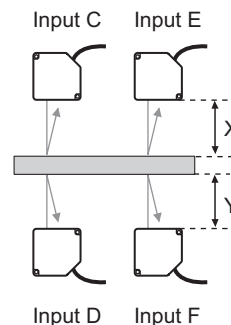

Section 4
Measuring the Thickness of Multiple Points (sandwiched thickness)

▶ Press MENU key - ESC key.

- 9.** To set the expression for calculating the difference in the thickness of the 3 locations for TASK4, select [TASK4].

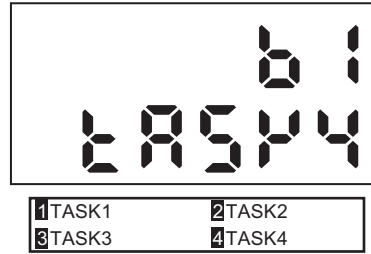

▶ [SENSING]-[CALC]-[CALC]-[MAX-MIN]

- 10.** Set task 1 to task3 for calculating the difference to ON, and other tasks to OFF.



- To output the judgment result of the operation
- ▶ [I/OSET]-[I/O SET]-[OUT]

- 11.** Select [TASK4] so that the judgment on the thickness difference can be output.



- To linear-output the operation result
- ▶ [I/O SET]-[I/O SET]-[ANALOG]

- 11.** Select [TASK4] so that the thickness difference can be linear-output.



The calculation results of each CH can be batch-acquired if you use the communication command.

Measuring the Relative Difference between Steps

This is an example of how to measure the height at three locations on a workpiece, and calculate the difference (step difference) between each of the measured values. Use [STEP] (X-Y) for the expression.

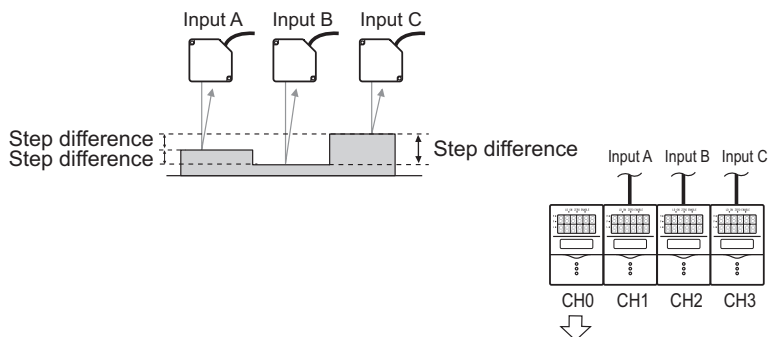

The operation and/or measurement results are output as judgement output or linear output.



For details on how to connect and install the Sensor Heads and Sensor Controllers, refer to the "ZS-L User's Manual."

► FUN Mode-[SENSING]-[SEL CH]

1. Assign the CH No. of the controller to inputs A to C to be used for the expression.



INPUT A:1CH
INPUT B:2CH
INPUT C:3CH

► Press MENU key - ESC key.

2. Select [TASK1].



Section 4
Measuring the Relative Difference between Steps

► [SENSING]-[CALC]-[CALC]-[STEP]

3. Set the expression of TASK1.

INPUT X: INPUT A
 INPUT Y: INPUT B

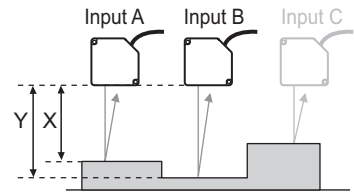

4. Following the same procedure as 2 to 3, set up TASK2.

INPUT X: INPUT B
 INPUT Y: INPUT C

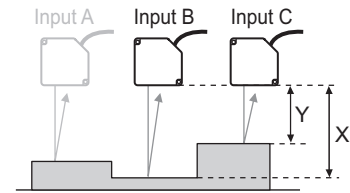

5. Following the same procedure as 2 to 3, set up TASK3.

INPUT X: INPUT C
 INPUT Y: INPUT A

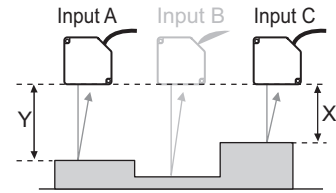

• To output the judgment result of the operation

► [I/O SET]-[I/O SET]-[OUT]

6. Select TASK1, TASK2, or TASK3 depending on the details to be output.



To output judgment on the difference between point A and point B: Set TASK1 to I/O SET

To output judgment on the difference between point B and point C: Set TASK2 to I/O SET

To output judgment on the difference between point C and point A: Set TASK3 to I/O SET

- To linear-output the operation result
▶ [I/O SET]-[I/O SET]-[ANALOG]

6. Select TASK1, TASK2, or TASK3 depending on the details to be output.

1 TASK1	2 TASK2
3 TASK3	4 TASK4

To output judgment on the difference between point A and point B: Set TASK1 to I/O SET

To output judgment on the difference between point B and point C: Set TASK2 to I/O SET

To output judgment on the difference between point C and point A: Set TASK3 to I/O SET



CHECK!

The calculation results of each CH can be batch-acquired if you use the communication command.

Measuring the Reference Difference between Steps

This is an example of how to measure the height at three locations on a workpiece, and calculate the difference (step difference) between the value of the reference height (obtained by taking one of the locations to be the reference height) and the other two locations. Use [STEP] (X-Y) for the expression.

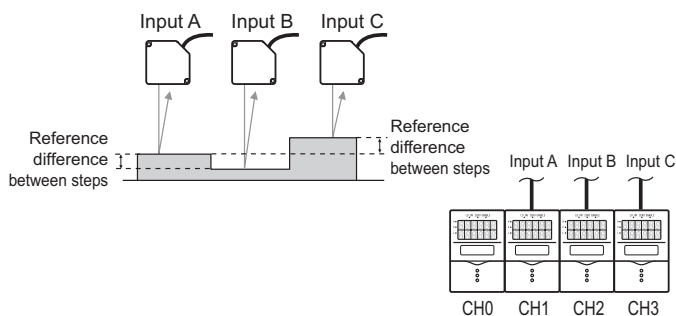

The operation and/or measurement results are output as judgement output or linear output.



For details on how to connect and install the Sensor Heads and Sensor Controllers, refer to the “ZS-L User’s Manual.”

▶ FUN Mode-[SENSING]-[SEL CH]

1. Assign the CH No. of the controller to inputs A to C to be used for the expression.



INPUT A:1CH
INPUT B:2CH
INPUT C:3CH

▶ Press MENU key - ESC key.

2. Select [TASK1].

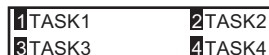

▶ [SENSING]-[CALC]-[CALC]-[STEP]

3. Set the expression of TASK1.

INPUT X: INPUT A
INPUT Y: INPUT B

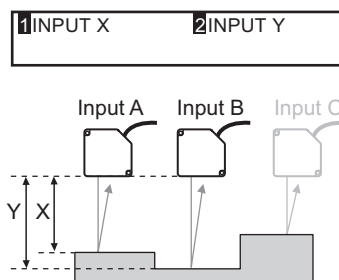

4. Following the same procedure as 2 to 3, set up TASK2.

INPUT X: INPUT A
INPUT Y: INPUT C

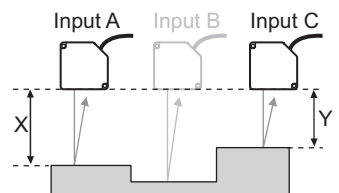

• To output the judgment result of the operation

▶ [I/O SET]-[I/O SET]-[OUT]

5. Select TASK1 or TASK2 depending on the details to be output.



To output judgment on the difference between point A (reference point) and point B: Set TASK1 to I/O SET

To output judgment on the difference between point A (reference point) and point C: Set TASK2 to I/O SET

• To linear-output the operation result

▶ [I/OSET]-[I/O SET]-[ANALOG]

5. Select TASK1 or TASK2 depending on the details to be output.



To output the difference between point A (reference point) and point B: Set TASK1 to I/O SET

To output the difference between point A (reference point) and point C: Set TASK2 to I/O SET



The calculation results of each CH can be batch-acquired if you use the communication command.

Measuring Flatness

This is an example of how to measure the height at 9 locations on a workpiece, and calculate the difference (max. value - min. value) between each measured point. [MAX-MIN] is used as the operation mode.

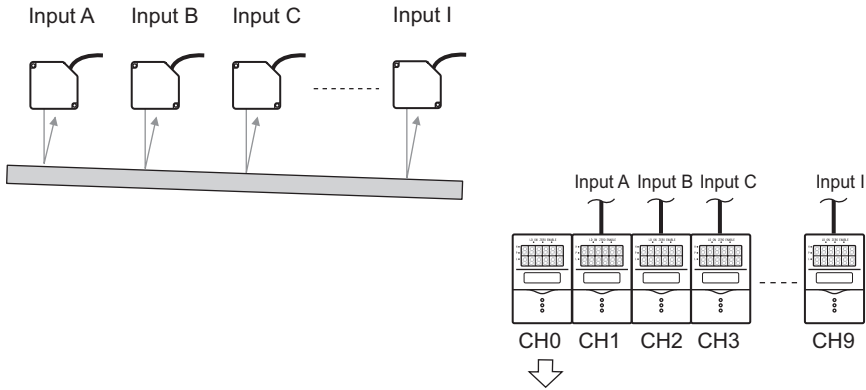

The operation and/or measurement results are output as judgement output or linear output.



For details on how to connect and install the Sensor Heads and Sensor Controllers, refer to the "ZS-L User's Manual".

► FUN Mode-[SENSING]-[SEL CH]

1. Assign the CH No. of the controller to inputs A to I to be used for the expression.

1 INPUT A	2 INPUT B
3 INPUT C	←→

INPUT A : 1CH
 INPUT B : 2CH
 INPUT C : 3CH
 INPUT D : 4CH
 INPUT E : 5CH
 INPUT F : 6CH
 INPUT G : 7CH
 INPUT H : 8CH
 INPUT I : 9CH

▶ Press MENU key - ESC key.

2. Select [TASK1].

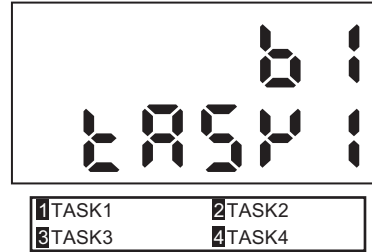

▶ [SENSING]-[CALC]-[CALC]-[MAX-MIN]

3. Set input A to input I for calculating the flatness to ON, and other input to OFF.



• To output the judgment result of the operation

▶ [I/O SET]-[I/O SET]-[OUT]

4. Select [TASK1] so that the judgment on the flatness measurement can be output.



• To linear-output the operation result

▶ [I/O SET]-[I/O SET]-[ANALOG]

4. Select [TASK1] so that the flatness measurement can be linear-output.

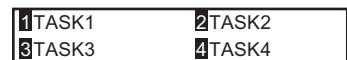

The calculation results of each CH can be batch-acquired if you use the communication command.

CHECK!

Measuring the Average Height

This is an example of how to measure the height at 3 locations on a workpiece, and calculate the average of each measured height value. [AVERAGE] is used as the operation mode.

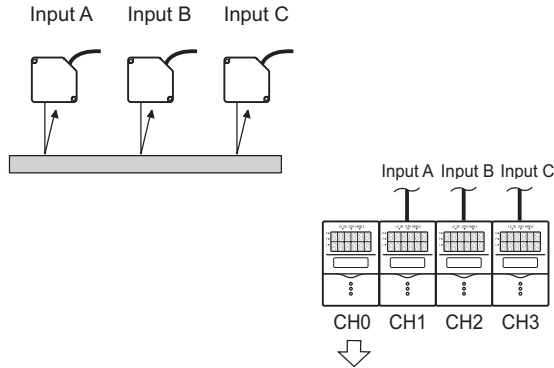

The operation and/or measurement results are output as judgement output or linear output.



For details on how to connect and install the Sensor Heads and Sensor Controllers, refer to the "ZS-L User's Manual".

► FUN Mode-[SENSING]-[SEL CH]

1. Assign the CH No. of the controller to inputs A to C to be used for the expression.



INPUT A:1CH
INPUT B:2CH
INPUT C:3CH

► Press MENU key - ESC key.

2. Select [TASK1].

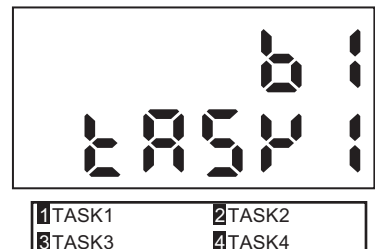

▶ [SENSING]-[CALC]-[CALC]-[AVE]

3. Set input A to input C for calculating the average to ON, and other inputs to OFF.

1 INPUT A	2 INPUT B
3 INPUT C	←→

• To output the judgment result of the operation

▶ [I/O SET]-[I/O SET]-[OUT]

4. Select [TASK1] so that the judgment on the average value can be output.

1 TASK1	2 TASK2
3 TASK3	4 TASK4

• To linear-output the operation result

▶ [I/O SET]-[I/O SET]-[ANALOG]

4. Select [TASK1] so that the average value can be linear-output.

1 TASK1	2 TASK2
3 TASK3	4 TASK4



CHECK!

The calculation results of each CH can be batch-acquired if you use the communication command.

Measuring the Twist of a Workpiece

This is an example of how to measure the height at 4 locations on a workpiece, and calculate the difference (twist) between each of the measured values. Use [X-Y] for the expression.

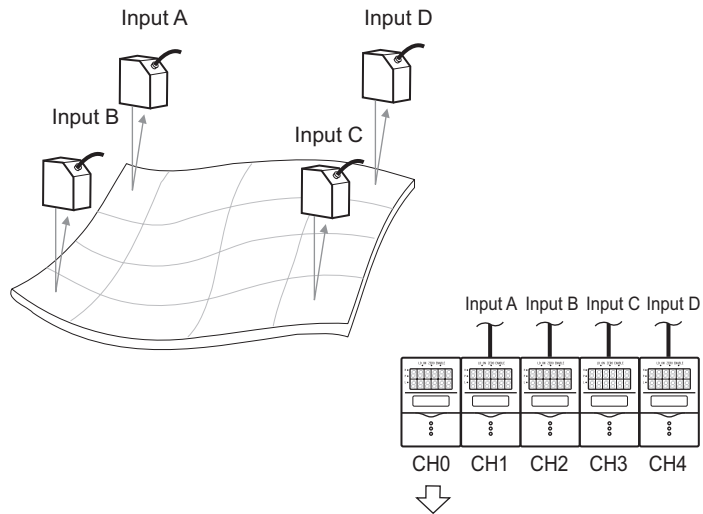

The operation and/or measurement results are output as judgement output or linear output.



For details on how to connect and install the Sensor Heads and Sensor Controllers, refer to the “ZS-L User’s Manual”.

► FUN Mode-[SENSING]-[SEL CH]

1. Assign the CH No. of the controller to inputs A to C to be used for the expression.

1 INPUT A	2 INPUT B
3 INPUT C	←←←←

INPUT A:1CH
INPUT B:2CH
INPUT C:3CH

▶ Press MENU key - ESC key.

2. Select [TASK1].

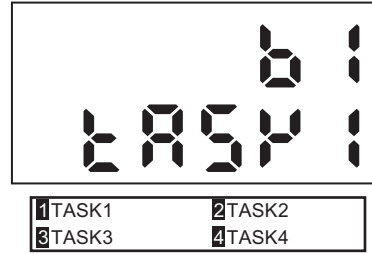

▶ [SENSING]-[CALC]-[CALC]-[STEP]

3. Set the expression of TASK1.



INPUT X: INPUT A
INPUT Y: INPUT B

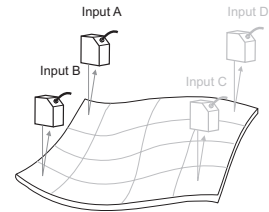

4. Following the same procedure as 2 to 3, set up TASK2.

INPUT X: INPUT D
INPUT Y: INPUT C

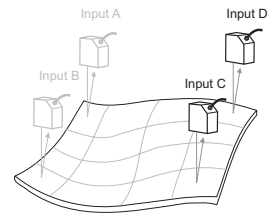

5. Following the same procedure as 2 to 3, set up TASK2.

INPUT X: TASK 1
INPUT Y: TASK 2

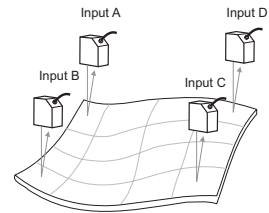

Section 4 Measuring the Twist of a Workpiece

- To output the judgment result of the operation
▶ [I/O SET]-[I/O SET]-[OUT]

6. Select [TASK3] so that the judgment on the twist can be output.

1 TASK1	2 TASK2
3 TASK3	4 TASK4

- To linear-output the operation result
▶ [I/O SET]-[I/O SET]-[ANALOG]

6. Select [TASK3] so that the twist value can be linear-output.

1 TASK1	2 TASK2
3 TASK3	4 TASK4



The calculation results of each CH can be batch-acquired if you use the communication command.

Measuring the Warp of a Workpiece

In the example below, the difference between the points on both edges (input A point and input C point) of the workpiece, the average distance value, and the measured value (input B point) of the center is taken to be the warp amount. Expression: $Z=B-(A+C)/2$. In the actual setting, calculation mode “K+mX+nY” is used.

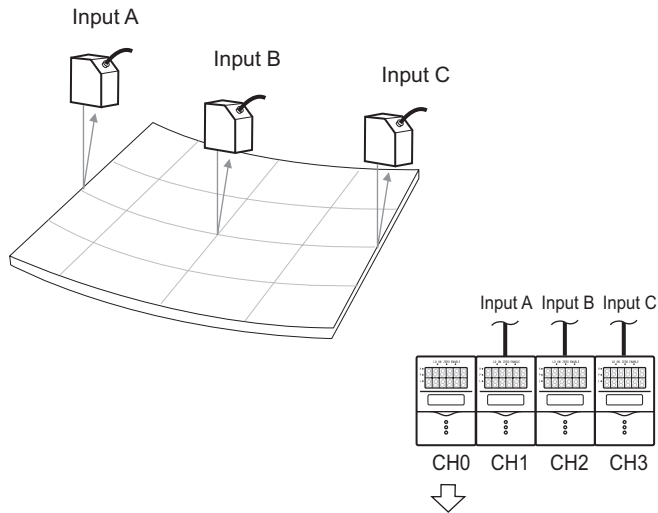

The operation and/or measurement results are output as judgement output or linear output.



For details on how to connect and install the Sensor Heads and Sensor Controllers, refer to the “ZS-L User’s Manual”.

CHECK!

► FUN Mode-[SENSING]-[SEL CH]

1. Assign the CH No. of the controller to inputs A to C to be used for the expression.

1 INPUT A	2 INPUT B
3 INPUT C	←←←

INPUT A:1CH
INPUT B:2CH
INPUT C:3CH

Section 4
Measuring the Warp of a Workpiece

▶ Press MENU key - ESC key.

2. Select [TASK1].

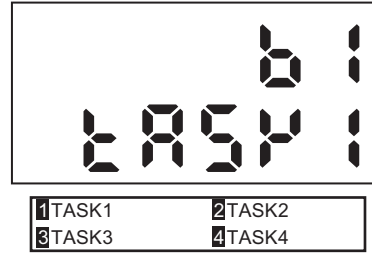

▶ [SENSING]-[CALC]-[CALC]-[K+mX+nY]

3. Set the expression of TASK1.

INPUT K:0
 INPUT m:1
 INPUT n:1
 INPUT X: INPUT A
 INPUT Y: INPUT C

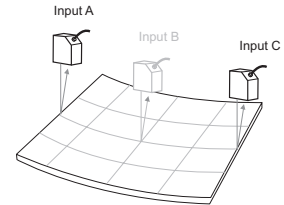
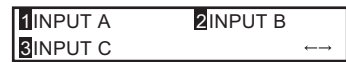

4. Following the same procedure as 2 to 3, set up TASK2.

INPUT K:0
 INPUT m:1
 INPUT n:-0.5
 INPUT X: INPUT B
 INPUT Y: TASK1

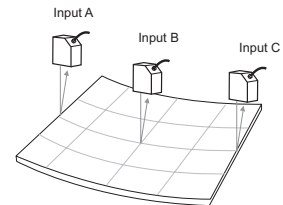

- To output the judgment result of the operation
▶ [I/O SET]-[I/O SET]-[OUT]

5. Select [TASK2] so that the judgment on the warp can be output.

1 TASK1	2 TASK2
3 TASK3	4 TASK4

- To linear-output the operation result
▶ [I/O SET]-[I/O SET]-[ANALOG]

5. Select [TASK2] so that the warp value can be linear-output.

1 TASK1	2 TASK2
3 TASK3	4 TASK4



The calculation results of each CH can be batch-acquired if you use the communication command.

MEMO

Section 5

APPENDIX

☒ Troubleshooting	5-2
☒ Error Messages and Countermeasures	5-3
☒ Q&A	5-4
☒ Glossary	5-5
☒ Specifications and External Dimensions	5-6
☒ Version Up Information	5-12
☒ Index	5-13
☒ Revision History	5-16

Troubleshooting

This section describes countermeasures for temporary hardware problems. Check the malfunction in this section before sending the hardware for repair.

Problem	Probable cause and possible countermeasure	Pages
Device restarts during operation.	<ul style="list-style-type: none"> • Is the power supply device connected correctly? 	p.2-10
Judgments are not output to external device.	<ul style="list-style-type: none"> • Are all cables connected correctly? • Is the signal line disconnected? • Are reset inputs short-circuited? 	p.2-10
No input signal received	<ul style="list-style-type: none"> • Are all cables connected correctly? • Is the signal line disconnected? 	p.2-10
No communications with personal computer	<ul style="list-style-type: none"> • Is the USB cable connected correctly? • Is the RS-232 cable connected correctly? 	—
Strange linear output levels	<ul style="list-style-type: none"> • Is the voltage/current switch on the bottom of the Sensor Controller set to the correct position? • Has the correct selection (voltage/current) been made in the focus settings? Linear output levels can be fine-tuned. 	p.1-8 —
The main display remains on [-----].	<ul style="list-style-type: none"> • Has a timing input been made while the hold function is enabled and the trigger type has been set to [EXT]? • If the hold function is enabled and the trigger type is [SELF-UP] or [SELF-DOWN], has the self-trigger level been set to an appropriate value? 	—
The measured values fluctuate and are not stable depending on day and time.	<ul style="list-style-type: none"> • This problem may be due to temperature characteristics. Execute zero reset periodically using the standard object to correct this problem. 	—

Error Messages and Countermeasures

■ When [Error] Is Displayed on the Main Display

Display Details		Cause	Countermeasure
LCD screen (upper section)	Overcurrent	One or all of the judgment outputs are short-circuited.	Cancel the load short-circuit. (Recovery is automatic after the load short-circuit is canceled.)
	Calculation data error	One (or all) of the channels assigned to the operation input cannot be measured.	Check the measurement state of the channels assigned to the operation input, and set all channels to a measurable state.

■ When all digits on the main display and sub-display blink

Display Details		Cause	Countermeasure
LCD screen	SYSTEM ERROR CONNECT	The controller is not connected.	Connect the Controller.
	SYSTEM ERROR BANK DATA	Bank data in the Sensor Controller in error	Hold the UP key down for 3 seconds, and then hold the DOWN key down for 3 seconds. The sensor is turned ON again and restored after the device is initialized.
	SYSTEM ERROR MAIN COM	Internal error	Turn the sensor ON again.



■ Others

Display Details		Cause	Countermeasure
LCD upper section	Disp range error	The measurement result exceeds the number of displayed digits.	Change the decimal point digit setting.
Main Display	-----	<ul style="list-style-type: none"> • The sensor is standing by for measurement. • No channels are assigned to inputs. (Assignments are set to "NONE".) 	<ul style="list-style-type: none"> • When hold is set, start sampling and apply the hold value. • Assign the channels.

Q&A

Question	Answer
When scaling is executed, an error appears and settings cannot be made.	Scaling cannot be set for one of the following reasons: <ul style="list-style-type: none">• Scaling has been attempted when the measured value is outside the measuring range.• When two-point scaling has been executed, the distance between the measured values for the two points is not 1% or more of the rated measuring range.
When focusing is executed, an error appears and settings cannot be made.	Monitor focus settings cannot be made when the distance between the two specified points is not 1% or more of the rated measuring range.

Glossary

Term	Explanation
Measured value	<p>The measured value is the operation result displayed on the main display of the Multi-Controller in the RUN and TEACH modes. It is the value when each of the currently set functions (e.g. hold) has been processed.</p> <p> p.3-7</p>
Present value	<p>The present value is the current measurement result for the target Multi-Controller. It is the value before each of the currently set functions (e.g. hold) has been processed. Press the LEFT or RIGHT Key in the RUN mode to display the present value on the sub-display.</p> <p> p.3-7</p>
Judgment output	<p>“Judgment output” is a general term for the HIGH, PASS, and LOW outputs. Judgment outputs are made in the RUN or TEACH mode based on the display values and the threshold, hysteresis width, and timer settings.</p>
SmartMonitor Zero	<p>This is software that runs on a personal computer. This software enables communication with ZS-MDC, sets the measurement conditions of the Multi-Controller and gang-mounted Sensor Controllers, saves setting data, and displays measurement results as a graph.</p>

Specifications and External Dimensions

Multi-Controller

ZS-MDC11/MDC41

(Unit: mm)

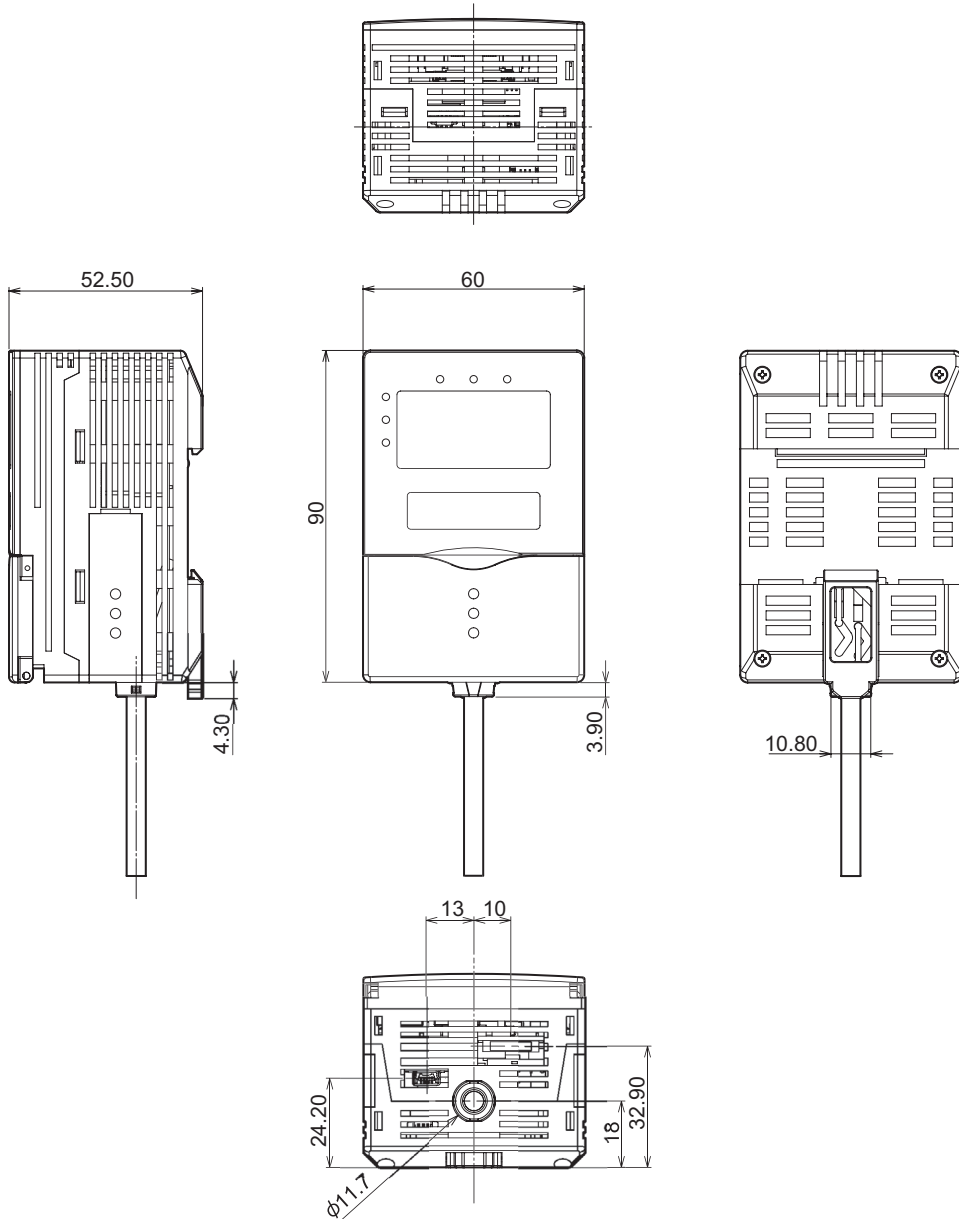

Item		ZS-MDC11	ZS-MDC41	
I/O type		NPNtype	PNPtype	
No. of samples to average		1, 2, 4, 8, 16, 32, 64, 128, 256, 512, 1024, 2048, or 4096		
Number of mounted Sensor Heads		Cannot be connected		
Connectable version of Sensor Controller		Ver2.0 or later		
Number of mounted Sensor Controllers		Max. 9 (The Controller Link Unit is needed for gang-mounting.)		
External I/F	Connection method		Serial I/O or connector Prewired (standard cable length: 2 m)	
	Serial I/O	USB2.0	1 port, FULL SPEED [12 Mbps], MINI-B	
		RS-232C	1 port, max. 115200 bps	
	Output	Judgment output 3 outputs: HIGH/ PASS/LOW	NPN open-collector, 30 VDC, 50 mA max. residual voltage; 1.2 V max.	PNPopen-collector 50 mA max. residual voltage;1.2V max.
		Linear output	Selectable from voltage/current (selected by slide switch on base) • At voltage output: -10 to +10 V, output impedance: 40 • At current output: 4 to 20 mA, max. load resistance: 300	
	Input	ZERO reset input ZERO reset execu- tion/cancel	ON: Short-circuited with 0V terminal or 1.5 V max. OFF: Open (leakage current: 0.1 mA max.)	ON: Supply voltage short-cir- cued or within supply volt- age -1.5 V OFF: Open (leakage current: 0.1 mA max.)
		Timing input Sample cycle speci- fied when hold func- tion is enabled		
RESET input Reset of hold state				
Status indicators		HIGH (orange), PASS (green), LOW (orange), LDON (green), ZERO (green), ENABLE (green)		
Segment display	Main display	8-segment red display, 6 digits		
	Sub-display	8-segment green display, 6 digits		
LCD		16 digits x 2 rows, color of characters: green, resolution per charac- ter: 5 x 8 pixel matrix		
Setting input	Setting keys		Direction keys (UP/DOWN/LEFT/RIGHT), SET key, ESC key, MENU key, function keys (1 to 4)	
	Slide switch	Threshold switch (H/L 2-state)		
		MODE switch (FUN/TEACH/RUN 3-state)		
Power supply voltage		21.6 V to 26.4 V (including ripple)		
Current consumption		0.5 A max.		
Insulation resistance		Across all lead wires and controller case: 20 M (by 250 V megger)		
Dialectic strength		Across all lead wires and controller case, 1000 VAC, 50/60 Hz, 1 min		
Noise immunity		1500 V peak-to-peak, pulse width 0.1 μs/1 μs, rising edge: 1 ns pulse		
Vibration resistance (destructive)		10 to 150 Hz, 0.7-mm double amplitude, 80 min each in X, Y, and Z directions		

Section 5 Specifications and External Dimensions

Item	ZS-MDC11	ZS-MDC41
Shock resistance (destructive)	300 m/s ² 3 times each in six directions (up/down, left/right, forward/backward)	
Ambient temperature	Operating: 0 to 50°C Storage: -15 to +60°C (with no icing or condensation)	
Ambient humidity	Operating and storage: 35% to 85% RH (with no condensation)	
Materials	Case: Polycarbonate (PC)	
Weight	Approx. 280 g (excluding packing materials and accessories)	

Panel Mount Adapters

ZS-XPM1/XPM2

When mounting on a panel

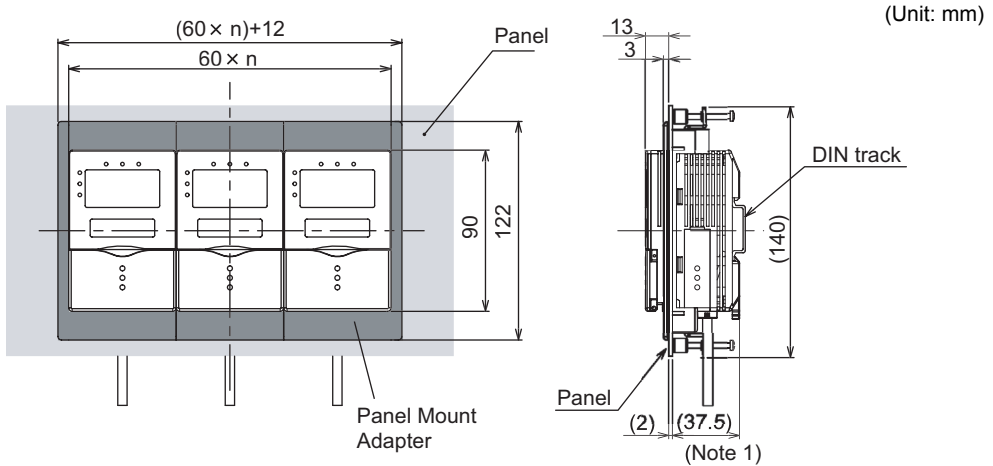

Note 1: Dimensions are shown for a panel thickness of 2.0 mm.

Panel cutout dimensions

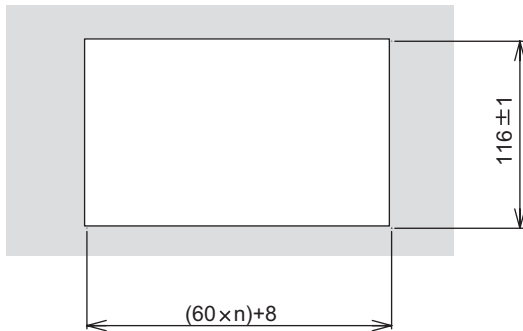

n: number of gang-mounted controllers (1 to 10)

Item	ZS-XPM1 (for 1st unit)	ZS-XPM2 (for 2nd unit onwards)
Appearance		
Applicable controller	ZS Series	
Vibration resistance	10 to 150 Hz, 0.7-mm double amplitude, 80 min each in X, Y, and Z directions	
Shock resistance	300 m/s ² 3 times each in six directions (up/down, left/right, forward/backward)	
Materials	Polycarbonate (PC), etc.	
Weight	Approx. 50g	

RS-232C Cable for Connecting to a Personal Computer

ZS-XRS2

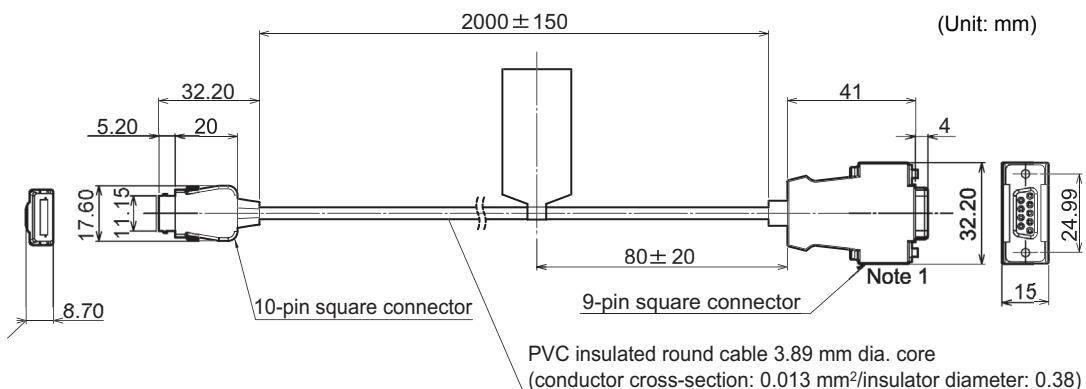

Note 1: Connector is socket type.

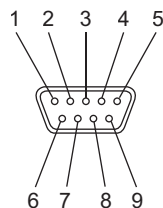
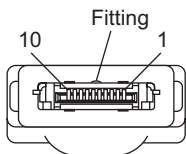

Signal Name	Pin No.
NC	1
SD(TXD)	2
RD(RXD)	3
RS(RTS)	4
CS(CTS)	5
NC	6
NC	7
NC	8
SG(GND)	9
NC	10

Pin No.	Signal Name
1	NC
2	RD(RXD)
3	SD(TXD)
4	NC
5	SG(GND)
6	NC
7	RS(RTS)
8	CS(CTS)
9	NC

Item	ZS-XRS2
Applicable controller	ZS Series
Ambient temperature	Operating: 0 to 50°C, Storage: -15 to +60°C (with no icing or condensation)
Ambient humidity	Operating and storage: 35% to 85% RH (with no condensation)
Dialectic strength	1,000 VAC, 50/60 Hz for 1 min
Insulation resistance	100 M (by 500 VDC megger)
Vibration resistance	10 to 150 Hz, 0.7 mm double amplitude, 80 min each in X, Y, and Z directions
Shock resistance	300 m/s ² 3 times each in six directions (up/down, left/right, forward/backward)
Materials	Cable sheath: PVC
Weight	Approx. 50 g

Controller Link Unit

ZS-XCN

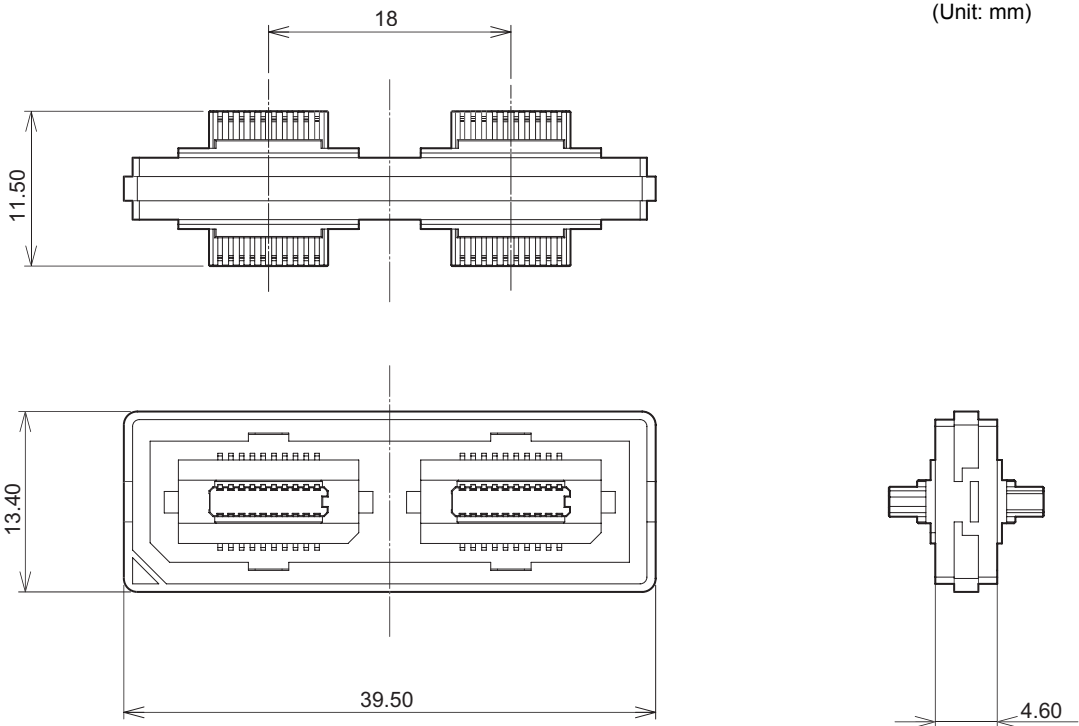

Item	ZS-XCN
Applicable controller	ZS Series
Ambient temperature	Operating: 0 to 50°C, Storage: -15 to +60°C (with no icing or condensation)
Ambient humidity	Operating and storage: 35% to 85% RH (with no condensation)
Vibration resistance	10 to 150 Hz, 0.7 mm double amplitude, 80 min each in X, Y, and Z directions
Shock resistance	300 m/s ² 3 times each in six directions (up/down, left/right, forward/backward)
Materials	Polycarbonate (PC), etc.
Weight	Approx. 10g

Version Up Information

This section describes the revisions made to the software.

■ Ver1.00 to Ver1.50

Description of Change	Pages
Task setup function was added.	p.3-13
Logic operation can be performed on the information of Sensor Controllers up to nine channels.	p.3-14
"K+mX+nY" that enables average height measurement and flexible formulas on types of logic operations were added.	p.3-15
The zero reset memory function was added.	*
The input signal setup function was added.	*
The I/O assignment function was added.	p.3-16

*Refer to the User's Manual for the Sensor Controller.

■ Ver1.50 to Ver2.00

Description of Change	Pages
RS-232C "delimiter", and "CompoWay/F", "Non-procedural" and "Node" were added to the communication specifications.	*
The Data Storage unit (ZS-DSU) was supported.	—
SmartMonitor Zero was supported.	—

*Refer to the User's Manual for the Sensor Controller.

Index

A			
ANALOG		3-17	
average height measurement			
CALC		3-15	
B			
Bank switching		3-16	
Basic Configuration		1-7	
BUSY output		2-11	
C			
CALC		3-15	
Control keys		3-5	
Controller Link Unit			
Connection		2-5	
Specifications and			
Dimensions		5-11	
Coupler		1-9	
D			
DIGITAL		3-17	
E			
ENABLE			
indicator		1-8	
Output		2-11	
Extension Cable		5-11	
F			
Ferrite core			
Multi-Controller		2-3	
flatness measurement			
CALC		3-15	
FUN Mode		3-5	
H			
HIGH			
indicator		1-9	
Output		2-10	
I			
I/O cable		2-10	
I/O circuit diagrams		2-13	
I/O SET		3-16, 3-17	
INPUT		3-14	
K			
K+mX+nY			
CALC		3-15	
L			
Laser indicator		1-8	
	LCD screen		
	name		3-5
	LD ON		1-8
	LOG		3-17
	LOW		
	indicator		1-9
	Output		2-10
M			
	Main Display		3-5
	Mode Switch		3-4
	Multi-Controller		
	Attaching the ferrite core		2-3
	Installation		2-4
	Part Names		1-8
	Specifications and		
	Dimensions		5-6
O			
	OUT		3-17
	OUT0 to 4		2-10
	Output cable		2-10
P			
	PASS		
	indicator		1-9
	Output		2-10
	Power supply		1-7
R			
	RS-232C		
	cable external		
	dimensions		5-10
	Connector		1-9
	RUN mode		3-7
S			
	SEL CH		3-14
	SENSING		3-14
	STEP		
	CALC		3-15
	Sub-display		3-5
T			
	TASK		3-13
	TEACH Mode		3-8
	THICK		
	CALC		3-15
	Threshold Selector Switch		1-9

U		
USB		
port		1-9
<hr/>		
V		
Voltage/Current switch		1-9
<hr/>		
W		
wiring		2-10
<hr/>		
Z		
Zero reset		
indicator		1-8

MEMO

Revision History

A manual revision code appears as a suffix to the catalog number at the bottom of the front and back covers of this manual.

Cat. No. Z209-E2-01

↑
Revision code

Revision code	Date	Revised contents
01	October 2004	Original production