

Pre-assembled and pre-cabled in different aperture to highlight the processes

LED Signal Towers

- Modular and monolithic design are available.
- Patlite's extensive product range cover highly advanced LED signal towers for industrial automation and security applications.
- Mechanical and electrical durability is a key feature of signal towers since machine operators rely on the signals they show. LED modules together with an impact and heat resistant ABS resin housing are the elements to give clear guidance of the operator for a long service life.
- Different aperture for different application (from 30 mm till 70 mm)
- This signal towers are designed for use in different environments till a protection up to IP 65. That makes them suitable for the widest possible range of applications in general industries.

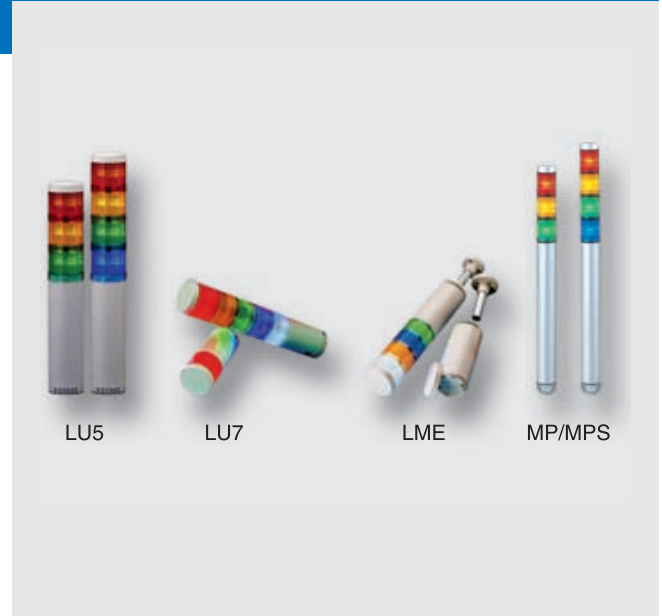

Features/Unique selling proposition

Modular system:

LU5 & LU7 series signal towers deliver the advantages of superior LED technology, innovative design, and the convenience of modular assembly with only 9 basic modular components to meet just about every indicating need.



LU5/LU7: Versatile modular Signal Tower featuring easy assembly and wiring designed for every need.

Monolithic system:

MP/MPS: Super slim 30 mm Signal tower ideal for small and mid-sized machines with a special pre-wired versatile 1 m connection cable.



LME: Versatile, cost and energy efficient LED Signal tower for every need and a special pre-wired versatile and flexible cable connection of 3 m.

LU5

Nomenclature/How to order

LED module

LU5-E-R
1 2

1. E: LED unit
2. Color of LED
 - R: Red
 - Y: Yellow
 - G: Green
 - B: Blue
 - C: Clear/White

Base module

LU5-02UFB
1 2 3

1. Rated voltage
 - 02: 24 VDC
2. Unit color
 - Blank: Ivory white
 - U: Silver color
3. Type
 - Blank: Continuous light
 - FB: Continuous or flashing light with audible alarm

Ordering Information

LED module

| Module Color | Power Consumption | Rated Voltage | Operation Voltage | Operation Temperature Range | Mass | Order Code |
|--------------|-------------------|---------------|-------------------------------------|-----------------------------|-----------|------------|
| Red | 52 mA/1.25 W | 24 VDC | Rated voltage ±10% (21.6~26.4 V) | -30°C~+60°C | 44 g ±10% | LU5-E-R |
| Yellow | | | | | | LU5-E-Y |
| Green | 42 mA/1.0 W | 24 VDC | Rated voltage ±10% (21.6~26.4 V) | -30°C~+60°C | 44 g ±10% | LU5-E-G |
| Blue | | | | | | LU5-E-B |
| Clear | | | | | | LU5-E-C |

Base module

| Typ | Alarm/ Flash | Power Consumption | Rated Voltage | Operation Voltage | Operation Temperature Range | Mass | Open Collector | Order Code |
|---------------|-----------------------|-------------------|---------------|---------------------------------------|-----------------------------|-----------|----------------|------------|
| Standard Body | Continuous | 1.2 W | 24 VDC | Rated voltage ±10% (21.6 ~ 26.4 V) | -30°C~+60°C | 182g ±10% | PNP/ NPN | LU5-02* |
| | 2 Sounds/ Flash-light | | | | | 200g ±10% | | LU5-02FB* |

* Ivory white: black, silver: add "U"

Optional parts

| Typ | Material | Order code |
|--------------------|-------------------------|------------|
| Wall Mount Bracket | Aluminum alloy die-cast | SZ-017 |
| | ABS resin | SZ-020 |
| Upper Bracket | Metal | SZ-60NPT |
| | | SZ-60U |
| Mount Bracket | Aluminum alloy die-cast | SZ-016A |
| | | SZ-70B |

| Typ | Height | Material | Order code |
|------|--------|-----------|-------------|
| Pole | 100 mm | Aluminium | Pole-100A21 |
| | 300 mm | Aluminium | Pole-300A21 |
| | 800 mm | Aluminium | Pole-800A21 |

Features



LED module is stackable and reconfigurable even after installation

IP 65: Implemented O rings seal out liquids so that the tower can be used in wet conditions.

Dimensions

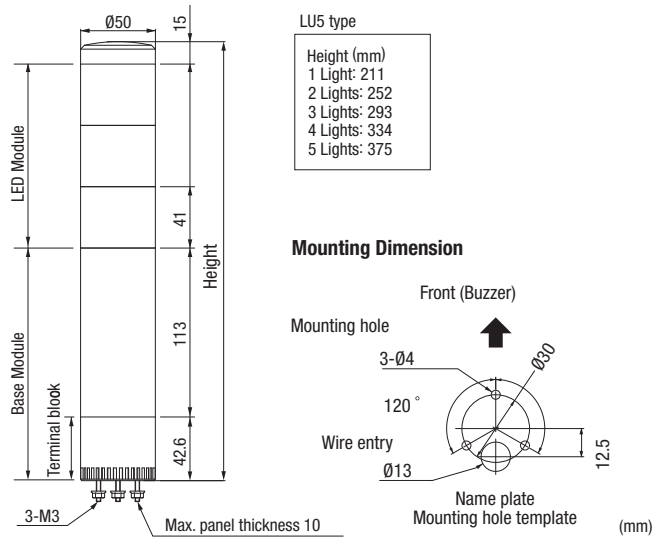

Wiring diagram



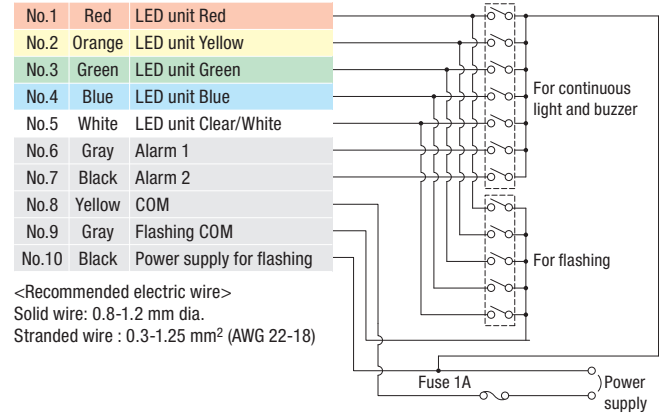

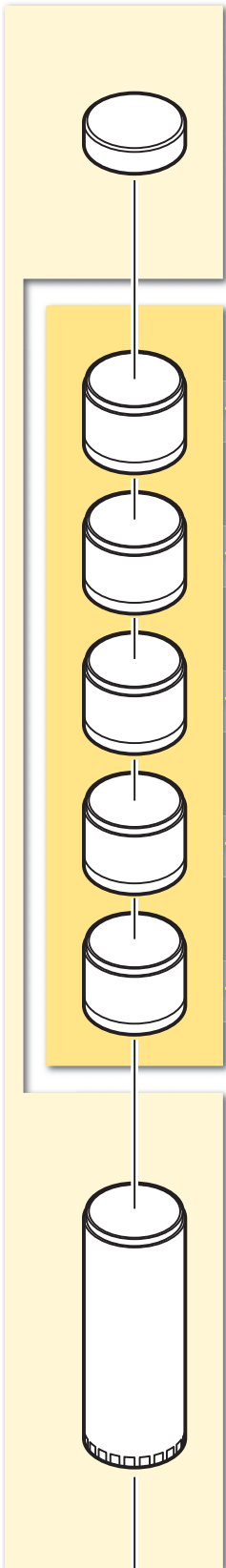
LU5-02FB
24 VDC











LED Units





| | | | | | |
|------------------------------------|---|---|---|---|---|
| Model | LU5-E-R | LU5-E-Y | LU5-E-G | LU5-E-B | LU5-E-C |
| Unit Color |  |  |  |  |  |
| Rated Voltage | 24 VDC | | | | |
| Operating Voltage Range | Rated Voltage±10%(21.6~26.4 V) | | | | |
| Current/Power Consumption | 52 mA/1.25 W | | 42 mA/1.0 W | | |
| Operating Temperature Range | -30°C~+60°C | | | | |
| Mass | 44 g±10% | | | | |



 RED
 YELLOW
 GREEN
 BLUE
 CLEAR/WHITE

BASE Units



| | | |
|---------------------------------|---|---|
| Model | LU5-02 | LU5-02FB |
| Color |  |  |
| Standard Body/Short Body | Standard | |
| Rated Voltage | 24 VDC | |
| Operating Voltage Range | Rated voltage±10%(21.6~26.4 V) | |
| Buzzer | - | *Buzzer 1 **Buzzer 2 |
| Current Consumption | - | 50±10 mA 24±10 mA |
| Power Consumption | - | 1.2±0.25 W 0.58±0.25 W |
| Sound Level | - | Max:85±5dB(at 1m) |
| Flashing Cycle | - | 6±12 flashes per minutes |
| Operating Temperature | -30°C~+60°C | |
| Range | Upright, Indoor only | |
| Mounting Direction | IP65 | |
| Protection Rating | 182 g±10% | 200 g±10% |
| Mass | PNP/NPN | |

Open Collector
 * Buzzer 1 : Continuous Sound **Buzzer 2 : Intermittent Sound

 Ivory White
 Silver Color(U)

Optional Parts

How to order

Optional Parts

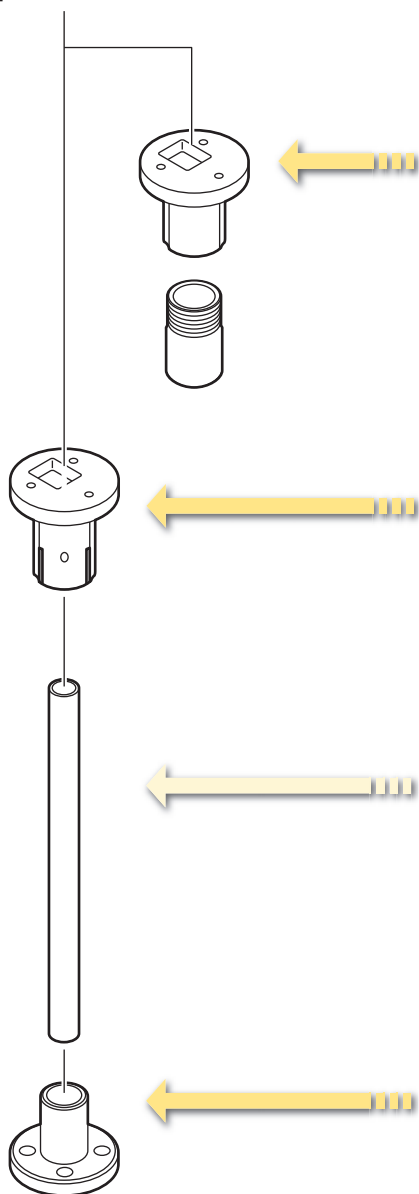

Upper Bracket

SZ-60NPT (for 1/2" NPT Pole)

Upper Bracket

SZ-60-U

Pole

21.7mm

Steel Pole

| | | | |
|--------|-------------|-------------|-------------|
| Model | POLE-800S21 | POLE-300S21 | POLE-100S21 |
| Height | 800mm | 300mm | 100mm |

Aluminum Pole

| | | | |
|--------|-------------|-------------|-------------|
| Model | POLE-800A21 | POLE-300A21 | POLE-100A21 |
| Height | 800mm | 300mm | 100mm |

Mount Bracket

SZ-016A
(For Ø21.7mm Pole)

SZ-70-B
(For Ø21.7mm Aluminium Pole Only)

Wall Mount Bracket

SZ-020
(For Ø21.7mm Pole)

SZ-017
(For Ø21.7mm Pole)

Specifications

| | |
|------------------------|---|
| Size | 50 mm diameter |
| Input voltage options | 24 VDC |
| Functions available | Continuous only Continuous, Flashing, Alarms |
| Mounting options | Direct mount only, includes 3 mounting nuts |
| Body styles | Component style, wiring terminals provided Interchangeable and stackable after purchase |
| Body colours | Beige |
| Tiers | 1-5 modules can be stacked |
| Module colors | Red / Yellow / Green / Blue / Clear |
| Alarms (FB style only) | Alarm 1: selectable, single-tone, continuous alarm, 85 dB (at 1 m) Alarm 2: selectable, single tone, intermittent (slow beep) alarm, 85 dB (at 1 m) |
| Ratings | CE UL Listed (US) UL Listed (Canada) RoHS |
| Protection | IP-65 Type 4 / 4X / 13 (indoor only) |
| Control options | Dry contact closure such as switches or relay contacts Open-collector transistor (NPN or PNP) for 24 VDC Direct voltage control for 24 VDC, continuous and alarm functions only |

LU7

Ordering Information

LED module

| Typ | Module Color | Power Consumption | Rated Voltage | Operation Voltage | Operation Temperature Range | Mass | Order Code | |
|----------|--------------|-------------------|---------------|------------------------------------|-----------------------------|--------------|------------|----------|
| Standard | Red | 52 mA/ 1.25 W | 24 VDC | Rated voltage±10% (21.6~26.4 V) | -30°C~+60°C | 60 g ±10% | LU7-E-R | |
| | Yellow | | | | | | LU7-E-Y | |
| | Green | 42 mA/1.0 W | | | | | LU7-E-G | |
| | Blue | | | | | | LU7-E-B | |
| | Clear/ White | | | | | | LU7-E-C | |
| Strobe | Red | 290 mA | 24 VDC | Rated voltage±10% (21.6~26.4 V) | -30°C~+60°C | 70 g | LU7-XE-R | |
| | Yellow | 140 mA | | | | | LU7-XE-Y | |
| | Green | | | | | | LU7-XE-G | |
| | Blue | | | | | | 270 mA | LU7-XE-B |
| | Clear/ White | | | | | | 280 mA | LU7-XE-C |

Base module

| Typ | Alarm/ Flash | Power Consumption | Rated Voltage | Operation Voltage | Operation Temperature Range | Mass | Open Collector | Order Code |
|---------------|-------------------------|-------------------|---------------|---|-----------------------------|---------------|----------------|------------|
| Short Body | Continuous | 1.2 W | 24 VDC | Rated voltage ± 10% (21.6~26.4 V) | -30°C~+60°C | 150 g ±10% | PNP/ NPN | LU7-02S* |
| Standard Body | Continuous | | | | | 250 g ±10% | | LU7 - 02* |
| | 2 Sounds/ Flashlight | 280 g ±10% | | | | LU7 -02FB* | | |

* Ivory white: blank, black: add "K", silver: add "U"

Optional parts

| Typ | Material | Order code |
|--------------------|-------------------------|------------|
| Wall Mount Bracket | Aluminum alloy die-cast | SZ-017 |
| | PBT/ ABS resin | SZ-018 |
| | | SZ-018U |
| | | SZ-018K |
| | ABS resin | SZ-020 |
| Upper Bracket | Metal | SZ - 50U |
| | | SZ - 50UU |
| | | SZ - 50KU |
| | | SZ - 50NPT |
| Mount Bracket | Aluminum alloy die-cast | SZ-016A |
| | | SZ-70B |

| Typ | Height | Material | Order code |
|------|--------|-----------|-------------|
| Pole | 100 mm | Aluminium | Pole-100A21 |
| | | Steel | Pole-100S21 |
| | 300 mm | Aluminium | Pole-300A21 |
| | | Steel | Pole-300S21 |
| | 800 mm | Aluminium | Pole-800A21 |
| | | Steel | Pole-800S21 |

Voice and Sound Module
(unique sound module in all directions)

| Rated Voltage | Power Consumption | Mass | Order code |
|---------------|-------------------|-------|------------|
| 24 VDC | 3.5 W | 170 g | LU7-V1 |

Features

Easy alignment:
Color-coordinated Terminal Block:
Corresponds to the lens colors for quick wiring verification in the base unit.

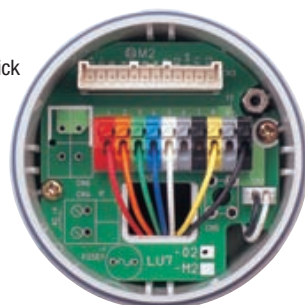

LU7-02FB

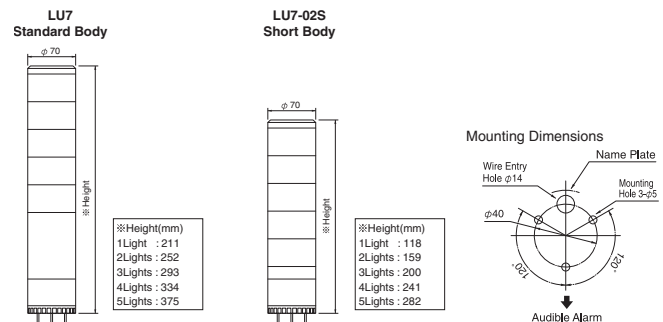

How to order

The diagram illustrates the assembly of an LED Signal Tower. On the left, a vertical stack of components is shown: a Voice and Sound Module at the top, followed by five LED Units, then five LED Strobe Modules, and finally a Base Unit at the bottom. Yellow arrows point from the detailed specification boxes on the right to the corresponding components in the assembly diagram.

Voice and Sound Module

| | |
|-------------------|-------------------|
| Model | LU7-V1 |
| Type | Voice Synthesizer |
| Rated Voltage | 24 VDC |
| Power Consumption | 3.5 W |
| Weight | 0.17 kg |

LED Units

| | | | | | |
|-----------------------------|--------------------------------|---------|-------------|---------|---------|
| Model | LU7-E-R | LU7-E-Y | LU7-E-G | LU7-E-B | LU7-E-C |
| Unit Color | | | | | |
| Rated Voltage | 24 VDC | | | | |
| Operating Voltage Range | Rated Voltage±10%(21.6~26.4 V) | | | | |
| Current/Power Consumption | 52 mA/1.25 W | | 42 mA/1.0 W | | |
| Operating Temperature Range | -30°C~+60°C | | | | |
| Mass | 60 g±10% | | | | |

LED Strobe Module

| | | | | | |
|-------------------|----------|----------|----------|----------|----------|
| Model | LU7-XE-R | LU7-XE-Y | LU7-XE-G | LU7-XE-B | LU7-XE-C |
| Unit Color | | | | | |
| Rated Voltage | 24 VDC | | | | |
| Power Consumption | 290 mA | 290 mA | 140 mA | 270 mA | 280 mA |
| Mass | 0.07 kg | | | | |

RED
 YELLOW
 GREEN
 BLUE
 CLEAR/WHITE

BASE Units

| | | | |
|--------------------------|--------------------------------|--|------------|
| Model | LU7-02S | LU7-02 | LU7-02FB |
| Color | | | |
| Standard Body/Short Body | Short | Standard | |
| Rated Voltage | 24 VDC | | |
| Operating Voltage Range | Rated voltage±10%(21.6~26.4 V) | | |
| Buzzer | - | *Buzzer 1 | **Buzzer 2 |
| Current Consumption | - | 50±10 mA | 24±10 mA |
| Power Consumption | - | 1.2±0.25 W ; 0.58±0.25 W | |
| Sound Level | - | Max:90±5dB(at 1m) Min:70dB or Less(at 1m) | |
| Flashing Cycle | - | 60±12 flashes per minute | |
| Operating Temperature | -30°C~+60°C | | |
| Range | Upright, Indoor only | | |
| Mounting Direction | IP65 | | |
| Protection Rating Mass | 150 g±10% | 250 g±10% | 280 g±10% |
| Open Collector | PNP/NPN | | |

* Buzzer 1 : Continuous Sound **Buzzer 2 : Intermittent Sound

Ivory White
 Silver Color(U)
 Black(K)

Optional Parts

Optional Parts

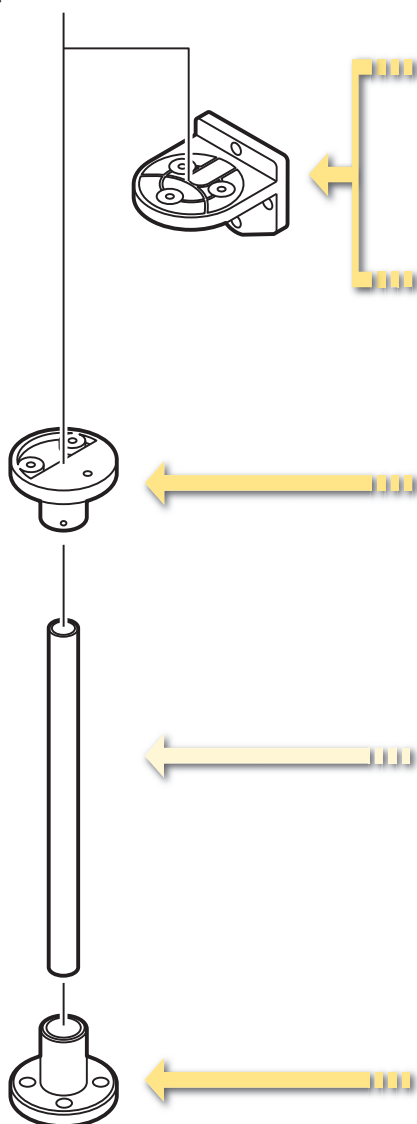

Wall Mount Bracket

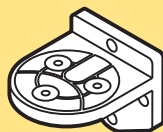

| | | | |
|--------------|-------------|------------------|-----------|
| Model | SZ-18 | SZ-18U | SZ-18K |
| Color | Ivory White | Silver Color (U) | Black (K) |

Upper Bracket



SZ-50NPT (For 1/2" NPT Pole)

Upper Bracket



| | | | |
|--------------|-------------|------------------|-----------|
| Model | SZ-50-U | SZ-50U-U | SZ-50K-U |
| Color | Ivory White | Silver Color (U) | Black (K) |

Pole

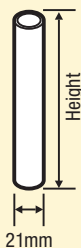

Steel Pole

| | | | |
|---------------|-------------|-------------|-------------|
| Model | POLE-800S21 | POLE-300S21 | POLE-100S21 |
| Height | 800mm | 300mm | 100mm |

Aluminum Pole

| | | | |
|---------------|-------------|-------------|-------------|
| Model | POLE-800A21 | POLE-300A21 | POLE-100A21 |
| Height | 800mm | 300mm | 100mm |

Mount Bracket

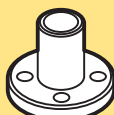

SZ-016A
(For Ø21.7mm Pole)



SZ-70-B
(For Ø21.7mm Aluminium Pole Only)

Wall Mount Bracket



SZ-020
(For Ø21.7mm Pole)



SZ-017
(For Ø21.7mm Pole)

Specifications

| | |
|------------------------|---|
| Size | 70 mm diameter |
| Input voltage options | 24 VDC |
| Functions available | Continuous only Continuous, Flashing, Alarms |
| Mounting options | Direct mount only; includes three mounting nuts |
| Body style | Component Style, wiring terminals provided Interchangeable and stackable after purchase |
| Body color | Beige Black Silver |
| Tiers | 1-5 modules can be stacked |
| Module colors | Red / Yellow / Green / Blue / Clear Standard LED Modules Strobe-flash LED Modules (24 V bases only) |
| Alarms (FB style only) | Alarm 1: selectable, single-tone, continuous alarm, 90 dB (at 1 m) Alarm 2: selectable, single tone, intermittent (slow beep) alarm, 90 dB (at 1 m) |
| Ratings | CE UL Listed (US) UL Listed (Canada) RoHS |
| Protections | IP-65 Type 4/4X/13 (indoor only) |
| Control options | Dry contact closure such as switches or relay contacts Open-collector transistor (NPN or PNP) for 24 VDC Direct voltage control for 24 VDC, continuous and alarm functions only |

MP/MPS

Nomenclatur/ How to order:

MP-502-RYGBC-B0438

- | | | |
|---|--|---|
| 1. MP: Standard Body MPS: Short Body | 4. Color of LED R: Red Y: Yellow G: Green B: Blue C: Clear/White Top to bottom | 5. Color of lense Blank: Colored lens B0438: Clear lens |
|---|--|---|

Ordering information

| Number of stacks | Rated voltage | Power Consumption | Open collector | Order code |
|------------------|----------------|-------------------|----------------|------------|
| 1 | 24 VAC/ VDC | 0.7 W | NPN/PNP | MP/MPS-102 |
| 2 | | 1.4 W | | MP/MPS-202 |
| 3 | | 2.0 W | | MP/MPS-302 |
| 4 | | 2.6 W | | MP/MPS-402 |
| 5 | | 3.2 W | | MP/MPS-502 |

Features

Patented reflection system increases visibility.

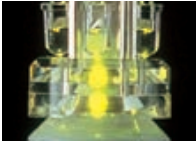

High intensity LED



Good visibility from any direction

Interchangeable LED modules

- Changeable color sequence: Easy to add/remove up to 5 colored modules even after installation.
- Note: LED modules of the same color will light up simultaneously.

The wiring remains the same.

Each color of LED module corresponds to the lead wire color.



Dimensions

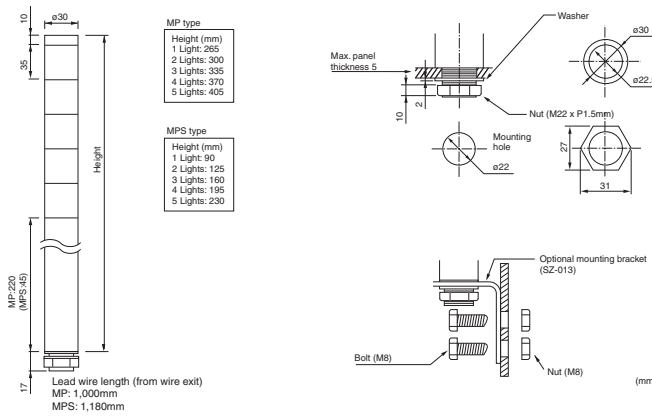

Wiring diagram

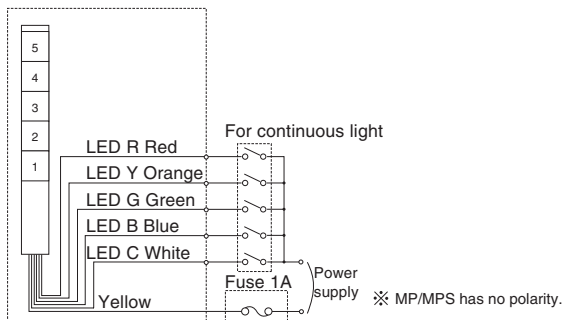

Specifications

| | |
|-----------------------|---|
| Size | 30 mm diameter |
| Input voltage options | 24 VAC/VDC |
| Functions available | Continuous only |
| Mounting options | Direct mount only: includes M22 mounting nut and sealing gasket |
| Body style | pre-assembled, pre-wired Interchangeable and stackable after purchase |
| Body color | Silver |
| Tiers | 1-5 modules can be stacked |
| Module colors | Red / Yellow / Green / Blue / Clear-White (for sunlight applications: clear-lense modules in all colors available) |
| Ratings | CE UL Component Recognition (US) UL Component Recognition (Canada) RoHS |
| Protection | IP-65 |
| Control options | Dry contact closure such as switches or relay contacts Open-collector transistor (NPN or PNP) for 24 VDC Direct voltage control |

LME

Nomenclature/How to order

LME-502UFBW-C-RYGBC-Z

1 2 3 4 5 6 7

- 1. Stack
1 ~ 5
- 2. Rated Voltage
02: 24V AC/DC
- 3. Body Color
Blank: Ivory white
N: Black color
U: Silver color
- 4. Type
Blank: Continuous light
FB: Continuous light or flashing light with audible alarm
- 5. Mount
Blank: Pole mount
K: Pole Mount (with SZ-020)
W: Direct mount
- 6. Cable
C: Special pre-wired cable connection of 3 m
- 7. Color of LED
R: Red
Y: Yellow
G: Green
B: Blue
C: Clear/White
- 8. Color of Lens
Blank: Colored lens
Z: Clear lens

Ordering Information

| Number of Stacks | Mount | Model | Rated Voltage | Power Consumption | Open Collector | Order code | |
|------------------|--------------|---------|---------------|-------------------|----------------|------------------|-------------------------------------|
| | | | | | | Continuous light | Continuous light with audible alarm |
| 1 | Pole Mount | LME-102 | 24 VAC/DC | 2.2 W | NPN/ PNP | LME-102-C | LME-102-FB-C |
| | Direct Mount | | 24 VAC/DC | | | LME-102W-C | LME-102-FBW-C |
| 2 | Pole Mount | LME-202 | 24 VAC/DC | 3.4 W | | LME-202-C | LME-202-FB-C |
| | Direct Mount | | 24 VAC/DC | | | LME-202W-C | LME-202-FBW-C |
| 3 | Pole Mount | LME-302 | 24 VAC/DC | 3.8 W | | LME-302-C | LME-302-FB-C |
| | Direct Mount | | 24 VAC/DC | | | LME-302W-C | LME-302-FBW-C |
| 4 | Pole Mount | LME-402 | 24 VAC/DC | 4.2 W | | LME-402-C | LME-402-FB-C |
| | Direct Mount | | 24 VAC/DC | | | LME-402W-C | LME-402-FBW-C |
| 5 | Pole Mount | LME-502 | 24 VAC/DC | 4.6 W | | LME-502-C | LME-502-FB-C |
| | Direct Mount | | 24 VAC/DC | | | LME-502W-C | LME-502-FBW-C |

Optional parts

| Typ | Material | Order code |
|--------------------|-------------------------|------------|
| Wall Mount Bracket | Aluminum alloy die-cast | SZ-017 |
| | ABS resin | SZ-020 |
| | PBT/ ABS resin | SZ-028 |
| Mount Bracket | Aluminum alloy die-cast | SZ-016A |
| | Aluminum alloy die-cast | SZ-010 |

| Typ | Height | Material | Order code |
|------|--------|-----------|-------------|
| Pole | 100 mm | Aluminium | Pole-100A21 |
| | | Steel | Pole-100S21 |
| | 300 mm | Aluminium | Pole-300A21 |
| | | Steel | Pole-300S21 |
| | 800 mm | Aluminium | Pole-800A21 |
| | | Steel | Pole-800S21 |

Dimensions

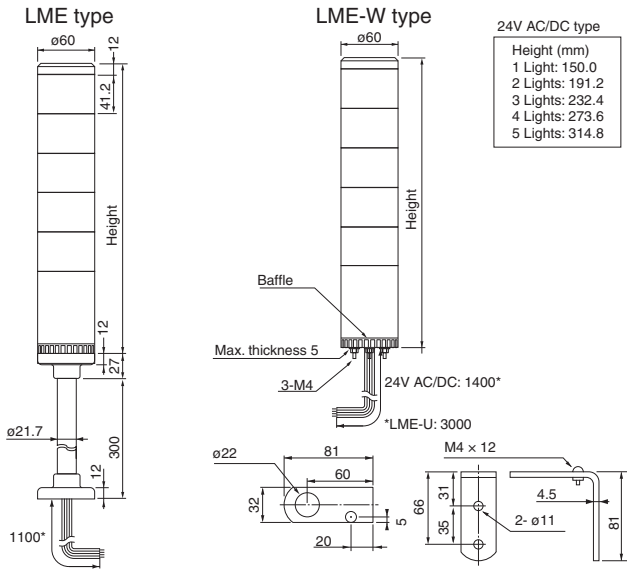

Wiring diagram

LME(-W)/LME(-W)-S-Q/LMS [Continuous type]

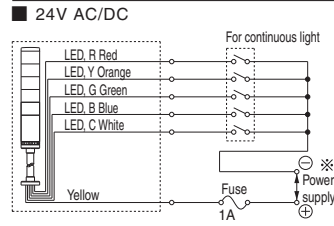

Features

Interchangeable LED modules

- Changeable color sequence: Easy to add / remove up to 5 colored modules even after installation.
- Note: LED modules of the same color within a signal tower will light up simultaneously.



Easy to add and remove

If the number of LED module is changed, center shaft must be purchased.

The wiring remains the same

Each color of LED module corresponds to the lead wire color.

Dual reflection system



PATLITE's original dual reflection system with its exclusive hybrid prism-cut lens and 5 color LED modules create bright, distinctive, even illumination.



To bring more attention to certain conditions, two, User-selectable, Alarms integrated in the Base module with adjustable volume up to 85 dB at 1m are available.

Specifications

| | |
|------------------------|---|
| Size | 60 mm diameter |
| Input voltage options | 24 VAC/VDC |
| Functions available | Continuous only Continuous, Flashing, Alarms |
| Mounting options | Pole mount: with 300 mm aluminum pole, plastic circular bracket Direct mount: includes 3 mounting nuts |
| Body style | Pre-assembled, pre-wired Interchangeable and stackable after purchase |
| Body color | Beige (optional: Black or Silver) |
| Tiers | 1-5 modules can be stacked |
| Module colors | Red / Yellow / Green / Blue / Clear/White (for sunlight applications: clear-lense modules in all colors available) |
| Alarms (FB style only) | Alarm 1: selectable, single-tone, intermittent (fast beep) alarm, 85 dB (at 1 m) Alarm 2: selectable, single tone, intermittent (slow beep) alarm, 85 dB (at 1 m) |
| Ratings | CE UL Component Recognition (US) UL Component Recognition (Canada) RoHS |
| Protection | IP-65 (LME, LME-W) IP-54 (LME-FB, LME-FBW) Type 4/4X/13 (indoor, direct-mount only) |
| Control options | Dry contact closure such as switches or relay contacts Open-collector transistor (NPN or PNP) for 24 VDC Direct voltage control for 24 VDC, continuous and alarm functions only |

WARRANTY

OMRON's exclusive warranty is that the products are free from defects in materials and workmanship for a period of one year (or other period if specified) from date of sale by OMRON.

OMRON MAKES NO WARRANTY OR REPRESENTATION, EXPRESS OR IMPLIED, REGARDING NON-INFRINGEMENT, MERCHANTABILITY, OR FITNESS FOR PARTICULAR PURPOSE OF THE PRODUCTS. ANY BUYER OR USER ACKNOWLEDGES THAT THE BUYER OR USER ALONE HAS DETERMINED THAT THE PRODUCTS WILL SUITABLY MEET THE REQUIREMENTS OF THEIR INTENDED USE. OMRON DISCLAIMS ALL OTHER WARRANTIES, EXPRESS OR IMPLIED.

LIMITATIONS OF LIABILITY

OMRON SHALL NOT BE RESPONSIBLE FOR SPECIAL, INDIRECT, OR CONSEQUENTIAL DAMAGES, LOSS OF PROFITS OR COMMERCIAL LOSS IN ANY WAY CONNECTED WITH THE PRODUCTS, WHETHER SUCH CLAIM IS BASED ON CONTRACT, WARRANTY, NEGLIGENCE, OR STRICT LIABILITY.

In no event shall responsibility of OMRON for any act exceed the individual price of the product on which liability is asserted.

IN NO EVENT SHALL OMRON BE RESPONSIBLE FOR WARRANTY, REPAIR, OR OTHER CLAIMS REGARDING THE PRODUCTS UNLESS OMRON'S ANALYSIS CONFIRMS THAT THE PRODUCTS WERE PROPERLY HANDLED, STORED, INSTALLED, AND MAINTAINED AND NOT SUBJECT TO CONTAMINATION, ABUSE, MISUSE, OR INAPPROPRIATE MODIFICATION OR REPAIR.

SUITABILITY FOR USE

THE PRODUCTS CONTAINED IN THIS DOCUMENT ARE NOT SAFETY RATED. THEY ARE NOT DESIGNED OR RATED FOR ENSURING SAFETY OF PERSONS, AND SHOULD NOT BE RELIED UPON AS A SAFETY COMPONENT OR PROTECTIVE DEVICE FOR SUCH PURPOSES. Please refer to separate catalogs for OMRON's safety rated products.

OMRON shall not be responsible for conformity with any standards, codes, or regulations that apply to the combination of products in the customer's application or use of the product.

At the customer's request, OMRON will provide applicable third party certification documents identifying ratings and limitations of use that apply to the products. This information by itself is not sufficient for a complete determination of the suitability of the products in combination with the end product, machine, system, or other application or use.

The following are some examples of applications for which particular attention must be given. This is not intended to be an exhaustive list of all possible uses of the products, nor is it intended to imply that the uses listed may be suitable for the products:

- Outdoor use, uses involving potential chemical contamination or electrical interference, or conditions or uses not described in this document.
- Nuclear energy control systems, combustion systems, railroad systems, aviation systems, medical equipment, amusement machines, vehicles, safety equipment, and installations subject to separate industry or government regulations.
- Systems, machines, and equipment that could present a risk to life or property.

Please know and observe all prohibitions of use applicable to the products.

NEVER USE THE PRODUCTS FOR AN APPLICATION INVOLVING SERIOUS RISK TO LIFE OR PROPERTY WITHOUT ENSURING THAT THE SYSTEM AS A WHOLE HAS BEEN DESIGNED TO ADDRESS THE RISKS, AND THAT THE OMRON PRODUCT IS PROPERLY RATED AND INSTALLED FOR THE INTENDED USE WITHIN THE OVERALL EQUIPMENT OR SYSTEM.

PERFORMANCE DATA

Performance data given in this document is provided as a guide for the user in determining suitability and does not constitute a warranty. It may represent the result of OMRON's test conditions, and the users must correlate it to actual application requirements. Actual performance is subject to the OMRON Warranty and Limitations of Liability.

CHANGE IN SPECIFICATIONS

Product specifications and accessories may be changed at any time based on improvements and other reasons.

It is our practice to change model numbers when published ratings or features are changed, or when significant construction changes are made. However, some specifications of the product may be changed without any notice. When in doubt, special model numbers may be assigned to fix or establish key specifications for your application on your request. Please consult with your OMRON representative at any time to confirm actual specifications of purchased products.

DIMENSIONS AND WEIGHTS

Dimensions and weights are nominal and are not to be used for manufacturing purposes, even when tolerances are shown.

ERRORS AND OMISSIONS

The information in this document has been carefully checked and is believed to be accurate; however, no responsibility is assumed for clerical, typographical, or proofreading errors, or omissions.

PROGRAMMABLE PRODUCTS

OMRON shall not be responsible for the user's programming of a programmable product, or any consequence thereof.

Cat. No. F09E-EN-01

In the interest of product improvement, specifications are subject to change without notice.

OMRON EUROPE B.V.

Wegalaan 67-69,
 NL-2132 JD, Hoofddorp,
 The Netherlands
 Phone: +31 23 568 13 00
 Fax: +31 23 568 13 88
 www.industrial.omron.eu