

R88M-G□

# G-Series servo motors

## A wide range of compact servomotors to meet all application needs

- Peak torque 300% of continuous torque during 3 seconds or more depending on model
- Servomotors supported by SmartStep2, G-Series and G5-Series servo drives
- Cylindrical and Flat servomotors types are available
- Available motors with absolute and incremental with 17-bit encoder for greater accuracy
- IP65 as standard and shaft oil seal available
- Motors with brake as option

### Ratings

- 230 VAC Single-phase 50 W to 1.5 kW (rated torque from 0.16 to 8.62 Nm)

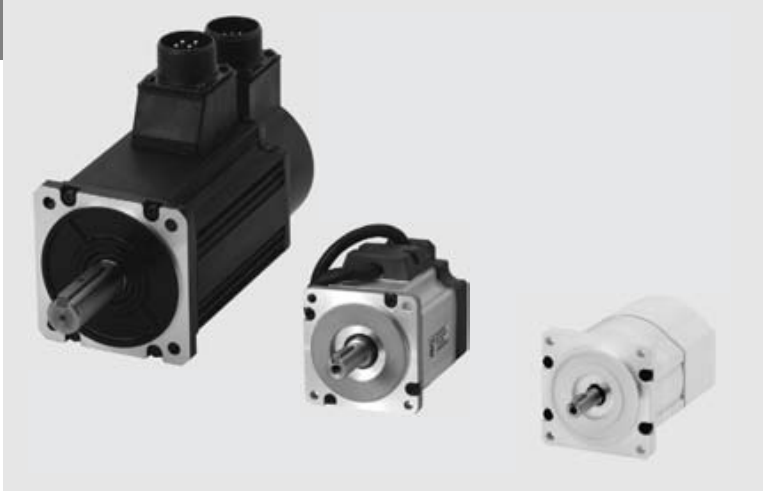

## System configuration

### G-Series Cylindrical type Servo Motor

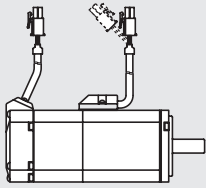

3000 rpm (50-750W)

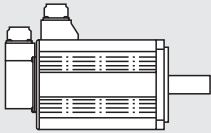

3000 rpm (1000-1500 W)  
2000 rpm (1000-1500 W)  
1000 rpm (900 W)

Power cable

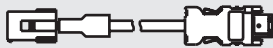

Encoder cable

### G-Series Flat type Servo Motor

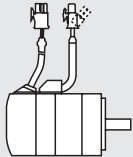

3000 rpm (100-400 W)

### G-Series Servo Drive

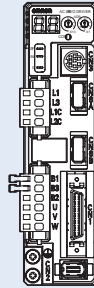

### SmartStep 2 Servo Drive Servo Drive controlled by pulses

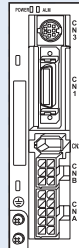

Servo motor / servo drive combination

		Servo motor					Servo drive		
Family		Voltage	Speed	Rated torque	Capacity	Model	SmartStep2 <sup>3</sup>	G-Series	
Cylindric	50-750 W	230 V	3000 min <sup>-1</sup>	0.16 Nm	50 W	R88M-G05030□-□S2	R7D-BP01H	R88D-GN01H-ML2	
				0.32 Nm	100 W	R88M-G10030□-□S2	R7D-BP01H	R88D-GN01H-ML2	
				0.64 Nm	200 W	R88M-G20030□-□S2	R7D-BP02HH	R88D-GN02H-ML2	
				1.3 Nm	400 W	R88M-G40030□-□S2	R7D-BP04H	R88D-GN04H-ML2	
				2.4 Nm	750 W	R88M-G75030□-□S2	-	R88D-GN08H-ML2	
	900-1500 W		2000 min <sup>-1</sup>	3.18 Nm	1000 W	R88M-G1K030T-□S2	-	R88D-GN15H-ML2	
				4.77 Nm	1500 W	R88M-G1K530T-□S2	-	R88D-GN15H-ML2	
				4.8 Nm	1000 W	R88M-G1K020T-□S2	-	R88D-GN10H-ML2	
				7.15 Nm	1500 W	R88M-G1K520T-□S2	-	R88D-GN15H-ML2	
				1000 min <sup>-1</sup>	8.62 Nm	900 W	R88M-G90010T-□S2	-	R88D-GN15H-ML2
Flat	100-400 W	3000 min <sup>-1</sup>	0.32 Nm	100 W	R88M-GP10030□-□S2	R7D-BP01H	R88D-GN01H-ML2		
			0.64 Nm	200 W	R88M-GP20030□-□S2	R7D-BP02HH	R88D-GN02H-ML2		
			1.3 Nm	400 W	R88M-GP40030□-□S2	R7D-BP04H	R88D-GN04H-ML2		

- Note:**
1. For servo motor and cables part numbers refer to ordering information at the end of this chapter
  2. Refer to the servo drive chapter for drive options selection and detailed specifications
  3. SmartStep2 only supports incremental encoder

Type designation

Servo motor

R88M-GP10030H-BOS2

G-Series Servomotor

Motor Type

Blank: Cylinder type  
P: Flat type

Capacity

050	50 W
100	100 W
200	200 W
400	400 W
750	750 W
900	900 W
1K0	1 kW
1K5	1.5 kW

Rated Speed (r/min)

10	1000
20	2000
30	3000

Shaft end specifications

Blank	Straigh shaft, no key
S2	Straigh, key, tapped

Oil seal specifications

Blank	No oil seal
O	Oil seal

Brake specifications

Blank	No brake
B	Brake

Voltage and encoder specifications

H: 230 V with incremental encoder  
T: 230 V with absolute encoder

**Servo motor specifications**

**Cylindrical servo motors 3000/2000/1000 r/min**

**Ratings and specifications**

Applied voltage		230 V									
Servo motor model R88M-□		G05030	G10030	G20030	G40030	G75030	G1K030T	G1K530T	G1K020T	G1K520T	G90010T
Rated output	W	50	100	200	400	750	1000	1500	1000	1500	900
Rated torque	N·m	0.16	0.32	0.64	1.3	2.4	3.18	4.77	4.8	7.15	8.62
Instantaneous peak torque	N·m	0.45	0.90	1.78	3.67	7.05	9.1	12.8	13.5	19.6	18.4
Rated current	A (rms)	1.1		1.6	2.6	4	7.2	9.4	5.6	9.4	7.6
Instantaneous max. current	A (rms)	3.4		4.9	7.9	12.1	21.4	28.5	17.1	28.5	17.1
Rated speed	min <sup>-1</sup>	3000							2000		1000
Max. speed	min <sup>-1</sup>	5000				4500	5000		3000		2000
Torque constant	N·m/A (rms)	0.14	0.19	0.41	0.51	0.64	0.44	0.51	0.88	0.76	1.13
Rotor moment of inertia (JM)	kg·m <sup>2</sup> ×10 <sup>-4</sup>	0.025	0.051	0.14	0.26	0.87	1.69	2.59	6.17	11.2	
Allowable load moment of inertia (JL)	Multiple of (JM)	30				20	15		10		
Rated power rate	kW/s	10.4	20.1	30.3	62.5	66	60	88	37.3	45.8	66.3
Applicable Encoder		Incremental encoder (10000 pulses)					Incremental /Absolute encoder (17 bits)				
Allowable radial load	N	68		245		392		490		686	
Allowable thrust load	N	58		98		147		196			
Approx. mass	Kg (without brake)	0.3	0.5	0.8	1.2	2.3	4.5	5.1	6.8	8.5	
	Kg (with brake)	0.5	0.7	1.3	1.7	3.1	5.1	6.5	8.7	10.1	10
Brake specifications	Rated voltage	24 VDC +/-5%					24 VDC +/-10%				
	Holding brake moment of inertia J	0.002		0.018		0.075	0.25	0.33	1.35		
	Power consumption (at 20°C)	7		9		10	18	19	14	19	
	Current consumption (at 20°C)	0.3		0.36		0.42	0.74	0.81	0.59	0.79	
	Static friction torque	0.29		1.27		2.45	4.9	7.8	4.9	13.7	
	Rise time for holding torque	35		50		70	50		80	100	
Release time	20		15		20	15		70	50		
Basic specifications	Rating	Continuous									
	Insulation grade	Type B					Type F				
	Ambient operating/ storage temperature	0 to +40°C/ -20 to 65°C					0 to +40°C/ -20 to 80°C				
	Ambient operating/ storage humidity	85% RH max. (non-condensing)									
	Vibration class	V-15									
	Insulation resistance	20 MΩ min. at 500 VDC between the power terminals and FG terminal									
	Enclosure	Totally-enclosed, self-cooling, IP65 (excluding shaft opening and lead wire ends)									
	Vibration resistance	Vibration acceleration 49 m/s <sup>2</sup>					Vibration acceleration 24.5 m/s <sup>2</sup>				
Mounting	Flange-mounted										

**Torque-speed characteristics**

R88M-G05030H/T (50 W)

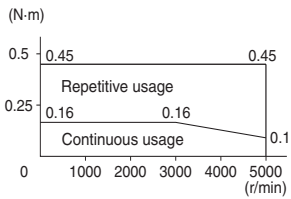

R88M-G10030H/T (100 W)

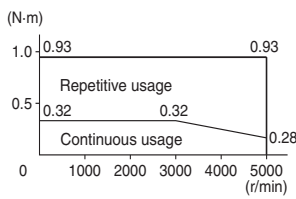

R88M-G20030H/T (200 W)

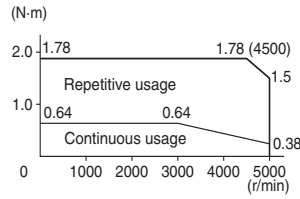

R88M-G40030H/T (400 W)

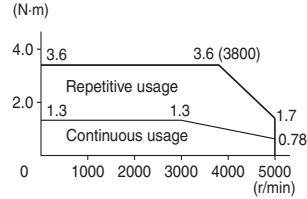

R88M-G75030H/T (750 W)

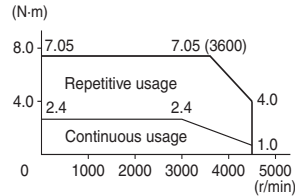

R88M-G1K030T (1 kW)

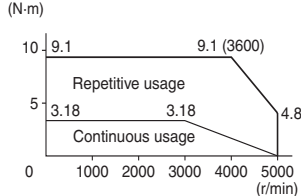

R88M-G1K530T (1.5 kW)

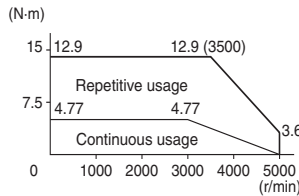

R88M-G1K020T (1 kW)

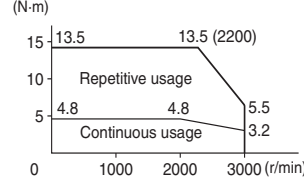

R88M-G1K520T (1.5 kW)

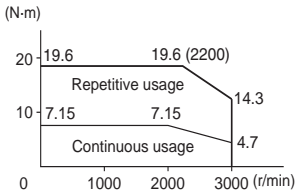

R88M-G90010T (900 W)

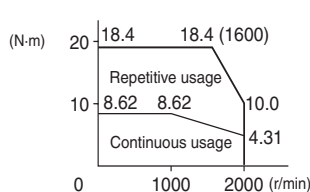

Flat servo motors 3000 r/min

Ratings and specifications

Applied voltage		230 V		
Servo motor model R88M-□		GP10030□	GP20030□	GP40030□
Rated output	W	100	200	400
Rated torque	N·m	0.32	0.64	1.3
Instantaneous peak torque	N·m	0.86	1.8	3.65
Rated current	A (rms)	1	1.6	2.5
Instantaneous max. current	A (rms)	3.1	4.9	7.5
Rated speed	min <sup>-1</sup>	3000		
Max. speed	min <sup>-1</sup>	5000		
Torque constant	N·m/A (rms)	0.34	0.42	0.54
Rotor moment of inertia (JM)	kg·m <sup>2</sup> ×10 <sup>-4</sup>	0.1	0.35	0.64
Allowable load moment of inertia (JL)	Multiple of (JM)	20		
Rated power rate	kW/s	10.2	11.5	25.5
Applicable encoder		Incremental (10000 pulses)		
		Incremental /Absolute encoder(17 bits)		
Allowable radial load	N	68	245	
Allowable thrust load	N	58	98	
Approx. mass	Kg (without brake)	0.7	1.3	1.8
	Kg (with brake)	0.9	2	2.5
Brake specifications	Rated voltage	24VDC +/-10%		
	Holding brake moment of inertia J	kg·m <sup>2</sup> ×10 <sup>-4</sup>	0.03	0.09
	Power consumption (at 20°C)	W	7	10
	Current consumption (at 20°C)	A	0.29	0.41
	Static friction torque	N·m (minimum)	0.29	1.27
	Rise time for holding torque	ms (max.)	50	60
	Release time	ms (max)	15	
Basic specifications	Rating	Continuous		
	Insulation grade	Type B		
	Ambient operating/ storage temperature	0 to +40 °C/ -20 to 80°C		
	Ambient operating/ storage humidity	85% RH max. (non-condensing)		
	Vibration class	V-15		
	Insulation resistance	20 MΩ min. at 500 VDC between the power terminals and FG terminal		
	Enclosure	Totally-enclosed, self-cooling, IP65 (excluding shaft opening and lead wire ends)		
	Vibration resistance	Vibration acceleration 49 m/s <sup>2</sup>		
Mounting	Flange-mounted			

Torque-speed characteristics

R88M-GP10030H/T (100 W)

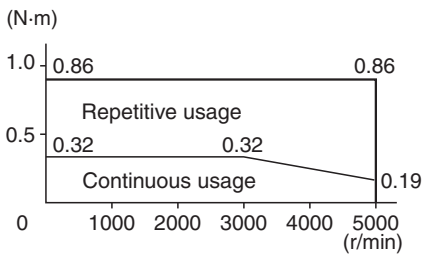

R88M-GP20030H/T (200 W)

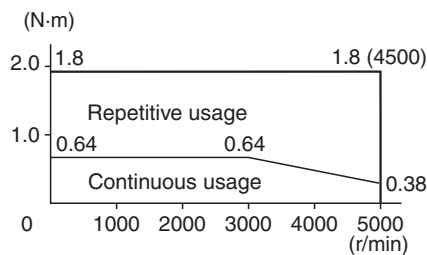

R88M-GP40030H/T (400 W)

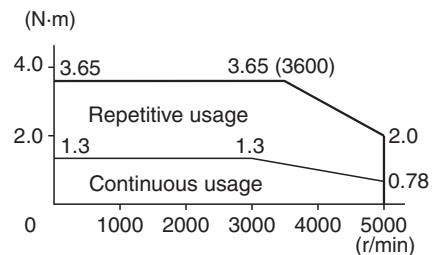

**Dimensions**

**Servo motors**

**Cylindrical type 3000 r/min (230 V, 50-100 W)**

Dimensions (mm)	Without brake	With brake	LN	Flange surface		Shaft end		Aprox. Mass (Kg)	
				D	S	B	Without brake	With brake	
R88M-G05030□□S2	72	102	26.5	30 <sup>h7</sup>	8 <sup>h6</sup>	3 <sup>h9</sup>	0.3	0.5	
R88M-G10030□□S2	92	122	46.5				0.5	0.7	

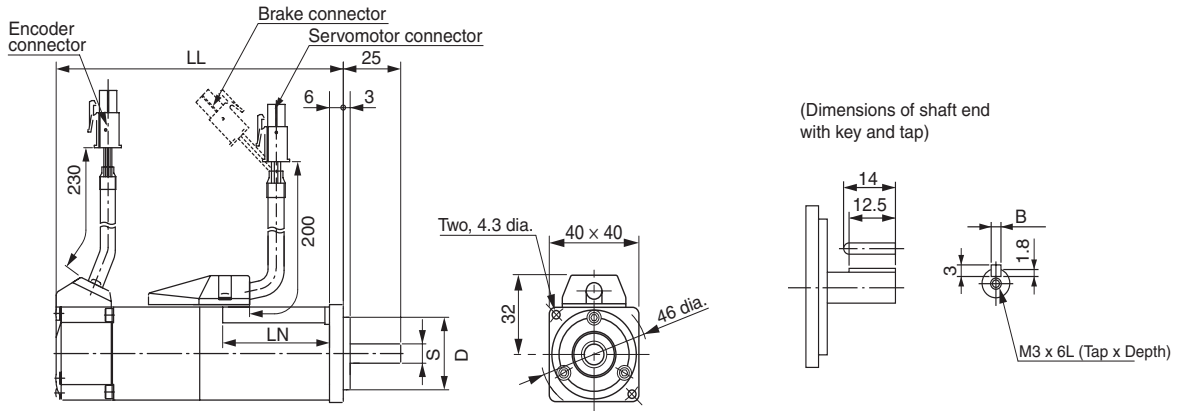

**Cylindrical type 3000 r/min (230 V, 200-750 W)**

Dimensions (mm)	Without brake	With brake	LR	KL1	Flange surface					Shaft end					Aprox. Mass (Kg)		
					D1	D2	C	G	Z	S	QK	B	H	T1	Tap x depth	Without brake	With brake
R88M-G20030□□S2	79.5	116	30	43	70	50 <sup>h7</sup>	60	6.5	4.5	11 <sup>h6</sup>	18	4 <sup>h9</sup>	4	2.5	M4x8L	0.8	1.3
R88M-G40030□□S2	99	135.5			90	70 <sup>h7</sup>	80	8		14 <sup>h6</sup>	22.5	5 <sup>h9</sup>	5	3	M5x10L	1.2	1.7
R88M-G75030□□S2	112.2	149.2	35	53	90	70 <sup>h7</sup>	80	8	6	19 <sup>h6</sup>	22	6 <sup>h9</sup>	6	3.5		2.3	3.1

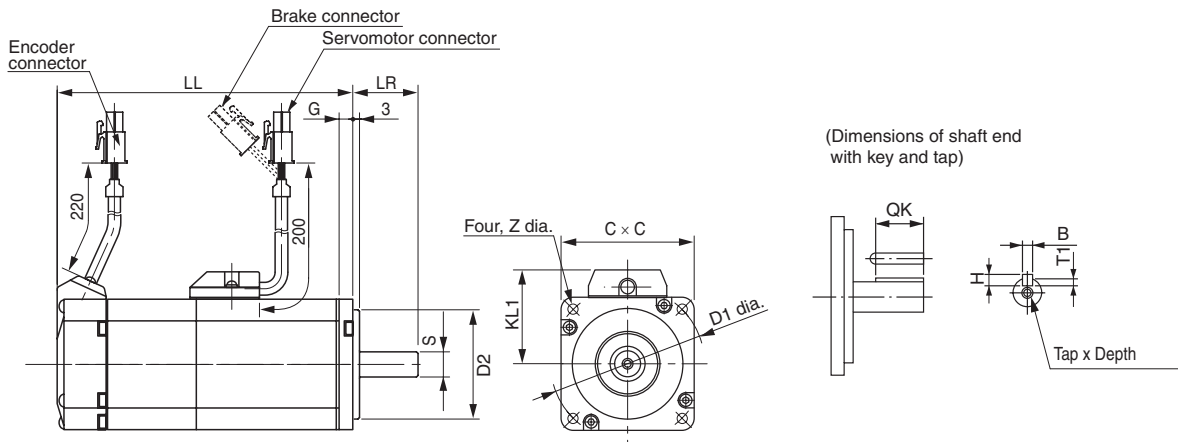

Cylindrical type 3000, 2000 and 1000 r/min (230 V, 900 kW - 1.5 kW)

Dimensions (mm)	Without brake	With brake	LR	KL1	Flange surface								Shaft end					Aprox. Mass (Kg)		
					D1	D2	D3	C	G	F	Z	S	QK	B	H	T1	Tap x depth	Without brake	With brake	
R88M-G1K030T-□S2	175	200	55	98	100	80 <sup>h7</sup>	120	90	7	3	6.6	19 <sup>h6</sup>	42	6 <sup>h9</sup>	6	3.5	M5x12L	4.5	5.1	
R88M-G1K530T-□S2	180	205		103	115	95 <sup>h7</sup>	135	100	10		9								5.1	6.5
R88M-G1K020T-□S2	150	175		118	145	110 <sup>h7</sup>	165	130	12	6		22 <sup>h6</sup>	41	8 <sup>h9</sup>	7	4			6.8	8.7
R88M-G1K520T-□S2	175	200																	8.5	10.1
R88M-G90010T-□S2	175	200	70																10	

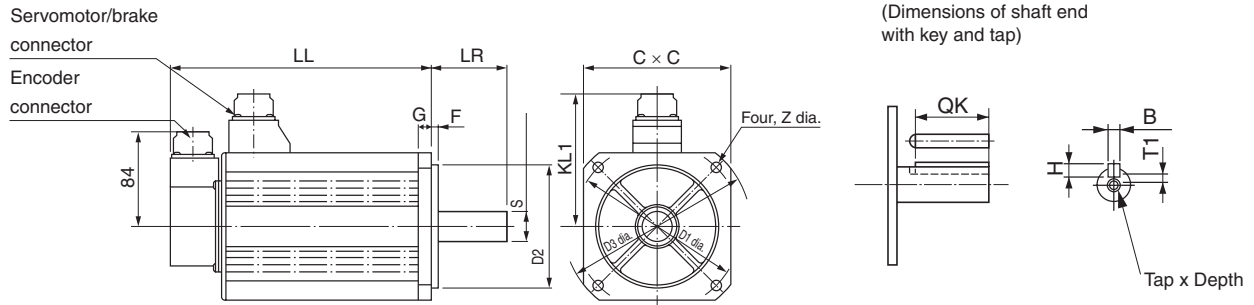

Flat type 3000 r/min (230 V, 100 W - 400 W)

Dimensions (mm)	Without brake	With brake	LR	KL1	Flange surface							Shaft end					Aprox. Mass (Kg)			
					D1	D2	C	F	G	Z	S	QK	B	H	T1	Tap x depth	Without brake	With brake		
R88M-GP10030H-□S2	60.5	84.5	25	43	70	50 <sup>h7</sup>	60	3	7	4.5	8 <sup>h6</sup>	12.5	3 <sup>h9</sup>	3	1.8	M3x6L	0.7	0.9		
R88M-GP10030T-□S2	87.5	111.5																		
R88M-GP20030H-□S2	67.5	100	30	53	90	70 <sup>h7</sup>	80	5	8	5.5	11 <sup>h6</sup>	18	4 <sup>h9</sup>	4	2.5	M4x8L	1.3	2		
R88M-GP20030T-□S2	94.5	127																		
R88M-GP40030H-□S2	82.5	115											14 <sup>h6</sup>	22.5	5 <sup>h9</sup>	5	3.0	M5x10L	1.8	2.5
R88M-GP40030T-□S2	109.5	142																		

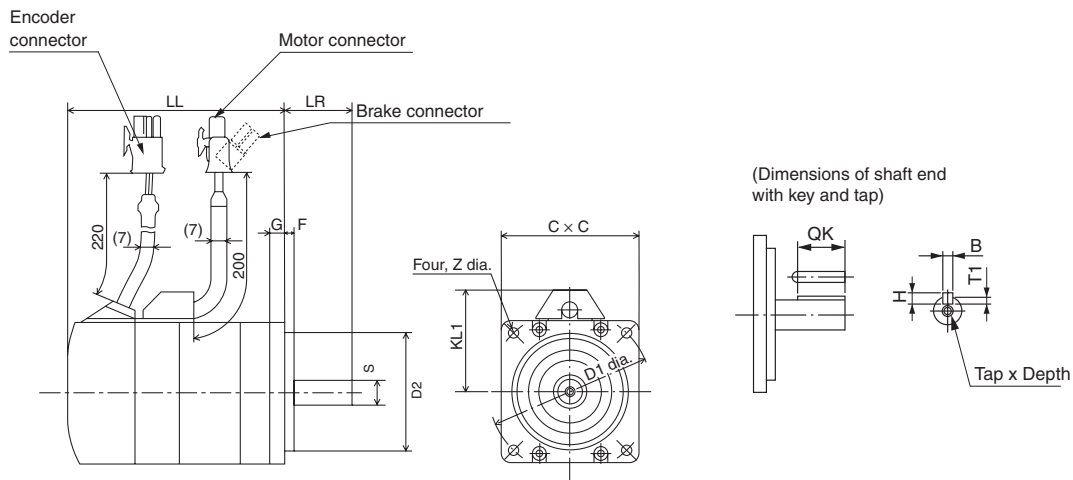

Ordering information

① G-Series Cylindrical type Servo Motor

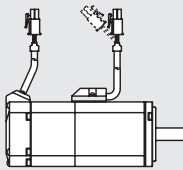

3000 rpm (50-750W)

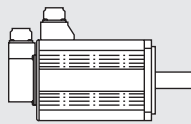

3000 rpm (1000-1500 W)  
2000 rpm (1000-1500 W)  
1000 rpm (900 W)

③ Encoder cable

④ Absolute Encoder Battery cable

② G-Series Servo Drive

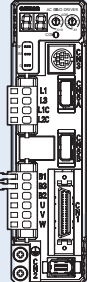

② SmartStep 2 Servo Drive  
Servo Drive controlled by pulses

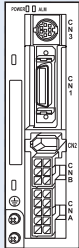

① G-Series Flat type Servo Motor

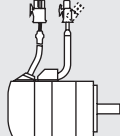

3000 rpm (100-400 W)

⑤ Power cable

⑥ Brake cable

**Note:** The symbols ①②③④⑤⑥... show the recommended sequence to select the servo motor and cables



**Servo motor**

① Select motor from Cylindrical and Flat types using motor tables in next pages.

**Servo drive**

② Refer to G-Series and SmartStep2 servo drive chapters for detailed drive specifications and selection of drive accessories.

**Cylindrical servo motors 3000/2000/1000 r/min (50 - 1.5 kW)**

Symbol	Specifications						Servo motor model	Compatible servo drives ②	
	Voltage	Encoder and design	Speed	Design	Rated torque	Capacity		SmartStep2	G-Series
 (50-750 W)   (900-1500 W)	230 V	Incremental encoder (10000 pulses)  Straight shaft with key & tap	3000 min <sup>-1</sup>	Without brake	0.16 Nm	50 W	R88M-G05030H-S2	R7D-BP01H	R88D-GN01H-ML2
					0.32 Nm	100 W	R88M-G10030H-S2	R7D-BP01H	R88D-GN01H-ML2
					0.64 Nm	200 W	R88M-G20030H-S2	R7D-BP02HH	R88D-GN02H-ML2
					1.3 Nm	400 W	R88M-G40030H-S2	R7D-BP04H	R88D-GN04H-ML2
					2.4 Nm	750 W	R88M-G75030H-S2	-	R88D-GN08H-ML2
					0.16 Nm	50 W	R88M-G05030H-BS2	R7D-BP01H	R88D-GN01H-ML2
				With brake	0.32 Nm	100 W	R88M-G10030H-BS2	R7D-BP01H	R88D-GN01H-ML2
					0.64 Nm	200 W	R88M-G20030H-BS2	R7D-BP02HH	R88D-GN02H-ML2
					1.3 Nm	400 W	R88M-G40030H-BS2	R7D-BP04H	R88D-GN04H-ML2
					2.4 Nm	750 W	R88M-G75030H-BS2	-	R88D-GN08H-ML2
					0.16 Nm	50 W	R88M-G05030T-S2	-	R88D-GN01H-ML2
					0.32 Nm	100 W	R88M-G10030T-S2	-	R88D-GN01H-ML2
		Absolute/ incremental encoder (17 bits)  Straight shaft with key & tap	Without brake	0.64 Nm	200 W	R88M-G20030T-S2	-	R88D-GN02H-ML2	
				1.3 Nm	400 W	R88M-G40030T-S2	-	R88D-GN04H-ML2	
				2.4 Nm	750 W	R88M-G75030T-S2	-	R88D-GN08H-ML2	
				3.18 Nm	1 kW	R88M-G1K030T-S2	-	R88D-GN15H-ML2	
				4.77 Nm	1.5 kW	R88M-G1K530T-S2	-	R88D-GN15H-ML2	
				0.16 Nm	50 W	R88M-G05030T-BS2	-	R88D-GN01H-ML2	
			With brake	0.32 Nm	100 W	R88M-G10030T-BS2	-	R88D-GN01H-ML2	
				0.64 Nm	200 W	R88M-G20030T-BS2	-	R88D-GN02H-ML2	
				1.3 Nm	400 W	R88M-G40030T-BS2	-	R88D-GN04H-ML2	
				2.4 Nm	750 W	R88M-G75030T-BS2	-	R88D-GN08H-ML2	
				3.18 Nm	1 kW	R88M-G1K030T-BS2	-	R88D-GN15H-ML2	
				4.77 Nm	1.5 kW	R88M-G1K530T-BS2	-	R88D-GN15H-ML2	
2000 min <sup>-1</sup>	Without brake	4.8 Nm	1 kW	R88M-G1K020T-S2	-	R88D-GN10H-ML2			
		7.15 Nm	1.5 kW	R88M-G1K520T-S2	-	R88D-GN15H-ML2			
		4.8 Nm	1 kW	R88M-G1K020T-BS2	-	R88D-GN10H-ML2			
	With brake	7.15 Nm	1.5 kW	R88M-G1K520T-BS2	-	R88D-GN15H-ML2			
		1000 min <sup>-1</sup>	Without brake	8.62 Nm	900 W	R88M-G90010T-S2	-	R88D-GN15H-ML2	
			With brake	-	-	R88M-G90010T-BS2	-	R88D-GN15H-ML2	

Flat type servo motors 3000 r/min (100 - 400 W)

Symbol	Specifications				Servo motor model	Compatible servo drives (2)		
	Voltage	Encoder and design		Rated torque		Capacity	SmartStep2	G-Series
	230 V	Incremental encoder (10000 pulses)	Without brake	0.32 Nm	100 W	R88M-GP10030H-S2	R7D-BP01H	R88D-GN01H-ML2
				0.64 Nm	200 W	R88M-GP20030H-S2	R7D-BP02HH	R88D-GN02H-ML2
				1.3 Nm	400 W	R88M-GP40030H-S2	R7D-BP04H	R88D-GN04H-ML2
		Straight shaft with key & tap	With brake	0.32 Nm	100 W	R88M-GP10030H-BS2	R7D-BP01H	R88D-GN01H-ML2
				0.64 Nm	200 W	R88M-GP20030H-BS2	R7D-BP02HH	R88D-GN02H-ML2
				1.3 Nm	400 W	R88M-GP40030H-BS2	R7D-BP04H	R88D-GN04H-ML2
	Absolute/ incremental encoder (17 bits)	Without brake	Straight shaft with key & tap	0.32 Nm	100 W	R88M-GP10030T-S2	-	R88D-GN01H-ML2
				0.64 Nm	200 W	R88M-GP20030T-S2	-	R88D-GN02H-ML2
				1.3 Nm	400 W	R88M-GP40030T-S2	-	R88D-GN04H-ML2
		With brake	0.32 Nm	100 W	R88M-GP10030T-BS2	-	R88D-GN01H-ML2	
			0.64 Nm	200 W	R88M-GP20030T-BS2	-	R88D-GN02H-ML2	
			1.3 Nm	400 W	R88M-GP40030T-BS2	-	R88D-GN04H-ML2	

Encoder Cables

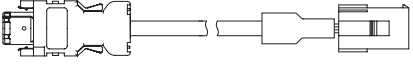
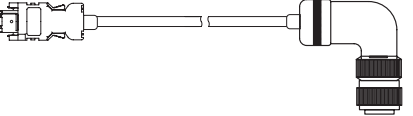
Symbol	Specifications	Model	Appearance
③	Encoder cable for absolute encoder (50-750 W) R88M-G(50/100/200/400/750)30T-□ R88M-GP(100/200/400)30T-□	1.5 m R88A-CRGA001-5CR-E	
		3 m R88A-CRGA003CR-E	
		5 m R88A-CRGA005CR-E	
		10 m R88A-CRGA010CR-E	
		15 m R88A-CRGA015CR-E	
		20 m R88A-CRGA020CR-E	
	Encoder cable for Incremental encoder (50-750 W) R88M-G(50/100/200/400/750)30H-□ R88M-GP(100/200/400)30H-□	1.5 m R88A-CRGB001-5CR-E	
		3 m R88A-CRGB003CR-E	
		5 m R88A-CRGB005CR-E	
		10 m R88A-CRGB010CR-E	
		15 m R88A-CRGB015CR-E	
		20 m R88A-CRGB020CR-E	
	Encoder cable for Absolute encoder (900-1500 W) R88M-G(1K0/1K5)30T-□ R88M-G(1K0/1K5)20T-□ R88M-G90010T-□	1.5 m R88A-CRGC001-5NR-E	
		3 m R88A-CRGC003NR-E	
		5 m R88A-CRGC005NR-E	
		10 m R88A-CRGC010NR-E	
		15 m R88A-CRGC015NR-E	
		20 m R88A-CRGC020NR-E	

Absolute Encoder Battery cable

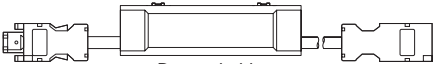
Symbol	Specifications	Model	Appearance	
④	Absolute Encoder battery cable	Battery not included	0.3 m R88A-CRGD0R3C	 <p>Battery holder</p>
		One R88A-BAT01G Battery included	0.3 m R88A-CRGD0R3C-BS	
	Absolute Encoder backup battery 2,000 mA.h 3.6V	-	-	

**Note:** The absolute encoder battery cable is only an extension and must be used with an absolute encoder cable.



**Power cables**

**for SmartStep2 servo drive**

Symbol	Specifications	Model	Appearance	
⑤	For servomotors from 50 to 400 W R88M-G(50/100/200/400)30□ R88M-GP(100/200/400)30□  For servomotors with brake, a separate cable (R88A-CAGA□BR-E) is needed	1.5 m	R7A-CAB001-5SR-E	
		3 m	R7A-CAB003SR-E	
		5 m	R7A-CAB005SR-E	
		10 m	R7A-CAB010SR-E	
		15 m	R7A-CAB015SR-E	
		20 m	R7A-CAB020SR-E	

**for G-Series servo drive**

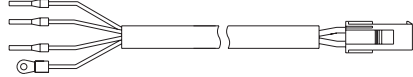
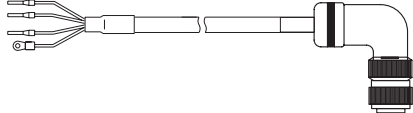
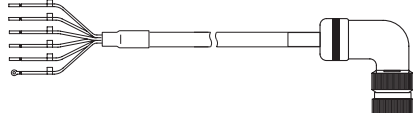
Symbol	Specifications	Model	Appearance	
⑤	For servomotors from 50 to 750W R88M-G(50/100/200/400/750)30□ R88M-GP(100/200/400)30□  For servomotors with brake, a separate cable (R88A-CAGA□BR-E) is needed	1.5 m	R88A-CAGA001-5SR-E	
		3 m	R88A-CAGA003SR-E	
		5 m	R88A-CAGA005SR-E	
		10 m	R88A-CAGA010SR-E	
		15 m	R88A-CAGA015SR-E	
		20 m	R88A-CAGA020SR-E	
	For servomotors from 900 to 1.5 kW without brake R88M-G(1K0/1K5)30T-S2 R88M-G(1K0/1K5)20T-S2 R88M-G90010T-S2	1.5 m	R88A-CAGB001-5SR-E	
		3 m	R88A-CAGB003SR-E	
		5 m	R88A-CAGB005SR-E	
		10 m	R88A-CAGB010SR-E	
		15 m	R88A-CAGB015SR-E	
		20 m	R88A-CAGB020SR-E	
For servomotors from 900 to 1.5 kW with brake R88M-G(1K0/1K5)30T-BS2 R88M-G(1K0/1K5)20T-BS2 R88M-G90010T-BS2	1.5 m	R88A-CAGB001-5BR-E		
	3 m	R88A-CAGB003BR-E		
	5 m	R88A-CAGB005BR-E		
	10 m	R88A-CAGB010BR-E		
	15 m	R88A-CAGB015BR-E		
	20 m	R88A-CAGB020BR-E		

**Brake cable (for 50-750W servomotors)**

Symbol	Specifications	Model	Appearance	
⑥	Brake cable only. For servomotors from 50 to 750W with brake  R88M-G(050/100/200/400/750)30□-BS2, R88M-GP(100/200/400)30□-BS2	1.5 m	R88A-CAGA001-5BR-E	
		3 m	R88A-CAGA003BR-E	
		5 m	R88A-CAGA005BR-E	
		10 m	R88A-CAGA010BR-E	
		15 m	R88A-CAGA015BR-E	
		20 m	R88A-CAGA020BR-E	

**Connectors for power, encoder and brake cables**

Specifications	Applicable Servomotor	Model	
Connectors for power cables	Drive side (CNB)	R88M-G(050/100/200/400)30H□, R88M-GP(100/200/400)30H□ (SmartStep2 Servo drives only)	R7A-CNB01A
	Motor side	R88M-G(050/100/200/400/750)30□, R88M-GP(100/200/400)30□	R88A-CNG01A
	Motor side	R88M-G(1K0/1K5)30□-S2, R88M-G(1K0/1K5)20□-S2, R88M-G90010□-S2 (without brake)	MS3108E20-4S
	Motor side	R88M-G(1K0/1K5)30□-BS2, R88M-G(1K0/1K5)20□-BS2, R88M-G90010□-BS2 (with brake)	MS3108E20-18S
Connectors for encoder cables	Drive side (CN2)	-	R88A-CNW01R
	Motor side	R88M-G(050/100/200/400/750)30T-□, R88M-GP(100/200/400)30T-□ (Absolute encoder)	R88A-CNG01R
	Motor side	R88M-G(050/100/200/400/750)30H-□, R88M-GP(100/200/400)30H-□ (Incremental encoder)	R88A-CNG02R
	Motor side	R88M-G(1K0/1K5)30T-□, R88M-G(1K0/1K5)20T-□, R88M-G90010T-□	MS3108E20-29S
Connector for brake cable	Motor side	R88M-G(050/100/200/400/750)30□-BS2, R88M-GP(100/200/400)30□-BS2	R88A-CNG01B

ALL DIMENSIONS SHOWN ARE IN MILLIMETERS.  
To convert millimeters into inches, multiply by 0.03937. To convert grams into ounces, multiply by 0.03527.