

GENERAL CATALOGUE 2003/2004

Automatic Identification Systems

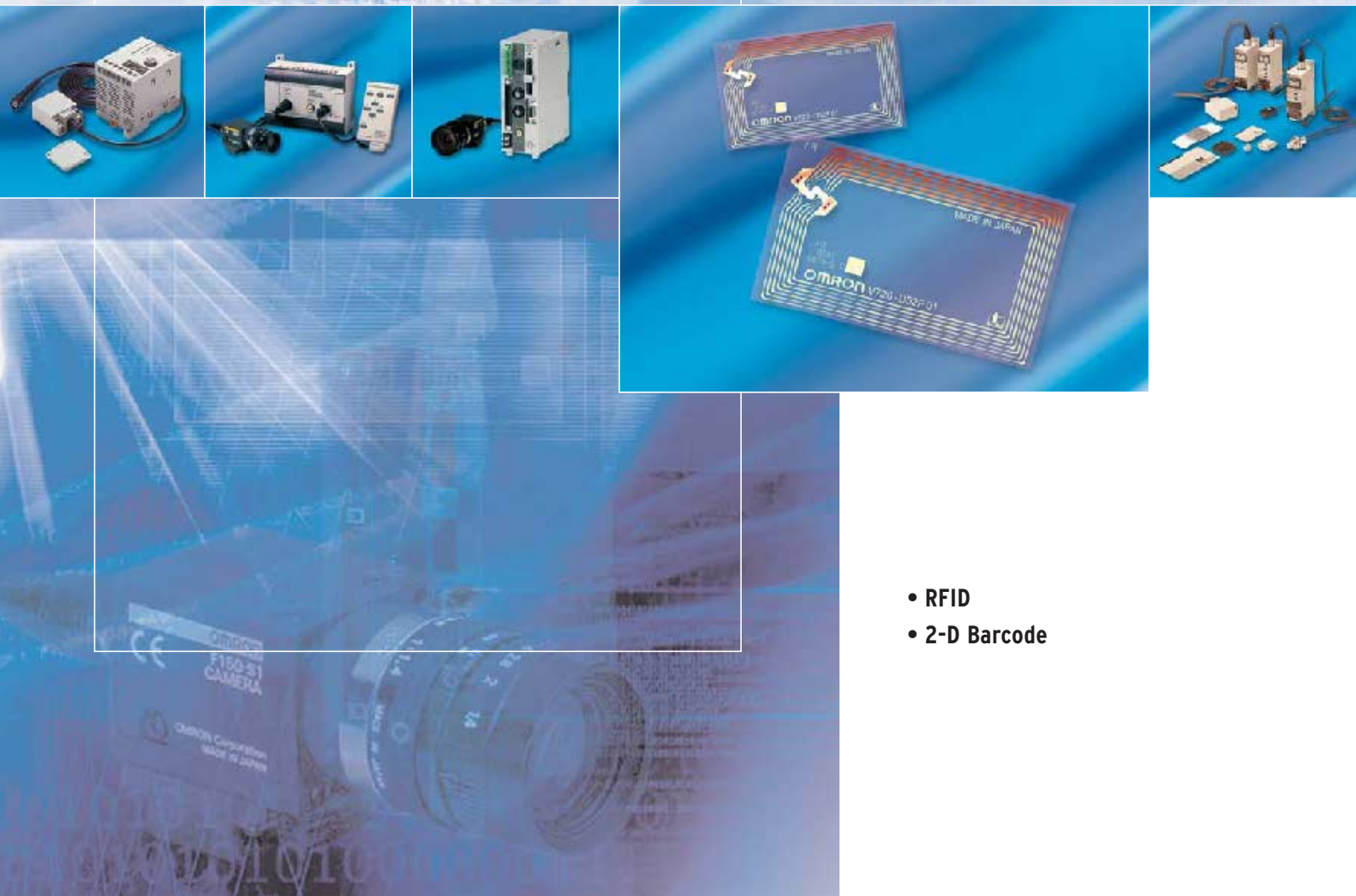

- RFID
- 2-D Barcode

Advanced Industrial Automation

WELCOME TO OMRON`S

Automatic Identification Systems

This catalogue features products that are ideally suited for use in today and tomorrow's needs for flexible information. With over 15 years experience in RFID Omron is one of the pioneers in this field. This results in a product range that fits into the market needs of today. These markets vary from local access control points to sophisticated supply chain management environments. Our business experts are most willing to guide you through every stage of your project.

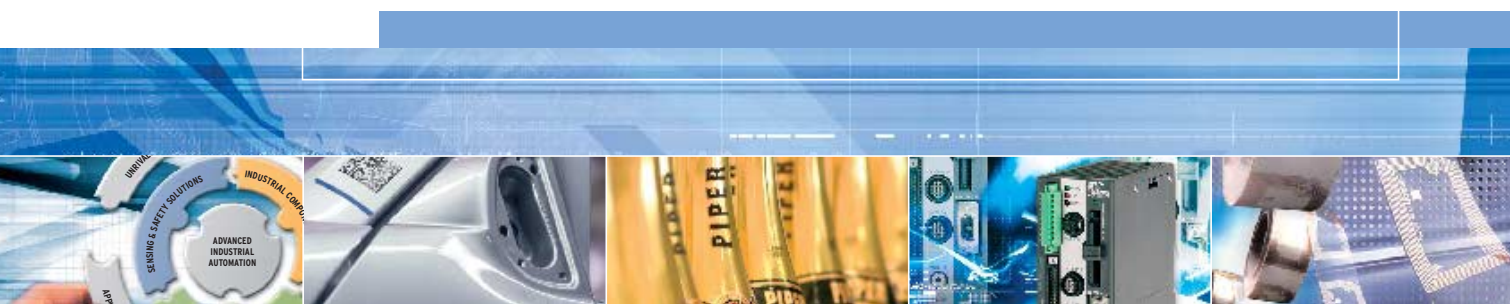

- 2** Advanced Industrial Automation
- 4** Proven application expertise
- 5** Our products make the world go round



ADVANCED INDUSTRIAL AUTOMATION

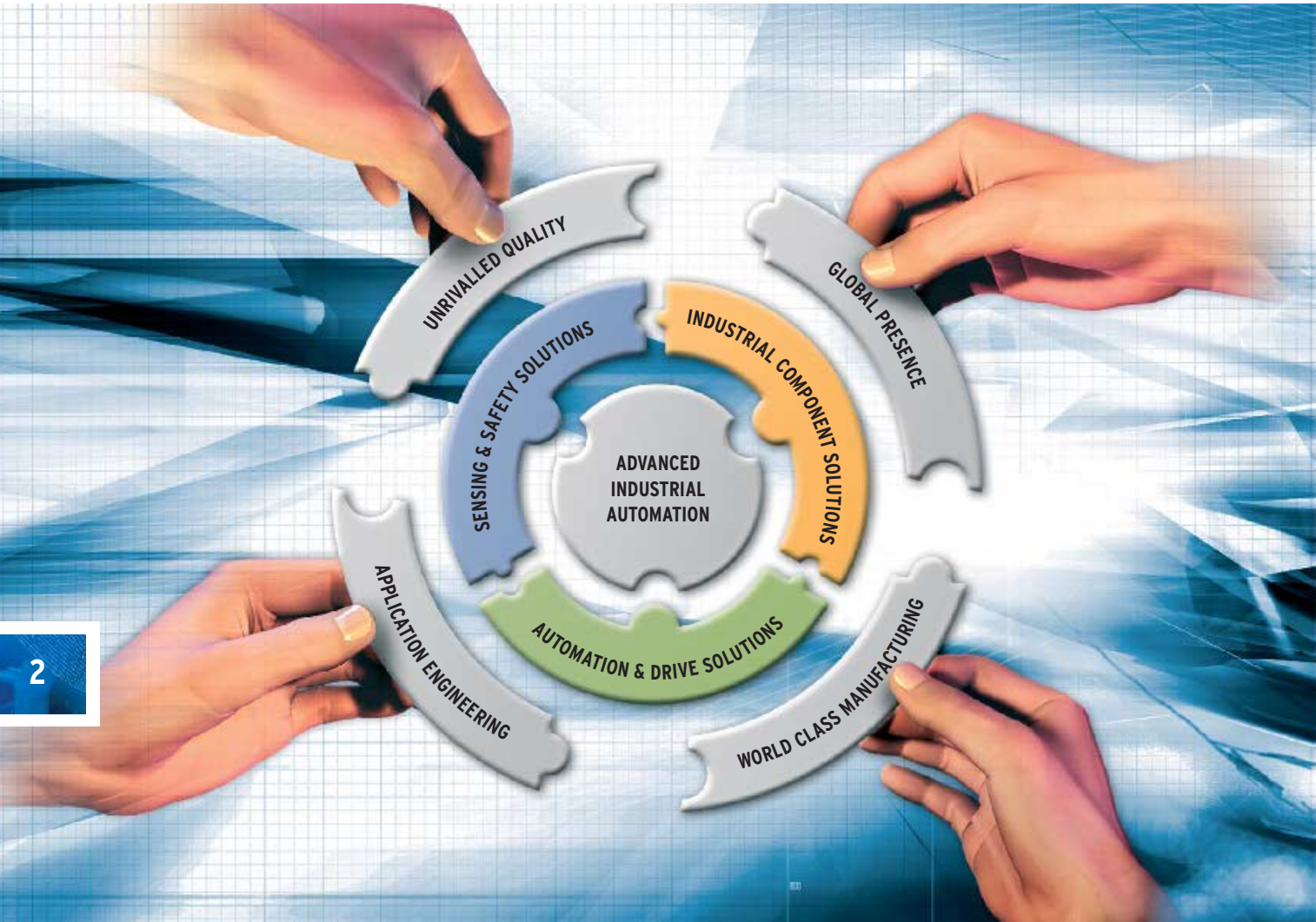

Today's industrial manufacturers are constantly faced with new challenges posed by ever increasing demands on performance, quality and cost. In an environment where every movement, every component and every assembly operation must be immediately and automatically recorded, checked and documented for maximum efficiency, Omron can provide the solution. Omron's industrial automation product range includes optical sensors and measuring systems, high-speed industrial-grade image processing systems, controlling and switching devices, highly dynamic drives and product tracking systems for information interchange, all of which meet today's industrial automation challenges.

Omron also caters to the logistics and information processing sectors by developing advanced network and field bus systems, which ensure that relevant data collected in the field by sensors and other equipment can be easily accessed and analysed by production managers through standard Office applications.

Omron is your one-stop shop for future-oriented products matched to perform in perfect unison. We are constantly developing new products and enhancing existing ones. Each year sees the introduction of at least 20 new product ranges in industrial components, safety engineering, sensors, image processing, drives and automation systems.



Our close relations with customers and partners in industry mean we are well-placed to quickly identify new trends which we can incorporate in the development of our own new products. In this we are helped by our Research and Development (R&D) Centres and our highly efficient production sites in the major regions of the world. With such distributed facilities, Omron can achieve customer-specific solutions and modifications with a very short time to market. In fact our customers see

us more as joint developers for their own machinery and plant and as solution providers for their increasingly complex automation requirements, while we see our customers as providing the product ideas and development impetus so vital to our own future. It's a partnership that works very well on both sides.

You too can choose such a partnership. Choose Advanced Technology & Services – choose Omron.

PROVEN APPLICATION EXPERTISE



“We know your industry”

Omron’s in-depth knowledge of many specific industries enables us to offer high-quality products as diverse as the applications they are designed for. You’ll find our components in every sector of manufacturing, including industries as diverse as automotive, ceramics, food, beverage, glass, dyeing, and pharmaceuticals, building automation and public services, and telecom. And our software products are used world-wide in the design, development and control of complex industrial processes.

We even develop cost-effective products for demanding process environments such as metall processing industry and energy production facilities. And in industrial processing applications, where quality control and safety are paramount, Omron has contributed to important improvements in the manufacturing process.



OUR PRODUCTS MAKE THE WORLD GO ROUND



5

"We have touched your life"

Omron's technologies support the way the world lives and works - it is very likely that their effect will have touched your life in some way over the past 24 hours. You'll find Omron automation products everywhere: in coffee vending machines and cash machines, traffic lights and petrol pumps, in hospitals and surgeries – and, of course, in factories all over the world, helping to make the products you use every day.

Whatever industry you are in, Omron can help make you more efficient, more reliable, more competitive and more profitable. Just ask any Omron customer!



Selecting Auto-Identification Functions

Introduction

Selection Guide	6
Introduction	8
Application Examples	23
Safety Precautions	59

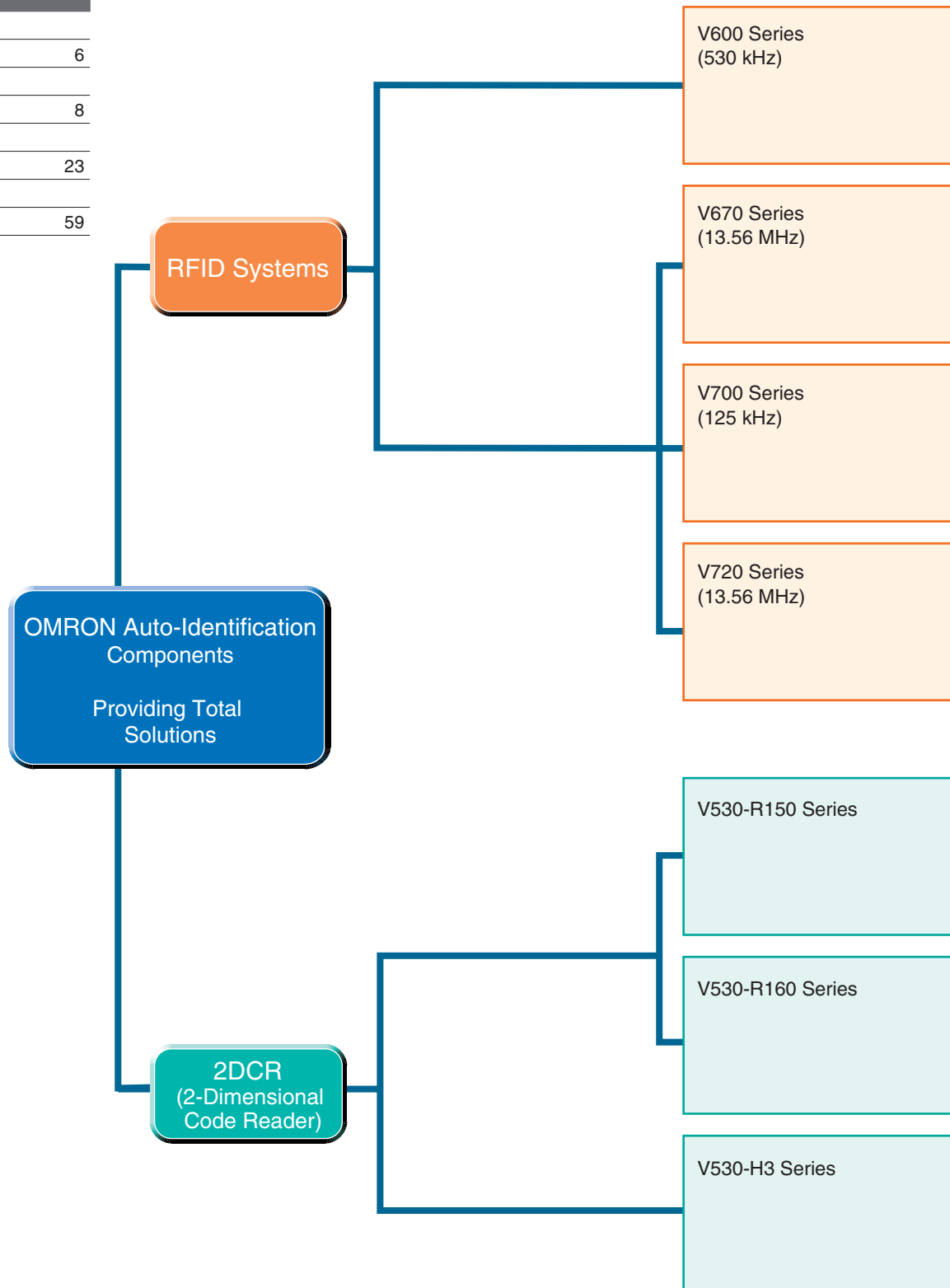

Selecting Auto-Identification Functions



RFID System	V600 Series	A-14
ID Sensor Unit	CJ1W-V600C11/V600C12 CS1W-V600C11/V600C12	NEW A-45
Intelligent Flags I and II	V600-HA Series	A-49
Intelligent Flag III DeviceNet	V600-HAM42-DRT	A-63



High-speed RFID System	V670 Series	A-71
------------------------	-------------	------



RFID System	V700 Series	A-77
CIDRW System	V700 for Semiconductor Industry	NEW A-88

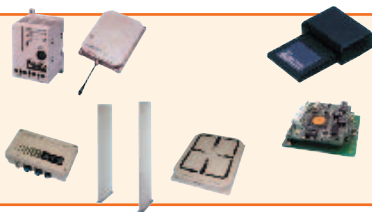

RFID System	V720 Series	A-97
-------------	-------------	------



Fixed Type	V530-R150 Series	B-7
------------	------------------	-----



Fixed Type	V530-R160 Series	NEW B-19
------------	------------------	-----------------



Handheld Type	V530-H3 Series	B-24
---------------	----------------	------

ID Systems -- An Overview

Auto-Identification and Data Capture (AIDC) refers to methods in which equipment, both hardware and software, automatically reads and recognizes data via bar codes, 2-dimensional codes, RFID, fingerprints, voice prints, retinal prints, etc., without the aid of a person. Basically, any system that reads and recognizes "data originating from people or objects" is called an ID system.

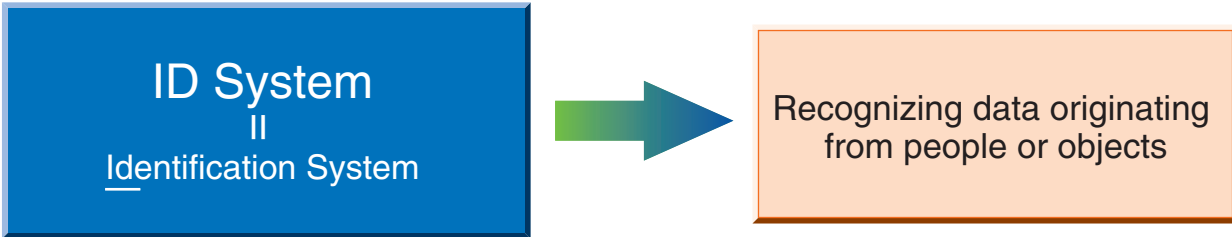

■ Bar Code/2-Dimensional Code Applications



Bar codes are attached to the packaging of many foods and daily commodities and widely used in retail sales, distribution, and the logistics industry to allow various forms of automation. As IT continues to advance, 2-dimensional codes are also finding increasing application in response to the needs for larger data volumes and space-saving.

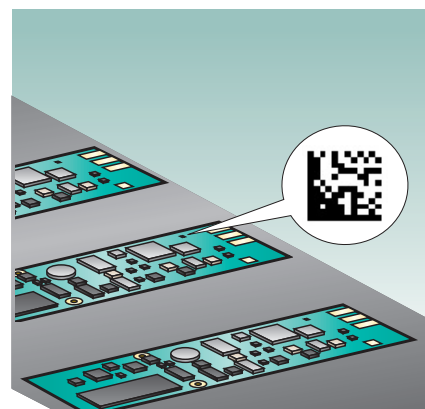

■ RFID Applications

RFID is an acronym for Radio Frequency Identification. An RFID System is a wireless ID system that exchanges data by communicating between a "tag" (or Data Carrier), which is attached to an object or carried by a person, and an antenna (or Reader Writer).

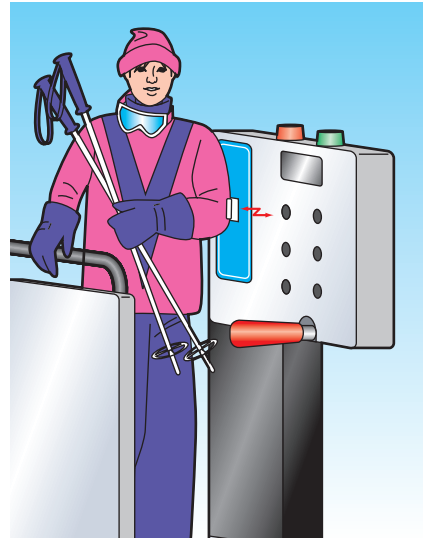
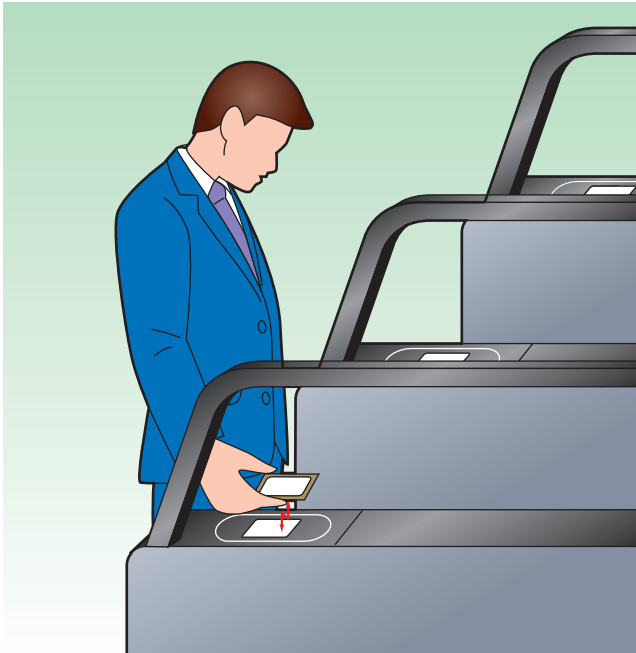

Typical examples include non-contact commuter passes for train station gates, and non-contact ski lift passes. In these examples, the commuter pass and ski lift pass serve as tags, and the station and ski lift gates serve as antennas. Another example which is less obvious is an automatic calculation system in a cafeteria. In this system, a tag is attached to each of the plates and cups, and an antenna is built into the calculation table where the diner places the tray. Such a system makes it possible to automatically display the price of the meal and other information, such as the total calories for the meal.

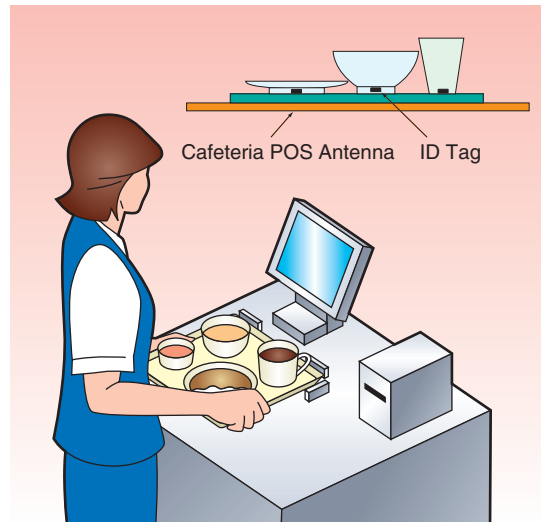

RFID Systems -- An Overview

RFID Systems use electrical and electromagnetic signals for non-contact data reading and writing. They allow data to be read and written without being affected by the material or surface condition of the target object. They can be used over a large communications area, and offer highly reliable communications. Introduction of an RFID System makes it possible to "integrate objects and data" to configure highly flexible and reliable systems.

RFID System → ID system using electrical and electromagnetic signals as a medium

Radio Frequency Identification System

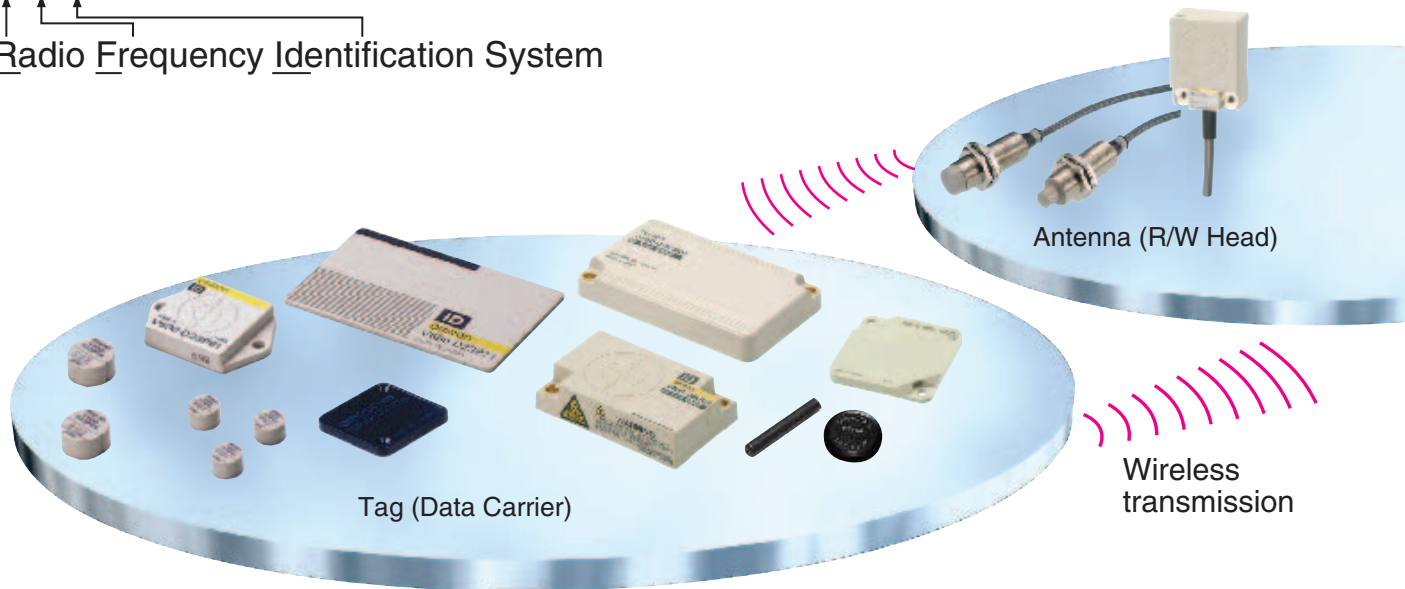

RFID Function Block Diagram

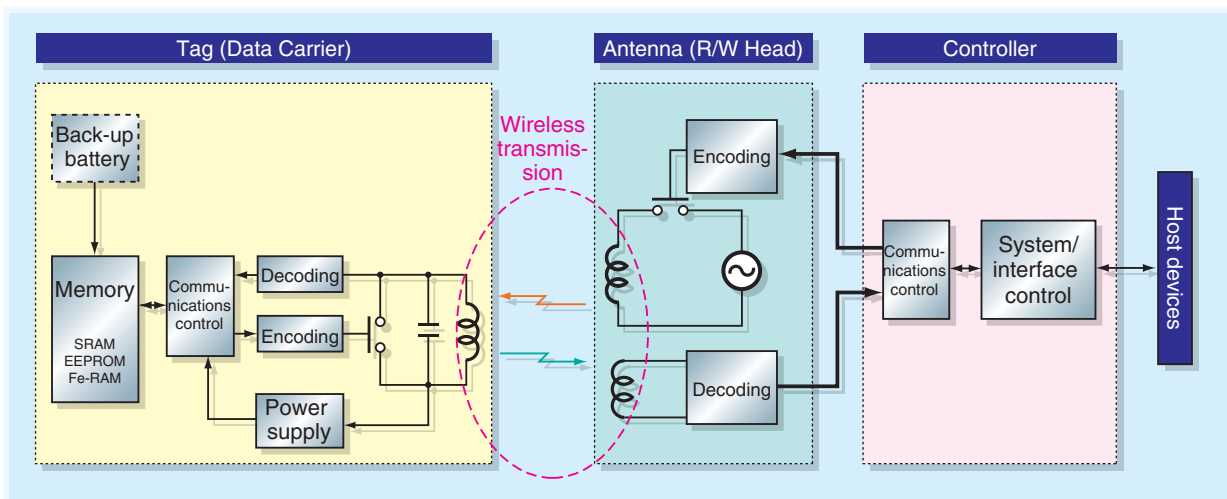

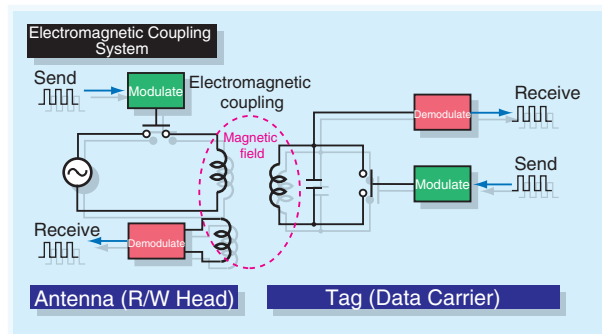
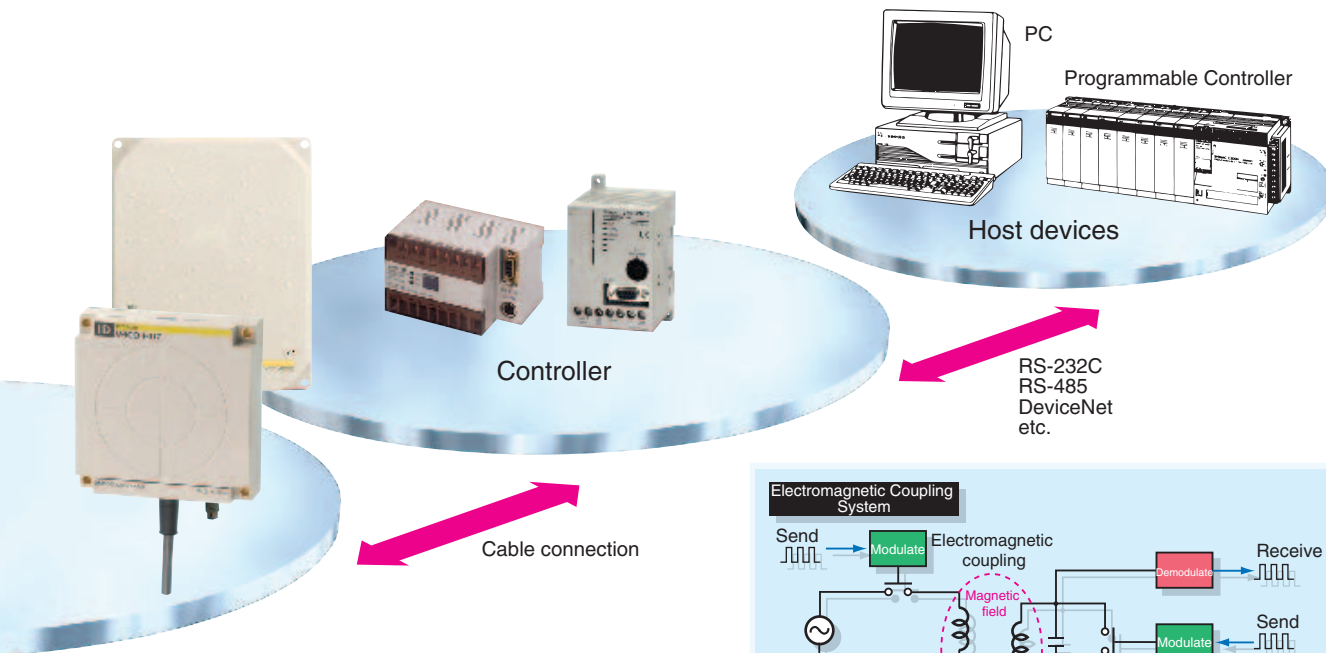

Types of Wireless Transmission

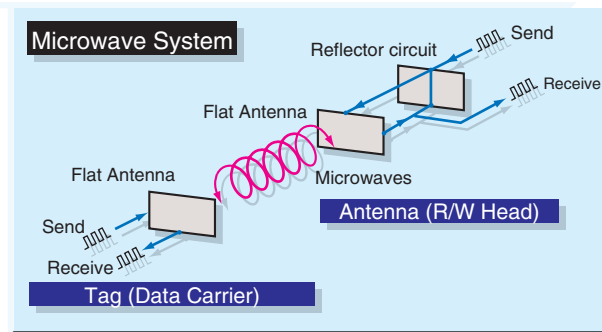
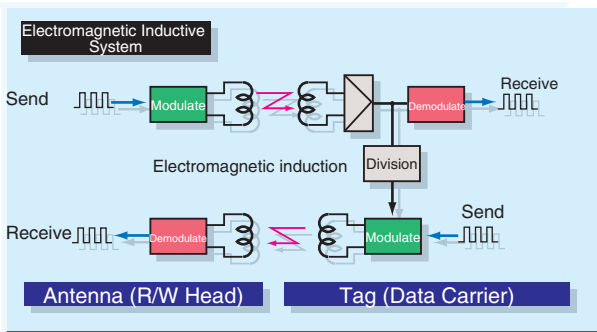

Main RFID System Features

- Non-contact data reading and writing.**
 Tags can store the large amount of data (8,000 bytes max.) that is necessary for production control. The data required for each process (process history, inspection data, etc.) can be overwritten freely and without contact. This promotes paperless production lines, and eliminates several factors that lower yield within each process.
- Integrating objects and data allows highly flexible and reliable systems.**
 Data is distributed to lower the burden on the host system. This cuts system development costs, dramatically speeds up system start-ups, and enables flexibility in making system changes. Integrating objects and data allows accurate, error-free production, process, and quality control. Also, up-to-the-minute data storage enables offline processing in the event of an emergency, to drastically shorten the time required to restore operation.
- Advanced wireless transmission technologies and protocols enable highly reliable communications.**
 Unlike bar codes, in which "1s" and "0s" must be distinguished, the RFID System uses highly advanced wireless transmission technologies and protocols. The transmitted data includes a 16-bit CRC (checksum), and burst error detection for 18 bits or more is 99.9985% min., ensuring highly reliable communications. The system also has no mechanical parts, as there are in raster scanning bar codes, so there is much less chance of a malfunction or other problem.
- Communication by electrical and electromagnetic signals allows reading and writing even with rough positioning and non-visible tags.**
 In contrast with bar codes, the RFID System communicates with electrical and electromagnetic signals. This eliminates the problem of data errors or not being able to read data due to soiling, moisture, oil, etc., on the target object. Communication is not affected by resin, moisture, or other matter, except for metals, positioned between the Antenna and the Tag. Further, because the communications area is relatively large, there is no need for extremely precise positioning of the target object, which reduces both time and cost in mechanical design.

Bar Codes and 2-Dimensional Codes -- An Overview

As defined by ANSI (American National Standards Institute), a bar code is a rectangular code containing information in the form of bars and spaces in various widths in accordance with a predetermined pattern.

Bar codes are commonly used in distribution and logistics. As the use of bar codes continued to spread, demands began for versions that could hold more information and be printed in smaller spaces. Two-dimensional codes were developed in response to this demand. By positioning the data vertically and horizontally, 2-dimensional codes are able to increase the amount and density of the information contained.

■ Bar Code Features

- Widespread Use Facilitates Introduction
- High-speed Processing

■ Main Types of Bar Codes



■ Applications

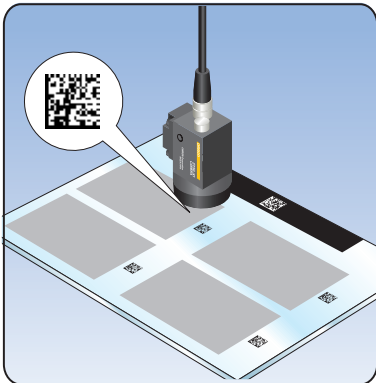

LCD glass substrates

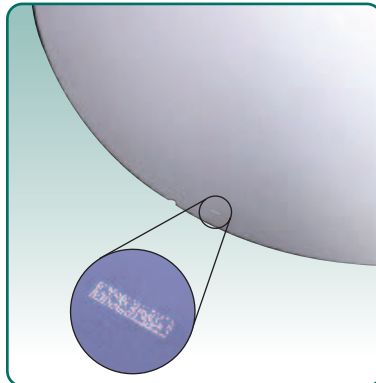

Wafers (Data Matrix T7)

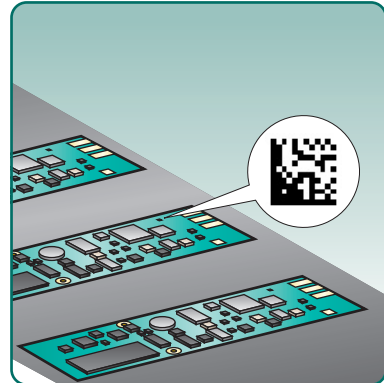

Substrates (Data Matrix)

■ 2-Dimensional Code Features

- **Much Higher Data Density than Bar Codes**
 - The same number of digits can be expressed in 1/10th to 1/100th the space of bar codes due to higher density.
 - Two-dimensional codes can be printed in tiny spaces where bar codes simply will not fit.
- **Large Data Volume**
 - Maximum data volume of 1 KB. This is the equivalent of about 7,000 English characters.
- **Error Correction Function Provides Strong Resistance to Soiling and Scratches**
 - When the code is soiled or damaged, this function makes it possible to restore the read data to the original data.
 - The error correction level can be set when encoding. When set to the maximum level, codes can be restored even when 1/2 or more of the code has been damaged.
- **High Flexibility in Reading Direction and Angle**
 - Using a 2-dimensional CCD scanner, codes can be read from all directions (360°).
 - Work efficiency is increased because the object with the 2-dimensional code can be read from any angle.
- **Data Can Be Printed Directly onto Objects**
 - Using a Laser Marker or similar device, codes can be printed directly onto objects, making it possible to integrate objects and information.

■ Main Types of 2-Dimensional Codes

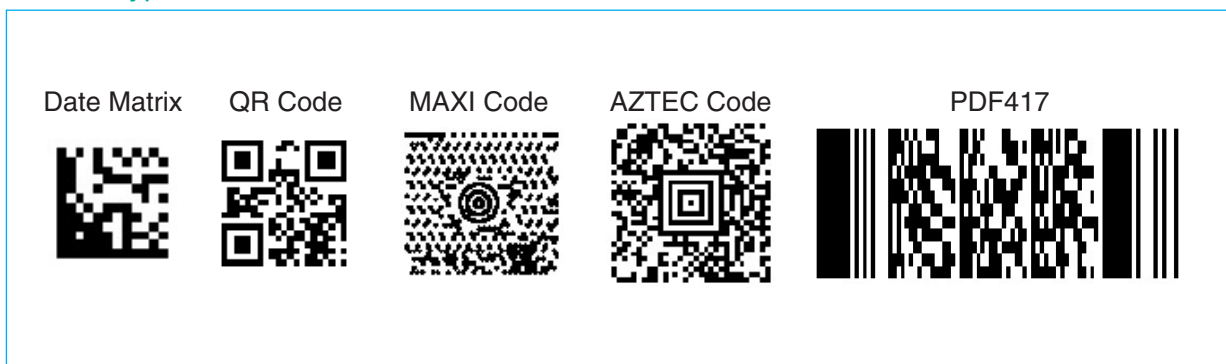

■ Printing Bar Codes and 2-Dimensional Codes

Labelers and printers for printing bar codes or 2-dimensional codes onto labels are widely used in the fields of distribution and logistics. Taking advantage of the error correction function of the 2-Dimensional Code Reader, codes can be directly printed onto objects (such as LCD glass substrates, wafers, electronic components, metallic parts, etc.), thus making it possible to integrate objects and information. This ability allows the use of bar codes and 2-dimensional codes in a wide range of applications that have been considered to be difficult until now. Laser Markers and pin stamping machines are available for use in direct marking for applications such as these.

Objectives for Introducing an RFID System, and Its Effects

One of the main objectives for introducing an RFID System is to raise productivity by "integrating objects and information." Naturally, there are various factors involved in raising productivity, including increasing product yields, shortening lead times, and achieving flexible production control. Two other factors that cannot be ignored are responding to environmental problems and legal regulations.

By writing information into the Tags of an RFID System, it is possible to "integrate objects and information." This will lead to solutions for a variety of factors related to productivity.

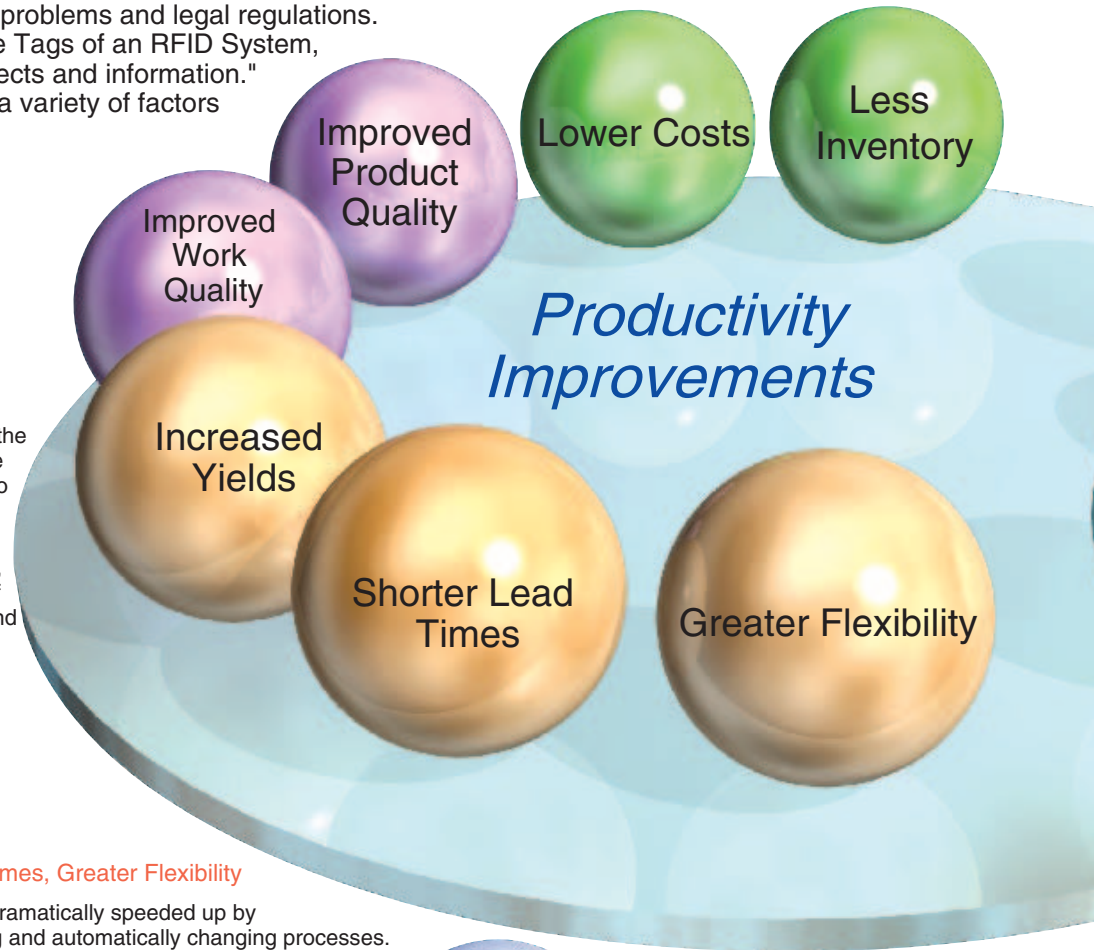

Improving Product Quality and Work Quality

- Human errors can be avoided in production processes.
- When processes are completed, the production process history can be controlled by writing information to an inspection data Tag.
- By controlling the quality-related information (model type, features, etc.) in the Tag, optimal control of each product can be achieved, and products can be exchanged or replaced in mid-process.

Increased Yields, Shorter Lead Times, Greater Flexibility

- Production line changes can be dramatically speeded up by reading the model data in the Tag and automatically changing processes.
- By designing the production line in a series of modules, functions can be expanded or changed by adding or exchanging module units.
- By writing data to the inspection data Tag (simplified data for NG items), adjustments can be quickly processed.

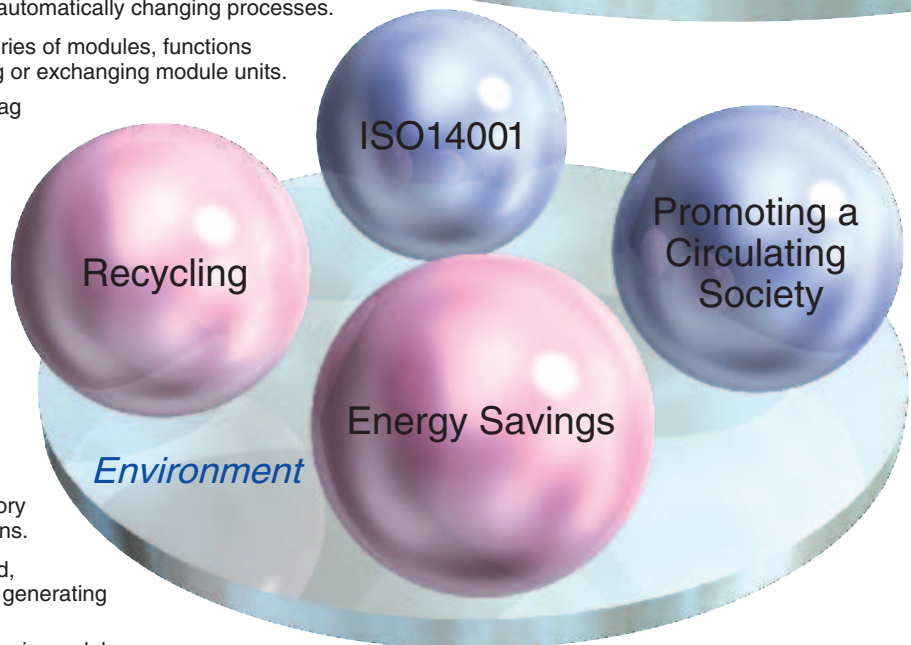

Environment

- Information management by Tag memory can help to achieve paperless operations.
- Tags with read/write capability are used, so a system can be introduced without generating new waste materials.
- The RFID System lets you add functions in module units to your present system, making it easy to utilize existing assets.

Lower Costs, Less Inventory

- It is possible to reduce costs for losses or mistakes due to human errors (mis-reading characters from a sheet of paper, mistakes made when writing information elsewhere, etc.).
- Storing model data onto Tags makes it possible to respond to the diversification of product needs.

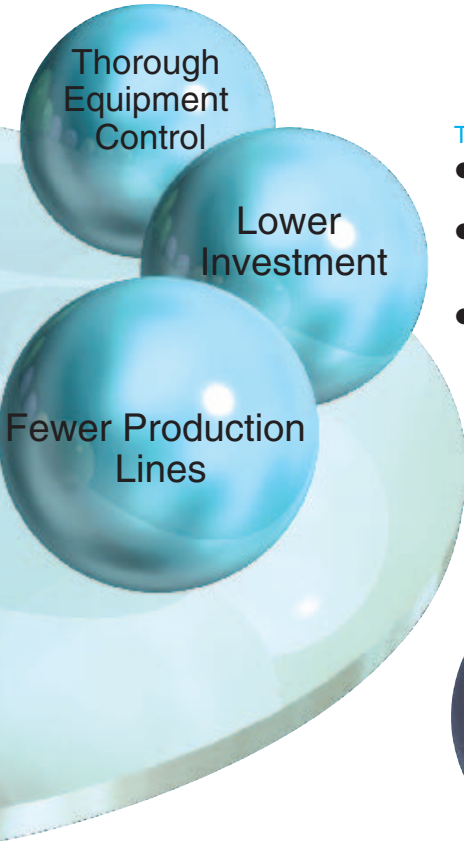

Thorough Equipment Control, Lower Investment, Fewer Production Lines

- Lines can be operated more efficiently by configuring multi-product, mixed lines with switching processes based on quality information.
- The burden on the host computer can be lessened by distributing information, and lines can be started up more quickly (tracking, error handling, and interruption processing can be simplified).
- By managing the number of products remaining, the product history, etc., prior warnings can be issued for maintenance.

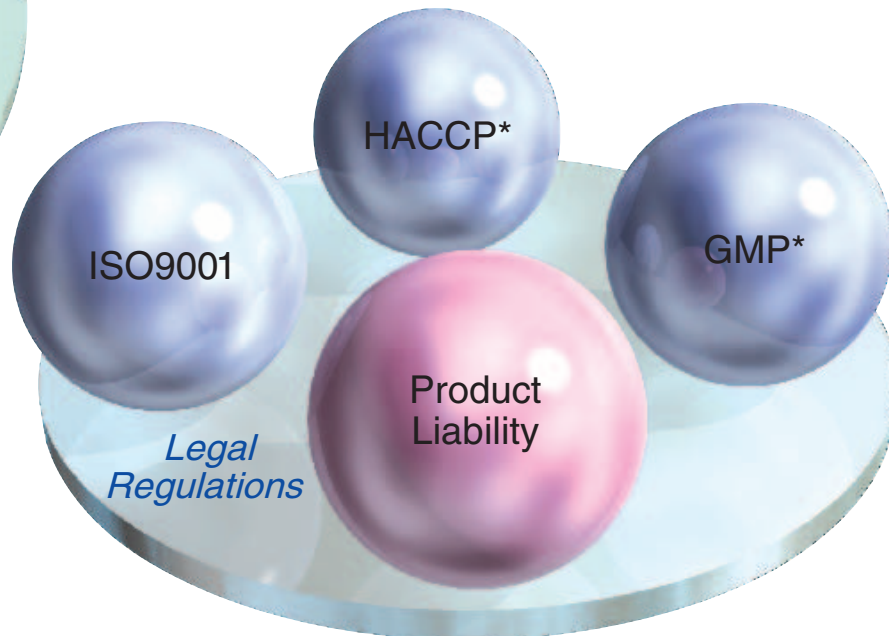

Legal Regulations

- By writing quality information onto Tags, the quality of individual products can be easily controlled.
- Product histories can be automatically controlled without having to newly introduce a high-cost system. new waste materials.
- By using the RFID System to build the automated portion, the personnel, material, and financial burden required to respond to HACCP* and GMP* can be minimized.
- Quality control for individual products can be achieved with quality information.

* HACCP: Hazard Analysis Critical Control Point

* GMP: Good Manufacturing Practice

Direct Marking with a High-precision Laser

Directly marking products with characters or 2-dimensional codes is an extremely effective means of controlling product histories or managing information for QS9000. OMRON refers to this method of furnishing each object with information as, "integrating objects and information." High-density 2-dimensional codes complete with an error correction function are imprinted with a Laser Marker or pin stamping machine, and read by a 2-Dimensional Code Reader.



Product History Management

Read information directly marked onto objects as 2-dimensional codes. Traceability management of key parts is now possible with direct marking and reading even for small parts.

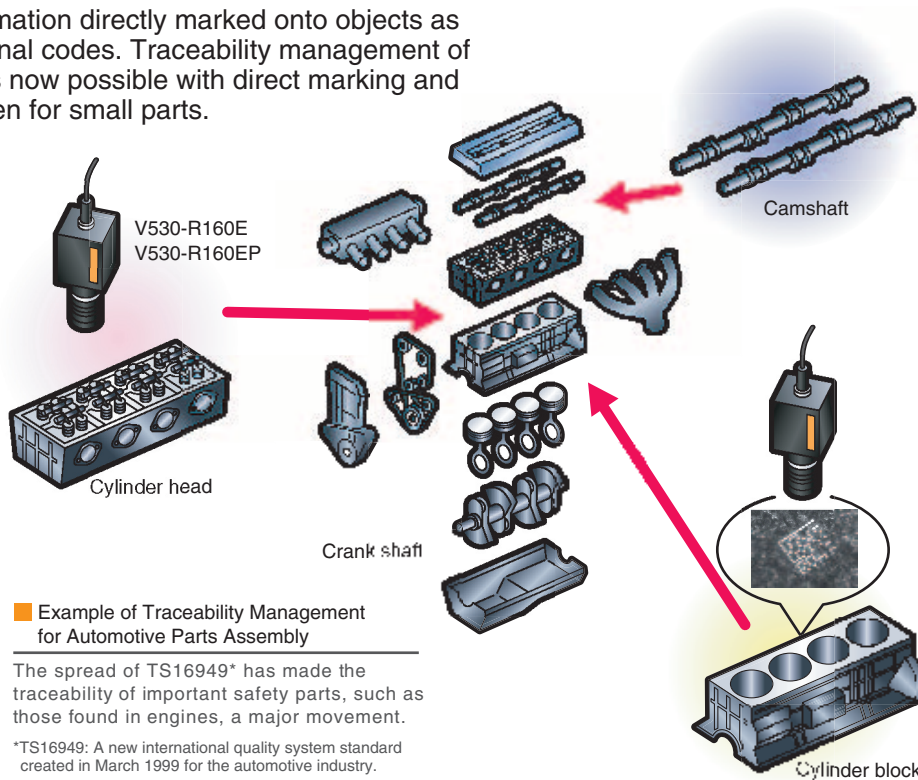



Fixed Type
2-Dimensional Code Reader
V530-R160E/EP

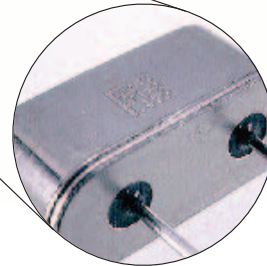
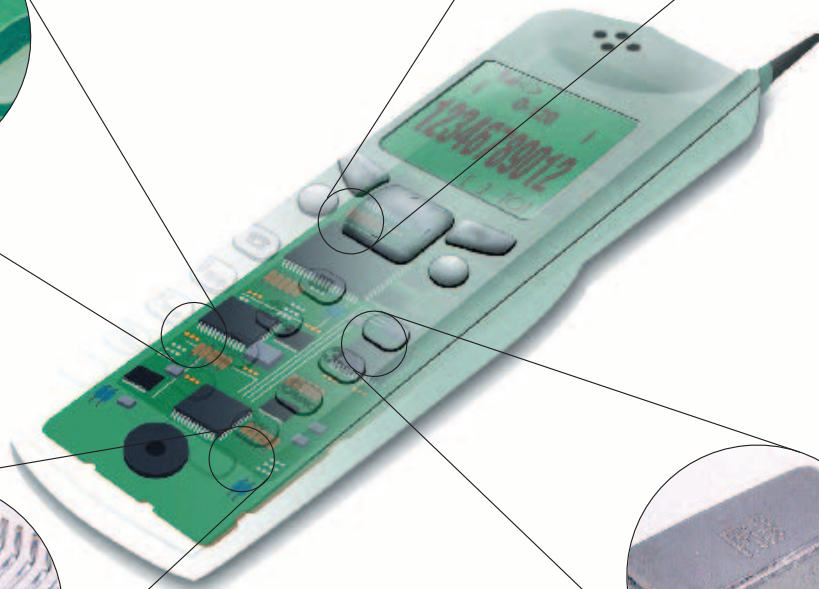
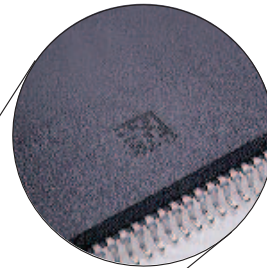
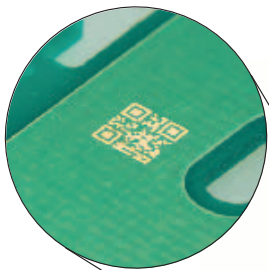

The 2-dimensional codes can be read for a variety of applications by using an Intelligent Light Source and Two-camera Unit.



Fixed Type
2-Dimensional Code Reader
V530-R150E-3/EP-3



Even tiny 2-dimensional codes can be easily read by the Handheld Type 2-Dimensional Code Reader.

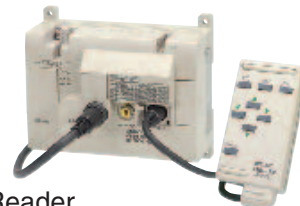

Handheld Type
2-Dimensional Code Reader
V530-H3 Series

OMRON's Total Information Management System

A variety of information management steps are required throughout a product's life cycle, from raw materials to recycling. OMRON offers a complete line of management tools, including Bar Code Readers, 2-Dimensional Code Readers, RFID Systems, and Laser Markers, to provide the most suitable system for each application.

The following shows an example for a sensor assembly plant.

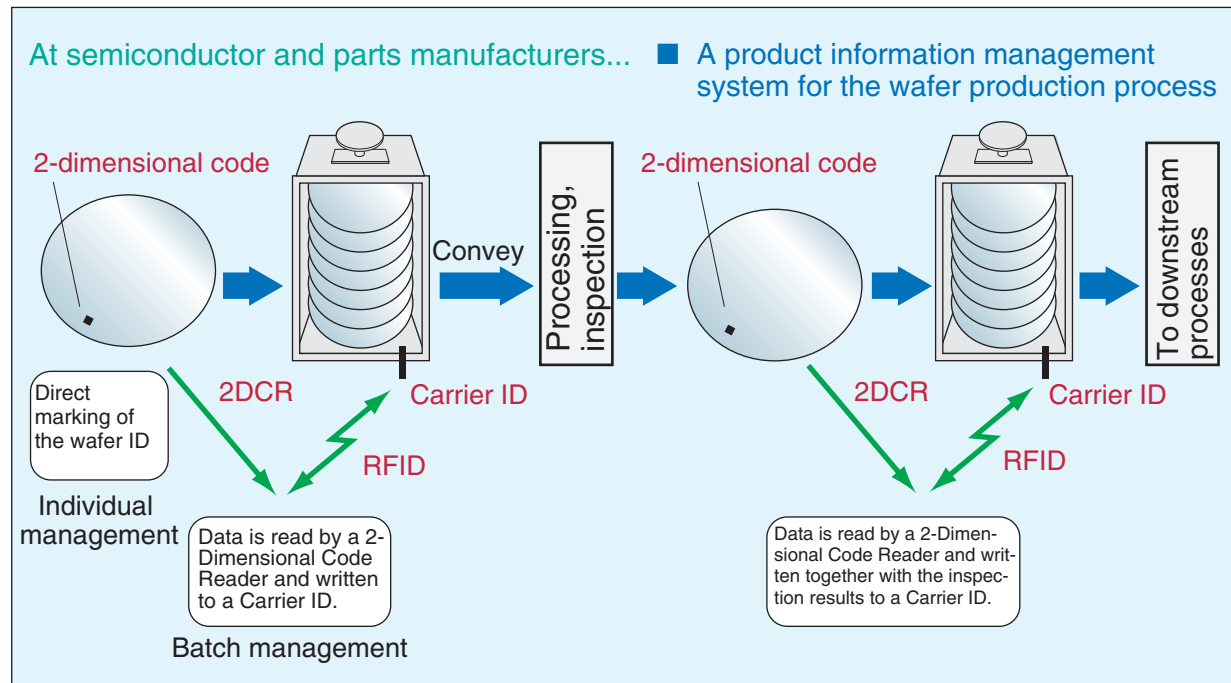
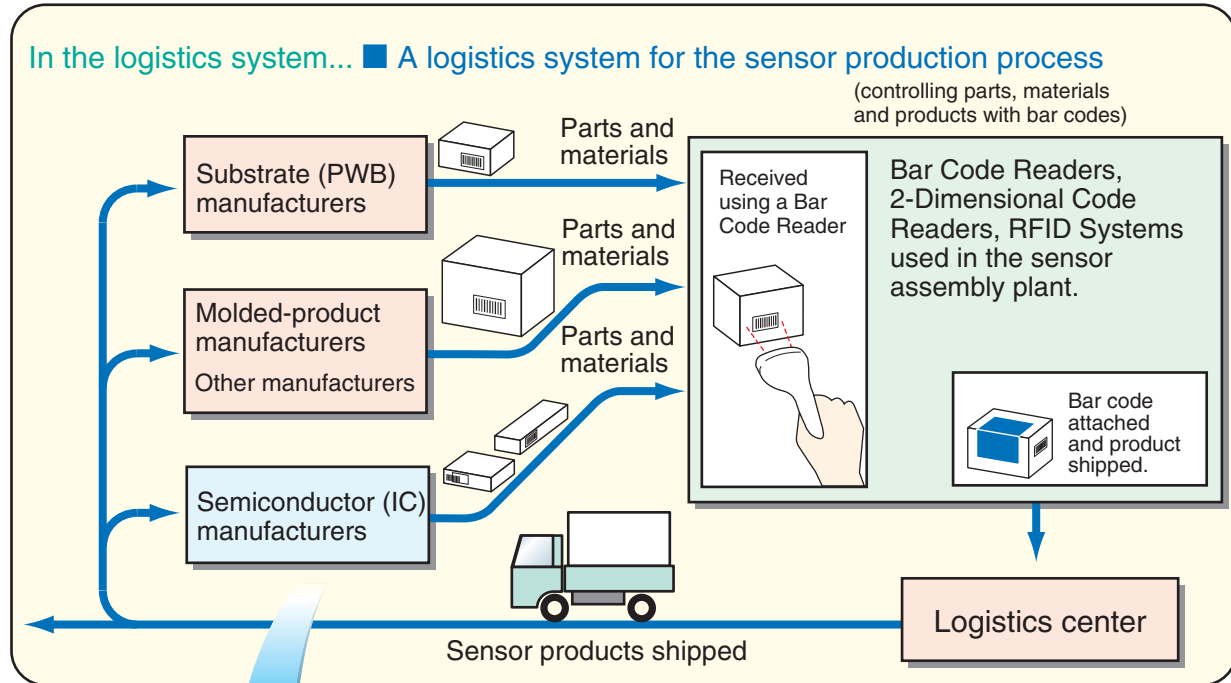

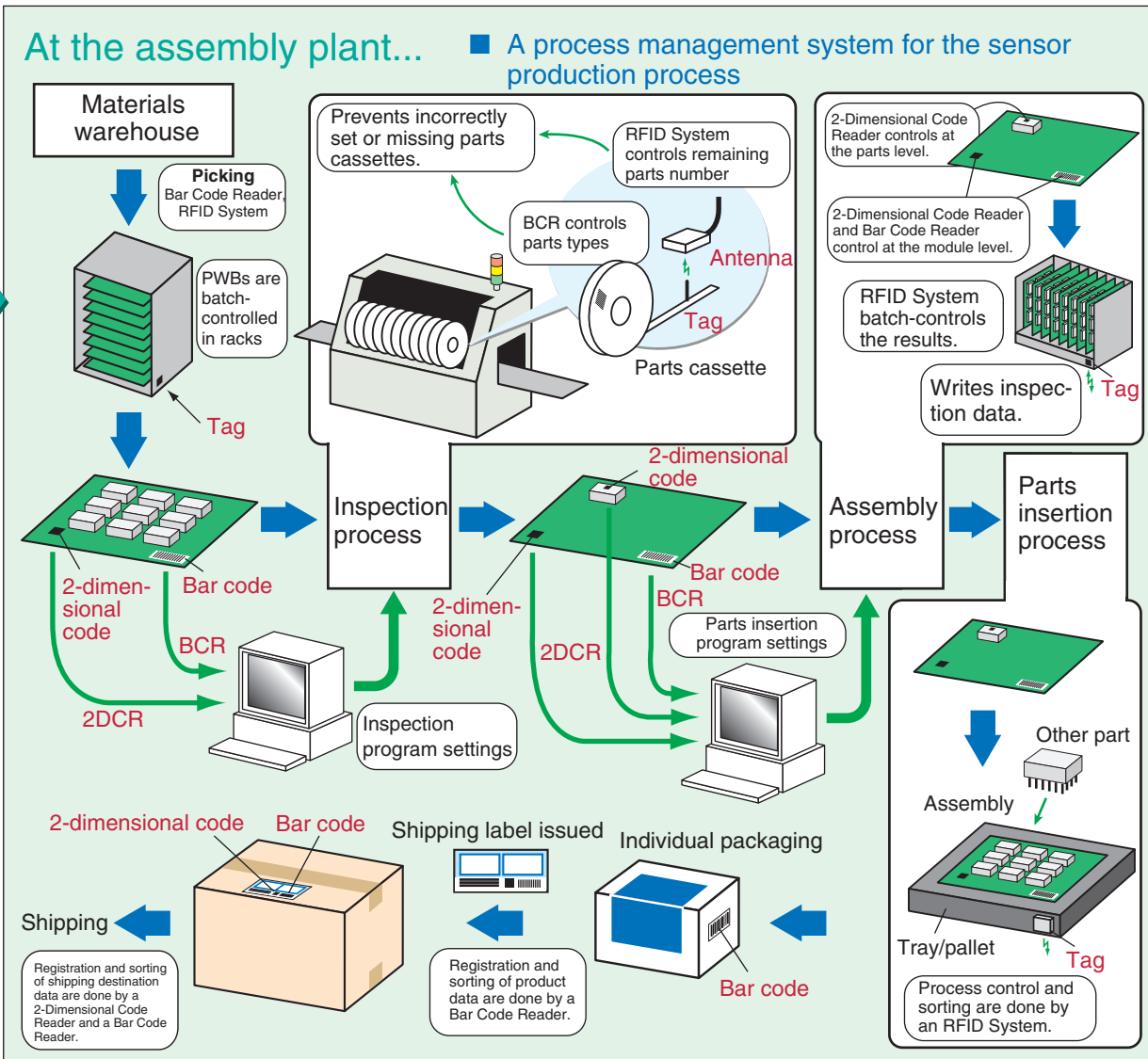

■ Configuring a self-distributed processing system...

When Bar Code Readers, 2-Dimensional Code Readers, and RFID Systems are used to integrate objects and information, information flows more smoothly and the amount of data that needs to be exchanged between the places that need it and the host computer is minimized, thus enabling self-distributed control.

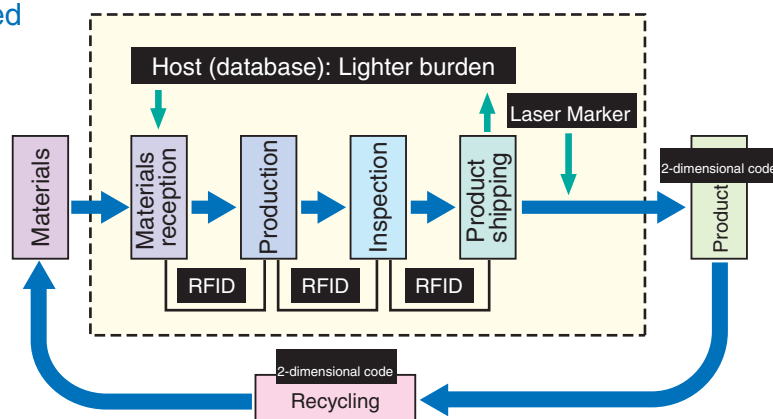

Examples of Equipment Incorporating Auto-Identification Components

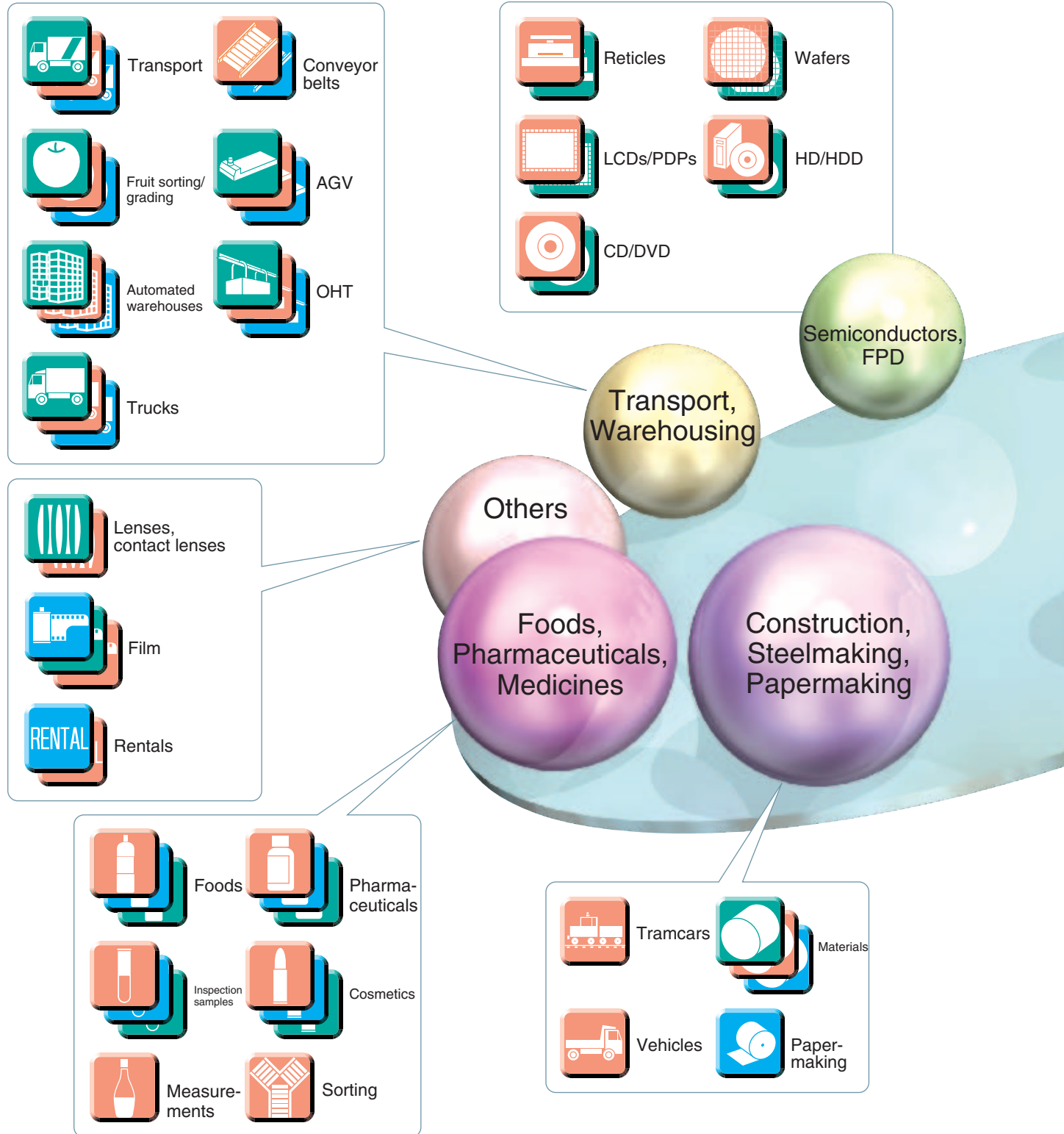

Bar codes and 2-dimensional codes are finding increasingly widespread use in different and specific applications: bar codes when a small number of digits will suffice, and 2-dimensional codes for holding more information. RFID Systems, which optimize the features of "integrating objects and information," are similarly finding a wide range of applications in various industries and fields, working together with both bar codes and 2-dimensional codes. OMRON products help each customer to configure the most suitable system quickly and economically.

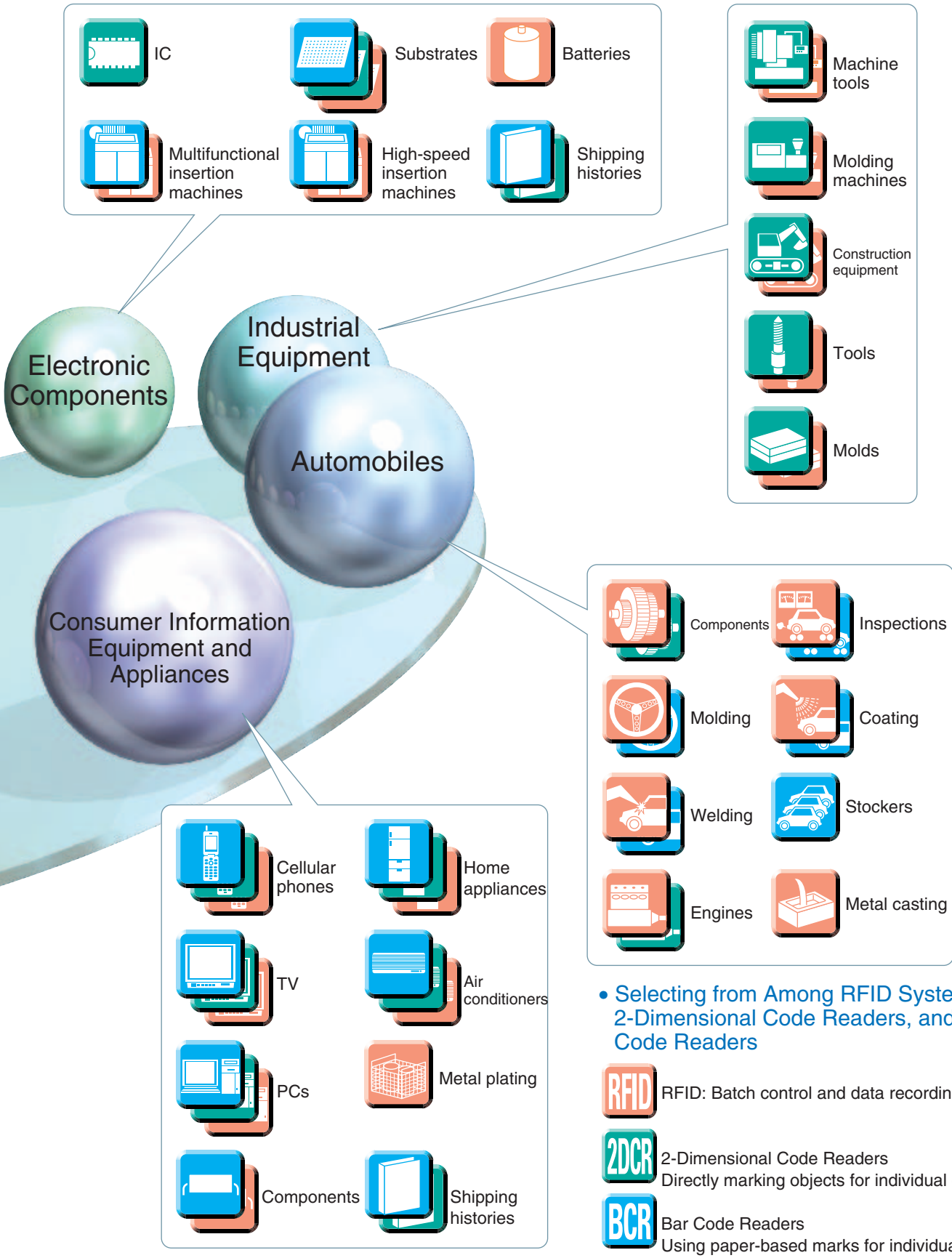

Examples of Equipment Incorporating Auto-Identification Components



• Selecting from Among RFID Systems, 2-Dimensional Code Readers, and Bar Code Readers

-  RFID: Batch control and data recording
-  2-Dimensional Code Readers
Directly marking objects for individual control
-  Bar Code Readers
Using paper-based marks for individual control

MEMO (This page was intentionally left blank.)

A p p l i c a t i o n

Application Examples



Semiconductors and Electronic Components

1. Reticle Control	V700 Series/V530 Series	Page 24
2. Individual Wafer Control	V530 Series	Page 25
3. 300-mm Semiconductor and Wafer Manufacturing Processes	V700 Series	Page 26
4. LCD and Color Filter Manufacturing Control	V600 Series	Page 27
5. LCD Substrate Control	V530 Series	Page 28
6. Batch Control of Parts for Multi-function Mounters	V600 Series/V520 Series	Page 29
7. Control of Parts for High-speed Mounters	V600 Series/V520 Series	Page 30
8. Automatic Recognition and History Management for Molds	V600 Series	Page 31
9. Classifying Secondary Batteries According to Inspection Results	V600 Series/V670 Series	Page 32
10. Hard Disk Manufacturing Processes	V600 Series	Page 33



Home Appliances and Electronics

11. PCB Traceability Control	V530 Series	Page 34
12. PCB Batch Control	V600 Series	Page 35
13. Traceability Control for Manufacturing TVs and Monitors	V600 Series/V530 Series	Page 36
14. Standardizing and Improving the Operating Rate of Production Lines	V600 Series	Page 37
15. Progress Control and History Notification within Processes	V600 Series	Page 38
16. Processing and Assembling CRTs and Displays	V600 Series	Page 39
17. Controlling Carrier Boxes (Components) within Processes	V600 Series	Page 40
18. Lot Control and Condition Control in Plating Processes	V600 Series	Page 41



Automobiles and Industrial Machinery

19. Traceability Control for Important Safety Components	V530 Series	Page 42
20. Automated Pouring in Casting Processes	V600 Series	Page 43
21. Model Discrimination and Process Control for Engine Assembly Lines	V600 Series	Page 44
22. Picking Instructions for Assembly Parts	V600 Series	Page 45
23. Tire Types and Destination Discrimination	V600 Series	Page 46
24. Tool Management for Machining Centers	V600 Series	Page 47



Foodstuffs, Chemicals, and Medical Supplies

25. Automation of Systems for Mixing and Measuring Medicines	V600 Series	Page 48
26. Automatic Inspection and Sorting of Blood Samples	V600 Series	Page 49
27. Automation of Systems for Combining and Measuring Raw Materials	V670 Series	Page 50
28. Quality Control for Food Products	V600 Series	Page 51
29. Filling Inspection for Plastic Containers	V670 Series	Page 52



Conveyance Systems and Warehousing

30. Enhancing Automatic Control of AGVs	V600 Series	Page 53
31. Motion Control for High-speed Conveyor	V670 Series	Page 54
32. Inventory Control for Automated Warehouses	V600 Series	Page 55



Other Applications

33. Management of Rental Machinery	V600 Series	Page 56
34. Fruit Sorting Systems	V600 Series/V670 Series	Page 57
35. Motion Control for Raw Material Transportation Systems	V600 Series	Page 58

Semiconductors and Electronic Components

1. Reticle Control

■ Problem

- There is a growing trend to use localized clean environments as clean rooms. As a result, pod conveyor systems are becoming recognized as necessary for reticle conveyance, an area in which particles are a major concern. The problem is how to make pod control more stable and efficient.
- In response to custom LSI, greater numbers of reticles are used, and effective reticle control has become an important issue.
- It would be an advantage if the reticles stored in pods could be identified from outside.

■ Solution

- Mark the reticles with 2-dimensional codes and read the codes when they come in or out of the stepper.
- Mount ID Tags to the pods containing the reticles. When a reticle come out of the stepper, write the reticle information to the ID Tag mounted to the pod.

■ Benefits

- The internal reticle can be checked and identified by reading the information in the ID Tag mounted to the pod. This means that data exchange via communications between the stepper and the stoker is unnecessary, and allows effective control with a relatively simple system.
- Physical objects (the pods) and information (reticle ID) can be handled together and so there are no tracking errors.
- Using 2-dimensional code for reticle ID makes it possible to control reticles individually.

■ Important Model Features

- The 2-Dimensional Code Reader allows the use of a compact, space-saving Camera.
- Settings for reading 2-dimensional codes can be performed easily using a teaching function.
- The compact (3.9 dia. × 25 mm) V700-D23P41-1 ID Tags have a proven track record in carrier ID for 300-mm FOUP semiconductor systems.
- The V700-HMD11-1 Compact Reader Writer can be installed in locations with tight space restrictions.

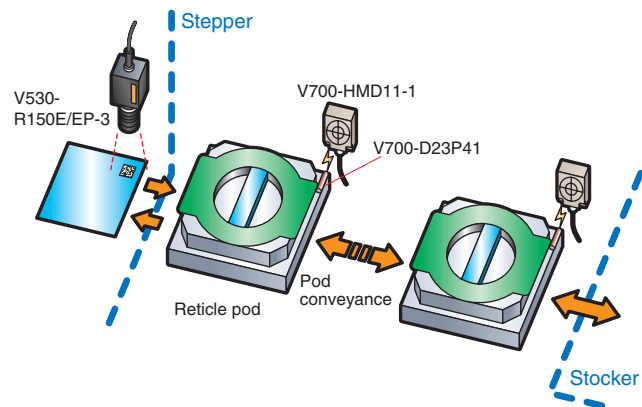

V700 RFID System for Semiconductor Industry
V530-R150E-3/EP-3 Fixed-type 2-dimensional Code Reader

Reference pages

A-88/B-7

2. Individual Wafer Control

■ Problem

- Until now, in the production of DRAM, for example, wafers have usually been processed in lots of 25 (i.e., in wafer carrier units). The switch, however, towards high-diversity, low-volume production (e.g., custom LSI) has made individual wafer control necessary.
- In order to avoid reducing the number of IC chips produced per wafer, the markings used for individual wafer control must be as small as possible.

■ Solution

- Mark the back surface of each wafer with wafer ID (2-dimensional code) satisfying the specifications of the SEMI T7 standards using a laser marker. (The surface can be marked with a wafer ID consisting of 13 alphanumeric characters in an area of 4×1 mm.)
- When the wafers are introduced into the processing equipment, read the wafer ID (2-dimensional code) with a 2-Dimensional Code Reader and send the information to the equipment.

■ Benefits

- Wafer ID can be managed wafer-by-wafer, instead of the lot management used until now. Individual wafer control will also help to increase traceability and lead to improvements in quality.

■ Important Model Features

- The 2-Dimensional Code Reader allows the use of a compact, space-saving Camera.
- Settings for reading 2-dimensional codes can be performed easily using a teaching function.
- Codes specified by SEMI T7 standards can be read.

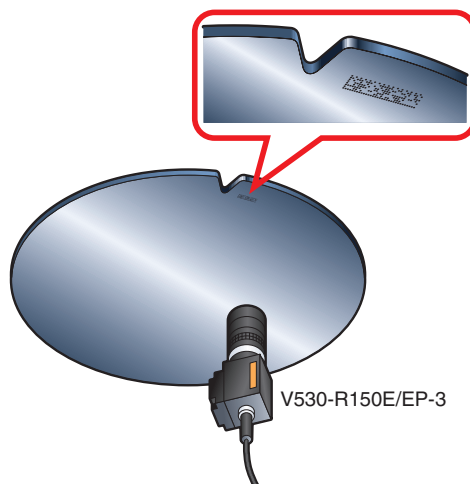

V530-R150E/EP-3

V530-R150E-3/EP-3 Fixed-type 2-dimensional Code Reader

Reference pages

B-7

3. 300-mm Semiconductor and Wafer Manufacturing Processes

■ Problem

- In order to fit into the limited space inside load ports, special, complex bar code readers with mirrors are used. This, however, makes it difficult to achieve a reading rate of 100%. Also, carrier cleaning can result in bar code deterioration and drops of water on the surface, increasing the likelihood of reading errors.
- Systems using bar codes that operate by carrier number control only can easily become complicated.
- Conformance to SEMI 300 mm standards is desirable.

■ Solution

- Storing work instructions and information (e.g., product information, process instructions and information, process completion information, lot information, and inspection results) in the carrier ID (ID Tags) mounted to the carriers (FOUP) enables distributed management of the necessary information.
- Mount ID Tags, which have high environment resistance (i.e., resistant to water, ultrasonic cleaning, and chemicals, with a long life expectancy) and high reading/writing reliability, to the carriers (FOUP).
- Use a CIDRW Controller that conforms to SECS I/II.

■ Benefits

- Unlike production control systems that uses bar codes, repeated exchanges with the host are not necessary, allowing for a simpler production program and system.
- The read/write reliability is high and so problems such as line stoppages due to errors can be avoided.
- Replacing bar code labels and other similar kinds of maintenance are not required, enabling reductions in running costs.
- Conformance to SECS I/II (SEMI E4 and E5) can be achieved easily (V700-L21).
- Conformance to SEMI E15.1 ensures easy mounting to the load port.

■ Important Model Features

- The V700 Series (V700-HMD13A, V700-L11, and V700-L21) conforms to SEMI standards (SEMI E15.1, E4, E5, and E99).
- The V700-D23P41-1 Tags have high environment resistance, allowing cleaning in pure water, IPA cleaning, ultrasonic cleaning, and use in vacuums.
- Lineup includes the V700-HMD11-1 Antenna for stockers and reticles and the V700-CH1D Handheld Reader Writer.

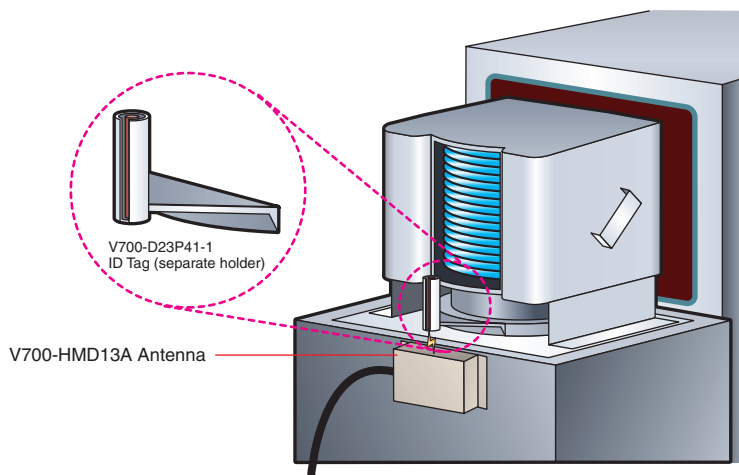

V700-HMD13A/HMD11-1/D23P41-1 RFID System
V700-CH1D RFID System

* Load port: Performs loading/unloading of the wafer to and from the FOUP.

Reference pages

A-88

4. LCD and Color Filter Manufacturing Control

■ Problem

- Mid-process replacement of LCDs in bar code cassette control systems necessitates frequent exchanges with the host system. This requires a complex system and program that are very difficult to change.
- IPA cleaning can result in bar code deterioration and drops of water on the surface, increasing the likelihood of reading errors.

■ Solution

- Store work instructions and information (e.g., product information, process instructions and information, process completion information, substrate information, and inspection results) in the ID Tags mounted to the cassettes to enable distributed management of the necessary information.
- Mount ID Tags, which have high environment resistance (i.e., resistant to water and chemicals, with a long life expectancy) and high reading/writing reliability, to the cassettes.

■ Benefits

- Unlike production control systems that use bar codes, repeated exchanges with the host are not necessary, and production is possible based on the information in the Data Carriers (ID Tags). This makes for a simpler production program and system.
- The read/write reliability is high and so problems such as line stoppages due to errors can be avoided.
- RFID uses non-contact communications and so there are no particles, contributing to a higher yield rate.
- Replacing bar code labels and other similar kinds of maintenance are not required, enabling reductions in running costs.

■ Important Model Features

- Used in FPD plants around the world with impressive results.
- High resistance to the environment, noise, and chemicals, allowing cleaning in pure water, IPA cleaning, ultrasonic cleaning, exposure to temperatures up to 150°C, and use in vacuums.
- Substantial information capacity of up to 8 Kbytes.

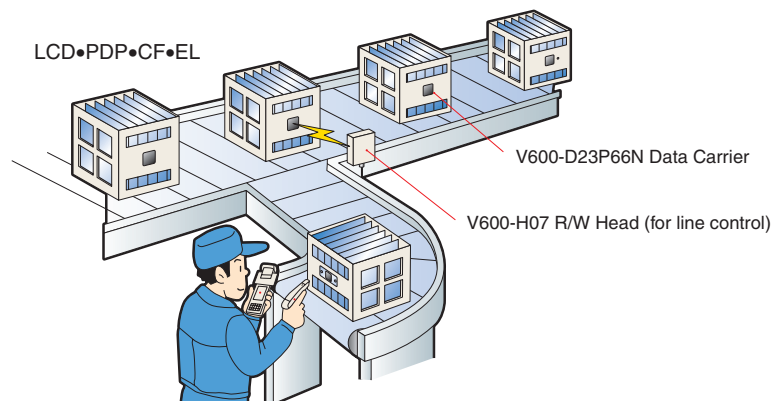

V600-series RFID System

Reference pages
A-14

5. LCD Substrate Control

■ Problem

- When using cassettes for LCD substrate conveyance with cassette control performed by assigning RFID to the cassettes, depending on the process, LCD replacement can result in inconsistencies between the control information for the LCD substrates and the cassettes.

■ Solution

- Convert product information and lot information to 2-dimensional code, mark the LCD substrates with the code directly using a photolithography machine or a laser marker, and read the 2-dimensional code at each process.

■ Benefits

- LCD substrates can be controlled individually. They can also be controlled when they are taken out of the cassettes.
- Cassette control information can be corrected without any exchanges with the host system.

■ Important Model Features

- In readjustment processes and human-operated conveyor lines, Handheld-type 2-Dimensional Code Readers are more effective than the Fixed-type Readers.
 - The V530-R150E/EP-3 Fixed-type 2-Dimensional Code Reader is more effective with automated lines as it allows the use of a compact Camera that can be mounted in almost any location. It can be used for a variety of different workpieces, code sizes, and reading distances by changing the lens and lighting as appropriate.
- * RFID (V600 Series) is ideal for cassette control (batch control of LCD substrates).

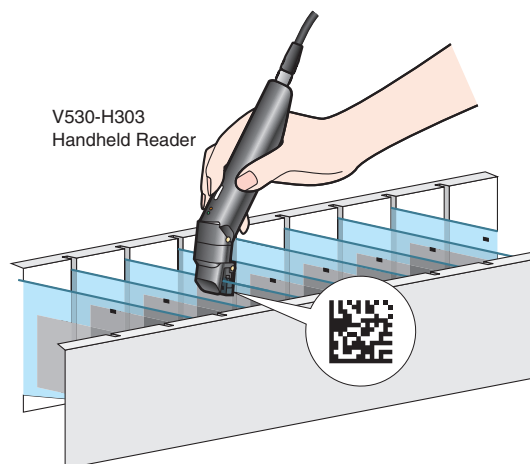

V530-H3 Series
Handheld 2-Dimensional Code Reader

Reference pages

B-24

6. Batch Control of Parts for Multi-function Mounters

■ Problem

- Parts are controlled using instruction sheets and so incorrect placement can occur due to human error when mounting cassettes to cassette racks. With multi-function mounters, this can result in considerable financial loss because of the large number of high-performance parts.
- Parts are sometimes incorrectly mounted because they look the same as other parts.

■ Solution

- Write the part information (e.g., part number, part name, and quantity - written in the bar code on the part reel) and the part position information to a Data Carrier mounted to the cassette rack. At the same time, mount the cassette at the specified position on the cassette rack.
- When mounting the cassette rack to the mounter, read all the cassette information and position information stored in the Data Carrier (ID Tag) with an R/W Head that is mounted to the mounter, and compare it with the mounting program.

■ Benefits

- Agreement between the parts that should be mounted to the cassette rack and the parts actually required in the program can be reliably confirmed. This means that errors can be prevented, and financial losses can be reduced significantly.
- Changes in the combinations of cassettes mounted to the cassette rack can be handled simply by rewriting the information in the Data Carriers (ID Tags).

■ Important Model Features

- With a capacity of 2 Kbytes, ID Tags can store much more information than bar codes.
- Battery replacement is possible for the ID Tags (life expectancy: 2 years).

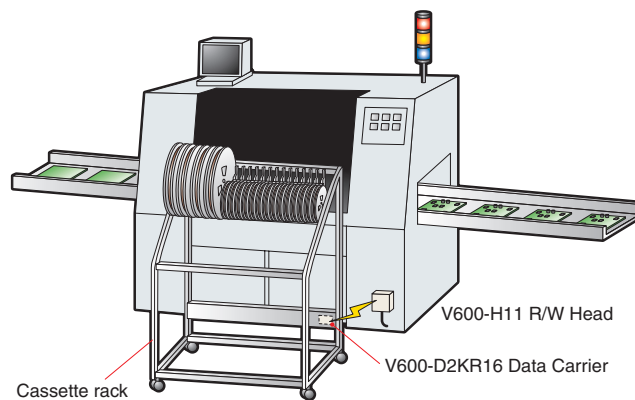

Reference pages

A-14

V600-series RFID System

7. Control of Parts for High-speed Mounters

■ Problem

- Control is based on instruction sheets and so human error can occur when cassettes are mounted to the mounter. Also, in order to prevent errors, multiple reading is used. This means that work efficiency is low and personnel expenses are high.
- The remaining number of parts is ascertained, in cassette units, using paper and the human eye. This is insufficient for effective control and leads to large stock losses. In particular, stock inventory is not possible unless the line is stopped for several days.
- The parts mounted to the mounter are insufficient and there are frequent mounter stoppages due to missing parts.

■ Solution

- Read the part information (e.g., part number, part name, and quantity) written in the bar code on the part reel, and write the information to the Data Carrier (ID Tag) mounted to the cassette.
- After mounting the cassette to the mounter, automatically read the cassette information, check the part information and remaining quantity, and perform verification with the mounting program. Use an alarm to provide notification of cassette mounting errors and insufficiencies in remaining parts.
- After the mounting process is completed, write the latest information on the number of remaining parts, based on the mounter's data, to the Data Carrier.

■ Benefits

- Cassette mounting errors are prevented and the type of operation can be switching efficiently.
- Control of the remaining number of parts enables part insufficiencies to be predicted before mounting. This means that the line can operate without stoppages.
- Stock inventory can be carried out by reading the Data Carrier information from the cassettes in the stocker.
- Quality control of the cassettes themselves can be performed by storing information about the part mounting rate in the Data Carriers.

■ Important Model Features

- The ID Tags have compact dimensions of 8 dia. × 5 mm and can be mounted to cassettes.
- High environment resistance (resistance to shocks and vibration).
- The ID Tags have a much larger information capacity than bar codes and can be written to.

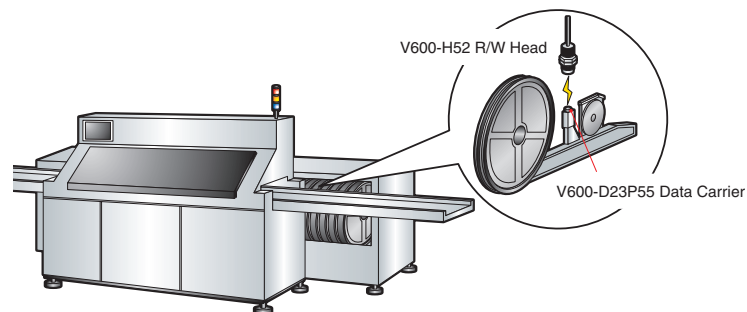

Reference pages

A-14

V600-series RFID System

8. Automatic Recognition and History Management for Molds

■ Problem

- Mold names can be written on pieces of paper attached to the molds or directly onto the molds with marker pen. If the pieces of paper peel off or the lettering becomes faint, however, the molds cannot be identified.
- The shot times and shot count for each mold are not recorded and so quality control for the molds is insufficient. Deterioration in molding performance is not discovered until a large number of defective products are produced.
- When working with instruction sheets, preparation time is required to input the product number into the molding machine and download the molding conditions from the host computer via communications.

■ Solution

- Store information such as mold ID information, shot count, date of first use, and molding conditions to a Data Carrier (ID Tag) mounted to the mold.
- Read the mold ID information and molding conditions from the Data Carrier using an ID Antenna mounted to the molding machine. At the same time, read the shot count, and check that the mold is within its service life specifications.
- After the molding process is completed, write information (e.g., shot count) from the molding machine to the Data Carrier.

■ Benefits

- The mold itself carries the necessary information. This enables reliable management and a reduction in the time required to switch to different types of operation.
- Even if a mold is mounted incorrectly, the molds are checked automatically and so problems can be discovered before defective products are created.
- The accumulated shot time and shot count, which are directly related to the quality of the mold, can be managed simply. This means that the creation of defective products resulting from poor mold quality can be avoided.

■ Important Model Features

- High noise resistance enables stable communications in FA (Factory Automation) environments.
- The storage temperature specification for the Data Carrier is 150°C (302°F) but a special holder (V600-A86) allows them to be used with molds at temperatures of up to 180°C (352°F).

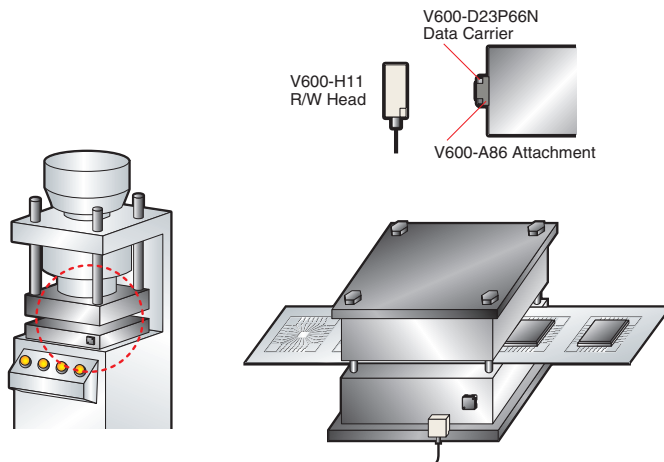

V600-series RFID System

Reference pages

A-14

9. Classifying Secondary Batteries According to Inspection Results

■ Problem

- The high diversity of clients and the large number of models and types makes the control of secondary batteries used in cellular phones and PDA terminals very difficult. In charge/discharge inspection processes, where several to hundreds of batteries are put in special pallets and inspected at the same time, the problem is how to classify the batteries efficiently based on the results.
- In order to improve productivity and increase profits, the yield rate must be raised, and this necessitates stringent control. A way of accurately keeping track of processes is required.

■ Solution

- Mount ID Tags to the pallets holding the secondary batteries for charge/discharge inspection. Write product information, lot information, and inspection conditions for each lot to the ID Tags. Change the inspection process according to this information. In addition, store process completion flags and instructions for the next process to enable process history management.
- When the charge/discharge inspection is finished, write classification information based on the inspection results to the ID Tags. ID Tag memory capacity is limited and so associate addresses in memory with the locations of the batteries in the pallets beforehand.
- To classify the batteries, read the classification information stored in the ID Tags, and perform sorting (automatically) with a robot.

■ Benefits

- Compared to systems where bar code labels are attached to pallets and control is performed from the host, because the pallets themselves hold product information and take this with them through the process, the system can operate with greater stability and efficiency (contributing to ISO9000).
- After charge/discharge inspection, simple, stable, and efficient classification is possible with just the ID Tag information. Also, the information is centralized, allowing switching between different types of operation without errors, even when there is a large variety of models.
- The ID Tags hold process history information. This makes it possible to keep track of progress and delivery dates, and makes it easy to deal with problems when they occur in the process.

■ Important Model Features

- It is possible to read or write 128 bytes of information in just 12 ms. The V670 Series significantly increases the efficiency of sorting after inspection.
- The ID Tags are equipped with Fe-RAM memory, eliminating the need to consider the number of writing operations (i.e., the service life), which can be a problem when reusing limited numbers of pallets.
- High noise resistance enables stable communications in FA environments.
- The V600 Series includes a compact Data Carrier and so it can be used for individual control in electrode assembly and clysis processes.

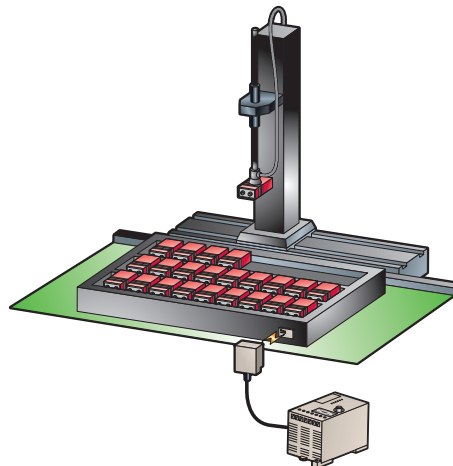

V600-series RFID System
V670-series RFID System

Reference pages
A-14/A-71

10. Hard Disk Manufacturing Processes

■ Problem

- The capacities of hard disks used in computers are becoming larger and more diverse. Also, the range of compact, high-capacity hard disks for laptop computers is expanding, and the need for control and traceability in manufacturing processes is becoming greater. For this reason, the load on the host in production control systems based on bar codes and paper is becoming greater and an alternative is required.
- The environment for some processes is very severe, resulting in reading errors with systems based on bar codes. A way of ensuring more stable process control is needed.

■ Solution

- Mount Data Carriers (ID Tags) to special cassettes that contain (several dozen) disks. Write product information, lot information, work instructions for each process, process completion flags, and instructions for the next process to the Data Carriers.
- In each process, read the information from the Data Carriers using R/W Heads mounted to the machinery, and perform processing or inspection based on this information. For inspection processes, write the inspection results (i.e., OK or NG) to the Data Carriers.
- At the end of each process, write instructions relating to process completion flags and the next process as appropriate.
- At the final process, read all the information in the Data Carriers, and store it in the host for lot control.

■ Benefits

- Using a highly environment-resistant RFID System enables stable monitoring of lot information and process information, allowing the creation of accurate, error-free automated lines. In particular, the RFID System contributes greatly to increasing yield rates, which, in a climate of intense competition to reduce costs, is an important factor in ensuring profits.
- Writing history information for each process ensures traceability within the process without placing an undue burden on the host. This leads to improvements in quality control (contributing to ISO9000).

■ Important Model Features

- The V600 Series has environment-resistant specifications (e.g., resistance to chemicals, water, vibrations, shock, and noise) that enable stable operation in severe conditions.
- The information capacity of 254 bytes is significantly greater than that of bar codes.
- Battery-less Data Carriers eliminate the need for maintenance. EEPROM models boast an industry-leading figure of 400,000 (at 25°C, 77°F) for the number of rewrites.
- The V600-D23P55 Data Carriers have compact dimensions of 8 dia. × 5 mm, making it possible to embed them in the compact cassettes carrying the disks. (Data Carriers are mounted to the cassettes with the cooperation of the cassette manufacturer.)

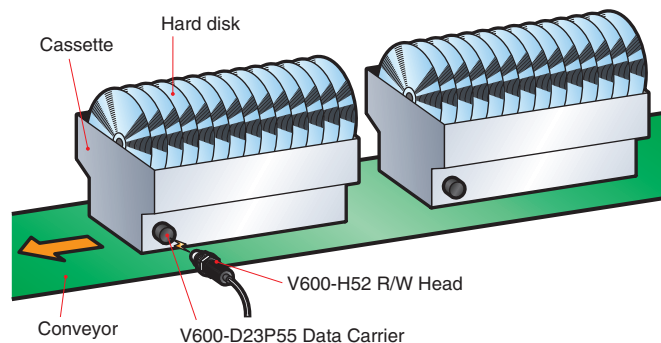

V600-series RFID System
 ID Sensor Unit
 CJ1W-V600C11/V600C12
 CS1W-V600C11/V600C12

Reference pages
 A-14/A-45

Home Appliances

11. PCB Traceability Control

■ Problem

- There is a need to control the production history and inspection data of PCBs used in cellular phones, PDAs, and similar products, but conventional bar codes are too large to print onto the small boards.
- Traceability is assuming increasing importance. Problems result when the codes disappear or peel off after shipping.
- The introduction of cell production systems calls for handheld readers.

■ Solution

- Use direct laser marking of small, 2-dimensional codes of about 4×4 mm for PCBs (with codes containing model number, lot number, production history, inspection data, etc.).
- Handheld readers can be used in cell production systems, allowing the PCB data to be read in 2-dimensional codes.

■ Benefits

- The production history and inspection data can be controlled for each, individual board.
- If a problem should occur in a production or inspection process, the production history and inspection data can be quickly compared by reading the 2-dimensional codes. Traceability is also possible if a problem should occur in the market.

■ Important Model Features

- The 2-Dimensional Code Reader allows the use of a compact, space-saving Camera.
- Settings for reading 2-dimensional codes can be performed easily using a teaching function.
- The V530-H3-series Handheld 2-Dimensional Code Reader can read 2-dimensional codes as small as approximately 0.7×0.7 mm.

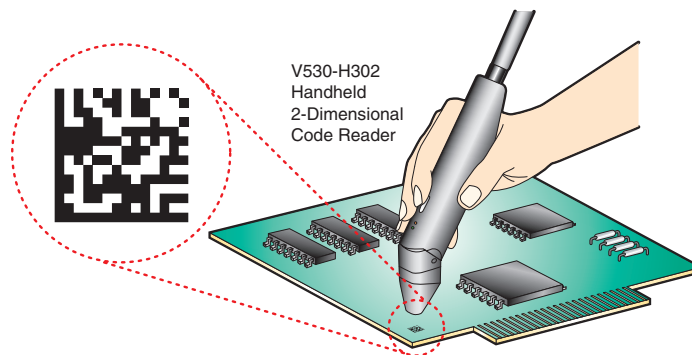

V530-H3 Series
Handheld 2-Dimensional Code Reader

Reference pages

B-24

12. PCB Batch Control

■ Problem

- Using bar codes attached to magazine racks, as well as paper-based instructions, for switching production processes during PCB mounting causes mistakes in switching operations and requires considerable time.
- Operators manually fill out check sheets with mounting history data for process control, leading to mistakes in writing and tabulation.
- Control at a host PC is difficult because different PCBs are inserted into racks at the loader and unloader. It is also not possible to cope with urgent items or interrupt items, which cause confusion in the process and dramatically lower productivity.

■ Solution

- Mount a Data Carrier (ID Tag) to the magazine rack, use it to store the PCB data (lot number, board size, number of boards, etc.), then switch processes during mounting based on the Data Carrier data.
- When mounting is finished, write completion data and mounted PCB data to the magazine rack Data Carrier.
- Also write the result (OK/NG) of the inspection process to the Data Carrier, and feed NG products back to the repair line.

■ Benefits

- Mistakes are eliminated in process switches during mounting, quality is improved, and costs are lowered.
- Mounting history data can also be automatically collected, making it possible to prevent human-error mistakes and lower personnel costs.
- Batch control (magazine rack control) is possible for PCBs, which is conventionally difficult to achieve.
- The magazine rack is equipped with an urgent flag, which allows a more flexible response to production that does not rely on the host PC.

■ Important Model Features

- The large memory capacity (254 bytes to 8 Kbytes) of the Data Carrier enables a variety of PCB control data to be written.
- Superior noise resistance enables stable communications in FA environments.
- Various special holders are available for easy mounting of the Data Carrier (for V600-D23P71, V600-D23P66N, and V600-D2KR16).

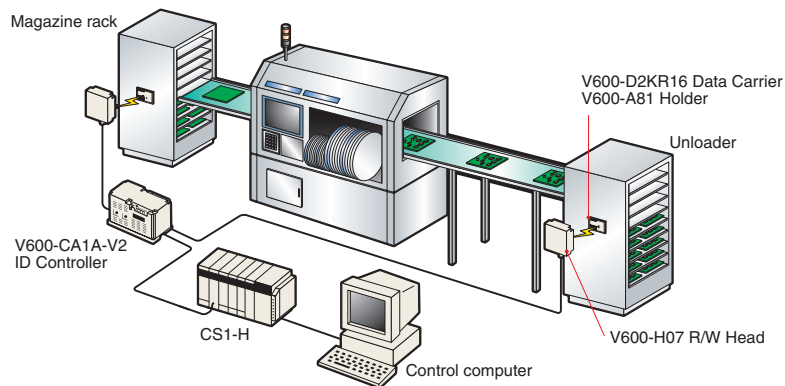

V600-series RFID System

Reference pages
A-14

13. Traceability Control for Manufacturing TVs and Monitors

■ Problem

- Products and their production histories (inspection results, etc.) need to be controlled on mixed-flow lines, but the system becomes too complicated.
- The lines use tracking control, so process switching is extremely troublesome whenever an urgent item enters the system, or an item is removed for repairs.
- The sorting process, in which products are sorted by size and destination, must be handled with high accuracy and speed.

■ Solution

- Write the product number, model number, processing data, assembly data, and inspection instructions to the Data Carrier (ID Tag).
- The processing, assembly, and inspection are conducted for each process according to the instructions of the Data Carrier.
- The inspection results are written to the Data Carrier at each inspection process, then uploaded to the host computer at the final process.

■ Benefits

- Because products and data are integrated, processes can be efficiently switched at each stage. Further, because production histories and inspection histories can be automatically collected, product traceability can be accurately controlled.
- By marking the product and guarantee card with a 2-dimensional code containing production history data (production number, lot number, factory, line, etc.), traceability can be further enhanced.

■ Important Model Features

- Superior environmental resistance enables stable communications even in severe FA environments.
- High reliability makes it possible to maintain accurate data in inspection processes (under tens of thousands of volts and high electrical fields).
- The V530-H3-series 2-Dimensional Code Reader (available in a wide range of fixed and handheld models) can read extremely small 2-dimensional codes with high stability.

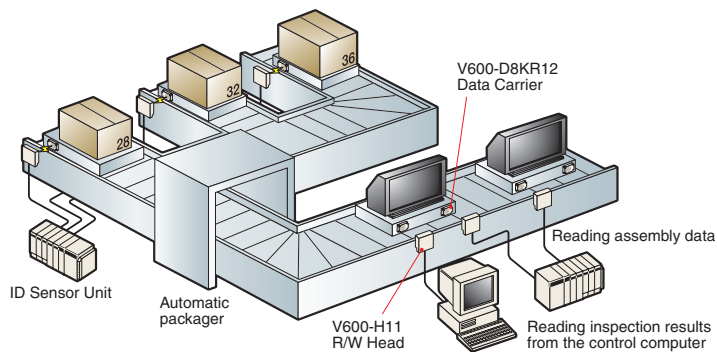

ID Sensor Unit
 CJ1W-V600C11/V600C12
 CS1W-V600C11/V600C12
 V530-R150E-3/EP-3 Fixed-type 2-Dimensional Code Reader

Reference pages
A-45/B-7

14. Standardizing and Improving the Operating Rate of Production Lines

■ Problem

- When multiple automated lines are used for production, there is no simple way of standardizing and maximizing the production volume of each line. It is also difficult to determine the operating condition of each automated machine.
- In a production system where the work results and inspection results from the preceding process are used to determine which automated line the product will be sent to for the next process, control by the host computer is difficult, and errors are extremely troublesome to handle.

■ Solution

- Mount a Data Carrier (ID Tag) to each pallet, write the work data for the automated machine (automated machine number used, lot number, tool used, work program number, etc.), and use this to send the product and components to an available line.
- The instructions are read by each automated machine, and the work is done. The work start time and end time are written to the Data Carrier. For inspection processes, the inspection results are written together with the automated line number that should be used next, and the subsequent work is done at that automated line.

■ Benefits

- Because the product can be sent to an available line based on the data in the Data Carrier mounted to the pallet, control is simplified with no burden on the host computer. This makes it possible to optimize and standardize each automated line to dramatically increase productivity. Further, by inputting time control data to the Data Carrier, the operating condition of the lines can be easily obtained.
- Because the product proceeds to the next process according to instructions that were written to the Data Carrier immediately before, no mistakes occur in tracking control when interrupt items are inserted, and operation is efficient with no burden on the host computer.

■ Important Model Features

- The V600-D8KR04 Data Carrier with a communications distance of 10 cm enables communication from below a roller conveyor, through the roller intervals. For this, the Data Carrier is embedded in the bottom of the pallet.
- The large data capacity of 8 Kbytes allows storage of detailed work instructions and inspection data.
- The large-capacity, shielded-type V600-D8KR1□/R04 Data Carrier can be directly mounted to metallic pallets.
- High resistance to noise enables stable communications in FA environments.

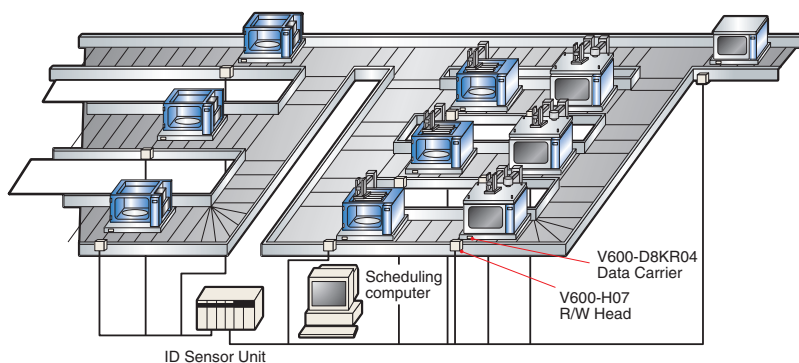

V600-series RFID System
 ID Sensor Unit
 CJ1W-V600C11/V600C12
 CS1W-V600C11/V600C12

Reference pages
 A-14/A-45

15. Progress Control and History Notification within Processes

■ Problem

- Since the production processing and assembly time, as well as the holding time, for each process in the production line cannot be accurately obtained, it is impossible to determine where to start in making process improvements aimed at raising productivity.
- Obtaining the progress status for each process in the production line is an important factor in achieving supply chain management (SCM), but it is extremely difficult to control this on a host computer because the processes are split into several branches and then merged.

■ Solution

- Mount a Data Carrier (ID Tag) onto the pallet carrying the product, or onto a workpiece. In addition to product information, write the work start and end times as they occur for each process onto the Data Carrier. Then, at the final process, read the time data that was written for each process and create a graph containing the process history and corresponding time data to analyze the processes.
- When the work at each process ends, write the process end flag data and instructions for the next process onto the Data Carrier.

■ Benefits

- Since the product processing/assembly time and holding time can be easily obtained for each process, bottleneck processes can be located, and process improvements can be made based on those analytical results.
- Also, since the unit price of the product can be simultaneously grasped, improvements can also help to increase profitability.
- For lines manned by people, the operating time can be accurately obtained without the need for writing daily work reports.
- Since it is easy to track products and know where they are within the process, it is possible to maintain accurate progress and delivery control.

■ Important Model Features

- The large data volume (2 Kbytes) makes it possible to obtain time data even for finely divided processes.
- The lifetime of the Data Carrier (V600-D2KR16 replaceable-battery type, battery life: 2 years) is easily managed even for complicated processes where the Data Carrier is frequently accessed (reading/writing) and the amount of access varies according to the line.
- High resistance to noise enables stable communications in FA environments.
- A special holder is available for easy mounting/removal of the Data Carrier (V600-A81).

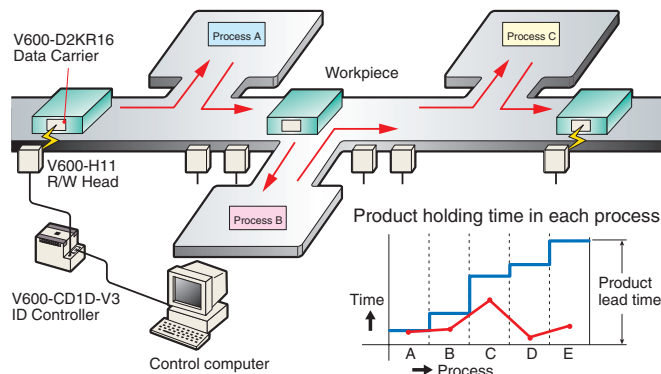

Reference pages

A-14

V600-series RFID System

16. Processing and Assembling CRTs and Displays

■ Problem

- Bar code labels or photoelectric mechanical flag seals are attached to the pallets of hanger conveyors that are used to transport small lots of CRTs or monitors for TVs and PCs in the processing and assembly lines. Because the hangers sway, the reading depth changes and the labels or seals sometimes cannot be read, causing the line to stop.
- The number of models being produced has increased due to diverse user needs and the appearance of LCD and plasma TVs. This has created the need for frequent line changes, and the resulting complex processes make control by a host computer extremely difficult.

■ Solution

- Mount a Data Carrier (ID Tag) onto the hanger pallet carrying the product. Write the data to distinguish models in bits (for example, 0000 for product A, 0001 for product B, and 0010 for product C, allowing 16 models to be distinguished with four bits). Install a system with Intelligent Flags and a PLC at each process.
- When the work at each process ends, write the process end flag data onto the Data Carrier. Use a "1" flag for ending, and a "0" flag for not ending (for example, for four processes, use 0001 for the end of process 1, 0011 for the end of process 2, and 0111 for the end of process 3. These will enable process progress management).

■ Benefits

- Since there will be no reading errors or missed readings such as those that occur in systems using bar codes or mechanical flags, accurate control will be possible and there will be no more stopping of the production line. This will increase productivity.
- Unlike mechanical flags, Intelligent Flags have no mechanical parts, allowing you to configure a maintenance-free system.
- By managing the process progress with process-end flags, the quality of product processing and assembly can be raised (contributing to ISO 9000).
- There is no need to revise the flags when the number of models increases as is required with mechanical flags, allowing you to configure a highly flexible system.

■ Important Model Features

- The Intelligent Flag Series can be set up with a smaller investment than that required for mechanical flags for distinguishing models and managing process progress. For example, for distinguishing models only, a single set (V600-HAR92) can handle up to 64,000 models, distinguish 256 models, and control eight processes.
- The V600-HS67 Sensor can read or write with a pallet sway of up to approximately 100 mm or 3.9". (For more stable communications, it would be better to mount a Data Carrier to the top of the hanger.)
- High resistance to noise enables stable communications in FA environments.
- The V600-D23P66N is available at a very reasonable price.

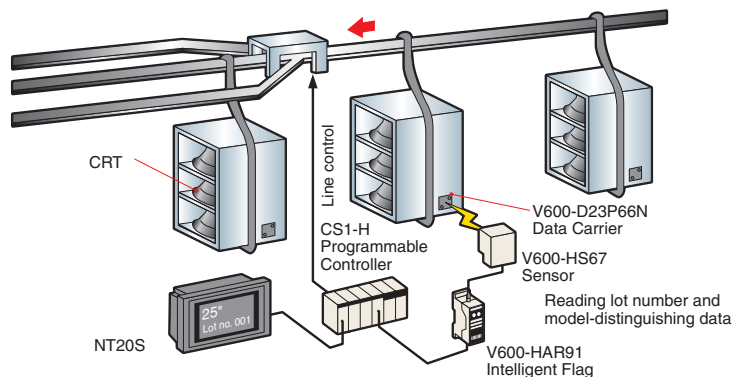

V600-HA RFID System

Reference pages
A-49

17. Controlling Carrier Boxes or Totes (Components) within Processes

■ Problem

- The components, dies, etc., that are needed for the processing and assembly lines of home appliances are conveyed in carrier boxes or totes. A paper list is placed in the boxes, and the parts are sorted while checking the list at each process. This system is inefficient and lends itself to human error. Many companies would like to improve on it without having to make a large investment.
- Bar code labels are attached to carrier boxes, and a bar code reader is used to read the labels at each sorting stage. However, when labels become soiled, they cannot be read or they cause reading errors. Or, to lessen the parts control burden on the host computer, companies have switched to a system that issues parts-distinguishing labels for each component instead of carrier box-distinguishing labels, but the cost of issuing the labels and the extra work of replacing them is driving up operating costs. Companies are therefore seeking to improve on this system.

■ Solution

- Mount Data Carriers (ID Tags) onto the carrier boxes carrying the components. Use a special holder that allows the Data Carrier to be easily mounted and removed for this. Write bit data to the Carrier Data for distinguishing components (for example, 00000000 for component A, 00000001 for component B, 00000010 for component C, and 00000011 for component D; up to 258 components can be distinguished with eight bits).
- Install a system with Intelligent Flags and a PLC at each process to automatically read the component bits and sort the components accordingly.

■ Benefits

- RFID Systems are more resistant to environmental conditions than systems using bar codes or similar means, which allows accurate sorting without reading errors or missed readings. They also eliminate the human errors that occur with systems using paper lists, and offer ecological benefits (contributing to ISO 14000).
- Unlike mechanical flags, Intelligent Flags have no mechanical parts, allowing you to configure a maintenance-free system in which there is no need to stop production lines.
- When the number of models increases, you simply have to change the Data Carrier bit data, allowing you to configure a highly flexible system.

■ Important Model Features

- The Intelligent Flag Series can be set up with a smaller investment than that required for systems using bar codes or mechanical flags to distinguish components. Up to 64,000 component models can be distinguished (using the V600-HAR92).
- High resistance to water, vibration, and shocks allows use in severe FA environments. It can also withstand ambient temperatures up to 110°C (80°C when reading/writing data).
- The special Data Carrier holders can be easily mounted to pallets with an ultrasonic adhesion unit manufactured by Sanko (holders can be attached to two locations within 10 seconds).

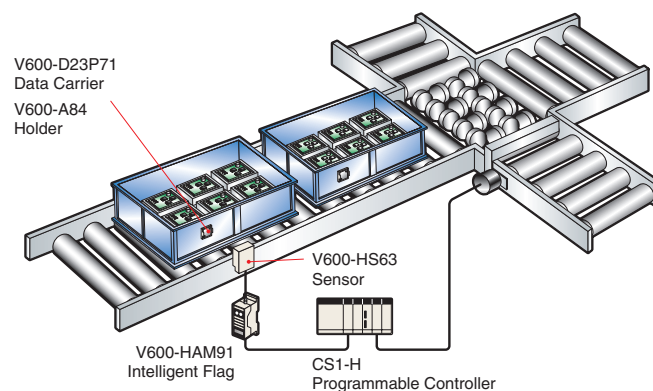

V600-series RFID System
V600-HA RFID System

Reference pages

A-14/A-49

18. Lot Control and Condition Control in Plating Processes

■ Problem

- Components are inserted in a plating bath for metal plating. When multiple components are inserted, each of the individual components must be managed. Paper and labels are used for this purpose in other processes, but they cannot be used here because the components are inserted into the bath. Human errors and missing components can result because it is difficult to keep track of which components, from which lots, are in the plating process.
- In some cases, the plating conditions are determined prior to plating and written up into work instructions for manual input. Due to the short life cycles of products today, and the speed at which model revisions occur, this instruction system becomes quite rushed and subject to human error and other mistakes. An operating method with greater accuracy and efficiency is needed.

■ Solution

- Mount a Data Carrier (ID Tag) onto the plating basket (pallet) carrying the components. Write the component data, lot data, urgent-item flag data, and plating conditions onto the Data Carrier.
- Mount a R/W Head (Antenna) onto the controller of the plating device. Prior to placing the components into the bath, use the R/W Head to read the lot data, product data, and plating conditions simultaneously, and automatically make the condition settings for the plating device.
- In order to achieve more advanced work process management, configure a system that writes the work start and end times for each plating job. This will enable process history and process progress control, making it easy to determine where components are in the process at any time.

■ Benefits

- Controlling components and writing work instructions for plating processes, which are conventionally considered to be difficult for physical reasons, are enabled together with automated process changes. Human errors are also eliminated to improve quality and reduce financial losses.
- It becomes easy to track components and know where they are within processes, which enables accurate progress control and delivery planning.

■ Important Model Features

- The V600-D23P66SP Data Carrier is packaged in PFA (Teflon) for high resistance to chemicals. The PFA packaging uses a dual structure for even greater reliability.
- The large storage volume (254 bytes) makes it possible to manage both component data and process control data.
- The ID Tag requires no battery, making it maintenance-free.
- High resistance to noise enables stable communications in FA environments.
Cannot be used if the temperature in the bath exceeds 110°C.

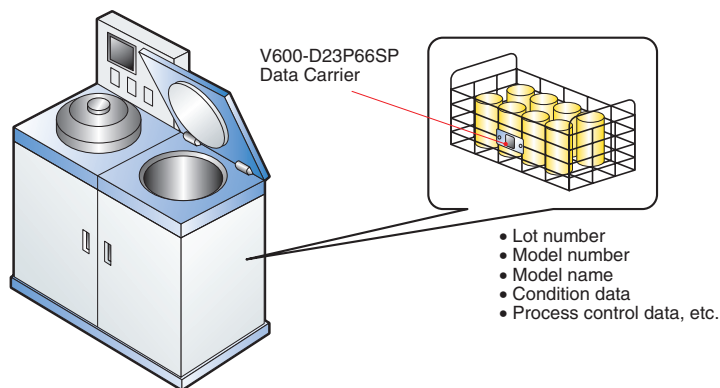

Reference pages

A-14

V600-series RFID System

Automobiles and Industrial Machinery

19. Traceability Control for Important Safety Components

■ Problem

- In the area of quality control, more effective history management is needed for products that have an influence on safety.
- In the unlikely event of a recall, the affected cars need to be pinpointed and dealt with quickly.
- Failure to carry out effective crisis management can cast doubts on a company's sense of social responsibility.

■ Solution

- Label important components with their own serial numbers in 2-dimensional code, either by pin-stamping or using laser marking.
- When assembling engines, read the 2-dimensional codes on the components, and associate them with the engine number.

■ Benefits

- When there is a recall, the affected cars can be identified accurately and completely, and the recall cost can be reduced to an absolute minimum.
- The information gathered can be used as basic reference material for analyzing failures and quickly isolating the causes.

■ Important Model Features

- 2-dimensional code allows approximately 20 digits of data to be written in an area of 4×4 mm.
- Markings printed directly onto metals can be read.
- The compact Camera ensures that space is used efficiently.

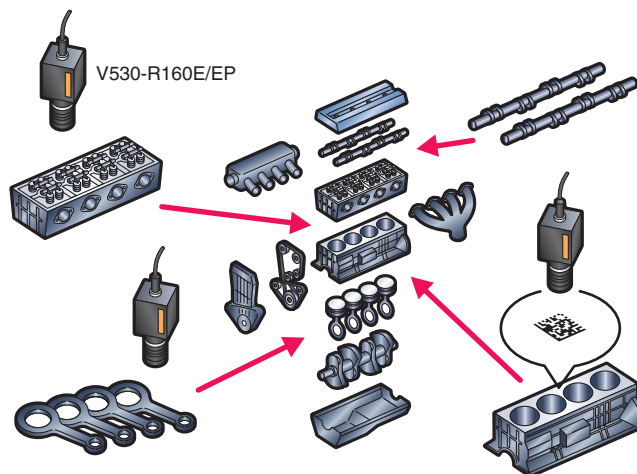

V530-R160E/EP Fixed-type 2-dimensional Code Reader

Reference pages

B-19

20. Automated Pouring in Casting Processes

■ Problem

- When pouring is based on visual confirmation of a number plate mounted to the mold, the influence of dust, high temperatures, vibrations, or other conditions particular to the production site make work very difficult.
- The number plate is difficult to see because of dust, increasing the likelihood of human error.
- The versatility to switch between different types of operation and high work efficiency, essential for responding to a variety of needs, are difficult to attain.

■ Solution

- Store information about the mold number and pouring hole position in Data Carriers (ID Tags) mounted to the molds.
- Read the information from the Data Carriers on the molds with an Antenna mounted to the pouring machinery, and perform pouring work (automatically) based on this information.

■ Benefits

- Mold number reading errors are prevented and consequently human error is eliminated. This leads to significant reductions in product losses.
- The mold numbers written in the Data Carriers and read automatically and so the time required to switch between different types of operation can be drastically reduced.
- Reading pouring hole position information allows the automation of pouring work. This enables greater efficiency in high-diversity, low-volume production.

■ Important Model Features

- Stable communications are possible even if the Data Carriers become dirty.
 - High noise resistance enables stable communications in FA environments.
- * The Data Carrier can withstand temperatures of up to 150°C (302°F). The mold, however, can reach temperatures of up to 1,000°C (1,832°F) and so consideration of the Data Carrier's mounting position is required.

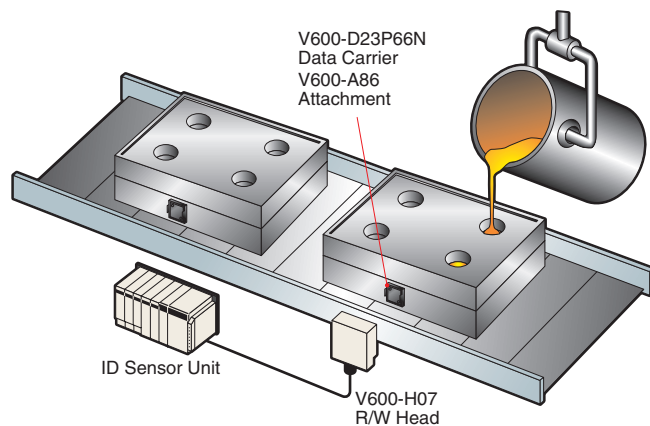

V600-series RFID System
ID Sensor Unit
CJ1W-V600C11/V600C12
CS1W-V600C11/V600C12

Reference pages
A-12/A-45

21. Model Discrimination and Process Control for Engine Assembly Lines

■ Problem

- In engine assembly lines that use mechanical flags and bar codes for model discrimination and process instructions, the production line sometimes has to be stopped because of mechanical failures or other factors, such as not being able to read the bar codes because of oil or coolant.
- Although mixed production lines can be handled, increasing diversification of client needs has led to further increases in the number of different models, and switching between different types of operation must be performed with more efficiency and stability than ever before.

■ Solution

- Mount Data Carriers (ID Tags) to the pallets or jigs.
- Write model information and process information to the Data Carriers, read the information at each process station, and, based on this information, switch the operation type (if necessary) and perform processing.
- After completing a process, enable the processing completion flag for that process.

■ Benefits

- Line stoppages and process errors due to mechanical failure and reading errors are eliminated.
- The model information written in the Data Carriers is read automatically and so the time required to switch between different types of operation is reduced and production efficiency is increased.
- The history for each process can be written to the Data Carriers straight away, ensuring stable progress management and improved traceability.

■ Important Model Features

- Stable communications are possible even if oil or coolant adheres to the Data Carrier surface.
- Stable communications are also possible in environments with high noise levels.
- Intelligent Flags, which allow systems to be constructed with a small capital investment, are ideal as substitutes for mechanical flags or for limited model discrimination applications. The Data Carriers can hold 8 Kbytes of information, allowing management of work instructions, process histories, and inspection information in other processes.

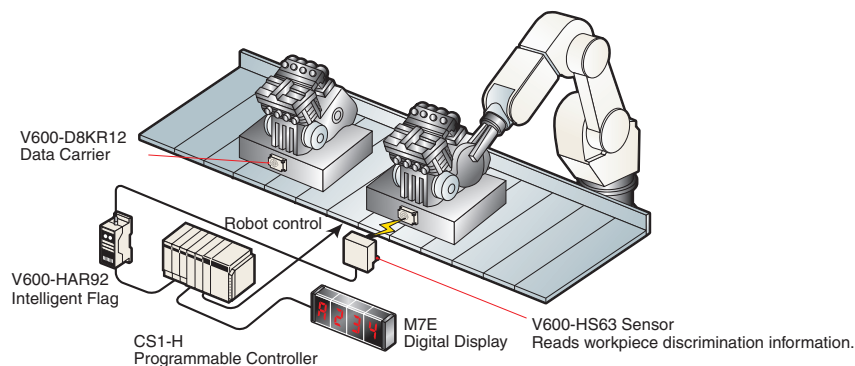

V600-HA RFID System

Reference pages

A-49

22. Picking Instructions for Assembly Parts

■ Problem

- Performing picking work using (paper) instruction sheets results in human error.
- Time wasted looking at instruction sheets results in low work efficiency.

■ Solution

- Store pallet numbers, picking station numbers, and picking instructions (e.g., picking component numbers and picking quantities) to Data Carriers (ID Tags) mounted to the pallets.
- At each picking station, read the information from the Data Carrier, turn ON the lamp for the rack corresponding to the picking component number and, at the same time, display the picking quantity.
- The operator puts the displayed quantity of the displayed component in the pallet.

■ Benefits

- The picking instructions are displayed at the rack as soon as the pallet arrives, enabling the work to be performed simply and quickly even by inexperienced operators.
- Human error is greatly reduced and so fewer assembled products are lost because of picking errors.
- No paper is required, contributing to ISO14000.

■ Important Model Features

- High noise immunity enables stable communications in FA (Factory Automation) environments.
- A special holder (for the V600-D23P66N) that allows simple Data Carrier mounting is available.
- Direct connection to an OMRON PLC bus is possible using an ID Sensor Unit. This significantly reduces the time and effort required for programming.
- Battery-less Data Carriers eliminate the need for maintenance.

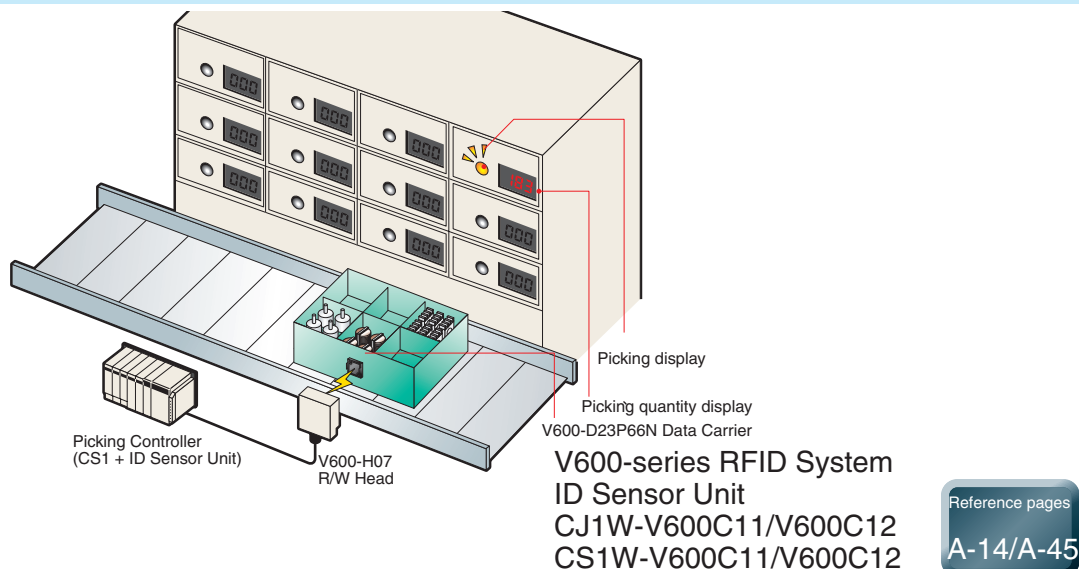

23. Tire Types and Destination Discrimination

■ Problem

- The manufacture and delivery of tires is carried out systematically based on a production plan. Urgent items, however, must be sorted by hand, giving rise to human error, such as destination direction, model discrimination, and quantity counting errors.
- The hangers vary with the size and type of tire and so conveyance efficiency is very low.
- Sorting is performed using bar codes on the tires but dirt on the label can lead to reading errors and it takes time to check the tires.

■ Solution

- When mounting a tire onto a hanger, write information regarding the tire type, the destination direction, and urgent-item flags to a Data Carrier (ID Tag) mounted to the hanger.
- Perform sorting (automatically) based on information regarding the tire type and destination direction read from the Data Carrier using a R/W Head (Antenna) mounted to the sorting point in the hanger conveyance system. Display information related to urgent-item flags on display devices.

■ Benefits

- Sorting the tires according to information stored in Data Carriers means that urgent items are sorted reliably with no errors. This ensures a significant reduction in losses.
- Holding the information in the hangers (i.e., the Data Carriers mounted to the hangers) eliminates the need for different types of hanger and reduces the number required. This allows significant savings in capital investment and management costs.

■ Important Model Features

- Stable communications are possible even if dust or bits of rubber adhere to the Data Carrier surface.
- High resistance to noise and heat enables stable communications in severe FA (Factory Automation) environments.

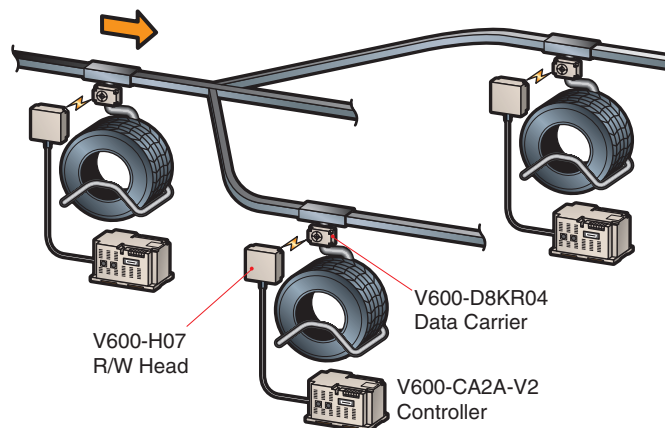

V600-series RFID System

Reference pages
A-14

24. Tool Management for Machining Centers

■ Problems

- Managing tools for machining centers, lathes, and hobbing machines on paper, by storage location, or by writing directly on the tools with a marker pen leads to delays and processing errors due to incorrect setting.
- Associating the information required for tool management (e.g., usage time and tool length) with the actual tools is difficult.

■ Solution

- Process the pull-stud or drive-key groove of each tool so that an ID Tag (dimensions: 8 dia. × 5 mm or 12 dia. × 5 mm) can be attached using adhesive, and store tool management information (e.g., tool number, name, usage time, and tool length) in the ID Tags.
- In addition, store information obtained by the tool presetter (e.g., initial tool length and compensation values) in the ID Tags.

■ Result

- Linking tools with information ensures that setting errors (e.g., incorrect tool selection) are prevented. This eliminates unnecessary losses due, for example, to process errors, material loss, and delays in delivery schedules.
- Unmanned machining center management is possible using an ATC (Auto Tool Changer).
- Reliable management of tool service life helps prevent reductions in processing quality due to tool deterioration.
- Management of compensation values for the tool length ensures accurate setting adjustment after regrinding tools.

■ Important Features of Model Lineup

- The compact ID Tags are small enough to be embedded in pull-studs or driver-key grooves.
- High environment resistance (resistance to oil, shocks, vibration, and temperatures up to 110°C, 230°F).
- Communications are possible even when embedded in metal.
- Intelligent Flags make management easy. (Mounting errors prevented.)

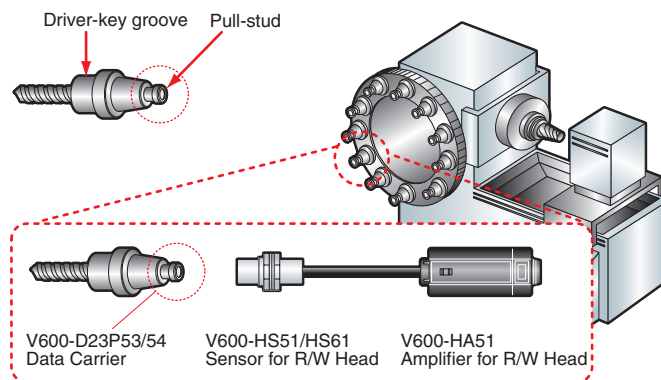

V600-series RFID System
V600-HA-series RFID System

Reference pages
A-14/A-49

Foodstuffs, Chemicals, and Medical Supplies

25. Automation of Systems for Mixing and Measuring Medicines

■ Problems

- Using (paper) instruction sheets leads to mixing errors due to misplacement.
- Changing the system to accommodate new products is extremely difficult.

■ Solution

- In each process, read product and mixing information written beforehand to ID Tags mounted to the pallets, and add the specified weight of each substance from the tanks.
- Write the mixing result (i.e., the weight) to the ID Tags and then read this information in the inspection process to check the actual weight of the contents.

■ Result

- Automated mixing instructions and reliable measurement help prevent mistakes and, as a result, waste-disposal costs can be reduced.
- Reliable mixing and quality control make for easy history management.
- The system can be set up so that products with an incorrect weight are not delivered, contributing to GMP.
- Unlike systems based on paper and bar codes, downloading data each time from the host is unnecessary and so product additions can be handled by simply by rewriting the data in the ID Tags.

■ Important Features of Model Lineup

- The PFA (Teflon) Tags have high resistance to the environment and bacteria, and can withstand the pallet sterilization process.
- The Tags are resistant to temperatures of up 110°C (230°F) and can withstand thermal cleaning and IPA cleaning.

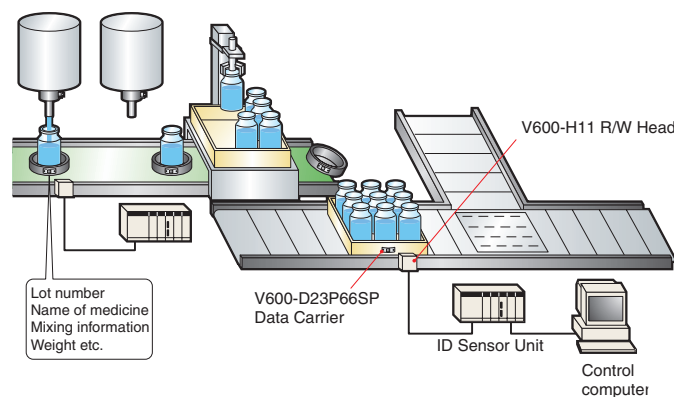

V600-series RFID System
ID Sensor Unit
CJ1W-V600C11/V600C12
CS1W-V600C11/V600C12

Reference pages
A-14/A-45

26. Automatic Inspection and Sorting of Blood Samples

■ Problems

- In systems that perform batch control of sample racks and trays with bar codes, the inspection instructions and sorting information are handled at the host system. This gives rise to complicated programs and configurations, making it difficult to change the system when required.
- A new bar code label must be attached each time the sample racks and trays are cleaned. The labels have to be attached carefully without being creased.

■ Solution

- Read information from the bar codes on the test tubes with a bar code reader, and store that information along with inspection instructions and sorting information in the ID Tags embedded in the sample racks and trays.
- Write inspection history information and inspection results to the ID Tags and, in the final process, upload the information to the host system.

■ Result

- Even though the inspection items vary with the sample, inspections and sorting based on the inspection instructions stored in the ID Tags can be performed automatically, efficiently, and reliably.
- The bar code labels do not require reattachment, reducing labor requirements and consequently labor costs.
- Interruption processing, such as for urgent inspection samples, can be handled smoothly and accurately.

■ Important Features of Model Lineup

- The compact ID Tags can be embedded in the sample racks and trays.
- High resistance to the environment - resistant to chemicals and temperatures of up to 110°C (230°F) and capable of withstanding IPA cleaning and ultrasonic cleaning.
- Communications are possible even when embedded in metal and so the ID Tags can be used with metal racks.
- The ID Tags have an information capacity of 240 bytes min., much larger than that of bar codes.

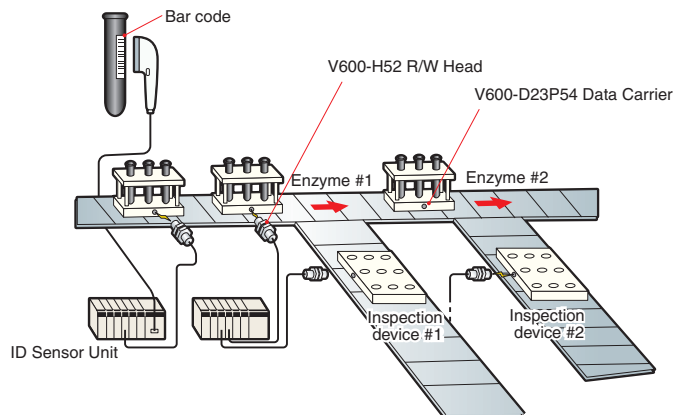

ID Sensor Unit
CJ1W-V600C11/V600C12
CS1W-V600C11/V600C12

Reference pages

A-45

27. Automation of Systems for Combining and Measuring Raw Materials

■ Problems

- Using (paper) instruction sheets leads to incorrect combinations due to misplacement.
- When incorrect combinations occur, they are not discovered until the final inspection process.

■ Solution

- In each process, read combination information from the ID Tags mounted to the containers and add the specified weight of each raw material from the hoppers.
- Write the combination result (i.e., the weight) to the ID Tags.

■ Result

- Automated combination instructions enable mistakes to be prevented and consequently waste-disposal costs to be reduced.
- Reliable combination and quality control make for easy history management. This also contributes to HACCP (Hazard Analysis Critical Control Point).
- Unlike systems based on paper and bar codes, downloading data each time from the host is unnecessary and so the tact time can be significantly reduced.

■ Important Features of Model Lineup

- High-speed communications makes it possible to handle short lead times (128-byte access, 14 ms).
- The long service life is not affected by the number of processes or accesses (maximum number of accesses: 1 billion times).
- High resistance to the environment (IP67) and noise.

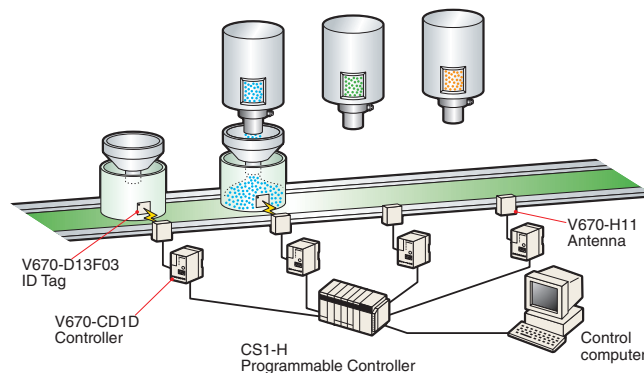

V670-series RFID System

Reference pages

A-71

28. Quality Control for Food Products

■ Problems

- Food products demand a high degree of safety. The importance of managing a wide variety of information, such as the date and place of production, the best-before date, and the destination direction is greater than ever and has made quality control of foodstuffs very difficult.
- Food products cartons are cleaned with alcohol, detergent, warm water, or steam and so machines that have a low resistance to chemicals or high temperatures, or that may allow bacteria to proliferate cannot be used.

■ Solution

- Mount Data Carriers (ID Tags) housed in a double layer of PFA (Teflon) to the cartons or pallets, and in addition to the product name, weight, and quantity, store information regarding the data and place of production, the best-before date, and the destination direction in the Data Carriers.
- Perform sorting and delivery work after confirming safety using the production date and best-before date information obtained from the Data Carriers and issue a form itemizing the relevant information.

■ Result

- Reading the product name, weight, and quantity stored in the Data Carriers enables reliable, error-free delivery and itemization with less effort and greater efficiency.
- Reliable quality control makes for easy history management (contributing to HACCP (Hazard Analysis Critical Control Point)).

■ Important Features of Model Lineup

- The V600-D23P66SP ID Tags have high resistance to chemicals and can withstand cleaning using alcohol (IPA) or detergent.
- The ID Tags have sufficient heat resistance to withstand cleaning with warm water, steam or IPA.
- A large information capacity (254 bytes) enables the storage of basic foodstuff control information.

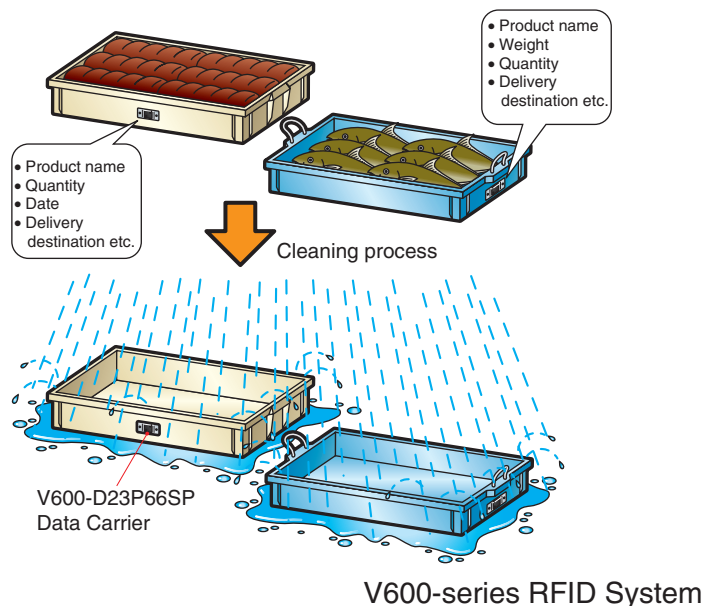

Reference pages

A-14

29. Filling Inspection for Plastic Containers

■ Problems

- Beverage production lines where plastic containers, for example, are filled with liquid, have a short tact time and require a high degree of accuracy. The foodstuff industry is subject to particularly stringent levels of product control (e.g., HACCP).
- Generally speaking, filling control is performed by measuring the weight of the plastic container once in the empty state and then again after the filling has been completed. The difference is calculated to confirm that the weight agrees with the specified value. Data must be exchanged, however, with the host at each measurement, necessitating a complicated system configuration.
- If, as a result of the inspection, the filling weight is found to disagree with the specified value, correction is necessary. A way of performing the necessary sorting control quickly, simply, without sacrificing reliability is required.

■ Solution

- Mount ID Tags to the jigs holding the products. If round jigs are used, mount the ID Tags to the bottom of the jigs and install the Antenna underneath to ensure access even if the jigs turn around.
- Measure the weight of each container in the empty state and write the result to the ID Tag. Write the filling machine number to the ID Tag to distinguish it from machines at subsequent processes. Measure the weight of the container again after the filling is completed and write the total to the ID Tag.
- In the weight inspection process, read the empty-state weight and total weight from the ID Tag and check the difference at the host system. At this point, if the difference disagrees with the specified value, send the item to the correction process.
- At the same time, read the filling machine number stored in the ID Tag.

■ Result

- The system does not impose a burden on the host with each measurement and so a quality control system that checks every item can be created, replacing the spot-check systems used until now.
- Handling the filling machine number and filling weight together enables inconsistencies between machines to be analyzed.
- ID Tags allow information to be distributed. This enables the system to be changed simply when new products are introduced and consequently less investment is required.

■ Important Features of Model Lineup

- This high-speed RFID System allows 128 bytes of information to be exchanged in 14 ms and 8 digits of weight information to be exchanged in 5 ms.
- The Data Carriers are equipped with Fe-RAM, allowing frequent access (reading/writing) without worrying about the service life.
- Resistance to water, chemicals, vibrations, shocks, and noise allows stable operation in the severe environment of foodstuff production lines.

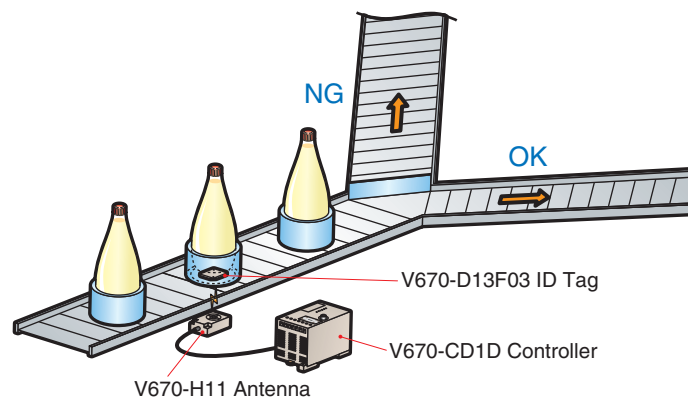

Reference pages

A-71

V670-series RFID System

Conveyance Systems and Warehousing

30. Enhancing Automatic Control of AGVs

■ Problems

- There are AGVs (Automatic Guided Vehicles) and RGVs (Rail Guided Vehicles) that run while sensing magnetic tape attached to the floor. They must stop at stations to load or unload cargo, and control is required to ensure that they proceed in the correct direction at junctions. This kind of control can be performed with wireless devices and sensors but depending on the installation, positioning, and environmental conditions, the sensors used may not have sufficient detection accuracy.
- A way of allowing the system to be changed more simply is needed.

■ Solution

- Embed Data Carriers (ID Tags) in the stations and at junctions. Incorporate an Intelligent Flag in each vehicle and connect it to the PLC or (Control Board) already built into the vehicle to control vehicle motion. Write the station number or junction number in the Data Carriers as bit data (e.g., 00000001 for station 1 and 00000010 for station 2).
- Either program control information (e.g., stop, decelerate) for each station in the PLCs, or send control information to the PLCs when required using a wireless device. Motion control of the AGVs will be based on the data read by the Intelligent Flags.

■ Result

- The position information stored in the Data Carriers is read at each point and so the motion of the AGVs can be controlled with a high degree of precision.
- Managing point information simply by embedding Data Carriers in each of the stations and junctions makes system design and positioning much simpler than with systems using reflective sensors. There are no mechanical parts and so maintenance is unnecessary, allowing reductions in running costs. Line changes can be handled simply by moving the Data Carriers.

■ Important Features of Model Lineup

- The Intelligent Flag Series enables the creation of point identification systems with a relatively small investment. Identification of up to 64,000 points is possible using the V600-HAR92.
- The width of the V600-HS67 Sensor is approx. 100 mm (3.9") and so reading is still possible even if the AGV is slightly out of position (communications distance set to approx. 30 mm (1.2")).
- High noise resistance enables stable communications in FA environments.
Performance may be affected, however, by high-capacity power cables laid under the floor.

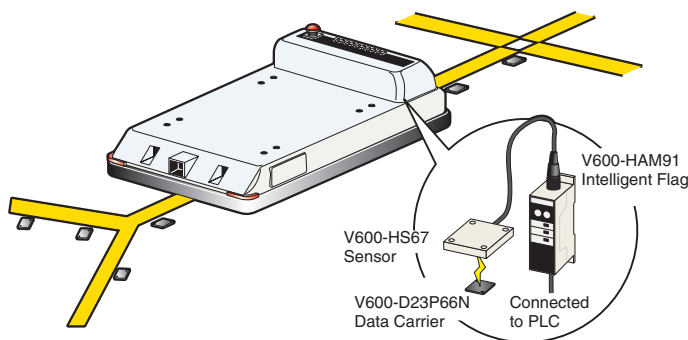

Reference pages

A-49

V600-HA RFID System

31. Motion Control for High-speed Conveyor

■ Problems

- Motion control for high-speed conveyors, such as OHTs and sorters, can be performed with mechanical flags that use photoelectric sensors and optical communications devices. With systems based on mechanical flags, however, position displacement caused by shocks and vibration can result in malfunctions. Wear-and-tear can lead to problems related to light-source deterioration, and malfunctions due to dirt can occur.
- In order to develop a faster system, a greater level of autonomy is needed. RFID technology would give the required level of autonomy but, generally speaking, the communications speed would be too slow.

■ Solution

- Mount ID Tags to the OHTs and install Antennas at stations and junctions as required. Store OHT unit numbers and other relevant information in the ID Tags.
- When an OHT reaches a station, read the unit number with the Antenna, and send the OHT to the specified location by switching points as necessary via the control system (e.g., PLC) connected to the Antenna.

■ Result

- RFID Systems do not have mechanical parts, such as mechanical flags. This makes malfunctions much less likely to occur and eliminates the need for maintenance. They are also unaffected by dirt.
- The reading time when the unit numbers are set with 8 alphanumeric digits is approx. 5 ms, enabling operation with a travel speed of 350 m/min (1,180 ft/min). This will help with performance improvements in conveyance devices in the future, such as faster OHTs.

■ Important Features of Model Lineup

- High-speed reading and writing (212 Kbps) enables the transmission of 8 bytes of information in 5 ms and 128 bytes of information in just 14 ms. Fe-RAM is used for the memory and so the reading and writing times are the same. The maximum number of accesses is 1 billion times.
- The communications frequency is in the 13-MHz band, allowing stable communications in FA (Factory Automation) environments (high noise resistance).
- The ID Controller is equipped with a self-execution mode that allows all types of control without a host system program. The communications distance is reduced if there is metal immediately behind the ID Tag. Take this into consideration when mounting.

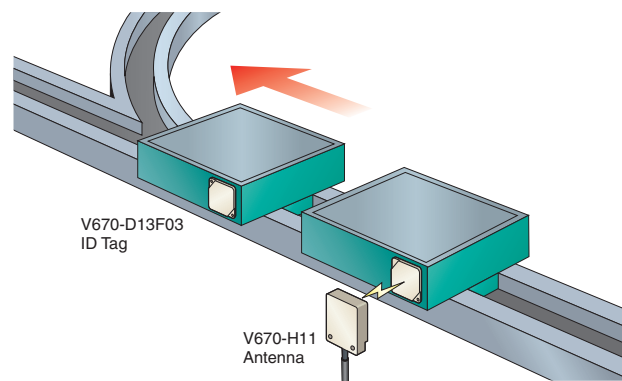

Reference pages

A-71

V670-series RFID System

32. Inventory Control for Automated Warehouses

■ Problems

- Linking warehouse inventory systems based on bar codes to other systems for picking, sorting, or another kinds of operation necessitates the creation of a network. This makes the overall system very complicated.
- Dirt on bar code labels attached to pallets can cause reading errors.

■ Solution

- Mount Data Carriers (ID Tags) to the pallets and store the pallet number and information about the contents of the pallet (e.g., component numbers, model numbers, and quantities) in the Data Carriers.
- In response to a storage instruction, read (automatically) all the information in the Data Carrier, and, after checking the contents, store the pallet in the specified rack, and record the rack number of the stored pallet in the host computer.
- In response to a delivery instruction from the host computer, take the pallet from the applicable rack, and after checking the pallet information, send the pallet to the picking or sorting process.

■ Result

- The information about each pallet and its contents is completely consistent and so complex tracking is unnecessary, and picking and sorting mistakes are eliminated.
- Unlike systems based on bar codes, databases and processing programs that relate the pallet numbers, pallet contents, and rack numbers are not required. This allows easy system restructuring.
- Contents and quantity can be checked just by reading Data Carrier information, allowing stock inventory to be performed simply.

■ Important Features of Model Lineup

- The R/W Head handles position displacements well thanks to its wide communications range (80 mm, 3.1").
- High noise resistance enables stable communications in FA (Factory Automation) environments.
- A special holder (for the V600-D23P71) that allows simple Data Carrier mounting is available.
- This system can be used in combination with the Intelligent Flag Series.

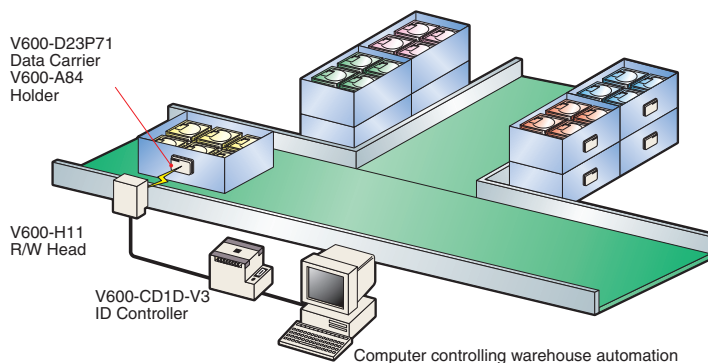

Reference pages

A-14

V600-series RFID System

Other Applications

33. Management of Rental Machinery

■ Problems

- Warehouse inventory control of rental machinery is complicated because it involves many different items. For example, it is necessary to keep track of which machinery has been rented out, which machinery has been returned, and what condition the machinery is in (e.g., how clean it is).
- Clerical errors can occur in management systems based on hand-written forms.
- Collating all the information into, for example, daily or monthly reports can be very difficult.

■ Solution

- Perform inventory control using ID Tags mounted to the machinery.
- Write information about the machinery, such as the machinery number and the status of the machinery (e.g., reserved/available, processed/not processed after return, clean/dirty), to the ID Tag.

■ Result

- The kind of clerical errors that occur with hand-written forms can be prevented.
- The time spent on filling out forms can be saved, enabling efficient management.
- The process of accumulating information on a computer is automated, allowing administrative work to be performed with much greater efficiency.
- Information about the status (e.g., reserved/available, processed/not processed after return, clean/dirty) is held by the machinery itself and so management errors can be eliminated.

■ Important Features of Model Lineup

- Not influenced by dirt.
- Proven track record in the industry.
- Handy, key-holder-size ID Tags are also available.

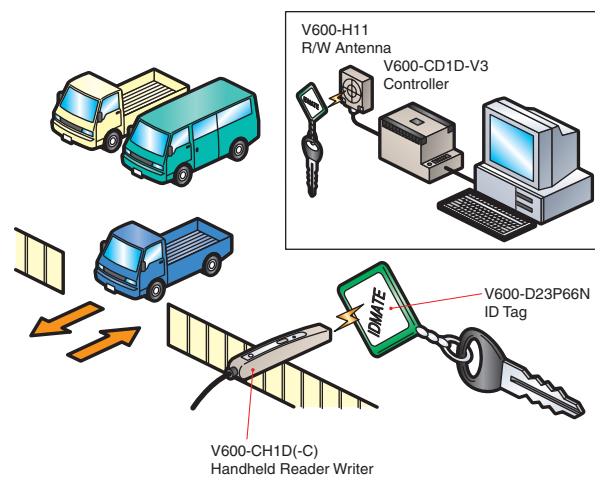

V600-series RFID System
V600-CH1D RFID System

Reference pages

A-14

34. Fruit Sorting Systems

■ Problems

- Selecting, sorting, or delivering fruit using mechanical flags (for variety discrimination) on special pallets gives rise to complicated mechanical parts with frequent malfunctions.
- Creating new mechanical flags to deal with new varieties uses up time and money.
- Water and dirt can cause reading errors in bar code systems.

■ Solution

- Store information obtained by a sorting machine, such as size, grade, and sugar content, in the Data Carriers (ID Tags) mounted to the pallets.
- Position Intelligent Flags at the sorting stations, read the information from the Data Carriers, and sort the fruit according to size, grade, or sugar content.

■ Result

- ID technology does not depend on mechanical parts and enables stable, trouble-free sorting. The cost per station is a fifth of the cost for systems using mechanical flags and so less investment is required.
- Additions of new varieties can be handled simply by rewriting the information in the Data Carriers.
- Unlike bar code systems, the RFID System is not affected by water and dirt, ensuring reliable control.

■ Important Features of Model Lineup

- The Intelligent Flags enable the simple creation of low-cost systems that can handle up to 256 varieties.
- The Data Carriers have high resistance to the environment and water.
- No maintenance is required for the Battery-less Data Carriers.

The V670 Series is ideal for high-speed sorting lines.

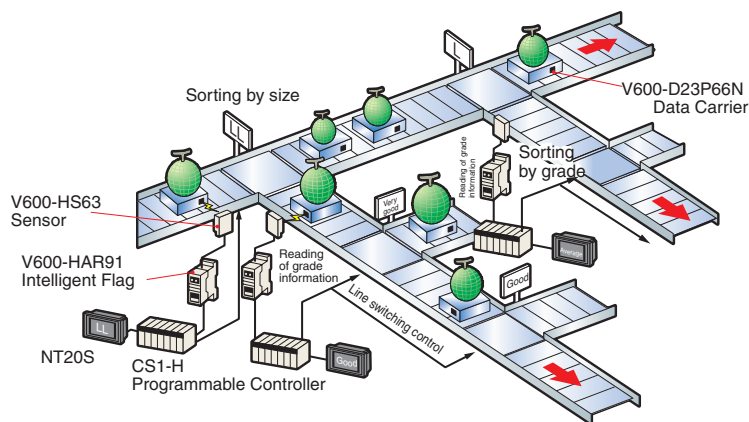

V600-HA-series RFID System
V670-series RFID System

Reference pages
A-49/A-71

35. Motion Control for Raw Material Transportation Systems

■ Problems

- Tracking control can be used to move AGVs around a factory to transport roll paper for printing. Using tracking control, however, means that the AGVs must be moved in order, and a large amount of time is lost waiting in line.
- With tracking control, the motion of the transportation vehicles is determined in advance and it is very difficult to make operation changes (e.g., interruptions).

■ Solution

- Write motion instructions (e.g., type, destination) to Data Carriers (ID Tags) mounted to the AGVs.
- Read the Data Carrier information at the stations and perform motion control of the AGVs as appropriate (e.g., instructions to move to material supply stations, standby stations, or production stations).

■ Result

- The AGVs themselves hold the information and so standby motion is possible and lost time can be eliminated.
- Information can be written directly to the Data Carriers and so operation changes (e.g., interruptions) can be handled easily.
- Information is distributed and so the system can recover quickly after a power failure.

■ Important Features of Model Lineup

- The R/W Head handles position displacements well thanks to its wide communications range (80 mm).
- High noise resistance enables stable communications in FA (Factory Automation) environments.
- A special holder (for the V600-D23P71) that allows simple Data Carrier mounting is available.
- This system can be used in combination with the Intelligent Flag Series.

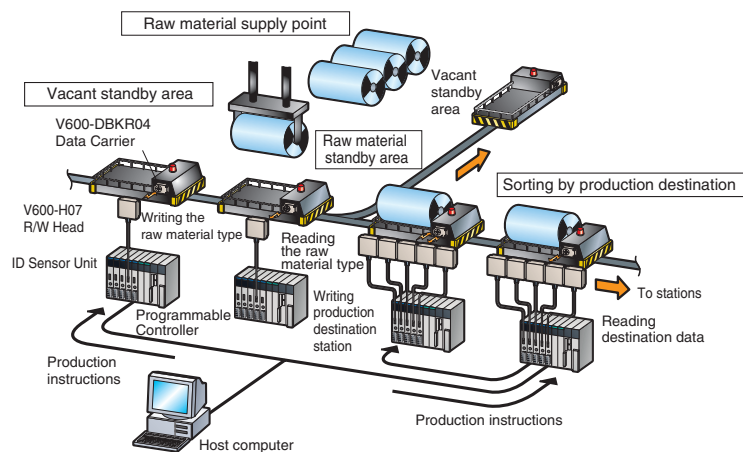

ID Sensor Unit
 CJ1W-V600C11/V600C12
 CS1W-V600C11/V600C12



Reference pages
A-45

Safety Precautions and International Standards

■ Meaning of Symbols





The symbols explained below are used to ensure correct use.

Standards

Symbol	Meaning
International standards 	Approved by UL standards.
	Approved by CSA standards.



Note: Only representative standards are given here. For details, refer to *Products with Standard Approval* below.

Product Safety

Symbol	Meaning
Precautionary information  	<ul style="list-style-type: none"> • General Caution Indicates general cautionary, warning, or danger level information.
	<ul style="list-style-type: none"> • Laser Caution Indicates information related to laser safety.
Prohibitions  	<ul style="list-style-type: none"> • General Prohibition Indicates a general prohibition.
	<ul style="list-style-type: none"> • Disassembly Prohibition Indicates that disassembly is prohibited to prevent electric shock.

Precautionary Information

The conventions described in the following table are used in sections containing precautionary information.

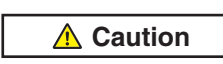
Classification	Symbol	Meaning
Items for product safety Precautionary information		<ul style="list-style-type: none"> • Danger Level Indicates an imminently hazardous situation which, if not avoided, will result in death or serious injury.
		<ul style="list-style-type: none"> • Warning Level Indicates a potentially hazardous situation which, if not avoided, could result in death or serious injury.
		<ul style="list-style-type: none"> • Caution Level Indicates a potentially hazardous situation which, if not avoided, may result in minor or moderate injury, or property damage.
Points to note	Cautions	Indicates items requiring attention to ensure safety.
Other items	Correct Use	Indicates items requiring attention to ensure full functionality and performance.

■ Products with Standard Approval

When ordering, be sure to specify the standard(s) that the products must satisfy. Consult your OMRON representative for details.

Note: The □ symbol in model numbers indicates a blank (i.e., nothing), a number, or a letter.



RFID Systems

Model	File No.	Ratings/notes
V600-CA1A-V2 V600-CA2A-V2 V600-CA8A-V2 V600-CA9A-V2	E184481	Input: 100 to 240 VAC, 50/60 Hz Reset input: 10 mA at 24 VDC Output: Transistor output, 100 mA at 24 VDC, parallel interface, serial interface
V600-HAR91 V600-HAR92 V600-HAM91 V600-HAR81 V600-HAM81	E104818 (UL508)	Intelligent Flag Series Amplifier Input: 130 mA at 24 VDC
V600-HS51 V600-HS61 V600-HS63 V600-HS67		Intelligent Flag Series Sensor
V600-A14	E131841 (UL508)	Battery Charger for V600-CB-US-S Input: 120 VAC, 60 Hz Output: 0.3 A at 7.8 VDC

Code Readers

Model	File No.	Ratings
V530-R150E-3/EP-3 V530-R160E V530-C300E	E41515	Refer to the following information.

The V530-R150E-3/EP-3, V530-R160E, and V530-C300E have DC power supply specifications. Ensure that the following conditions are satisfied.

Connect the V530-R150E-3/EP-3 or V530-R160 to the type of circuit described in either 1 or 2 below.

1. Limited Voltage/Current Circuit (approved by UL508)

A circuit for which the power supply is the secondary winding of an isolating transformer that satisfies the following conditions:

- Maximum voltage (with no load): 30 Vrms (42.4 Vpeak) max.
- Maximum current: 8 A max. (including short-circuits) or the circuit must be limited by a circuit protection device (e.g., a fuse) with the ratings shown in the following table.

No-load voltage (Vpeak)	Maximum current rating
0 to 20	5.0
More than 20 but no more than 30	100 ÷ Peak voltage value

2. A circuit (Class 2 circuit) for which the power supply is either a Class 2 power supply unit that satisfies UL1310 or a Class 2 transformer that satisfies UL1585, with a maximum voltage of 30 Vrms (42.4 Vpeak).



RFID Systems

Model	File No.	Ratings
V600-CA1A-V2 V600-CA2A-V2 V600-CA8A-V2 V600-CA9A-V2	LR46463 (CSA22.2 No. 1010.1/ CB46463-49)	Input: 100 to 240 VAC, 50/60 Hz Reset input: 10 mA at 24 VDC Output: Transistor output, 100 mA at 24 VDC, parallel interface, serial interface
V600-A14	LR92770 (CSA22.1)	Battery Charger for V600-CB-US-S Input: 120 VAC, 60 Hz Output: 0.3 A at 7.8 VDC

Product Lineup	A- 3	
Product Variations.....	A- 5	
System Configuration.....	A-10	
V600 Series.....	A-14	
ID Sensor Unit	CJ1W-V600C11/V600C12	
	CS1W-V600C11/V600C12.....	A-45
Intelligent Flag I/II	V600-HA.....	A-49
Intelligent III	V600HAM42-DRT	A-63
V670 Series.....	A-71	
V700 Series.....	A-77	
Electromagnetic Inductive RFID System for Semiconductor Industry		
	V700 for Semiconductor Industry.....	A-88
V720 Series.....	A-97	

Product Lineup

Non-contact data communication that fuses information to the physical world.

Product Features and Configuration

Short Distance



V600 System (page A- 14)

- Short-distance up to distance of 100 mm.
- Lineup includes Built-in-battery Data Carriers (8 kbytes) and Battery-less Data Carriers (256 bytes).
- The Data Carriers are thin, compact, and economical.
- The system offers high resistance to the environment, noise, and heat: models resistant to temperatures of up to 150_C are available.
- Lineup also includes Intelligent Flag Series that handles mechanical flag and Kanban applications.
- DeviceNet compatibility is also available with the Intelligent Flag III System.
- Direct connection to an OMRON PLC bus is possible using the ID Sensor Unit.
- Compact, lightweight Handheld Reader Writer available

Short Distance



V670 System (page A- 71)

- High-speed communications requiring only 14 ms to read or write 128 bytes of data.
- Long-life battery-free Data Carriers to read and write data 1,000 million times.
- Versatile functions, such as auto repeat, repeat input trigger, and tag specification.
- Self-execution mode for data processing with no host controller intervention.

Medium Distance



V700 (page A- 77)

- A medium transmission distance of 250 mm max. and a wide transmission range of 50 cm.
- Equipped with multiple access function to enable reading and writing for several ID Tags in the Antenna's transmission range.
- Easy-to-use, reasonably-priced ID Tags for applications using a large number of Tags.
- The series includes a Link Unit and a Compact Reader Writer to allow simultaneous control for several Antennas.

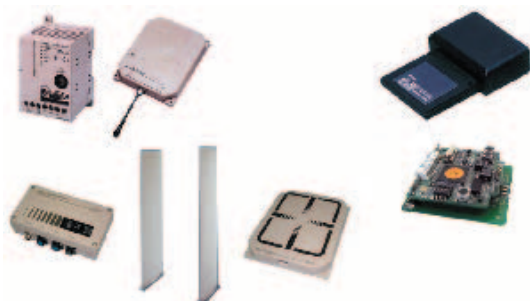

V720 (page A- 97)

- A medium transmission distance of 1000 mm max.
- Equipped with multiple access function to enable reading and writing for several ID Tags in the Antenna's transmission range.
- Easy-to-use, low-priced ID Tags for applications using a large number of Tags.
- Special antenna shapes available. Example: gate reader.
- Communications according ISO 15693.

Functionality (max values in list, see specs for details)	Omron RFID system			
	V600	V670	V700	V720
Operating frequency	530kHz	13,56MHz	125kHz	13,56MHz
Max. transmission distance	100mm	30mm	250mm	1400mm
Max. memory size available tags	8 kbytes	128 bytes	256 bytes	128 bytes
Memory type	EEPROM/SRAM	Fe RAM	EEPROM	EEPROM
Read(R) / Write(W) tags	R/W	R/W	R/W	R/W
Number of data rewrites	800.000	1000 million!	100.000	100.000
Data holding time	10 years	10 years	10 years	10 years
Ambient temperature during read/write	-40/110°C	-10/70°C	-25/70°C	-10/70°C
Ambient temperature during storage	-40/110°C	-10/70°C	-40/110°C	-30/70°C
Thermal shock	150°C 1000h	-	180°C 200h	80°C 250h
Max. reading speed examples(bytes/ms)	128/280	128/14,6	128/834	128/48
Standard	-	-	-	ISO 15693
PLC controller card available	+	-	-	-
Single access	+	+	+	+
First In First Out (FIFO) functionality	-	+	+	+
Selective Access	-	+	+	+
Multiple Read	-	-	+	+
Mounting tag on metal	++	-	+	0
Chemical resistant tags	++	+	+	0
Max IP value tags	IP68	IP67	IP68	IP67
Noise immunity	++	++	+	0
Handheld solution available	+	-	+	+
Block shaped tag	+	+	-	+
Coin shaped tag	+	-	+	0
Stick shaped tag	-	-	+	-
Card shaped tag	+	-	-	+
Inlet only	-	-	-	+
Customised tagshapes available	-	-	+	++

Product Variations

■ V600 Series

V600 Built-in-battery Data Carriers



Large-capacity V600 Tags

- Maximum transmission distance: 100 mm
- Mounts to metal surfaces.
- Flush-mounts in metal bases.
- Medium-size
- Water-resistant
- Oil-resistant
- Large capacity
- Unlimited number of overwrites

V600 Rectangular R/W Heads

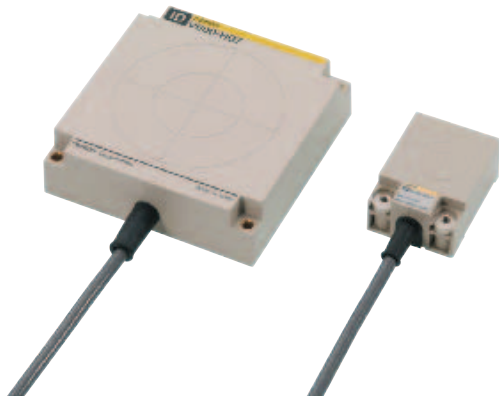

Flexible Transmission Distance

- Maximum transmission distance: 100 mm
- Mounts to metal surfaces.
- Medium-size model
- Compact model
- Water-resistant
- Oil-resistant

V600 Battery-less Data Carriers

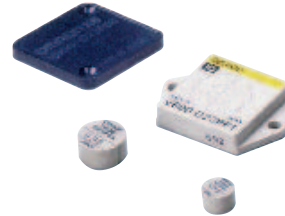

Flexible Lineup for a Variety of Applications

- Maximum transmission distance: 70 mm.
- Mounts to metal surfaces.
- Flush-mounts in metal bases.
- Medium-size model
- Compact model
- Miniature model
- Oil-resistant
- Chemical-resistant
- Storage at high temperatures
- Storage at very high temperatures
- Battery-less
- Number of overwrites: 100,000 times

V600 Round R/W Heads



Easy Mounting on Metal Surfaces

- Maximum transmission distance: 30 mm
- Mounts to metal surfaces.
- Flush-mounts in metal bases.
- Compact model
- Miniature model
- Water-resistant
- Oil-resistant

V600 Separate-amplifier R/W Head



Miniature Design Allows Mounting Almost Anywhere

- Maximum transmission distance: 100 mm
- Mounts to metal surfaces.
- Flush-mounts in metal bases.
- Separate amplifier and sensor
- Miniature
- Water-resistant
- Oil-resistant

V600 AC-type ID Controller



Offering a Variety of Host Interfaces

- Medium-size
- Connects to Monitor Unit.
- Supports connection of several R/W Heads.
- AC power supply
- RS-232C
- RS-485

V600 DC-type ID Controller



Low-cost DC Version

- Compact
- Board-type
- Connects to Monitor Unit.
- DC power supply
- RS-232C

V600 Handheld ID Controller



Enabling Portable Operation

- Medium-size
- Handheld
- Rechargeable model
- Battery-powered model
- AC adapter

V600 ID Controller for Incorporating in PLC



Ideal for Connection to OMRON PLCs

- Supports connection of several R/W Heads.
- Power supplied from PLC
- DC power supply
- Available for CJ1 PLCs
- Available for CS1 PLCs
- Available for C200H, C500, C1000H, and C2000H

V600 Intelligent Flag Series

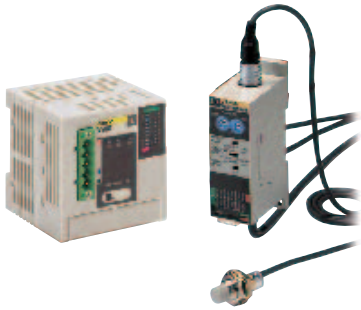

Innovative Electronic Flags to Replace Mechanical Flags

- Compact
- DC power supply
- Open collector output
- DeviceNet interface

Sensor

- Maximum transmission distance: 100 mm
- Mounts to metal surfaces.
- Flush-mounts in metal bases.
- Medium-size model
- Compact model
- Miniature model
- Oil-resistant
- Water-resistant

■ V670 Series

V670 Tags



High-speed, Long-life V670 Tags

- Maximum transmission distance: 23 mm
- Compact
- Water-resistant
- Number of accesses: 1,000 million times
- Battery-less

V670 Antenna



Ideal for High-speed Production and Conveyance Lines

- Maximum transmission distance: 23 mm
- Mounts to metal surfaces.
- Compact
- Water-resistant
- High-speed transmission

V670 Controller



Operation Possible without Host Controller

- Compact
- Self-execution mode
- Supports connection to Programming Console.
- DC power supply
- RS-232C

■ V700 Series

V700 ID Tags



Ideal for Applications Using a Large Number of Tags

- Maximum transmission distance: 250 mm
- Mounts to metal surfaces (using a holder).
- Compact model
- Miniature model
- Storage at high temperatures
- Storage at very high temperatures
- Water-resistant
- Oil-resistant
- Chemical-resistant
- Number of overwrites: 100,000 times
- Battery-less

V700 Antenna



Wide Transmission Range

- Maximum transmission distance: 250 mm
- Large model
- Very large model
- Transmission for multiple tags

V700 Controller



Compatible with Two Types of Host Interface

- Compact
- Programming Console
- Noise measurement function
- DC power supply
- RS-232C
- RS-485

V700 Compact Reader Writer



Compact, Low-cost Reader Writer

- Maximum transmission distance: 43 mm
- Mounts to metal surfaces
- Compact
- Water-resistant
- Oil-resistant
- Built-in controller
- AC adapter
- DC-type Interface Conversion Unit
- RS-232C

V700 for Semiconductor Industry



Special Lineup for the Semiconductor Industry

- Transmission range conforms to SEMI standards.
- Tags cleaned with purified water.
- Installation dimensions conform to SEMI standards.
- Compatible with SECS protocol.

System Configuration

■ V600 Battery-less Data Carriers

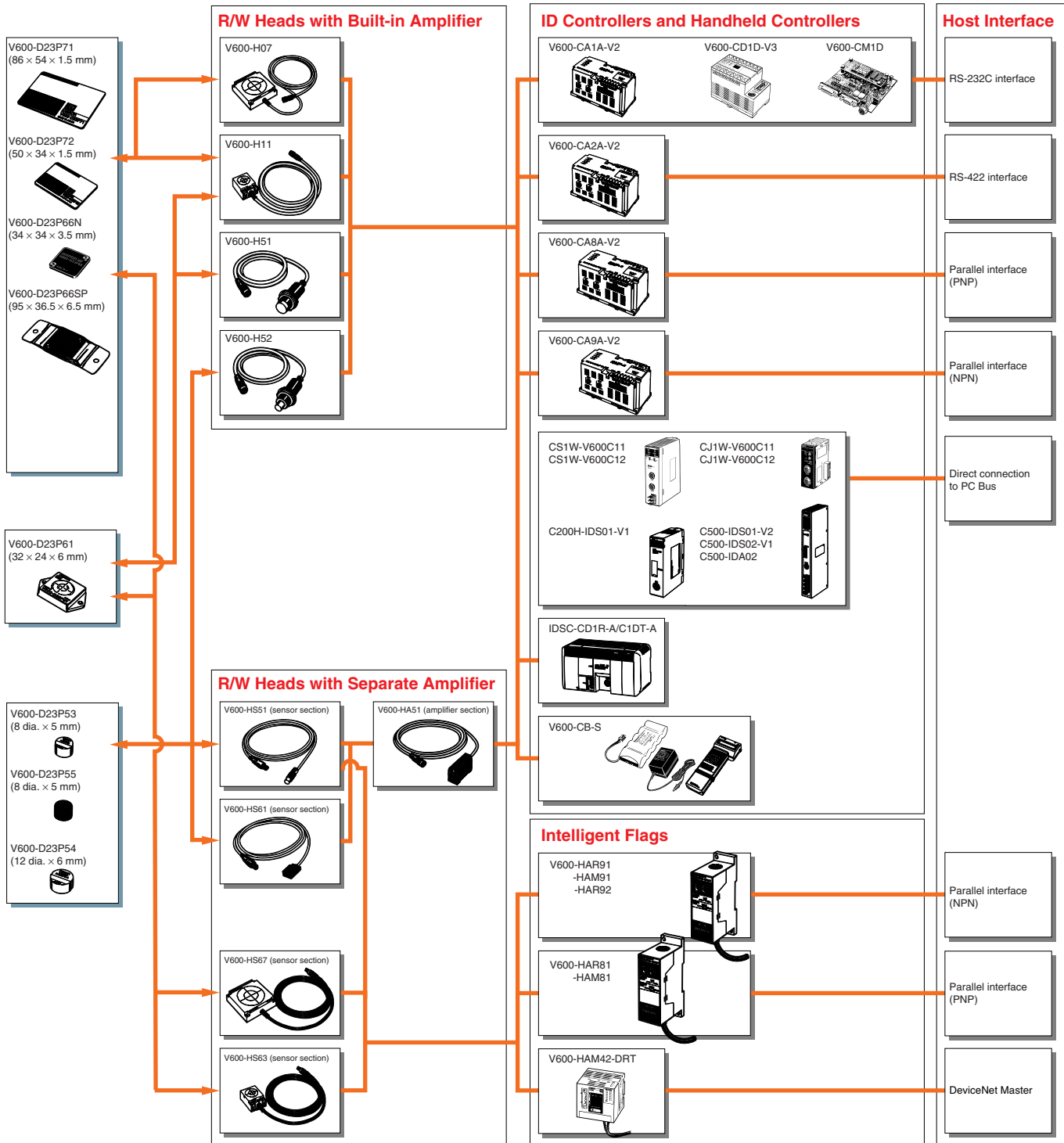

Note: 1. There are restrictions for the following Controllers when using EEPROM (battery-less).

Data Carriers:

V600-CA□A: Software version 5.0 or higher

V600-CD1D/CM1D: Software version 2.0 or higher

V600-CB: Software version 2.0 or higher

ID Sensor Unit: V1 or higher for C200H-IDS01 or C500-IDS02 and V2 for C500-IDS01.

2. There is no compatibility between V600, V670, and V700 products.

■ V600 Built-in-battery Data Carriers

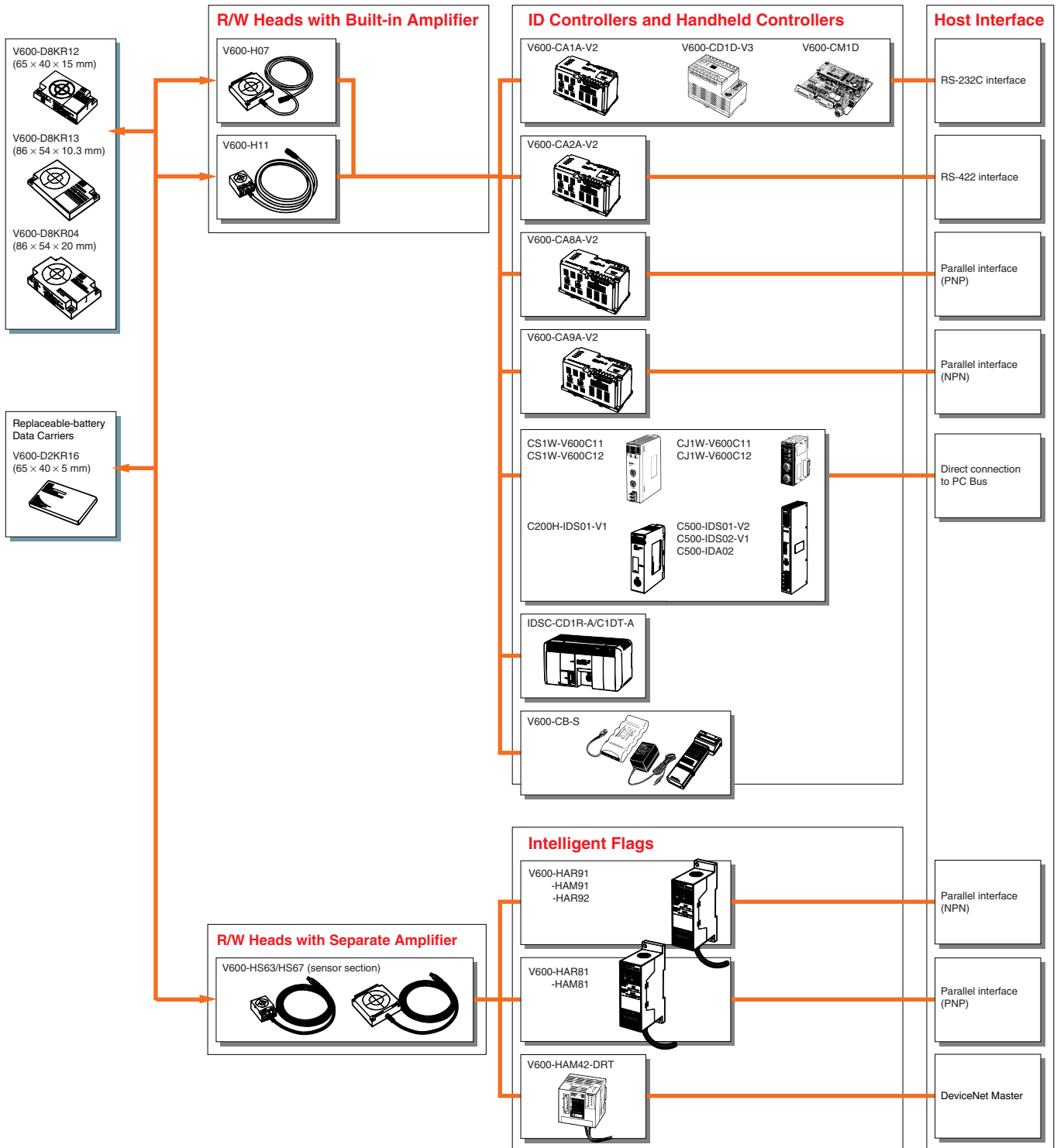

Note: There is no compatibility between V600, V670, and V700 products.

■ V670 Series

ID Tag



Antenna

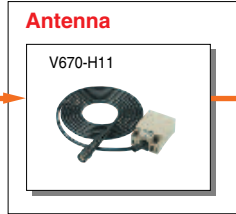

Controller

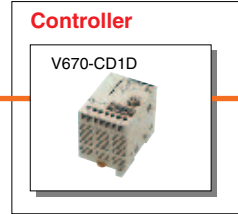

Host interface

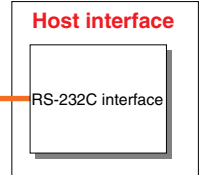

Note: There is no compatibility between V600, V670, and V700 products.

■ V700 Series

ID Tag

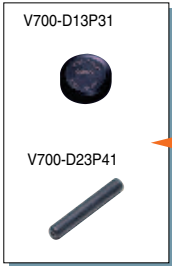

Antenna

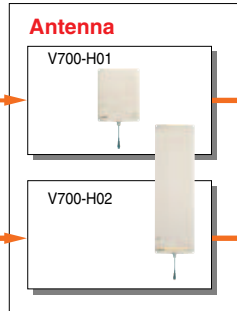

Cable

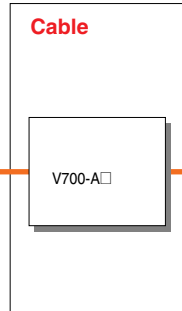

Controller

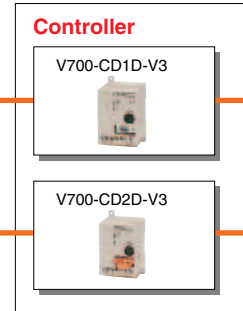

Host interface

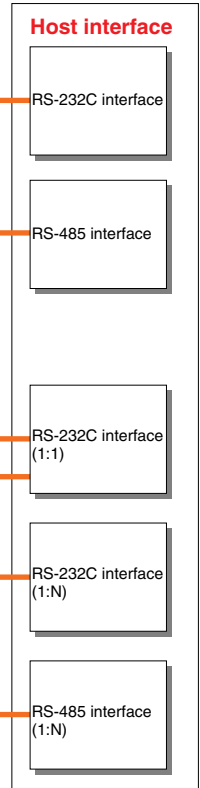

Compact Reader Writer



ID Link Unit



■ V700 for Semiconductor Industry

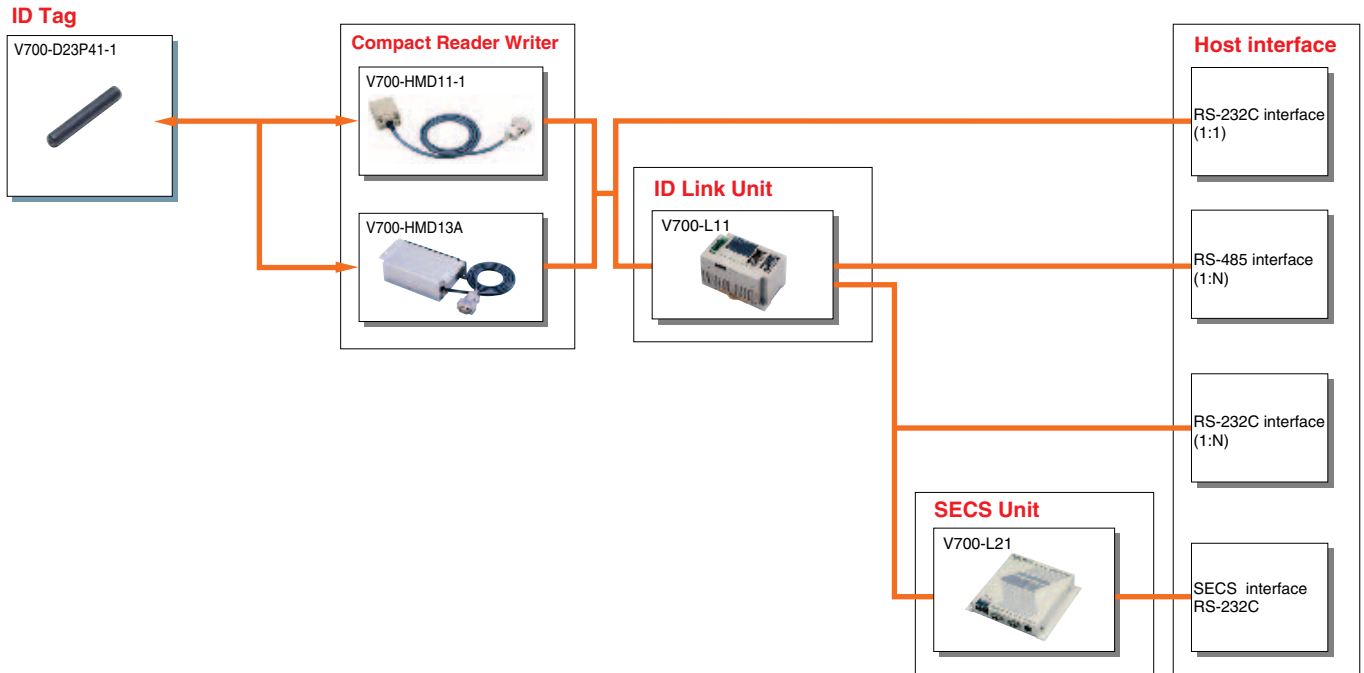

Note: There is no compatibility between V600, V670, and V700 products.

ALL DIMENSIONS SHOWN ARE IN MILLIMETERS.
 To convert millimeters into inches, multiply by 0.03937. To convert grams into ounces, multiply by 0.03527.

Electromagnetic Coupling RFID System V600













Non-contact Data Communications System

- Superior environmental resistance.
- Heat-resistant type available (150°C max.).
- High memory capacity of 8 Kbytes for Built-in-battery Data Carriers and 254 bytes for Battery-less Data Carriers.
- Built-in-battery Data Carriers have a battery life detecting function.
- Data of Battery-less Data Carriers can be overwritten 300,000 times at normal temperatures.
- Thin, compact, and low-cost Data Carriers are available.
- Transmission distance of 100 mm max.



Ordering Information





■ Data Carriers

Item	Model		Specifications/Design/Memory capacity	
Built-in-battery DCs	V600-D8KR12		Rectangular compact 65 × 40 × 15 mm	8 Kbytes
	V600-D8KR13		Thin rectangular 86 × 54 × 10.3 mm	
	V600-D8KR04		Intermediate-range rectangular 86 × 54 × 20 mm	
Replaceable-battery DCs	V600-D2KR16		Compact 65 × 40 × 5 mm	2 Kbytes
Battery-less DCs	V600-D23P71		Ultrathin card-type 86 × 54 × 1.5 mm	254 bytes
	V600-D23P72		Thin half-size card-type 50 × 34 × 1.5 mm	
	V600-D23P66N		Rectangular 34 × 34 × 3.5 mm	
	V600-D23P66SP		Rectangular package with PFA 95 × 36.5 × 6.5 mm	
	V600-D23P61		Rectangular compact 32 × 24 × 6 mm	
	V600-D23P53		Round super-compact 8 dia. × 5 mm	
	V600-D23P54		Round compact 12 dia. × 6 mm	
	V600-D23P55		Round super-compact 8 dia. × 5 mm	



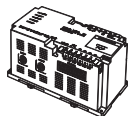

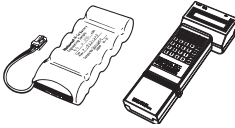
■ R/W Heads

Item		Model	Specifications/Design			
Rectangular type		V600-H07 (0.5 m)		Dimensions: 100 × 100 × 30 mm	0.5-m cable	
		V600-H07 (2 m)			2-m cable	
		V600-H07 (5 m)			5-m cable	
		V600-H07 (10 m)			10-m cable	
			V600-H11 (0.5 m)		Dimensions: 53 × 40 × 23 mm	0.5-m cable
			V600-H11-R (0.5 m)			0.5-m cable
			V600-H11 (2 m)			2-m cable
			V600-H11 (5 m)			5-m cable
			V600-H11 (10 m)			10-m cable
	Cylinder type		V600-H51 (0.5 m)		Dimensions: 22 dia. × 80 mm	0.5-m cable
V600-H51 (2 m)			2-m cable			
V600-H51 (5 m)			5-m cable			
V600-H51 (10 m)			10-m cable			
			V600-H52 (0.5 m)		Dimensions: 22 dia. × 85 mm	0.5-m cable
			V600-H52 (2 m)			2-m cable
			V600-H52 (5 m)			5-m cable
			V600-H52 (10 m)			10-m cable
Separate-amplifier type	Amplifier section	V600-HA51 (2 m)		73.8 × 22.6 × 36.5 mm, with 2-m cable		
		V600-HA51 (5 m)			73.8 × 22.6 × 36.5 mm, with 5-m cable	
		V600-HA51 (10 m)			73.8 × 22.6 × 36.5 mm, with 10-m cable	
	Sensor section	V600-HS51		12 dia. × 35 mm deep, with 2-m cable		
		V600-HS61				30.5 × 18 × 10 mm, with a 2-m cable

■ ID Controllers

Item	Model	Specifications/Design		
AC Power Supply	V600-CA1A-V2		100 to 240 VAC, 50/60 Hz Two R/W Head connectors 200 × 100 × 100 mm	RS-232C host interface
	V600-CA2A-V2			RS-422 host interface
	V600-CA8A-V2			Parallel PNP host interface
	V600-CA9A-V2			Parallel NPN host interface
DC Power Supply	V600-CD1D-V3		24 VDC R/W Head connectors 115 × 68 × 80 mm	RS-232C host interface
	V600-CM1D			
Handheld Controller	V600-CB-US-S		A Battery Charger, Ni-Cd Battery Pack, Battery Case, and Carrying Belt are included.	
AC Power Supply	IDSC-C1DR-A		100 to 240 VAC, 50/60 Hz Relay contact output type	
	IDSC-C1DT-A			150 to 240 VAC, 50/60 Hz Transistor output type

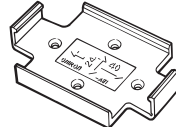
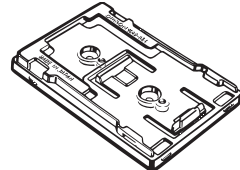
■ Accessories (Order Separately)

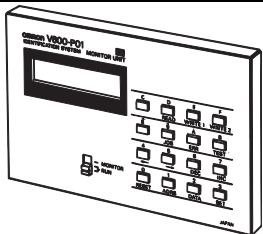
Item	Model		Specifications/Design		
Extension cable for R/W Heads	V600-A45		Standard cable Non-water-resistant connectors	3-m cable	
	V600-A44			5-m cable	
	V600-A40			10-m cable	
	V600-A41			20-m cable	
	V600-A42			30-m cable	
	Holder	V600-A56		Robotic cable Non-water-resistant connectors	3-m cable
		V600-A55			5-m cable
		V600-A50			10-m cable
		V600-A51			20-m cable
		V600-A52			30-m cable
Holder	V600-A81		For the V600-D2KR16 *Mount with M3 flat countersunk head screws (at least two).		
	V600-A84		For the V600-D23P71/D23P72 Ultrasonic deposition can be used on the plastic container.		
Attachment	V600-A86		For the V600-D23P66N		
Lithium battery	V600-A82 (5 in each set)		For the V600-D2KR16 Commercially available CR2016 battery (includes replacement battery cover seal, and cover)		
Monitor Unit	V600-P01		Special Unit for the V600-CA□A-□ Controller		

■ RS-232C Cables (Order Separately)

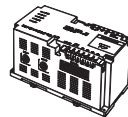
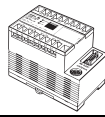



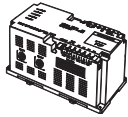
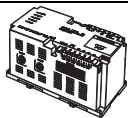
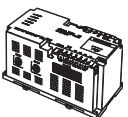



Model	Cable length	Compatible ID Controllers	
XW2Z-200P	2 m	V600-CA1A-V2	
XW2Z-500P	5 m		
XW2Z-200S	2 m	V600-CD1D-V3 V600-CM1D	
XW2Z-500S	5 m		

■ Connectors for ID Controllers (One Set per Unit)

Model	Name	Compatible ID Controllers	
XM2A-0901	Connector Plug	V600-CA2A-V2 V600-CD1D-V3 V600-CM1D	
XM2S-0911	Connector Hood		
XM2A-2501	Connector Plug	V600-CA1A-V2	
XM2S-2511	Connector Hood		
MR-50F (Honda Tsushin Kogyo)	Connector Plug	V600-CA8A-V2 V600-CA9A-V2	
MR-50L (Honda Tsushin Kogyo)	Connector Hood		





Specifications

■ Battery-less Data Carriers

Shape	Ultrathin Card-type	Ultrathin Half-size Card-type	Rectangular Compact	Chemical-resistant	Rectangular Compact	Round Super-compact	Round Compact	Round Super-compact
Model	V600-D23P71	V600-D23P72	V600-D23P66N	V600-D23P66SP	V600-D23P61	V600-D23P53	V600-D23P54	V600-D23P55
Item								
Memory capacity	254 bytes							
Memory type	EEPROM (non-volatile memory)							
Transmission distance	Refer to "Transmission Distance Specifications for Battery-less DCs" on page 24.							
Data retention time (after writing data)	10 years	10 years (-40 to 110°C) 1 year (-40 to 150°C)	10 years (-40 to 110°C) 1 year (-40 to 150°C)	10 years	10 years	10 years (-40 to 110°C) 1 year (-40 to 150°C)	10 years (-40 to 110°C) 1 year (-40 to 150°C)	10 years (-40 to 110°C) 1 year (-40 to 150°C)
Number of overwrites (per address) (Refer to separate item for ambient temperature)	Up to 0°C	800,000 times						
	Up to 25°C	400,000 times						
	Up to 60°C	300,000 times						
	Up to 85°C	100,000 times						
Transmission error detection	16-bit CRC in both directions (CRC: Cyclic Redundancy Check)							
Ambient temperature	For data storage	-20 to 110°C	-40 to 150°C (See note.)	-40 to 110°C	-40 to 85°C	-40 to 150°C (See note.)	-40 to 150°C (See note.)	-40 to 150°C (See note.)
	For reading/writing	-10 to 70°C	-20 to 85°C	-20 to 70°C	-25 to 70°C	-25 to 85°C	-25 to 85°C	-25 to 85°C
Storage temperature	-20 to 110°C	-40 to 150°C (See note.)	-40 to 110°C	-40 to 85°C	-40 to 150°C (See note.)	-40 to 150°C (See note.)	-40 to 150°C (See note.)	-40 to 150°C (See note.)
Ambient humidity	Operating: 35% to 95%							
Degree of protection	IEC 60529: IP67		IEC 60529: IP68	IEC 60529: IP67	IEC 60529: IP67			IEC 60529: IP67
Vibration resistance (destruction)	10 to 2,000 Hz, 3.0-mm double amplitude, 300 m/s ² acceleration for 30 min each in 3 directions (90 min total)		10 to 2,000 Hz, 1.5-mm double amplitude, 150 m/s ² acceleration 10 times each in 3 directions (15 min)	10 to 2,000 Hz, 3.0-mm double amplitude, 300 m/s ² acceleration for 30 min each in 3 directions (90 min total)			10 to 2,000 Hz, 1.5-mm double amplitude, 150 m/s ² acceleration 10 times each in 3 directions (15 min)	
Shock resistance (destruction)	1,000 m/s ² 3 times each in 3 directions (18 times total)		500 m/s ² 3 times each in 3 directions (18 times total)	1,000 m/s ² 3 times each in 3 directions (18 times total)			500 m/s ² 3 times each in 3 directions (18 times total)	
Weight	Approx. 15 g	Approx. 5 g	Approx 6.5 g	Approx. 19 g	Approx. 5.8 g	Approx. 0.4 g	Approx. 1.0 g	Approx. 0.6 g

Note: The 150°C heat resistance was confirmed by leaving the Unit at 150°C for 1,000 continuous hours, and by a thermal shock test consisting of 1,000 -10°C/150°C cycles of 30 min each. No defect was found among the 22 test samples.

■ Built-in-battery Data Carriers



Shape	Rectangular Compact	Rectangular Thin	Rectangular Intermediate Range	Rectangular Compact with Replaceable Battery
Model	V600-D8KR12 	V600-D8KR13 	V600-D8KR04 	V600-D2KR16 
Item				
Memory capacity	8 Kbytes			2 Kbytes
Memory type	SRAM (volatile memory)			
Transmission distance	Refer to "Transmission Distance Specifications for Built-in-battery DCs" on page 29			
Battery life (See note 1.)	Refer to "Battery Life" on page 35			2 years (at 25°C) (See note 2.)
Number of reads/writes	Unlimited			Unlimited (Does not affect battery life)
Transmission error detection	16-bit CRC in both directions (CRC: Cyclic Redundancy Check)			
Ambient temperature	For data storage	-40 to 70°C		-15 to 70°C
	For reading/writing	-25 to 70°C		0 to 50°C
Storage temperature	-40 to 70°C		-15 to 70°C	
Ambient humidity	35% to 95%		35% to 85%	
Storage humidity	35% to 95%			
Degree of protection	IEC 60529: IP67			IEC 60529: IP50 (dustproof) (See note 3.)
Vibration resistance (destruction)	10 to 500 Hz, 1.0-mm single amplitude, 150 m/s ² acceleration for 11 min each in X, Y, and Z directions			10 to 150 Hz, 0.75-mm single amplitude, 100-m/s ² acceleration for 30 min each in X, Y, and Z directions
Shock resistance (destruction)	1,000 m/s ² 3 times each in X, Y, and Z directions (18 times total)			300 m/s ² 3 times each in X, Y, and Z directions (18 times total)
Weight	Approx. 70 g		Approx. 160 g	Approx. 15 g

Note: 1. A low battery detection function is built-in.

2. The battery life is applicable for batteries used at a temperature of 25°C. Refer to "Temperature and Battery Life" on page 35 for details on the relationship between temperature and battery life. The CR2016 is provided as the replacement battery. Refer to page 16 for details on accessories.

3. The Data Carrier is dustproof when the provided battery replacement cover seal is used.

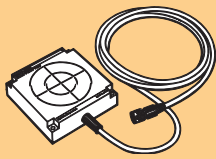
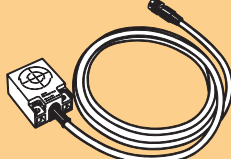
■ Read/Write (R/W) Heads (with Built-in Amplifier)

Model	V600-H07	V600-H11/H11-R	V600-H51	V600-H52
Item				
Oscillation frequency	530 kHz			
Ambient temperature	-25 to 70°C		-10 to 60°C	
Storage temperature	-40 to 85°C		-25 to 75°C	
Ambient humidity	35% to 95%			
Storage humidity	35% to 95%			
Insulation resistance	50 MΩ (at 500 VDC) between cable terminals and case			
Dielectric strength	1,000 VAC, 50/60 Hz for 1 min between cable terminals and case (Leakage current: 1 mA max.)			
Degree of protection	IEC 60529: IP67			
Vibration resistance (destruction)	10 to 500 Hz, 1.0-mm single amplitude, 150 m/s ² acceleration with 3 sweeps of 11 min each in X, Y, and Z directions			
Shock resistance	Destruction: 500 m/s ² 3 times each in X, Y, and Z directions (18 times total)			
Cable length (See note 1.)	Standard lengths of 0.5 m, 2 m, 5 m, and 10 m.			
Wireless transmission error detection	16-bit CRC in both directions (CRC: Cyclic Redundancy Check)			
Indicators	Power: green; transmission: orange			
Weight	Approx. 1 kg (with 10-m cable)	Approx. 650 g (with 10-m cable)		

Note: 1. Extension cables are also available. The maximum cable length is 30.5 m for the V600-H07 and 50.5 m for the V600-H11/H51/H52.
 2. The connectors are not water-resistant.

■ R/W Heads (with Separate Amplifier)

Item	Sensor section		Amplifier section	
	V600-HS51	V600-HS61	V600-HA51	
Oscillation frequency	530 kHz		---	
Ambient temperature	-10 to 60°C			
Storage temperature	-25 to 75°C			
Ambient humidity	35% to 95%			
Insulation resistance	50 MΩ (at 500 VDC) between cable terminals and case			
Dielectric strength	1,000 VAC 50/60 Hz for 1 min between cable terminals and case (Leakage current: 1 mA max.)			
Degree of protection	IEC 60529: IP67		IEC 60529: IP66	
Vibration resistance (destruction)	10 to 2,000 Hz, 1.5-mm single amplitude, 300 m/s ² acceleration with 2 sweeps of 15 min each in 3 directions		Installed in panel	10 to 2,000 Hz, 1.5-mm single amplitude, 300-m/s ² acceleration with 2 sweeps of 11 min each in 3 directions
			DIN Track installation	10 to 500 Hz, 1.0-mm single amplitude, 150-m/s ² acceleration with 3 sweeps of 11 min each in 3 directions
Shock resistance (destruction)	1,000 m/s ² 3 times each in 3 directions (18 times total)		500 m/s ² 3 times each in 3 directions (18 times total)	
Cable length	Sensor to amplifier	2 m (fixed)		---
	Amplifier to controller	---		Standard lengths of 2 m, 5 m, and 10 m (See note 1.)
Wireless transmission error detection	16-bit CRC in both directions (CRC: Cyclic Redundancy Check)			
Indicators	---		Power: green; transmission: orange	
Weight	Approx. 70 g (with 2-m cable)		Approx. 650 g (with 10-m cable)	

Note: 1. Extension cables are also available. The maximum cable length is 50 m for the V600-HA51. Extension cables are not available for the V600-HS51/HS61.

2. The connectors are not water-resistant.

■ ID Controllers

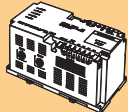
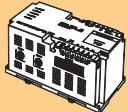
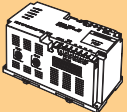
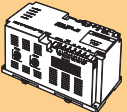
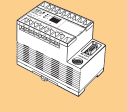
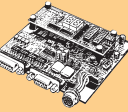
Series Model	V600 Series (Electromagnetic RFID System)					
	V600-CA1A-V2	V600-CA2A-V2	V600-CA8A-V2	V600-CA9A-V2	V600-CD1D-V3	V600-CM1D
Item						
Host interface	RS-232C	RS-422A (Maximum of 16 Units can be connected)	Parallel PNP output	Parallel NPN output	RS-232C	
Possible number of R/W Heads	2				1	
Power supply voltage	100 to 240 VAC, 50/60 Hz				24 VDC	24 VDC, 5 VDC
Acceptable power supply voltage	85 to 264 VAC				20.4 to 26.4 VDC	20.4 to 26.4 VDC 4.5 to 5.5 VDC
Power consumption	35 VA max.				7.2 W max.	24 VDC: 7.2 W max. 5 VDC: 1.5 W max.
Insulation resistance	50 MΩ min. (at 500 VDC) between power terminals and case, between I/O terminals and case, or between the power supply terminals and I/O terminals					
Dielectric strength	1,500 VAC, 50/60 Hz for 1 min between the points listed above; Leakage current: 10 mA max.				1,000 VAC, 50/60 Hz for 1 min between the points listed above; Leakage current: 10 mA max.	
Noise immunity	1,500-V (p-p) pulses of 100-ns to 1-μs pulse width with a 1-ns rise time					
Vibration resistance	Destruction	10 to 150 Hz, 0.3-mm double amplitude for 32 min each in X, Y, and Z directions				
	Malfunction	10 to 150 Hz, 0.2-mm double amplitude for 32 min each in X, Y, and Z directions				
Shock resistance	Destruction: 200 m/s ² 3 times each in X, Y, and Z directions (18 times total)					
Ambient temperature	-10 to 55°C				0 to 50°C	
Ambient humidity	35% to 85% (with no condensation)					
Operating conditions	No corrosive gases					
Storage temperature	-25 to 65°C				-15 to 70°C	
Memory back-up	A capacitor backs up the most recent error data and statistical error data for up to 20 days (at 25°C) after a power interruption.				Memory backup is not available. Error details, however, can be read from the personal computer when the power is turned ON.	
Diagnostic functions	Checks for CPU errors, memory errors, power interruptions, and transmission errors					
Ground	Ground to 100 Ω or less.					
Degree of protection	IEC 60529: IP30 (panel mounted)					
Weight	Approx. 890 g	Approx. 930 g	Approx. 960 g		Approx 360 g	Approx. 180 g

■ Monitor Unit

V600-P01 (for use with V600-CA□A Controllers)

The Monitor Unit is a monitoring device that can be mounted to an ID Controller. It can be used to test communications between the R/W Head and Data Carrier when the RFID System is started up, check the data in Data Carriers, and read error information or statistical error information.

The specifications conform to those of the ID Controller, except the operating temperature range is 0°C to 40°C.

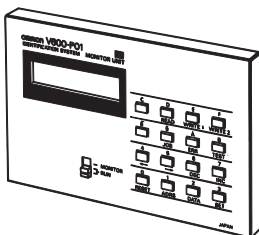

■ Handheld ID Controllers

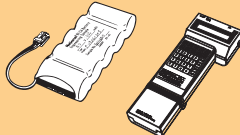
Model	V600-CB-US-S
Item	
Power supply	Built-in nickel-cadmium batteries (6 VDC) or 9-V alkaline batteries (9 VDC) (See note.)
Power consumption	700 mA max.
Continuous operating time (See note.)	3 hrs min. when using the built-in nickel-cadmium batteries; 1.5 hrs min. when using the alkaline batteries
Automatic power-saver	The power is turned OFF automatically if a key input or response is not received in 10 min.
Automatic command cancellation	A command will be cancelled automatically if a response is not received from a Data Carrier within 2 min.
Low battery indicator	This display appears when the battery voltage falls below the minimum voltage required for operation.
User memory	32 Kbytes (Data will be retained for at least 24 hrs after batteries are removed.)
Vibration resistance	Destruction: 10 to 150 Hz, 0.3-mm double amplitude for 32 min each in X, Y, and Z directions
Shock resistance	Destruction: 200 m/s ² 3 times each in X, Y, and Z directions (18 times total)
Ambient temperature	0 to 45°C
Ambient humidity	35% to 85% (with no condensation)
Operating conditions	No corrosive gases
Storage temperature	-25 to 60°C (excluding the battery pack)
Degree of protection	IEC 60529: IP30
Weight	680 g max. (including the battery pack)

Note: The continuous operating time is for new, fully charged nickel cadmium batteries or new alkaline batteries used at room temperature. Overseas specifications (with UL-listed Battery Charger) also available.

V600-CB-US-S Configuration









Model	Name	Remarks
V600-CB-US	Handheld ID Controller	Controller
V600-A14	Battery Charger	Accessory
V600-A11	Battery Case	Accessory (for alkaline batteries)
V600-A12	Ni-Cd Battery Pack	Accessory (built-in to ID Controller)
V600-A13	Carrying Belt	Accessory

■ IDSC Series

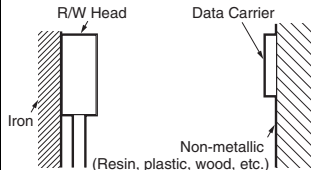





Item	Series Model IDSC Series IDSC-C1DR-A IDSC-C1DT-A 
Host interface	RS-232C
Possible number of R/W Heads	1
Power supply voltage	100 to 240 VAC, 50/60 Hz
Acceptable power supply voltage	85 to 264 VAC
Power consumption	60 VA max.
Insulation resistance	20 Ω min. (at 500 VDC) between all Power Supply Unit AC external terminals and ground terminals
Dielectric strength	2,300 VAC, 50/60 Hz for 1 min between Power Supply Unit AC external terminals and ground terminals Leakage current: 10 mA max.
Noise immunity	1,500-V (p-p) pulses of 100-ns to 1-μs pulse width with a 1-ns rise time
Vibration resistance	10 to 57 Hz, 0.075-mm amplitude, 57 to 150 Hz, 9.8 m/s ² acceleration for 80 min each in X, Y, and Z directions
Shock resistance	150 m/s ² 3 times each in X, Y, and Z directions
Ambient temperature	0 to 55°C
Ambient humidity	10% to 90% (with no condensation)
Operating conditions	No corrosive gases
Storage temperature	-20 to 75°C (excluding the battery pack)
Memory back-up	The battery life is 5 years regardless of whether an RTC is provided. The period that data is retained after a power interruption depends on the ambient temperature. Replace the battery within one week of the battery low indicator flashing.
Diagnostic functions	Checks for CPU errors, memory errors, power interruptions, and transmission errors
Ground	Ground to 100 Ω or less.
Construction	Installed in panel
Weight	Approx. 1,500 g

Note: Refer to the applicable ID Controller Operation Manual (Cat. No. W250) for details.



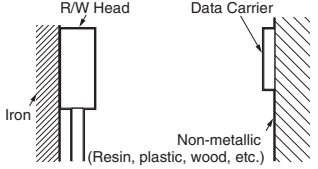

■ Transmission Distance Specifications for Battery-less DCs

Recommended combinations		Installation		Controller mode	Transmission distance	Condition for DC and R/W head installation
Data Carrier	R/W Head		Read/Write distance			
		Stationary	Read/Write distance	Irrelevant	10 to 70 mm (max. axial offset ±10 mm)	 <p>These Data Carriers are for installation on non-metallic surfaces only.</p> <p>Data transmission will be impossible if the DC is installed directly on a metal surface. Refer to the <i>V600 R/W Heads and EEPROM Data Carriers Operation Manual</i> (Cat. No. Z128) for details.</p>
		Moving			30 to 60 mm (max. axial offset ±10 mm)	
		Stationary	Read/Write distance	Irrelevant	5 to 40 mm (max. axial offset ±10 mm)	
		Moving			15 to 40 mm (max. axial offset ±10 mm)	
		Stationary	Read/Write distance	Irrelevant	10 to 50 mm (max. axial offset ±10 mm)	
		Moving			30 to 40 mm (max. axial offset ±10 mm)	
		Stationary	Read/Write distance	Irrelevant	5 to 30 mm (max. axial offset ±10 mm)	
		Moving			15 to 30 mm (max. axial offset ±10 mm)	





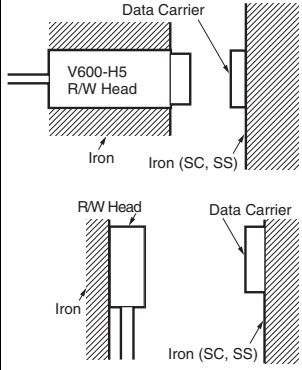



- Note:**
1. The transmission distance/transmission time priority mode setting can be made using the lower-level transmission mode setting switch or memory switch only with a Serial-interface Controller or ID Sensor Unit.
 2. With Parallel-interface Controllers, the mode setting is always transmission distance priority.
 3. The specifications take fluctuations in ambient temperature and slight differences between products into account.

Recommended combinations		Installation		Controller mode	Transmission distance	Condition for DC and R/W head installation
Data Carrier	R/W Head					
		Stationary	Read distance	Transmission distance priority	5 to 45 mm (max. axial offset ±10 mm)	 <p>Data transmission will be impossible if the DC is installed directly on a metal surface. Refer to the <i>V600 R/W Heads and EEPROM Data Carriers Operation Manual</i> (Cat. No. Z128) for details.</p>
				Transmission time priority	5 to 35 mm (max. axial offset ±10 mm)	
			Write distance	Irrelevant	5 to 35 mm (max. axial offset ±10 mm)	
		Moving	Read distance	Transmission distance priority	25 to 40 mm (max. axial offset ±10 mm)	
				Transmission time priority	25 to 30 mm (max. axial offset ±10 mm)	
			Write distance	Irrelevant	25 to 30 mm (max. axial offset ±10 mm)	
		Stationary	Read distance	Transmission distance priority	5 to 30 mm (max. axial offset ±10 mm)	
				Transmission time priority	5 to 25 mm (max. axial offset ±10 mm)	
			Write distance	Irrelevant	5 to 25 mm (max. axial offset ±10 mm)	
		Moving	Read distance	Transmission distance priority	15 to 25 mm (max. axial offset ±10 mm)	
				Transmission time priority	15 to 20 mm (max. axial offset ±10 mm)	
			Write distance	Irrelevant	15 to 20 mm (max. axial offset ±10 mm)	
		Stationary	Read distance	Transmission distance priority	5 to 40 mm (max. axial offset ±10 mm)	
				Transmission time priority	5 to 30 mm (max. axial offset ±10 mm)	
			Write distance	Irrelevant	5 to 30 mm (max. axial offset ±10 mm)	
		Moving	Read distance	Transmission distance priority	20 to 40 mm (max. axial offset ±10 mm)	
				Transmission time priority	20 to 30 mm (max. axial offset ±10 mm)	
			Write distance	Irrelevant	20 to 30 mm (max. axial offset ±10 mm)	
		Stationary	Read distance	Transmission distance priority	5 to 25 mm (max. axial offset ±10 mm)	
				Transmission time priority	5 to 20 mm (max. axial offset ±10 mm)	
			Write distance	Irrelevant	5 to 20 mm (max. axial offset ±10 mm)	
		Moving	Read distance	Transmission distance priority	10 to 25 mm (max. axial offset ±10 mm)	
				Transmission time priority	10 to 20 mm (max. axial offset ±10 mm)	
			Write distance	Irrelevant	10 to 20 mm (max. axial offset ±10 mm)	

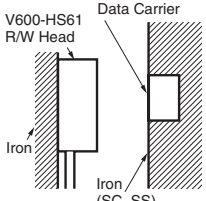
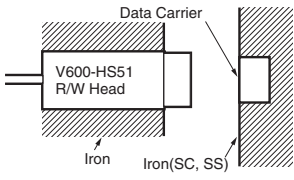
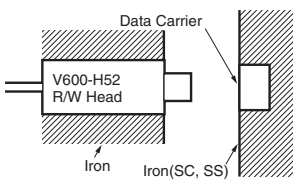



- Note:**
1. The transmission distance/transmission time priority mode setting can be made using the lower-level transmission mode setting switch or memory switch only with a Serial-interface Controller or ID Sensor Unit.
 2. With Parallel-interface Controllers, the mode setting is always transmission distance priority.
 3. The specifications take fluctuations in ambient temperature and slight differences between products into account.

Recommended combinations		Installation		Controller mode	Transmission distance	Condition for DC and R/W head installation
Data Carrier	R/W Head					
V600-D23P61 	V600-H11/-H11-R 	Stationary	Read distance	Transmission distance priority	2 to 19 mm (max. axial offset ±10 mm)	These Data Carriers can be installed on metallic surfaces. 
			Transmission time priority	2 to 16 mm (max. axial offset ±10 mm)		
		Write distance	Irrelevant	2 to 16 mm (max. axial offset ±10 mm)		
		Moving	Read distance	Transmission distance priority	12 to 19 mm (max. axial offset ±10 mm)	
	Transmission time priority		13 to 16 mm (max. axial offset ±10 mm)			
	V600-H51 	Stationary	Read distance	Transmission distance priority	1 to 16 mm (max. axial offset ±10 mm)	
				Transmission time priority	1 to 14 mm (max. axial offset ±10 mm)	
		Moving	Read distance	Transmission distance priority	7 to 16 mm (max. axial offset ±10 mm)	
Transmission time priority				7 to 14 mm (max. axial offset ±10 mm)		
Write distance	Irrelevant	7 to 14 mm (max. axial offset ±10 mm)				

- Note:**
1. The transmission distance/transmission time priority mode setting can be made using the lower-level transmission mode setting switch or memory switch only with a Serial-interface Controller or ID Sensor Unit.
 2. With Parallel-interface Controllers, the mode setting is always transmission distance priority.
 3. The specifications take fluctuations in ambient temperature and slight differences between products into account.



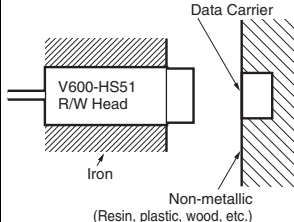





Recommended combinations		Installation		Controller mode	Transmission distance		Condition for DC and R/W head installation
Data Carrier	R/W Head						
V600-D23P53 	V600-HS51 (See note 4.) 	Stationary	Read distance	Transmission distance priority	0.5 to 4.0 mm (max. axial offset ±2 mm)	0.5 to 4.5 mm (max. axial offset ±1 mm)	These Data Carriers are for flush mounting in metallic bases only.   
				Transmission time priority	0.5 to 3.0 mm (max. axial offset ±2 mm)	0.5 to 3.5 mm (max. axial offset ±1 mm)	
			Write distance	Irrelevant	0.5 to 3.0 mm (max. axial offset ±2 mm)	0.5 to 3.5 mm (max. axial offset ±1 mm)	
	V600-HS61 (See note 4.) 	Stationary	Read distance	Transmission distance priority	0.5 to 4.0 mm (max. axial offset ±2 mm)	0.5 to 4.5 mm (max. axial offset ±1 mm)	
				Transmission time priority	0.5 to 3.0 mm (max. axial offset ±2 mm)	0.5 to 3.5 mm (max. axial offset ±1 mm)	
			Write distance	Irrelevant	0.5 to 3.0 mm (max. axial offset ±2 mm)	0.5 to 3.5 mm (max. axial offset ±1 mm)	
	V600-H52 	Stationary	Read distance	Transmission distance priority	0.5 to 4.0 mm (max. axial offset ±2 mm)	0.5 to 4.5 mm (max. axial offset ±1 mm)	
				Transmission time priority	0.5 to 3.0 mm (max. axial offset ±2 mm)	0.5 to 3.5 mm (max. axial offset ±1 mm)	
			Write distance	Irrelevant	0.5 to 3.0 mm (max. axial offset ±2 mm)	0.5 to 3.5 mm (max. axial offset ±1 mm)	
V600-D23P54 	V600-HS51 (See note 4.) 	Stationary	Read distance	Transmission distance priority	0.5 to 6.0 mm (max. axial offset ±2 mm)	0.5 to 6.5 mm (max. axial offset ±1 mm)	The listed transmission distances also apply for installation on non-metallic surfaces. Refer to the <i>V600 R/W Heads and EEPROM Data Carriers Operation Manual</i> (Cat. No. Z128) for details.
				Transmission time priority	0.5 to 5.5 mm (max. axial offset ±2 mm)	0.5 to 6.0 mm (max. axial offset ±1 mm)	
			Write distance	Irrelevant	0.5 to 5.0 mm (max. axial offset ±2 mm)	0.5 to 5.5 mm (max. axial offset ±1 mm)	
	V600-HS61 (See note 4.) 	Stationary	Read distance	Transmission distance priority	0.5 to 6.5 mm (max. axial offset ±2 mm)	0.5 to 7.0 mm (max. axial offset ±1 mm)	
				Transmission time priority	0.5 to 5.5 mm (max. axial offset ±2 mm)	0.5 to 6.0 mm (max. axial offset ±1 mm)	
			Write distance	Irrelevant	0.5 to 5.5 mm (max. axial offset ±2 mm)	0.5 to 6.0 mm (max. axial offset ±1 mm)	
	V600-H52 	Stationary	Read distance	Transmission distance priority	0.5 to 6.5 mm (max. axial offset ±2 mm)	0.5 to 7.0 mm (max. axial offset ±1 mm)	
				Transmission time priority	0.5 to 5.5 mm (max. axial offset ±2 mm)	0.5 to 6.0 mm (max. axial offset ±1 mm)	
			Write distance	Irrelevant	0.5 to 5.5 mm (max. axial offset ±2 mm)	0.5 to 6.0 mm (max. axial offset ±1 mm)	



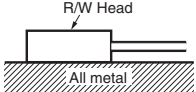
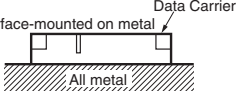

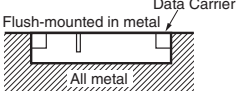
- Note:**
1. The transmission distance/transmission time priority mode setting can be made using the lower-level transmission mode setting switch or memory switch only with a Serial-interface Controller or ID Sensor Unit.
 2. With Parallel-interface Controllers, the mode setting is always transmission distance priority.
 3. The specifications take fluctuations in ambient temperature and slight differences between products into account.
 4. This is the transmission distance when using the V600-HS□1 and V600-HA51 combination.

Recommended combinations		Installation		Controller mode	Transmission distance	Condition for DC and R/W head installation
Data Carrier	R/W Head					
V600-D23P55 	V600-HS51 (See note 4.) 	Stationary	Read distance	Transmission distance priority	0.5 to 6.5 mm (max. axial offset ±2 mm)	These Data Carriers are for flush mounting in non-metallic bases only. 
				Transmission time priority	0.5 to 6.0 mm (max. axial offset ±2 mm)	
			Write distance	Transmission distance priority	0.5 to 6.5 mm (max. axial offset ±2 mm)	
				Transmission time priority	0.5 to 6.0 mm (max. axial offset ±2 mm)	
	V600-HS61 (See note 4.) 	Stationary	Read distance	Transmission distance priority	0.5 to 7.0 mm (max. axial offset ±2 mm)	
				Transmission time priority	0.5 to 6.0 mm (max. axial offset ±2 mm)	
Write distance	Transmission distance priority		0.5 to 7.0 mm (max. axial offset ±2 mm)			
	Transmission time priority		0.5 to 6.0 mm (max. axial offset ±2 mm)			
V600-H52 	Stationary	Read distance	Transmission distance priority	0.5 to 9.0 mm (max. axial offset ±2 mm)		
			Transmission time priority	0.5 to 8.5 mm (max. axial offset ±2 mm)		
		Write distance	Transmission distance priority	0.5 to 8.5 mm (max. axial offset ±2 mm)		
			Transmission time priority	0.5 to 8.5 mm (max. axial offset ±2 mm)		

- Note:**
1. The transmission distance/transmission time priority mode setting can be made using the lower-level transmission mode setting switch or memory switch only with a Serial-interface Controller or ID Sensor Unit.
 2. With Parallel-interface Controllers, the mode setting is always transmission distance priority.
 3. The specifications take fluctuations in ambient temperature and slight differences between products into account.
 4. This is the transmission distance when using the V600-HS□1 and V600-HA51 combination.

■ Transmission Distance Specifications for Built-in-battery DCs

Recommended combinations		Installation		Controller mode	Transmission distance	Condition for DC and R/W head installation	
Data Carrier	R/W Head						
		Stationary	Flush-mounted in metal	Irrelevant	10 to 50 mm (max. axial offset ±10 mm)		
			Surface-mounted on metal		10 to 60 mm (max. axial offset ±10 mm)		
		Moving	Flush-mounted in metal		25 to 50 mm (max. axial offset ±10 mm)		
			Surface-mounted on metal		25 to 60 mm (max. axial offset ±10 mm)		
		Stationary	Flush-mounted in metal		Irrelevant	5 to 40 mm (max. axial offset ±10 mm)	
			Surface-mounted on metal			5 to 45 mm (max. axial offset ±10 mm)	
		Moving	Flush-mounted in metal			25 to 40 mm (max. axial offset ±10 mm)	
			Surface-mounted on metal			25 to 45 mm (max. axial offset ±10 mm)	
		Stationary	Flush-mounted in metal	Irrelevant	10 to 30 mm (max. axial offset ±10 mm)	<p>The listed transmission distances also apply for installation on non-metallic surfaces. Refer to the <i>V600 R/W Heads and SRAM Data Carriers Operation Manual</i> (Cat. No. Z127) for details.</p>	
			Surface-mounted on metal		10 to 35 mm (max. axial offset ±10 mm)		
		Moving	Flush-mounted in metal		20 to 30 mm (max. axial offset ±10 mm)		
			Surface-mounted on metal		20 to 35 mm (max. axial offset ±10 mm)		
		Stationary	Flush-mounted in metal		Irrelevant		10 to 30 mm (max. axial offset ±10 mm)
			Surface-mounted on metal				
		Moving	Flush-mounted in metal				15 to 30 mm (max. axial offset ±10 mm)
			Surface-mounted on metal				

Recommended combinations		Installation		Controller mode	Transmission distance	Condition for DC and R/W head installation	
Data Carrier	R/W Head						
V600-D8KR04 (unsealed) 	V600-H07 	Stationary	Flush-mounted in metal	Irrelevant	See note 1.	The listed transmission distances also apply for installation on non-metallic surfaces. Refer to the <i>V600 R/W Heads and SRAM Data Carriers Operation Manual</i> (Cat. No. Z127) for details.	
			Surface-mounted on metal		10 to 100 mm (max. axial offset ± 10 mm)		
		Moving	Flush-mounted in metal		See note 1.		
			Surface-mounted on metal		50 to 100 mm (max. axial offset ± 10 mm)		
	V600-H11 	Stationary	Flush-mounted in metal		Irrelevant		See note 1.
			Surface-mounted on metal				10 to 65 mm (max. axial offset ± 10 mm)
		Moving	Flush-mounted in metal				See note 1.
			Surface-mounted on metal				30 to 65 mm (max. axial offset ± 10 mm)
V600-D2KR16 	V600-H11 	Stationary	Flush-mounted in metal	Irrelevant		2 to 15 mm (max. axial offset ± 10 mm) (See note 2.)	
			Surface-mounted on metal			2 to 15 mm (max. axial offset ± 10 mm)	
		Moving	Flush-mounted in metal			6 to 15 mm (max. axial offset ± 10 mm) (See note 2.)	
			Surface-mounted on metal			10 to 15 mm (max. axial offset ± 10 mm)	

Note: 1. When Data Carriers are flush-mounted in metal, the read/write distance will depend on the distance (x) between the side of the DC and the metal surface.

2. Use the following method for flush mounting into a metallic base.

Refer to the *V600 R/W Heads and SRAM Data Carriers Operation Manual* (Cat. No. Z127) for details.

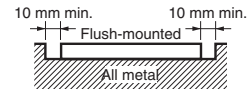
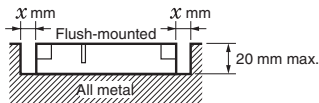

Combined with V600-H07

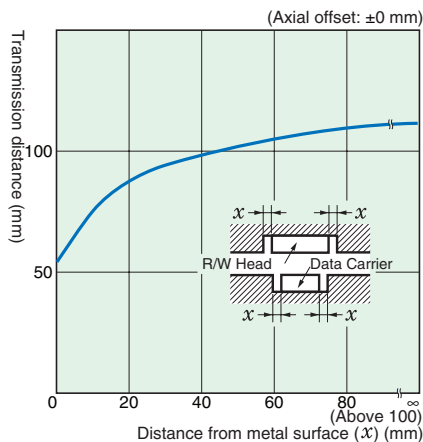

Combined with V600-H11

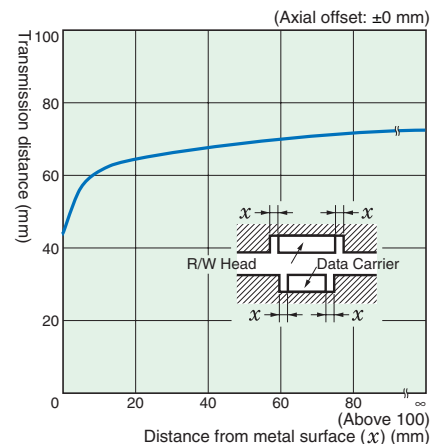

Characteristic Data (Typical)

Transmission Range

Note: The values shown in the following graphs are in millimeters. Refer to pages 24 to 30 for details on Data Carrier and R/W Head mounting conditions.

Battery-less Compact DCs

V600-D23P71 & V600-H07

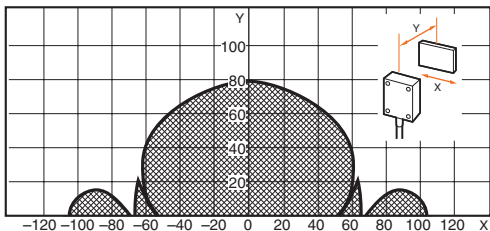

V600-D23P71 & V600-H11

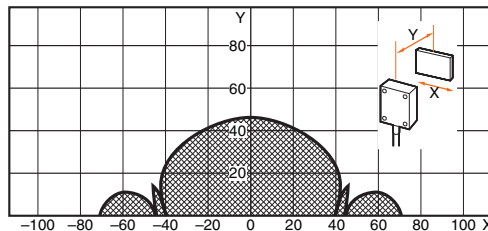

V600-D23P72 & V600-H07

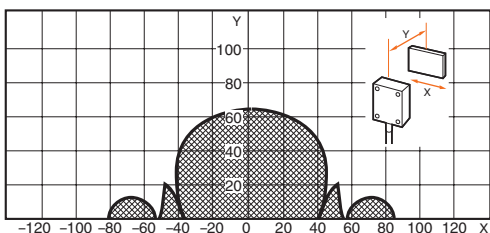

V600-D23P72 & V600-H11

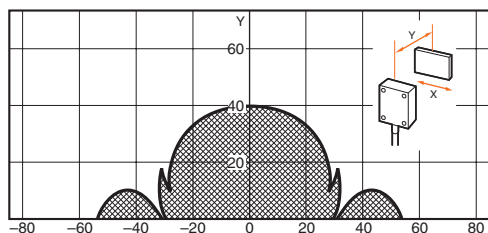

V600-D23P66N & V600-H07

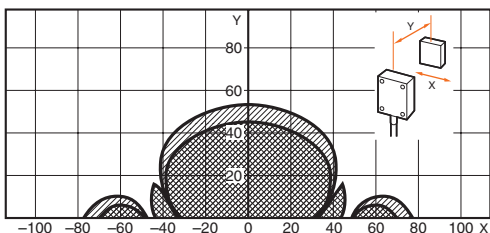

V600-D23P66N & V600-H11

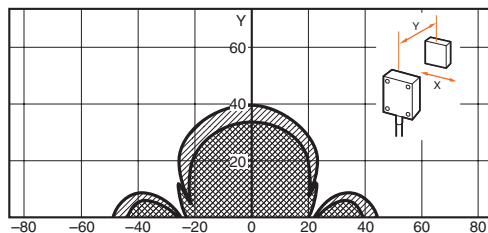

V600-D23P66SP & V600-H07

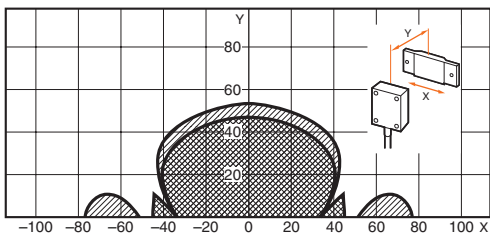

V600-D23P66SP & V600-H11

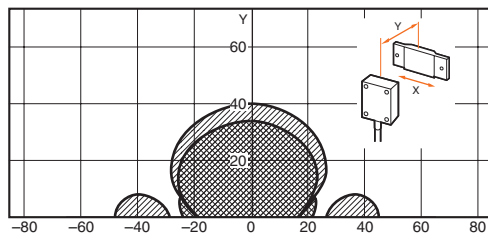

V600-D23P61 & V600-H11

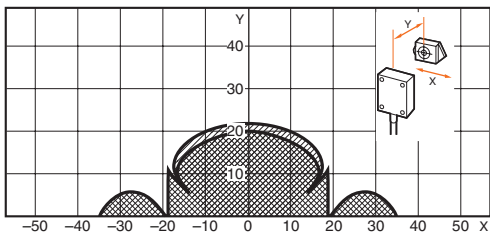

V600-D23P61 & V600-H51

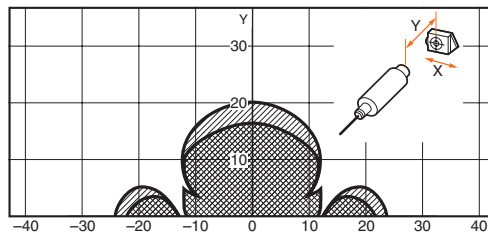

Read range (in transmission distance priority mode)
 Write range (in transmission distance or transmission time priority mode)
 Read range (in transmission time priority mode)

V600-D23P53 & V600-HS51
+V600-HA51

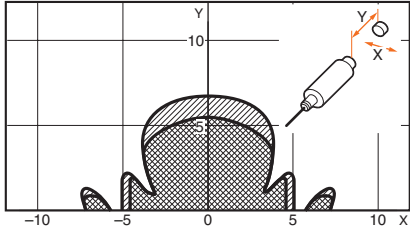

V600-D23P53 & V600-HS61
+V600-HA51

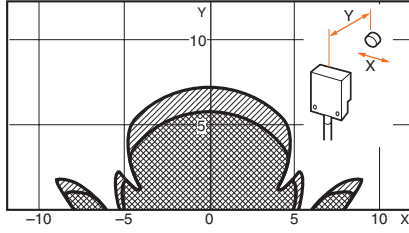

V600-D23P53 & V600-H52

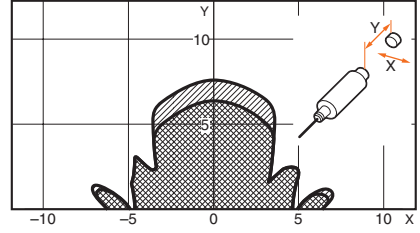

V600-D23P54 & V600-HS51
+V600-HA51

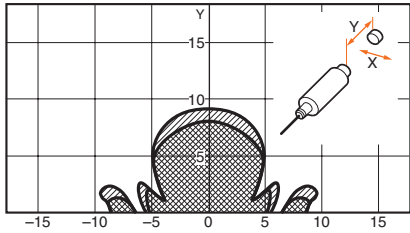

V600-D23P54 & V600-HS61
+V600-HA51

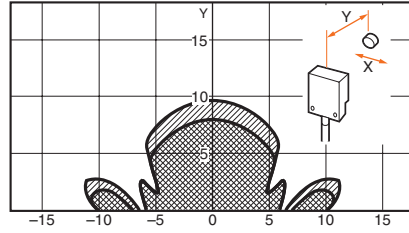

V600-D23P54 & V600-H52

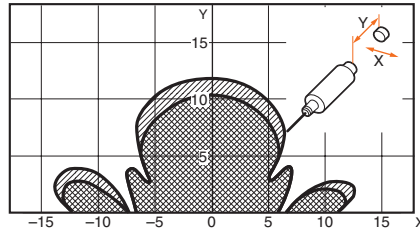

V600-D23P55 & V600-HS51
+V600-HA51

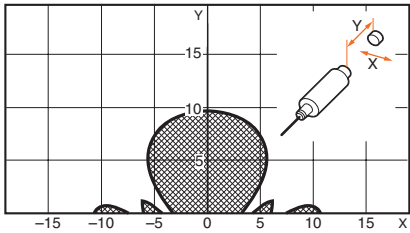

V600-D23P55 & V600-HS61
+V600-HA51

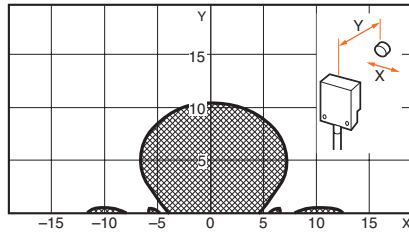

V600-D23P55 & V600-H52

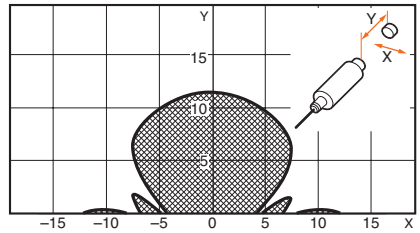

 Read range (in transmission distance priority mode)
  Write range (in transmission distance or transmission time priority mode)
  Read range (in transmission time priority mode)

Built-in-battery DCs

V600-D8KR12 & V600-H07

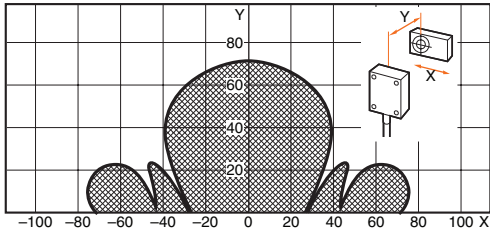

V600-D8KR12 & V600-H11

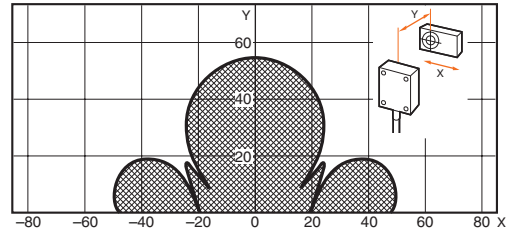

V600-D8KR13 & V600-H07

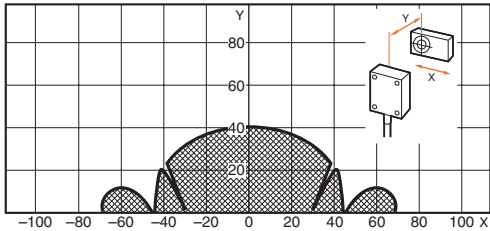

V600-D8KR13 & V600-H11

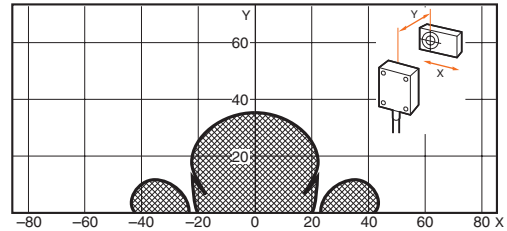

V600-D8KR04 & V600-H07

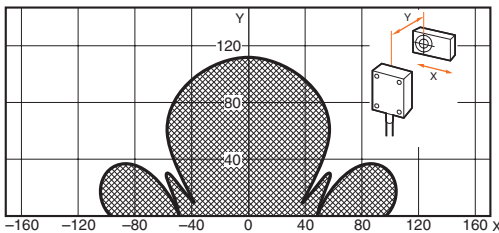

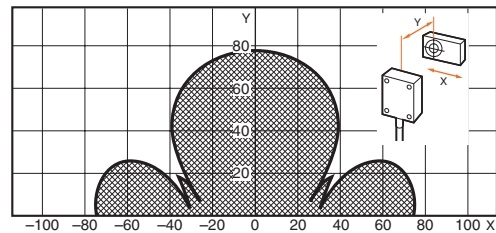

V600-D8KR04 & V600-H11

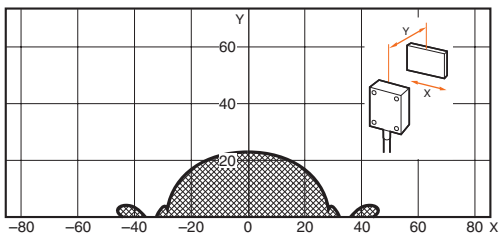

Replaceable-battery DC's

V600-D2KR15 & V600-H11



 Read/Write range (in transmission distance or transmission time priority mode)

■ Transmission Time

- The transmission time does not depend on the model of R/W Head or Data Carrier, although transmission times differ between Data Carriers with and without batteries.
- The turn around time (TAT) is the total time required from the issuance of a command from the host device (for example, a host computer) until the reception of a response.

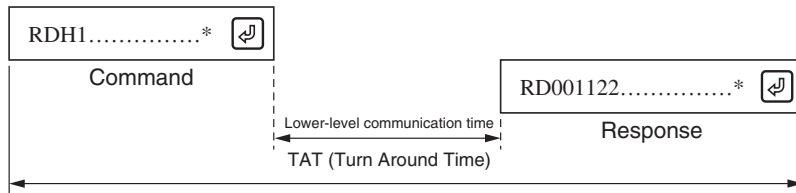

- The lower-level communications time does not include the host communications; it is the time required for communications between the R/W Head and Data Carrier. The lower-level communications time is used in the equation for the DC speed.

$$\text{DC Speed} = \frac{\text{Distance travelled in the transmission range}}{\text{Lower-level communications time}}$$

Transmission Time with Built-in-battery Data Carriers (Reference)

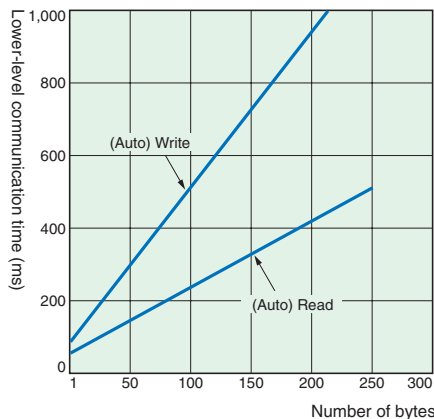

Calculation (Reference)

	Lower-level communications time (ms)
READ	$t = 1.8 N + 48.4$
WRITE	$t = 4.2 N + 86.5$

N is the number of processing bytes.

Transmission Time with Battery-less Data Carriers (Reference)

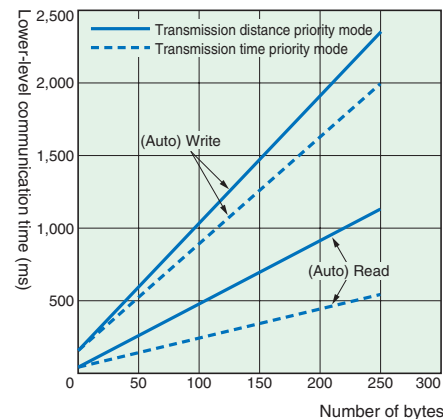

Calculation (Reference)

	R/W	Lower-level communications time (ms)
Distance priority mode	READ	$t = 4.3 N + 64.6$
	WRITE	$t = 8.7 N + 167.1$
Time priority mode	READ	$t = 1.8 N + 79.0$
	WRITE	$t = 7.1 N + 180.4$

N is the number of processing bytes.

■ Lower-level Communications Mode Setting (Distance/Time Priority)

The lower-level communications mode setting is made with a DIP Switch or memory switch on the Serial-interface Controller (V600-CA1A-□/CA2A-□, V600-CD1D-V3, V600-CMID) or ID Sensor Unit. (Refer to the Controller's Operation Manual for more details on this setting.)

With Parallel-interface Controllers (V600-CA8A-V2/CA9A-V2) the mode is fixed to transmission distance priority.

Battery Life

The Data Carrier has a built-in lithium battery.

The following graphs show the relationship between the number of bytes per transmission, the number of transmissions per day, and the battery life.

V600-D8KR12 (Typical Example)

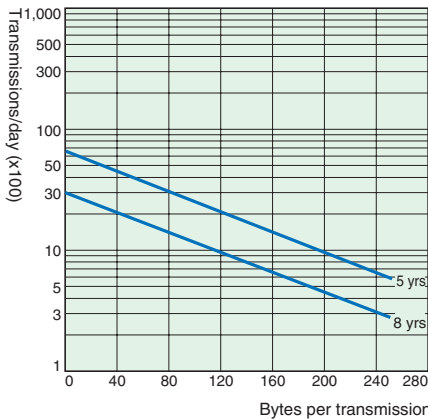

V600-D8KR13 (Typical Example)

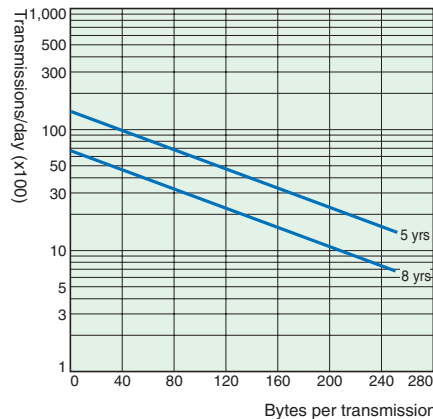

V600-D8KR04 (Typical Example)

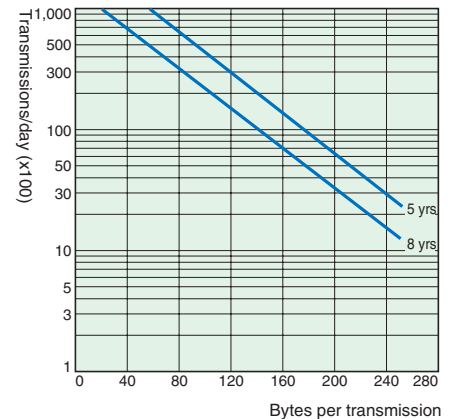

Temperature and Battery Life

V600-D2KR16

The battery life is two years at 25°C regardless of the relationship between the number of bytes read/written and the number of transmissions.

Examples Showing Relationship between Battery Life and Temperature

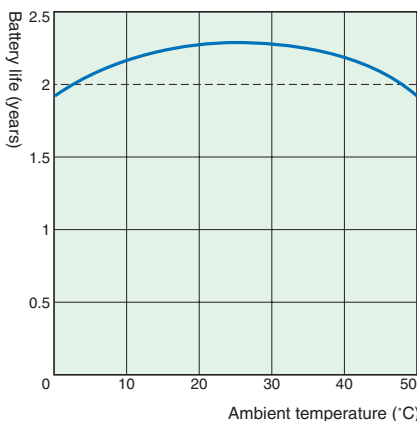

The following table shows the standard values.

Temperature	Battery consumption rate in one year
20°C	1%
30°C	2%
40°C	4%
50°C	8%
60°C	16%
70°C	32%

Note: If the battery is stored at 70°C and is not installed, the battery life is calculated as follows:

$$2 \text{ (years)} \times (1 - 0.32) = 1.36 \text{ years}$$

If the battery is stored at 25°C after one year's storage, the battery life will be approximately 1 year and 4 months. (The battery life will be shortened if the battery is used at temperatures close to 0°C or 50°C.)

The values in the above graph are based on the battery being installed (i.e., the insulation sheet is removed). If the battery is not installed, the values shown in the above table will apply.

Precautions

Correct Use

Data Carrier Batteries

Built-in-battery Data Carriers

Do not disassemble, deform by applying pressure, heat at temperatures exceeding 100°C, or burn. Doing so may cause the built-in lithium batteries to combust or explode.

Replaceable-battery Data Carriers

Never short-circuit the positive and negative terminals of the batteries, charge the batteries, disassemble them, deform them, or throw them into a fire. Doing so may cause the batteries to explode, combust, or leak liquid.

■ Mutual Interference

Mutual Interference between R/W Heads

When more than one set of R/W Heads are used, mutual interference between the Heads can be avoided by mounting the Heads at the specified distance as shown below.

V600-H07

- Facing
RD/WT command: 650 mm min.
Auto command: 900 mm min.

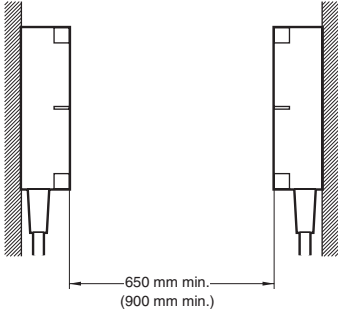

- Side-by-side
RD/WT command: 550 mm min.
Auto command: 1,200 mm min.

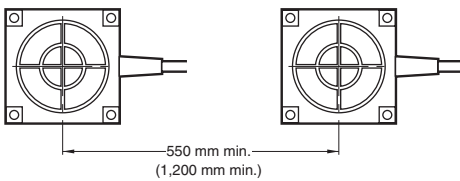

V600-H11

- Facing
RD/WT command: 200 mm min.
Auto command: 200 mm min.

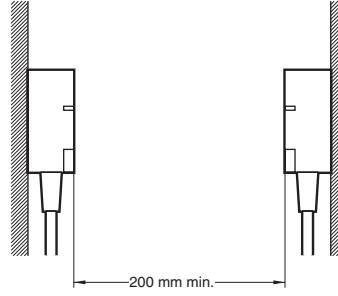

- Side-by-side
RD/WT command: 200 mm min.
Auto command: 200 mm min.

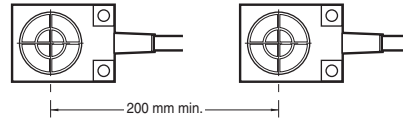

V600-H51

- Facing: 120 mm min.

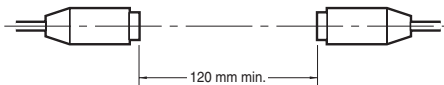

- Side-by-side: 100 mm min.

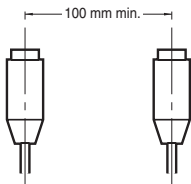

V600-H52

- Facing: 80 mm min.

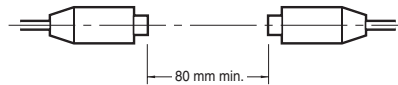

- Side-by-side: 80 mm min.

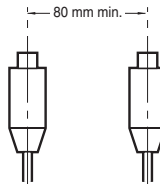

V600-HS51

- Facing: 80 mm min.

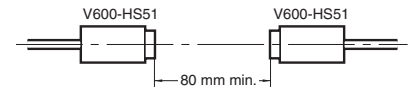

- Side-by-side: 80 mm min.

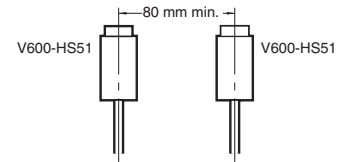

V600-HS61

- Facing: 80 mm min.

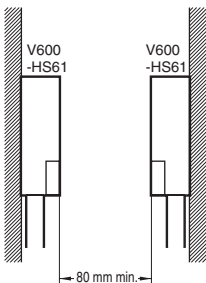

- Side-by-side: 80 mm min.

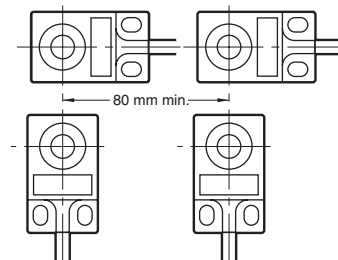

Note: If the two R/W Heads are not transmitting simultaneously (i.e., independent read/write), mutual interference will not occur. Therefore, the restriction on the distance between the Heads will not be applicable. The commands will be received by the R/W Heads and transmission will oscillate between them.

Mutual Interference between Proximity Sensors

The V600-series Units use electromagnetic coupling (frequency: 530 kHz). When a V600 Unit is wired close to R/W Heads, Proximity Switches, and Sensors that have an oscillating frequency between 400 and 600 kHz, the Proximity Sensor may malfunction, so be sure to install the Units according to the distance restrictions specified in the following diagrams. Make sure to thoroughly test that the mounting positions and the fixed positions of the Sensors are correct before putting them into actual operation.

V600-H07

- Vertical: 400 mm min.

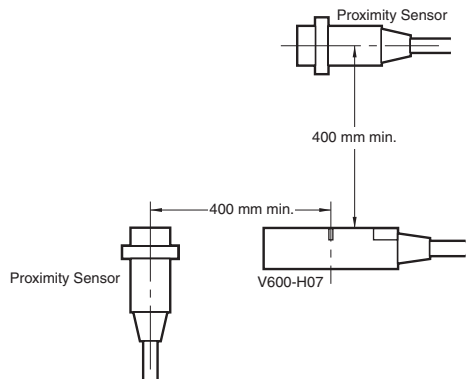

- Facing: 300 mm min.

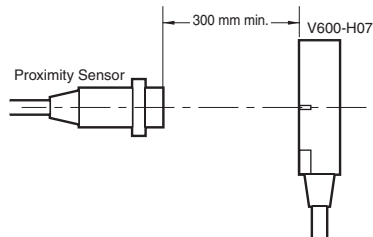

V600-H11

- Vertical: 100 mm min.

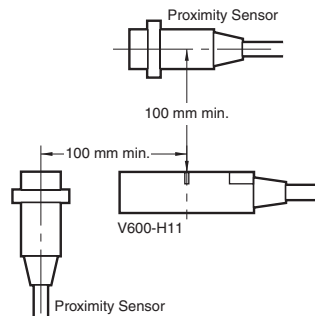

- Facing: 100 mm min.

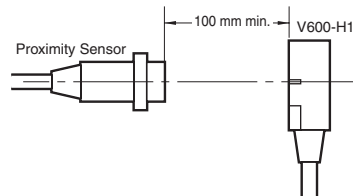

V600-H51/H52

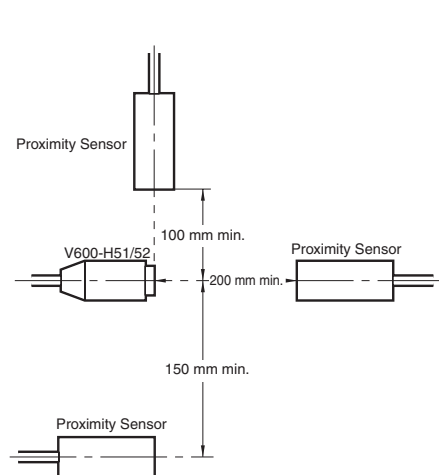

V600-HS51

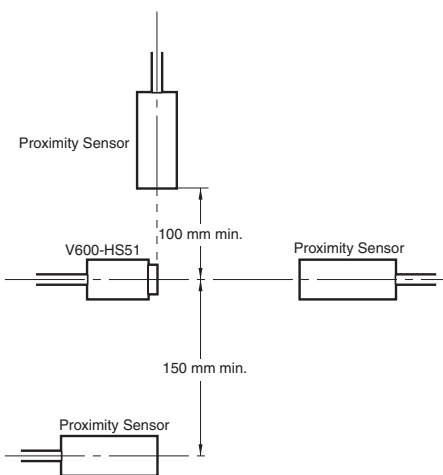

V600-HS61

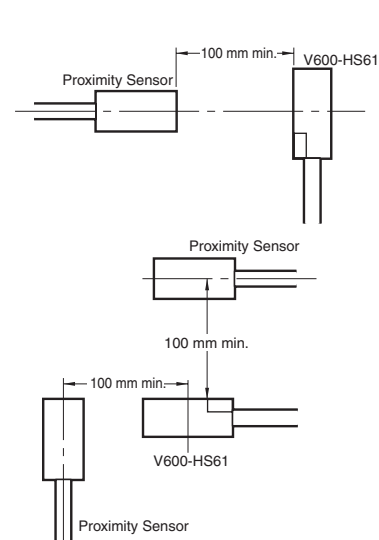

Mutual Interference between Data Carriers

When more than one Data Carrier is used, mutual interference between the DCs can be avoided by making sure that they are mounted apart at the distances specified below.

(Reading/writing)

V600-D23P53

R/W Head: V600-H52, V500-HS51 + V600-HA51, V600-HS61 + V600-HA51

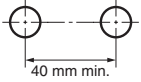

V600-D23P55

R/W Head: V600-H52, V600-HS51 + V600-HA51, V600-HS61 + V600-HA51

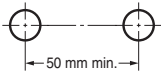

V600-D23P66N

R/W Head: V600-H11

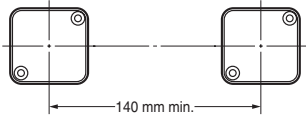

R/W Head: V600-H07

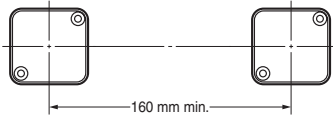

V600-D23P72

R/W Head: V600-H51

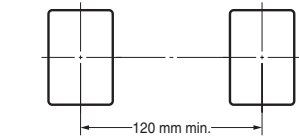
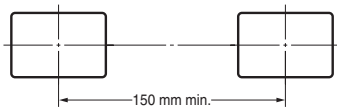

R/W Head: V600-H11

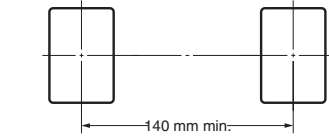
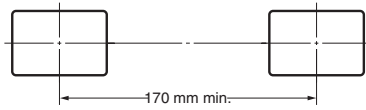

R/W Head: V600-H07

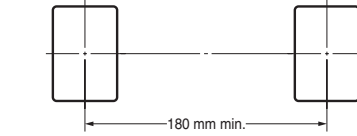
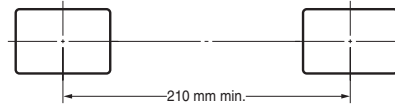

V600-D23P66SP

R/W Head: V600-H07

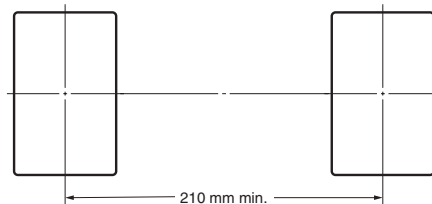
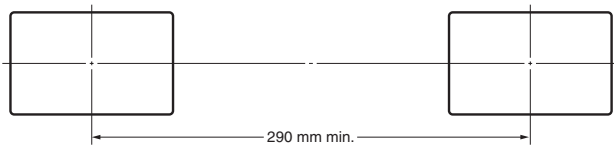

V600-D23P54

R/W Head: V600-H52, V600-HS51 + V600-HA51, V600-HS61 + V600-HA51

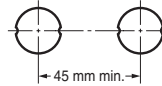

V600-D23P61

R/W Head: V600-H11/-H51

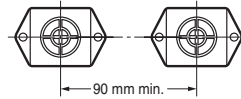

V600-D23P66SP

R/W Head: V600-H11

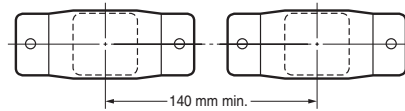

R/W Head: 600-H07

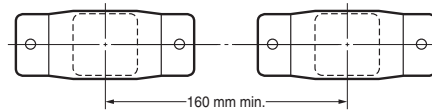

V600-D8KR12

R/W Head: V600-H11

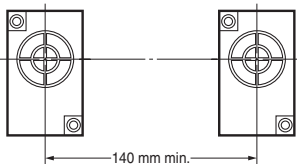
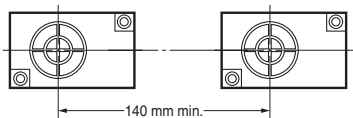

R/W Head: V600-H07

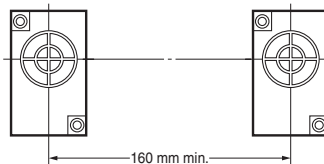
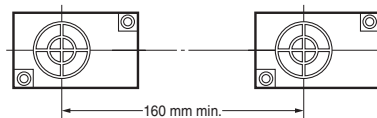

V600-D8KR13

R/W Head: V600-H11

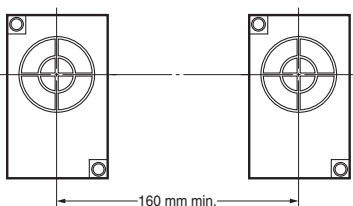
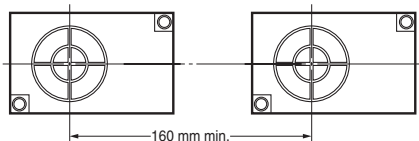

R/W Head: V600-H07

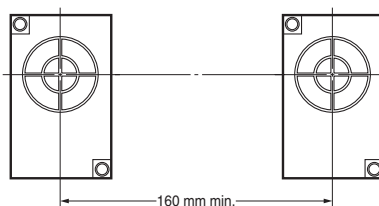
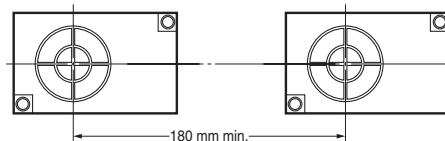

V600-D8KR04

R/W Head: V600-H11

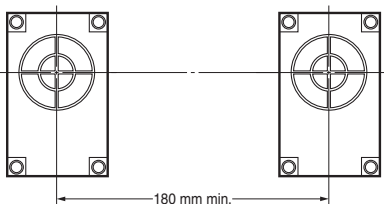
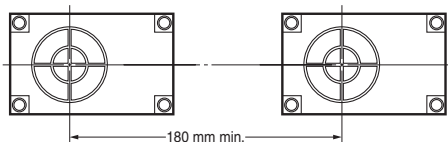

R/W Head: V600-H07

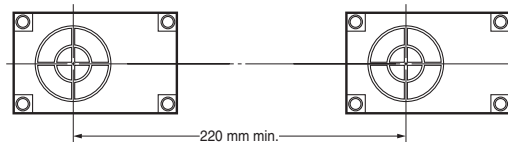

V600-D2KR16

R/W Head: V600-H11

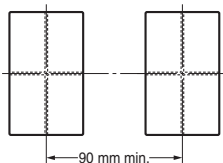
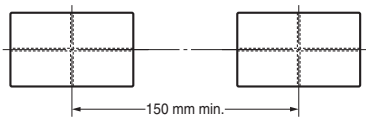

Dimensions

Note: All units are in millimeters unless otherwise indicated.

Data Carriers

Built-in-battery DCs

V600-D8KR12

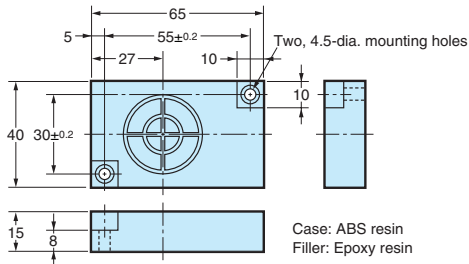

V600-D8KR13

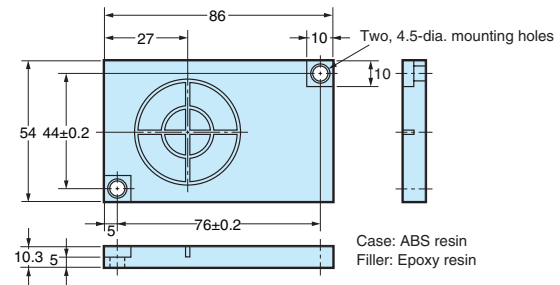

V600-D8KR04

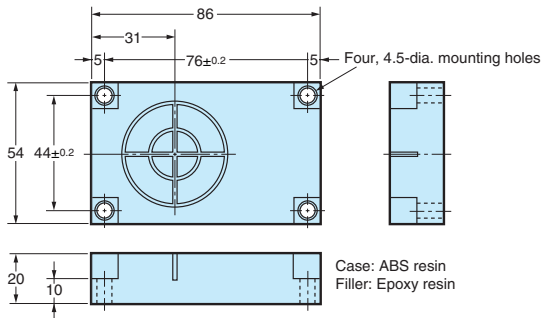

Replaceable-battery DCs

V600-D2KR16

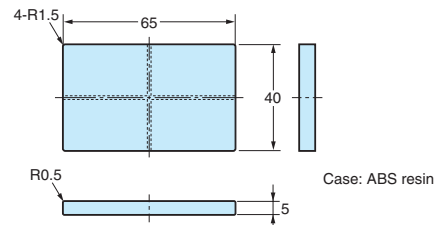

Battery-less DCs

V600-D23P53

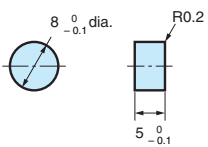

Case: ABS resin
Filler: Epoxy resin

V600-D23P54

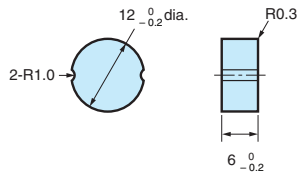

Case: ABS resin
Filler: Epoxy resin

V600-D23P55

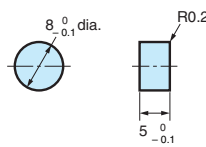

Case: PPS resin
Filler: Epoxy resin

V600-D23P61

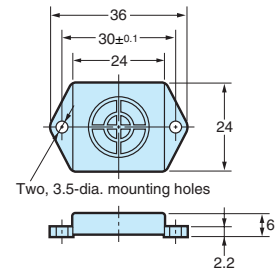

Case: ABS resin
Filler: Epoxy resin

V600-D23P66N

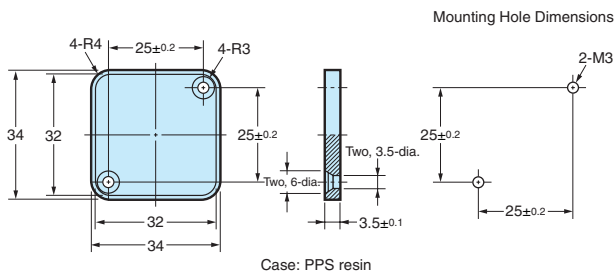

V600-D23P66SP

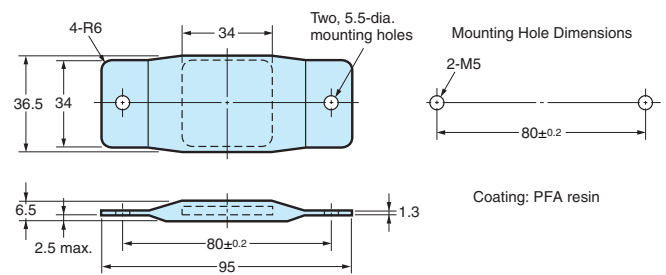

V600-D23P71

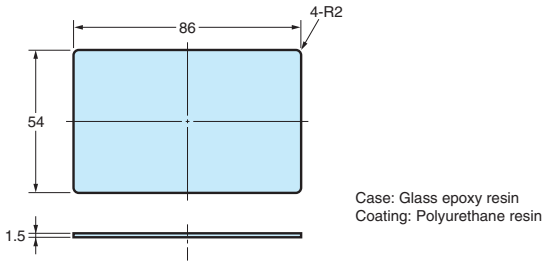

V600-D23P72

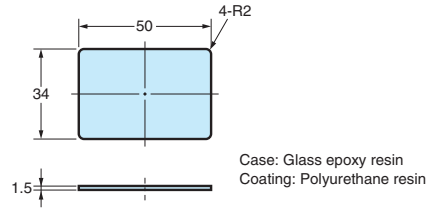

R/W Heads

V600-H07

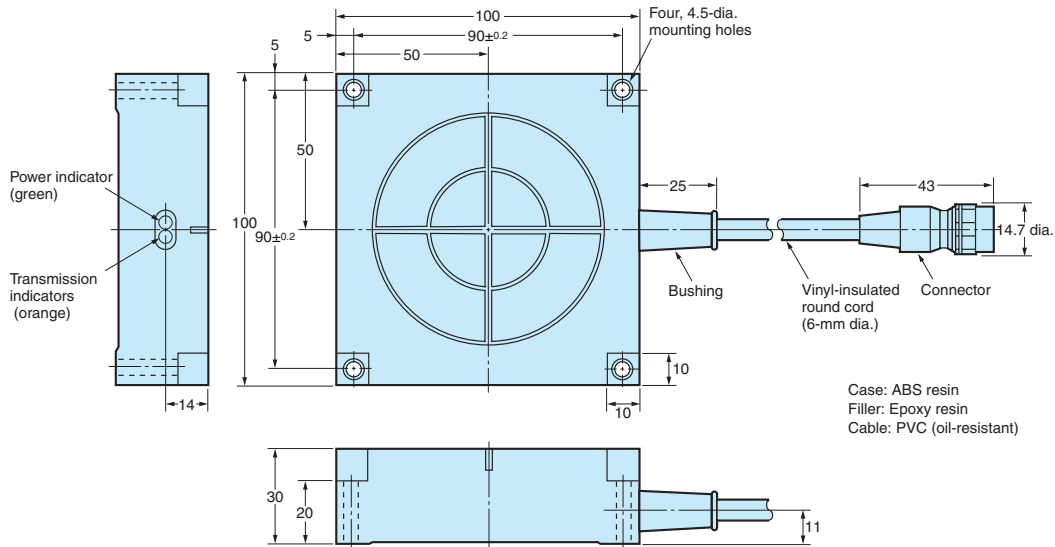

V600-H11

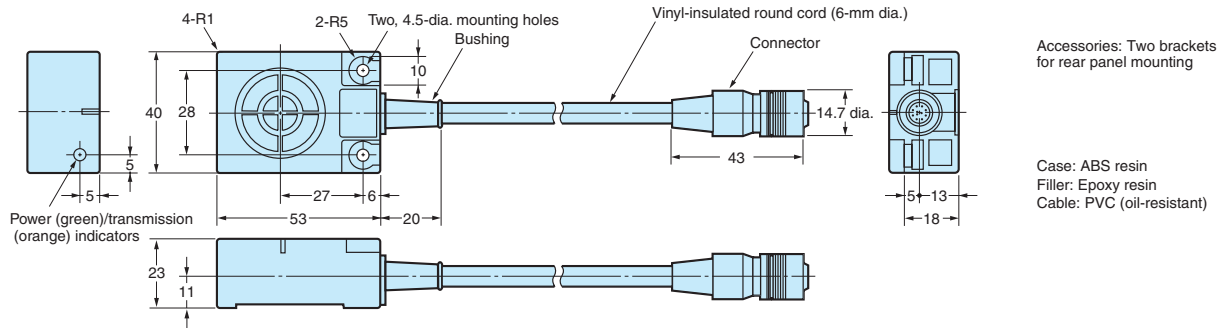

V600-H51

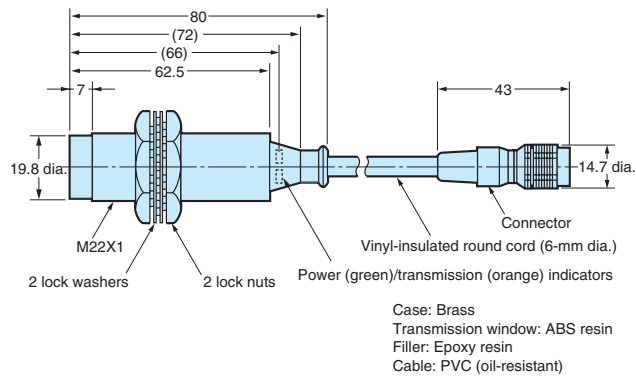

V600-HS51 (Sensor Section)

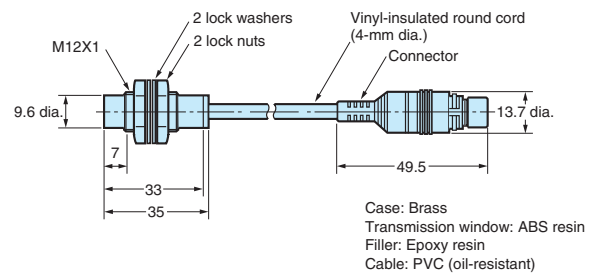

V600-H52

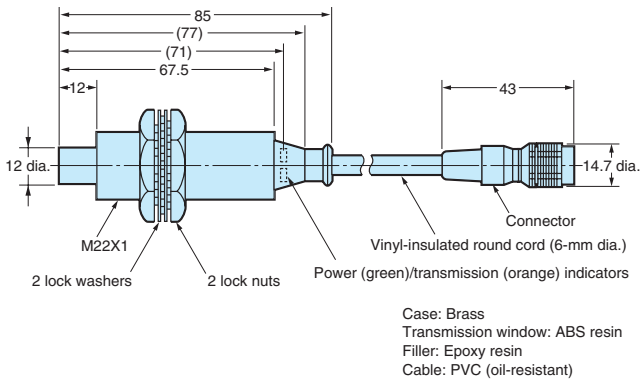

V600-HS61 (Sensor Section)

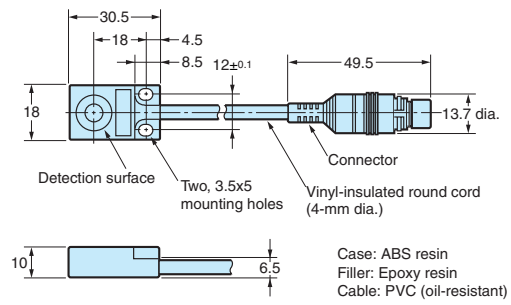

V600-HA51 (Amplifier Section)

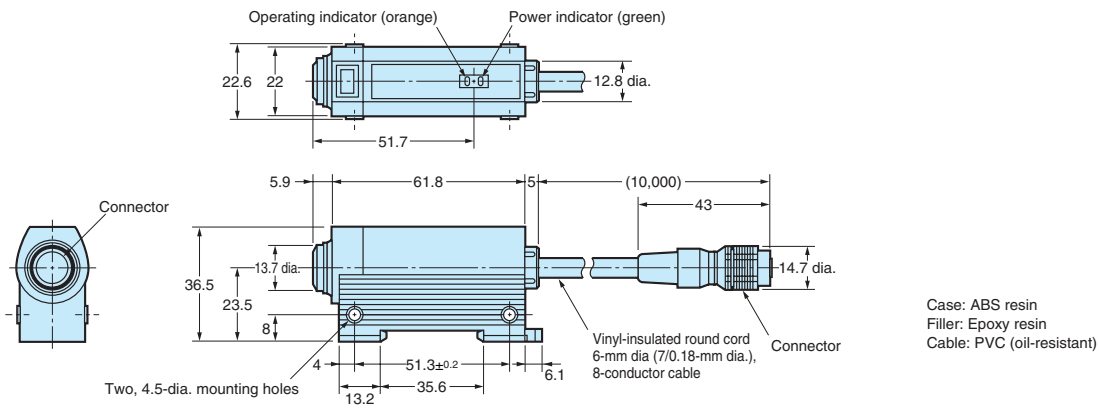

ID Controllers

V600-CA□A-□ (Multipurpose)

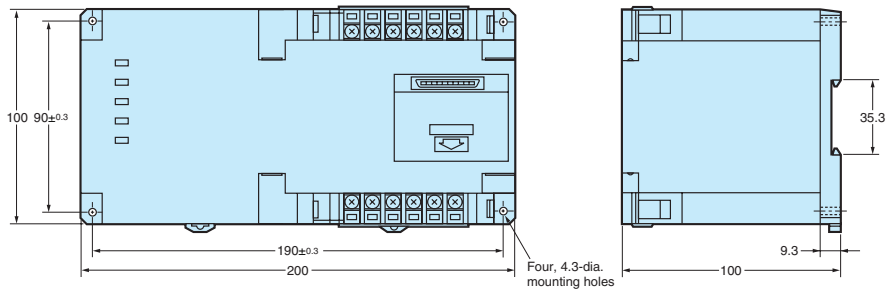

V600-P01 Monitor Unit (For use with V600-CA□A-□)

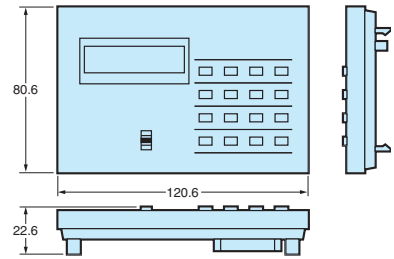

V600-CD1D-V3 (Compact)

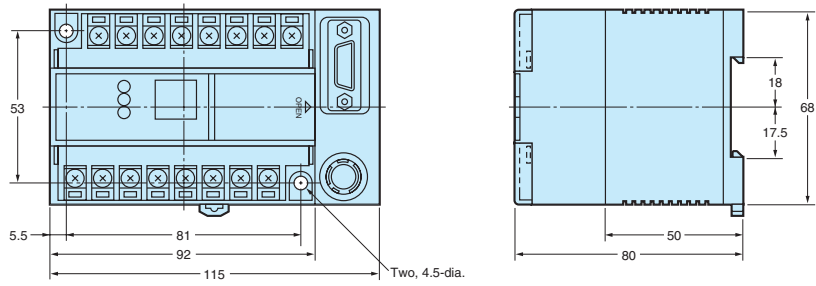

V600-CB-US Hand-held ID Controller

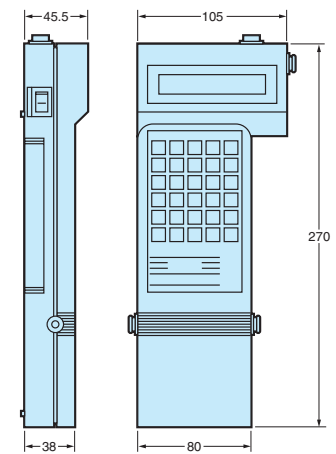

V600-CM1D (Board-mounted)

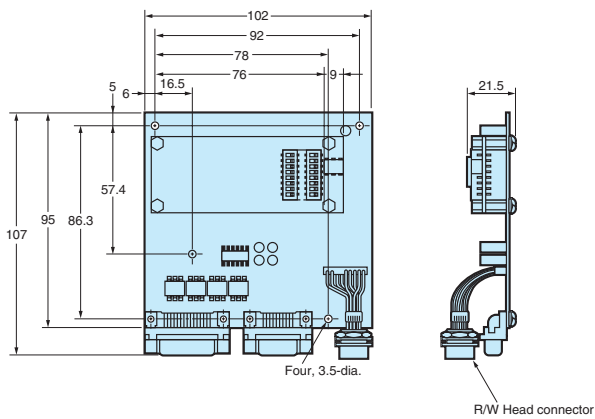

IDSC-C1D□-A (Stand-alone)

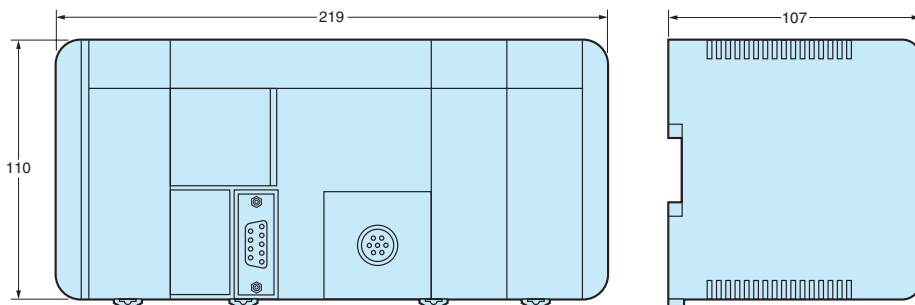

■ Accessories

Holder

V600-A81

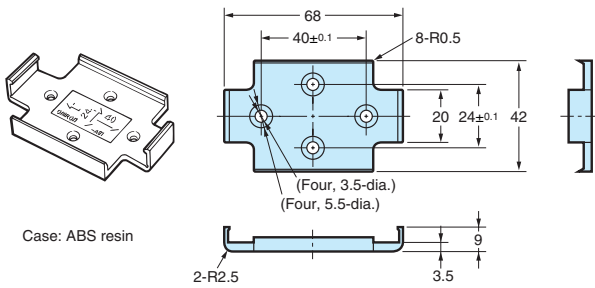

V600-A84

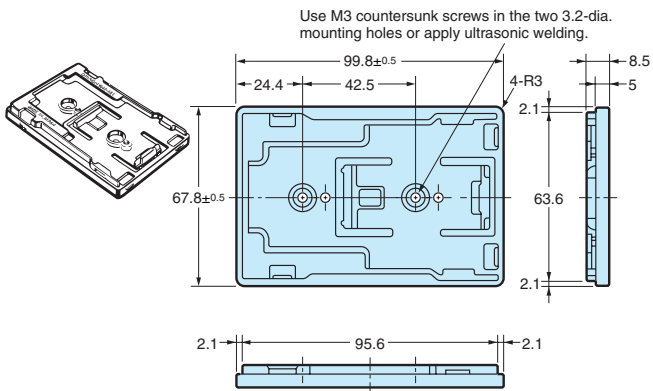

Attachment

V600-A86

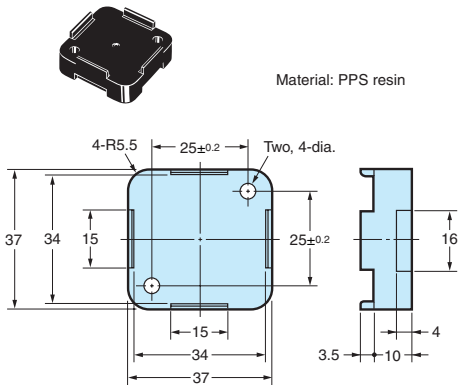

Mounting Hole Dimensions

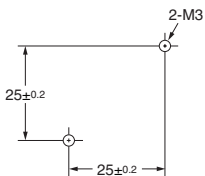

ALL DIMENSIONS SHOWN ARE IN MILLIMETERS.

To convert millimeters into inches, multiply by 0.03937. To convert grams into ounces, multiply by 0.03527.

ID Sensor Units

CJ1W-V600C11/V600C12

CS1W-V600C11/V600C12

Create Flexible Systems Based on Distributed Control and Centralized Management

- These Units can be combined with OMRON's comprehensive lineup of PLC Units to create the optimum system.
- Operations are the same for Single-head and Double-head Units, enabling effective reuse of ladder programs.
- A simple test function allows communications status to be checked without any special programming in the CPU Unit to greatly speed up the system startup.
- Maintenance is greatly simplified by a power supply failure flag and a monitoring function for communications turnaround time and error codes.



Ordering Information

List of Models

Classification	Model	Specifications
ID Sensor Unit	CS1W-V600C11	SYSMAC CS1-series PLCs
	CS1W-V600C12	
	CJ1W-V600C11	SYSMAC CJ1-series PLCs
	CJ1W-V600C12	

Specifications

General Specifications

Item	Model	CJ1W-V600C11	CJ1W-V600C12	CS1W-V600C11	CS1W-V600C12
Applicable PLC		CJ1 Series		CS1 Series	
Unit classification		Special I/O Units			
Compatible RFID System		V600 Series			
Ambient operating temperature		0 to 55°C			
Storage temperature		-20 to 75°C			
Ambient operating humidity		10% to 90% (with no condensation)			
Vibration/shock resistance		Conforms to CJ1 Series.		Conforms to CS1 Series.	
External power supply		Not required.			24 VDC+/-10%
Current consumption	5 V	0.26 A	0.32 A	0.26 A	0.32 A
	24 V	0.12 A	0.24 A	---	---
	26 V	---	---	0.12 A	0 A (Not used.)
	External	---	---	---	0.36 A
Weight		Approx. 120 g	Approx. 130 g	Approx. 180 g	Approx. 300 g
Applicable standards		UL, CE (EMS: EN61000-6-2, EMI: EN50081-2)			

■ Performance Specifications

Model	CJ1W-V600C11	CJ1W-V600C12	CS1W-V600C11	CS1W-V600C12
Item				
Unit number	0 to 95	0 to 94	0 to 95	0 to 94
Word allocation	10 words	20 words	10 words	20 words
Mounting position	CJ1 CPU Rack or Expansion Rack		CS1 CPU Rack or Expansion Rack/Long-distance Expansion Rack (The Units cannot be mounted to C200H I/O Expansion Racks or Remote I/O Slave Racks.)	
Number of mountable Units	<p>The actual number of Units that can be mounted depends on the number of Units and their respective consumption currents. (Refer to data on current consumptions in the operation manual for the relevant CPU Unit.) The maximum number of ID Sensor Units (without any other Units) that can be mounted per Rack is as follows:</p> <p>CJ1W-V600C11: 4 per Rack CJ1W-V600C12: 2 per Rack CS1W-V600C11: 5 per Rack CS1W-V600C12: 10 per Rack (no restrictions)</p> <p>Note: The power supply for the CJ1W-V600C11/V600C12 is the CJ1W-PA205R.</p>			
Communications control method	Controlled using the Special I/O Unit Area.			
Data transfer speed	Up to 2,048 bytes of data can be transferred at 160 bytes/scan (between the CPU Unit and the ID Sensor Unit)			
Compatible RFID System	V600 Series			
Possible number of R/W Heads	1 R/W Head	2 R/W Heads	1 R/W Head	2 R/W Heads
Commands (Figures in parentheses indicate the number of bytes that can be specified.)	Read/Write (1 to 2048) Data Fill (1 to 2048 or the last address)Åj Copy (Double-head models only) (1 to 2048) Calculation Write (1 to 4) Bit Set/Bit Clear (1 to 4) Mask Bit Write (2) Data Check (2) Number of Writes Control (3)			
Communications processing time (See note.)	Command	Data Carrier with built-in battery	Battery-less Data Carrier (time priority mode)	
	Read	$1.8 \times N + 48.4$	$1.8 \times N + 79.0$	
	Write (with verify setting)	$4.2 \times N + 86.5$	$7.1 \times N + 180.4$	
	Write (without verify setting)	$2.2 \times N + 72.8$	$4.3 \times N + 132$	
Maintenance functions	Communications test function, processing result monitor function (communications TAT, error codes)			
Error detection functions	Detects CPU errors and errors in communications with the Data Carrier, and checks the power supply for the Head.			

Note: The command processing time can be calculated by adding the data transfer time to the communications processing time.

System Configuration

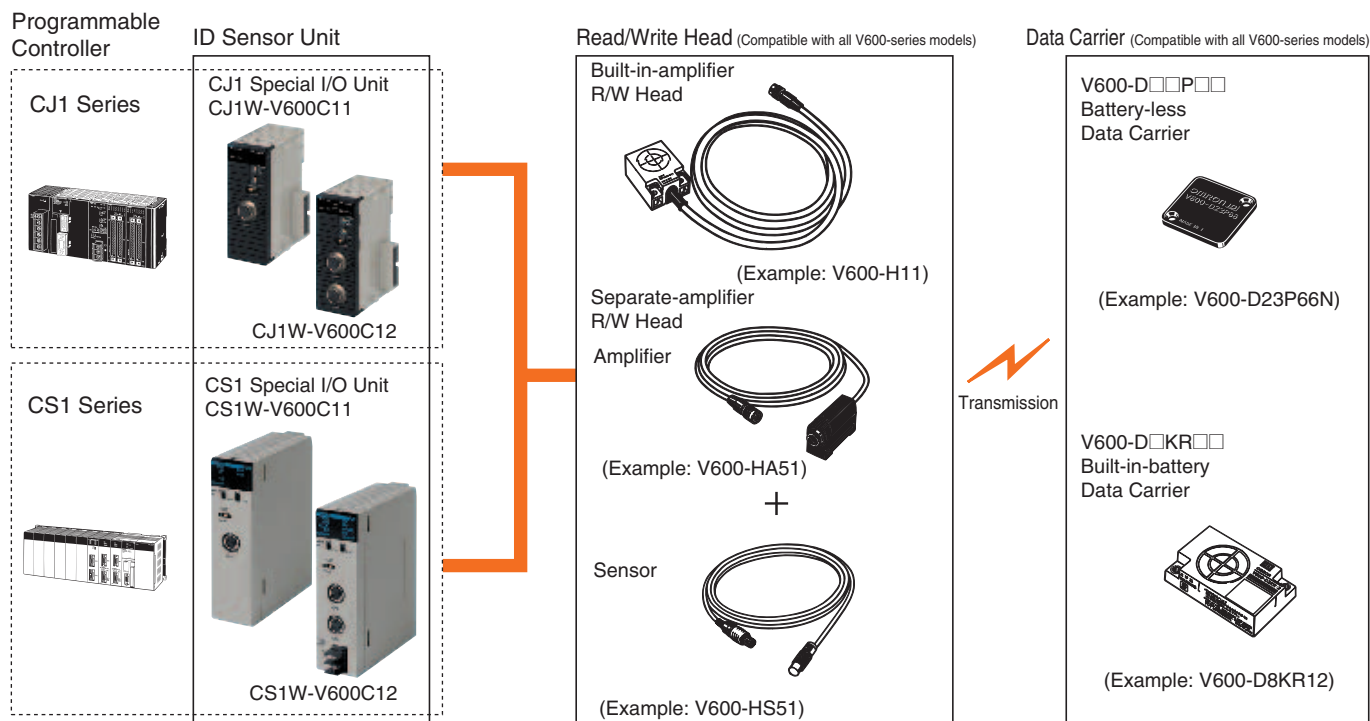

Note: For information related to Programmable Controller specifications, refer to the operation manual for relevant Programmable Controller. The following Units, which can be used with PLCs other than CJ1- and CS1-series PLCs, are also available.

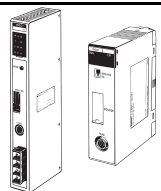
ID Sensor Unit	C500-IDS01-V2		SYSMAC CV500, CV1000, CVM1, C500(F), C1000H(F), and C2000H PLCs	General-purpose
	C500-IDS02-V1			Long-distance transmission
	C200H-IDS01-V1		SYSMAC C200H and C200HX PLCs	General-purpose
ID Adapter	C500-IDA02		Required when using the C500-IDS02-V1 Sensor Unit.	Long-distance transmission

Note: Refer to the relevant PLC catalog for more details.

Dimensions

Note: All units are in millimeters unless otherwise indicated.

ID Sensor Units

CJ1W-V600C11

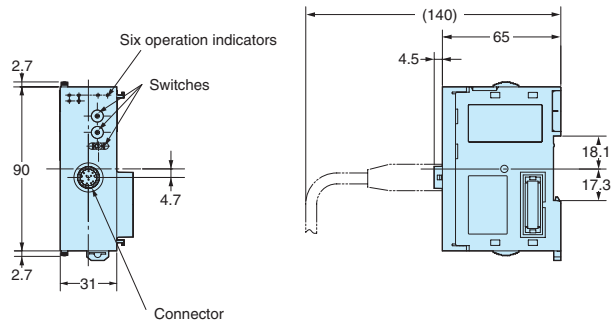

CS1W-V600C11

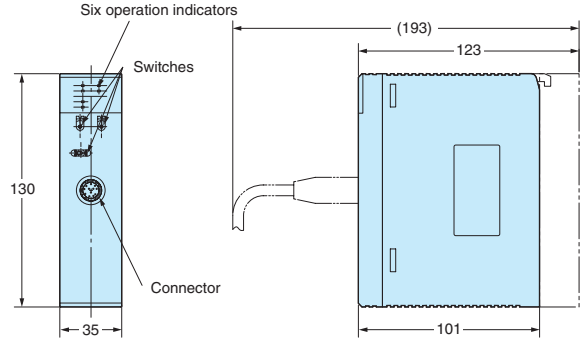

CJ1W-V600C12

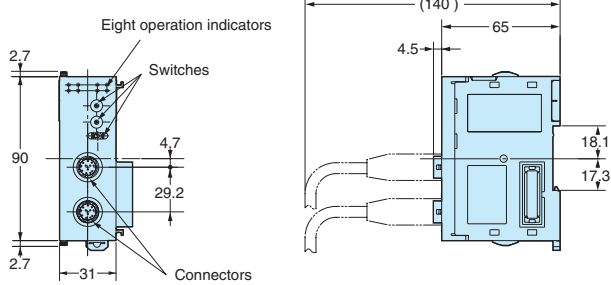

CS1W-V600C12

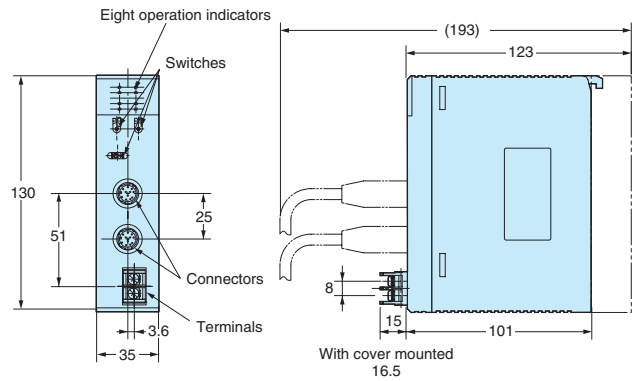

ALL DIMENSIONS SHOWN ARE IN MILLIMETERS.
To convert millimeters into inches, multiply by 0.03937. To convert grams into ounces, multiply by 0.03527.

Intelligent Flag I/II V600-HA

Innovative RFID Electronic Flags to Replace Mechanical Flag and Kanban Systems

- Doesn't need a program and can be used like a sensor.
- Advanced line construction at minimal cost.
- Saves space.
- Precise installation not required (Transmission distance: 100 mm max.).
- A verification function provided on multi-functional type.
- Addition of 16-bit models to the series responds to applications from Kanban to quality control.
- Equipped with a wiring reduction mode and communications parity check function (16-bit models).
- Both NPN and PNP output available.
- FCC certified.



Ordering Information/Specifications

■ Amplifier

Item	Type Model	Read-only		Multi-functional		Read-only
		V600-HAR91	V600-HAR81	V600-HAM91	V600-HAM81	V600-HAR92
Power supply		24 VDC ±10%, ripple (p-p): 10%				
Current consumption		130 mA max.				
Input		Transistor output or contact output Short-circuit current: 3 mA (typical) (IN terminal and 0-V short-circuit) OFF voltage: 15 to 30 VDC ON voltage: 0 to 5 VDC Input impedance: 8.2 kΩ Applied voltage: 30 VDC max.				Transistor output OFF voltage: 15 to 30 VDC Input impedance: 8.2 kΩ Short-circuit current: 3 mA (typical) (for 0-V short-circuit of INHIBIT/TRG) ON voltage: 0 to 5 VDC Applied voltage: 30 VDC max.
Output		NPN open collector output, 20 mA max. at 30 VDC, residual voltage: 2 V max.	PNP open collector output, 20 mA max. at 30 VDC, residual voltage: 2 V max.	NPN open collector output, 20 mA max. at 30 VDC, residual voltage: 2 V max.	PNP open collector output, 20 mA max. at 30 VDC, residual voltage: 2 V max.	NPN open collector output, 20 mA max. at 30 VDC, residual voltage: 2 V max.
Diagnostic functions		Checks for CPU errors and transmission errors				
Insulation resistance		50 MΩ max. (at 500 VDC) between cable terminals and case				
Dielectric strength		500 VAC, 50/60 Hz for 1 min between cable terminals and case (leakage current: 1 mA max.)				

Item	Type Model	Read-only		Multi-functional		Read-only
		V600-HAR91	V600-HAR81	V600-HAM91	V600-HAM81	V600-HAR92
Vibration resistance		Destruction: 10 to 150 Hz, 0.3-mm double amplitude, with 4 sweeps of 8 min each in 3 directions				Destruction: 10 to 150 Hz, 1.5-mm double amplitude, with 4 sweeps of 8 min each in 3 directions
Shock resistance		Destruction: 294 m/s ² , 3 times each in 6 directions				
Ambient temperature		-10 to 55°C (with no icing)				
Ambient humidity		35% to 85% (with no condensation)				
Storage temperature		-25 to 65°C				
Degree of protection		IEC60529: IP40				
Ground		Ground to 100 Ω or less.				
Material		ABS resin (case)				
Cable length		Standard, 0.5 m with a dedicated connector (See note.)				
Weight		Approx. 170 g				Approx. 180 g

Note: The connector is not waterproof. If there is a possibility that the connector may be exposed to water, keep it inside the control box. Be sure to use the connector together with the separately sold interface cable.

■ Functions

V600-HAR91/-HAR81 (Read-only type)

Reads the 8-bit data (1 byte) of the set address and outputs to the 8 data output lines.

V600-HAM91/-HAM81 (Multi-functional type)

The amplifier has the following three basic functions.

Read

Reads the 8-bit (1 byte) data of the set address and outputs to the 8 data output lines.

Write

Writes on the set address the 8-bit (1 byte) data designated via the 8 data input lines.

Verify

Reads the 8-bit data (1 byte) of the set address, compares with the 8-bit (1 byte) data input via the 8 verification data input lines, and outputs the verification result.

V600-HAR92 (Read-only type)





Reads the 16-bit data (2 bytes) of the set address and outputs to the 16 data output lines.

■ Interface Cable

Amplifier	Cable length	Interface Cable
V600-HAR91/81 (Connector: 20 pin)	2 m	V600-A60R
	5 m	V600-A61R
	10 m	V600-A62R
V600-HAM91/81 V600-HAR92 (Connector: 26 pin)	2 m	V600-A60M
	5 m	V600-A61M
	10 m	V600-A62M

Note: The interface cable connector is not waterproof. If there is a possibility that the connector may be exposed to water, keep it inside the control box. The maximum cable length is 10 m.

■ Sensor

Model Shape	V600-HS51	V600-HS61	V600-HS63	V600-HS67
Item				
Transmission frequency	530 kHz			
Ambient temperature	-10 to 60°C		-10 to 70°C	
Storage temperature	-25 to 75°C			
Ambient humidity	35% to 95%			
Insulation resistance	50 MΩ (at 500 VDC) between cable terminal and case			
Dielectric strength	1,000 VAC, 50/60 Hz for 1 min between cable terminal and case (leakage current: 1 mA max.)			
Degree of protection	IEC60529: IP67			
Vibration resistance	Destruction: 10 to 2,000 Hz, 3-mm double amplitude, with 2 sweeps of 15 min each in 3 directions		Destruction: 10 to 500 Hz, 2-mm double amplitude, with 3 sweeps of 11 min each in 3 directions	
Shock resistance	Destruction: 981 m/s ² , 3 times each in 3 directions (18 times total)		Destruction: 490 m/s ² , 3 times each in 3 directions (18 times total)	
Cable length	2 m (fixed)			
Wireless transmission error direction	16-bit CRC (Cyclic Redundancy Check) in both directions			
Indicator	---		Power: green	
Weight	Approx. 70 g		Approx. 190 g	Approx. 540 g

■ Transmission Distance Specifications

Recommended Combinations

Data Carrier	Amplifier Sensor	V600-HAR91/-HAR81/-HAM91/-HAM81/-HAR92			
		V600-HS51	V600-HS61	V600-HS63	V600-HS67
Memory EEPROM (Battery-less type)	V600-D23P53	0.5 to 3.0 mm	0.5 to 3.0 mm	---	---
	V600-D23P54	0.5 to 5.0 mm	0.5 to 5.5 mm	---	---
	V600-D23P55	0.5 to 7.0 mm	0.5 to 7.0 mm	0.5 to 9.5 mm	---
	V600-D23P61	0.5 to 8.0 mm	0.5 to 9.0 mm	2 to 16 mm	---
	V600-D23P66N	---	---	5 to 30 mm	5 to 35 mm
	V600-D23P66SP	---	---	5 to 25 mm	5 to 30 mm
	V600-D23P71	---	---	5 to 35 mm	10 to 70 mm
	V600-D23P72	---	0.5 to 18 mm	5 to 35 mm	10 to 50 mm
Memory SRAM (Built-in-battery type)	V600-D8KR12	5 to 15 mm	5 to 18 mm	5 to 45 mm	10 to 60 mm
	V600-D8KR13	---	---	10 to 30 mm	10 to 40 mm
	V600-D8KR04	---	---	10 to 65 mm	10 to 100 mm
	V600-D2KR16	---	---	2 to 15 mm	---

Note: 1. The specifications take fluctuations in ambient temperature and slight differences between products into account.

2. The read distance and write distance are the same.

3. Sensor Installation Conditions

- V600-HS51: When flush-mounted in iron
Axial offset from the Data Carrier: ±2.0 mm
- V600-HS61: When surface-mounted on metal (ferrous)
Axial offset from the Data Carrier: ±2.0 mm
- V600-HS63: When surface-mounted on metal (ferrous)
Axial offset from the Data Carrier: ±10.0 mm
- V600-HS67: When surface-mounted on metal (ferrous)
Axial offset from the Data Carrier: ±10.0 mm

4. Data Carrier Installation Conditions

- V600-D23P53/-P54: When flush-mounted in iron
- V600-D23P55/-P66N/-P66SP/-P71/-P72: When surface-mounted on resin (no metal on the backside)
- V600-D23P61: When surface-mounted on metal (ferrous)
- V600-D8KR12/-13/-04: When surface-mounted on metal (ferrous)
- V600-D2KR16: When the Data Carrier attached to the holder is mounted on a metal (ferrous) surface

5. The transmission distance specified in the specifications is also applicable when the Data Carrier is mounted on non-metallic surfaces.

6. The Data Carrier is stationary.

System Configuration

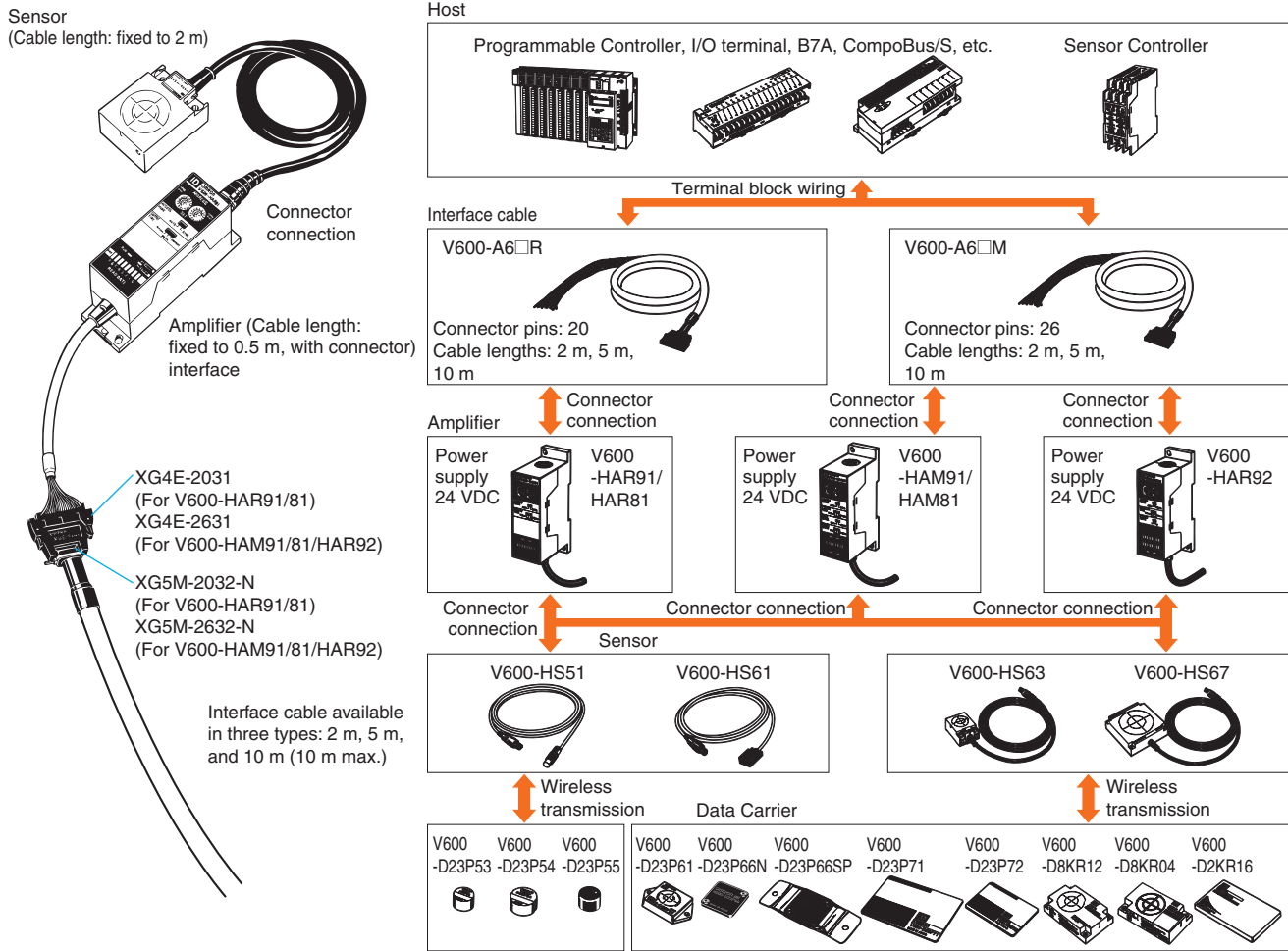

Characteristic Data (Typical)

■ Transmission Range

Combinations with the V600-HS51 Sensor

V600-HS51 & V600-D23P53

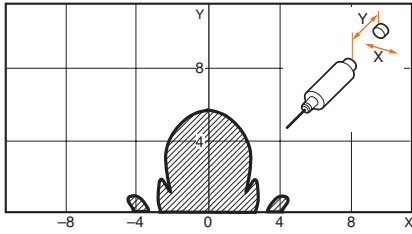

V600-HS51 & V600-D23P54

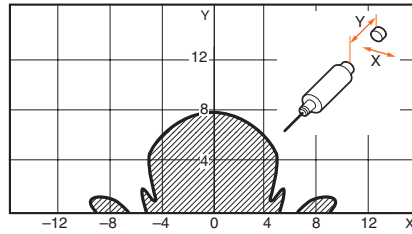

V600-HS51 & V600-D23P55

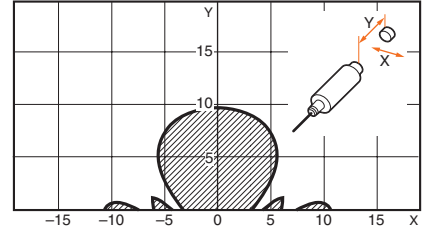

V600-HS51 & V600-D23P61

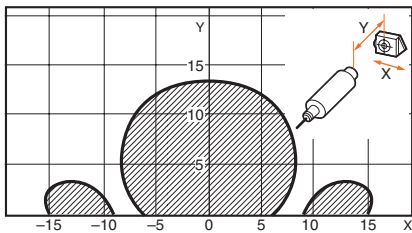

V600-HS51 & V600-D23P66N

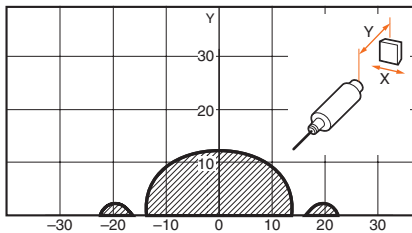

V600-HS51 & V600-D8KR12

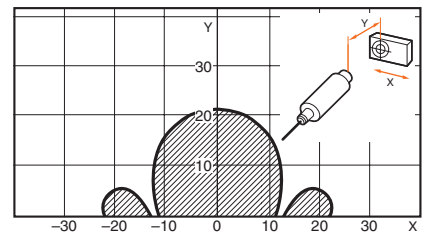

Combinations with the V600-HS61 Sensor

V600-HS61 & V600-D23P53

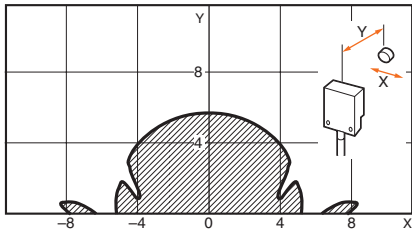

V600-HS61 & V600-D23P54

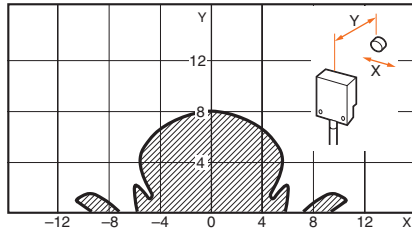

V600-HS61 & V600-D23P55

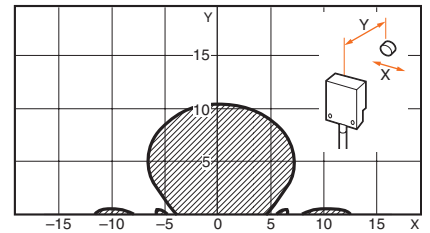

V600-HS61 & V600-D23P61

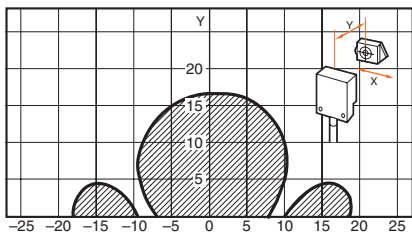

V600-HS61 & V600-D23P72

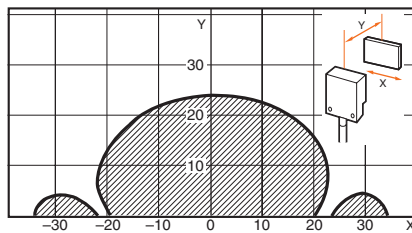

V600-HS61 & V600-D8KR12

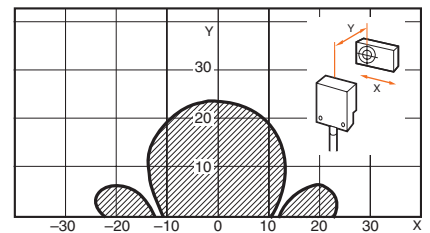

Combinations with the V600-HS63 Sensor

V600-HS63 & V600-D23P55

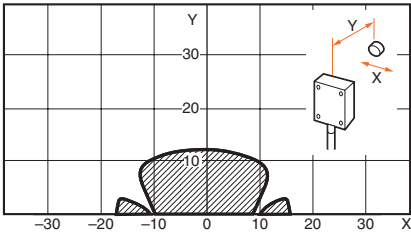

V600-HS63 & V600-D23P61

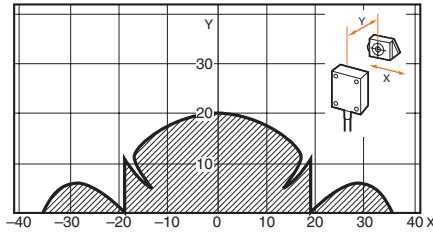

V600-HS63 & V600-D23P66N

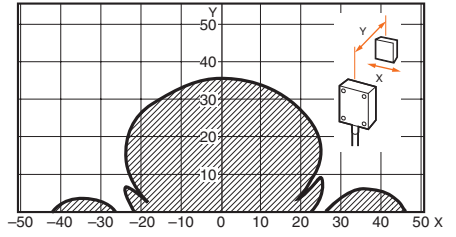

V600-HS63 & V600-D23P66SP

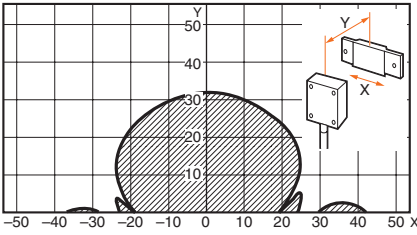

V600-HS63 & V600-D23P71

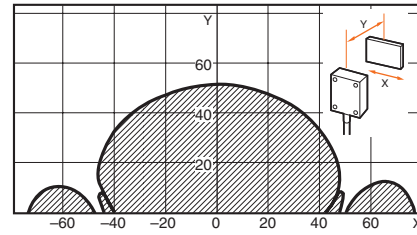

V600-HS63 & V600-D23P72

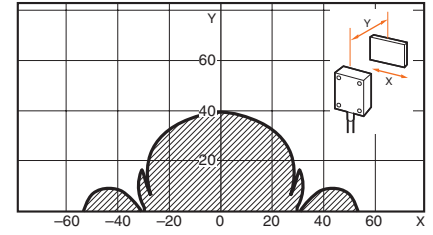

V600-HS63 & V600-D8KR12

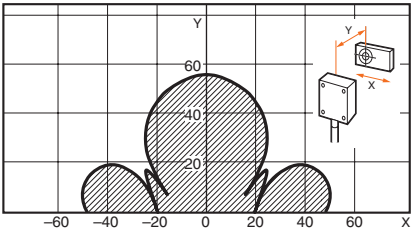

V600-HS63 & V600-D8KR04

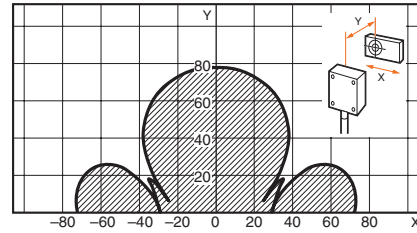

V600-HS63 & V600-D2KR16

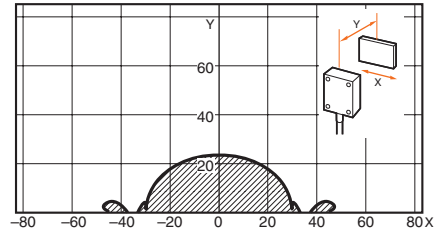

Combinations with the V600-HS67 Sensor

V600-HS67 & V600-D23P66N

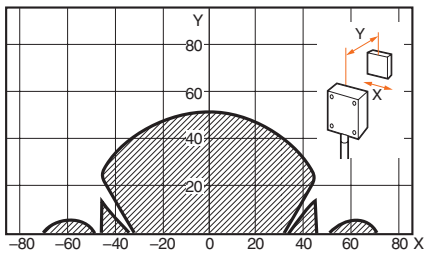

V600-HS67 & V600-D23P66SP

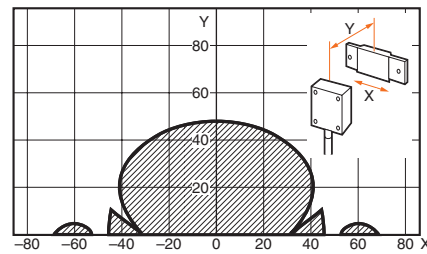

V600-HS67 & V600-D23P71

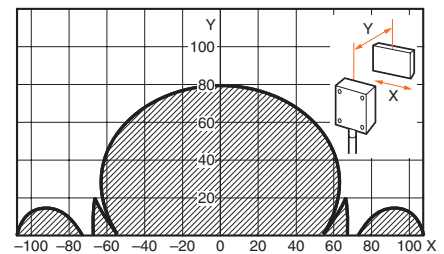

V600-HS67 & V600-D23P72

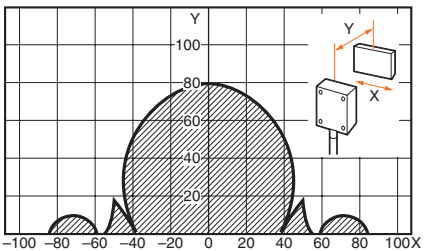

V600-HS67 & V600-D8KR12

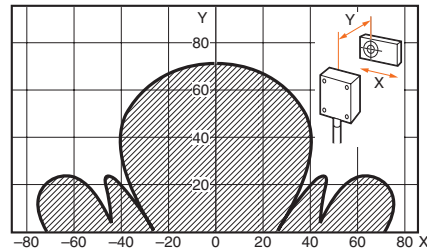

V600-HS67 & V600-D8KR13

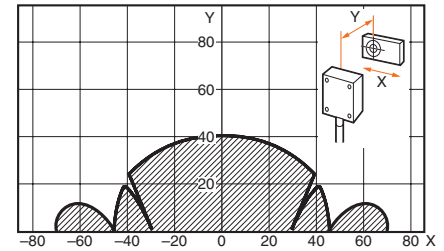

V600-HS67 & V600-D8KR04

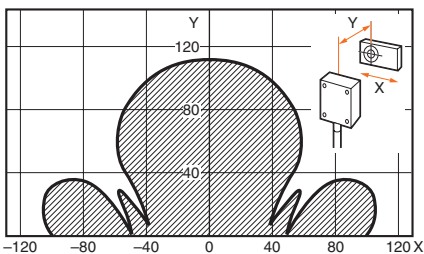

Transmission Time

The transmission time refers to the time required for communications between the Sensor and the Data Carrier. It is used for calculating the travel speed of the auto command.

$$\text{DC speed (conveyor speed)} = \frac{\text{Distance travelled in the transmission range}}{\text{Transmission time}}$$

Model		V600-HAR91/-HAR81/-HAM91/-HAM81			V600-HAR92
		Read	Write		Read
Mode type		DATA READ mode, VERIFY READ mode	BYTE mode	BIT SET mode, BIT CLEAR mode	DATA READ mode
Data Carrier type	EEPROM	75 ms	138 ms	150 ms	77 ms
	SRAM	60 ms	95 ms	107 ms	62 ms

Example: Combinations with the V600-HAR91, V600-HS63, and V600-D8KR04 Sensors.

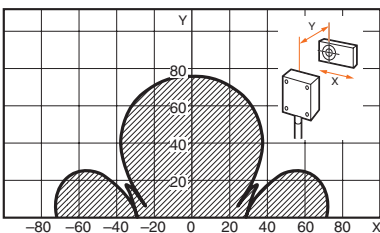

$$\text{DC speed (conveyor speed)} = \frac{75 \text{ (mm)}}{60 \text{ (ms)}} = \frac{75 \times 10^{-3} \text{ (m)}}{60 \times 10^{-3} \times 1/60 \text{ (min)}} = 75 \text{ (m/min)}$$

- Note:**
1. The DC speed varies depending on transmission distance Y and the axial offset. It is recommended that you refer to the transmission range graphs and use the product where the range is the largest.
 2. This calculation is intended as a guideline only. Perform a test with the actual product prior to use.
 3. This equation does not include transmission error processing.

Circuit Configuration

V600-HAR91 V600-HAM91

Input Circuit

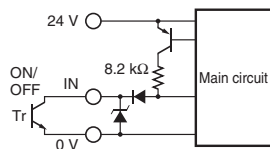

Output Circuit

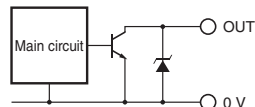

V600-HAR92

Input Circuit

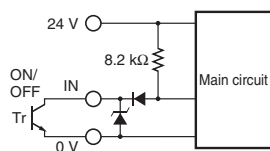

Output Circuit

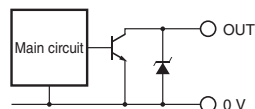

V600-HAR81 V600-HAM81

Input Circuit

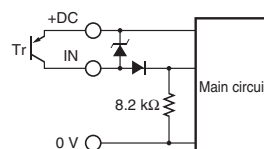

Output Circuit

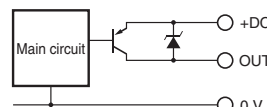

Precautions

■ Cautions

Be sure to house the V600-HA□91/-HA□81/-HA□92 together with their connectors and cable in control boxes when using them and do not expose them to water, oil, dust, metal powder, corrosive gas, or organic solvent, otherwise they may malfunction, suffer damage, or burn.

The connectors of the V600-HA□91/-HA□81/-HA□92 can be mounted to metal plates, provided that there is an insulation plate with a thickness of 1.5 mm minimum between each of the connectors and metal plates.

Input/Output

The Data Input and Data Output lines are set to "1" when the transistor turns ON and to "0" when it turns OFF.

Do not use a solid-state output with the following ratings with the V600-HAM91/-HAM81, otherwise an external input error may result.

1. Maximum switching current: 1 A min.
2. Minimum switching current: 10 mA min.
3. Response time (ON to OFF): 3 ms min.

The following OMRON products cannot be connected to this product.

- CVM1-OD219, C20H, C28H, C40H, or C60H Programmable Controllers
- Sensor Controllers other than from the S3D2 Series

When using a contact output, pay careful attention to chattering and to the minimum switching current. Also note that the minimum switching current may be specified for some solid-state outputs.

When connecting an inductive load or an electrical device that tends to generate noise to the output, connect a diode in parallel with the load. Connect the cathode side of the diode to the positive side of the power source.

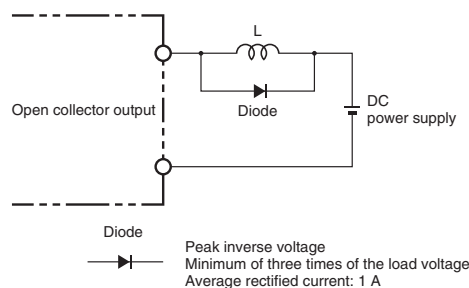

Power Supply Voltage

Do not impose any voltage exceeding the rated voltage range. Doing so, or applying alternating current (100 VAC) may cause the product to explode or burn.

Load Short-circuiting

Do not short-circuit the load connected to the product or connect to the power supply. Doing so may cause the product to explode or burn.

Wiring

Avoid wiring mistakes such as incorrect polarity in the power supply. Wiring mistakes may cause the product to explode or burn.

Correct Use

Grounding

The FG line is provided for grounding to the earth. When using the Amplifier in an environment where it is exposed to large amounts of noise or if the V600-HA□91/-HA□81/-HA□92 Amplifier malfunctions, provide a Class-3 ground (ground resistance of 100 Ω or less). Note that sharing the grounding wire with other equipment or grounding to the beam of a building will adversely affect the grounding effect.

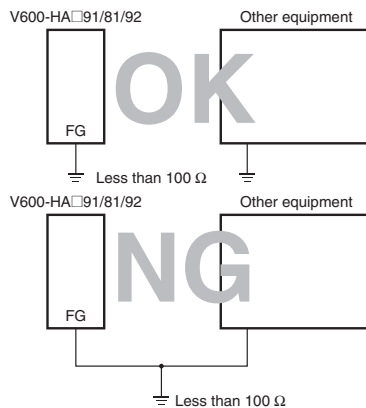

Mounting

Amplifier Spacing

When installing V600-HA□91/V600-HA□81/V600-HA□92 Amplifiers in a row, provide a minimum space of 10 mm between Amplifiers in order to prevent them from being affected by the heat produced by each Amplifier.

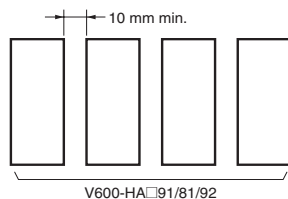

When housing the Amplifiers in a box, provide a fan or ventilation opening for radiating the heat.

When wiring power cables, which carry large current such as motor drive cables, near the V600-HA□91/81/92 Amplifiers, conduct necessary tests to make sure that the installation conditions are fully satisfied.

I/O Interface Requirements

1. The TRG input must be 10 ms min.
2. The INHIBIT input must be 20 ms min.
3. Minimum of 5 ms is required as the transfer time of the Read/Write Selection Input (W/R).
4. The read data output must be read after the Normal End Output is set to ON.

Connecting the Sensor

Hold the black part of the connector, line up the notch and push it in until it clicks.

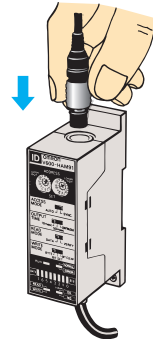

Compatibility with the SRAM Memory Type Data Carrier

1. If the Data Carrier is stationary in the transmission area for a long time when using the V600-HA□91/81 in the AUTO mode, or when using the V600-HAR92, it will drastically reduce the battery life. Therefore, stop the oscillation in the sensor either by turning off the power of the V600-HA□91/81/92 Amplifier or by setting the Inhibit input to ON.
2. Use a Data Carrier that has the oscillation frequency of 530 kHz. Note that the following models manufactured before February 1991 cannot be used.
 - V600-D2KR01
 - V600-D2KR02

Precautions When Using the AUTO Mode

If transmitting to the Data Carrier while it is traveling under the AUTO mode, conduct tests to make sure that the travel speed and installation conditions are fully satisfied.

Dimensions

Note: All units are in millimeters unless otherwise indicated.

Amplifier

V600-HAR91/-HAR81

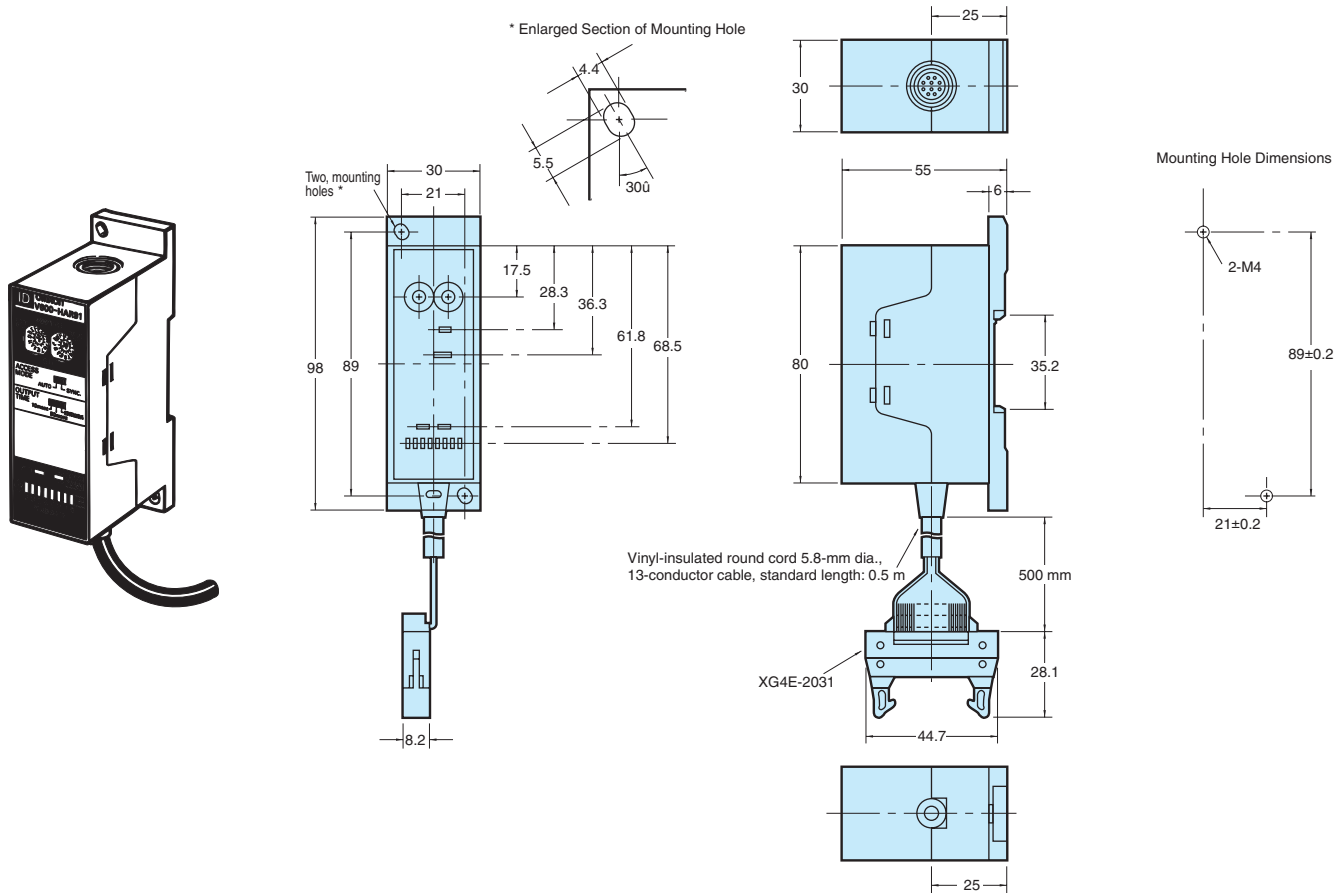

V600-HAM91/-HAM81

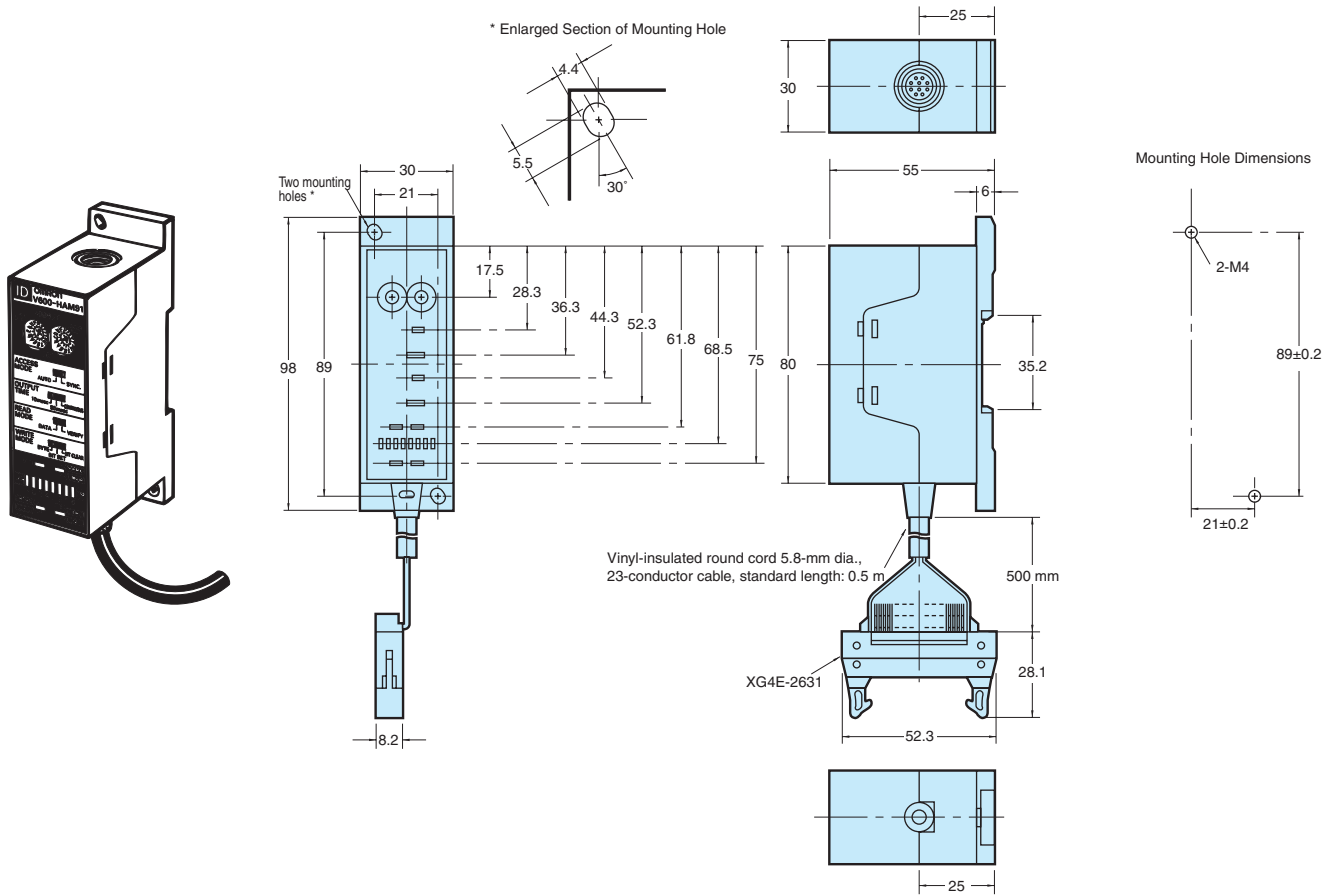

V600-HAR92

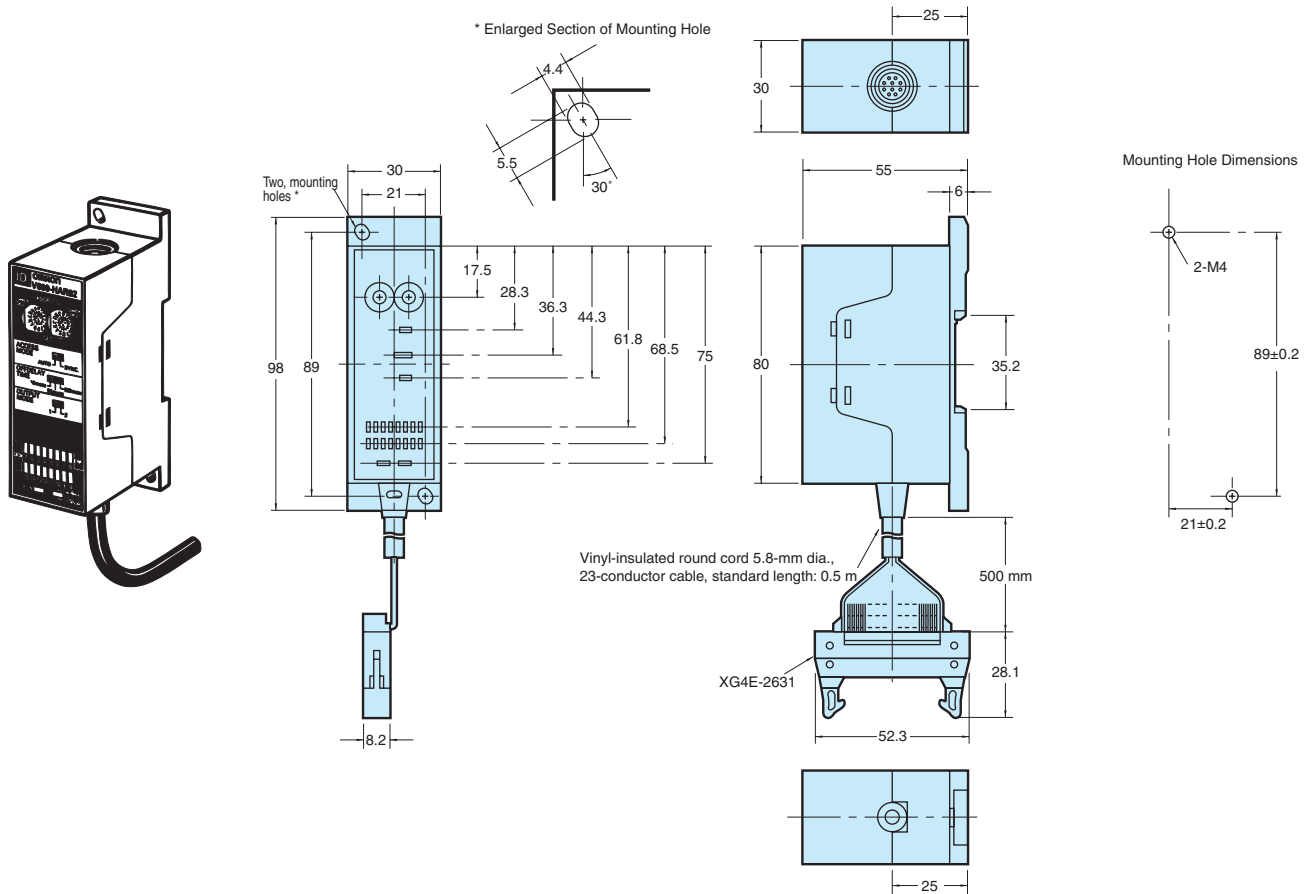

Sensor

V600-HS51

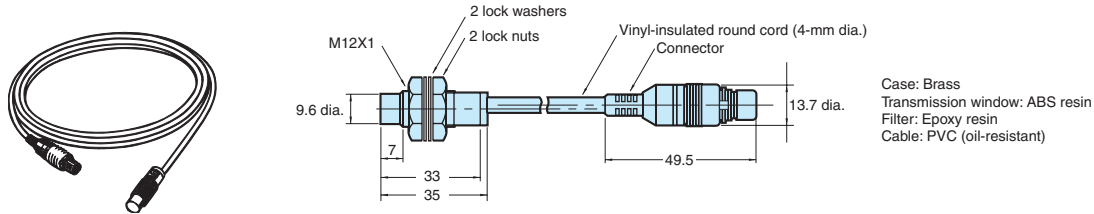

V600-HS61

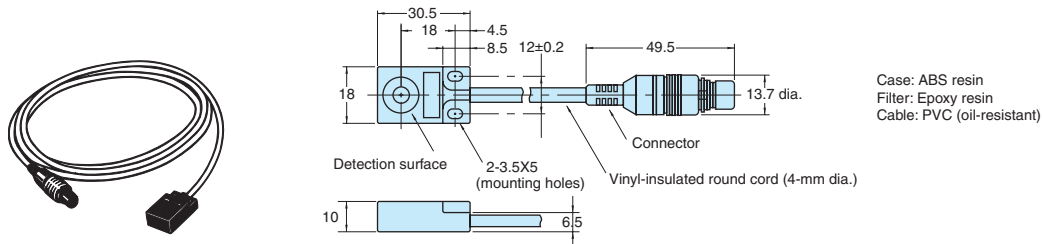

V600-HS63

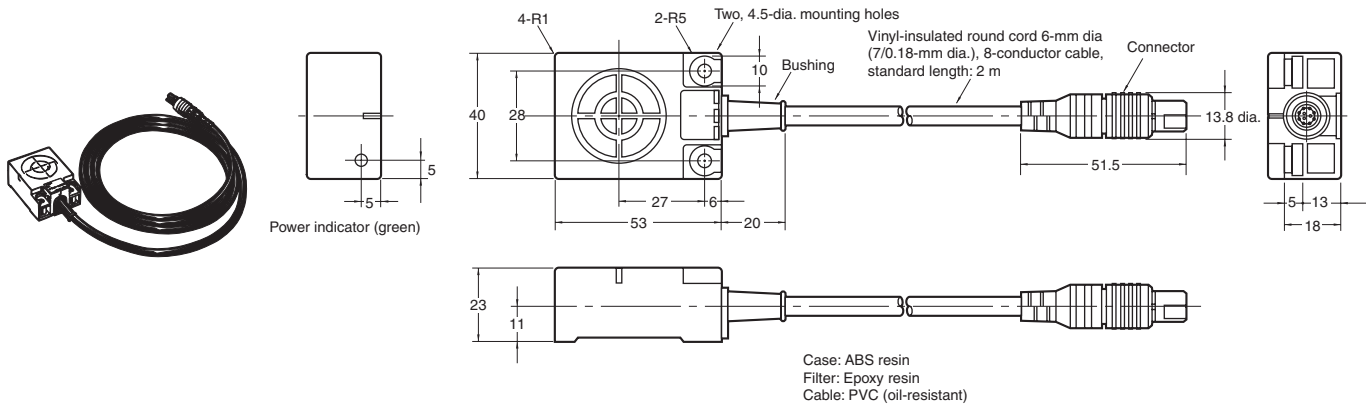

V600-HS67

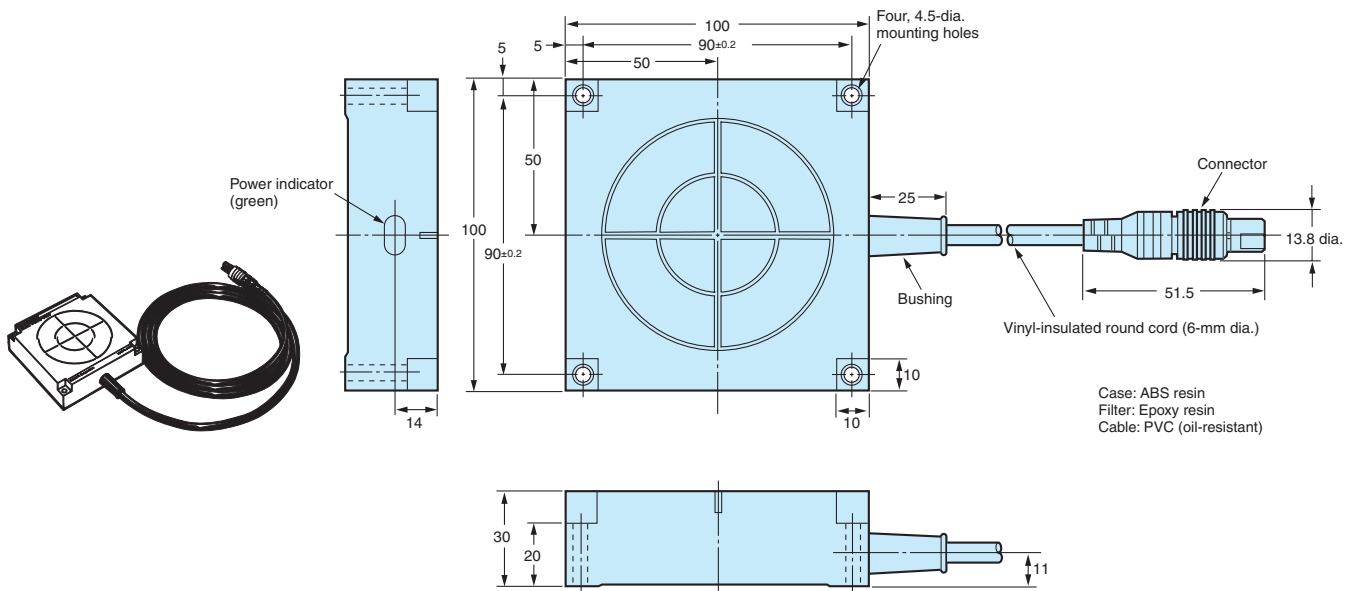

Interface Cable

V600-A6□R (for V600-HAR91/-HAR81))

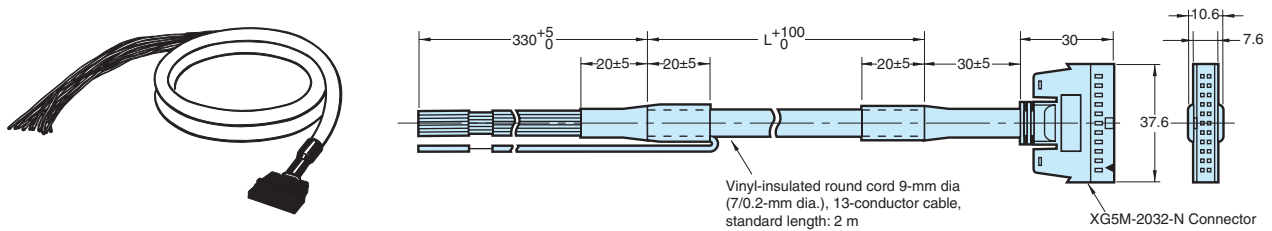

V600-A6□M (for V600-HAM91/-HAM81/-HAR92)

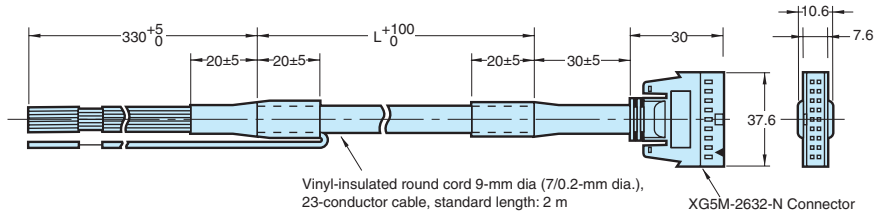
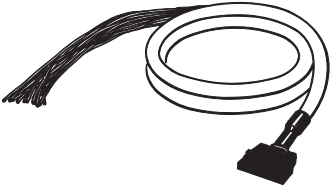

Model	L (m)
V600-A60R/60M	2
V600-A61R/61M	5
V600-A62R/62M	10

V600-series Data Carrier

Refer to page A- 40.

ALL DIMENSIONS SHOWN ARE IN MILLIMETERS.
 To convert millimeters into inches, multiply by 0.03937. To convert grams into ounces, multiply by 0.03527.

Intelligent Flag III V600-HAM42-DRT

Employs Innovative Electronic ID Flags to Replace Mechanical Flags, and Offers DeviceNet Compatibility

- Conforms to DeviceNet standards.
- Uses the same main functions (Read, Write, Bit Set, Bit Clear, etc.) as those of the V600-HA Intelligent Flag Series.
- Responds flexibly to applications with data reading up to 24 bits.
- Allows data to be written in units of up to 16 bits.

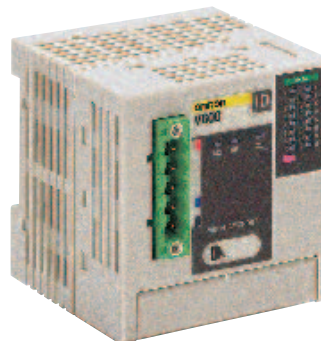





Ordering Information/Specifications

■ Amplifier

Item	V600-HAM42-DRT
Communications power supply voltage	11 to 25 VDC (provided from communications connector)
Internal circuit power supply voltage	18 to 26.4 VDC
Internal current consumption	Communications power supply: 40 mA max. Internal circuit power supply: 150 mA max.
Noise immunity	Internal circuit power supply normal: ± 600 V Internal circuit power supply common: $\pm 1,500$ V
Dielectric strength	50/60 Hz at 500 V AC for 1 minute; leakage current 10 mA max.
Vibration resistance	10 to 55 Hz, 1.5-mm double amplitude, with 4 sweeps of 8 min each in 3 directions
Shock resistance	294 m/s ² , 3 times each in 3 directions (18 times total)
Ambient temperature	0 to 55°C (with no icing)
Ambient humidity	35% to 85% RH (with no condensation)
Storage temperature	-25 to 65°C
Degree of protection	IEC 60529: IP20 (panel mounted)
Mounting method	DIN track or direct mounting using accessory fittings (M4 screws)
Weight	Approx. 150 g

■ Sensor

Model	V600-HS51	V600-HS61	V600-HS63	V600-HS67
Shape				
Item				
Oscillation frequency	530 kHz			
Ambient temperature	-10 to 60°C		-10 to 70°C	
Storage temperature	-25 to 75°C			
Ambient humidity	35% to 95%			
Insulation resistance	50 MΩ (at 500 V DC) between cable terminal and case			
Dielectric strength	1,000 V AC, 50/50 Hz for 1 min between cable terminal and cable (leakage current 1 mA max.)			
Degree of protection	IEC 60529: IP67			
Vibration resistance	10 to 2,000 Hz, 3-mm double amplitude, with 2 sweeps of 15 min each in 3 directions		10 to 500 Hz, 2-mm double amplitude, with 3 sweeps of 11 min each in 3 directions	
Shock resistance	981 m/s ² , 3 times each in 3 directions (18 times total)		490 m/s ² , 3 times each in 3 directions (18 times total)	
Cable length	2 m (fixed)			
Wireless transmission error direction	16-bit CRC (Cyclic Redundancy Check) in both directions			
Indicator	---		Power: green	
Weight	Approx. 70 g		Approx. 190 g	Approx. 540 g

■ Performance

Number of Master words	Input: 2; output: 2 (total: 4 words)	
Number of sensor connections	1 channel	
Applicable sensors	V600-HS51, V600-HS61, V600-HS53, V600-HS67	
Read	DATA READ mode	Read 24 bits of data from the set address
Write	BYTE mode	Write 8-bit or 16-bit data from the set address
	BIT SET mode	Set (write "1") only the data for the bits that are set (with "1") at the set address
	BIT CLEAR mode	Clear (write "0") only the data for the bits that are set (with "1") at the set address

Transmission Distance Specifications

Data Carrier		Amplifier Sensor	V600-HAM42-DRT			
			V600-HS51	V600-HS61	V600-HS63	V600-HS67
Memory EEP-ROM Type	V600-D23P53		0.5 to 3.0 mm	0.5 to 3.0 mm	---	---
	V600-D23P54		0.5 to 5.0 mm	0.5 to 5.5 mm	---	---
	V600-D23P55		0.5 to 7.0 mm	0.5 to 7.0 mm	---	---
	V600-D23P61		0.5 to 8.0 mm	0.5 to 9.0 mm	2 to 16 mm	---
	V600-D23P66N		---	---	5 to 30 mm	5 to 35 mm
	V600-D23P66SP		---	---	5 to 25 mm	5 to 30 mm
	V600-D23P71		---	---	5 to 35 mm	10 to 65 mm
	V600-D23P72		---	0.5 to 18 mm	5 to 35 mm	10 to 45 mm
Memory S-RAM Type	V600-D8KR12		5 to 15 mm	5 to 18 mm	5 to 45 mm	10 to 50 mm
	V600-D2KR16		---	---	2 to 15 mm	---
	V600-D8KR04		---	---	10 to 65 mm	10 to 90 mm

Note: 1. Sensor installation conditions

- V600-HS51: When flush-mounted in iron
Axial offset from the Data Carrier ± 2.0 mm
- V600-HS61: When surface-mounted on metal (ferrous)
Axial offset from the Data Carrier: ± 2.0 mm
- V600-HS63: When surface-mounted on metal (ferrous)
Axial offset from the Data Carrier: ± 10.0 mm
- V600-HS67: When surface-mounted on metal (ferrous)
Axial offset from the Data Carrier: ± 10.0 mm

2. Data Carrier installation conditions

- V600-D23P53/-P54: When flush-mounted in iron
- V600-D23P55: When flush-mounted in iron, the transmission distance decreases greatly.
- V600-D23P66N/-P66SP/-P71/-P72: When surface-mounted on resin (no metal on the backside)
- V600-D23P61: When surface-mounted on metal (ferrous)
- V600-D8KR12/04: When surface-mounted on metal (ferrous)
- V600-D2KR16: When the Data Carrier attached to the holder is mounted on metal (ferrous)

- 3.** The transmission distance specified in the specifications is also applicable when the Data Carrier is mounted on non-metallic surfaces.
- 4.** The Data Carrier is stationary.

System Configuration

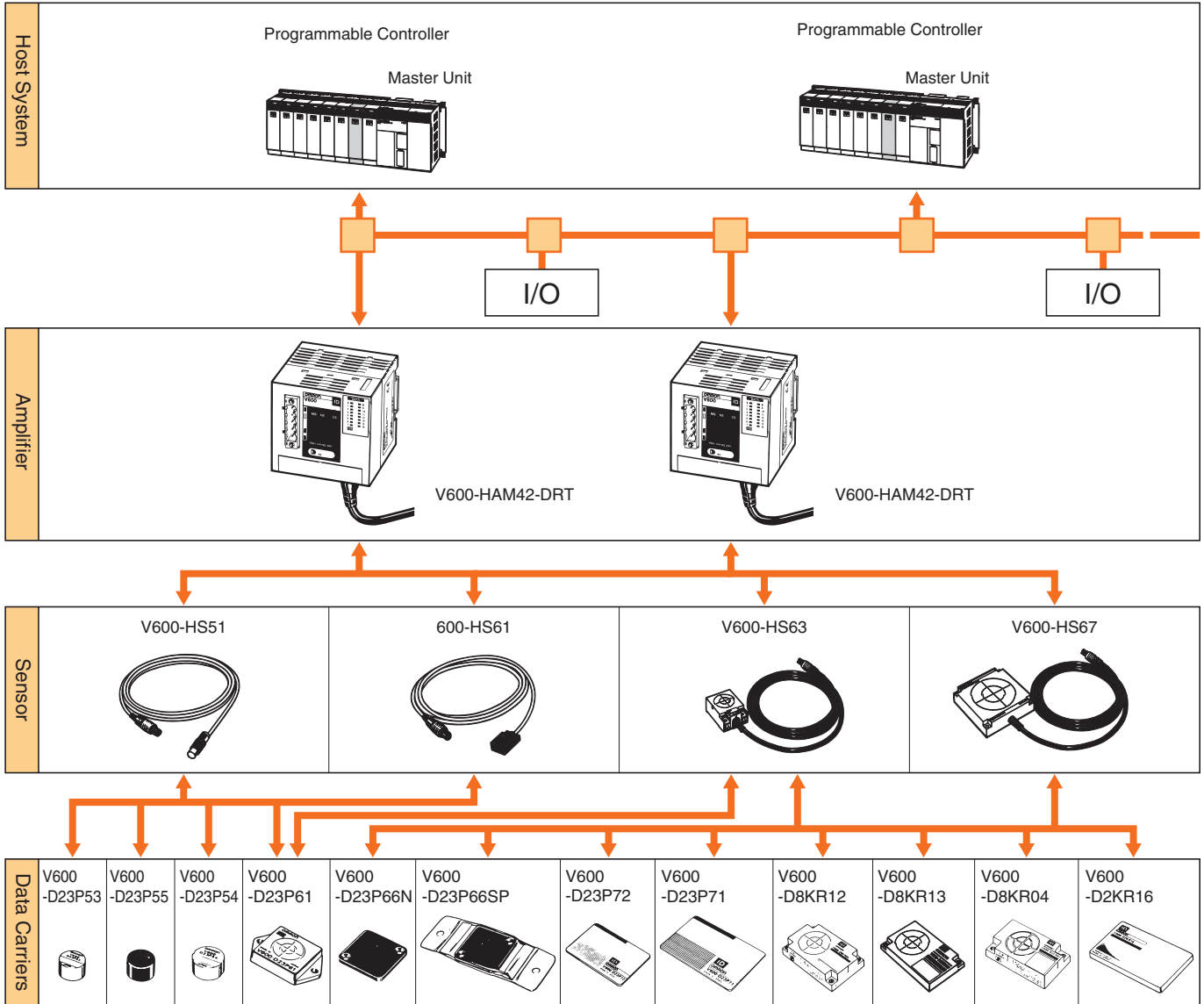

Characteristic Data (Typical)

Transmission Range

Note: All units are in millimeters unless otherwise indicated.

Combinations with the V600-HS51 Sensor

V600-HS51 & V600-D23P53

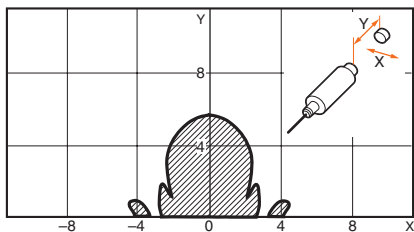

V600-HS51 & V600-D23P54

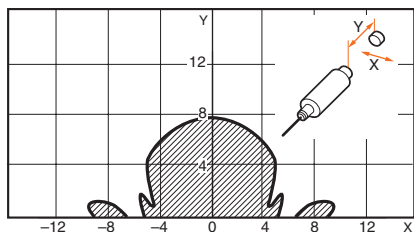

V600-HS51 & V600-D23P55

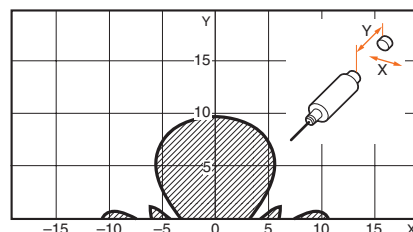

V600-HS51 & V600-D23P61

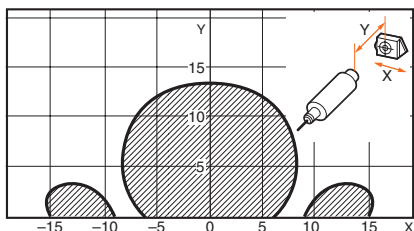

V600-HS51 & V600-D23P66N

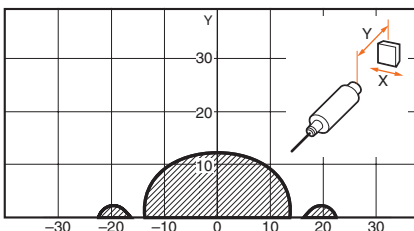

V600-HS51 & V600-D8KR12

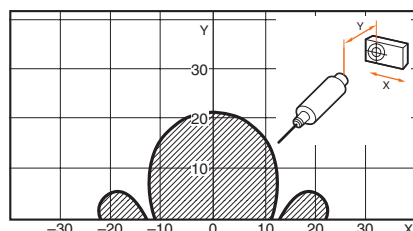

Combinations with the V600-HS61 Sensor

V600-HS61 & V600-D23P53

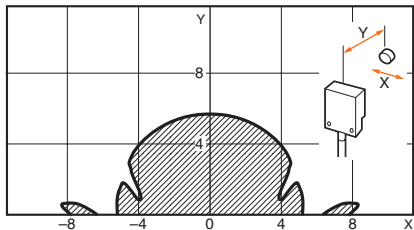

V600-HS61 & V600-D23P54

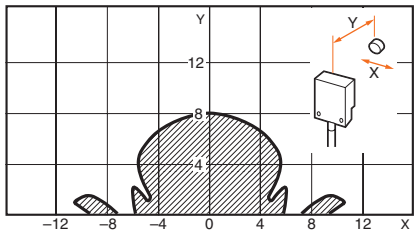

V600-HS61 & V600-D23P55

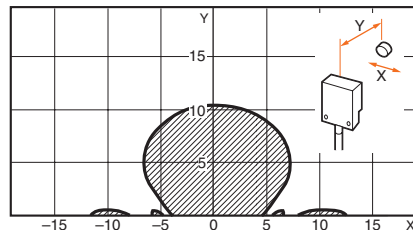

V600-HS61 & V600-D23P61

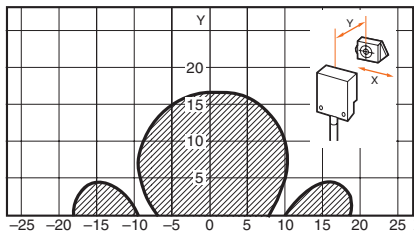

V600-HS61 & V600-D23P72

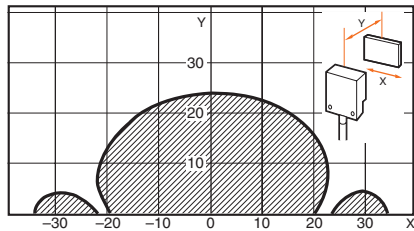

V600-HS61 & V600-D8KR12

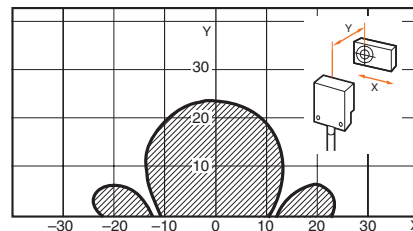

Combinations with the V600-HS63 Sensor

V600-HS63 & V600-D23P55

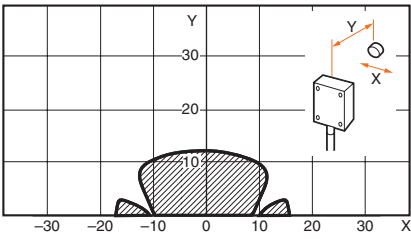

V600-HS63 & V600-D23P61

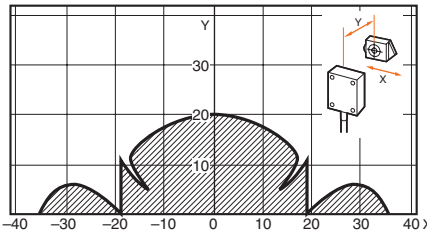

V600-HS63 & V600-D23P66N

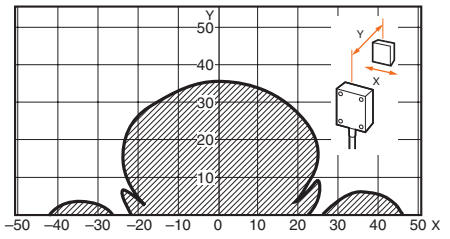

V600-HS63 & V600-D23P66SP

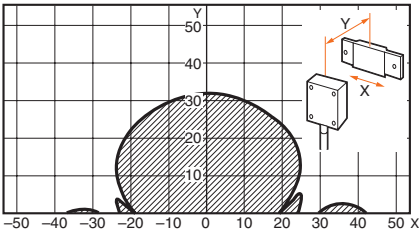

V600-HS63 & V600-D23P71

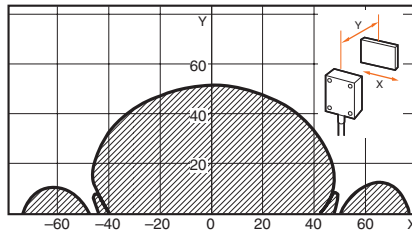

V600-HS63 & V600-D23P72

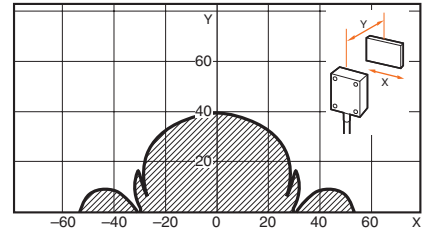

V600-HS63 & V600-D8KR12

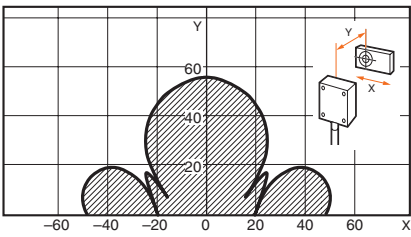

V600-HS63 & V600-D8KR04

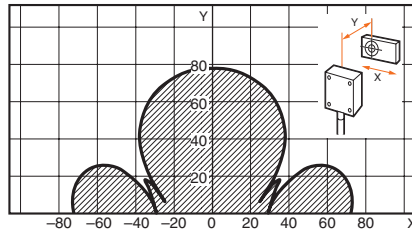

V600-HS63 & V600-D2KR16

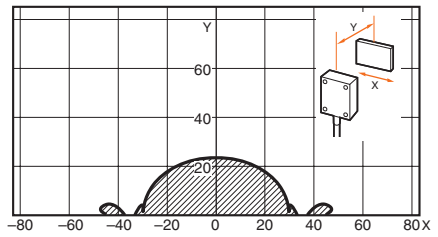

Combinations with the V600-HS67 Sensor

V600-HS67 & V600-D23P66N

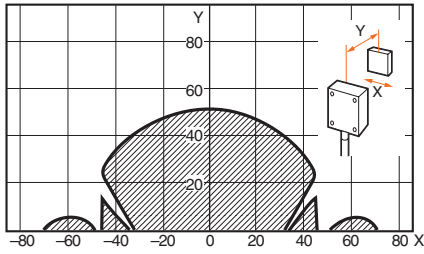

V600-HS67 & V600-D23P66SP

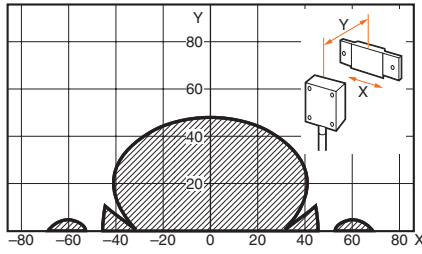

V600-HS67 & V600-D23P71

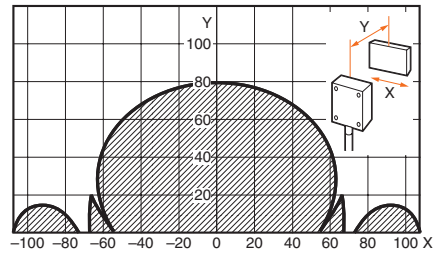

V600-HS67 & V600-D23P72

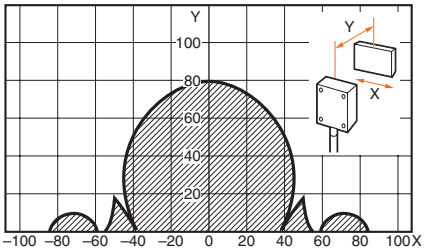

V600-HS67 & V600-D8KR12

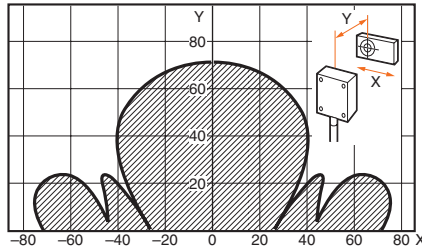

V600-HS67 & V600-D8KR13

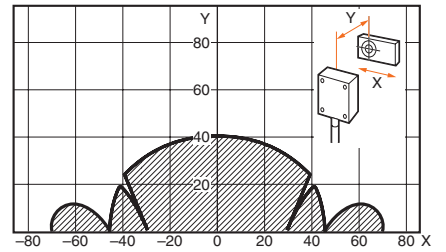

V600-HS67 & V600-D8KR04

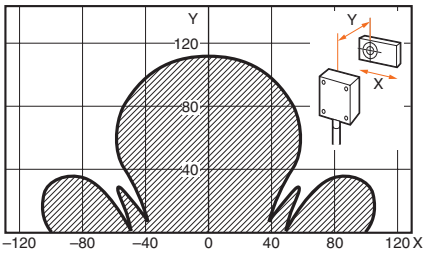

Transmission Time

The transmission time is the time required for transmission between the Sensor and the Data Carrier.

Model		V600-HAM42-DRT		
		Read	Write	
Mode type		DATA READ mode	BYTE mode	BIT SET mode, BIT CLEAR mode
Data Carrier type	Battery-less type	79 ms	140 ms	152 ms
	Built-in battery type	64 ms	97 ms	109 ms

Battery-less type: V600-D23P53, V600-D23P55, V600-D23P54, V600-D23P61, V600-D23P66N, V600-D23P66SP, V600-D23P72, V600-D23P71

Built-in battery type: V600-D8KR12, V600-D8KR13, V600-D8KR04, V600-D2KR16

Dimensions

Note: All units are in millimeters unless otherwise indicated.

Amplifier

V600-HAM42-DRT

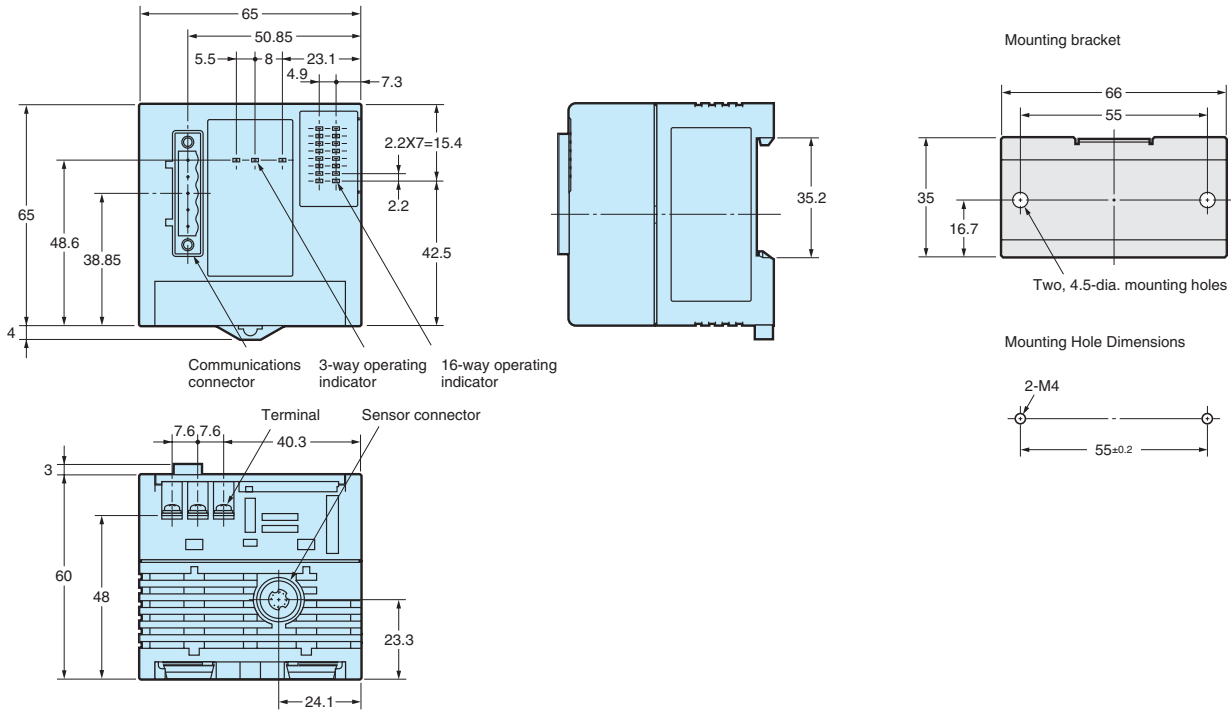

Sensor

- V600-HS51
- V600-HS61
- V600-HS63
- V600-HS67

Refer to pages A-60 to A-61.

V600-series Data Carrier

Refer to pages A-40 to A-41.

ALL DIMENSIONS SHOWN ARE IN MILLIMETERS.
 To convert millimeters into inches, multiply by 0.03937. To convert grams into ounces, multiply by 0.03527.

Electromagnetic Inductive RFID System V670

High-speed, Long-life, Battery-less RFID System







- High-speed communications requiring only 14 ms to read or write 128 bytes of data.
- Long-life battery-free tags to read and write data 1,000 million times.
- Versatile functions, such as auto repeat, repeat input trigger, and tag specification.
- Self-execution mode for data processing with no host controller intervention.

Note: The V670 conforms to the FCC Rules and EU Directives, allowing it to be used in a wide variety of countries. In other countries, it may be subject to radio regulations and EMC restrictions. Contact your OMRON representative for details.



Ordering Information

List of Models

Product	Model	Image	Shape/Specification	Shape/Specification
ID Tag	V670-D13F03		40 × 40 × 4.5 mm	128 bytes
Antenna	V670-H11		40 × 53 × 23 mm	2-m cable
Controller	V670-CD1D		90 × 66 × 75 mm	RS-232C interface operating at 24 VDC with a single antenna connector
Antenna Extension Cables	V670-A40		3 m	Material: Polyvinyl chloride Connectors are not watertight.
	V670-A41		10 m	
	V670-A42		18 m	
	V670-A43		28 m	
Programming Console	C200H-PRO27-E			Operation monitor, set value display, communications, test communications, and error log functions.
Programming Console Conversion Cable	V700-P10		2 m	Connects the V670-CD1D and C200H-PRO27-E.

System Configuration

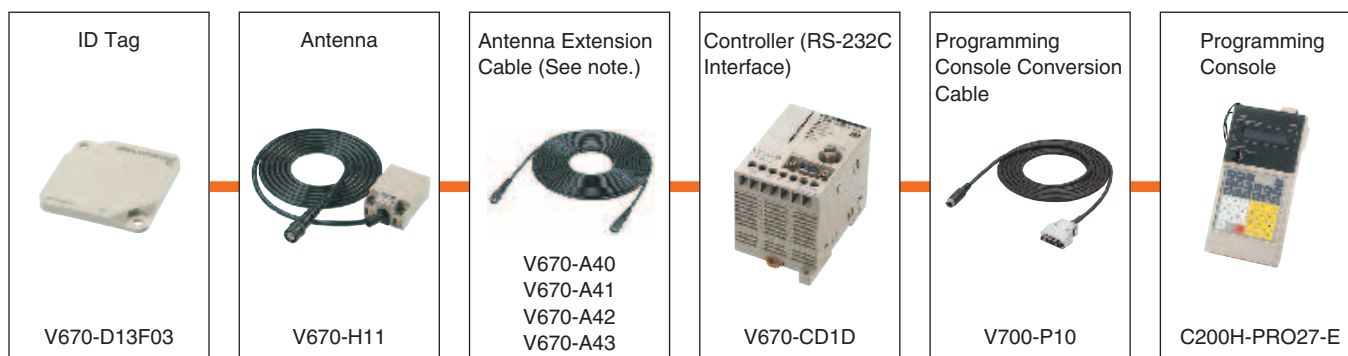

Note: When extending the antenna cable, do not use any cable other than the Antenna Extension Cables from OMRON.

Specifications

■ ID Tags

Item	V670-D13F03
Memory capacity	128 bytes
Memory type	FeRAM
Memory life	Number of accesses: 1,000 million times (See note.)
Data storage time	10 years (after the data is written or read)
Ambient temperature	Operating: -10 to 70°C
Ambient temperature	Storage: -10 to 70°C
Ambient humidity	Operating: 35% to 85%
Degree of protection	IEC60529 IP67
Vibration resistance	10 to 2,000 Hz, 1.5-mm double amplitude at 150 m/s ² acceleration with 10 sweeps in X, Y, and Z directions for 15 minutes each
Shock resistance	500 m/s ² in X, Y, and Z directions 3 times each (18 times in total)
Material	Filled with ABS/Epoxy resin
Weight	Approx. 6 g

Note: The number of accesses is the total number of read or write communications.

■ Antenna



Item	V670-H11
Oscillation frequency	13.56 MHz
Ambient temperature	Operating: -10 to 70°C
Ambient humidity	Operating: 35% to 85%
Ambient temperature	Storage: -25 to 85°C
Ambient humidity	Storage: 35% to 85%
Insulation resistance	20 MΩ min. (at 1,000 VDC) between the terminals and case
Dielectric strength	1,000 VAC for 1 minute between the terminals and case with a current leakage of 1 mA
Degree of protection	IEC60529 IP67
Vibration resistance	10 to 150 Hz, 0.7-mm double amplitude at 50 m/s ² acceleration with 10 sweeps in X, Y, and Z directions for 8 minutes each
Shock resistance	150 m/s ² in X, Y, and Z directions 3 times each (18 times in total)
Material	Filled with ABS/Epoxy resin
Cable length	2 m
Weight	Approx. 160 g

Note: The connector is not watertight.

Controller

Item	V670-CD1D
Host interface specifications	RS-232C
Number of connectable antennas	1
Power supply voltage	24 VDC \pm 10%
Power consumption	7 W max.
Ambient temperature	Operating: 0 to 55°C (with no icing)
Ambient humidity	Operating: 35% to 85% (with no condensation)
Ambient temperature	Storage: -20 to 75°C (with no icing)
Ambient humidity	Storage: 35% to 85% (with no condensation)
Insulation resistance	20 MW min. (at 1,000 VDC) 1. Between ground terminal and both power supply terminals 2. Between both power supply terminals and both output terminals 3. Between both power supply terminals and case 4. Between both output terminals and ground terminal 5. Between both output terminals and case 6. Between ground terminal and case
Dielectric strength	1,000 VAC for 1 minute in all the above combinations with a maximum leakage current of 5 mA
Degree of protection	Panel mounted
Vibration resistance	10 to 150 Hz, 0.2-mm double amplitude at 15 m/s ² acceleration with 10 sweeps in X, Y, and Z directions for 8 minutes each.
Shock resistance	150 m/s ² in X, Y, and Z directions 3 times each (18 times in total)
Ground	Ground at a resistance of less than 100 Ω
Material	PC/ASA resin
Weight	Approx. 270 g

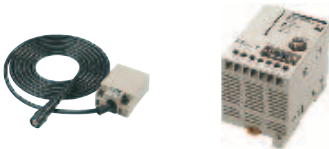
Transmission Distance Specifications

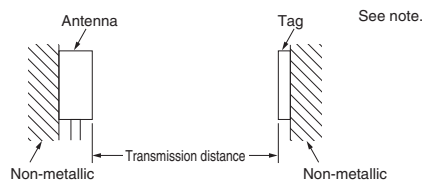
Antenna/Controller	ID Tag	Transmission distance		Measurement conditions	
		Without Extension Cable	With Extension Cable		
		5.0 to 23.0 (axial offset: \pm 1)	A40 (3 m)	5.0 to 21.5	
			A41 (10 m)	5.0 to 21.0	
			A42 (18 m)	5.0 to 20.5	
			A43 (28 m)	5.0 to 20.0	

- Note:**
- When the background object of the antenna is metal, the communications area is almost the same. If the tag is attached on metal without a gap, no communications will be possible. For details, refer to the *V670 User's Manual (Z148-E1)*.
 - The transmission distance is reduced if an Extension Cable is used. Also, the transmission distance varies with the type of Extension Cable.

Characteristic Data (Typical)

Transmission Range

Combination of V670-H11 and V670-D13F03

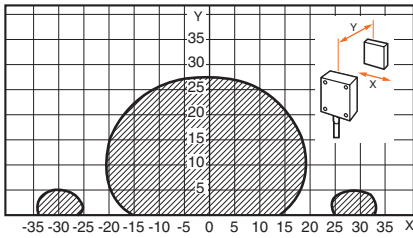

Note: The above data applies only if an Extension Cable is not used.

Transmission Time (Reference)

Communications time is a period required for communications between the antenna and ID Tag.

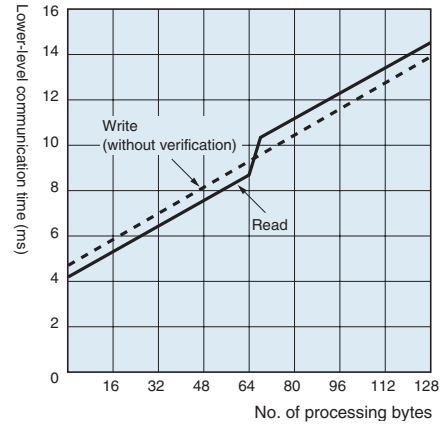

Operation	No. of bytes	Calculation formula
Read	1 to 64 bytes	$T = 0.07 \times N + 4.22$
	65 to 128 bytes	$T = 0.07 \times N + 5.64$
Write	1 to 128 bytes	$T = 0.07 \times N + 4.72$

Note: N: Number of bytes
T: Communications time (ms)

Movement Speed (Reference)

Tag movement speed must be a maximum of 50% of the maximum movement speed according to the number of processing bytes to ensure the reliability of communications. Conduct proper on-site tests to determine the tag movement speed. (The following data applies only if an Extension Cable is not used.)

Read

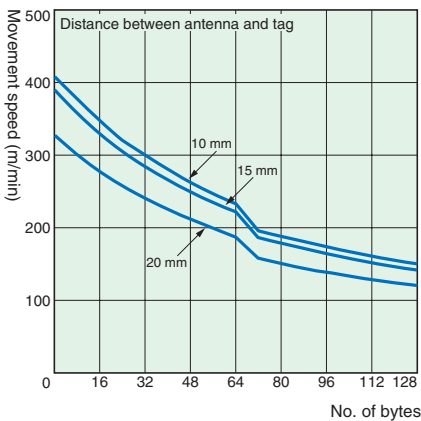

Write

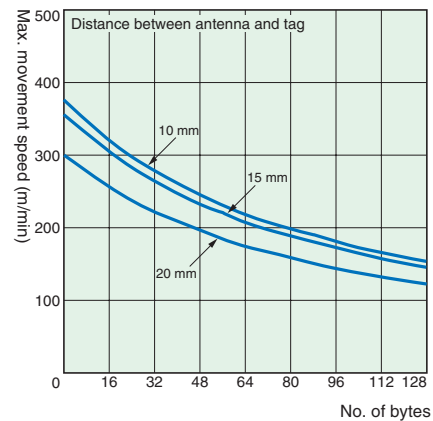

Precautions

Standard Conformity

The V670 conforms to the following standards.

FCC Rules (Federal Communications Commission)

This Product Complies with Part 15 Subpart C of the FCC Rules.
FCC ID: E4E6CYCIDV6700101

Radio: EN 300 330 V1.2.1 (May 1999)
EMC: EN 301 489-3 (EN 301 489-1)
Safety: EN 61010-1: 1993+A2

EC Declaration of Conformity

Hereby, OMRON Corporation declares that this RFID System, V670-H11 Antenna, and V670-CD1D Controller are in compliance with the essential requirements and other relevant provisions of Directive 1999/5/EC, and satisfy tests for the appropriate requirements on the following relevant standards.

Countries of intended use:
Austria, Belgium, Denmark, Finland, France, Germany, Greece, Iceland, Ireland, Italy, Luxembourg, Netherlands, Norway, Portugal, Spain, Sweden, Switzerland, United Kingdom



Dimensions

Note: All units are in millimeters unless otherwise indicated.

ID Tag

V670-D13F03

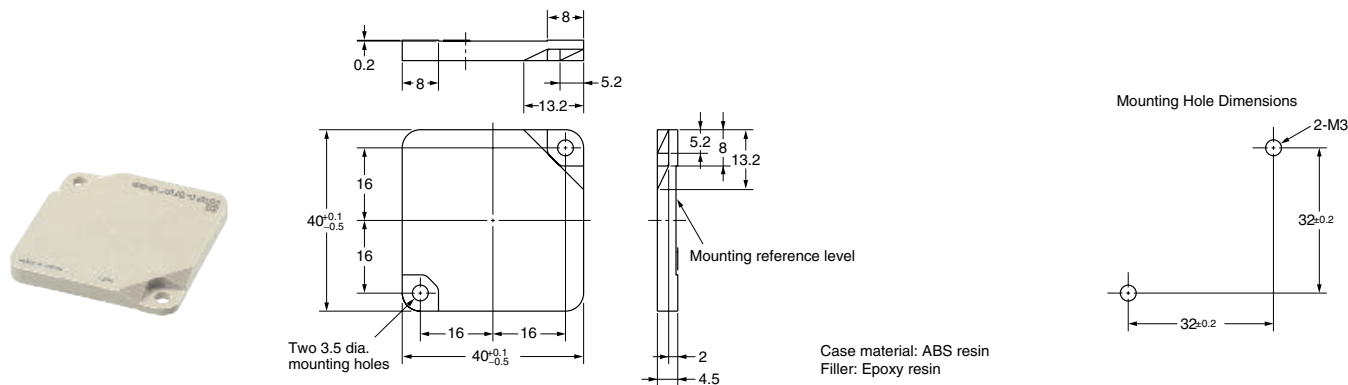

Antenna

V670-H11

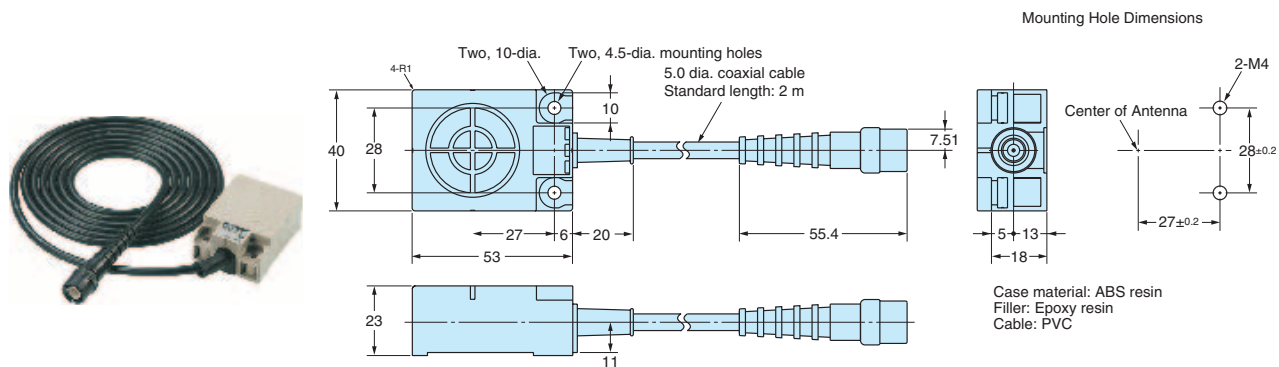

Controller

V670-CD1D

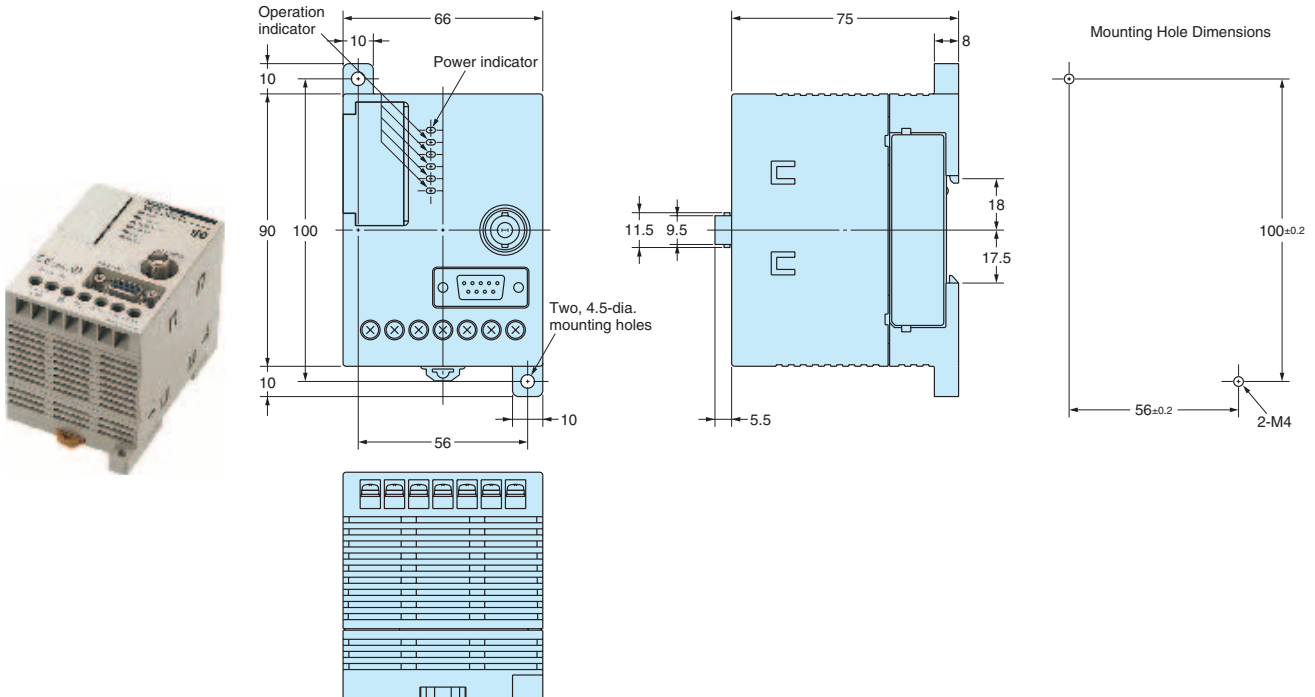

Extension Cable

V670-A40/A41/A42/A43

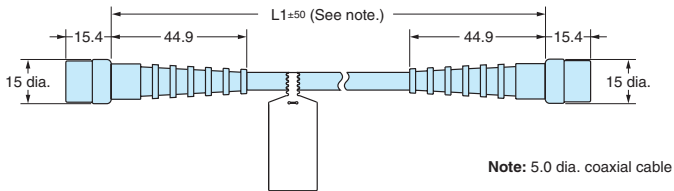

Model	Length
V670-A40	3 m
V670-A41	10 m
V670-A42	18 m
V670-A43	28 m

ALL DIMENSIONS SHOWN ARE IN MILLIMETERS.
 To convert millimeters into inches, multiply by 0.03937. To convert grams into ounces, multiply by 0.03527.

Electromagnetic Inductive RFID System V700





A High-functionality High-performance RFID System That Revolutionizes Product and Distribution Management in the Production Environment









- A long transmission distance and a wide transmission range allow low position displacement and axial offset of ID Tags to be handled with ease.
- Reading and writing are possible with several ID Tags in the Antenna's transmission range, allowing use in new applications.
- Easy-to-use, reasonably-priced ID Tags enable the creation of low-cost systems even in applications using a large number of Tags.
- A Compact Reader Writer, the V700-HMD11(-1), is now available.
- The lineup includes an ID Link Unit that is compatible with multi-drop connections and RS-485 interfaces.
- The V700-HMD11-1 Compact Reader Writer can be connected directly to the ID Link Unit or an OMRON PLC without an AC Adapter.



Ordering Information



■ List of Models

Name	Model		Specifications/Design
ID Tag	V700-D13P31		20 dia. × t 2.7 mm Coin-shaped 128 bytes (with user area of 112 bytes)
	V700-D23P41		3.9 dia. × 25 mm Stick-shaped 256 bytes (with user area of 240 bytes)
ID Tag Holder	V700-A80		Special holder for the V700-D13P31 (There is no ID Tag provided with the product.)
Antenna	V700-H01 (Standard Antenna)		250 × 200 × 35 mm 100-mm cable
	V700-H02 (Wide-field Antenna)		650 × 200 × 35 mm 100-mm cable



Name	Model	Image	Specifications/Design
Controller	V700-CD1D-V3		90 × 65 × 75 mm RS-232C interface 24 VDC, 1 channel for Antenna connection
	V700-CD2D-V3		RS-485 interface Maximum number of Controllers that can be connected: 31 24 VDC, 1 channel for Antenna connection
Antenna Cable	V700-A40		2 m
	V700-A41		3 m
	V700-A42		5 m
	V700-A43		10 m
	V700-A44		20 m
	V700-A45		30 m
Compact Reader Writer	V700-HMD11		40 × 53 × 23 mm RS-232C interface 5 VDC supplied via AC Adapter 2-m cable
	V700-HMD11-1		RS-232C interface 5 VDC supplied via AC Adapter for V700-L12 and CPM2C PLCs 1-m cable 2-m cable 4-m cable
ID Link Unit	V700-L12		110 × 65 × 64 mm RS-232C and RS-485 interface Unit for multiple connections
Programming Console	C200H-PRO27-E		Equipped with the following functions: Execution status monitor, set value display, transmission execution, transmission test, noise measurement, reading error contents
Programming Console Connecting Cable	V700-P10		2 m Cable for connecting the V700-CD□D-V□ and C200H-PRO27-E

Specifications

■ ID Tags

Item	Model	
	V700-D13P31 	V700-D23P41 
Memory capacity	112 bytes (user area)	240 bytes (user area)
Memory type	EEPROM	
Data backup time	10 years after data written	
Data writing times	100,000 times per address	
Ambient operating temperature (during transmission)	-20 to 70°C (with no icing)	-25 to 70°C (with no icing)
Ambient operating temperature (not during transmission)	-40 to 110°C (with no icing) Heat resistance: Constant high temperature: 180°C for 200 hours Thermal cycle: 25°C/180°C, 30 minutes, 200 cycles	-40 to 110°C (with no icing)
Ambient storage temperature	-40 to 110°C (with no icing)	-40 to 110°C (with no icing)
Ambient operating humidity	No restrictions	35% to 95% (with no condensation)
Degree of protection	IEC60529: IP68	IEC60529: IP67
Vibration resistance	10 to 2,000 Hz, 0.75-mm single amplitude, 150-m/s ² acceleration with 10 sweeps of 15 min each in X, Y, and Z directions	
Shock resistance	500-m/s ² acceleration for 3 times each in X, Y, and Z directions (18 times in total)	
Material	PPS resin	Case: PBT resin; Filling: Epoxy resin
Weight	Approx. 2 g	Approx. 1 g

■ Controllers

Item	Model	
	V700-CD1D-V3 	V700-CD2D-V3 
Host interface	RS-232C	RS-485 (Up to 31 Controllers can be connected.)
Number of connectable Antennas	1	
Power supply voltage	24 VDC +10%/-15%	
Power consumption	20 W max.	
Insulation resistance	20 MΩ min. (at 100 VDC) between the power supply terminals and ground terminal, power supply terminals and I/O terminals, power supply terminals and case, I/O terminals and ground terminal, I/O terminals and case, and ground terminal and case	
Dielectric strength	500 VAC (50/60 Hz, 1 minute) between the above terminals (leakage current: 10 mA max.)	
Vibration resistance	10 to 150 Hz, 0.30-mm double amplitude with 4 sweeps of 8 min each in X, Y, and Z directions	
Shock resistance	200-m/s ² acceleration for 3 times each in X, Y, and Z directions (18 times in total)	
Ambient operating temperature	-10 to 55°C (with no icing)	
Ambient operating humidity	35% to 85% (with no condensation)	
Ambient storage temperature	-25 to 65°C (with no icing)	
Ambient storage humidity	35% to 95% (with no condensation)	
Degree of protection	IEC60529: IP30 (panel mounted)	
Ground	Ground at a resistance of less than 100 Ω. If grounding is not performed properly, transmission specifications may be adversely affected by the surrounding environment.	
Weight	Approx. 290 g	

■ Antennas

Item	Model	
	V700-H01	V700-H02
Oscillation frequency	125 kHz	
Insulation resistance	20 MΩ min. (at 500 VDC) between the cable terminals and the case	
Dielectric strength	1,000 VAC (50/60 Hz, 1 minute) between the cable terminals and the case (leakage current: 1 mA max.)	
Vibration resistance	10 to 150 Hz, 1.50-mm double amplitude with 2 sweeps of 8 min each in X, Y, and Z directions	
Shock resistance	300-m/s ² acceleration for 3 times each in X, Y, and Z directions (18 times in total)	
Ambient operating temperature	-20 to 55°C (with no icing)	
Ambient storage temperature	-35 to 65°C (with no icing)	
Ambient operating humidity	35% to 85% (with no condensation)	
Ambient storage humidity	35% to 95% (with no condensation)	
Degree of protection	IEC60529: IP40 (except connector)	
Material	Case: PC/ASA resin; Rear panel: Phenol resin; PVC (The connector is not resistant to water or oil.)	
Cable length	Maximum connection distance: 50.1 m using extension cable.	
Weight	Approx. 800 g	Approx. 1,760 g

■ Compact Reader Writers

Item	Model	
	V700-HDM11	V700-HMD11-1
Host interface	RS-232C	
Power consumption	5 VDC ±5% (supplied via V600-A20 AC Adapter) Oscillating: 200 mA max.; Not oscillating: 25 mA max.	5 VDC ±5% (supplied via connector) 250 mA max.
Insulation resistance	50 MΩ min. (at 500 VDC) between the cable terminals and the case	
Dielectric strength	1,000 VAC (50/60 Hz, 1 minute) between the cable terminals and the case (leakage current: 1 mA max.)	
Vibration resistance	10 to 150 Hz, 1.50-mm double amplitude with 4 sweeps of 8 min each in X, Y, and Z directions	
Shock resistance	300-m/s ² acceleration for 3 times each in X, Y, and Z directions (18 times in total)	
Ambient operating temperature	-10 to 55°C (with no icing)	
Ambient operating humidity	25% to 85% (with no condensation)	
Ambient storage temperature	-25 to 65°C (with no icing)	
Ambient storage humidity	25% to 95% (with no condensation)	
Degree of protection	IEC60529: IP67 The connector is not resistant to water or oil.	
Material	Case: ABS resin; Filling: Epoxy resin; Cable: PVC (oil-resistant)	
Cable length	2 m (RS-232C signal lines can be extended up to a total length of 15 m.)	1, 2, 4 m
Weight	Approx. 210 g	Approx. 210 g (2 m)

■ ID Link Unit

Item	V700-L12 
Host interface	RS-232C or RS-485 (special 1:N protocol)
Number of connectable Antennas	1
Power supply voltage	24 VDC +10%/–15%
Power consumption	10 W max.
Insulation resistance	50 MΩ min. (at 500 VDC) between the power supply terminals and the ground terminal
Dielectric strength	1,000 VAC (50/60 Hz, 1 minute) between the power supply terminals and the ground terminal (leakage current: 5 mA max.)
Vibration resistance	10 to 150 Hz, 0.20-mm double amplitude, 15-m/s ² acceleration with 10 sweeps of 8 min each in X, Y, and Z directions
Shock resistance	150-m/s ² acceleration for 3 times each in X, Y, and Z directions (18 times in total)
Ambient operating temperature	0 to 40°C (with no icing)
Ambient operating humidity	35% to 85% (with no condensation)
Ambient storage temperature	–15 to 50°C (with no icing)
Ambient storage humidity	35% to 85% (with no condensation)
Degree of protection	IEC60529: IP20
Ground	Ground at a resistance of less than 100 Ω. If grounding is not performed properly, transmission specifications may be adversely affected by the surrounding environment.
Weight	Approx. 185 g

■ ID Tag Holder (for V700-D13P31 Coin-shaped ID Tag)

Item	V700-A80 
Ambient storage temperature	Conforms to the specifications for the V700-D13P31 Coin-shaped ID Tag.
Ambient operating humidity	No restrictions
Material	PPS resin
Weight	Approx. 5 g

System Configuration

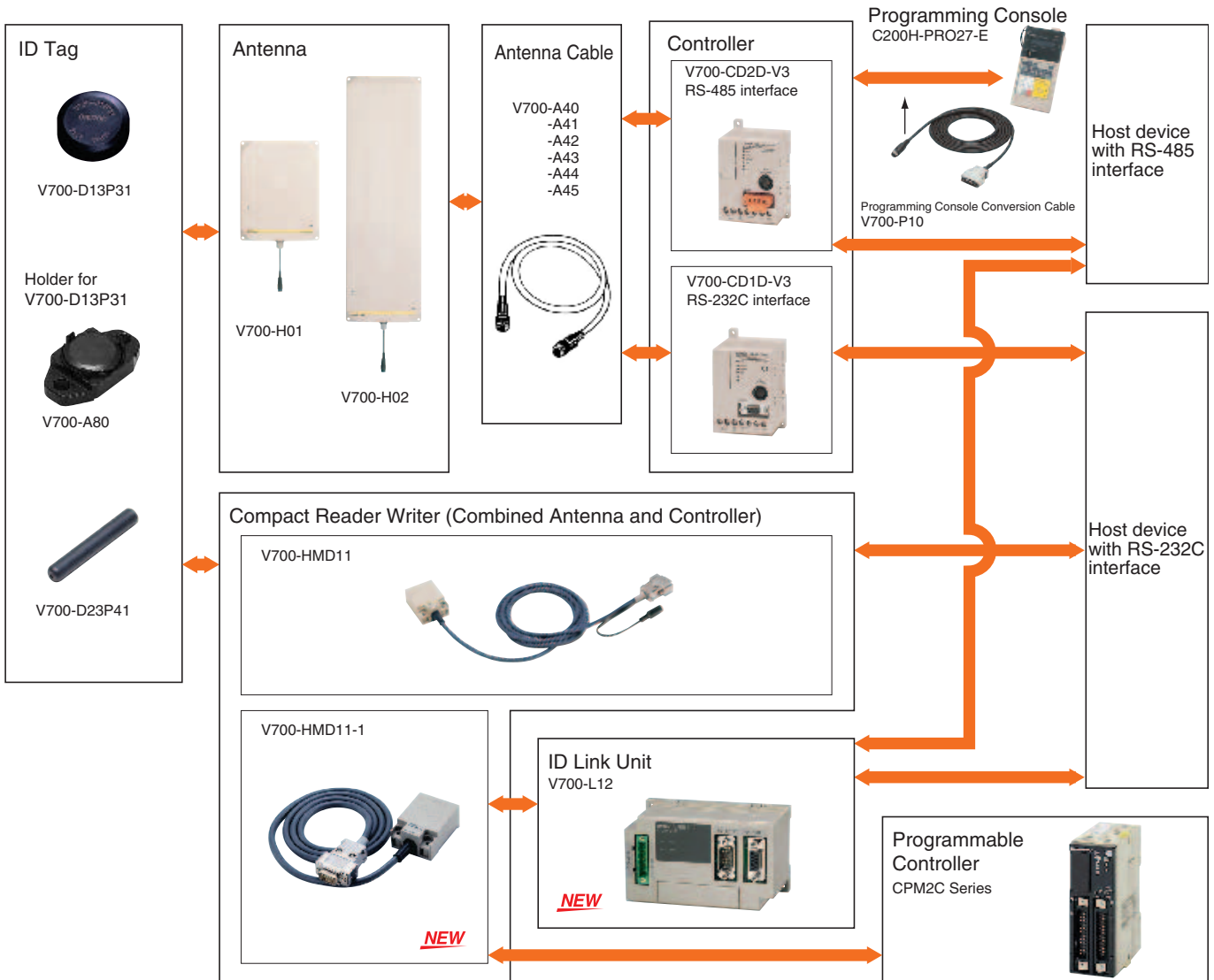

Note: The V700-CD1D-V3, V700-HMD11(-1), and V700-L12 all have different function and command structures.

Characteristic Data (Typical)

Transmission Range

Antenna Operation Range Graphs

V700-H01 & V700-D13P31

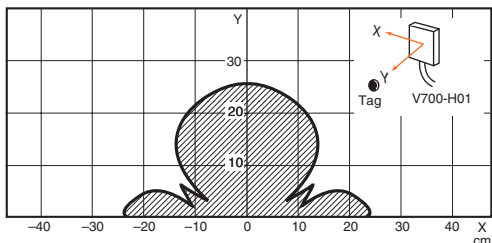

V700-H01 & V700-D23P41

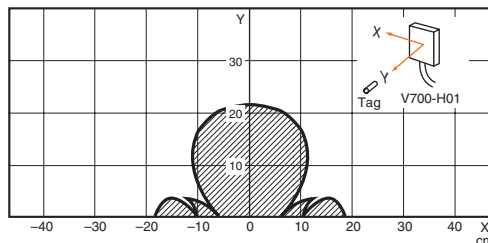

V700-H02 & V700-D13P31

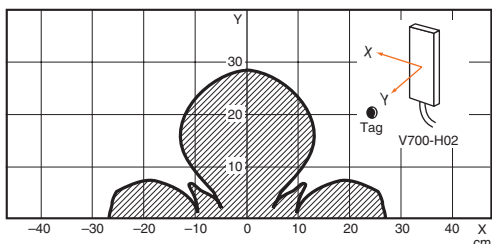

V700-H02 & V700-D23P41

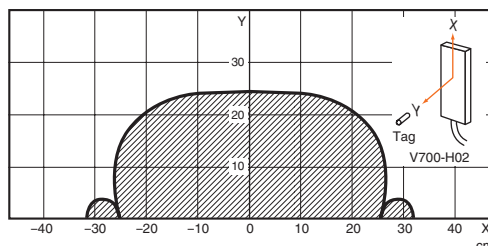
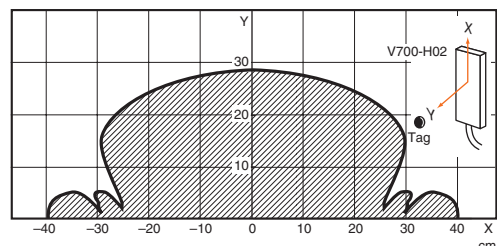
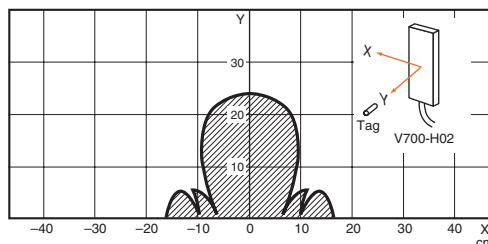

V700-HMD11(-1) & V700-D13P31

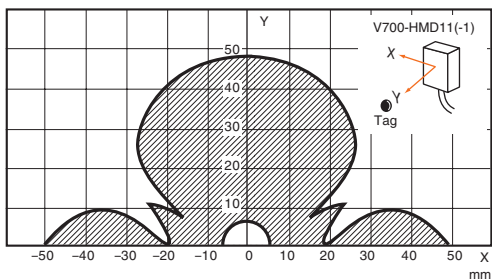

V700-HMD11(-1) & V700-D23P41

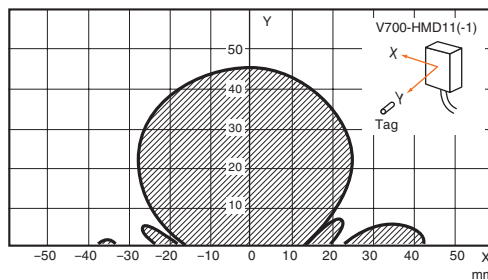

■ Transmission Time

The transmission time is the time required for transmission between the Antenna and ID Tag and does not include time required for host communications.

V700-CD□D-V□

Asynchronous	Write	$T = 46.7 N + 60.7$
	Read	$T = 52.8 N + 113.5$
Read-only synchronization	Read	$T = 46.7 N + 107.4$
Read-write synchronization	Write	$T = 52.8 N + 119.6$
	Read	$T = 52.8 N + 172.4$

V700-HMD11/HMD11-1

Read	$T = 48 N + 66$
Write	$T = 55 N + 120$

Note: T = Transmission time (ms)
N = Number of pages (1 page = 8 bytes)

Precautions on Using the Product near Noise Sources

This product makes transmissions to ID Tags using a frequency of 125 KHz. Transceivers, motors, monitoring devices, and power supplies have parts that generate electromagnetic waves (noise). These waves may interfere with transmissions to ID Tags. Before using this product near these kinds of devices, check that there is no adverse affect on transmissions.

Multiple Access with the V700-□D-V□

The transmission time when using multiple-access commands not only depends on the number of bytes, but also on the number of ID Tags in the transmission range and the combination of the ID Tags' codes. The average values for random ID codes are given below.

(units: ms)

Number of Tags	Reading 8 bytes	Writing 8 bytes
5	579	873
10	1,191	1,547
15	1,857	2,275
20	2,523	3,002
30	3,853	4,455
50	6,344	7,192

Functions

Transmission Functions

	V700-CD1D-V3 V700-CD2D-V3	V700-HMD11 V700-HMD11-1
Single access	Provided	Provided
FIFO	Provided	Provided
Multiple access	Provided	Not provided
Selective access	Provided	Not provided

Note: The V700-CD□D-V□ and V700-HMD11(-1) have different command structures.

	ID Tag	Transmission distance
Using the V700-H01/H02	V700-D13P31	0 to 250 mm
	V700-D23P41	0 to 220 mm
Using the V700-HMD11 or V700-HMD11-1	V700-D13P31	8 to 43 mm
	V700-D23P41	0 to 37 mm

Note: The transmission distance is the same for reading and writing.

Mutual Interference Prevention Functions

If there is less than 15 m between Antennas, all the Antennas must be synchronized to prevent mutual interference. This can be done using either of the two methods described below.

Read-only Synchronization

If all the Antennas only use read commands, this method can be used to reduce the access time.

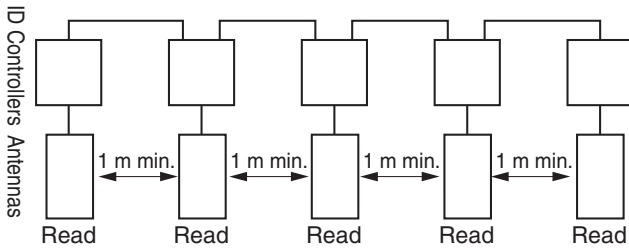

Read/Write Synchronization

This is the synchronization method that is usually used. It enables the synchronization of both read and write commands for several connected Antennas.

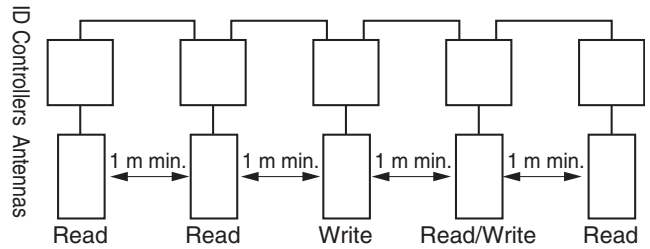

Dimensions

Note: All units are in millimeters unless otherwise indicated.

ID Tag

V700-D13P31
Coin-shaped ID Tag

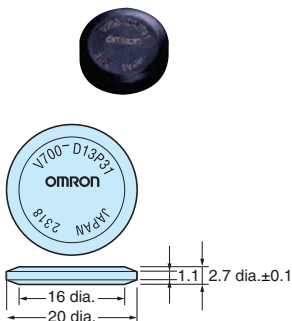

V700-D23P41
Stick-shaped ID Tag

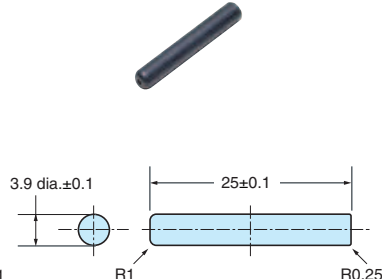

ID Tag Holder (for V700-D13P31)

V700-A80

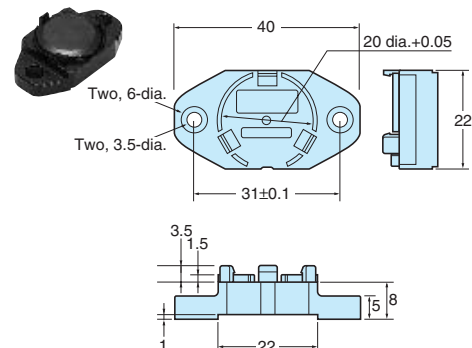

Antenna

V700-H01 Standard Antenna

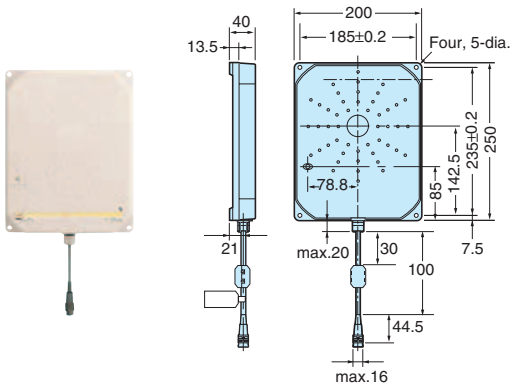

V700-H02 Wide-field Antenna

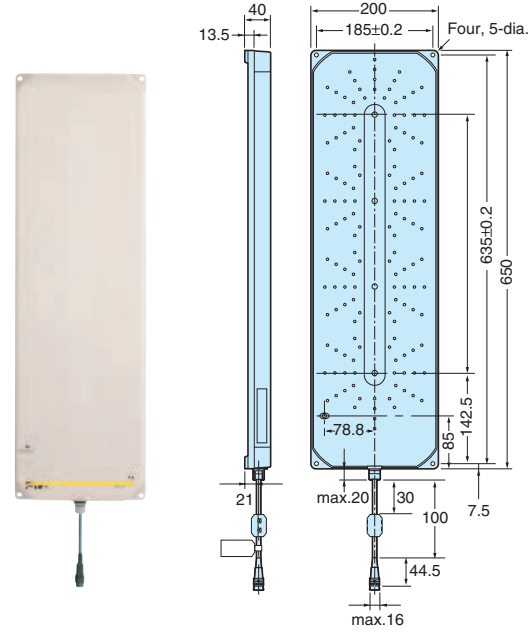

Compact Reader Writer

V700-HMD11

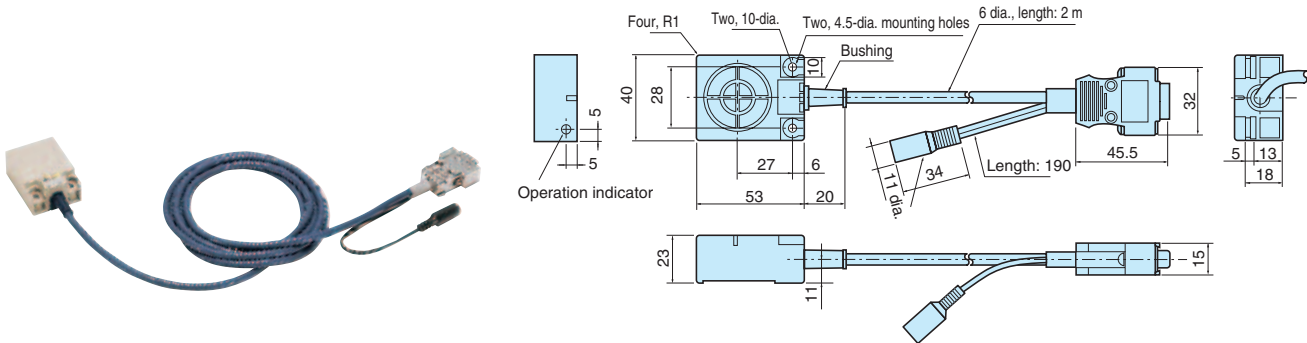

V700-HMD11-1

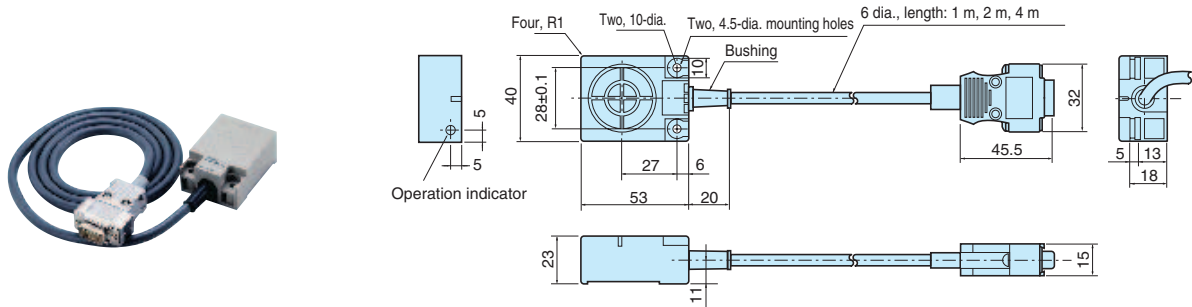

Controller

V700-CD1D-V3

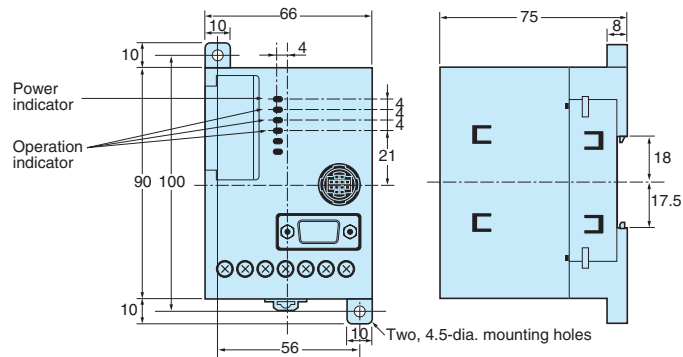

V700-CD2D-V3

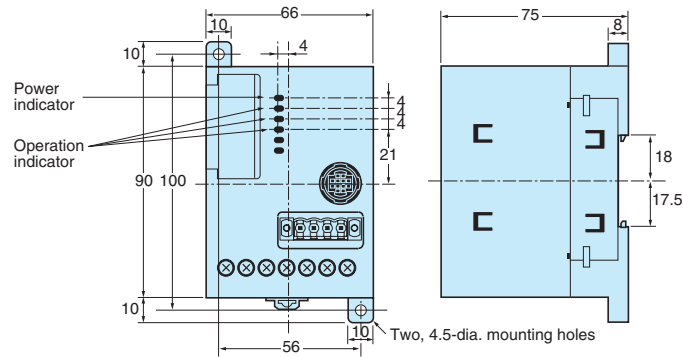

ID Link Unit

V700-L12

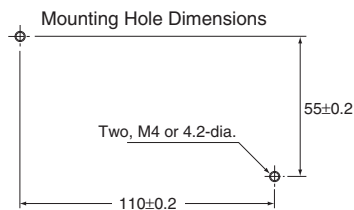
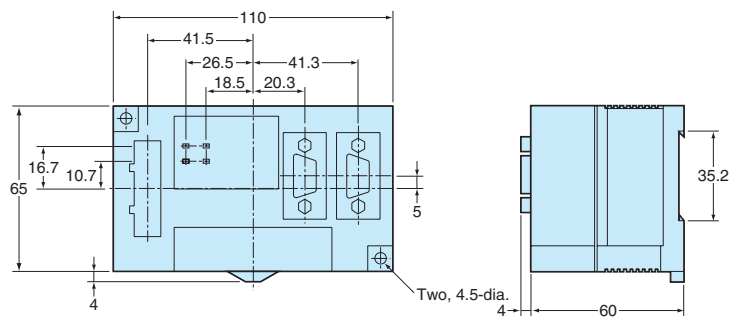

ALL DIMENSIONS SHOWN ARE IN MILLIMETERS.
To convert millimeters into inches, multiply by 0.03937. To convert grams into ounces, multiply by 0.03527.

Electromagnetic Inductive RFID System for Semiconductor Industry V700 for Semiconductor Industry





RFID Systems Conforming to SEMI E15.1 and E99, and SECS I/II

- Antenna dimensions are based on antenna area specifications in SEMI E15.1, ensuring conformance with the standard's transmission range specification.
- Compatible with the SECS interface specified in SEMI E4, E5, and E99.
- Lineup includes ID Link Unit that enables several antennas connected via the load ports to be controlled through just one host channel.
- Uses special Tags that are cleaned in purified water.



Ordering Information

■ List of Models

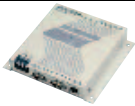

Name	Model		Specifications/Design	
ID Tag	V700-D23P41-1		3.9 dia. × 25 mm	Special stick-shaped Tag for semiconductors 256 bytes (with user area of 240 bytes)
IDRW Head	V700-HMD13A		44.8 × 149.8 × 73 mm	1-m cable RS-232C interface
	V700-HMD11-1		40 × 53 × 23 mm	1-m, 2-m, and 4-m cables RS-232C interface
ID Link Unit	V700-L11		110 × 65 × 64 mm	24 VDC RS-232C interface RS-485 interface
CIDRW Controller	V700-L21		150 × 167 × 28 mm	24 VDC RS-232C interface (Compatible with SECS I/II protocol.)

Specifications

■ ID Tags

Item	V700-D23P41-1 
Memory capacity	240 bytes (user area)
Memory type	EEPROM
Data backup time	10 years after data written
Data writing times	100,000 times per address
Ambient operating temperature (during transmission)	-25 to 70°C (with no icing)
Ambient operating temperature (not during transmission)	-40 to 110°C (with no icing)
Ambient storage temperature	-40 to 110°C (with no icing)
Ambient operating humidity	35% to 95% (with no condensation)
Degree of protection	IEC60529: IP67
Vibration resistance	10 to 2,000 Hz, 0.75-mm single amplitude, 150-m/s ² acceleration with 10 sweeps of 15 min each in X, Y, and Z directions
Shock resistance	500-m/s ² acceleration for 3 times each in X, Y, and Z directions (18 times in total)
Material	Case: PBT resin; Filling: Epoxy resin
Weight	Approx. 1 g
Cleaning	Cleaned with purified water. Capable of withstanding ultrasonic cleaning.

■ IDRW Head

Item	Model	
	V700-HMD13A 	V700-HMD11-1 
Host interface	RS232C (special 1-to-1 protocol)	
Power consumption	5 VDC ±5% (supplied via V700-L11 Link Unit) Oscillating: 400 mA max.	5 VDC ±5% (supplied via V700-L11 Link Unit) Oscillating: 250 mA max.
Insulation resistance	50 MΩ min. (at 500 VDC) between the cable terminals and the case	
Dielectric strength	1,000 VAC (50/60 Hz, 1 minute) between the cable terminals and the case (leakage current: 5 mA max.)	1,000 VAC (50/60 Hz, 1 minute) between the cable terminals and the case (leakage current: 1 mA max.)
Vibration resistance	10 to 150 Hz, 0.2-mm double amplitude, 10-m/s ² acceleration with 10 sweeps of 8 min each in X, Y, and Z directions	10 to 150 Hz, 1.50-mm double amplitude with 4 sweeps of 8 min each in X, Y, and Z directions
Shock resistance	150-m/s ² acceleration for 3 times each in X, Y, and Z directions (18 times in total)	300-m/s ² acceleration for 3 times each in X, Y, and Z directions (18 times in total)
Ambient operating temperature	0 to 40°C (with no icing)	-10 to 55°C (with no icing)
Ambient operating humidity	35% to 85% (with no condensation)	25% to 85% (with no condensation)
Ambient storage temperature	-15 to 50°C (with no icing)	-25 to 65°C (with no icing)
Ambient storage humidity	35% to 85% (with no condensation)	25% to 95% (with no condensation)
Degree of protection	IEC60529: IP30	IEC60529: IP67
Material	Case: Aluminum; Detecting surface: Bakelite; Cable: PVC (oil-resistant); Mounting bracket: SUS304	Case: ABS resin; Filling: Epoxy resin; Cable: PVC (oil-resistant)
Cable length	1 m (Extendable up to a total length of 4 m when using the V700-L11.)	1, 2, 4 m
Weight	Approx. 380 g	Approx. 185 g (1 m)

■ ID Link Unit

Item	V700-L11 
Host interface	RS-232C or RS-485 (Up to 31 Link Units can be connected.)
Number of connectable IDRW Heads	1
Power supply voltage	24 VDC +15%/-15%
Power consumption	10 W max.
Insulation resistance	50 MΩ min. (at 500 VDC) between the power supply terminals and the ground terminal
Dielectric strength	1,000 VAC (50/60 Hz, 1 minute) between the power supply terminals and the ground terminal (leakage current: 5 mA max.)
Vibration resistance	10 to 150 Hz, 0.20-mm double amplitude, 15-m/s ² acceleration with 10 sweeps of 8 min each in X, Y, and Z directions
Shock resistance	150-m/s ² acceleration for 3 times each in X, Y, and Z directions (18 times in total)
Ambient operating temperature	0 to 40°C (with no icing)
Ambient operating humidity	35% to 85% (with no condensation)
Ambient storage temperature	-15 to 50°C (with no icing)
Ambient storage humidity	35% to 85% (with no condensation)
Degree of protection	IEC60529: IP20
Ground	Ground at a resistance of less than 100 Ω. If grounding is not performed properly, transmission specifications may be adversely affected by the surrounding environment.
Weight	Approx. 185 g

■ CIDRW Controller

Item	V700-L21 
Host interface	RS-232C
Power supply voltage	24 VDC, +10%/-15%
Power consumption	150 mW max.
Insulation resistance	50 MΩ min. (at 500 VDC) between the power supply terminals and the ground terminal
Dielectric strength	1,000 VAC (50/60 Hz, 1 minute) between the power supply terminals and the ground terminal (leakage current: 3.5 mA max.)
Vibration resistance	10 to 150 Hz, 0.20-mm double amplitude, 15-m/s ² acceleration with 10 sweeps of 8 min each in X, Y, and Z directions
Shock resistance	150-m/s ² acceleration for 3 times each in X, Y, and Z directions (18 times in total)
Ambient operating temperature	0 to 40°C (with no icing)
Ambient operating humidity	10% to 85% (with no condensation)
Ambient storage temperature	-15 to 65°C (with no icing)
Ambient storage humidity	10% to 95% (with no condensation)
Degree of protection	IEC60529: IP30
Ground	Ground at a resistance of less than 100 Ω.
Weight	Approx. 580 g

Interface Specifications

Classification Model	CIDRW Controller		ID Link Unit			IDRW Head
	V700-L21		V700-L11			V700-HMD11-1 V700-HMD13A
Communications port Item	SECS port	ID port	Host connection port	Multi-connection port	ID connection port	---
Connector	9-pin, D-sub, male, #4-40UNC		9-pin, D-sub, male, #4-40UNC	5-pin special connector (provided with Unit)	9-pin, D-sub, female, M2.6	9-pin, D-sub, male, M2.6
Communications method	Conforms to RS-232			Conforms to RS-485	Conforms to RS-232C	
Synchronization method	Start-stop synchronization method					
Communications control method	SEMI E4, E5 (SECS I/II)	Special OMRON 1-to-N protocol			Special OMRON 1-to-1 protocol	
Error detection method	SECS I (Check Sum)	FCS (Frame Check Sequence)			Even parity	
Baud rate (default value underlined)	1,200/2,400/4,800/ <u>9,600</u> /19,200/38,400/57,600/115,200 bps	<u>9,600</u> /19,200/38,400 bps	4,800/ <u>9,600</u> /19,200/38,400 bps		<u>9,600</u> bps (fixed)	
Cable length	15 m max.			50 m max.	---	4 m max.

System Configuration

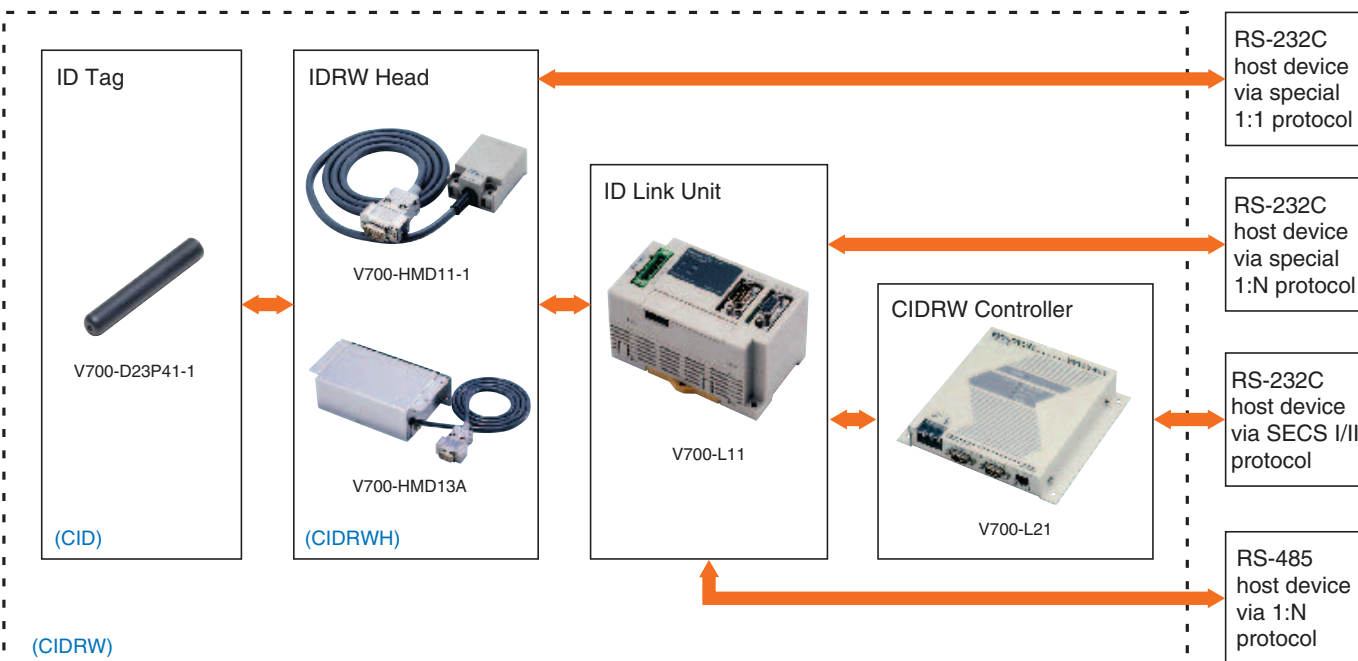

Note: 1. The terms in parentheses are the ones used in the SEMI standards.
 2. The command structure depends on the system configuration.

Characteristic Data (Typical)

■ Transmission Range

Note: All units are in millimeters unless otherwise indicated.

Antenna Operation Range Graphs

V700-HMD11-1 & V700-D23P41-1

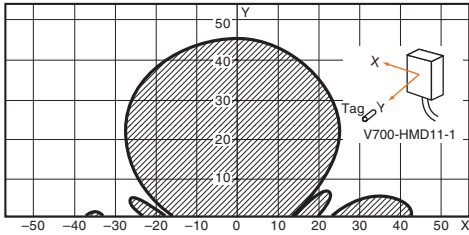

V700-HMD13A & V700-D23P41-1

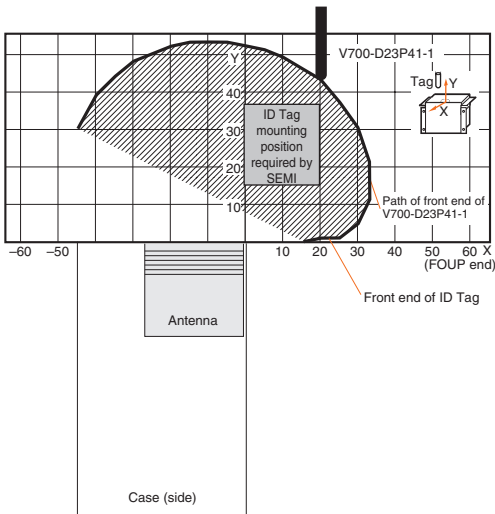

Connections

■ System Connection Example 1

Systems with the CIDRW Controller (V700-L21)

The Carrier ID Reader Writer (CIDRW) System is an RFID system that conforms to SEMI standards. The V700-L21 CIDRW Controller, the V700-L11 ID Link Unit, the V700-HMD13A or V700-HMD11-1 IDRW Head, and V700-D23P41-1 ID Tags can be used to create a Carrier ID Reader Writer (CIDRW) System that conforms to the following standards:

- SEMI E99 THE CARRIER ID READER WRITER FUNCTIONAL STANDARD
- SEMI E5 EQUIPMENT COMMUNICATION STANDARD 2 MESSAGE CONTENT (SECS II)
- SEMI E4 EQUIPMENT COMMUNICATION STANDARD 1 MESSAGE TRANSFER (SECS I)

Note: SEMI: Semiconductor Equipment and Materials International
SECS: SEMI Equipment Communications Standard

CIDRW System

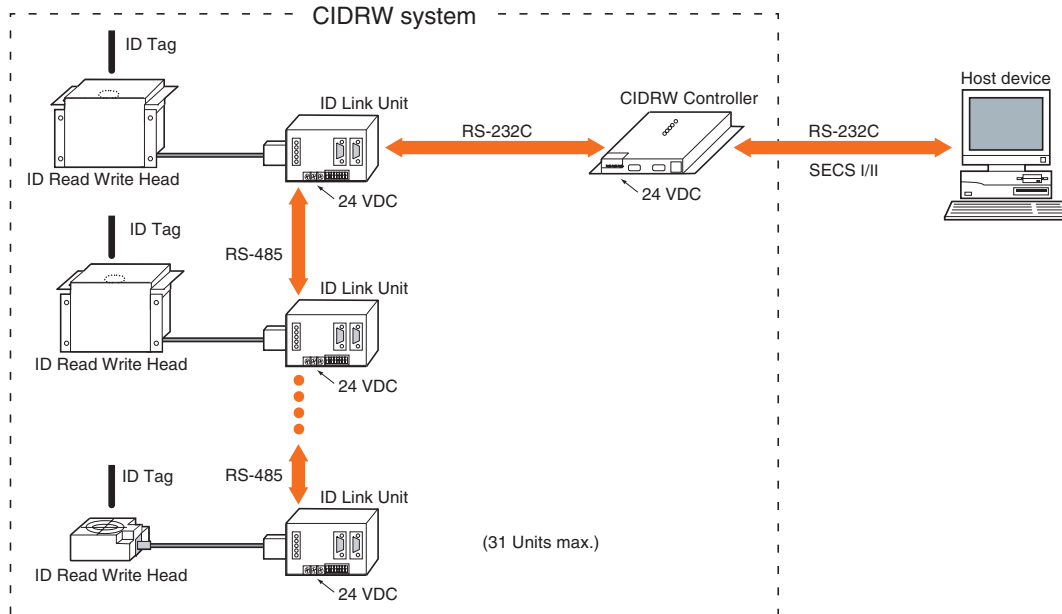

For more details on the standards, refer to the standards issued by SEMI.

■ System Connection Example 2

Systems without the CIDRW Controller (V700-L21)

The IDRW Head and the ID Link Unit can be used in combination to handle a variety of installation configurations (i.e., connection configurations and power supply voltages).

Host Device Interface: RS/232C/RS-485

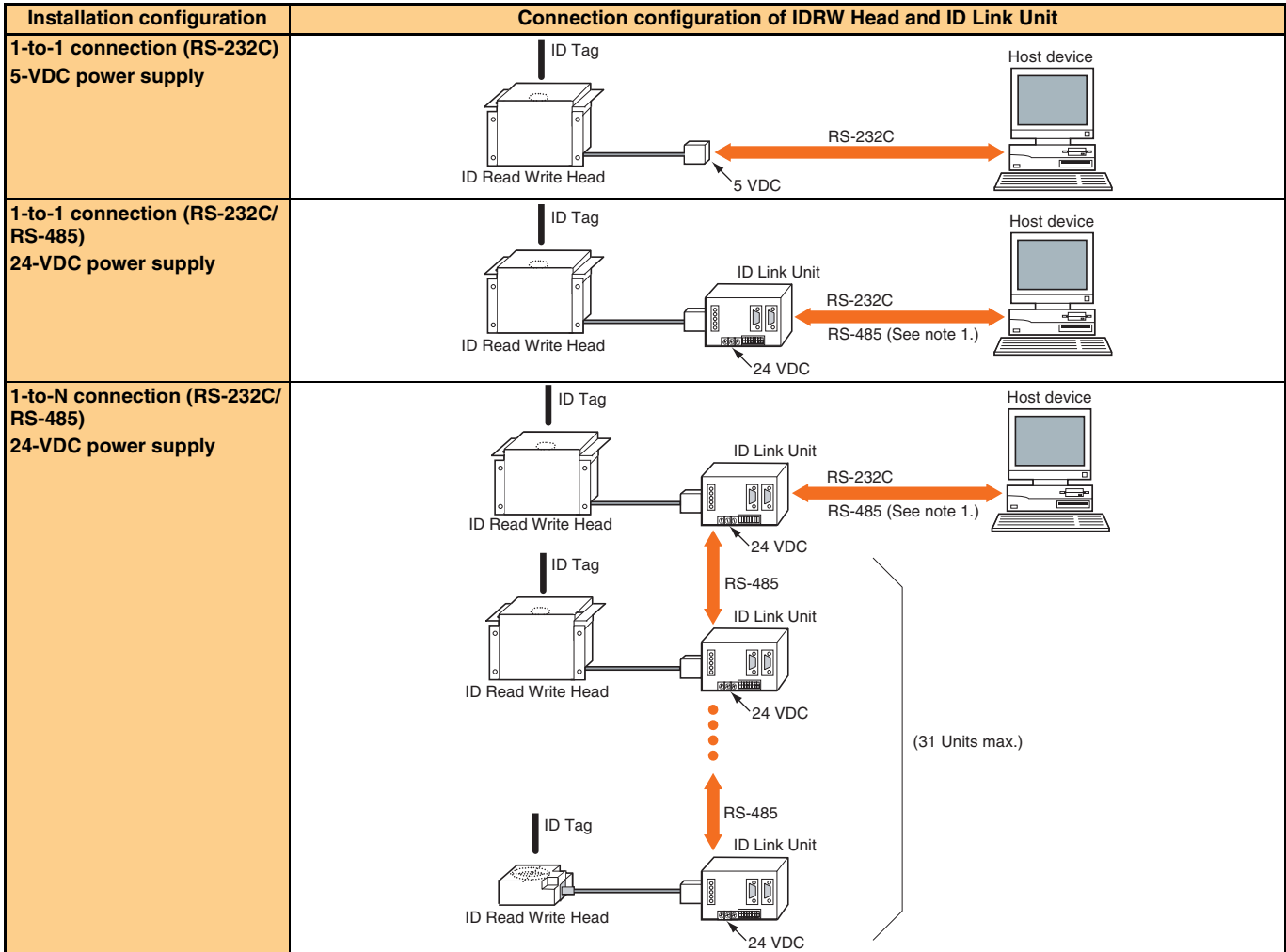

Note: Connection is also possible to host devices with RS-485 interfaces by changing the ID Link Unit connection.

Dimensions

Note: All units are in millimeters unless otherwise indicated.

ID Tag

V700-D23P41-1

Stick-shaped ID Tag

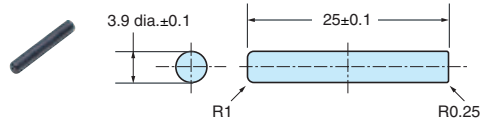

IDRW Head

V700-HMD11-1

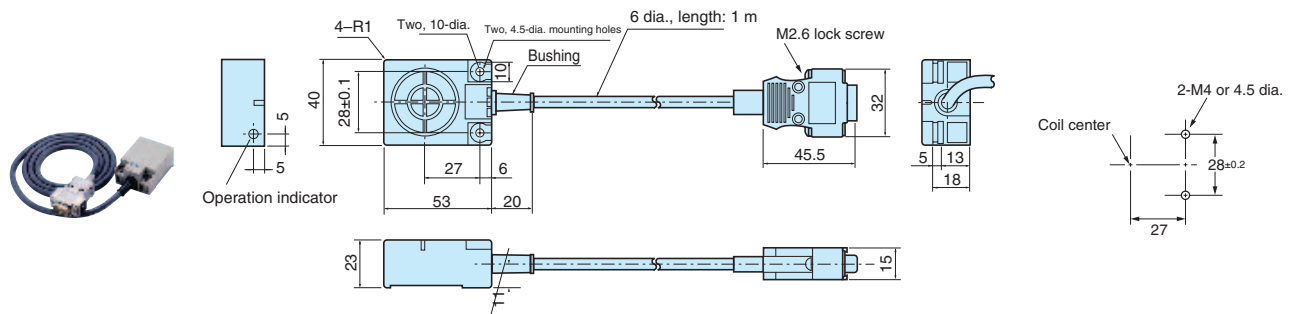

V700-HMD13A

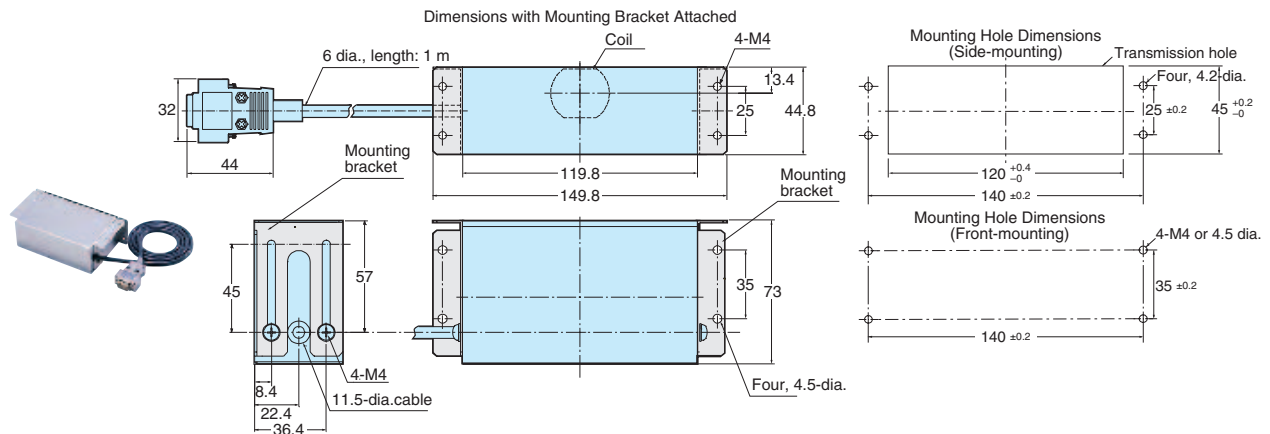

ID Link Unit

V700-L11

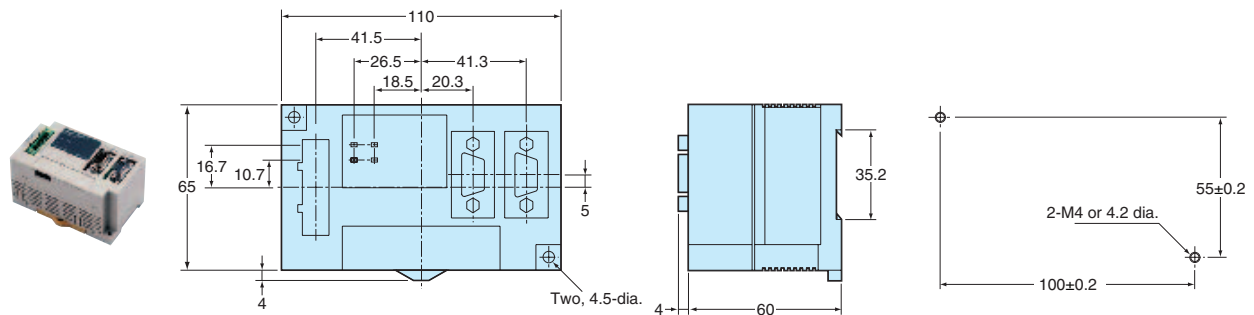

CIDRW Controller

V700-L21

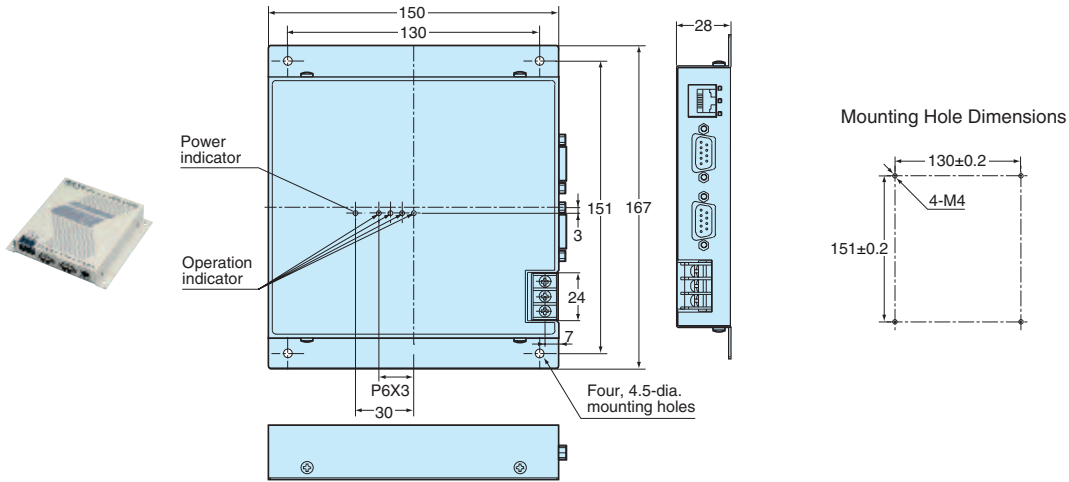

ALL DIMENSIONS SHOWN ARE IN MILLIMETERS.
 To convert millimeters into inches, multiply by 0.03937. To convert grams into ounces, multiply by 0.03527.

Electromagnetic Inductive RFID System

Tag Inlets V720□-D□□P□□-R□K



V720-D52P01
V720S-D13P01



V720-D52P02
V720S-D13P02



V720-D52P03



V720-D52P04

Product Description

Smart Labels are Radio Frequency Identification (RFID) tags from OMRON that conform to the international standard ISO 15693. Smart Labels are super thin and highly flexible, making them the most cost-effective of all ID tag products to date, and well suited to a wide range of applications.

- Airport baggage handling systems
- Museum collection management
- Supply chain management systems
- Designer brand product control
- Library book and document management
- Facility and equipment maintenance

Combined with OMRON's ID Controllers and Read Write Antennas, the Tag Inlets are provided for system integrators to use in building RFID systems, converters considering the marketing of ID tags, and bar code equipment manufacturers who want to add RFID labels to their existing line of bar code labels.

Features



- Conform to ISO 15693, the international standard for contactless IC cards.
- Apply I-CODE chip technology from Philips Semiconductors. Both I-CODE1 and I-CODE SLI types are available

Benefits

- Thin and flexible.
- Withstand bending.
- Easy secondary processing onto business forms (roll-to-roll).

General Specifications

Item	V720-D52P□□	V720S-D13P□□ (Available soon)
Applicable chip	I-CODE1	I-CODE SLI
Memory capacity	44 bytes (user area)	112 bytes (user area)
Memory type	64-byte EEPROM	128-byte EEPROM
Communications frequency	13.56 MHz	
Data retention time	10 years after data is written (at 55°C max.)	
Number of overwrites	100,000 times for each address	
Ambient temperature in operation	-10 to 55°C (with no icing)	
Ambient temperature in storage	-30 to 70°C (with no icing)	
Heat resistance	No communications error after leaving the product for 250 hours at 85°C	
Cold resistance	No communications error after leaving the product for 250 hours at -30°C	
Thermal shock resistance	No communications error after 100 cycles between 85°C and -30°C, holding 30 minutes at each temperature	
Vibration resistance	Destruction: 10 Hz to 2 kHz, 1.5-mm double amplitude, 150-m/s ² acceleration with 10 sweeps of 11 minutes each in X, Y, and Z directions	
Shock resistance	Destruction: 500 m/s ² 3 times each in X, Y, and Z directions	
Moisture resistance	No communications error after leaving the product for 250 hours at 85°C and 85% humidity	

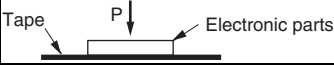
Item	V720-D52P01 V720S-D13P01	V720-D52P02 V720S-D13P02	V720-D52P03	V720-D52P04
Tape tension (P)	< 10 N			
Bending diameter (D)	> 20 mm dia.			
Static pressure (P)	< 10 MPa (10 N/mm ²)			

Dimensions

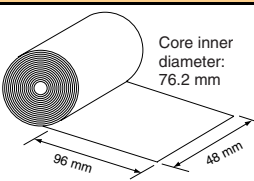
Item	V720-D52P01 V720S-D13P01	V720-D52P02 V720S-D13P02	V720-D52P03	V720-D52P04	Dimensions of Tag Inlets
Width	48 ±0.3 mm				
Length per piece	96 ±0.3 mm ^(*)	48 ±0.3 mm	32 ±0.3 mm	32 ±0.3 mm	
Thickness at electronic parts	270+/-5 μm				
Overall thickness of copper antenna coil	50 +10 μm/-0 μm				
Size of antenna coil	46 × 75 mm	46 × 43 mm	Diameter 21	16.5 × 22 mm	

Tag Inlet Roll Delivery Form

Item	V720-D52P01 V720S-D13P01	V720-D52P02 V720S-D13P02	V720-D52P03	V720-D52P04
Appearance	Single-row roll form			
Number of functional units on 1 roll	1,000 pcs. (V720□-D□□P-R1K) and 5,000 pcs. (V720□-D□□P-R5K)			
Sheet length (1,000 pcs./5,000 pcs.)	Approx. 100/500 m	Approx. 50/250 m	Approx. 33/167 m	Approx. 33/167 m
Roll core	Paper core, inner diameter of 3 inches, outer diameter of 5 inches			
Outer diameter of roll (1,000 pcs./5,000 pcs.)	160/260 mm	Consult your OMRON dealer.		
Weight (1,000 pcs./5,000 pcs.)	0.7/2.4 kg	Consult your OMRON dealer.		
Identification of roll	Label on inner core with roll No., date of production, and type			

Communications Distance ^(*) (Measured at 25°C)

Read Write Antennas	V720-D52P01 V720S-D13P01	V720-D52P02 V720S-D13P02	V720-D52P03	V720-D52P04
V720□-H01	0 to 280 mm	0 to 220 mm	0 to 80 mm	0 to 80 mm
V720S-HMC73□	0 to 45 mm	0 to 45 mm	0 to 18 mm ^(*)	0 to 18 mm ^(*)

*1: The communications distance may vary depending on surrounding noise and equipment.

*2: The communications distance for writing is 5 to 18 mm.

ALL DIMENSIONS SHOWN ARE IN MILLIMETERS.
To convert millimeters into inches, multiply by 0.03937. To convert grams into ounces, multiply by 0.03527.

ID Tags V720□-D□□P□□



V720-D52P40
V720S-D13P40



V720-D52P30
V720S-D13P30

Product Description

OMRON's V720-series ID Tags conform to the international standard ISO 15693 (communications frequency). Two types are available: the V720□-D□□P40, which is sealed in PET resin, and the V720□-D□□P30, which is processed pouch-style using PET sheets. The ID Tag is widely used in RFID system testing and evaluation. A variety of ID Tag samples are also available. Contact your OMRON representative for details.

Features

- Conform to ISO 15693, the international standard for contactless IC cards.
- Apply I-CODE chip technology from Philips Semiconductors. Both I-CODE1 and I-CODE SLI types are available.

General Specifications

Item	V720-D52P□□	V720S-D13P□□ (Available soon)
Applicable chip	I-CODE1	I-CODE SLI
Memory capacity	44 bytes (user area)	112 bytes (user area)
Memory type	64-byte EEPROM	128-byte EEPROM
Communications frequency	13.56 MHz	
Data retention time	10 years after data is written (at 55°C max.)	
Number of overwrites	100,000 times for each address	
Ambient temperature in operation	-10 to 70°C (with no icing)	
Ambient temperature in storage	-30 to 70°C (with no icing)	
Degree of protection	IEC 60529, IP67	
Material	PET resin	
Shock resistance	Destruction: 500 m/s ² 3 times each in X, Y, and Z directions for 18 repetitions	
Vibration resistance	Destruction: 10 Hz to 500 Hz, 1.5-mm double amplitude, 100-m/s ² acceleration with 10 sweeps of 11 minutes each in X, Y, and Z directions	
Weight	V720□-D□□P40: Approx. 4 g, V720□-D□□P30: Approx. 2 g,	

Dimensions

■ V720□-D□□P40

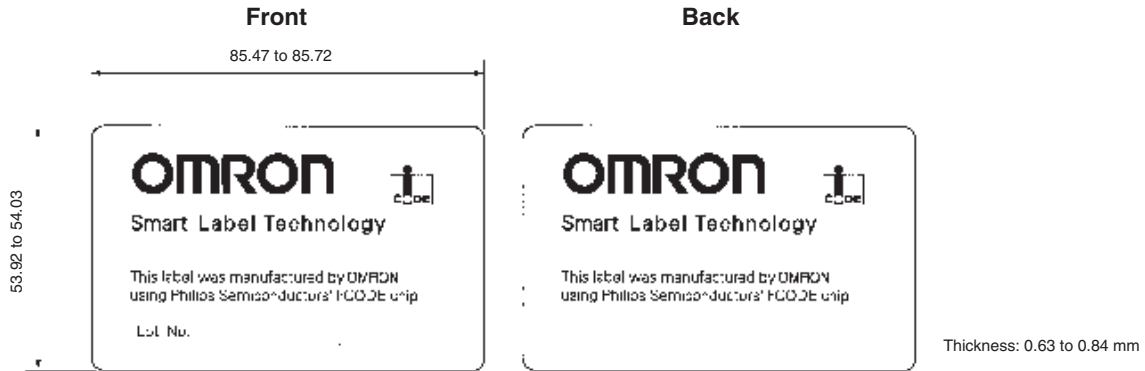

■ V720□-D□□P30

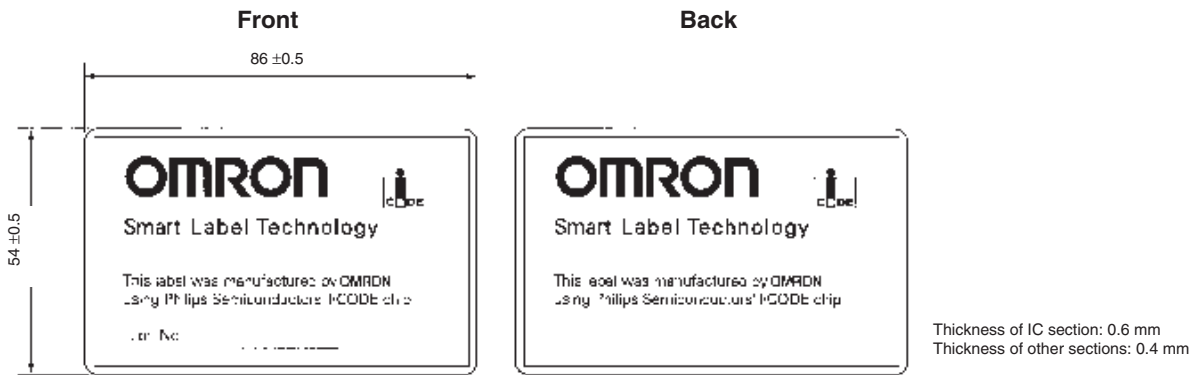

■ Communications Distance (*1) (Measured at 25°C)

Model	V720-D52P30 V720-D52P40	V720S-D13P30 (Available soon) V720S-D13P40 (Available soon)
V720□-H01	0 to 250 mm	0 to 250 mm
V720S-HMC73□	0 to 30 mm	0 to 30 mm

*1: The communications distance may vary depending on surrounding noise and equipment. Be sure to check the effects prior to use.

ALL DIMENSIONS SHOWN ARE IN MILLIMETERS.

To convert millimeters into inches, multiply by 0.03937. To convert grams into ounces, multiply by 0.03527.

Reader/Writer V720S-BC5D4



Product Description

OMRON's Reader/Writer enables the industry's top level of communications distance for OMRON Smart Cards, with connection to a V720-HS03 Antenna or V720-HS71 Gate Antenna.

Features

- Two Antenna terminals available for use in a variety of applications.
- Includes RS-232C and RS-485 interfaces.
- Allows multi-drop connection of up to 32 Antennas
- Both I-CODE1 and I-CODE SLI types are available.

Benefits

- Durable construction conforms to IP65.
- Inherits the user-friendly host command structure of the previous OMRON series.

General Specifications

Item	Specifications
Communications frequency	13.56 MHz
Ambient temperature in operation	-10 to 50°C (with no icing)
Degree of protection	IEC 60592, IP65
Power supply voltage	24 VDC ±10%
Dimensions	247 (W) × 64 (H) × 128 (D) mm
Antenna output impedance	50 Ω
I/O interface	Input: 4 signals (IN1, IN2, IN3 RESET), Output: 4 signals (OUT1, OUT2, OUT3, OUT4)
Host interface	COM1 (RS-232C/RS-485), COM2 (RS-232C) 9,600 to 115,200 bps
Applicable standards	R & TTE, FCC Part 15

Dimensions

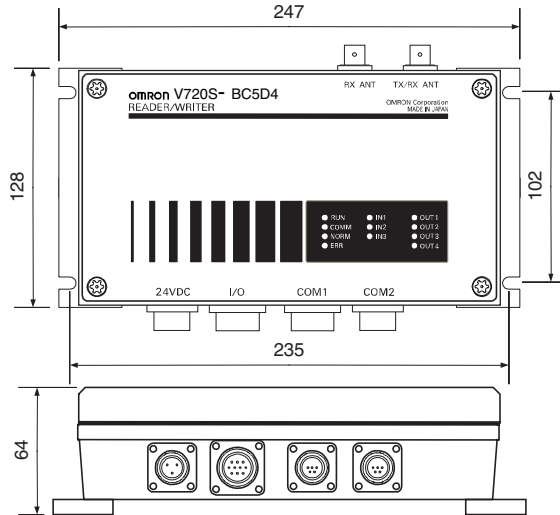

Communications Time (Reference Value)

The communications time is the time taken for communications to take place between the Read Write Antenna and the ID Tag, not including the host communications time.

Standard Mode

Calculation Methods(msec)

	Communications time
High-speed read	$T = 1.3 N + 43.4$
Normal read	$T = 1.3 N + 91.6$
Write	$T = 54.2 N + 90.0$

Fast Mode

Calculation Methods(msec)

	Communications time
High-speed read	$T = 1.3 N + 6.2$
Normal read	$T = 1.3 N + 12.7$
Write	$T = 13 N + 13.5$

System Configuration

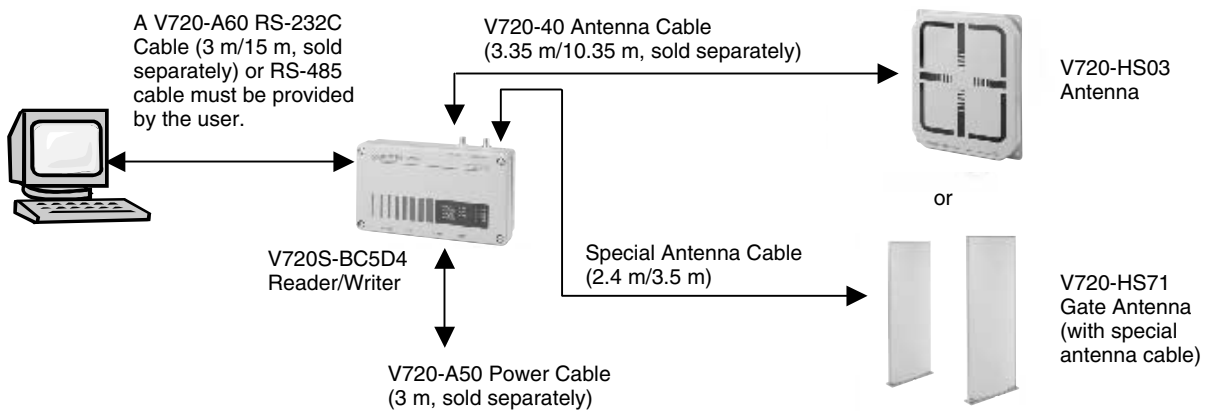

ALL DIMENSIONS SHOWN ARE IN MILLIMETERS.
 To convert millimeters into inches, multiply by 0.03937. To convert grams into ounces, multiply by 0.03527.

Antenna / Antenna Cables

V720-HS03 / V720-A40 □.□ m



V720-HS03

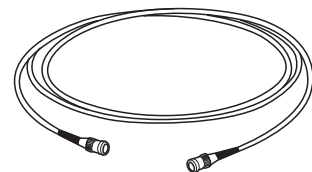

V720-A40 3.35 m

Product Description

This OMRON Antenna connects to a Reader/Writer (V720S-BC5D4) and performs communications with OMRON Smart Tags over one of the longest communications distances in the industry. In addition to the Antenna, a special Antenna Cable (V720-A40□.□m) is also available.

Features

- The communications distance and communications range are respectively 1.6 and 2.6 times those of OMRON's standard Antenna (V720S-H01).

General Specifications

■ Antenna

Item	Specifications
Communications frequency	13.56 MHz
Input impedance	50 Ω
Ambient temperature in operation	-10 to 55°C (with no icing)
Ambient humidity in operation	35% to 85% (with no condensation)
Dimensions	334 (W) × 46 (H) × 407 (D) mm
Degree of protection	IEC60529, IP65
Weight	Approx. 2.5 kg

■ Antenna Cable

Item	Specifications	
Cable length	3.35 m (V720-A40 3.35 m)	10.35 m (V720-A40 10.35 m)

Dimensions

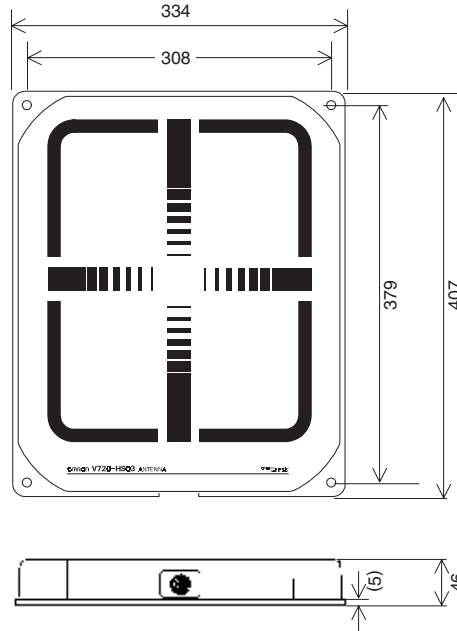
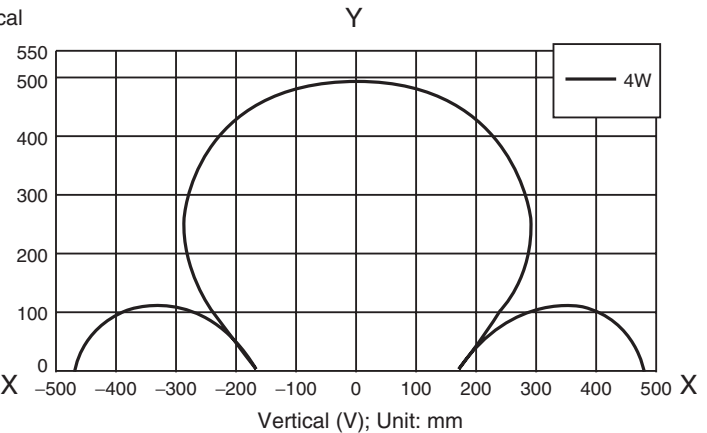
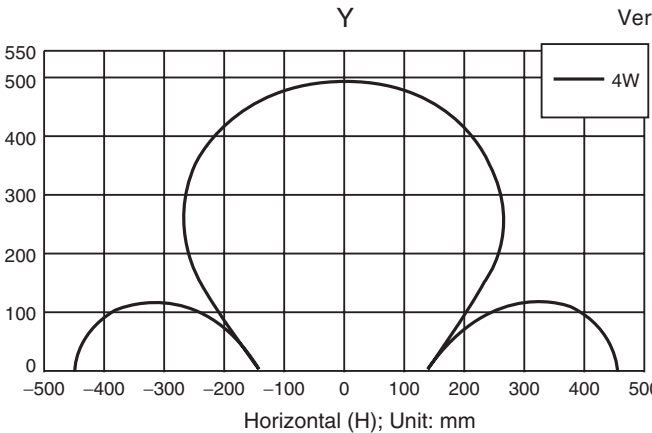
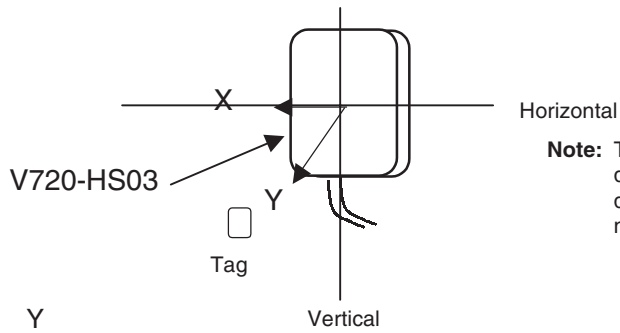

Diagram of Communications Range (Reference Values)

■ Tags: V720-D52P30



ALL DIMENSIONS SHOWN ARE IN MILLIMETERS.
 To convert millimeters into inches, multiply by 0.03937. To convert grams into ounces, multiply by 0.03527.

Gate Antennas

V720-HS71



V720S-HS71

Product Description

OMRON's Gate Antennas can be connected to a host device via the V720S-BC5D4 Reader/Writer. Using OMRON Smart Tags, the communications distance between the Antennas can be up to one meter.

Features

Gate Antennas are applicable to a variety of gate applications, including those in distribution systems, rental equipment management systems, and room entry/exit systems.

- In a single-lane configuration, the communications distance can cover a gate width of up to one meter.
- Compatible with three Tag directions: Gate width one meter (lane width approx. 90 cm)
- Support the EAS (Electronic Article Surveillance) function, and simultaneously reads multiple Tags.
- Support either two antennas (single-lane configuration: V720-HS71) or one antenna (single configuration: V720-HS71S).

Benefits

Connection to the Reader/Writer makes it possible to configure a high-performance RFID system with features such as a standalone EAS mode that requires no host computer, 1:1 communications between Tag and Antenna, or a 1:N multi-access mode.

General Specifications

Item	Specifications
Communications frequency	13.56 MHz
Ambient temperature in operation	-10 to 50°C (with no icing)
Degree of protection	IEC 60529, IP40
Weight	Approx. 16.5 kg
Dimensions	622 (W) × 1,597 (H) × 120 (D) mm
Color	Side panel: Ivory white
Cabinet	Side frame: Aluminum, Side panel: PC/ABS resin
Cable length	Between Antenna and Controller: 3.5 m, Between Antennas: 2.4 m
Mounting	Fixed with two M12 anchor bolts.

Dimensions

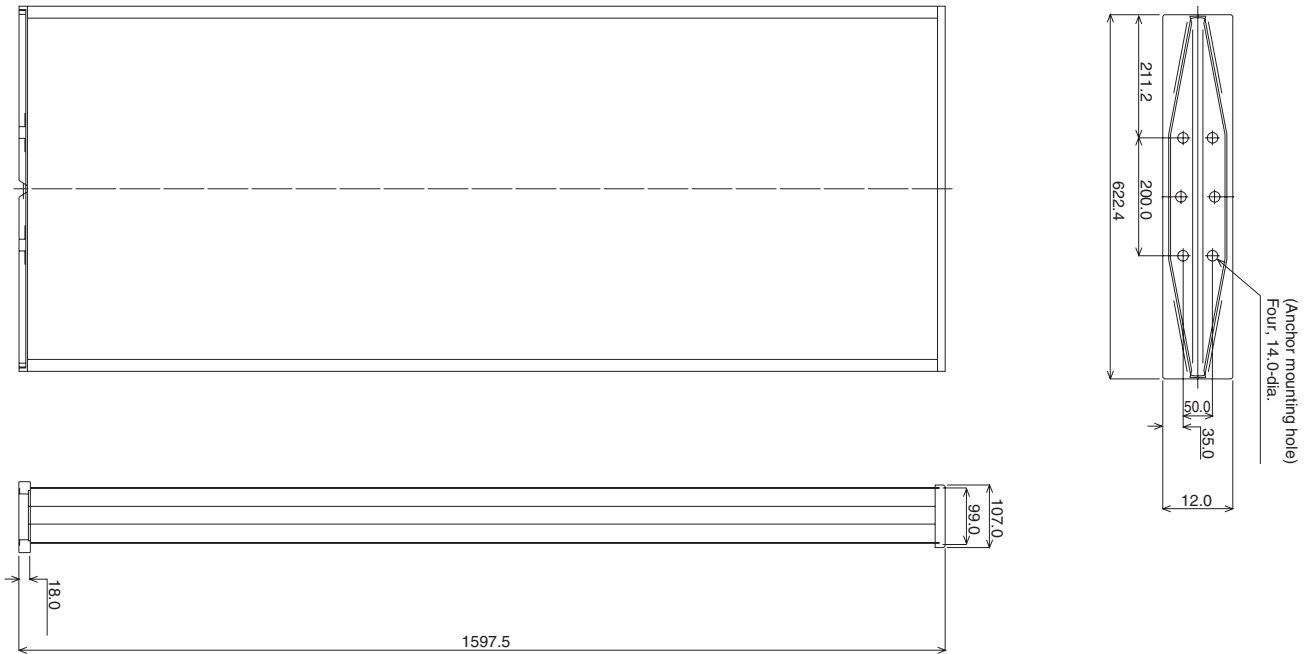

Installation Dimensions

■ Mounting Hole Positions and Dimensions

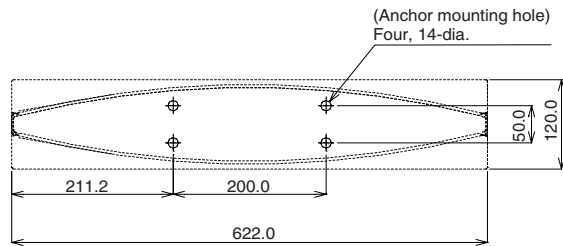

■ Positions for 2-Antenna Configuration

When installing a 2-Antenna configuration, install so that the centers of the Antennas are one meter apart (resulting in a 0.88-m lane).

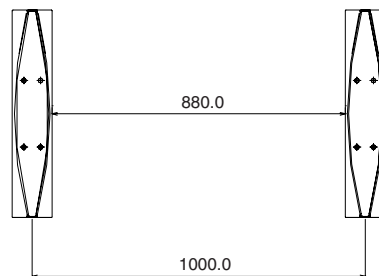

ALL DIMENSIONS SHOWN ARE IN MILLIMETERS.

To convert millimeters into inches, multiply by 0.03937. To convert grams into ounces, multiply by 0.03527.

Electromagnetic Inductive RFID System

ID Controllers V720S-CD□D



V720S-CD1D



V720S-CD2D

Product Description

OMRON's ID Controllers suit a wide range of applications by offering a variety of access functions, and general-purpose host interfaces. Simply connect the ID Controller to a Read Write Antenna (V720S-H01) to configure an RFID system. The V720S-CD□D ID Controllers conform completely to the international standard ISO 15693.

Features

- Equipped with single access (1 to 1), multiple access (1 to n), selective access, and FIFO queue functions.
- General-purpose RS-232C or RS-485 command/response interface for host.
- Conform to EC Directives and FCC.

Benefits

- Small and easy to install.
- General-purpose interfaces for easy connection to a host system.

General Specifications

	V720S-CD1D	V720S-CD2D
Host interface	RS-232C	RS-485 (Maximum number of connectable Controllers: 10)
Number of connectable Antennas	1	
Supply voltage	24 VDC ^{+10%} / _{-15%}	
Power consumption	20 W max. including the power consumption of the Read Write Antenna	
Insulation resistance	20 MΩ min. (at 100 VDC) between the ground and both power supply terminals, both power supply terminals and both I/O terminals, both power supply terminals and cables, both I/O terminals and ground, both I/O terminals and case, and ground terminal and case	
Dielectric strength	Leakage current of 1 mA max. at 500 VAC (50/60 Hz) for 1 minute in any of the above combinations.	
Vibration resistance	No abnormality after applying variable vibration of 10 to 150 Hz and 0.2-mm double amplitude in X, Y, and Z directions for 8 minutes each for 10 repetitions.	
Shock resistance	No abnormality after applying 150 m/s ² in X, Y, and Z directions 3 times each for 18 repetitions.	
Ambient temperature in operation	-10 to 55°C (with no icing)	
Ambient humidity in operation	35% to 85% (with no condensation)	
Ambient temperature in storage	-25 to 65°C (with no icing)	
Ground	Ground at a resistance of less than 100 Ω. (If not grounded, communications performance may be affected by the surrounding environment.)	
Degree of protection	Panel mounted	
Material	PC/ASA resin	
Weight	Pyrex. 290 g	
Applicable standards	EN55022, EN55024	

Dimensions

■ ID Controller V720S-CD□D

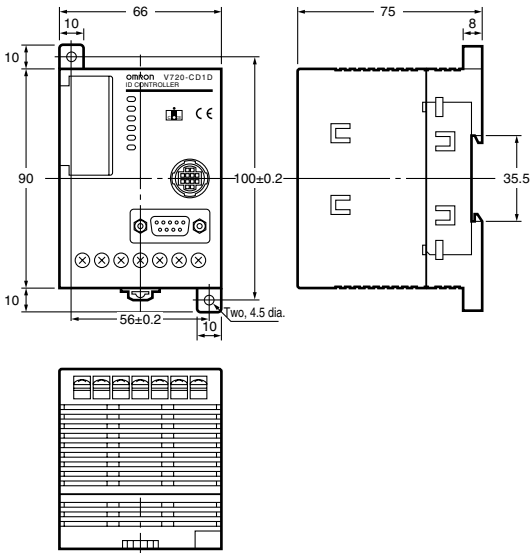

Communications Time (Reference Values)

The communications time is the time taken for communications to take place between the Read Write Antenna and the ID Tag, not including the host communications time.

■ Standard Mode

Calculation Methods(msec)

	Communications time
High-speed read	$T = 1.3 N + 43.4$
Normal read	$T = 1.3 N + 91.6$
Write	$T = 54.2 N + 90.0$

■ Fast Mode

Calculation Methods(msec)

	Communications time
High-speed read	$T = 1.3 N + 6.2$
Normal read	$T = 1.3 N + 12.7$
Write	$T = 13 N + 13.5$

■ Communications Time for Multi-access

The communications time when using multiple commands depends on various conditions. It depends not only on the number of bytes to be processed but also on the number of Tags there are within the communications range. The relationship between these factors and the average communications time is shown in the table below.(msec)

Number of Tags	Tag numeric constant	Reading 2 pages (8 bytes)		Writing 2 pages (8 bytes)	
		Standard mode	Fast mode	Standard mode	Fast mode
2	2	560	144	715	190
4	3	917	301	1,139	378
8	4	1,659	644	2,016	784
16	5	3,239	1,391	3,867	1,656

Functions for Accessing Multiple Tags

● **FIFO (First In First Out) Queue Function**

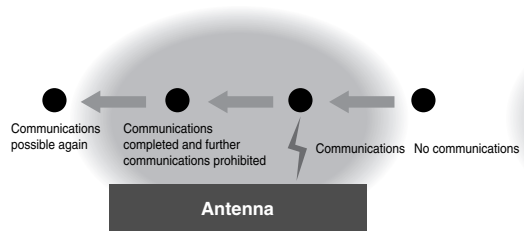

Using this function, communications are performed in order starting with the first Tag to enter the communications range.

● **Multiple Access Function**

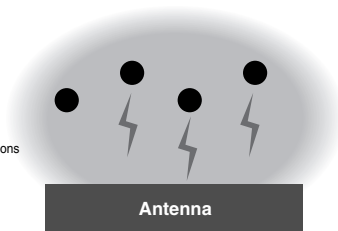

Using this function, communications are performed with every Tag inside the communications range. The Tags are accessed in random order.

● **Selective Access Function**

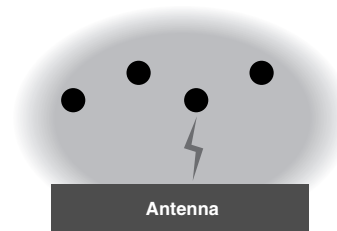

Using this function, it is possible to specify which Tags in the communications range are accessed.

ALL DIMENSIONS SHOWN ARE IN MILLIMETERS.
 To convert millimeters into inches, multiply by 0.03937. To convert grams into ounces, multiply by 0.03527.

Electromagnetic Inductive RFID System Read Write Antennas V720S-H01 Antenna Cables V700-A□



V720S-H01

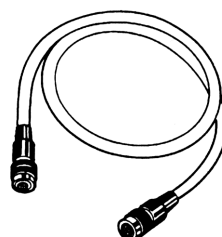

V700-A40
V700-A41
V700-A42
V700-A43
V700-A44
V700-A45

Product Description

OMRON's medium-range Read Write Antennas have a maximum communications distance of 25 cm with OMRON smart labels. Connection of the Read Write Antenna with the ID Controller (V720S-CD1D or V720S-CD2D) via the V700-A□ Antenna Cable provides a complete RFID system.

Features

- Conform to the international standard ISO 15693 for contactless IC cards.
- Six different cable lengths available.
- Provide a communications distance of 25 cm.
- Conform to EC Directives and FCC.
- Both I-CODE1 and I-CODE SLI types are available

Benefits

- Easy installation
- High reading accuracy even in dirty or dusty environments.

General Specifications

Item	Specifications
Communications frequency	13.56 MHz
Ambient temperature in operation	-20 to 55°C (with no icing)
Ambient temperature in storage	-35 to 65°C (with no icing)
Ambient humidity in operation	35% to 85% (with no condensation)
Insulation resistance	20 MΩ min. (at 100 VDC) between rear plate and case
Dielectric strength	Leakage current of 1 mA max. at 1,000 VAC (50/60 Hz) for 1 minute between rear plate and case.
Degree of protection	IED60529 IP40 (except connector)
Vibration resistance	No abnormality after applying variable vibration of 10 to 150 Hz and 0.7-mm double amplitude in X, Y, and Z directions for 8 minutes each for 10 repetitions.
Shock resistance	No abnormality after applying 150 m/s ² in X, Y, and Z directions 3 times each for 18 repetitions.
Cable length	0.1 m (use and extension cable to connect to the ID Controller up to 30 m)
LED indicators	Power supply: Green, Communications: Orange
Weight	Approx. 750 g
Applicable standards	EN300 330, ETS 300 683, EN 60065, FCC Part 15 Subpart C

■ V700-A4 □ Antenna Cables

	A40	A41	A42	A43	A44	A45
Cable length	2 m	3 m	5 m	10 m	20 m	30 m

The connectors do not have waterproof specifications.

Dimensions

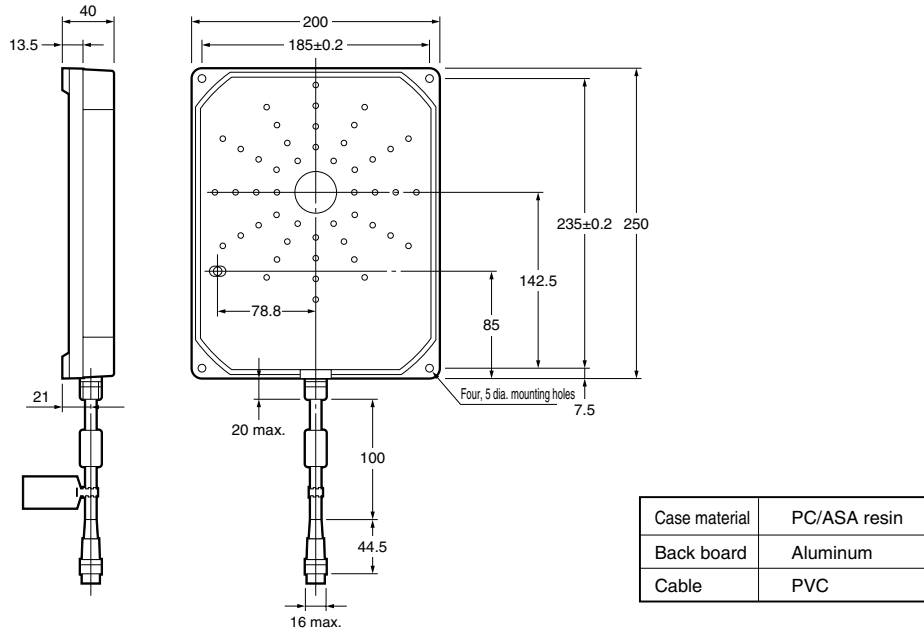
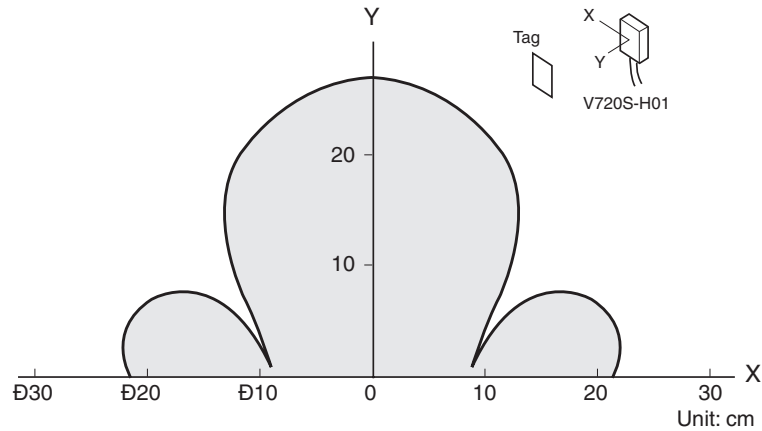

Diagram of Communications Range

A diagram of the V720S-H01's communications range is given below. The communications distance may vary, however, depending on surrounding noise and equipment.

- Read Write Antenna: V720S-H01,
Tags: V720-D52P30/V720-D52P40/V720S-D13P30/V720S-D13P40



ALL DIMENSIONS SHOWN ARE IN MILLIMETERS.
To convert millimeters into inches, multiply by 0.03937. To convert grams into ounces, multiply by 0.03527.

Electromagnetic Inductive RFID System CF II I/F Reader/Writer V720S-HMF01



V720S-HMF01

Product Description

OMRON's V720S-HMF01 CF II I/F Reader/Writer connects to a variety of PDAs (Personal Digital Assistants) to form a handy RFID reader/writer system. Its compact size ensures easy portability for use virtually anywhere.

Features

- Applies I-Code1 chip and I-Code SLI (ISO/IEC 15693) chip technology from Philips Semiconductors.
- Readily available PDA interface: Compact Flash Type 2 (<http://www.compactflash.org/>).
- Highly versatile functions, such as Read/Write modes, in a compact size.

Benefits

- Combining the V720S-HMF01 with a PDA costs much less than most handy RFID readers.

General Specifications

Item	Specifications
Communications frequency	13.56 MHz
Ambient temperature in operation	0 to 50°C (with no icing)
Weight	Approx. 30 g
Supply voltage	3.3 VDC ±5%
Antenna dimensions	52 (W) × 35 (H) × 16 (D) mm (The dimensions of the portion of the antenna extending from the PDA when the Unit is mounted in the PDA)
Current consumption	Approx. 175 mA (oscillating), Approx. 100 mA (not oscillating)
Communications range	30 mm with V720-D52P40
Interface	Compact Flash Type 2 (9,600 bps)

Dimensions

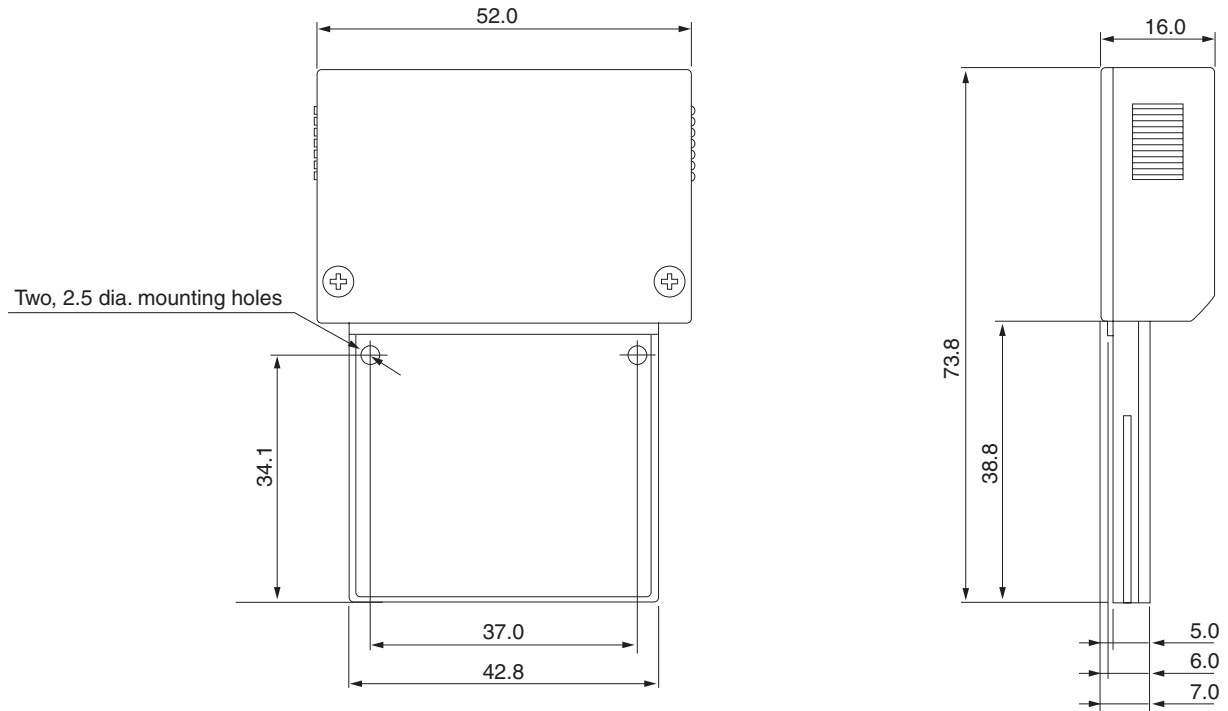

Communications Time (Reference Value)

Command	I-Code1	I-Code SLI
Read	$T = 1.3 N + 6.2$	$T = 1.3 N + 6$
Write	$T = 13 N + 13.5$	$T = 13.6 N + 15.5$

* T = Communications time (msec)

* N = Number of pages (1 page is 4 byte.)

Communications Range

■ Communications Range between V720S-HMF01 and I-Code1 Tag Inlet

Tag Inlet	V720-D52P01	V720-D52P02	V720-D52P03	V720-D52P04
Communications range*1	45	45	3 to 14	3 to 15

■ Communications Range between V720S-HMF01 and I-Code SLI Tag Inlet

Tag Inlet	V720S-D13P01	V720S-D13P02
Communications range*1	45	45

*1 The communications range depends on the environmental conditions, such as temperature, humidity, electronic noise, etc.

ALL DIMENSIONS SHOWN ARE IN MILLIMETERS.

To convert millimeters into inches, multiply by 0.03937. To convert grams into ounces, multiply by 0.03527.

Dimensions

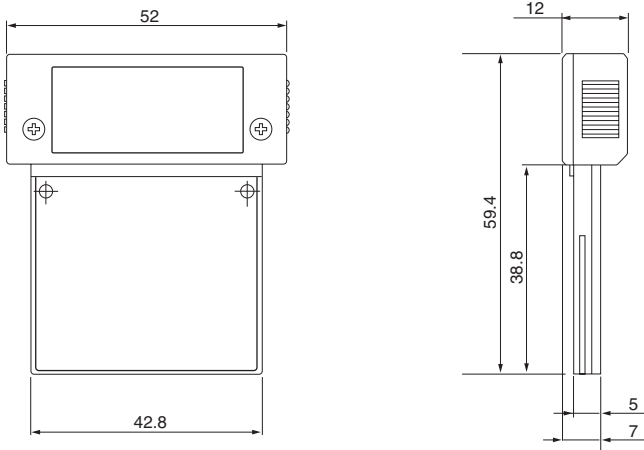

Communications Time (Reference Value)

Read	$T = 48 N + 66$
Write	$T = 55 N + 120$

* T = Communications time (msec)

* N = Number of pages (1 page is 8 bytes.)

Communications Range

■ Tag V700-D13P31/21

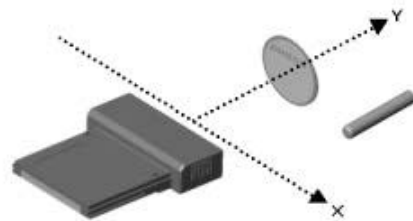
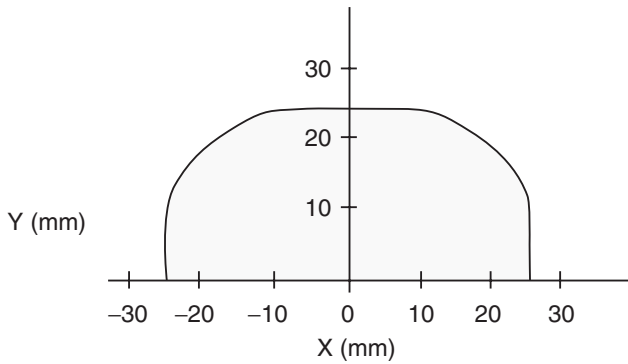

ALL DIMENSIONS SHOWN ARE IN MILLIMETERS.

To convert millimeters into inches, multiply by 0.03937. To convert grams into ounces, multiply by 0.03527.

PCB-type Read Write Modules

V720S-HMC73□

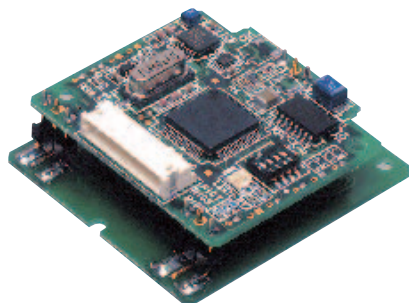

V720S-HMC73

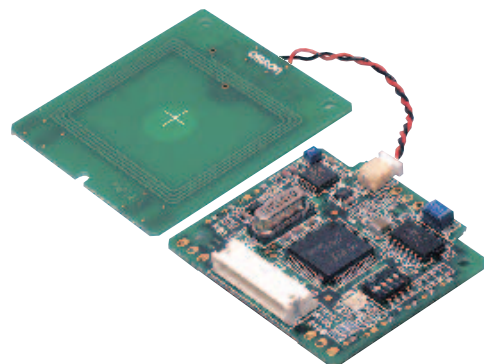

V720S-HMC73T

Product Description

OMRON's PCB-type Read Write Modules are available in unified type (V720S-HMC73) and separate type (V720S-HMC73T), and are ideal for built-in applications.

Features

- Compatible with Phillips I-CODE1 and ISO/IEC 15693 I-CODE SLI tags.
- Can be used directly with higher version software for the V720-HMC73□.
- Compact size, and include a read write function.
- Conform to standards for small-signal stations.

Benefits

- Both unified type and separate type are available.
- Inherit the user-friendly host command structure of the previous series.
- Support host interface with two-wire half duplex serial communications system at C-MOS level (5 V).

General Specifications

Item	Specifications	
	V720S-HMC73	V720S-HMC73T
Mounting	M2.3 screw mounting at 3 points	M2 screw mounting at 2 points for the circuit board, M2.3 screw mounting at 3 points for the antenna board
Communications frequency	13.56 MHz	
Ambient temperature in operation	-10 to 55°C	
Supply voltage	5 VDC ±10%	
Current consumption	Approx. 70 mA max. (oscillating), approx. 20 mA max. (not oscillating), approx. 10 mA (stopped)	
Vibration resistance	Destruction: 10 to 150 Hz, 0.1-mm single amplitude at 15 m/s ² in three directions 10 times for approximately 8 minutes	
Shock resistance	Destruction: 150 m/s ² three times each in six directions	
Communications system	Two-wire half duplex serial communications system (C-MOS level)	
Connector	S10B-ZR-SM3A-TF (J.ST. MFG. CO., LTD.)	
Communications control system/ baud rate	CR control/Character control/9,600 bps/38,400 bps	
Weight	Approx. 12 g	

Dimensions

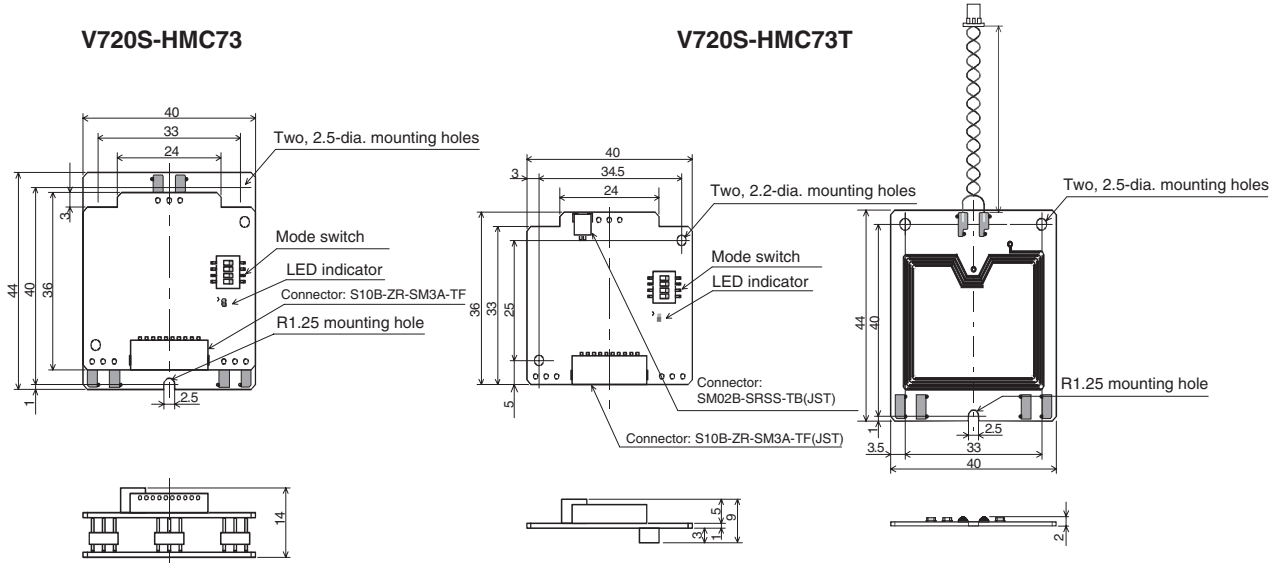

Communications Time (Reference Value)

Command	I-CODE1	I-CODE SLI
Read	$T = 1.3 N + 6.2$	$T = 1.3 N + 6.0$
Write	$T = 13 N + 13.5$	$T = 13.6 N + 15.5$

*1:T = Communications time (msec)

N = Number of processing pages (4 bytes/page)

*2:This refers to the time required for communications between the Read Write Module and the Tag Inlets, using single trigger mode. It also refers to the time required when the read/write page numbers are continuously designated.

Communications Distance (Reference Value)

The communications distances for the V720S-HMC73 Read Write Module and V720-series Tag Inlets are as listed in the following table.

Tag Inlets	V720-D52P01	V720-D52P02	V720-D52P03	V720-D52P04
Communications distance (mm) (Measured at 25°C)	45	45	18 (*2)	18 (*2)

*1: The communications distance may vary depending on surrounding noise and equipment.

*2: The communications distance for writing is 5 to 18 mm.

ALL DIMENSIONS SHOWN ARE IN MILLIMETERS.
 To convert millimeters into inches, multiply by 0.03937. To convert grams into ounces, multiply by 0.03527.

Electromagnetic Inductive RFID System Development Kits V720-W01-□

Each Development Kit contains the equipment, user's manual, and demonstration software necessary for V720-series product demonstrations, product evaluation, and application development.



Ordering Information

Model	Name	ID Tags included in Kit
V720-W01-1	V720 Development Kit A	V720-D52P40: 100 Tags, V720-D52P30: 5 Tags, V720-D52P30-T: 5 Tags
V720-W01-2	V720 Development Kit B	---

Development Kit Contents

No.	Product	Model	QTY
1	Read Write Antenna	V720□-H01	1
2	ID Controller	V720□-CD1D	1
3	Antenna Cable	V700-A40	1
4	Operation Manual (Read Write Antenna)	S907-E1-1	1
5	Operation Manual (ID Controller)	S908-E1-2	1
6	Screwdriver	-	1
7	Ferrite Core (TDK)	ZCAT2032-0930	1
8	Power Supply Unit	S82K-03024	1
9	Interface Cable (RS-232C)	-	1
10	V720-CD1D Demonstration Software Ver. 1.00	-	1
11	V720-CD1D Demonstration Software Operation Manual	S909-E1-1	1
12	Case	-	1
13	Weight	Approx. 5.2 kg	-

Product Description

OMRON provides RFID system solutions based on its comprehensive engineering ability in Label Tags and Readers. In order to facilitate RFID system development and evaluation, OMRON offers the V720-W01-□ Development Kits.

Features

- Conforms to the international standard ISO 15693 for no-contact IC cards.
- Applies I-CODE chip technology from Philips Semiconductors.
- Three kinds of Tags are provided in the Kit.
- Conforms to EC Directives.
- Includes easy-to-use demonstration sample programs.

Benefits

- Integrated into a case for easy carrying.
- Can be easily connected via RS-232C to a host in an existing system.

Dimensions of the Development Kit

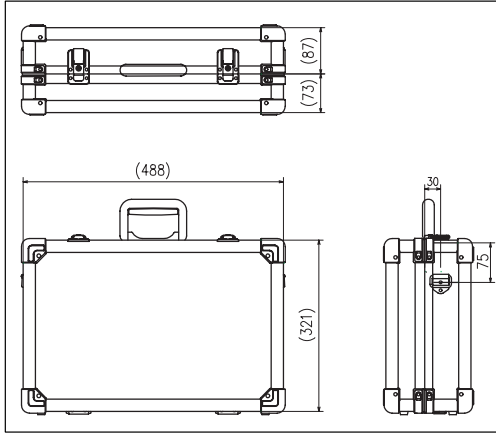

ALL DIMENSIONS SHOWN ARE IN MILLIMETERS.

To convert millimeters into inches, multiply by 0.03937. To convert grams into ounces, multiply by 0.03527.

V720-series Electromagnetic Inductive RFID System Examples of Projects Developing Large-scale Antennas for Special Applications

OMRON offers RFID system solutions that utilize its technical capability in the field of label tags and large-scale readers.

OMRON also develops large-scale readers for special distribution applications. Consult your OMRON representative for more information.

Large-scale Readers for Supply Chain Management (SCM)

Dedicated readers raise the efficiency of delivering to and shipping from warehouses for SCM.



0.8-m-wide Portal Reader



1.4-m-wide Large-scale Reader for European Palettes

STR (Sortation Tunnel Reader) for Check-in Baggage at Airports

Sortation tunnel readers are used in sorting machines for check-in baggage at airports and parcels for international delivery.

■ Tilt Conveyors



■ Belt Conveyors



Outline of STR Specifications

- Communications frequency: 13.56 MHz
- Conveyor speed: 2.0 m/s max.
- Read area dimensions: 1.0 (W) × 0.7 (H) × 0.5 (D) m
- Product dimensions: 1.73 (H) × 1.37 (W) × 1.47 (L) m

ALL DIMENSIONS SHOWN ARE IN MILLIMETERS.

To convert millimeters into inches, multiply by 0.03937. To convert grams into ounces, multiply by 0.03527.

Product Variations	B- 3
Terminology for 2-Dimensional Codes	B- 4
2-Dimensional Code Readers	
2-Dimensional Code Reader (Fixed Type)	
V530-R150E-3, EP-3	B- 7
2-Dimensional Code Reader (Fixed Type)	
V530-R160E, EP	B-19
Handheld 2-Dimensional Code Reader	
V530-H3	B-24

Product Variations

Bringing about a revolution in data management by linking information to the physical world.

■ 2-Dimensional Code Readers

Variations

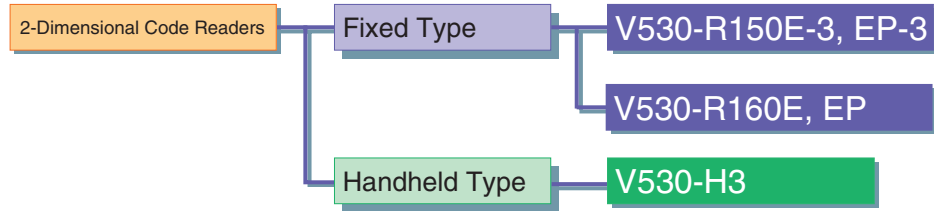

V530-R150E-3, EP-3

See page B- 7.

- Intelligent Light Source and Two-camera Unit
- Compatible with Data Matrix Old Version
- Reads dot cell codes.
- Conforms to SEMI standard T7.

V530-R160E, EP

See page B- 19.

- Dependably Read Pin-stamped Markings
- Dot Codes* Read at Any Angle: 360° Compatibility
- Dependably Read Markings at an Angle
- Easy Setup
- Easy Operation and Maintenance
- Easy Analysis



V530-H3

See page B- 24.

- Select from 3 different types of handheld reader to suit the marked object.
- Minimum resolution of 50 μm.
- Reads dot cell codes.



Terminology for 2-Dimensional Codes

The terminology explained below focuses on terms related to QR Codes and Data Matrix codes which are matrix-type 2-dimensional codes. There may be some parts of this glossary that do not apply to other types of 2-dimensional codes.

Matrix-type Codes

These are 2-dimensional codes that are represented using patterns of black and white squares. Two typical matrix-type 2-dimensional codes are shown below.



QR Code



Data Matrix

Stack-type Codes

These are 2-dimensional codes that consist of several 1-dimensional bar codes stacked vertically. Two typical stack-type 2-dimensional codes are shown below.



PDF 417



CODE 49

Data Matrix

Data Matrix codes were developed by I.D. Matrix, and are used extensively in the semiconductor and electronics industries. Data Matrix codes have a relatively large data capacity for their size. There are several different types of Data Matrix, differentiated by their error correction method. The ECC200 is the most commonly used type.



QR Code

The “Quick Response Code” type is a 2-dimensional code that was developed in Japan. High-speed reading is possible with QR Codes, but the code size is quite large compared to other 2-dimensional codes.



Finder Pattern

These are patterns used to detect the position of 2-dimensional codes. The shape of the finder patterns varies with the type of code.

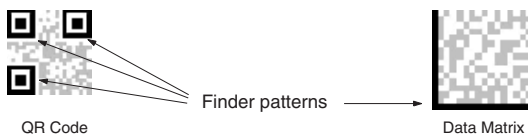

QR Code

Data Matrix

Cell

These squares are the units that make up matrix-type 2-dimensional codes. Whether these cells are black or white determines the information carried by the code.

Version (QR Code)

The code size of QR Codes is indicated by the version. “Version 1” indicates that a QR Code contains (the minimum) 21 cells both horizontally and vertically. The larger the version number, the larger the number of cells per side.

Margin (Quiet Zone)

This is the empty space around 2-dimensional codes. Usually it is necessary to ensure that there is a margin around 2-dimensional codes. When the QR Code (Pattern) mode is used, a margin of 4 cells is required.

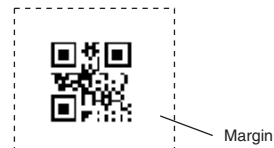

Error Correction

This term is used to describe the function which detects and corrects errors using a special mathematical technique (commonly known as the “Reed-Solomon” method). Using this function, reading is possible, to a certain extent, for codes with poor printing quality or that are damaged. There are, however, limits on the extent to which correction is possible, and reading may not be possible for codes if the damage is extensive. There are 2-dimensional codes for which the error correction level can be selected. (For example, with QR Codes, error correction levels of 7%, 15%, 25%, or 30% are available.)

Maximum Data Capacity

The maximum amount of data that can be stored in a code varies with the code size. In other words, if there is a large amount of data to be stored, then the code size must also be large. The maximum data capacity will also vary with the type of characters used. With QR Codes and Data Matrix codes, the numeric capacity (numbers only) is larger than the alpha numeric capacity (numbers and letters).

Right and Left Reversal

This is the term used to describe the state that occurs when reading 2-dimensional codes marked on a transparent material or reading codes reflected in a mirror. For example, right and left reversal will occur when attempting to read a 2-dimensional code marked on a piece of glass from the reverse side.

Black and White Reversal

Usually, in images of 2-dimensional codes, the code itself is black and the background is white. Sometimes, however, due to the material of the reading object and the kind of lighting used, the code will appear white in the image obtained. This phenomenon is called “black and white reversal.”



QR Code in black and white reversal

■ Marking Methods

There are several marking methods that can be used. The most suitable method will depend on factors such as the material of the object onto which the code is marked. The most commonly used marking devices are listed below.

- Printer

A printer can be used to print codes onto paper and different kinds of labels.

- Laser Marker

A laser marker can be used to mark metal objects. A laser marker can mark very finely enabling the size of 2-dimensional codes to be reduced.

- Exposure Marking

Using exposure marking, particles are not created (unlike laser marking) and even finer marking is possible than with laser marking. Exposure marking is used with semiconductor wafers, LCD panels, and color filters that have exposure processing.

ALL DIMENSIONS SHOWN ARE IN MILLIMETERS.

To convert millimeters into inches, multiply by 0.03937. To convert grams into ounces, multiply by 0.03527.

2-Dimensional Code Reader (Fixed Type) V530-R150E-3, EP-3

Intelligent Light Source and a Two-camera Unit Respond to a Wide Variety of Applications

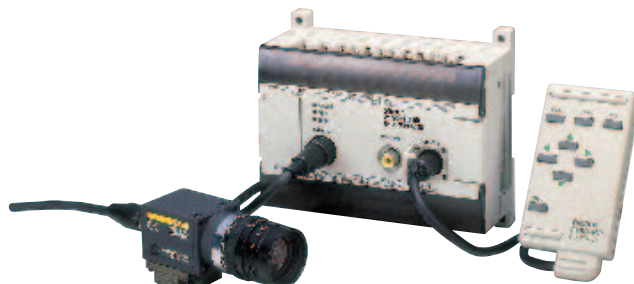

Features

Intelligent Light Source

Versatile lighting control and a dome shape that minimizes external interference provide stable images for 2-dimensional code reading.

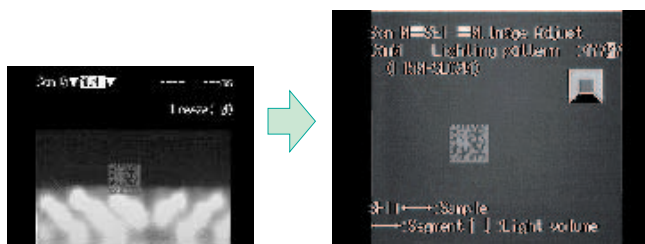

Ring lighting

Intelligent Light Source

Reduces the background effects of metal processed parts.

A Variety of Lighting Methods

The lighting direction and intensity can be changed. In addition, coaxial lighting is available with the F150-SLC20. Optimal lighting methods can be set for a wide variety of workpieces.

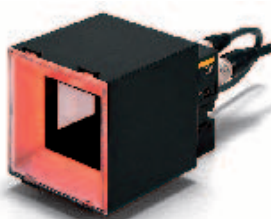

F150-SLC20 (Field of vision: 20 mm)

The light intensity can be set for each of five lighting blocks, in eight steps.

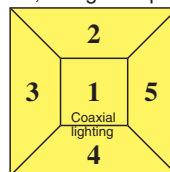

F150-SLC50 (Field of vision: 50 mm)

The light intensity can be set for each of eight lighting blocks, in eight steps.

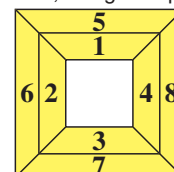

Lighting Controlled from Menu

- The lighting block and intensity can be controlled from the Controller menu. Settings can be easily changed without having to touch the light itself.
- Because light is handled as scene data, the lighting conditions can be varied to match model changes on mixed-product lines.
- The Controller manages light settings numerically, for accurate reproducibility.

Two-camera Unit

Two cameras can be switched by a single Controller.



Application Example

Simultaneous single-product and lot management

Single products and lots can be managed simultaneously.

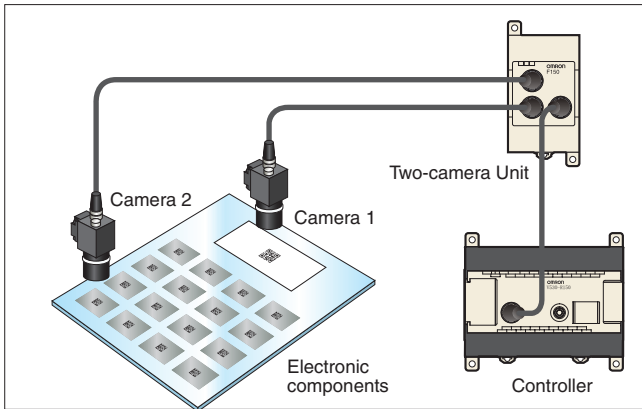

Greater positioning tolerance

For applications that cannot be covered by the field of vision of only one camera.

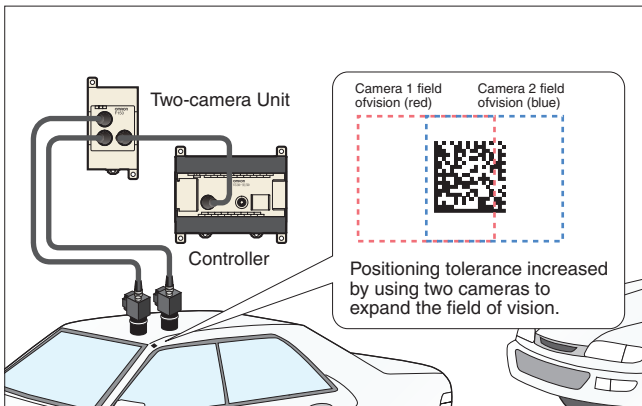

Compatible with Data Matrix Old Version

The V530-R150V3 Controller is also capable of reading the Data Matrix Old Version. (See note.)

Note: Compatible with ECC000, 050, 080, 100, and 140.

Compatible with Data Matrix ECC200, with Up to 64 × 64 Cells

To enable the use of more information, ECC200 codes with up to 64 × 64 cells (max. of 418 alphanumeric characters) can be read.

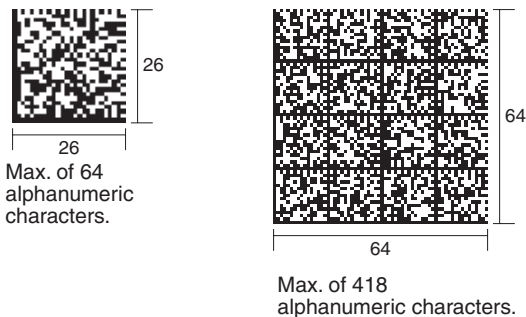

New Guidance Function for the Settings Display

The addition of a guidance function on the display greatly simplifies setting.



Easy-to-Read Analytical Data Format

See the reading status at a glance on the reading information display. The finder pattern, cell recognition, reading data, etc., can all be viewed on the display.



Finder pattern (cutting symbol)

Use this pattern to detect the 2-dimensional code position. The finder pattern is different for each code.



Easy Image Analysis

The image analysis mode helps to detect the cause of marking problems.



Store up to 24 Defect Images

Use the stored images to confirm defect types.



Note: Stored images are kept until the power is turned OFF.

Applications

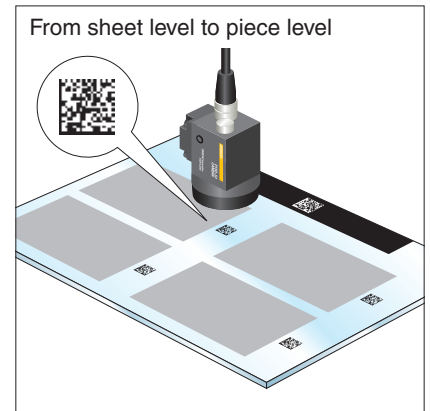
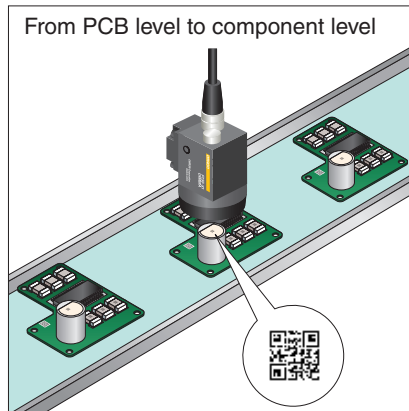
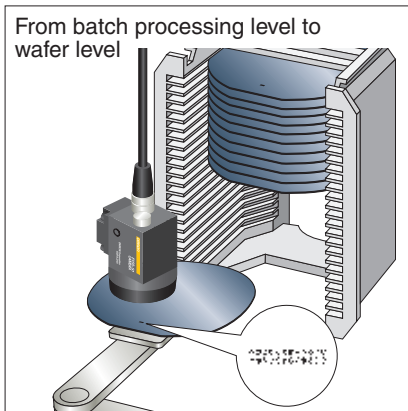

Ordering Information

■ List of Models

Name	Model No.
Controller	V530-R150E-3, EP-3
Console	F150-KP-2D
Camera	F150-S1A-2D
Camera Cable (3 m)	F150-VS-2D
Two-camera Unit	F150-A20
Monitor Cable (2 m)	F150-VM-2D
Liquid Crystal Monitor	F150-M05L-2D
Video Monitor	F150-M09-2D

Specifications

■ Controller

Item	V530-R150E-3, EP-3
Readable codes	Data Matrix ECC200: 10 × 10 to 64 × 64, 8 × 18, 8 × 32, 12 × 26, 12 × 36, 16 × 36, 16 × 48 Data Matrix Old Ver. (ECC000, 050, 080, 100, 140): 9 × 9 to 25 × 25 QR Code (Model 1, 2): 21 × 21 to 41 × 41 (Version 1 to 6)
Readable direction	360°
Number of pixels (resolution)	512 (H) × 484 (V)
Number of connectable cameras	1 (Using F150-A20: 2 max.)
Number of scenes	10
Image memory function	Maximum of 24 images stored.
Operation method	Menu selectable
Processing method	Gray
Monitor interface	1 channel (over scan monitor)
RS-232C I/F	1 channel
Parallel I/O	3 inputs and 9 outputs including control I/O points
Power supply voltage	20.4 to 26.4 VDC
Degree of protection	IEC 60529: IP 20 (panel mounted)
Current consumption	Approx. 0.5 A
Ambient temperature/humidity	0 to 50°C/35% to 85% (with no condensation)
Weight	Approx. 390 g

■ Camera

Item	F150-S1A-2D	
Camera	Picture element	1/3" CCD
	Effective pixels	659 (H) × 494 (V)
	Shutter function	Electronic frame shutter Shutter speed: 1/100, 1/500, 1/2000, or 1/10000 sec (menu selectable)
Lens	Mounting distance	F150-SLC20: 15 to 25 mm F150-SLC50: 16.5 to 26.5 mm F150-SL20A: 61 to 71 mm F150-SL50A: 66 to 76 mm
	Field of vision	F150-SLC20/SL20A: 20 × 20 mm, F150-SLC50/SL50A: 50 × 50 mm
Light	Light source	F150-SLC20/50: Red LED/Green LED, F150-SL20A/50A: Red LED
	Lighting method	Pulse (synchronized with camera shutter)
Ambient temperature	Operating: 0 to 50°C, storage: -25 to 60°C (with no icing or condensation)	
Ambient humidity	Operating/Storage: 35% to 85% (with no condensation)	
Weight (camera only)	F150-ALC20: Approx. 280 g, F150-FLC50: Approx. 370 g, F150-SL20A/50A: Approx. 135 g, F150-S1A: Approx. 80 g	

■ Two-camera Unit

Item	F150-A20
Number of connectable cameras	2
Camera mode	2-camera selectable Single, independent (camera 0/1)
Power supply voltage	20.4 to 26.4 VDC
Current consumption	Approx. 0.3 A
Ambient temperature	Operating: 0 to 50°C storage: -25 to 60°C (with no icing or condensation)
Ambient humidity	Operating/Storage: 35% to 85% (with no condensation)
Weight (2-camera unit only)	Approx. 220 g

■ Monitor

Item	Liquid Crystal Monitor	Video Monitor
	F150-M05L-2D	F150-M09-2D
Size	5.5 inches	9 inches
Type	Liquid crystal color TFT	CRT monochrome
Resolution	320 × 240 dots	800 TV lines min. (at center)
Input signal	NTSC composite video (1.0 V/75 Ω)	
Power supply voltage	20.4 to 26.4 VDC	100 to 240 VAC (-15%, +10%)
Current consumption	Approx. 700 mA	Approx. 200 mA
Ambient temperature	Operating: 0 to 50°C storage: -25 to 60°C (with no icing or condensation)	Operating: -10 to 50°C storage: -20 to 65°C (with no icing or condensation)
Ambient humidity	Operating/Storage: 35% to 85% (with no condensation)	10% to 90% (with no condensation)
Weight (monitor only)	Approx. 1 kg	Approx. 4.5 kg

System Configuration

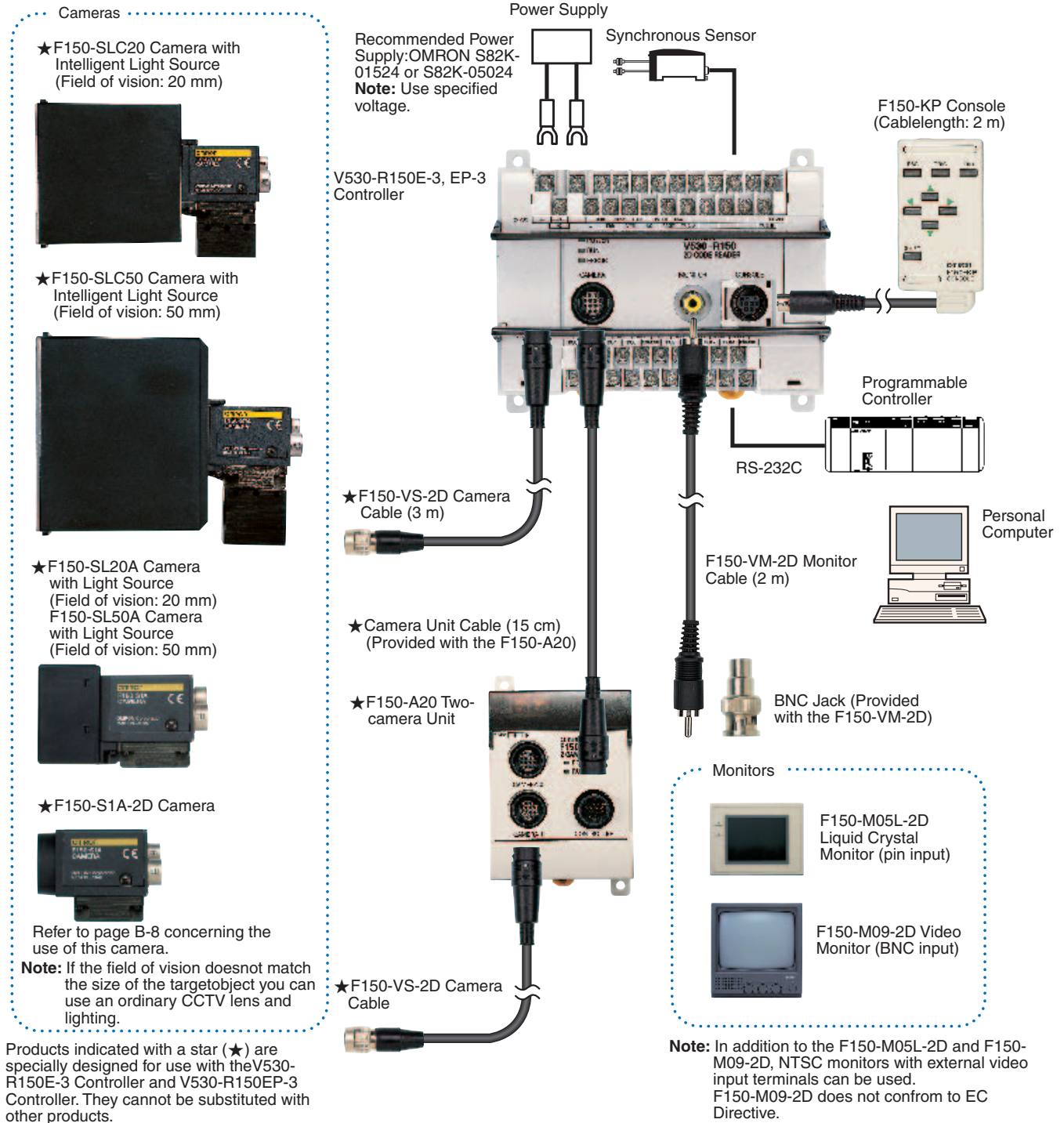

Lighting Methods

Select the appropriate lighting method for the material of the marked object.

Back Lighting

Codes on transparent objects such as glass PCBs can be read by detecting the contrast between transmitted and blocked light.

Applications: Transparent objects such as LCD glass

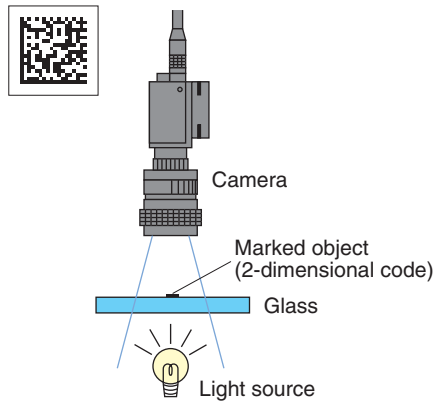

Reflected Lighting

Ring Lighting

For codes printed onto paper or other light-diffusing objects, ring lights can be used to illuminate the marked object. The difference in the reflection factors of the background and the marking enables stable detection.

Applications: Paper labels and corrugated cardboard

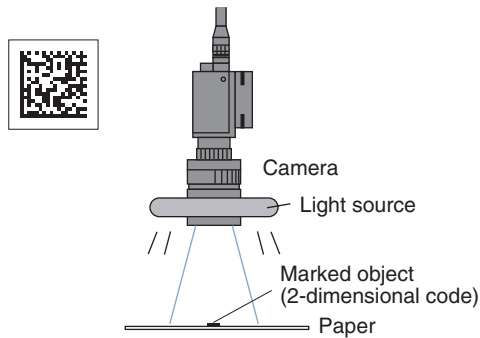

Oblique Lighting

Ring lighting close to the marked object

For codes inscribed with a laser maker onto PCBs and other relatively glossy surfaces, oblique lighting provides stable detection by distinguishing between regular and diffuse reflected light.

Applications: Direct marking on PCBs and electronic parts

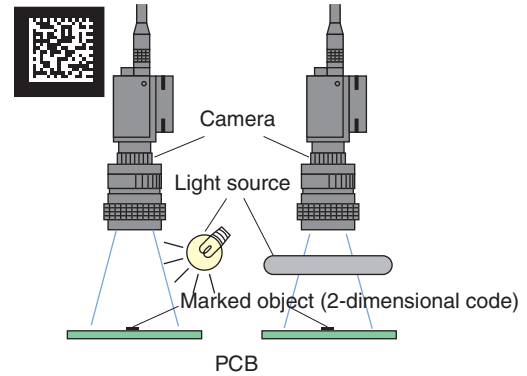

Coaxial Lighting

For codes marked directly onto wafers and other mirror-like surfaces, a stable image with few shadows from surface irregularities can be obtained from the marked object by using coaxial lighting, because it detects only regular reflected light. (The surface of the object must be perpendicular to the optical axis.)

Applications: Mirror-like objects such as wafers

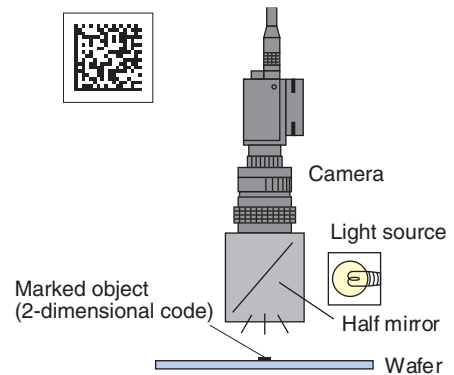

Data Capacity

Data Matrix ECC200

The relation between matrix size (number of cells) and data capacity is shown in the table below. In this example, the matrix size is 12 × 12 cells.

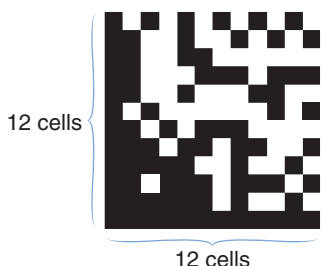

QR Code Model 2

The relation between matrix size (number of cells) and data capacity is shown in the table below. In this example, the matrix size is 21 × 21 cells.

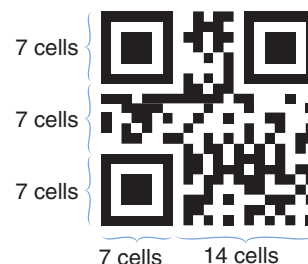

Matrix size	Maximum data capacity				
	Numbers	Alpha-numeric characters	Symbols	Japanese Kanji (Shift JIS)	JIS8
10 × 10	6	3	3	---	1
12 × 12	10	6	5	1	3
14 × 14	16	10	9	3	6
16 × 16	24	16	14	5	10
18 × 18	36	25	22	8	16
20 × 20	44	31	28	10	20
22 × 22	60	43	38	14	28
24 × 24	72	52	46	17	34
26 × 26	88	64	57	21	42
32 × 32	124	91	81	30	60
36 × 36	172	127	113	42	84
40 × 40	228	169	150	56	112
44 × 44	288	214	190	71	142
48 × 48	348	259	230	86	172
52 × 52	408	304	270	101	202
64 × 64	560	418	372	139	278
8 × 18	10	6	5	1	3
8 × 32	20	13	12	4	8
12 × 26	32	22	20	7	14
12 × 36	44	31	28	10	20
16 × 36	64	46	41	15	30
16 × 48	98	72	64	23	47

Matrix size (version)	Error correction	Maximum data capacity			
		Numbers	Alphanu-meric characters (upper case only)	JIS8	Japanese Kanji (Shift JIS)
21 × 21 (version 1)	L (7%)	41	25	17	10
	M (15%)	34	20	14	8
	Q (25%)	27	16	11	7
	H (30%)	17	10	7	4
25 × 25 (version 2)	L (7%)	77	47	32	20
	M (15%)	63	38	26	16
	Q (25%)	48	29	20	12
29 × 29 (version 3)	L (7%)	127	77	53	32
	M (15%)	101	61	42	26
	Q (25%)	77	47	32	20
33 × 33 (version 4)	L (7%)	187	114	78	48
	M (15%)	149	90	62	38
	Q (25%)	111	67	46	28
37 × 37 (version 5)	L (7%)	255	154	106	65
	M (15%)	202	122	84	52
	Q (25%)	144	87	60	37
41 × 41 (version 6)	L (7%)	322	195	134	82
	M (15%)	255	154	106	65
	Q (25%)	178	108	74	45
	H (30%)	139	84	58	36

Note: 1. Maximum Data Capacity

The maximum amount of data that can be stored in a code varies with the code size. In other words, if there is a large amount of data to be stored, then the code size must also be large. The maximum data capacity will also vary with the type of characters used. With a QR Code or Data Matrix, the numeric capacity (numbers only) is larger than the alpha numeric capacity (numbers and letters), which is in turn larger than the Japanese Kanji (Shift JIS) capacity. The order and combinations of different characters also affects the data capacity.

2. The matrix size of a QR Code is indicated by the version. "Version 1" indicates that a QR Code contains (the minimum) 21 cells both horizontally and vertically. The larger the version number, the larger the number of cells per side.

Cameras with Light Source

Cameras with Intelligent Light Source

20-mm field of vision	F150-SLC20
50-mm field of vision	F150-SLC50

Note: These models consist of an F150-S1A Camera with Lens and Intelligent Light Source.

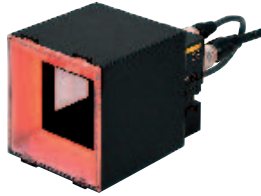

Using the Camera with Intelligent Light Source or Camera with Light Source

- The Lens has a fixed focus. Because there is a certain amount of variation in the field of vision and focus of each Lens, the mounting distance must be adjusted each time the Lens or Camera is replaced.
- The camera mounting distance is approximate. Use a mounting method that allows the distance to be adjusted back and forth in the direction of the 2-dimensional code.

2-Dimensional Code Reader Distance vs. Field of Vision

Mount the Camera at a distance that will provide accurate imaging of the 2-dimensional codes.

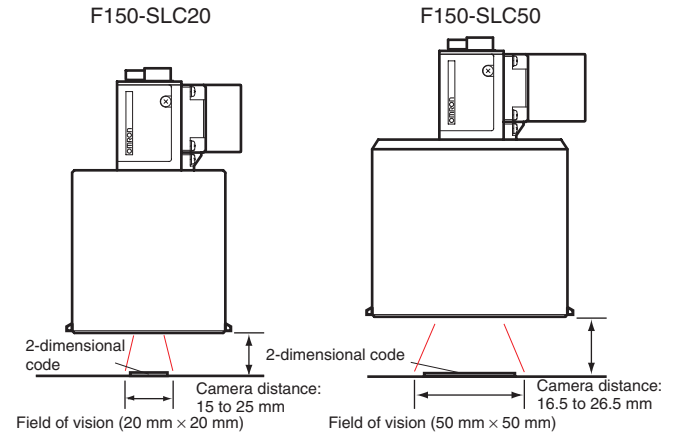

Lenses

CCTV Lenses

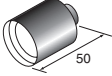
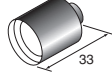
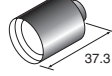
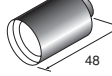
CCTV Lenses				
Model	3Z4S-LEB1214D-2	3Z4S-LEC1614A	3Z4S-LEB2514D	3Z4S-LEB5014A
Dimensions	42 dia. 	30 dia. 	30 dia. 	48 dia. 
Locking mechanism	Focus/iris locking mechanism			

Note: Refer to the following optical graph to select the Lens and Extension Tube according to the field of vision and camera mounting distance being used.

Extension Tubes

Model	3Z4S-LE EX-C6
Length	A set of six Extension Tubes that are 40, 20, 10, 5, 1, and 0.5 mm in length respectively.

Optical Graph

Point: Based on the necessary field of vision and workpiece, select the Lens and Extension Tube to suit the working distance (WD).
 Lengthening the Extension Tube lowers the brightness, and increasing distance WD increases the depth of field.

Note: Slight differences exist between cameras. When mounting the Lens, provide a means of adjusting the camera mounting distance. For example, to obtain a camera mounting distance WD of about 30 mm with a field of vision of 10 mm, mount a 5-mm Extension Tube to the 3Z4S-LEC1614A.

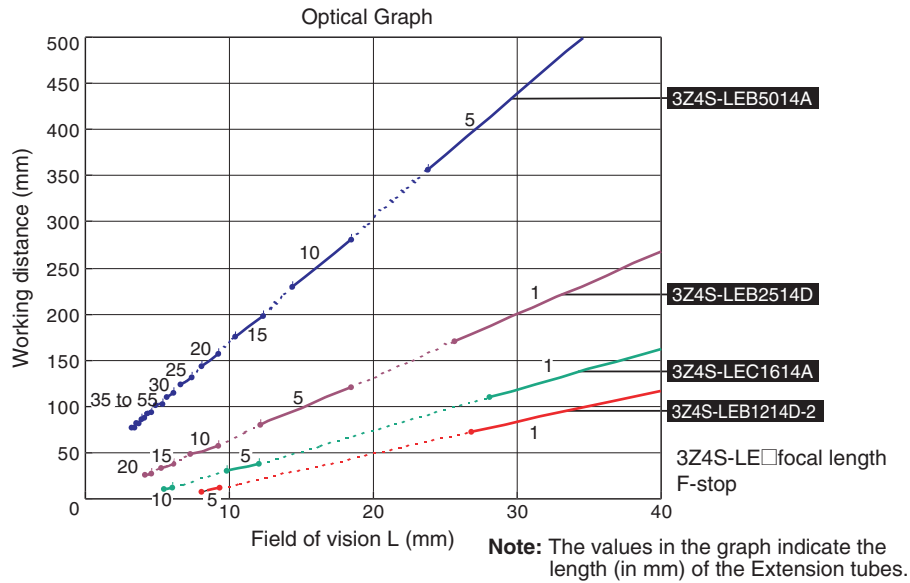

Reading the Optical Graph

The X axis of the graph shows field of vision L in millimeters, and the Y axis shows the camera mounting distance A in millimeters. The curves on the graph indicate different Lenses, and the "t" values indicate the lengths of the Extension Tubes.

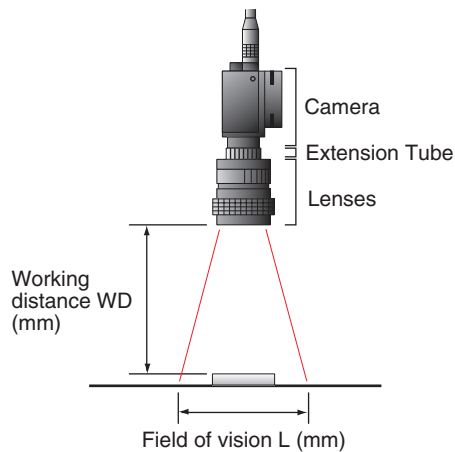

Dimensions

Note: All units are in millimeters unless otherwise indicated.

2-Dimensional Code Reader

V530-R150E-3, V530-R150EP-3

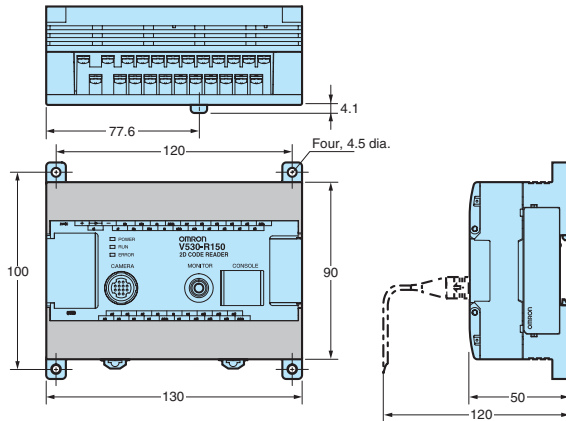

Camera

F150-SLC20
(Camera with F150-LTC20 Intelligent Light Source)

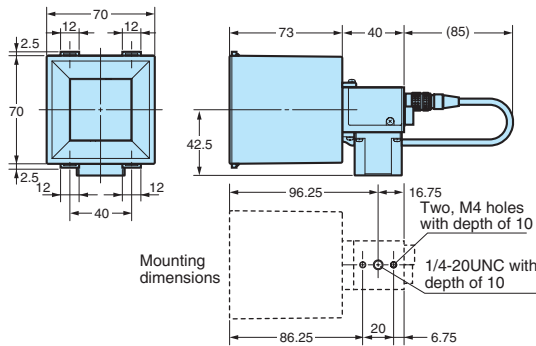

F150-SLC50
(Camera with F150-LTC50 Intelligent Light Source)

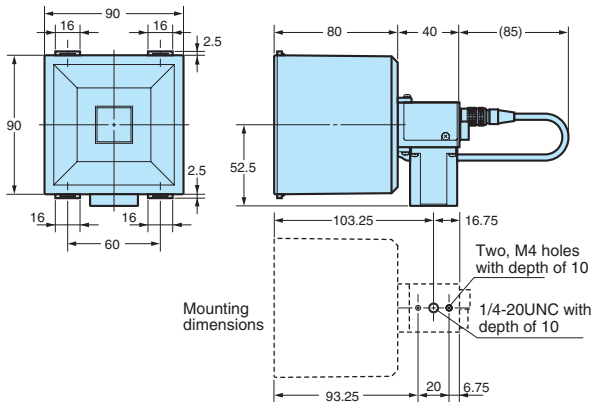

F150-S1A-2D (Camera only)

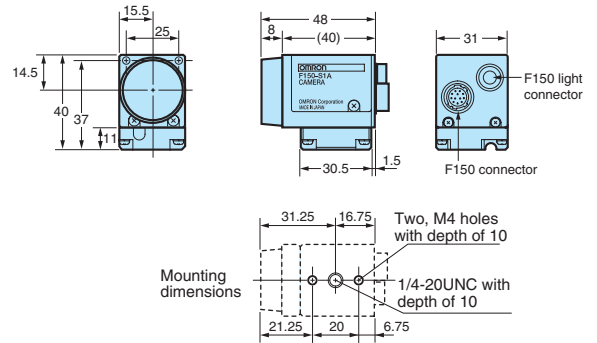

Console

F150-KP-2D

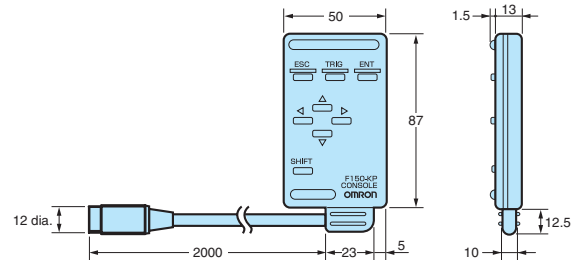

Two-camera Unit

F150-A20

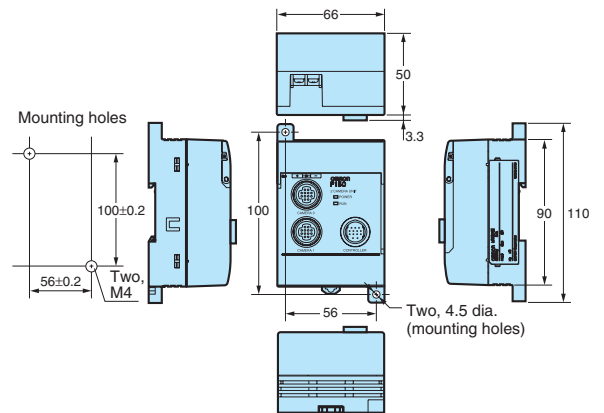

Liquid Crystal Monitor

F150-M05L-2D

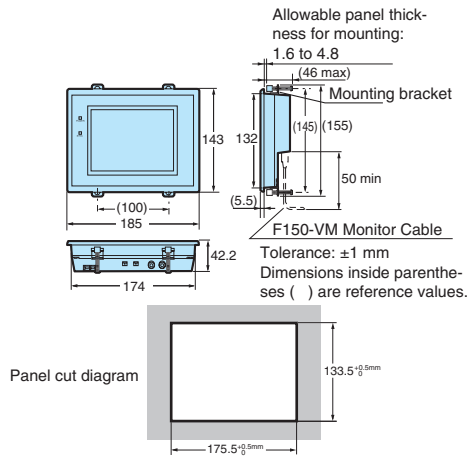

Video Monitor

F150-M09-2D

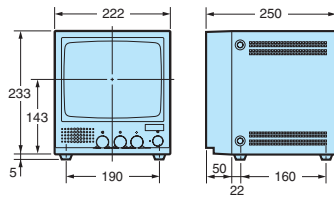

ALL DIMENSIONS SHOWN ARE IN MILLIMETERS.
To convert millimeters into inches, multiply by 0.03937. To convert grams into ounces, multiply by 0.03527.

2-Dimensional Code Reader (Fixed Type) V530-R160E, EP

A code reader that handles pin-stamped markings!



Features

Dependably Read Pin-stamped Markings

- Markings made by pin-stamping machines can be dependably read, providing the user with a wider range of selection of marking devices.
- Stable reading is possible even if the shape of cells changes because of aging in the marking device.
(Reference: Stamping using a Vector Co. pin-stamping machine)

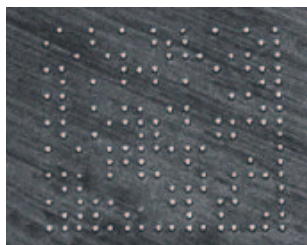

Dependably Read Markings at an Angle

With dependable reading at an angle, installation is possible even on existing facilities with space limitations.



Dot Codes* Read at Any Angle: 360° Compatibility

- Codes can be read even with rough backgrounds on the casting surface or other locations.
- Dot codes* can be read at any angle through a 360° range.
* Dot codes are 2-dimensional codes in which dots form the cells.

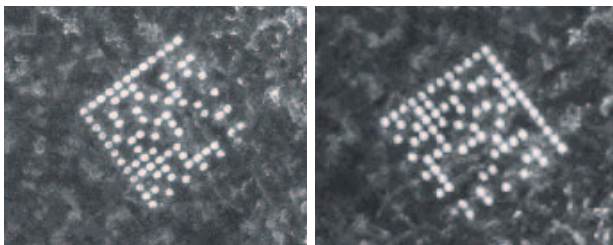

Easy Setup

Setup is easily achieved with a Memory Card (compact flash memory) slot on the V530-R160E and V530-R160EP. Just insert a card to easily copy settings or save images. Carrying a personal computer and cables is no longer required for process switchovers.



Easy Operation and Maintenance

Trends can be monitored to achieve the following:

- Displaying changes in the status (correlation values) of codes or contrast changes on line graphs on a monitor.
- Setting alarm levels while monitoring graphs.
- Outputting external alarms if a value falls below the set value.

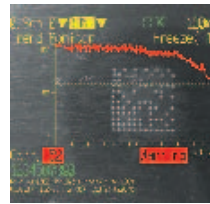

Trend monitoring can be used to set guidelines for replacing parts in lighting devices, marking devices, and other equipment.

Easy Analysis

Manage Data Histories

Histories of the number of OK and NG reads can be managed.

Save Images to Memory Cards

Save approx. 200 images in 64 MB and 400 images in 128 MB.

Check and Analyze Troubles

Up to 35 NG images can be saved in internal memory.

Reproduce Images

Saved NG images can be loaded to reproduce a reading.

Using time stamps on NG images with data histories enables more detailed troubleshooting.

Applications

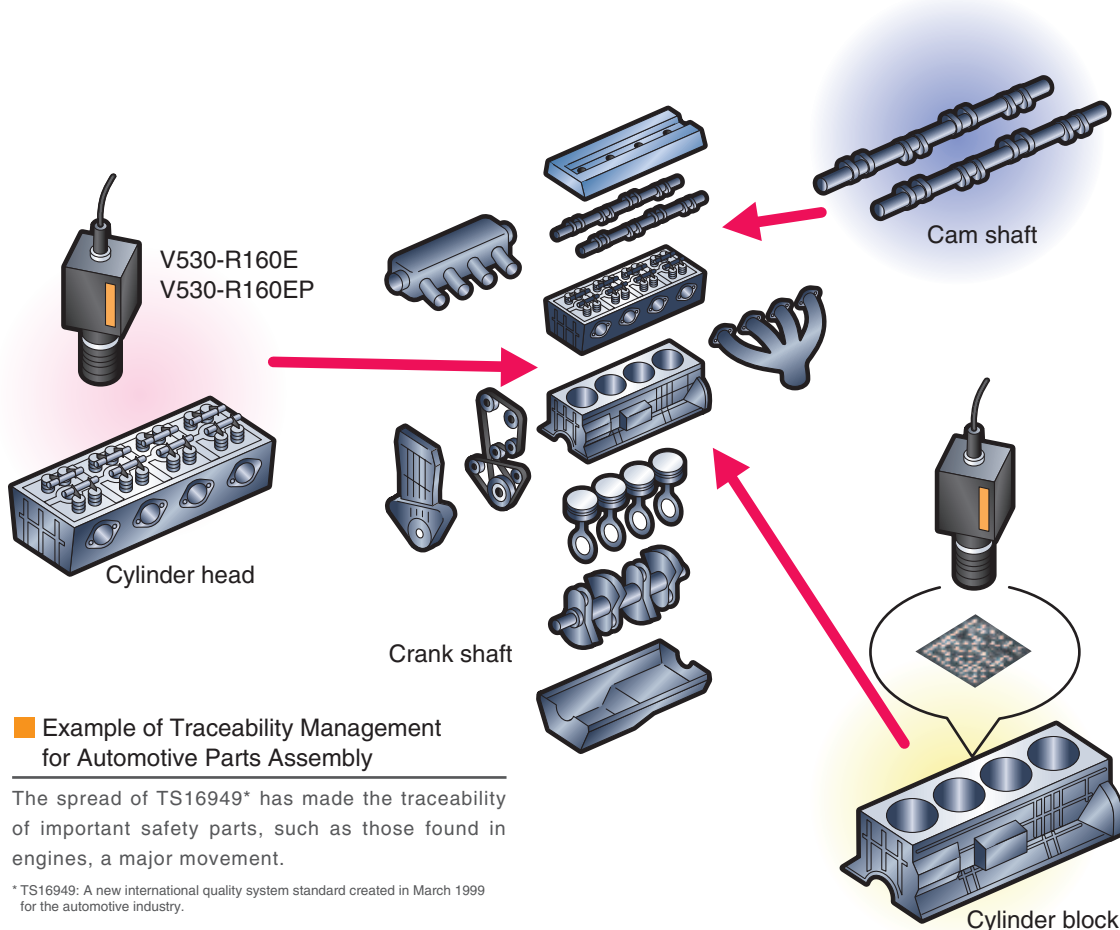

Ordering Information

List of Models

Name	Model No.	Remarks
Controller	V530-R160E, V530-R160EP	
Console	F150-KP-2D	2-m cable
Camera	F150-S1A-2D	
Camera Cable	F150-VS-2D	3-m cable
Monitor Cable	F150-VM-2D	2-m cable
Liquid Crystal Monitor	F150-M05L-2D	
Video Monitor	F150-M09-2D	
Parallel Cable	F160-VP	Cable with loose wires for Parallel I/O Connector (2-m cable)
Memory Card	F160-N64S(S)	Card capacity: 64 MB
	QM300-N128S	Card capacity: 128 MB
RS-232C Cable	XW2Z-200S-V	For IBM PC/AT or compatible computer (2-m cable)
	XW2Z-200T	For SYSMAC PLC (2-m cable)

Specifications

V530-R160E, V530-R160EP Controller

Item	Specifications	
Model	V530-R160E	V530-R160EP
Input/Output type	NPN	PNP
Applicable codes	Data Matrix ECC200: 10 × 10 to 64 × 64, 8 × 18, 8 × 32, 12 × 26, 12 × 36, 16 × 36, 16 × 48 Data Matrix ECC000, ECC050, ECC080, ECC100, ECC140: 9 × 9 to 25 × 25 QR Code (Model 1, 2): 21 × 21 to 41 × 41 (Version 1 to 6)	
Readable direction	360°	
Number of pixels (resolution)	512 (H) × 484 (V)	
Number of connectable cameras	2 max.	
Image memory function	Maximum of 35 images stored (internal memory in Controller).	
Operation method	Selected from menu.	
Processing method	Gray	
Memory Card slot	1	
Monitor interface	1 channel (color/monochrome)	
Serial communications	RS-232C/422A, 1 channel	
Parallel I/O	5 inputs: TRIG-A, TRIG-B, TRIG-C, TRIG-D, and RESET 6 outputs: RUN, ERROR, OK/NG, BUSY, GATE, and ALARM	
Power supply voltage	20.4 to 26.4 VDC	
Current consumption	Approx. 1.6 A max.	
Ambient temperature	Operating: 0 to 50°C, storage: -25 to 65°C (with no icing or condensation)	
Ambient humidity	35% to 85% (with no condensation)	
Weight	Approx. 570 g	

F150-S1A-20 Camera

Item	Specifications
Picture element	1/3-inch CCD
Effective pixels	659 (H) × 494 (V)
Shutter function	Electronic frame shutter Shutter speed: 1/100, 1/500, 1/2000, or 1/10000 s (menu selectable)
Ambient temperature	Operating: 0 to 50°C, storage: -25 to 60°C (with no icing or condensation)
Ambient humidity	35% to 85% (with no condensation)
Weight	Approx. 80 g

Monitor

Item	Name Model No.	Liquid Crystal Monitor F150-M05L-2D	Video Monitor F150-M09-2D
Size		5.5 inches	9 inches
Type		Liquid crystal color TFT	Monochrome CRT
Resolution		320 × 240 dots	800 TV lines min. (at center)
Input signal		NTSC composite video (1.0 V/75 Ω)	
Power supply voltage		20.4 to 26.4 VDC	85 to 264 VAC
Current consumption		Approx. 700 mA	Approx. 200 mA
Ambient temperature		Operating: 0 to 50°C, storage: -25 to 65°C (with no icing or condensation)	Operating: -10 to 50°C, storage: -20 to 65°C (with no icing or condensation)
Ambient humidity		Operating/Storage: 35% to 85% (with no condensation)	Operating/Storage: 10% to 90% (with no condensation)
Weight (Monitor only)		Approx. 1 kg	Approx. 4.5 kg
Accessories		Operation manual, 4 mounting brackets	Operation manual

System Configuration

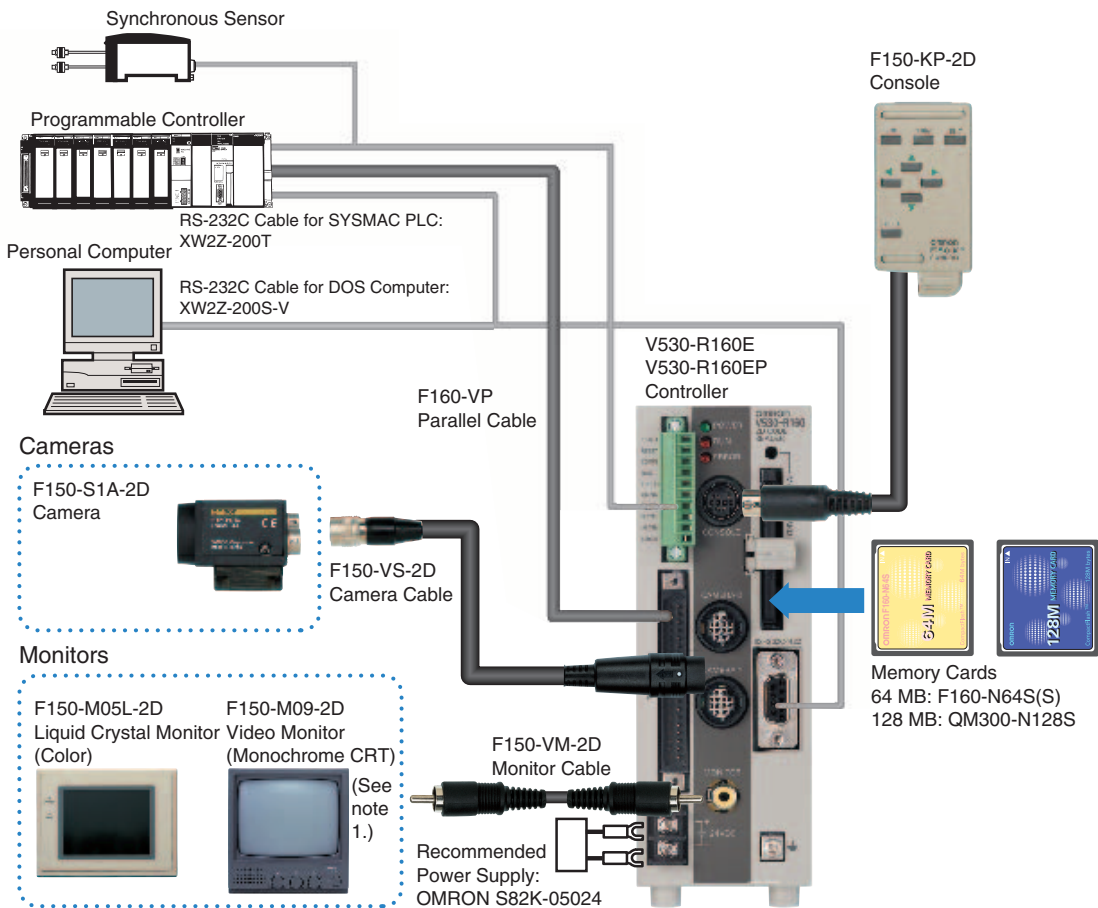

Note 1: F150-M09-2D does not conform to EC Directives.

Dimensions

V530-R160E, V530-R160EP Controller

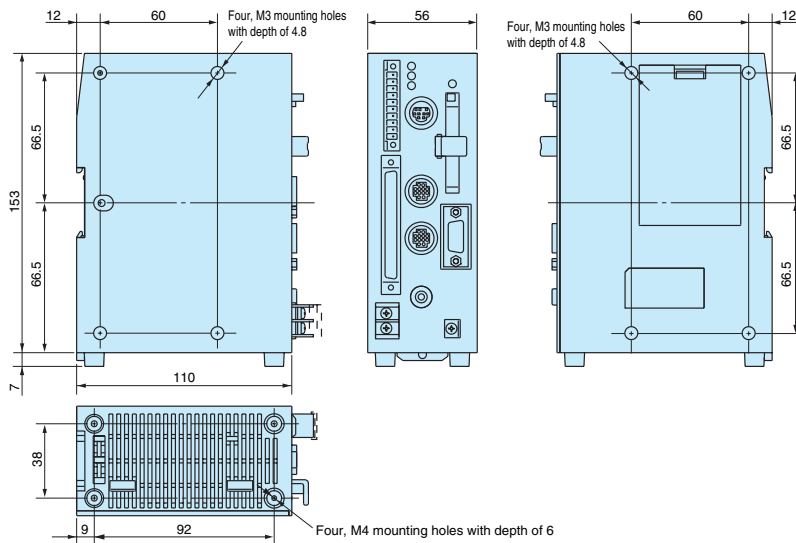

F150-S1A-2D Camera

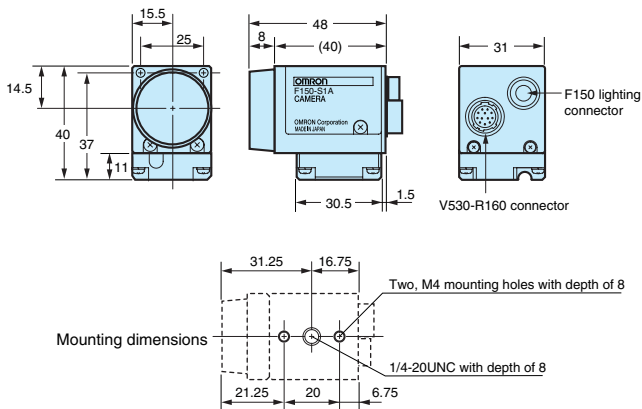

F150-KP-2D Console

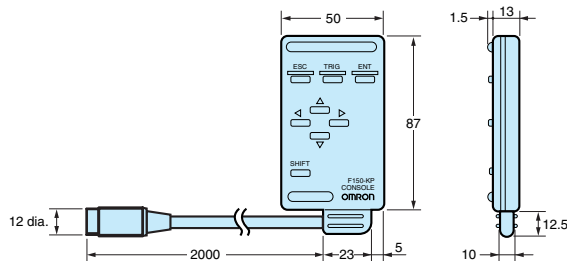

F150-M05L-2D Liquid Crystal Monitor

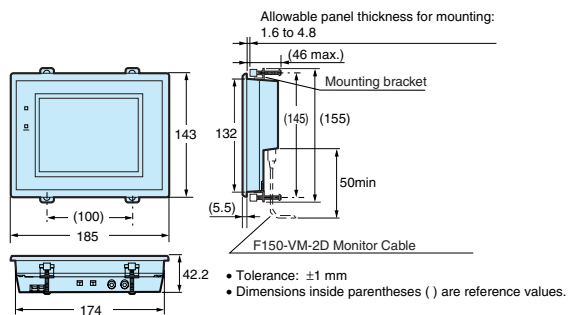

F150-M09-2D Video Monitor

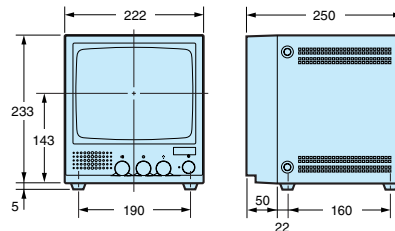

Panel cutout diagram

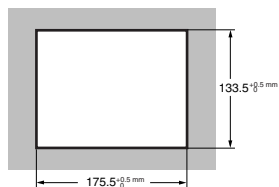

ALL DIMENSIONS SHOWN ARE IN MILLIMETERS.
To convert millimeters into inches, multiply by 0.03937. To convert grams into ounces, multiply by 0.03527.

Handheld 2-Dimensional Code Reader V530-H3

Easy Handheld Reading of Directly Marked, Ultra-Small, 2-Dimensional Codes



Features

Reads Directly Marked 2-Dimensional Codes

In addition to 2-dimensional codes printed onto paper, this convenient handheld unit easily reads codes directly marked with a laser marker onto metal, resin, or glass. (See note.)

Note: The ability to read directly marked codes is affected by the marking method and the material which is marked. These factors must be carefully considered before selecting the Handheld 2-Dimensional Code Reader.

Reads Ultra-Small 2-Dimensional Codes

Ultra-high resolution of 0.05 mm (in the V530-H301 Coaxial Lighting Model) makes it possible to read the ultra-small 2-dimensional codes that are used in many of today's smaller, space-saving products and parts.



Reads Dot Cell Codes

The Handheld 2-Dimensional Code Reader can also read dot cell codes.

Data Matrix (ECC200)



QR Code



Note: The readable direction is limited for dot cell codes.

Three Models to Suit Target Objects

Three models are available to match the objects to be read, and the marking method.



For reading 2-dimensional codes marked onto polished wafer surfaces, LCD glass, and lenses.



For reading 2-dimensional codes marked onto printed wiring boards, electronic parts, and IC packages.



For reading 2-dimensional codes marked onto LCD glass substrates or color filters.

Lightweight, Compact, Handheld Design

Measuring only 175 mm in length and weighing only 100 g, the Handheld 2-Dimensional Code Reader can be used to control a variety of production information, such as the production number and lot number, on cell lines. Or, it can be used together with the V530-R150E-3/V530-R150EP-3 Fixed 2-Dimensional Code Reader as an ideal combination for automated lines.

Enables Easy Problem Analysis

Using the Console and Monitor, the 2-dimensional code reading condition can be checked on-the-spot. Up to 24 NG images can also be stored in memory for use in troubleshooting reading problems.

For example, the finder pattern, cell recognition and reading data can be viewed on the Monitor.



Finder pattern (cutting symbol)

The shape of this pattern, which is used to detect the position of the 2-dimensional code, differs for each type of code.

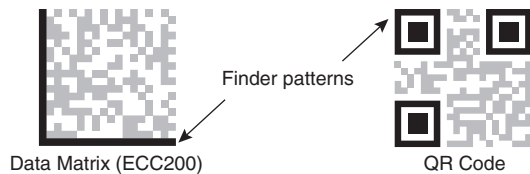

Easy Optimization

Optimal settings can be easily made by setting the DIP switch on the Controller and then reading the target 2-dimensional code. More detailed settings can be made by using the Console and Monitor.

STEP 1

Use the Controller DIP switch to select the matrix size (Data Matrix) or symbol color (QR Code).

STEP 2

Read the target 2-dimensional code.

STEP 3

When the Reading Complete signal sounds and the green LED illuminates, the setting procedure is finished.

Applications

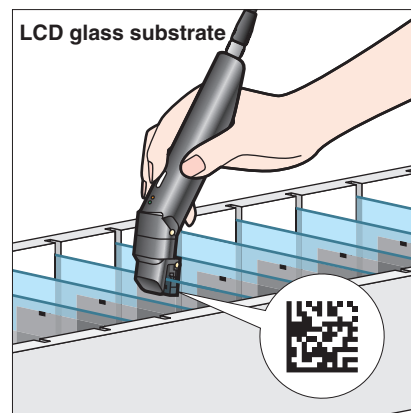
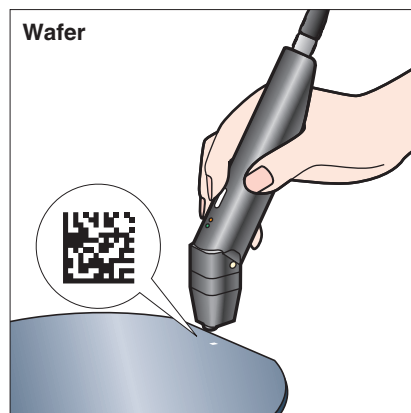
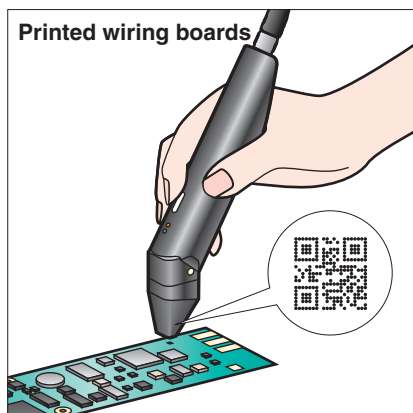

Ordering Information

List of Models

Name		Model
Handheld Reader	Coaxial Lighting Model	V530-H301
	Oblique Lighting Model	V530-H302
	Back Lighting Model	V530-H303
Controller		V530-C300E
Handheld Reader Cable (2 m)		V530-W001

Optional Models

Name	Model
Console	F150-KP-2D
Monitor Cable (2 m)	F150-VM-2D
LCD Monitor	F150-M05L-2D
Video Monitor	F150-M09-2D

Specifications

Handheld 2-Dimensional Code Reader

Item		Model		
		V530-H301	V530-H302	V530-H303
Performance specifications	Field of vision	3 × 3 mm	6 × 6 mm	6 × 6 mm
	Resolution	50 μm	100 μm	100 μm
	Lighting method	Coaxial lighting	Oblique lighting	Back lighting
	Reading method	Touch		
General specifications	Ambient operating temperature	0 to 38°C (with no icing or condensation)		
	Ambient operating humidity	35% to 85% (with no condensation)		
	Ambient operating environment	No corrosive gases		
	Storage temperature	-25 to 60°C		
Weight		Approx. 100 g (not including cable)		
Case material		ABS resin (reading section: POM)		

■ Controller

Item		V530-C300E
Performance specifications	Readable codes	Data Matrix (ECC200): 10 × 10 to 26 × 26 QR Code (Models 1, 2): Versions 1 to 6 (21 × 21 to 41 × 41)
	Interface	RS-232C
General specifications	Ambient operating temperature	0 to 50°C (with no icing or condensation)
	Ambient operating humidity	35% to 85% (with no condensation)
	Ambient operating environment	No corrosive gases
	Storage temperature	-25 to 60°C
	Power supply voltage	24 VDC (+10%, -15%)
	Current consumption	0.5 A
Number of pixels (resolution)		512 (H) × 484 (V)
Number of scenes		2
Image memory function		Maximum of 24 images stored.
Operation method		Menu selectable
Processing method		Gray
Readable direction		360°
Monitor interface		1 channel (over scan monitor)
Weight		Approx. 500 g
Case material		ABS/PC resin

■ Handheld Reader Cable

Item		V530-W001
Ambient operating temperature		0 to 50°C (with no icing or condensation)
Ambient operating humidity		35% to 85% (with no condensation)
Ambient operating environment		No corrosive gases
Storage temperature		-25 to 60°C
Length		2 m
Cover material		Polyvinyl chloride resin

System Configuration

Handheld 2-Dimensional Code Readers



Select the model that best matches the marked material.

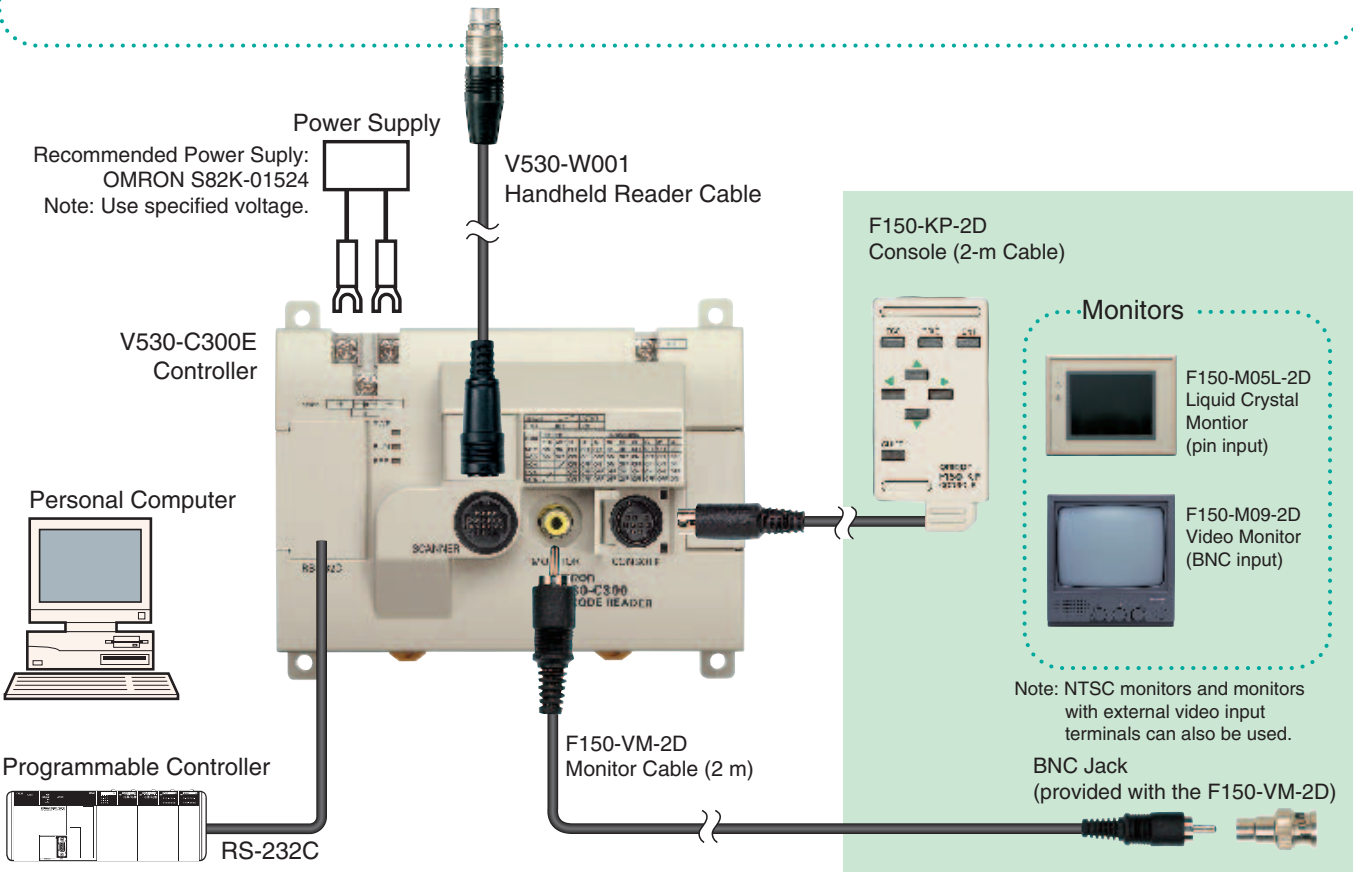

The products inside the green box are optional.

Note: The F150-M09-2D does not conform to EC Directives.

Model Selection

Select the Handheld Reader that best matches the marked material.

Coaxial Lighting Model V530-H301

For directly marked items with mirror-like surfaces, such as wafers, or LCD glass substrates, stable reading can be achieved with the Coaxial Lighting Model because it detects only regular reflected light.

Application Examples

Codes on wafers or LCD glass substrates.

A 2-dimensional code on wafer



Read image

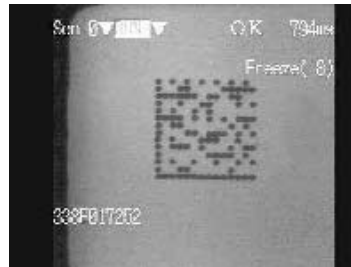

Oblique Lighting Model V530-H302

For laser-marked codes on comparatively glossy surfaces such as printed wiring boards or metal parts, or for codes printed onto highly diffusing surfaces such as paper, stable reading can be achieved with the Oblique Lighting Model.

Application Examples

Labels or directly marked printed wiring boards or electronic parts

A 2-dimensional code on a printed wiring board



Read image



Back Lighting Model V530-H303

For transparent objects such as glass substrates and lenses, a stable, high-contrast image can be obtained by using the Back Lighting Model to detect differences between the transmitted and interrupted light.

Application Examples

Codes on transparent objects such as glass substrates and lenses.

A 2-dimensional code on a glass substrate



Read image

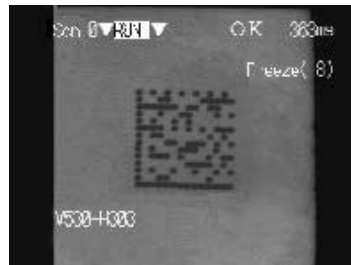

Dimensions

Note: All units are in millimeters unless otherwise indicated.

Handheld 2-Dimensional Code Reader

V530-H301

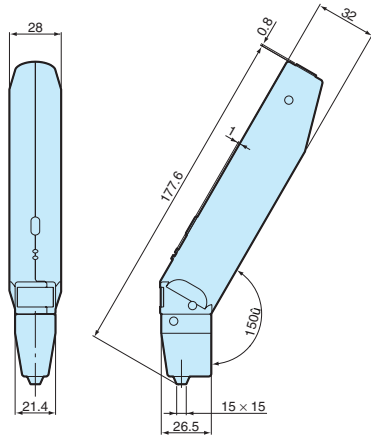

V530-H302

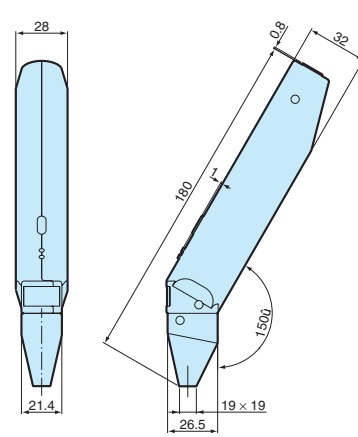

V530-H303

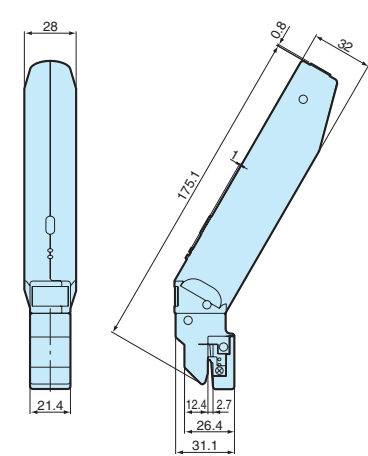

Controller

V530-C300E

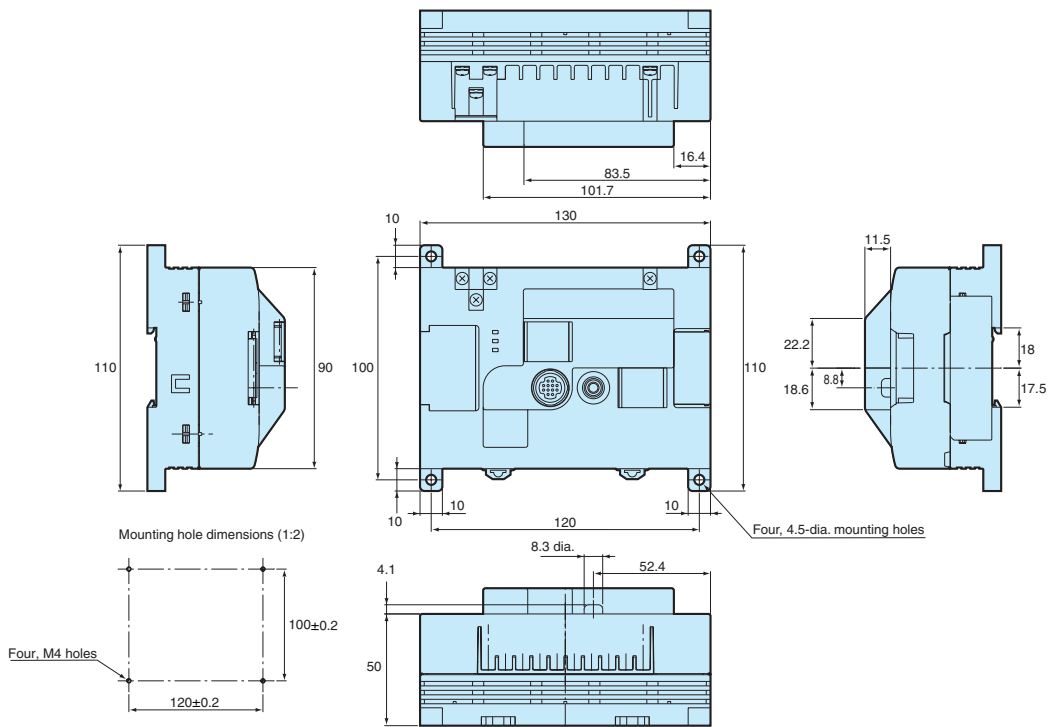

Handheld Reader Cable

V530-W001

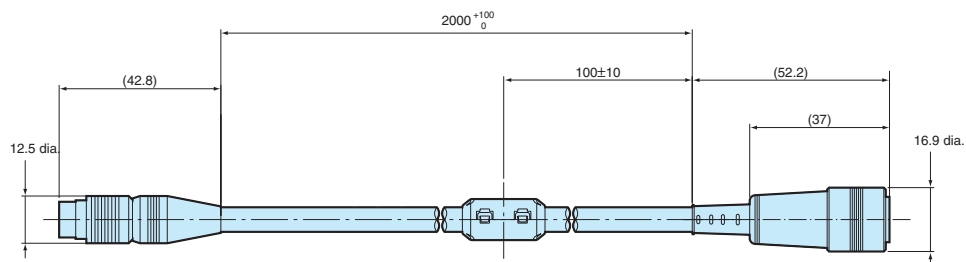

ALL DIMENSIONS SHOWN ARE IN MILLIMETERS.
 To convert millimeters into inches, multiply by 0.03937. To convert grams into ounces, multiply by 0.03527.