

**H8GN**

**Preset Counter/Timer**

**USER'S MANUAL**

**OMRON**

# Preface

---

The H8GN supports serial communications specifications, CompoWay/F and Sysway.

This User's Manual describes the communications functions of the H8GN.

Before using your H8GN thoroughly read and understand this manual in order to ensure correct use.

Also, store this manual in a safe place so that it can be retrieved whenever necessary.

© **OMRON, 2000**

All rights reserved. No part of this publication may be reproduced, stored in a retrieval system or transmitted, in any form, or by any means, mechanical, electronic, photocopying, recording, or otherwise, without the prior written permission of OMRON.

No patent liability is assumed with respect to the use of the information contained herein. Moreover, because OMRON is constantly striving to improve its high-quality products, the information contained in this manual is subject to change without notice. Every precaution has been taken in the preparation of this manual. Nevertheless, OMRON assumes no responsibility for errors or omissions. Neither is any liability assumed for damages resulting from the use of the information contained in this publication.

## PRECAUTIONS

When the product is used under the circumstances or environments described in this manual always adhere to the limitations of the rating and functions. Also, for safety, take countermeasures such as fitting fail-safe installations.

### **DO NOT USE:**

- In circumstances or environments that have not been described in this manual.
- For control in nuclear power, railway, aircraft, vehicle, incinerator, medical, entertainment, or safety applications
- Where death or serious property damage may occur, or where extensive safety precautions are required.

# SAFETY PRECAUTIONS

## ■ Safety Signal Words

This manual uses the following signal words to mark safety precautions for the H8GN. These precautions provide important information for the safe application of the product. You must be sure to follow the instructions provided in all safety precautions.



**CAUTION**

Indicates information that, if not heeded, could result in relatively serious or minor injury, damage to the product, or faulty operation.

## ■ Safety Precautions



**CAUTION**

### ● Electric Shock Warning

Tighten the terminal screws properly. Loose screws may cause ignition and malfunction.  
Tightening torque :0.5 N·m max.

Do not operate this product in flammable and explosive gas atmospheres.

The life expectancy of the output relays varies greatly with the switching capacity and other switching conditions. Always use the output relays within their rated load and electrical life expectancy. If an output relay is used beyond its life expectancy, its contacts may become fused or burned.

Never disassemble, repair or modify the product.  
Doing so may cause electric shock, fire or malfunction.

Do not allow metal fragments or lead wire scraps to fall inside this products.  
These may cause leak of electricity, fire or malfunction.

## NOTICE

### **Be sure to observe these precautions to ensure safe use.**

- (1) When storing the H8GN, make sure that the ambient temperature and humidity are within the rated values. Leave the H8GN at room temperature for at least three hours before using the H8GN if it has been stored at an ambient temperature of  $-10^{\circ}\text{C}$  or below.
- (2) Do not use the H8GN in the following locations.
  - Locations with excessive vibration or shock.
  - Locations where the H8GN is exposed to sprayed water or oil.
- (3) Do not use the H8GN in dusty environments or expose it to corrosive gases or direct sunlight.
- (4) Be sure to use the H8GN according to its rated ambient operating temperature and humidity ranges.
- (5) Make sure that the voltage is applied within the specified range. Otherwise the internal elements of the H8GN may be damaged.
- (6) When using the H8GN in an area with excess electronic noise, separate the H8GN, wiring, and the equipment which generates the input signals as far as possible from the noise sources. It is also recommended to shield the input signal wiring to prevent electronic interference.
- (7) If the H8GN is used in locations with high static electricity, such as sites with pipes transporting molding materials, powders, or liquids, be sure to separate the H8GN from all sources generating static electricity.
- (8) Organic solvents (such as paint thinner), as well as very acidic or basic solutions can damage the outer casing of the H8GN.

## NOTICE

- (1) Do not use the H8GN in the following locations:
  - Locations with high humidity that may result in condensation
  - Locations with radical temperature changes
- (2) Pay the utmost attention not to make mistakes in polarity when wiring the Timer.
- (3) Always maintain the power supply voltage within the specifications.
- (4) Connect the power supply voltage through a relay or switch in such a way that the voltage reaches a fixed value at once. Otherwise, the H8GN may not be reset or outputs may turn ON.
- (5) Be sure that the capacity of the power supply is large enough, otherwise the H8GN may not start due to inrush current (Approx. 15A) that may flow for an instant when the H8GN is turned on.
- (6) For the power supply of an input device for the H8GN, use an isolating transformer with the primary and secondary windings mutually isolated and the secondary winding not grounded.
- (7) Leaving the H8GN with outputs ON at a high temperature for a long time may hasten the degradation of internal parts (such as electrolytic capacitors). For this reason, by using in combination with relays, avoid situations where outputs are left ON for a long time (e.g. one month or more).
- (8) If the watertight rubber packing is not compressed sufficiently, water may penetrate the panel. For this reason, be sure to tighten the reinforcement screws of the Mounting Adapter (Y92F-34).

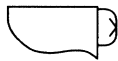

- (9) The output contacts are SPST-NO and SPST-NC. For this reason, be sure not to use these contacts in circuits that will result in 3-point short-circuits (power supply short-circuiting due to arcing).
- (10) In counter operation:
  - Changing the set value  
When changing the set value during operation, the output will turn ON if the set value equals the present value.
  - Operation with set value and present value of 0  
The output will turn ON if the set value of 0 equals the present value. The output will be OFF while the Reset Key is pressed or the reset input is ON.
- (11) In timer operation:
  - Changing the set value  
When changing the set value during operation, the H8GN operates in the same way as when the present value reached the set value because a constant read-in system is in use. And output may turn ON depending on the output mode if the set value is changed as follows:  
  
Input mode UP:            Present value  $\square$  Set value  
Input mode DOWN:        Elapsed time  $\square$  Set value (Present value=0)
  - Note:** When in DOWN mode, the amount set value is changed is added to or subtracted from the present value.
  - Operation with set value of 0
    - a) When the output mode is set to A, B (one-shot output), D, or F, output will turn ON when the start signal is input.
    - b) When the output mode is set to B (hold output), E, or Z, output will remain OFF even when the start signal is input.

(12) To allow for the startup time of peripheral devices (sensors, etc.), the H8GN starts timing operation between 210 to 260 ms after power is turned ON. For this reason, in operations where timing starts from power ON, the time display will actually start from 258 ms. If the set value is 258 ms or less, the time until output turns ON will be a fixed value between 210 and 260. (Normal operation is possible for set value of 259 ms or more.) In applications where a set value of 258 ms or less is required, use start timing with signal input.

# Table of Contents

---

Preface .....	I
Precautions .....	II
Safety Precautions .....	III
Notice .....	IV
Notice .....	V

## CHAPTER 1 ABOUT COMMUNICATIONS METHODS ..... 1-1

This chapter briefly describes the supported communications methods and how to wire equipment. First-time users should read this chapter without fail to ensure proper installation of the equipment.

1.1 Outline .....	1-2
Introduction .....	1-2
Communications specifications .....	1-2
Transmission procedure .....	1-3
Interface .....	1-3
Wiring .....	1-3
Communications parameters .....	1-4

## CHAPTER 2 COMPOWAY/F COMMUNICATIONS PROCEDURES ..... 2-1

Read this chapter if you are to communicate using the CompoWay/F format.

2.1 Data Format .....	2-2
Command frame .....	2-2
Response frame .....	2-3
Communications data .....	2-4
Example of end code .....	2-4
2.2 Structure of Command Text .....	2-5
PDU structure .....	2-5
Area definitions .....	2-5
Type code (variable type) .....	2-5
Addresses .....	2-5
Number of elements .....	2-5
List of services .....	2-6
2.3 Details of Services .....	2-7
Read from variable area .....	2-7
Write to variable area .....	2-8
Read controller attributes .....	2-10
Read controller status .....	2-11
Echoback test .....	2-12
Operation instructions .....	2-13
2.4 Response Code List .....	2-15



CHAPTER 3 COMMUNICATIONS DATA ..... 3-1

This chapter lists the details of each of the communications data in the Compo-Way/F communications procedures.

3.1 Variable Area (setup range) List ..... 3-2

3.2 Status ..... 3-6

3.3 Sample Program ..... 3-9

APPENDIX ..... A-1

ASCII List ..... A-2

INDEX

# CHAPTER 1

## ABOUT COMMUNICATIONS METHODS

This chapter briefly describes the supported communications methods and how to wire equipment. First-time users should read this chapter without fail to ensure proper installation of the equipment.

1.1	Outline .....	1-2
	Introduction .....	1-2
	Communications specifications .....	1-2
	Transmission procedure .....	1-3
	Interface .....	1-3
	Wiring .....	1-3
	Communications parameters .....	1-4

## 1.1 Outline

### ■ Introduction

The program for the communications functions are created on the host computer, and the H8GN's parameters are monitored or set from the host computer. Therefore, the description provided here is from the viewpoint of the host computer.

CompoWay/F is OMRON's standard communications format for general serial communications. This format uses a standard frame format as well as the FINS\* commands which have proven successful in OMRON's PLCs. Therefore, it can simplify communications between components and the host computer.

\* FINS (Factory Interface Network Service)

The FINS protocol provides message communications between controllers in OMRON FA networks.

The H8GN have the following communications functions:

- Reading/writing of parameters
- Operation instructions
- Selection of setup levels

Communications are subject to the following condition:

- Parameters can be written only when the "communications writing" parameter is set to ON (enabled).

### ■ Communications specifications

Transmission line connection	Multiple point
Communications method	RS-485 (2-wire, half-duplex)
Synchronization method	Start-stop synchronization
Baud rate *1	1200, 2400, 4800, <b>9600</b> (bit /s)
Communication code	ASCII
Data bits *1	<b>7</b> or 8 bits
Stop bits *1	1 or <b>2</b> bits
Error detection	Vertical parity (non, <b>even</b> , or odd) BCC (block check character)
Flow control	None
Interface	RS-485
Retry function	None
Communications buffer	40 byte

\*1 Baud rate, data bits, stop bits and vertical parity can each be set independently in the communications setting level. Highlighted characters in the table above indicate defaults.

## Transmission procedure

When the host computer transmits a command frame, the H8GN transmits a response frame that corresponds to the command frame. A single response frame is returned for each command frame. The following diagram shows the operation of the command and response frames.

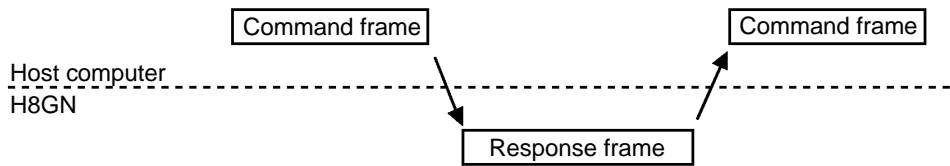

Allow a wait time of at least 2 ms until the next command is sent after the host computer receives a response from the H8GN.

## Interface

Communications with the host computer are carried out through a standard RS-485 interface.

## Wiring

- RS-485 connections can be 1 : 1 or 1 : N. A maximum of 32 Units (including the host computer) can be connected in one-to-N systems.
- The total cable length is 500 m max.
- Use a shielded, twisted-pair cable AWG28 or larger for wiring the H8GN.

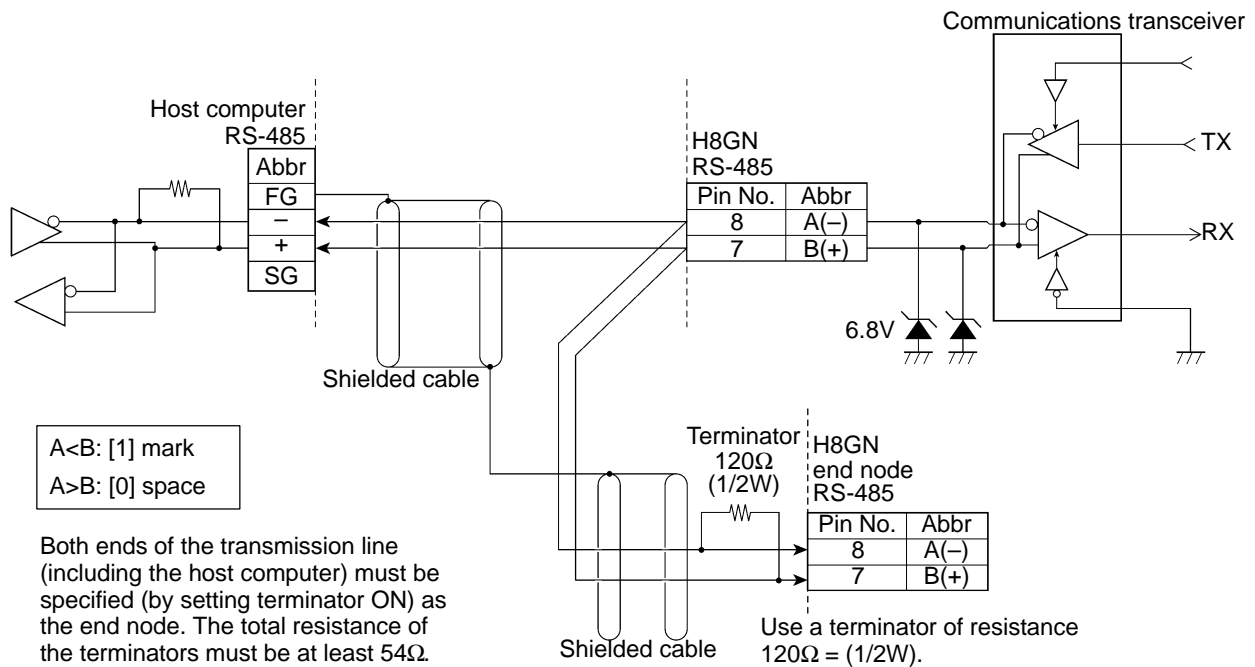

Match the communications specifications of the H8GN and the host computer. If a one-to-N system is being used, be sure that the communications specifications of all devices in the system (except individual unit numbers) are the same.

## ■ Communications parameters

The H8GNs communications specifications are set in the communications setting level. These parameters are set on the H8GNs front panel.





The following table shows the communications parameters and their setting ranges.

Parameter	Displayed Characters	Setting Range	Set Value
Communications unit No.	U-nā	0 to 99	0, <b>1</b> to 99
Baud rate	bPS	1.2 / 2.4 / 4.8 / 9.6 (k bit/s)	1.2 / 2.4 / 4.8 / <b>9.6</b> (k bit/s)
Communications data length	LEn	7 / 8 (bit)	<b>7</b> / 8 (bit)
Communications stop bit	SbLt	1 / 2	1 / <b>2</b>
Communications parity	Prty	None / even / odd	nānE / <b>EVEN</b> / odd

Highlighted characters indicate defaults.

## ● Communications parameter setup

Before you carry out communications with the H8GN, set up communications unit No., Communication rate and other parameters by carrying out the following procedure.

- (1) Hold down the  key for at least three seconds to move from the “operation level” to the “initial setting level.”
- (2) Press the  key for less than one second to move from the “initial setting level” to the “communications setting level.”
- (3) Select the parameters as shown below by pressing the  key.
- (4) Use the  or  keys to change the parameter set values.

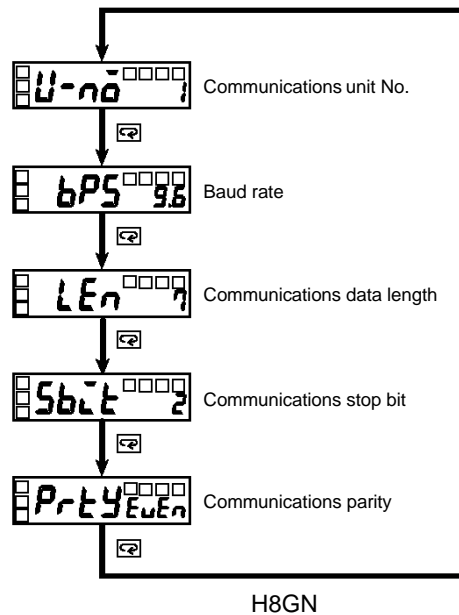

---

## ● Communications parameter setup

Note that communications parameters are enabled after they have been changed by resetting the controller.

- Communications unit No. (U- $\bar{n}\bar{a}$ )

This parameter is for setting the unit No. to each of the H8GN. This unit No. is set so that the host computer can identify the H8GN when communications are carried out with the host computer. Set a unit No. within the range 0 to 99 for each H8GN connected to the host computer on the network. Default is "1". When two or more H8GN are used, do not set the same unit No. Doing so will prevent normal operation.

- Baud rate (b $\bar{P}\bar{5}$ )

This parameter is for setting the baud rate when communicating with the host computer. Set one of "1.2 (1200 bit/s)", "2.4 (2400 bit/s)", "4.8 (4800 bit/s)" and "9.6 (9600 bit/s)".

- Communications data length (L $\bar{E}\bar{n}$ )

This parameter is for setting the communications data length. Set either of "7 bits" or "8 bits".

- Communications stop bit (S $\bar{b}\bar{L}\bar{L}$ )

This parameter is for setting the communications stop bit. Set either of "1" or "2".

- Communications parity (P $\bar{r}\bar{L}\bar{Y}$ )

This parameter is for setting the communications parity. Set one of "none", "even" or "odd".



# CHAPTER 2

## *CompoWay/F* COMMUNICATIONS PROCEDURES

Read this chapter if you are to communicate using the CompoWay/F format.

2.1	Data Format .....	2-2
	Command frame .....	2-2
	Response frame .....	2-3
	Communications data .....	2-4
	Example of end code .....	2-4
2.2	Structure of Command Text .....	2-5
	PDU structure .....	2-5
	Area definitions .....	2-5
	Type code (variable type) .....	2-5
	Addresses .....	2-5
	Number of elements .....	2-5
	List of services .....	2-6
2.3	Details of Services .....	2-7
	Read from variable area .....	2-7
	Write to variable area .....	2-8
	Read controller attributes .....	2-10
	Read controller status .....	2-11
	Echoback test .....	2-12
	Operation instructions .....	2-13
2.4	Response Code List .....	2-15



## 2.1 Data Format

Unless otherwise indicated, numbers in this manual are expressed in hexadecimal. Values in double quotation marks, such as “00”, are ASCII.

The number underneath each delimiter in a frame indicates the number of bytes.

### ■ Command frame

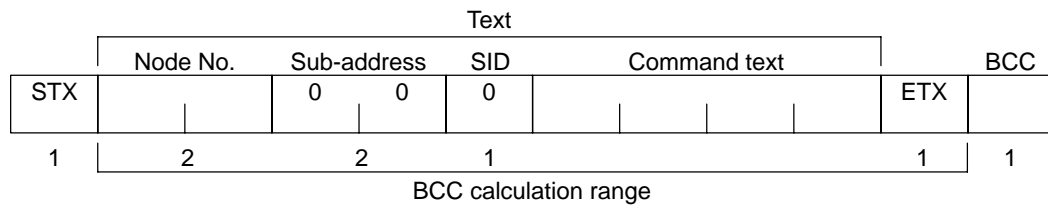

STX	This code (02) indicates the beginning of the communications frame (text). Always set this character in the first byte. When STX is received again during reception, reception is carried out again from the point where STX was received.
Node number	<ul style="list-style-type: none"> <li>• This number specifies the transmission's destination.</li> <li>• Specify the H8GN's "Communications unit No."</li> <li>• BCD range "00" to "99" and "XX" can be set.</li> <li>• Specify "XX" for a broadcast transmission. No response will be returned for broadcast transmissions.</li> <li>• No responses will be returned from node Nos. set otherwise from the above.</li> </ul>
Sub-address	This is not used on the H8GN. Be sure to set the sub-address to "00".
SID (service ID)	This is not used on the H8GN. Be sure to set the sub-address to "00".
Command text	Command text area. For details, see "2.2 Structure of Command Text."
ETX	This code (03) indicates the end of the text.
BCC	Block Check Character The BCC result is found by calculating the exclusive OR of the bytes from the node No. up to ETX.

### ● BCC calculation example

The BCC is formed by converting the 8-bit value obtained by converting the exclusive OR of the node No. up to ETX into two ASCII characters, and setting this to the BCC area.

STX	Node No.		Sub-address		SID	Command text				ETX	BCC
02H	0(30H)	0(30H)	0(30H)	0(30H)	0(30H)	0(30H)	5(35H)	0(30H)	3(33H)	03H	35H

$$\text{BCC} = 30\text{H} \oplus 30\text{H} \oplus 30\text{H} \oplus 30\text{H} \oplus 30\text{H} \oplus 30\text{H} \oplus 35\text{H} \oplus 30\text{H} \oplus 33\text{H} \oplus 03\text{H} = 35\text{H}$$

Calculation result 35H is set to the BCC area.

The  $\oplus$  symbol indicates exclusive OR operation and the H indicates hexadecimal code.

### ■ Response frame

STX	Node No.		Sub-address		End code	Command text				ETX	BCC
1	2	2	2	2						1	1

End code	Name	Description	Error Detection Priority
00	Normal completion	The command ended normally without error.	None
0F	FINS command error	The specified FINS command could not be executed. The FINS response code should indicate why the command could not be executed.	8
10	Parity error	The sum total of bits whose received data is "1" does not match the set value of "communications parity."	2
11	Framing error	Stop bit is "0".	1
12	Overrun error	An attempt was made to transfer new data when the reception data was already full.	3
13	BCC error	The calculated BCC value is different from the received BCC value.	5
14	Format error	<ul style="list-style-type: none"> <li>The command text contains characters other than 0 to 9, and A to F. This error is not applicable to the echoback test. (For details, see chapters 2.3 "Echoback test.")</li> <li>No SID and command text. Or, no command text</li> <li>"MRC/SRC" not included in command text</li> </ul>	7
16	Sub-address error	<ul style="list-style-type: none"> <li>Illegal (unsupported) sub-address</li> <li>No sub-address, SID and command text</li> <li>Sub-address less than two characters, and no SID and command text</li> </ul>	6
18	Frame length error	The received frame exceeds the fixed (supported) number of bytes.	4

- The end code is returned to received command frames addresses to the self node.
- No response will be returned if all the items in the response frame are incomplete up to the ETX and BCC.
- "Error Detection Priority" indicates the priority when two or more errors occur simultaneously.

## ■ Communications data

Set (monitor) Value	Minus Value	Decimal point
8 digits (Hex)	2's complement	Decimal point is removed and the result is converted to hexadecimal. Example) 105.0 → 1050 → 000041A

## ■ Example of end code

The following examples show an end code when a command did not end normally.

Example 1) Illegal sub-address, and no SID and command text

Command Format

	Node No.	Sub-address	BCC
STX		0   A	ETX

Response Format

	Node No.	Sub-address	End code	BCC
STX		0   A	1   6	ETX

End code is "16" (sub-address error).

This is because a sub-address was received and the sub-address error has a higher error detection priority than the format error.

Example 2) No command text

Command Format

	Node No.	Sub-address	SID	BCC
STX		0   0	0	ETX

Response Format

	Node No.	Sub-address	End code	BCC
STX		0   0	1   4	ETX

End code is "14" (format error).

Example 3) All node Nos. not provided

Command Format

	BCC
STX	ETX

The node No. is lacking one character.

Response Format

No response

Example 4) No sub-address, and illegal BCC

Command Format

	Node No.	BCC
STX		ETX   Err

Response Format

	Node No.	Sub-address	End code	BCC
STX		0   0	1   3	ETX

Sub-address is "00" and end code is "13" (BCC error).

## 2.2 Structure of Command Text

### ■ PDU structure

An MRC (Main Request Code) and SRC (Sub-Request Code) followed by the various required data is transferred to the command text.

Service request PDU



MRES (Main Response Code) and SRES (Sub-Response Code) are transferred following the above MRC/SRC. Data is then transferred following these MRES and SRES.

Service response PDU (during normal operation)

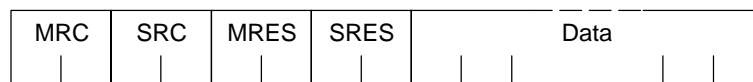

If the specified command text could not be executed, only the MRC/SRC and MRES/SRES become the target response PDUs.

Service response PDU (at non-execution of specified command text)

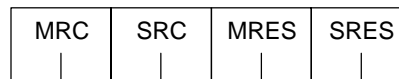

MRES/SRES becomes the response code except when processing ends in “normal completion.”

### ■ Area definitions

Areas comprise only variable area.

### ■ Type code (variable type)

The following defines variable area type codes.

Variable type	Description
C0	R/O (read only) parameter.
C1	Protect level parameter.
C2	Operation and adjustment level parameter.
C3	Initial setting, communications setting and advanced function setting level parameter.

### ■ Addresses

Each of the variable types is appended with an address. Express addresses in 2-byte hexadecimal code.

### ■ Number of elements

The number of elements is expressed in 2-byte hexadecimal code. Specify the number of elements within the range “0 to 2”.  
For example, when the number of elements is “0002”, specify data for two items from the address.

■ List of services

MRC	SRC	Name of service	Process
01	01	Read from variable area	This service reads from variable areas.
01	02	Write to variable area	This service writes to variable areas.
05	03	Read controller attributes	This service reads the model No. and communications buffer size.
06	01	Read controller status	This service reads the run status of the controller.
08	01	Echoback test	This service carries out the echoback test.
30	05	Operation instructions	This service carries out reset, communications writing, multi-SP, move to protect level, move to setup area 1 and software reset.

\* In a memory error (RAM error) or initial state (until the control starts normally after the power is turned ON), all commands will not be accepted, and no response will be returned.

The following table summarizes setup areas 0 and 1.

Area	Description
Setup area 0	This area groups together the protect, operation and adjustment levels.
Setup area 1	This area groups together the initial setting, communications setting and advanced function setting levels.

## 2.3 Details of Services

### ■ Read from variable area

This service reads from variable areas.

Service request PDU

MRC	SRC	Variable type	Read start address	Bit position	Number of elements
0   1	0   1			0   0	
2	2	2	4	2	4

Service response PDU

MRC	SRC	Response code	Read data (for number of elements)
0   1	0   1		
2	2	4	0 or 8 or 16

- (1) Variable type and read start address  
For details on variable types and read start addresses, see “Chapter 3 Communications Data.”
- (2) Bit position  
Bit accessing is not supported on the H8GN. Fixed to “00”.
- (3) Number of elements

Number of elements	Process
0000	Read is not carried out (the service response PDU is not appended with read data), and processing ends in “normal completion.”
0001 to 0002	Read is carried out, and processing ends in “normal completion.”

- (4) Response code  
At normal completion

Response code	Name	Description
0000	Normal completion	No errors were found.

At occurrence of error

Response code	Error name	Cause
1001	Command too long	The command is too long.
1002	Command too short	The command is too short.
1101	Area type error	The variable type is wrong.
1103	Start address out-of-range error	The read start address is out of range.
110B	Response too long	The number of elements is larger than “0002”.
1100	Parameter error	The bit position is other than “00”.
2203	Operation error	CPU or EEPROM error

**Write to variable area**

This service writes to variable areas.

Service request PDU

MRC	SRC	Variable type	Read start address	Bit position	Number of elements	Write data (for number of elements)
0   1	0   2			0   0		
2	2	2	4	2	4	0 or 8 or 16

Service response PDU

MRC	SRC	Response code
0   1	0   2	
2	2	4

- (1) Variable type and write start address  
For details on variable types and write start addresses, see “Chapter 3 Communications Data.”
- (2) Bit position  
Bit accessing is not supported on the H8GN. Fixed to “00”.
- (3) Number of elements

Number of elements	Process
0000	Write is not carried out (the service response PDU is not appended with write data), and processing ends in “normal completion.”
0001 to 0002	Write is carried out, and processing ends in “normal completion.”

(4) Response code

At normal completion

Response code	Name	Description
0000	Normal completion	No errors were found.

At occurrence of error

Response code	Error name	Cause
1002	Command too short	The command is too short.
1101	Area type error	Wrong variable type
1103	Start address out-of-range error	Write start address is out of range.
1104	End address out-of-range error	The write end address (write start address + number of elements) exceeds the final address of the variable area.
1003	Number of elements/data mismatch	The number of data does not match the number of elements.
1100	Parameter error	<ul style="list-style-type: none"> <li>• Bit position is other than "00".</li> <li>• Write data is out of setting range.</li> </ul>
3003	Read-only data	Variable type "C0" was written to.
2203	Operation error	<ul style="list-style-type: none"> <li>• The "communications writing" parameter is set to "OFF" (disabled).</li> <li>• Writing was carried out on the parameters from setup areas 0 to 1.</li> <li>• Writing was carried out on a protected parameter other than in the protect level.</li> <li>• CPU or EEPROM error</li> </ul>



**Read controller attributes**

This service reads the model No. and communications buffer size.

Service request PDU

MRC	SRC
0   5	0   3
2	2

Service response PDU

MRC	SRC	Response code	Model No.	Communications buffer size
0   5	0   3			0   0   2   8
2	2	4	10	4

(1) Model No.

The model No. is expressed in 10-byte ASCII code. Empty bytes are space codes.

**Example:**

The model number for the H8GN is expressed as follows:

H	8	G	N	-	A	D			
---	---	---	---	---	---	---	--	--	--

(2) Communications buffer size

The communications buffer size is expressed in 2-byte hexadecimal code, and read after being converted to 4-byte ASCII code.

Buffer size: 40 bytes (= H'0028)

(3) Response code

At normal completion

Response code	Name	Description
0000	Normal completion	No errors were found.

At occurrence of error

Response code	Name	Description
1001	Command too long	The command is too long.
2203	Operation error	CPU or EEPROM error

## ■ Read controller status

This service reads the run status of the controller.

Service request PDU

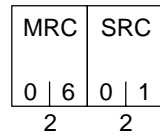

Service response PDU

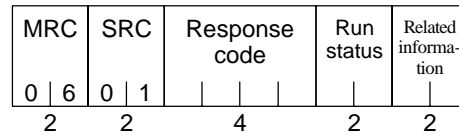

### (1) Run status

Run status	Description
00	Status in which the count (timer) input can be accepted (error not generated when setup area is 0)
01	Status in which the count (timer) input cannot be accepted (other than above)

### (2) Related information

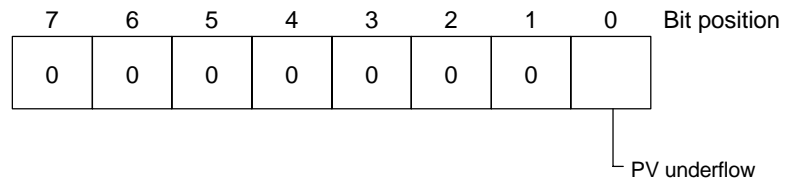

### (3) Response code

At normal completion

Response code	Name	Description
0000	Normal completion	No errors were found.

At occurrence of error

Response code	Name	Description
1001	Command too long	The command is too long.
2203	Operation error	CPU or EEPROM error

## ■ Echoback test

This service carries out the echoback test.

Service request PDU

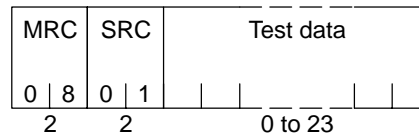

Service response PDU

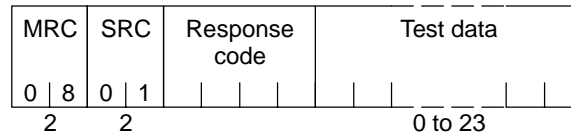

(1) Test data

Set any test data within the range “0” to “23”.

Set a value for the test data within the ranges shown below according to the communications data length.

Communications data length	Test data
8 bits	20 to 7E, A1 to FE converted to ASCII code
7 bits	20 to 7E converted to ASCII code

(2) Response code

At normal completion

Response code	Name	Description
0000	Normal completion	No errors were found.

At occurrence of error

Response code	Name	Description
1001	Command too long	The command is too long.
2203	Operation error	CPU or EEPROM error

## ■ Operation instructions

This service carries out reset, communications writing, multi-SP, move to protect level, move to setup area 1 and software reset.

### Service request PDU

MRC	SRC	Instruc- tion code	Related in- forma- tion
3   0	0   5		
2	2	2	2

### Service response PDU

MRC	SRC	Response code
3   0	0   5	
2	2	4

#### (1) Instruction code and related information

Instruction code	Description	Related information
00	Communications writing	00: OFF (disabled) 01: ON (enabled)
01	Reset	00: Reset PV 01: Reset totalizing count value 02: Reset PV/totalizing count value
02	SV-bank	00: Set value 0 01: Set value 1 02: Set value 2 03: Set value 3
06	Software reset *	00
07	Move to setup area 1	00
08	Move to protect level	00

\* No response will be returned when a software reset is carried out.

#### (2) Response code

At normal completion

Response code	Name	Description
0000	Normal completion	No errors were found.

At occurrence of error

Response code	Error name	Cause
1001	Command too long	The command is too long.
1002	Command too short	The command is too short.
1100	Parameter error	Instruction code and related information are wrong.
2203	Operation error	<ul style="list-style-type: none"> <li>The "communications writing" parameter is set to "OFF" (disabled). However, note that the error is accepted regardless of the "communications writing" parameter setting (ON/OFF).</li> <li>The command cannot be processed. For details, see "(3) Description of operating instructions and precautions" below.</li> <li>CPU or EEPROM error</li> </ul>

## (3) Description of operation instructions and precautions

## ● Communications writing

Set the “communications writing” parameter to “ON: enabled” or “OFF: disabled” according to related information. This instruction can be accepted at both setup areas 0 and 1.

## ● Reset

The PV and/or total count value is reset according to the related value.  
[Reset PV]

Resets the “PV.” This can be accepted only in setup area 0. The “operation error” occurs in the following instance:

- When the reset is issued in “setup area 1”

[Reset totalizing count value]

Resets the “totalizing count value.” This can be accepted only in setup area 0. The “operation error” occurs in the following instances:

- When the reset is issued in “setup area 1”
- When “select function” is set to “timer”
- When “use total counter” is set to “OFF”

[Reset PV/totalizing count value]

Resets the “PV” and the “totalizing count value.” This can be accepted only in setup area 0. The “operation error” occurs in the following instances:

- When the reset is issued in “setup area 1”
- When “select function” is set to “timer”
- When “use total counter” is set to “OFF”

## ● SV-bank

Set four set value beforehand in the adjustment level so that you switch to a desired set value. SV-bank can be accepted at both setup areas 0 and 1. The “operation error” occurs in the following instance:

- When “use SV-bank ” is set to “OFF”

## ● Software reset

This instruction resumes processing after the power is turned OFF. This instruction can be accepted at both setup areas 0 and 1. No response will be returned for this operation instruction.

## ● Move to setup area 1

This instruction moves to “setup area 1” and can be accepted at both setup areas 0 and 1. However, note that when “initial setup/communications protection” is set to “2”, an “operation error” is generated, and move to setup area 1 is forbidden.

When this move is carried out from setup area 0, the display indicates the “select function” in the “initial setting level.” When this operation instruction is issued in setup area 1, the display will not change.

## ● Move to protect level

This instruction moves to the “protect level” and can be accepted only in setup area 0. When this instruction command is issued in setup area 1, an “operation error” is generated, and move to setup area 1 is forbidden.

## 2.4 Response Code List

At normal completion

Response code	Name	Description	Error detection priority
0000	Normal completion	No errors were found.	None

At occurrence of error

Response code	Name	Description	Error detection priority
0401	Unsupported command	The service function for the relevant command is not supported.	1
1001	Command too long	The command is too long.	2
1002	Command too short	The command is too short.	3
1101	Area type error	The variable type is wrong.	4
1103	Start address out-of-range error	The read/write start address is out of range.	5
1104	End address out-of-range error	The write end address (write start address + number of elements) exceeds the final address of the variable area.	6
1003	Number of elements/data mismatch	The number of data does not match the number of elements.	7
110B	Response too long	The response exceeds the communications buffer size (when larger than number of elements 0002).	8
1100	Parameter error	<ul style="list-style-type: none"> <li>• The bit position is other than "00".</li> <li>• The write data is out of the setting range.</li> <li>• The instruction code and related information in the operating instruction is wrong.</li> </ul>	9
3003	Read-only error	Variable type "C0" was written to.	10
2203	Operation error	<ul style="list-style-type: none"> <li>• The "communications writing" parameter is set to "OFF" (disabled).</li> <li>• Writing was carried out on the parameters from setup areas 0 to 1.</li> <li>• Writing was carried out on a protected parameter other than in the protect level.</li> <li>• Processing is not possible by operating instruction.</li> <li>• CPU or EEPROM error</li> </ul>	11



# CHAPTER 3

## COMMUNICATIONS DATA

This chapter lists the details of each of the communications data in the CompoWay/F communications procedures.

3.1	Variable Area (setup range) List .....	3-2
3.2	Status .....	3-8
3.3	Sample Program .....	3-9
	N88Basic .....	3-9
	Protocol macro .....	3-11



## 3.1 Variable Area (setup range) List

The following table lists the variable areas. Items expressed in hexadecimal in the “Set (monitor) Value” column are the setting range. Values in parentheses “( )” are the actual setting range.

For details of variable areas that are described not in numerical values but by text, refer to the relevant parameter descriptions.

Variable type	Address	Item	Set (monitor) Value	Level
C0	0000	Version * Note 1	H'00000100	
C0	0001	PV	H'FFFFFFC19 to H'0000270F (–999 to 9999) * Counter * At PV underflow, lower limit value=H'FFFFFFC19 (–999)	Operation
			H'00000000 to H'0000270F (0 to 9999) * Time range at timer=other than - -m- -s, - -h- -m	
			H'00000000 to H'000026E7 (0:00 to 99:59) * Time range at timer=- -m- -s, - -h- -m	
C0	0002	Status * Note 1	See “3.2. Status.”	
C0	0003	Totalizing count value	H'00000000 to H'05F5E0FF (0 to 99999999)	Operation
C1	0000	Operation/adjustment protection	H'00000000 (0): No restrictions in operation and adjustment levels H'00000001 (1): Move to adjustment level restricted H'00000002 (2): Display and change of only PV/SV parameters enabled H'00000003 (3): Display of only PV/SV parameters enabled	Protect
C1	0001	Initial setting/communications protection	H'00000000 (0): Move to initial setting/communications setting level enabled (move to advanced function setting level displayed) H'00000001 (1): Move to initial setting/communications setting level enabled (move to advanced function setting level not displayed) H'00000002 (2): Move to initial setting/communications setting level restricted	
C1	0002	Setting change protection	H'00000000 (0): OFF (changing of setup on controller display enabled) H'00000001 (1): ON (changing of setup on controller display disabled)	
C1	0003	Reset key protection	H'00000000 (0): OFF (reset key enabled) H'00000001 (1): ON (reset key disabled)	

Variable type	Address	Item	Set (monitor) Value	Level
C2	0000	Set value	H'00000000 to H'0000270F (0 to 9999) * Input mode at counter=incremental or decremental	Operation
			H'FFFFFFC19 to H'0000270F (-999 to 9999) * Input mode at counter=individual or phase different input	
			H'00000000 to H'0000270F (0 to 9999) * Time range at timer=other than - -m- -s, - -h- -m and output mode=A,B,D,E,F	
			H'00000000 to H'000026E7 (0:00 to 99:59) * Time range at timer=- -m- -s, - -h- -m and output mode=A,B,D,E,F * Note 2	
			H'00000000 to H'00000064 (0 to 100) * Output mode at timer=Z	
C2	0001	Set value 0	H'00000000 to H'0000270F (0 to 9999) * Input mode at counter=incremental or decremental	Adjustment
			H'FFFFFFC19 to H'0000270F (-999 to 9999) * Input mode at counter=individual or phase different input	
			H'00000000 to H'0000270F (0 to 9999) * Time range at timer=other than - -m- -s, - -h- -m and output mode=A,B,D,E,F	
			H'00000000 to H'000026E7 (0:00 to 99:59) * Time range at timer=- -m- -s, - -h- -m and output mode=A,B,D,E,F * Note 2	
			H'00000000 to H'00000064 (0 to 100) * Output mode at timer=Z	
C2	0002	Set value 1	Same as set value 0	Adjustment
C2	0003	Set value 2	Same as set value 0	
C2	0004	Set value 3	Same as set value 0	
C2	0005	Cycle time	H'00000000 to H'0000270F (0 to 9999) * Time range at timer=other than - -m- -s, - -h- -m	Operation
			H'00000000 to H'000026E7 (0:00 to 99:59) * Time range at timer=- -m- -s, - -h- -m * Note 2	

\* Note 1: This item is not displayed on the controller display.

\* Note 2: Even if the set value is within the setting range, the out-of-range error occurs when the 2nd digit (sexal number) is six or above such as 5:60 (H\*00000230).

Variable type	Address	Item	Set (monitor) Value	Level
C3	0000	Select function	H'00000000(0): Counter H'00000001(1): Timer	Initial setting
C3	0001	Input mode	H'00000000(0): Incremental H'00000001(1): Decremental H'00000002(2): Individual H'00000003(3): Phase difference	
C3	0002	Time range	H'00000000(0): 0.000s to 9.999s H'00000001(1): 0.00s to 99.99s H'00000002(2): 0.0s to 999.9s H'00000003(3): 0s to 9999s H'00000004(4): 0m0s to 99m59s H'00000005(5): 0.0m to 999.9m H'00000006(6): 0h0m to 99h59m H'00000007(7): 0.0h to 999.9h H'00000008(8): 0h to 9999h	
C3	0003	Timer mode	H'00000000(0): Elapsed time H'00000001(1): Remaining time	
C3	0004	Output mode (counter)	H'00000000(0): N H'00000001(1): F H'00000002(2): C H'00000003(3): K	
C3	0005	Output mode (timer)	H'00000000(0): A H'00000001(1): B H'00000002(2): D H'00000003(3): E H'00000004(4): F H'00000005(5): Z	
C3	0006	Output time	H'00000001 to H'0000270F (0.01 to 99.99) * counter H'00000000 to H'0000270F (0.00 to 99.99) * timer	
C3	0007	Counting speed	H'00000000(0): 30Hz H'00000001(1): 5kHz	
C3	0008	Input signal width	H'00000000(0): 20ms H'00000001(1): 1ms	

Variable type	Address	Item	Set (monitor) Value	Level
C3	0009	Decimal point	H'00000000(0): ---- H'00000001(1): ---. H'00000002(2): -.-. H'00000003(3): -.--	Initial setting
C3	000A	Pre-scale value	H'00000001 to H'0000270F (0.001 to 9.999)	
C3	000B	Input signal edge	H'00000000(0): Rise edge H'00000001(1): Fall edge	
C3	000C	Communications unit No. *1	H'00000000 to H'00000063 (0 to 99)	Communications setting
C3	000D	Baud rate *1	H'00000000(0): 1.2 H'00000001(1): 2.4 H'00000002(2): 4.8 H'00000003(3): 9.6	
C3	000E	Communications data length *1	H'00000007(7): 7 H'00000008(8): 8	
C3	000F	Communications stop bit *1	H'00000001(1): 1 H'00000002(2): 2	
C3	0010	Communications parity	H'00000000(0): None H'00000001(1): Even H'00000002(2): Odd	
C3	0011	Use SV-bank	H'00000000(0): OFF H'00000001(1): ON	Advanced function setting
C3	0012	Use totalizing counter	H'00000000(0): OFF H'00000001(1): ON	
C3	0013	Display auto-return time	H'00000000(0): OFF H'00000001 to H'00000063 (1 to 99)	
C3	0014	Move-to-protect-level time	H'00000003 to H'0000001E (3 to 30)	

\* 1: Communications parameters are enabled after they have been changed by turning the power OFF then back ON again.

## 3.2 Status

The figure below shows the structure of the status data:

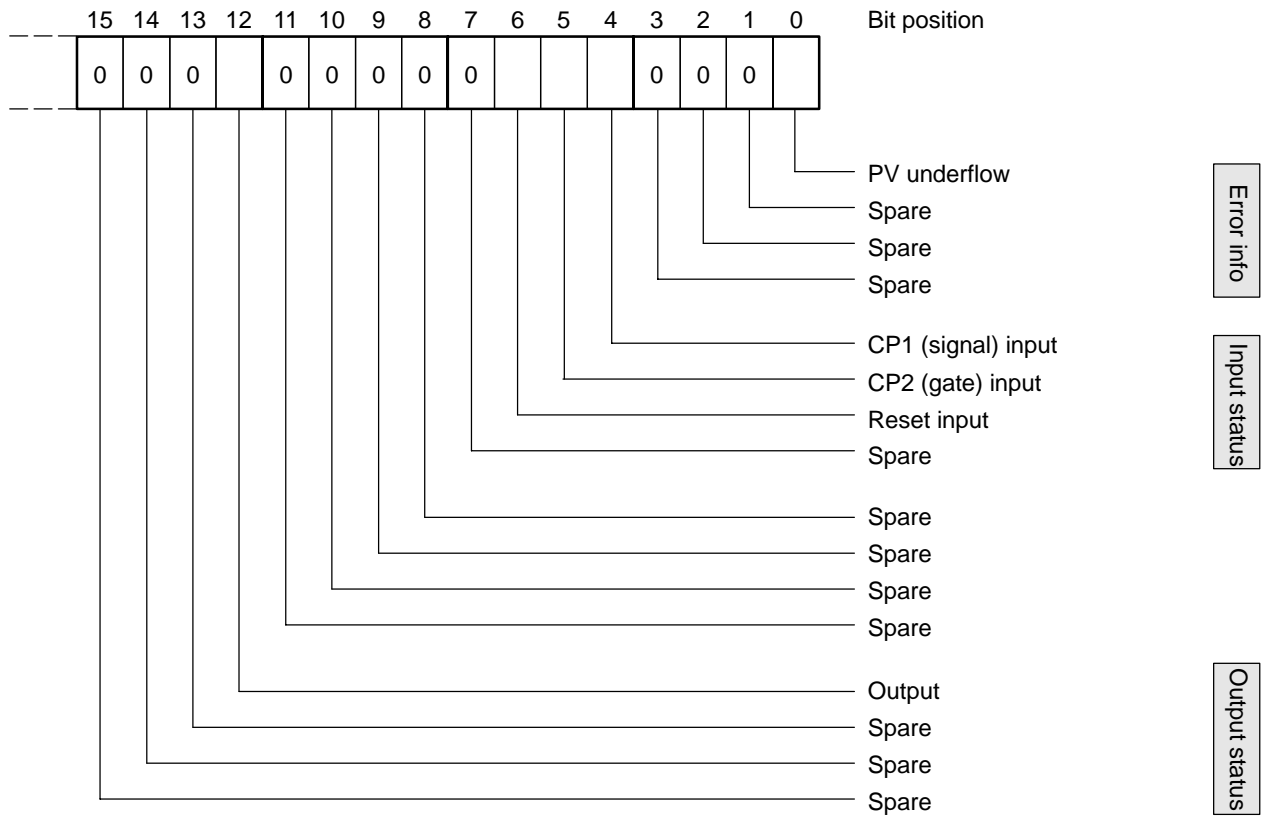

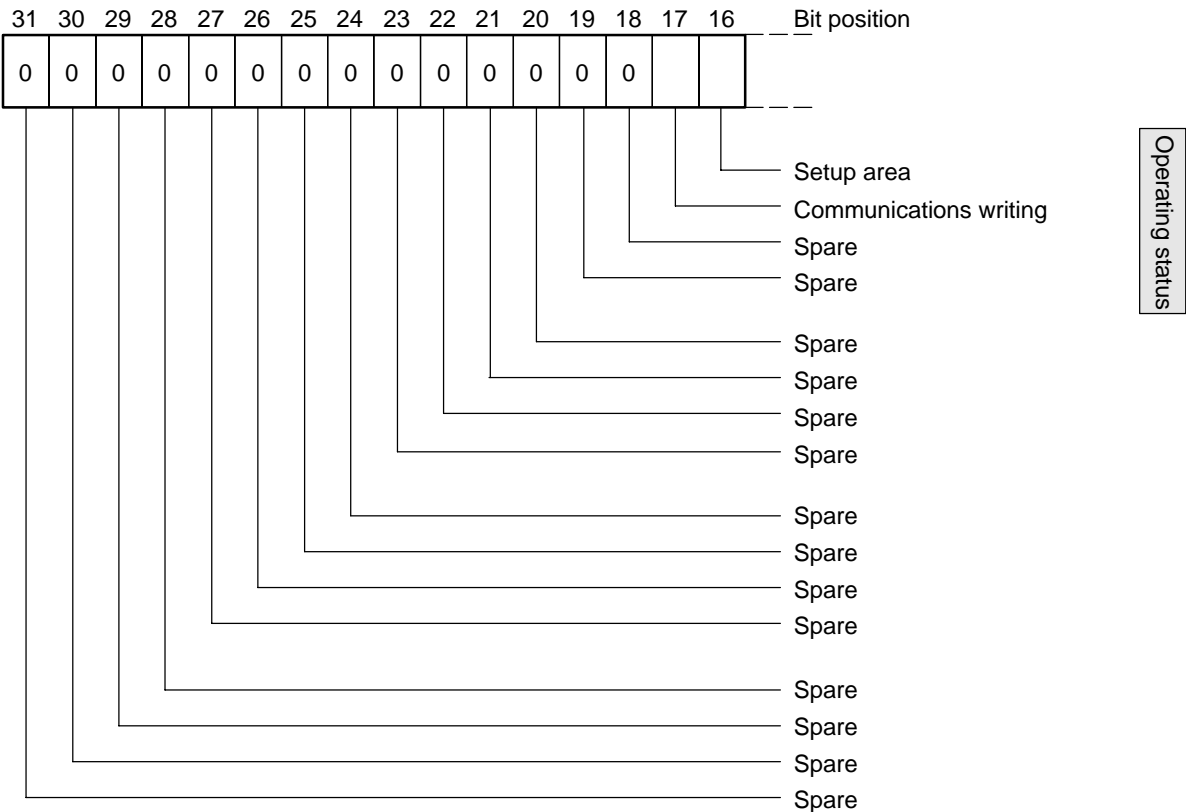

The following shows the status contents.

Bit position	Status	Bit Description	
		0	1
0	PV underflow *1	Not generated	Generated
1	Spare		
2	Spare		
3	Spare		
4	CP1 (signal) input *1	OFF	ON
5	CP2 (gate) input *1	OFF	ON
6	Reset input *1	OFF	ON
7	Spare		
8	Spare		
9	Spare		
10	Spare		
11	Spare		
12	Output *1	OFF	ON
13	Spare		
14	Spare		
15	Spare		
16	Setup area	Setup area 0	Setup area 1
17	Communications writing	OFF (disabled)	ON (enabled)
18	Spare		
19	Spare		
20	Spare		
21	Spare		
22	Spare		
23	Spare		
24	Spare		
25	Spare		
26	Spare		
27	Spare		
28	Spare		
29	Spare		
30	Spare		
31	Spare		

\* "Spare" bits are OFF at all times.

\*1: The status is as follows when reading is carried out in setup area 1:

- PV underflow: Previous value is held until reset is generated.
- CP1 (signal) input, CP2 (gate) input, reset input: OFF (0)
- Output: OFF (0)

### 3.3 Sample Program

#### ■ N88Basic

The following sample program displays responses returned from the H8GN on screen when command data is entered from the keyboard. Enter starting with the unit up to the number of elements as the command data.

This sample program was created using N88BASIC

```

1000 '-----
1010 'PROGRAM: H8GN Communication Sample Program (Compo Way/F)
1020 'VERSION: 1.00
1030 '(c) Copyright OMRON Corporation 2000
1040 'All Right Reserved
1050 '-----
1060 '
1070 '= Communications port setting (PARITY=EVEN, DATA=7, STOP=2)="
1080 '
1090 OPEN "COM: E73" AS #1
1100 '
1110 *REPEAT
1120 '
1130 '====Transmission processing====
1140 '
1150 '----- Entry of send data -----
1160 INPUT "SEND DATA:", SEND$
1170 '
1180 '----- To exit processing if there is no entry -----
1190 IF SEND$="" THEN * EXIT
1200 '
1210 '----- Calculation of BCC -----
1220 BCC=0
1230 SEND$=SEND$+CHR$ (3)
1240 FOR I=1 TO LEN (SEND$)
1250 BCC=BCC XOR ASC (MID$ (SEND$, I, 1))
1260 NEXT I
1270 BCC$=CHR$ (BCC)
1280 '
1290 '----- Transmission -----
1300 SDATA$=CHR$ (2)+SEND$+BCC$
1310 PRINT #1, SDATA$;
1320 '
1330 '====Reception processing====
1340 '
1350 *LOOP0
1360 RDATA$=""
1370 TIMEOUT=0
1380 *LOOP
1390 '----- Detection of time-out -----
1400 TIMEOUT=TIMEOUT+1
1410 IF TIMEOUT>2000 THEN RESP$="No Response": GOTO * REND
1420 IF LOC (1)=0 THEN * LOOP
1430 '

```



```

1440 '---- Identification of end character
      (reading is continued if character is not end character)
1450 RDATA$=RDATA$+INPUT$ (LOC (1), #1)
1460 IF LEN (RDATA$)<2 THEN * LOOP
1470 IF MID$ (RDATA$, LEN (RDATA$) -1, 1)<>CHR$ (3) THEN * LOOP
1480 RESP$=MID$ (RDATA$, 2, LEN (RDATA$) -2)
1490 IF RDATA$=SDATA$ THEN * LOOP0
1500 * END
1510 '
1520 '----- Display receive data -----
1530 PRINT "RESPONSE:"; RESP$
1540 GOTO * REPEAT
1550 '
1560 * EXIT
1570 '====End processing=====
1580 CLOSE #1
1590 END

```

● Sample operation

Read the PV of unit No.00. (In this example, PV=335.)

```

RUN
SEND DATA: 000000101C00001000001
RESPONSE: 000000010100000000014F

```

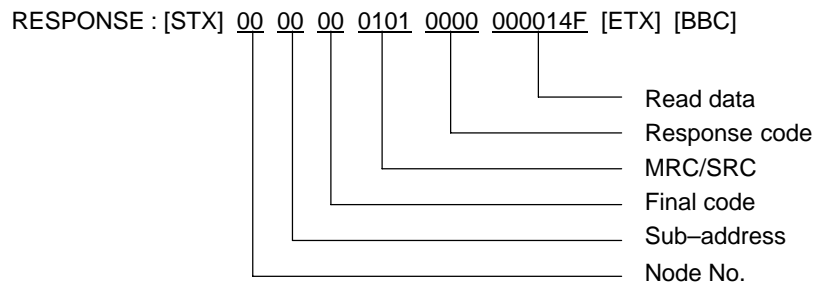
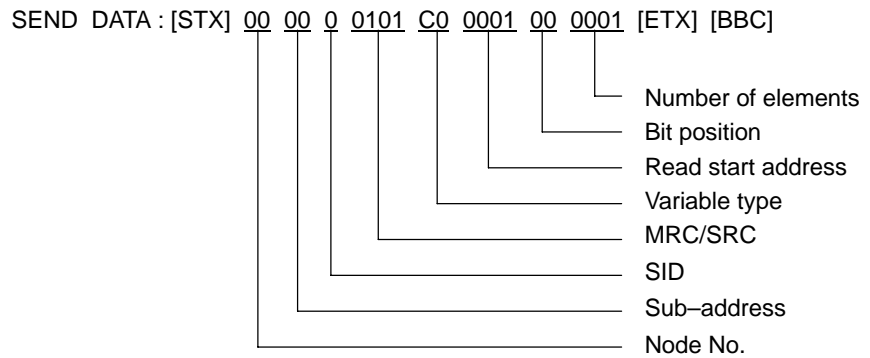

## Protocol macro

### What is a “protocol macro?”

The protocol macro function uses the PMCR command in a ladder program to execute a data send/receive sequence (protocol) with various communications devices such as general-purpose components connected to the RS-232C or RS-422A/RS-485 interface to control the device.

Standard system protocol is pre-installed on Serial Communications Board/Unit for enabling control of OMRON components (e.g. controllers and temperature control units).

For details on protocol macros, refer to the “CS1W-SCB21/41/-SCU21 User’s Manual” (Cat. No. W336).

**Connection** Use port 2 on the Serial Communications Board (CS1W-SCB41) for direct connection to the RS-485.

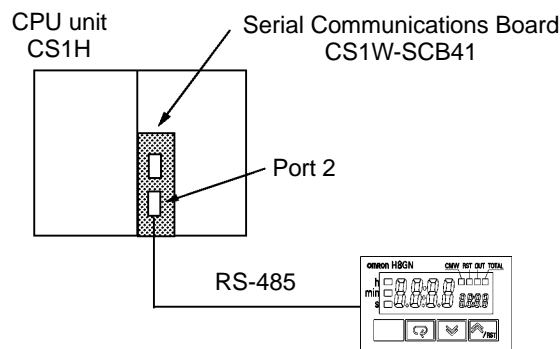

Set the TERM switch on the Serial Communications Board to ON and the WIRE switch to “2”. Attach a terminator to H8GN.

### Sample ladder program

Read the PV of H8GN using sequence No. 600 “send/receive with ASCII conversion (response ON)” of the standard system protocol “CompoWay /F Host” built into the Serial Communications Board.

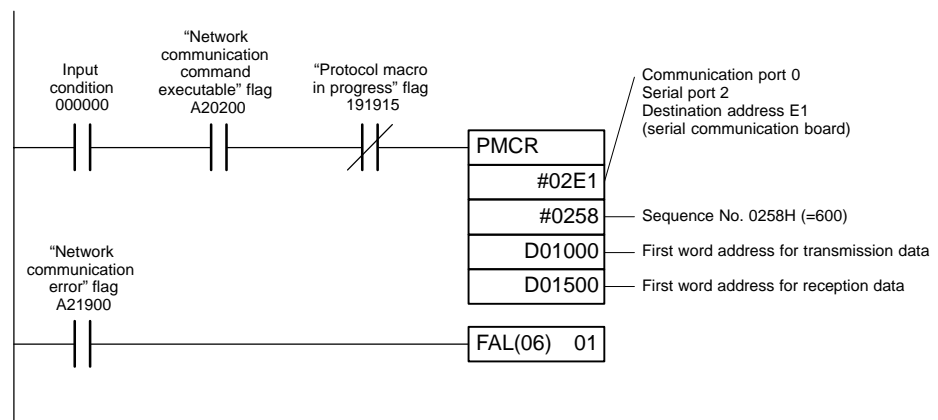

The PV is stored to D01502 and D01503 if the read PV command is set to D01000 onwards.

If a communications error occurs, execute the FAL command (continue operation and analyze trouble command).

● Data transmission word assignment

STX	Node No.	Sub-address	SID	MRC	SRC	Variable type	Address	Bit position	Number of elements	EXT	BCC
02H	"01"	"00"	"0"	"01"	"01"	"C0"	"0001"	"00"	"0001"		03H

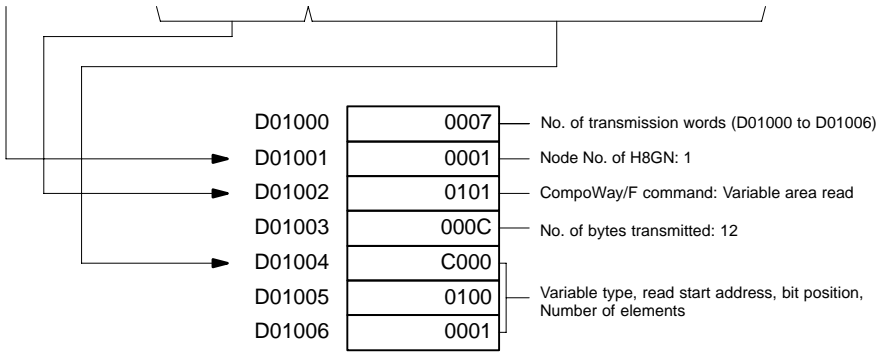

● Data reception word assignment

STX	Node No.	Sub-address	End code	MRC	SRC	Response code	Data	EXT	BCC
02H	"01"	"00"		"01"	"01"		Process value		03H

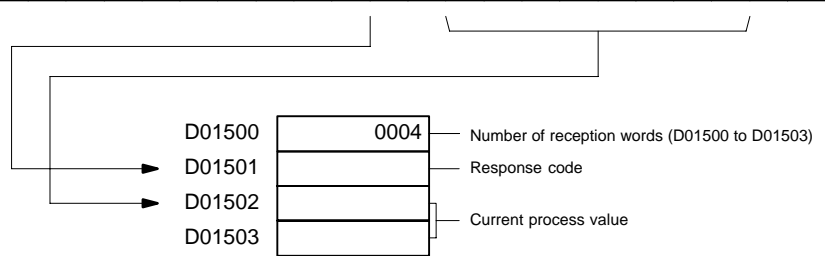

# *APPENDIX*

ASCII List .....	A-2
------------------	-----

# ASCII LIST (ANSI X 3.4-1986)

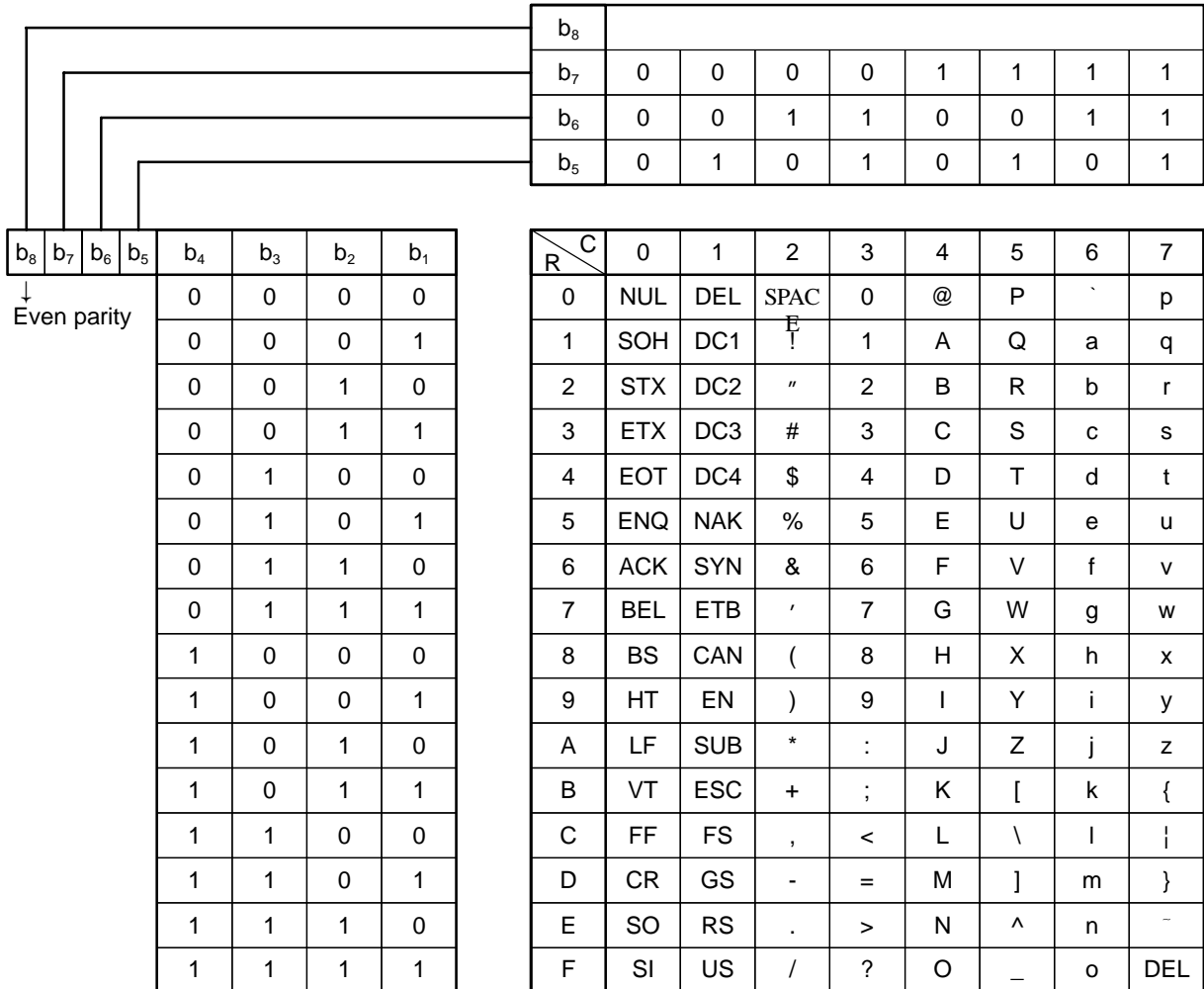

- A**  
 Addresses ..... 2-5  
 Area definitions ..... 2-5  
 ASCII list ..... A-2
- B**  
 BCC ..... 1-2, 2-2, 2-3, 2-4
- C**  
 Command frame ..... 1-3, 2-2  
 Command text ..... 2-2, 2-5  
 Communications data ..... 2-4, 3-1  
 Communications data length ..... 1-4, 1-5  
 Communications methods ..... 1-1, 1-2  
 Communications parameters ..... 1-4  
 Communications parity ..... 1-4, 1-5  
 Communications specifications ..... 1-2  
 Communications stop bit ..... 1-4, 1-5  
 Communications unit No. .... 1-4, 1-5  
 CompoWay/F ..... 1-2, 2-1, 3-1
- D**  
 Data format ..... 2-2  
 Details of services ..... 2-7
- E**  
 Echoback test ..... 2-6, 2-12  
 End code ..... 2-3, 2-4  
 ETX ..... 2-2, 2-3
- F**  
 FINS ..... 1-2, 2-3
- I**  
 Interface ..... 1-2, 1-3
- L**  
 List of services ..... 2-6
- N**  
 Number of elements ..... 2-5
- O**  
 Operation instructions ..... 2-6, 2-14
- P**  
 PDU ..... 2-5, 2-10
- R**  
 Read controller attributes ..... 2-6, 2-10  
 Read controller status ..... 2-6, 2-11  
 Read from variable area ..... 2-6, 2-7  
 Response code list ..... 2-15  
 Response frame ..... 2-3
- S**  
 Sample program ..... 3-9  
 SID ..... 2-2, 2-4  
 Status ..... 3-6  
 STX ..... 2-2
- T**  
 Transmission procedure ..... 1-3  
 Type code (variable type) ..... 2-5
- V**  
 Variable area (setup range) list ..... 3-2
- W**  
 Wiring ..... 1-3  
 Write to variable area ..... 2-6, 2-8

# Revision History

A manual revision code appears as a suffix to the catalog number on the front cover of the manual.

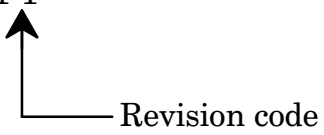
Cat. No. M066-E1-1  
 Revision code

The following table outlines the change made to the manual during each revision. Page numbers refer to previous version

Revision code	Data	Revised content
1	June 2000	Original production