

E5ZE-8
Multipoint Temperature Controller
Communications Manual

Produced December 2000

Notice:

OMRON products are manufactured for use according to proper procedures by a qualified operator and only for the purposes described in this manual.

The following conventions are used to indicate and classify precautions in this manual. Always heed the information provided with them. Failure to heed precautions can result in injury to people or damage to property.

- ! **DANGER** Indicates an imminently hazardous situation which, if not avoided, will result in death or serious injury.
- ! **WARNING** Indicates a potentially hazardous situation which, if not avoided, could result in death or serious injury.
- ! **Caution** Indicates a potentially hazardous situation which, if not avoided, may result in minor or moderate injury, or property damage.

OMRON Product References

All OMRON products are capitalized in this manual. The word “Unit” is also capitalized when it refers to an OMRON product, regardless of whether or not it appears in the proper name of the product.

The abbreviation “Ch,” which appears in some displays and on some OMRON products, often means “word” and is abbreviated “Wd” in documentation in this sense.

The abbreviation “PC” means Programmable Controller and is not used as an abbreviation for anything else.

Visual Aids

The following headings appear in the left column of the manual to help you locate different types of information.

Note Indicates information of particular interest for efficient and convenient operation of the product.

1,2,3... 1. Indicates lists of one sort or another, such as procedures, checklists, etc.

ODVA Conformance

This product has been tested by a third party test laboratory officially recognized by the Open DeviceNet Vendor Association, Inc. and conforms to the ODVA test software Ver. 2.0 to 1.00.

© OMRON, 2000

All rights reserved. No part of this publication may be reproduced, stored in a retrieval system, or transmitted, in any form, or by any means, mechanical, electronic, photocopying, recording, or otherwise, without the prior written permission of OMRON.

No patent liability is assumed with respect to the use of the information contained herein. Moreover, because OMRON is constantly striving to improve its high-quality products, the information contained in this manual is subject to change without notice. Every precaution has been taken in the preparation of this manual. Nevertheless, OMRON assumes no responsibility for errors or omissions. Neither is any liability assumed for damages resulting from the use of the information contained in this publication.

TABLE OF CONTENTS

PART 1: DEVICENET COMMUNICATIONS

SECTION 1

Overview of Communications Functions	3
1-1 DeviceNet	4
1-2 Remote I/O	4
1-3 DeviceNet Explicit Message Communications.	4

SECTION 2

Communications Setup.	5
2-1 Cable Connections	6
2-2 Communications Parameters.	6

SECTION 3

Remote I/O Communications.	9
3-1 Transmission Contents and Word Allocations	10
3-2 Reading Process Values	10
3-3 Reading Status.	11
3-4 Temperature Control Start/Stop	13
3-5 Writing Set Points	14
3-6 Remote I/O Delay Time	15

SECTION 4

DeviceNet Explicit Message Communications	17
4-1 Transmitting DeviceNet Explicit Messages	18
4-2 E5ZE Fixed Command Configuration	19
4-3 Instruction Execution Precautions.	20
4-4 DeviceNet Explicit Messages Set Values and Measurement Values	21

SECTION 5

Communications Errors.	33
5-1 End Codes	34
5-2 Indicators.	37

SECTION 6

Communications Program Examples	39
6-1 CVM1 and CV-series PCs.	40
6-2 C200HX/C200HE/C200HG PCs	47
6-3 CS1 PCs	54

Appendix A Multi-vendor Applications.

Appendix A Basic I/O Slave Device Protocol	61
Appendix A Object Mounting	61

TABLE OF CONTENTS

PART 2: SERIAL COMMUNICATIONS

SECTION 1

Serial Communications Control	67
1-1 Communications Control Procedure	68
1-2 Block Format	69
1-3 FCS Calculations	69
1-4 Checks	70
1-5 Error Processing	70

SECTION 2

Commands and Responses	71
2-1 Commands	72
2-2 Writing Sets of Data	78
2-3 Reading Sets of Data	80
2-4 End Codes	82
2-5 Error Codes	85

SECTION 3

Basic Temperature Control Commands	87
3-1 Set Point Write: WS	88
3-2 Set Point Read: RS	89
3-3 Process Value Read: RX	90
3-4 Output Value Read: RO	92
3-5 Proportional Band Write: WB	93
3-6 Proportional Band Read: RB	94
3-7 Integral Time Write: WN	95
3-8 Integral Time Read: RN	96
3-9 Derivative Time Write: WV	97
3-10 Derivative Time Read: RV	98
3-11 Control Period Write: WT	99
3-12 Control Period Read: RT	100
3-13 Output Operation (Normal/Reverse) Write: WU	101
3-14 Output Operation (Direct/Reverse) Read: RU	102
3-15 Alarm Mode Write: W#	103
3-16 Alarm Mode Read: R#	104
3-17 Alarm Temperature Write: W%	106
3-18 Alarm Temperature Read: R%	107
3-19 Memory Bank Designation Write: WM	108
3-20 Memory Bank Designation Read: RM	109
3-21 Hysteresis Write: WH	110
3-22 Hysteresis Read: RH	111
3-23 Status Read: RX	112
3-24 Error Read: RU	115

TABLE OF CONTENTS

SECTION 4

Commands According to Application 119

4-1	Auto-tuning Start: AS	120
4-2	Auto-tuning Stop: AP	121
4-3	Setting Unit Write: Wt	121
4-4	Setting Unit Read: Rt	123
4-5	Input Shift Write: WI	124
4-6	Input Shift Read: RI	125
4-7	Manual Reset Value Write: WK	126
4-8	Manual Reset Value Read: RK	127
4-9	Ramp Value Write: WR	127
4-10	Ramp Value Read: RR	128
4-11	Present Set Point Read: Rs	129
4-12	Manual Output Value Write: WO	131
4-13	Output Variable Limit Value Write: WL	132
4-14	Output Variable Limit Value Read: RL	133
4-15	Output Variable Change Rate Limit Value Write: WG	134
4-16	Output Variable Change Rate Limit Value Read: RG	136
4-17	Memory Write:	136
4-18	Initialize Setting Data: MC	137
4-19	Communication Test: TS	138

SECTION 5

Heater Burnout and SSR Failure Detection Commands 141

5-1	HB Alarm and HS Alarm Point Write: WU	142
5-2	HB Alarm and HS Alarm Point Read: RU	143
5-3	Heater Burnout and SSR Failure Detection Current Value Write: WW	144
5-4	Heater Burnout and SSR Failure Detection Current Value Read: RW	145
5-5	Heater Current Value and SSR Leakage Current Value Read: RZ	146

SECTION 6

Heating and Cooling Control Commands 149

6-1	Dead Band and Overlap Band Write: WD	150
6-2	Dead Band and Overlap Band Read: RD	151
6-3	Cooling Coefficient Write: WC	151
6-4	Cooling Coefficient Read: RC	152

TABLE OF CONTENTS

SECTION 7

Fuzzy Control Commands	155
7-1 Fuzzy Strength Write: Wj	156
7-2 Fuzzy Strength Read: Rj	157
7-3 Fuzzy Scale 1 Write: Wk	157
7-4 Fuzzy Scale 1 Read: Rk	158
7-5 Fuzzy Scale 2 Write: Wl	159
7-6 Fuzzy Scale 2 Read: Rl	160

SECTION 8

Control Operation Start and Stop Commands.....	163
8-1 Operation Start: OS	164
8-2 Operation Stop: OP	164
8-3 Manual Operation Start: OM	165
Revision History	173

About this Manual:

This manual describes DeviceNet (CompoBus/D) and serial communications (using the RS-232C auxiliary setting jack) for E5ZE-8@@@D1@B-V2 Multipoint Temperature Controllers and includes the sections described below. DeviceNet communications are described in part 1 and serial communications are described in part 2.

Please read this manual carefully and be sure you understand the information provided before attempting to use DeviceNet communications with an E5ZE Multipoint Temperature Controller.

Read the following manuals before operating a E5ZE-8@@@D1@B-V2 Multipoint Temperature Controller.

E5ZE Multipoint Temperature Controller Operation Manual (Cat. No. H076)

DeviceNet (CompoBus/D) Operation Manual (Cat. No. W267)

CS1W-DRM21 DeviceNet Unit Operation Manual (Cat. No. W380)

DeviceNet PCI Board Operation Manual (Cat. No. W381)

Part 1: DeviceNet Communications

Section 1 provides an overview of remote I/O and Explicit Messages that are supported by the E5ZE for DeviceNet communications.

Section 2 provides details on installing the E5ZE in a DeviceNet Network and setting the DIP switch.

Section 3 provides details on remote I/O communications, including allocations in the PC, various operating statuses, flags, and applications.

Section 4 provides details on DeviceNet explicit messages, including command and response formats, the instructions used by the PC to execute DeviceNet explicit message communications, and tables of set values and measurement values showing setting ranges, default values, data types, and addresses.

Section 5 provides details on response end codes and indicators used to identify communications errors.

Section 6 provides programming examples for both CV-series and C200HX/C200HE/C200HG PCs.

The **Appendix** provides details on multi-vendor applications.

Part 2: Serial Communications

Section 1 provides general information on serial communications and communications checks.

Section 2 provides a list of commands, end codes, and error codes. Information on writing and reading data sets are also provided.

Section 3 describes the basic temperature control commands

Section 4 describes the commands that are used according to the application.

Section 5 describes the commands used for heater burnout and SSR failure detection.

Section 6 describes the commands used for heating and cooling control.

Section 7 describes the commands used for fuzzy control.

Section 8 describes the commands used for starting and stopping operation.

The **Appendices** provide communications programming examples and an ASCII code list.

! WARNING

Failure to read and understand the information provided in this manual may result in personal injury or death, damage to the product, or product failure. Please read each section in its entirety and be sure you understand the information provided in the section and related sections before attempting any of the procedures or operations given.

Part 1

DeviceNet Communications

This part of the manual provides information required to communicate on a DeviceNet network.

SECTION 1

Overview of Communications Functions

This section provides an overview of remote I/O and Explicit Messages that are supported by the E5ZE for DeviceNet communications.

1-1	DeviceNet	4
1-2	Remote I/O	4
1-3	DeviceNet Explicit Message Communications.....	4

1-1 DeviceNet

DeviceNet (CompoBus/D) is a multi-vendor, open-field network that combines control and information at the machine and line control level. The E5ZE Multi-point Temperature Controller with DeviceNet communications supports the following transmission services.

- Remote I/O
- DeviceNet explicit message communications

For details on the methods for connecting and configuring a DeviceNet network, refer to the *DeviceNet (CompoBus/D) Operation Manual (Cat. No. W267)*.

This part of the manual describes mainly how to operate the E5ZE as a Slave in a DeviceNet network. It is assumed that the E5ZE is connected to an OMRON CVM1-DRM21-EV1 DeviceNet Master Unit, C200HW-DRM21-EV1 DeviceNet Master Unit, or CS1W-DRM21 DeviceNet Unit.

When using DeviceNet, use an E5ZE-8@@@D1@B-V2 model.

1-2 Remote I/O

The remote I/O function allows I/O data to be exchanged automatically between the DeviceNet Master Unit and the E5ZE, without the need of any special programs. The remote I/O function enables the following functions in the E5ZE.

- Reading the process value and different operating statuses.
- Writing set points.
- Executing commands to start and stop temperature control.

1-3 DeviceNet Explicit Message Communications

DeviceNet explicit messages are used to read and write messages for Slaves, and perform various control operations, according to the program being used by the host system. DeviceNet explicit message communications enable the following functions in the E5ZE.

- Reading and writing set values and process values.
- Starting and stopping auto-tuning (AT), and other operating directions.

SECTION 2

Communications Setup

This section provides details on installing the E5ZE in a DeviceNet network and setting the DIP switch.

2-1	Cable Connections	6
2-2	Communications Parameters.....	6

2-1 Cable Connections

Wire the DeviceNet connector as shown in the following diagram. For details on connecting the Master Unit to the E5ZE, refer to the *DeviceNet (CompoBus/D) Operation Manual (Cat. No. W267)*. Multi-drop connectors cannot be used to connect the E5ZE to the CompoBus/D Master Unit.

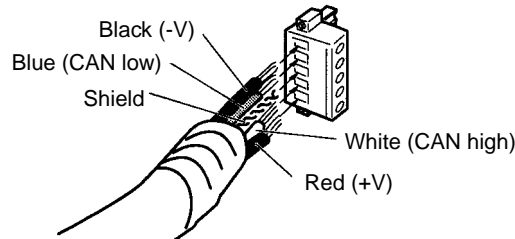

2-2 Communications Parameters

Be sure to set the following parameters.

- **Node Address**
Make sure that the E5ZE node address settings and words allocated to the E5ZE are not the same as those set for any other Slave.
- **Baud Rate**
Set the same baud rate on the E5ZE and DeviceNet Master Unit.

DeviceNet DIP Switch

Pin 1 to Pin 6

The node address is set using pins 1 to 6.

Pin 1	Pin 2	Pin 3	Pin 4	Pin 5	Pin 6
2^0	2^1	2^2	2^3	2^4	2^5

Pins 1 to 6 are all factory-set to OFF (node address 00).



Pin 7 and Pin 8

The baud rate is set using pins 7 and 8.

Baud rate	Pin 7	Pin 8
125 kbps	OFF	OFF
250 kbps	ON	OFF
500 kbps	OFF	ON
Not used	ON	ON

Pins 7 and 8 are both factory-set to OFF (baud rate of 125 kbps).

Pin 9

Always set pin 9 to OFF.

Pin 10

When a DeviceNet communications error occurs, set the E5ZE operation as follows:

ON

Temperature control will continue according to the data that was transmitted immediately before the error occurred.

OFF

Operation is stopped. (Pin 10 is set to ON at the factory.)

DeviceNet Communications Error

A DeviceNet communications error indicates a transmission data error or a connection time-out error between the DeviceNet Master Unit and the E5ZE.

SECTION 3

Remote I/O Communications

This section provides details on remote I/O communications, including allocations in the PC, various operating statuses, flags, and applications.

3-1	Transmission Contents and Word Allocations	10
3-2	Reading Process Values	10
3-3	Reading Status	11
3-3-1	Alarm Status	11
3-3-2	Auto-tuning Status	11
3-3-3	Operating Status	12
3-4	Temperature Control Start/Stop	13
3-4-1	Startup Operation	13
3-4-2	Manual Operation	14
3-5	Writing Set Points	14
3-6	Remote I/O Delay Time	15

3-1 Transmission Contents and Word Allocations

When remote I/O communications are used with the E5ZE, reading the process value, starting and stopping temperature control, and writing set points are possible for any control point, without requiring a special program to be executed from the Master Unit. Data is automatically refreshed at every 200-ms cycle. There are 14 input words and 9 output words allocated to the E5ZE in the Master Unit (I/O directions are in reference to the Master Unit). Each word is allocated according to the following table.

Inputs		Outputs	
First word	Control point 0 process value	First word	Control point 0 set point
+ 1	Control point 1 process value	+ 1	Control point 1 set point
+ 2	Control point 2 process value	+ 2	Control point 2 set point
+ 3	Control point 3 process value	+ 3	Control point 3 set point
+ 4	Control point 4 process value	+ 4	Control point 4 set point
+ 5	Control point 5 process value	+ 5	Control point 5 set point
+ 6	Control point 6 process value	+ 6	Control point 6 set point
+ 7	Control point 7 process value	+ 7	Control point 7 set point
+ 8	Alarm 1 status	+ 8	Start/stop temperature control
+ 9	Alarm 2 status	---	
+ 10	Auto-tuning status		
+ 11	HB (heater burnout) alarm status		
+ 12	HS (SSR failure) alarm status		
+ 13	Operating status		

The first input and output words are normally determined according to the Master Unit being used and the node address. The first I/O words can be changed and a Configurator is used to change the Master Unit settings.

3-2 Reading Process Values

The process value for each control point is expressed as 16-bit signed binary data (two's complement for negative values) in the corresponding word allocated in the Master Unit mounted to the PC. The unit used depends on the position of the decimal point in the E5ZE. The default values are 1°C/°F for thermocouples and 0.1°C/°F for platinum resistance thermometers.



Example

If the setting unit is 0.1°C/°F, and the value in the allocated word is 1111110001111100, the conversion values are as follows:

Binary	Hexadecimal	Decimal	Process value
1111110001111100	FC7C	-900	-90.0°C

If the value in the word is 0000010001001100, the values are as follows:

Binary	Hexadecimal	Decimal	Process value
0000010001001100	044C	1100	110.0°C

The following table shows the values that will be contained in the corresponding word under certain conditions.

Status details	Value (hexadecimal)
Process value overflow or input error	7FFF
Process value underflow	8000
Temperature Controller error or connection confirmation standby	0000 or the last value sent
Outside temperature display range	7D00

3-3 Reading Status

3-3-1 Alarm Status

Alarms 1 and 2, HB and HS Alarms

The alarm status is expressed in the corresponding word in the PC to which the Master Unit is connected as shown in the following diagram. The format is the same for the alarm 1, alarm 2, HB (heater burnout) alarm, and HS (SSR failure) alarm.

Alarm Status

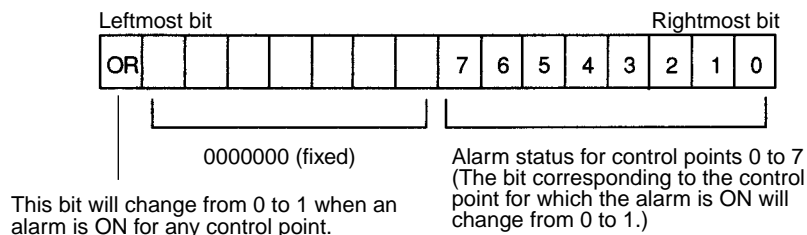

Example

If the alarm 1 is OFF for all control points and then turns ON for control point 3, the contents of the corresponding word in the PC will change as follows:

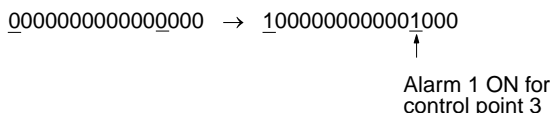

When alarm 1 turns OFF for control point 3, the contents of the corresponding word will return to 0000000000000000.

3-3-2 Auto-tuning Status

The auto-tuning status is reflected in the corresponding word in the PC to which the Master Unit is mounted.

Auto-tuning Status

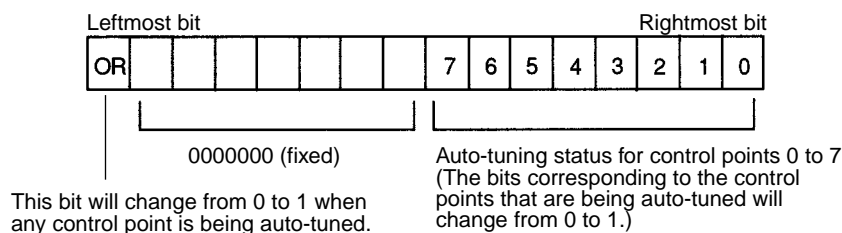

Example

If no control points are being auto-tuned, and then auto-tuning begins for control point 3, the contents of the corresponding word in the PC will change as follows:

0000000000000000 → 1000000000001000
 ↑
 Control point 3 is being auto-tuned.

When auto-tuning for control point 3 has been completed, the contents of the corresponding word will return to 0000000000000000.

3-3-3 Operating Status

The status data showing whether an error has occurred in the E5ZE is expressed in the contents of the corresponding word in the PC to which the Master Unit is mounted.

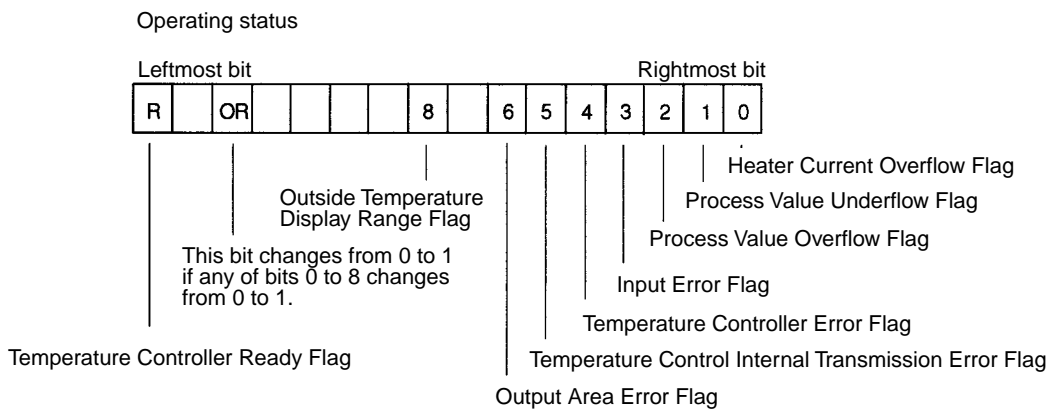

The following table provides the meaning and operation of the operating status flags.

Flag name	Meaning
Temperature Controller Ready Flag	This flag changes from 0 to 1 when the E5ZE power is turned ON and DeviceNet communications are enabled. After checking that this flag is ON, execute the program to start using I/O data.
Outside Temperature Display Range Flag	This flag changes from 0 to 1 if the process value exceeds 3200.0°F when a W/Re5-26 thermocouple sensor is being used and the setting unit is 0.1°C/°F.
Output Area Error Flag (See note 1.)	This flag changes from 0 to 1 if the output data from the Master is not reflected in the E5ZE due to the operating mode.
Temperature Control Internal Transmission Error Flag (See note 1.)	This flag changes from 0 to 1 if the remote I/O function has not been processed properly in the E5ZE.
Temperature Controller Error Flag	This flag changes from 0 to 1 if there is an error in the Temperature Controller, such as an AD converter error or memory error.
Input Error Flag	This flag changes from 0 to 1 if the temperature sensor is disconnected or short-circuited.
Process Value Overflow Flag	This flag changes from 0 to 1 if the process value is more than the maximum value of the setting range. (See note 2.)

Flag name	Meaning
Process Value Underflow Flag	This flag changes from 0 to 1 if the process value is less than the minimum value of the setting range. (See note 2.)
Heater Current Overflow Flag	This flag changes from 0 to 1 if the measured heater current exceeds 55.0 A when the HB and HS alarm are being used.

- Note**
1. If the Output Area Error Flag or Temperature Controller Error Flag is ON (1) for longer than 1 s, the remote I/O data will not be transmitted correctly to the E5ZE.
 2. The measurement range is from the setting range lower-limit negative value (-20°C or -40°F) to the setting range upper-limit positive value (20°C or 40°F).

3-4 Temperature Control Start/Stop

The temperature control of control points in the E5ZE is started and stopped by operating the bits in the corresponding word allocated in the PC to which the Master Unit is mounted, as follows:

Temperature Control Start/Stop

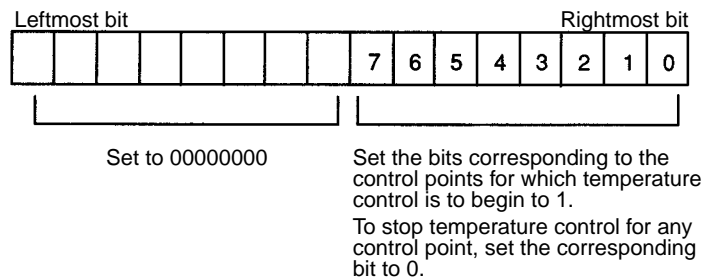

Example

If the temperature control of all control points is stopped and then starts for control point 3, the contents of the corresponding word in the PC will change, as follows:

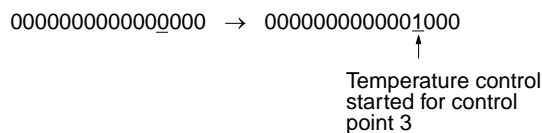

3-4-1 Startup Operation

When pin 5 (startup operation setting) of the FUNCTION switch on the front panel of the E5ZE-8@@@D1@B-V2 Multipoint Temperature Controller is set to ON, the Unit will operate as shown in the following diagram.

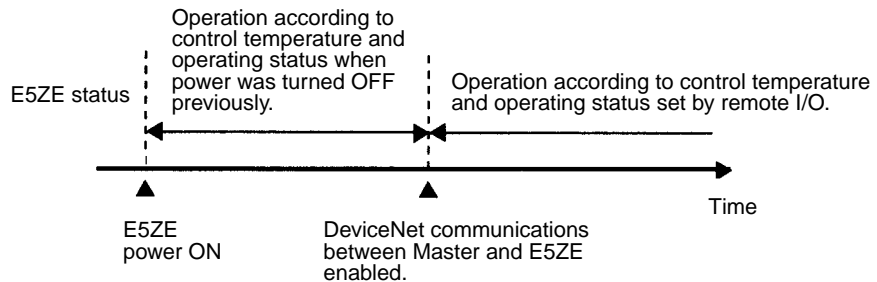

The time required for DeviceNet communications to be enabled will depend on the order in which power is supplied, the number of Slaves connected to the Master, the baud rate, and other variables.

3-4-2 Manual Operation

When the E5ZE-8@@@D1@B-V2 Multipoint Temperature Controller is being operated manually, the following procedure is required depending on the relationship to the remote I/O Temperature Control Start/Stop Bit.

Refer to page 28 for details on the relationship between remote I/O and the E5ZE operating status.

Starting Manual Operation

- 1,2,3...
1. Set the Temperature Control Start/Stop Bit to 1 for the control point to be manually operated and temperature control will start for the control point.
 2. Execute the Manual Operation Start command using DeviceNet explicit message communications or through the RS-232C auxiliary setting jack. Manual operation will start.
 3. Set the manual output using DeviceNet explicit message communications or through the RS-232C auxiliary setting jack.

Stopping Manual Operation

Set the Temperature Control Start/Stop Bit to 0 for the control point being manually operated and temperature control will stop for the specified control point. Temperature control can then be restarted by setting the bit to 1 again.

3-5 Writing Set Points

The set point for each control point is written as 16-bit signed binary data (two's complement for negative values) in the corresponding word in the PC to which the Master Unit is mounted. The value is automatically transmitted to the E5ZE. The data will be written according to the setting unit that is set in the E5ZE. The default value is 1°C/°F for thermocouples and 0.1°C/°F for platinum resistance thermometers.



Example

If the set point is to be set to -90.0°C, and the setting unit is 0.1°C, the value set in the corresponding word will be as follows:

Set Point	Decimal	Hexadecimal	Binary
-90.0°C	-900	FC7C	1111110001111100

If the set point is to be set to 110.0°C, and the setting unit is 0.1°C, the value set in the corresponding word will be as follows:

Set Point	Decimal	Hexadecimal	Binary
110.0°C	1100	044C	0000010001001100

If the set point is to be set to 110.0°C, and the setting unit is 1°C, the value set in the corresponding word will be as follows:

Set Point	Decimal	Hexadecimal	Binary
110.0°C	110	006E	000000001101110

Refer to page 25 for details on the permissible setting ranges.

3-6 Remote I/O Delay Time

- The time required for the remote I/O data reflecting the changed data to be prepared at the E5ZE after a main input to the E5ZE has changed is called the input delay time.
- The time required for the data that has been transmitted to the E5ZE using DeviceNet communications to affect in the operation of the E5ZE is called the output delay time.
- The maximum input and output delay times are 500 ms.
- For details on how to calculate the I/O delay time, refer to the *DeviceNet (CompoBus/D) Operation Manual (Cat. No. W267)*.

SECTION 4

DeviceNet Explicit Message Communications

DeviceNet explicit message communications are used to read and write the E5ZE's measurement values and set values that cannot be read or written using remote I/O communications. Settings can also be made from a master not manufactured by OMRON.

Parameters written using DeviceNet explicit messages are saved even if the power supply is turned OFF.

This section provides details on DeviceNet explicit messages, including command and response formats, the instructions used by the PC to execute DeviceNet explicit message communications, and tables of set values and measurement values showing setting ranges, default values, data types, and addresses.

4-1	Transmitting DeviceNet Explicit Messages	18
4-1-1	Command Format	18
4-1-2	Commands	19
4-1-3	Remote I/O and DeviceNet Explicit Messages.	19
4-2	E5ZE Fixed Command Configuration	19
4-3	Instruction Execution Precautions.	20
4-3-1	CMND(194/490): CVM1, CV-series, and CS1-series PCs	20
4-3-2	IOWR(223): C200HX/C200HE/C200HG PCs	20
4-3-3	Control Data for Sending DeviceNet Explicit Messages Using CMND(194/490) or IOWR(223)	21
4-4	DeviceNet Explicit Messages Set Values and Measurement Values	21
4-4-1	Commonly Used Set Values	21
4-4-2	Reading/Writing using Variable Type 90	27
4-4-3	Operation Variables	27
4-4-4	Relationship between Operating Status and Operating Commands	28
4-4-5	Set Values in Memory Banks	28
4-4-6	Measurement Values for Individual Control Points	30
4-4-7	Set Values for all Control Points.	31
4-4-8	Set Values for All Control Points	32

4-1 Transmitting DeviceNet Explicit Messages

DeviceNet explicit messages are executed from the user program using the CMND(194/490) instruction for a CVM1, CV-series, or CS1-series PC, and the IOWR(223) instruction with a C200HX, C200HG, or C200HE PC.

The transmission procedure involves the Master sending a command to the E5ZE and the E5ZE returning a response to the command back to the Master.

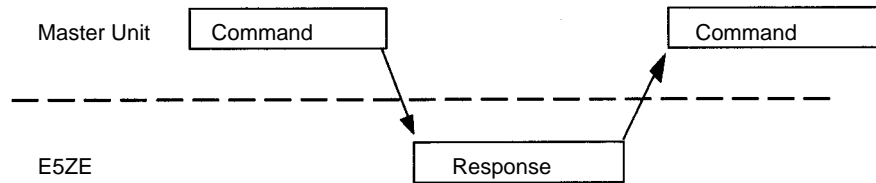

Refer to the *DeviceNet (CompoBus/D) Operation Manual (Cat. No. W267)* for details on the transmission methods.

Details on the format of commands and responses used for transmission, and the set values and measurement values specific to the E5ZE are provided here.

4-1-1 Command Format

The command format for DeviceNet explicit messages is given below.

Command

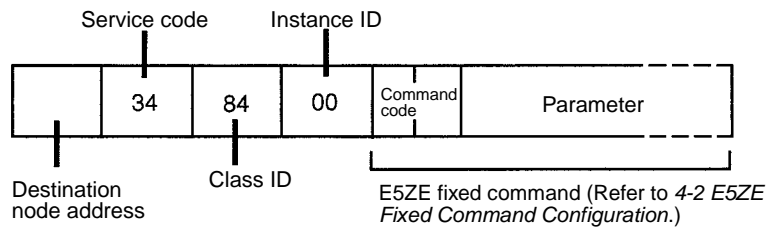

Response

Normal

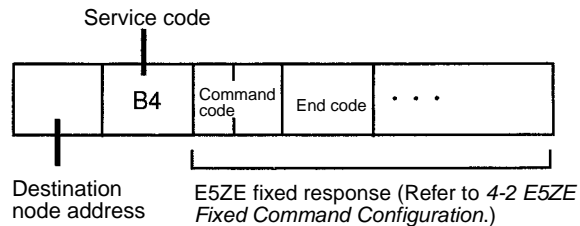

Error

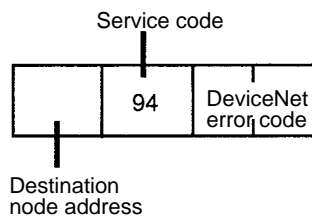

4-1-2 Commands

There are only two commands that can be used with the E5ZE.

Command type	Command code
MEMORY AREA READ	0101
MEMORY AREA WRITE	0102

4-1-3 Remote I/O and DeviceNet Explicit Messages

Data written with the remote I/O allocated in the DeviceNet Network is updated in the E5ZE every 200 ms. Data written with DeviceNet explicit messages is updated when the command is executed.

4-2 E5ZE Fixed Command Configuration

Reading PC Memory

The following diagram shows the format of command data and response data when messages are used to read set values and measurement values from the E5ZE to which the Master Unit is mounted.

Command Format

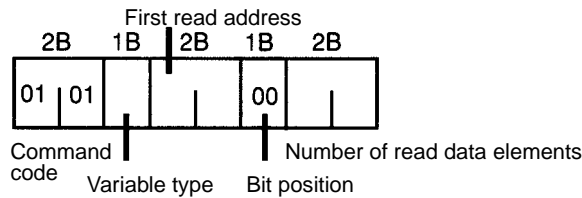

Response Format

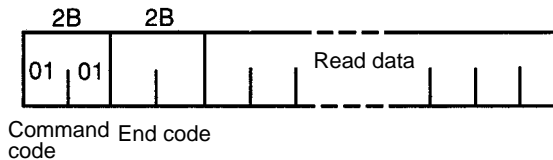

- The total number of read data bytes is $2 \times$ Number of read data elements.
- Refer to the table of DeviceNet explicit messages set values and measurement values for details on addresses and variable types for read set values and measurement values.

Writing PC Memory

The following diagram shows the format of command data and response data when messages are used to write set values and measurement values from the E5ZE to which the Master Unit is mounted.

Command Format

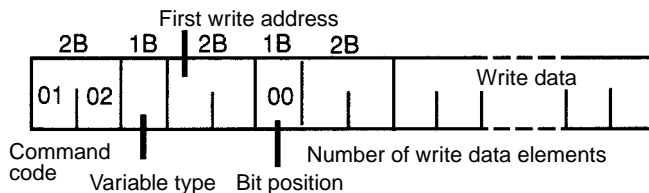

Response Format

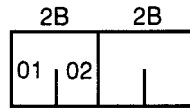

Command code End code

- The total number of write data bytes is 2 × Number of write data elements.
- Refer to the table of DeviceNet explicit messages set values and measurement values for details on addresses and variable types of write set values and measurement values.
- If there is an error in even one part of the data being written, all of the data written at the same time will not be saved in the E5ZE.

FINS command 2801 is sent using CMND(194/490) or IOWR(223) to send DeviceNet explicit messages from an OMRON PC Master Unit. For details, refer to the *DeviceNet (CompoBus/D) Operation Manual (Cat. No. W267)* or the *CS1W-DRM21 DeviceNet Unit Operation Manual (Cat. No. W380)*.

4-3 Instruction Execution Precautions

When DeviceNet explicit message communications are used with the E5ZE, there are settings that are specific to the control data for CMND(194/490) and IOWR(223) instructions that must be set, as shown next.

For details on both instructions and their applications, refer to the *DeviceNet (CompoBus/D) Operation Manual (Cat. No. W267)*.

4-3-1 CMND(194/490): CVM1, CV-series, and CS1-series PCs

The control data for the CMND(194/490) instructions is as follows:

Word	Bit									
	15	12	11	08	07	06	05	04	03	00
C	Number of command data bytes									
C+1	Number of response data bytes									
C+2	0		0		Destination network address					
C+3	Destination node address (Local node DeviceNet Master MAC ID)					Destination unit address (Local node DeviceNet Master Special I/O Unit number or FE)				
C+4	0 (response required)		Communications port No. (0 to 7)		0			Number of retries (0 to F)		
C+5	Response monitoring time (0000 to FFFF), in 0.1 s increments (except 0000 that is 2 s)									

4-3-2 IOWR(223): C200HX/C200HG/C200HE PCs

The control data for the IOWR(223) instruction is as follows:

Word	Bit					
	15	08	07	00		
C	0/1	0	Destination address (Local node DeviceNet Master MAC ID)		Destination unit address	

Bit 15 is used to set whether a response is required or not. If bit 15 is set to 0, a response is required and if the bit is set to 1, a response is not required. Set this bit to 0 (response required).

Bits 8 to 13 are used to set the destination node address (E5ZE node address), and bits 0 to 7 are used to set the destination Unit address (the local node DeviceNet Master Special I/O Unit number or FE).

4-3-3 Control Data for Sending DeviceNet Explicit Messages Using CMND(194/490) or IOWR(223)

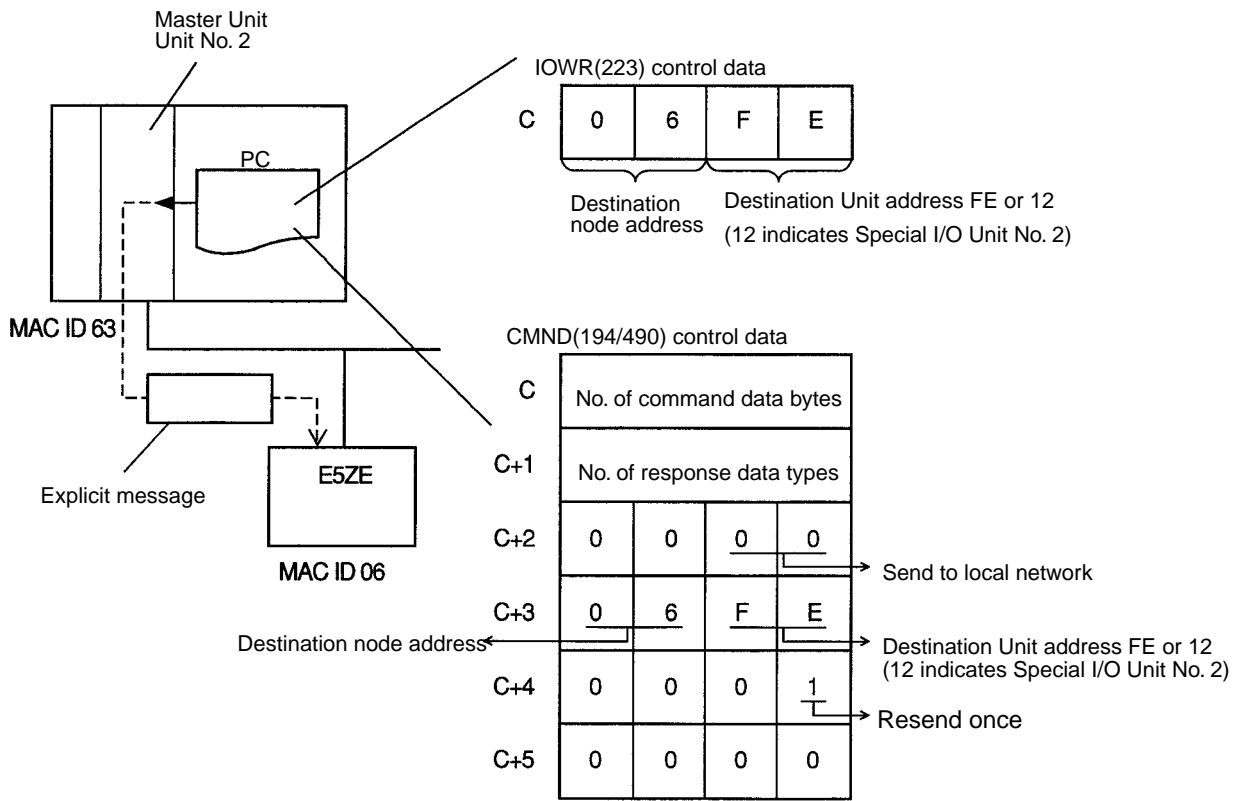

4-4 DeviceNet Explicit Messages Set Values and Measurement Values

This section provides tables that can be used when setting and monitoring the set values for all control points. The tables are given by variable type.

4-4-1 Commonly Used Set Values

Variable Type: 90

No.	Address	Set value or measurement value	Data setting or monitoring range	Data type
1	0000	Control point 0 process value	Range: Depends on sensor type used. (See note 4.) Unit: Depends on setting (either 0.1°C/°F or 1°C/°F)	Numeric Read only
2	0001	Control point 1 process value		
3	0002	Control point 2 process value		
4	0003	Control point 3 process value		
5	0004	Control point 4 process value		
6	0005	Control point 5 process value		
7	0006	Control point 6 process value		
8	0007	Control point 7 process value		
9	000C	Alarm 1 status	Range: 0000 to 80FF	Status Read only Bit contents same as remote I/O contents.
10	000D	Alarm 2 status	Range: 0000 to 80FF	
11	000E	Auto-tuning status	Range: 0000 to 80FF	
12	000F	HB alarm status	Range: 0000 to 80FF	
13	0010	HS alarm status	Range: 0000 to 80FF	

No.	Address	Set value or measurement value	Data setting or monitoring range	Data type
14	0011	Temperature control status (See note 7.)	Range: 0000 to 811F	Status Read only
15	0012	Operation start/stop (See notes 3 and 6.)	Range: 0000 to 00FF (Default: 0000)	Status Read
16	0013	Control point 0 set point	Range: Depends on sensor type used. (See notes 1 and 4.) Unit: Depends on setting (either 0.1°C/ °F or 1°C/°F)	Numeric Read
17	0014	Control point 1 set point		
18	0015	Control point 2 set point		
19	0016	Control point 3 set point		
20	0017	Control point 4 set point		
21	0018	Control point 5 set point		
22	0019	Control point 6 set point		
23	001A	Control point 7 set point		
24	001F	Auto-tuning start/stop (See note 2.)	Range: 0000 to 00FF Default: 0000	Status Write only
25	0020	Control point 0 alarm 1 temperature	Range: D8F1 to 7350 (-999.9 to 3000.0) when setting unit is 0.1°C/°F. (See note 4.) Range: D8F1 to 270F (-9999 to 9999) when setting unit is 1°C/°F. Default: 0000 (0.0 or 0)	Numeric Read/write
26	0021	Control point 1 alarm 1 temperature		
27	0022	Control point 2 alarm 1 temperature		
28	0023	Control point 3 alarm 1 temperature		
29	0024	Control point 4 alarm 1 temperature		
30	0025	Control point 5 alarm 1 temperature		
31	0026	Control point 6 alarm 1 temperature		
32	0027	Control point 7 alarm 1 temperature		
33	002C	Control point 0 alarm 2 temperature	Range: D8F1 to 7530 (-999.9 to 3000.0) when setting unit is 0.1°C/°F. (See note 4.) Range: D8F1 to 270F (-9999 to 9999) when setting unit is 1°C/°F. Default: 0000 (0.0 or 0)	Numeric Read/write
34	002D	Control point 1 alarm 2 temperature		
35	002E	Control point 2 alarm 2 temperature		
36	002F	Control point 3 alarm 2 temperature		
37	0030	Control point 4 alarm 2 temperature		
38	0031	Control point 5 alarm 2 temperature		
39	0032	Control point 6 alarm 2 temperature		
40	0033	Control point 7 alarm 2 temperature		
41	0038	Control point 0 input shift value	Range: FC19 to 03E7 (-99.9 to 99.9) (See note 1.) Unit: 0.1°C or °F Default: 0000 (0.0)	Numeric Read/write
42	0039	Control point 1 input shift value		
43	003A	Control point 2 input shift value		
44	003B	Control point 3 input shift value		
45	003C	Control point 4 input shift value		
46	003D	Control point 5 input shift value		
47	003E	Control point 6 input shift value		
48	003F	Control point 7 input shift value		

No.	Address	Set value or measurement value	Data setting or monitoring range	Data type
49	0044	Control point 0 proportional band	Range: 0000 to 270F (0.0 to 999.9) (See note 1.) Unit: 0.1°C or °F Default: 0000 (0.0)	Numeric Read/write
50	0045	Control point 1 proportional band		
51	0046	Control point 2 proportional band		
52	0047	Control point 3 proportional band		
53	0048	Control point 4 proportional band		
54	0049	Control point 5 proportional band		
55	004A	Control point 6 proportional band		
56	004B	Control point 7 proportional band		
57	0050	Control point 0 integral time	Range: 0000 to 0F9F (0 to 3999) (See note 1.) Unit: 1 s Default: 0000 (0)	Numeric Read/write
58	0051	Control point 1 integral time		
59	0052	Control point 2 integral time		
60	0053	Control point 3 integral time		
61	0054	Control point 4 integral time		
62	0055	Control point 5 integral time		
63	0056	Control point 6 integral time		
64	0057	Control point 7 integral time		
65	005C	Control point 0 derivative time	Range: 0000 to 0F9F (0 to 3999) (See note 1.) Unit: 1 s Default: 0000 (0)	Numeric Read/write
66	005D	Control point 1 derivative time		
67	005E	Control point 2 derivative time		
68	005F	Control point 3 derivative time		
69	0060	Control point 4 derivative time		
70	0061	Control point 5 derivative time		
71	0062	Control point 6 derivative time		
72	0063	Control point 7 derivative time		
73	0068	Control point 0 heating output variable	Range: 0000 to 03EB (0.0 to 100.0) Unit: 0.1%	Numeric Read only
74	0069	Control point 1 heating output variable		
75	006A	Control point 2 heating output variable		
76	006B	Control point 3 heating output variable		
77	006C	Control point 4 heating output variable		
78	006D	Control point 5 heating output variable		
79	006E	Control point 6 heating output variable		
80	006F	Control point 7 heating output variable		

No.	Address	Set value or measurement value	Data setting or monitoring range	Data type
81	0074	Control point 0 heater current	Range: 0000 to 0226 (0.0 to 55.0) (See note 8.) Unit: 0.1 A	Numeric Read only
82	0075	Control point 1 heater current		
83	0076	Control point 2 heater current		
84	0077	Control point 3 heater current		
85	0078	Control point 4 heater current		
86	0079	Control point 5 heater current		
87	007A	Control point 6 heater current		
88	007B	Control point 7 heater current		
89	0080	Control point 0 memory bank No.	Range: 0000 to 0007 (See note 1.) Default: 0000 (0)	Numeric Read/write
90	0081	Control point 1 memory bank No.		
91	0082	Control point 2 memory bank No.		
92	0083	Control point 3 memory bank No.		
93	0084	Control point 4 memory bank No.		
94	0085	Control point 5 memory bank No.		
95	0086	Control point 6 memory bank No.		
96	0087	Control point 7 memory bank No.		
97	008C	Control point 0 heater burnout detection current	Range: 0000 to 01F4 (0.0 to 50.0) Unit: 0.1 A Default: 0000 (0.0)	Numeric Read/write
98	008D	Control point 1 heater burnout detection current		
99	008E	Control point 2 heater burnout detection current		
100	008F	Control point 3 heater burnout detection current		
101	0090	Control point 4 heater burnout detection current		
102	0091	Control point 5 heater burnout detection current		
103	0092	Control point 6 heater burnout detection current		
104	0093	Control point 7 heater burnout detection current		
105	0098	Control point 0 cooling coefficient	Range: 0000 to 0064 (0.0 to 10.0) (See note 1.) Unit: 0.1 Default: 000A (1.0)	Numeric Read/write
106	0099	Control point 1 cooling coefficient		
107	009A	Control point 2 cooling coefficient		
108	009B	Control point 3 cooling coefficient		
109	009C	Control point 4 cooling coefficient		
110	009D	Control point 5 cooling coefficient		
111	009E	Control point 6 cooling coefficient		
112	009F	Control point 7 cooling coefficient		

No.	Address	Set value or measurement value	Data setting or monitoring range	Data type
113	00A4	Control point 0 dead band	Range: FC19 to 03E7 (-999 to 999) (See note 1.) Unit: 1°C or °F Default: 0000 (0)	Numeric Read/write
114	00A5	Control point 1 dead band		
115	00A6	Control point 2 dead band		
116	00A7	Control point 3 dead band		
117	00A8	Control point 4 dead band		
118	00A9	Control point 5 dead band		
119	00AA	Control point 6 dead band		
120	00AB	Control point 7 dead band		
121	00B0	Control point 0 fuzzy strength	Range: 0000 to 0063 (0 to 99) (See note 1.) Unit: 1% Default: 0032 (50)	Numeric Read/write
122	00B1	Control point 1 fuzzy strength		
123	00B2	Control point 2 fuzzy strength		
124	00B3	Control point 3 fuzzy strength		
125	00B4	Control point 4 fuzzy strength		
126	00B5	Control point 5 fuzzy strength		
127	00B6	Control point 6 fuzzy strength		
128	00B7	Control point 7 fuzzy strength		

Numeric data for the values in the above table is all expressed as 16-bit signed binary (two’s complement for negative values)

- Note**
1. Numeric data cannot be modified during auto-tuning.
 2. Auto-tuning cannot be executed when operation is stopped. The sequential auto-tuning function is not supported with DeviceNet communications.
 3. If an instruction to stop operation is executed during auto-tuning, operation will stop after auto-tuning is cancelled.
 4. The setting ranges vary depending on the setting unit used, as shown in the following table.

Temperature sensor	Setting range			
	Setting unit (1)		Setting unit (0.1)	
	°C	°F	°C	°F
K	FF38 to 0514 (-200 to 1300)	FED4 to 08FC (-300 to 2300)	F830 to 32C8 (-200.0 to 1300.0)	F448 to 59D8 (-300.0 to 2300.0)
J	FF9C to 0352 (-100 to 850)	FF9C to 05DC (-100 to 1500)	FC18 to 2134 (-100.0 to 850.0)	FC18 to 3A98 (-100.0 to 1500.0)
R	0000 to 06A4 (0 to 1700)	0000 to 0BB8 (0 to 3000)	0000 to 4268 (0.0 to 1700.0)	0000 to 7530 (0.0 to 3000.0)
S	0000 to 06A4 (0 to 1700)	0000 to 0BB8 (0 to 3000)	0000 to 4268 (0.0 to 1700.0)	0000 to 7530 (0.0 to 3000.0)
T	FF38 to 0190 (-200 to 400)	FED4 to 02BC (-200 to 700)	F830 to 0FA0 (-200.0 to 400.0)	F448 to 1B58 (-300.0 to 700.0)
E	0000 to 0258 (0 to 600)	0000 to 044C (0 to 1100)	0000 to 1770 (0.0 to 600.0)	0000 to 2AF8 (0.0 to 1100.0)
B	0064 to 0708 (100 to 1800)	012C to 0BB8 (300 to 3000)	03E8 to 4650 (100.0 to 1800.0)	0BB8 to 7530 (300.0 to 3000.0)
N	0000 to 0514 (0 to 1200)	0000 to 08FC (0 to 2300)	0000 to 32C8 (0.0 to 1300.0)	0000 to 59D8 (0.0 to 2300.0)
L	FF9C to 0352 (-100 to 850)	FF9C to 05DC (-100 to 1500)	FC18 to 2134 (-100.0 to 850.0)	FC18 to 3A98 (-100.0 to 1500.0)
U	FF38 to 0190 (-200 to 400)	FED4 to 02BC (-300 to 700)	F830 to 0FA0 (-200.0 to 400.0)	F448 to 1B58 (-300.0 to 700.0)
W/Re5-26	0000 to 08FC (0 to 2300)	0020 to 1004 (0 to 4100)	0000 to 59D8 (0.0 to 2300.0)	0140 to 7D00 (32 to 3200.0)

Temperature sensor	Setting range			
	Setting unit (1)		Setting unit (0.1)	
	°C	°F	°C	°F
PL II	0000 to 0514 (0 to 1300)	0000 to 08FC (0 to 2300)	0000 to 32C8 (0.0 to 1300.0)	0000 to 59D8 (0.0 to 2300.0)
Pt	FF9C to 01F4 (-100 to 500)	FF9C to 0384 (-100 to 900)	FC18 to 1388 (-100.0 to 500.0)	FC18 to 2328 (-100.0 to 900.0)
JPt	FF9C to 01F4 (-100 to 500)	FF9C to 0384 (-100 to 900)	FC18 to 1388 (-100.0 to 500.0)	FC18 to 2328 (-100.0 to 900.0)
Alarm setting range	D8F1 to 270F (-9999 to 9999)		D8F1 to 7530 (-999.9 to 3000.0)	

- If an E5ZD-SDL Setting Display Unit is used with the E5ZE, and the setting unit is 0.1°C/°F, the setting range will be limited to F831 to 270F (-199.9 to 999.9).
- If the alarm temperature that is read is more than 7530 (Hex), the temperature will be read as 7FFF (Hex), and if the alarm temperature is less than D8F1 (Hex), then the temperature will be read as 8000 (Hex).

5. The meaning of the Auto-tuning Start/Stop Bits is as follows:

Auto-tuning Start/Stop

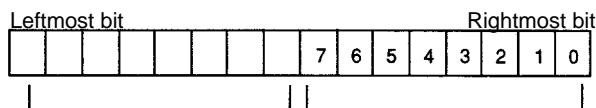

Set bits 8 to 15 to 00000000. Set the bits corresponding to the control points to be auto-tuned to 1 and then write the data. To stop auto-tuning, set the bits corresponding to the control points to be stopped to 0 and then write the data.

6. The contents of the Operation Start/Stop Bit is the same as that for the remote I/O, as shown here.

Read: 0: Operation stopped.

1: Controlling temperature or operating manually.

Write: 0: Stop operation.

1: Start or continue temperature control or continue manual operation. (Even if 1 is written to a control point that is being operated manually it will not start temperature control.)

7. The meaning of the operating status bits is as follows:

Operating Status

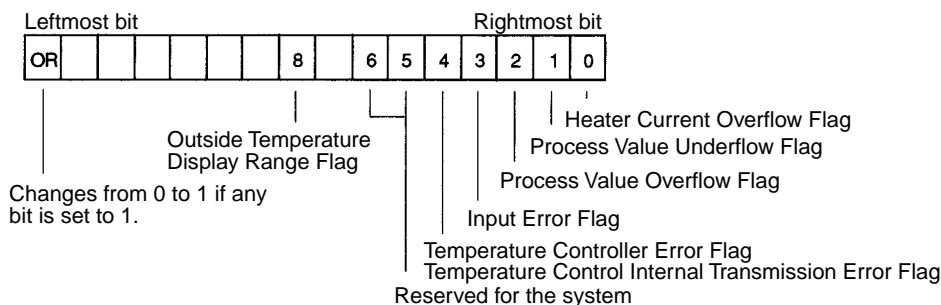

8. Control points that have been set to disable the HB and HS alarms, and control points that are not operating will be read as 0000 (hex).

4-4-2 Reading/Writing using Variable Type 90

The table for variable type 90 shows that the addresses are not continuous when the type of set value or measurement value changes. Groups of set values and measurement values that are not in consecutive addresses and include different types of data, however, can be read or written together.

Example: To read the data from the proportional band of control point 0 to the derivative time of control point 7 in one operation, set the data elements as shown here. The data for the addresses in between will also be read

First read address: 0044 (hex) (control point 0 proportional band address)

Number of elements: 0018 (hex) (24 elements)

If, however, there are write-only set values within the range to be read in succession, or read-only set values and measurement values within the range to be written, an error will occur.

The limit on the number of set values for which communications can be performed at one time varies depending on the Master Unit being used. Refer to the *DeviceNet (CompoBus/D) Operation Manual (Cat. No. W267)* or the *CS1W-DRM21 DeviceNet Unit Operation Manual (Cat. No. W380)* for details on set value limitations.

4-4-3 Operation Variables

The following table shows the variable types that are used for operating the E5ZE. If the set value is also in the table for variable type 90, either variable type can be used to change values.

Variable Type: 83

Address	Set value	Data setting or monitoring range	Data type
0002	Auto-tuning Start (See note 2.)	Range: 0001 to 00FF	Status Write only
0003	Auto-tuning Stop		
0004	Manual Operation Start (See notes 3 and 6.)		
0005	Write Set Values	0001	
0006	Initialize Set Values (See notes 4 and 5.)		

Operation Command Data Contents

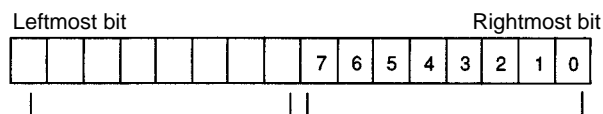

Set to 00000000.

When the bit corresponding to the control point to be operated is set to 1, writing will start.

- Note**
1. The Temperature Control Start Command cannot be executed while auto-tuning is being executed.
 2. The Auto-tuning Start Command cannot be executed while operation is stopped or the Unit is being manually operated.
 3. The Manual Operation Start Command cannot be executed while auto-tuning is being executed.
 4. The Initializing Setting Data Command can be executed only when the Unit is stopped.

5. When the Initializing Setting Data command is executed, the parameters in the storage area will be reset to the factory-set default values even if the E5ZE is in RAM write mode.
6. Set the Temperature Control Start/Stop Bit for the applicable control point to 1 before starting manual operation. (Refer to the graph in the next section.)

4-4-4 Relationship between Operating Status and Operating Commands

The relationship between operating commands from the remote I/O Temperature Control Start/Stop Bit and operating commands from DeviceNet explicit messages or the RS-232C auxiliary setting jack is represented in the following graph. Remote I/O data is refreshed every 200 ms. Operating commands that are different from the status of the remote I/O Temperature Control Start/Stop Bit will, therefore, be momentarily effective and will then immediately change to the commands from the remote I/O.

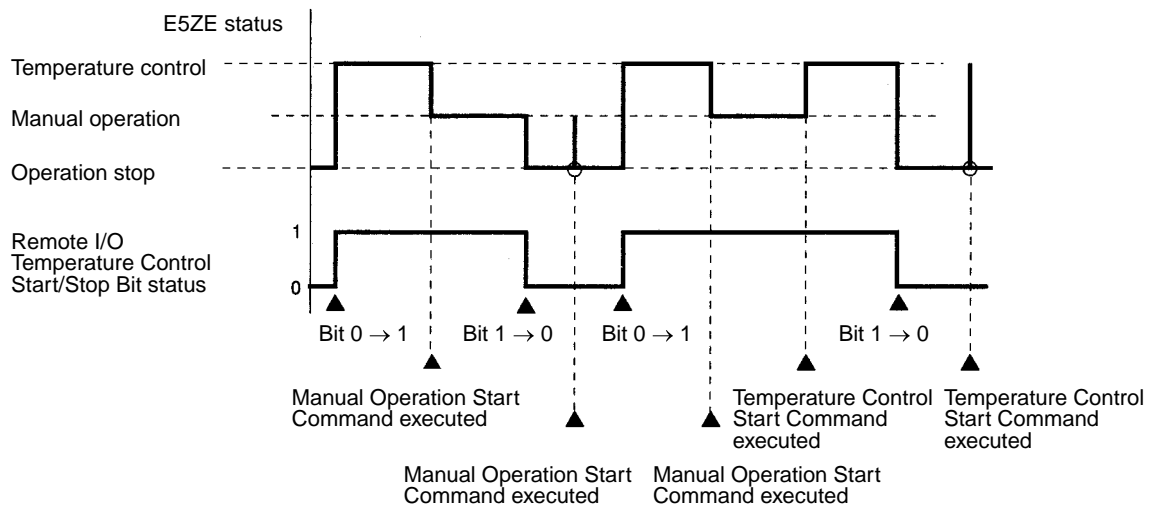

4-4-5 Set Values in Memory Banks

The following variable type table shows the information required to monitor or change the settings for the control points in memory banks 0 to 7.

Variable Type: 88

No.	Address	Set value or measurement value	Default	Data setting or monitoring range	Data type
1	XY00	Set point (read only)	0000	Depends on the input type and setting unit. (Refer to page 25.)	Numeric Read/write
2	XY01	Alarm 1 temperature (See note 1.)	0000	Depends on setting unit. (Refer to page 25.)	
3	XY02	Alarm 2 temperature (See note 1.)	0000		
4	XY03	Proportional band	0000	Range: 0000 to 270F (0.0 to 999.9) Unit: 0.1°C/°F	
5	XY04	Integral time	0000	Range: 0000 to 0F9F (0 to 3999)	
6	XY05	Derivative time	0000	Unit: 1 s	
7	XY06	Heating hysteresis	See note 3	Range: 0000 to 03E7 (0.0 to 99.9) Unit: 0.1°C/°F	
8	XY07	Input shift value	0000	Range: FC19 to 03E7 (-99.9 to 99.9) Unit: 0.1°C/°F	
9	XY08	Heater burnout detection current	0000	Range: 0000 to 01F4 (0.0 to 50.0) Unit: 0.1 A	
10	XY09	Control period (heating)	0002	Range: 0001 to 0063 (0 to 99) Unit: 1 s	
11	XY0A	Manual reset value	01F4	Range: 0000 to 03E8 (0.0 to 100.0) Unit: 0.1%	
12	XY0B	Heating output variable lower limit	0000		
13	XY0C	Heating output variable upper limit	03E8		
14	XY0D	Ramp value (See note 1.)	0000	Range: 0000 to 03E7 (0.0 to 99.9) Unit: 0.1	
15	XY0E	Ramp time unit (See note 1.)	0000	0000: s, 0001: min, or 0002: hr	
16	XY0F	Output variable change rate limit	0000	Range: 000 to 03E8 (0.0 to 100.0) Unit: 0.1% per sampling period	
17	XY10	Dead band	0000	Range: FC19 to 03E7 (-999 to 999) Unit: 1°C/°F	
18	XY11	Cooling coefficient	000A	Range: 0000 to 0064 (0.0 to 10.0) Unit: 0.1	
19	XY12	Cooling hysteresis	See note 3	Range: 0000 to 03E7 (0.0 to 99.9) Unit: 0.1°C/°F	
20	XY13	Cooling control period	0002	Range: 0001 to 0063 (0 to 99) Unit: 1 s	
21	XY14	Cooling output variable lower limit	0000	Range: 0000 to 03E8 (0.0 to 100.0) Unit: 0.1%	
22	XY15	Cooling output variable upper limit	03E8		
23	XY16	Fuzzy strength	0032	Range: 0000 to 0063 (0 to 99) Unit: 1%	
24	XY17	Fuzzy scale 1	270F	Range: 0002 to 270F (0.2 to 999.9) Unit: 0.1°C/°F	
25	XY18	Fuzzy scale 2	270F	Range: 0014 to 270F (0.20 to 99.99) Unit: 0.01	

- Set the values of X and Y in the addresses as follows:
 X: Control point number (0 to 7). Set “A” for all control points.
 Y: Memory bank number (0 to 7). Set “8” for the current memory bank or “A” for all memory banks. The setting A is valid for writing only.
 X and Y cannot both be set to A at the same time.
Example: To set the alarm 1 temperature in memory bank 3 for control point 5, the address would be 5301 (hex).
- Set values cannot be written while auto-tuning is being executed.

- Numeric values are expressed as 16-bit signed binary (two's complement for negative values).

- Note**
- These parameters can be written while auto-tuning is being executed.
 - The following settings are not possible
 Heating output variable lower limit > Heating output variable upper limit
 Cooling output variable lower limit > Cooling output variable upper limit
 - The default is 0008 hexadecimal (0.8°C) when the temperature unit is degrees Celsius, and 000F hexadecimal (1.5°F) when it is degrees Fahrenheit.

4-4-6 Measurement Values for Individual Control Points

The following variable type is used to monitor various measurement values at the same time for each control point.

Variable Type: 80

No.	Address	Set value or measurement value	Data setting or monitoring range	Data type
1	X001	Status (See note.)	Range: 0000 to FFBF	Numeric Read only
2	X002	Heating output variable	Range: 0000 to 03EB (0.0 to 100.0) Unit: 0.1%	
3	X003	Heater current	Range: 0000 to 0226 (0.0 to 55.0) Unit:	
4	X004	Cooling output variable	Range: 0000 to 03EB (0.0 to 100.0) Unit: 0.1%	
5	X005	Current set point	Depends on the input type, setting unit, and temperature unit	
6	X006	Current memory bank	Range: 0000 to 0007	
7	X007	SSR failure current value	Range: 0000 to 0226 (0.0 to 55.0) Unit: 0.1 A	

Set the value of X in the address to the applicable control point number (0 to 7).

Note The following diagram shows the status contents. Treat the bits specified as reserved for the system as being any status.

Status

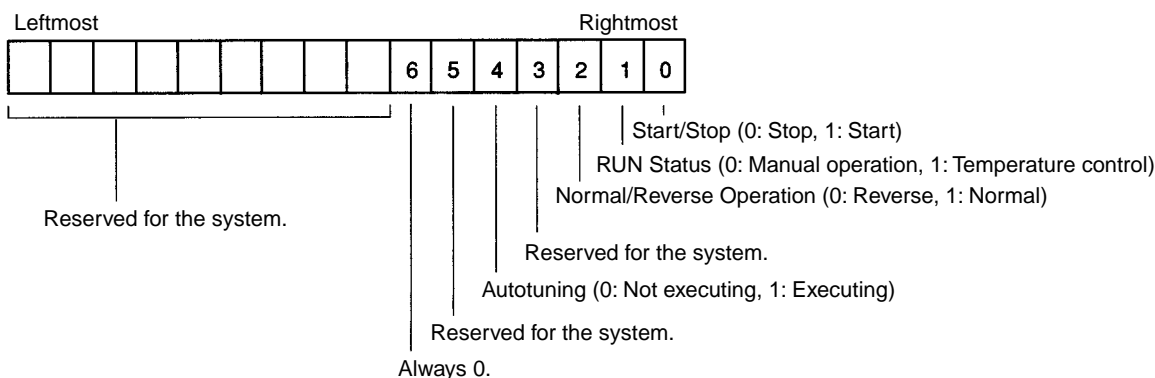

4-4-7 Set Values for all Control Points

The following variable table is used for setting and monitoring the same set values for all control points.

Variable Type: 88

No.	Address	Set value or measurement value	Default	Data setting or monitoring range	Data type
1	XF00	Memory bank (See note 3.)	0000	Range: 0000 to 0007 (See note 5.)	Numeric Read/write
2	XF01	Alarm 1 mode (See note 1.)	0000	Range: 0000 to 000C	
3	XF02	Alarm 2 mode (See note 1.)	0000		
4	XF03	Output operation (direct/reverse)(See note 1.)	0000	0000: Reverse operation 0001: Direct operation	
5	XF04	Heating manual output variable (See note 4.)	0000	Range: 0000 to 03E8 (0.0 to 100.0) Unit: 0.1%	
6	XF05	HB/HS alarm enable setting (See note 1.)	0000	0000: HB/HS alarm disabled 0001: HB/HS alarm enabled	Status Read/write
7	XF06	Heater burnout detection current value (See note 2.)	0000	Range: 0000 to 01F4 (0.0 to 50.0) Unit: 0.1 A	Numeric Read/write
8	XF07	SSR failure detection current value (See note 2.)	0000		
9	XF08	Cooling manual output variable (See note 4.)	0000	Range: 0000 to 03E8 (0.0 to 100.0) Unit: 0.1%	

- Set the value of X in the addresses as follows:
X: Control point number (0 to 7). Set “A” all control points. The setting A is valid for writing only.
- Set values cannot be changed while auto-tuning is being executed.

Note

1. These parameters can be set only when operation is stopped.
2. These parameters can be set while auto-tuning is being executed.
3. When external contact inputs are used to set the memory bank, the memory banks cannot be switched using communications.
4. The manual output variable can be set only during manual operation. This applies to both heating and cooling control.
5. The relationship between the set point and alarm mode is as shown below.

Set point	Alarm mode
0000	No alarm
0001	Upper- and lower-limit alarm
0002	Upper-limit alarm
0003	Lower-limit alarm
0004	Upper- and lower-limit range alarm
0005	Upper- and lower-limit alarm with standby sequence
0006	Upper-limit alarm with standby sequence
0007	Lower-limit alarm with standby sequence
0008	Absolute-value upper-limit alarm
0009	Absolute-value lower-limit alarm
000A	Absolute-value upper-limit alarm with standby sequence
000B	Absolute-value lower-limit alarm with standby sequence
000C	HB alarm and HS alarm (general alarm)

4-4-8 Set Values for All Control Points

The following variable table is used for setting and monitoring set values that are used for all control points.

Variable Type: 88

Address	Set value or measurement value	Data setting or monitoring range	Data type
F000	Specification temperature range lower limit (See note.)	Depends on the temperature sensor type used.	Numeric Read only
F001	Specification temperature range upper limit (See note.)		
F002	Temperature unit	0: °C or 1: °F	
F003	Setting unit	0: 1°C/°F or 1: 0.1°C/°F Default: 0	Numeric Read/write

Note When a W sensor is used with the setting unit set to 0.1°C/°F, the upper limit will be read as 7D00.

SECTION 5

Communications Errors

This section provides information on response end codes and indicator statuses used to troubleshoot E5ZE DeviceNet explicit communications errors.

5-1	End Codes	34
5-1-1	Checking FINS Command 2801 End Code	34
5-1-2	Checking DeviceNet Error Codes.	34
5-1-3	Checking 0101 (Read) and 0102 (Write) Commands End Codes . .	35
5-2	Indicators.	37

5-1 End Codes

The results of communications with the E5ZE using DeviceNet explicit messages can be confirmed using the response end codes. Perform any error processing using the communications program according to the contents of the end codes.

Check the end code using the following procedure.

- 1,2,3...
1. Check the end code of FINS command 2801 (OMRON PC Masters only).
 2. Check the end code of the DeviceNet explicit message.
 3. Check the end codes of commands 0101 and 0102.

Check the end codes in the order given above.

28	01	End code 2801	No. of bytes received	Source MAC ID	Service code	Service data
----	----	------------------	--------------------------	------------------	-----------------	--------------

Note This data is valid only when using an OMRON PC Master. If using a master not manufactured by OMRON, refer to the manual for that master.

5-1-1 Checking FINS Command 2801 End Code

The command has ended normally when the response code is 0000. If the response code is not 0000, an error has occurred. If an error occurs, the data following the end code will be lost. For error code details, refer to the *DeviceNet (CompoBus/D) Operation Manual (Cat. No. W267)* or the *CS1W-DRM21 DeviceNet Unit Operation Manual (Cat. No. W380)*. Command 2801 errors are detected by the PC or the DeviceNet Master.

5-1-2 Checking DeviceNet Error Codes

Normal End

28	01	00	00	No. of bytes received	Source MAC ID	B4	0101 or 0102	Response code for command on left.
----	----	----	----	--------------------------	------------------	----	-----------------	--

Service code

Note This data is valid only when using an OMRON PC Master. If using a master not manufactured by OMRON, refer to the manual for that master.

The command has ended normally when the service code is B4.

Error

28	01	00	00	No. of bytes received	Source MAC ID	94	DeviceNet error code
----	----	----	----	--------------------------	------------------	----	-------------------------

Service code

Note This data is valid only when using an OMRON PC Master. If using a master not manufactured by OMRON, refer to the manual for that master.

If an error has occurred, the service code will be 94. The DeviceNet error code will be added after the service code. The error code meanings and remedies are described below.

DeviceNet Error Codes

Error code	Meaning		Remedy
08FF	Service not supported	Invalid service code or instance ID	Check the service code and instance ID settings.
16FF	Object does not exist	Invalid class ID	Check the class ID settings.
16FF	Device state conflict	A processing error has occurred in the Temperature Controller.	Resend the DeviceNet explicit message.
0CFF	Object state conflict	A new command was received while processing the previous command.	Wait for a response to the command being processed, and then send a new command.

5-1-3 Checking 0101 (Read) and 0102 (Write) Commands End Codes

Read

The responses to commands 0101 and 0102 are described below. The commands have ended normally when the response code is 0000.

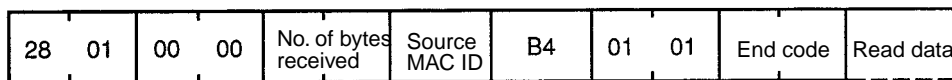

Note This data is valid only when using an OMRON PC Master. If using a master not manufactured by OMRON, refer to the manual for that master.

Write

Note This data is valid only when using an OMRON PC Master. If using a master not manufactured by OMRON, refer to the manual for that master.

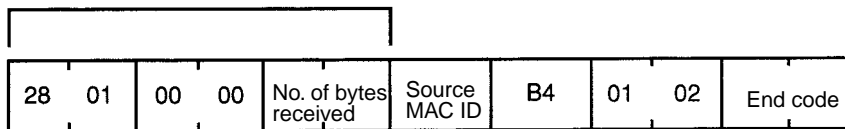

Error code: 0204	Name: Busy error
-------------------------	-------------------------

Meaning

A processing error has occurred in the E5ZE.

Processing

Turn ON the power to E5ZE again. If the E5ZE is set to continuous communications and messages are being transmitted, increase the interval between transmissions.

Error code: 0401	Name: Undefined command
-------------------------	--------------------------------

Meaning

A command that is not supported by the Unit has been used.

Processing

Check the contents of the command data.

Error code: 1001	Name: Command length too long
-------------------------	--------------------------------------

Meaning

The command is longer than the maximum permissible length.

Processing

Check the contents of the command data and re-enter it correctly.

Error code: 1002:	Name: Command length too short
--------------------------	---------------------------------------

Meaning

The command is shorter than the minimum permissible length.

Processing

Check the contents of the command data and re-enter it correctly.

Error code: 1003	Name: Number of data elements and data do not match
-------------------------	--

Meaning

The number of data elements do not match the number of write data in the command data.

Processing

Specify the command data so that the number of data elements match.

Error code: 1005	Name: FINS header error
-------------------------	--------------------------------

Meaning

The command format received is incorrect.

Processing

Check the communications conditions. If the communications conditions match, there is a malfunction in the communications circuit at the Master Unit, at the E5ZE, or at both Units.

Error code: 1100	Name: Parameter error
-------------------------	------------------------------

Meaning

There is an error in the command data or the parameters are set outside the permissible range.

Processing

Check the setting range and rewrite or reread the correct parameter values.

Error code: 1101	Name: Incorrect memory area
-------------------------	------------------------------------

Meaning

The variable type code is set incorrectly.

Processing

Check the variable type code and re-enter it correctly.

Error code: 1103	Name: First address outside range
-------------------------	--

Meaning

The first address in the command data is set incorrectly or the address is set to words that do not exist in the set value and measurement value table.

Processing

Check the first address referring to the DeviceNet explicit messages set value and measurement value table, and re-enter the correct address.

Error code: 1104	Name: End address outside range
-------------------------	--

Meaning

The end address in the command data is set incorrectly or the address is set to words that do not exist in the set value and measurement value table.

Processing

Check the permissible end address setting range referring to the DeviceNet explicit messages set value and measurement value table, and re-enter the correct address.

Error code: 110B	Name: Excessive response block length
-------------------------	--

Meaning

The response block is longer than the permissible maximum length (512 bytes).

Processing

Check the command format, and re-enter the data elements within the permissible range (512 bytes). The restrictions on the length of the response block depend on the capacity of the Master Unit. Make sure that the maximum response block length is not exceeded even if the length is within 512 bytes.

Error code: 2203	Name: Mode error
-------------------------	-------------------------

Meaning

Command did not execute. The following may have caused the mode error.

- Executing a command apart from Operation Stop (OP) or Auto-tuning Stop (AP) was attempted during auto-tuning.
- Executing Auto-tuning Start (AS) when operation is stopped.
- Writing a memory bank number when setting the memory bank using contact input.

Processing

Read or write the parameters in a different operation mode.

Error code: 3002	Name: Write only
-------------------------	-------------------------

Meaning

Attempt to read data from an area that is write-only.

Processing

Check the first address and number of data elements in the DeviceNet explicit messages set value and process value table and re-enter the correct address and number of data elements.

Error code: 3003	Name: Read only
-------------------------	------------------------

Meaning

Attempt to write in an area that is read-only.

Processing

Check the first address and number of data elements in the DeviceNet explicit messages set value and process value table and re-enter the correct address and number of data elements.

5-2 Indicators

DeviceNet errors are indicated by the status of the MS and NS indicators on the E5ZE. The following table shows the relationship between the indicator status and the corresponding error.

Indicator Status and Meaning

Indicator status		Network status	Probable cause and remedy
MS	NS		
ON (green)	ON (green)	Remote I/O or message communications in progress	E5ZE is communicating normally.
ON (green)	OFF	Checking for node address duplication	Checking whether the Unit's node address has been set on another node.
ON (green)	Flashing (green)	Waiting for connection	The Unit is waiting for a connection from the Master Unit.
ON (red)	OFF	Watchdog timer error	A watchdog timer error occurred in the Unit. Replace the Unit.
Flashing (red)	OFF	Incorrect switch settings	A mistake has been made in the DeviceNet switch settings. Check the settings and restart the Slave.
ON (green)	ON (red)	Node address duplication	The same Slave Unit node address has been set on another node. Change the settings to eliminate the duplication and restart the Slave.
ON (green)	ON (red)	Bus Off error detected	The communications controller detected a Bus Off status and communications have been stopped. Check the following items and restart the Slave Unit. <ul style="list-style-type: none"> • Does the baud rate of the Master and Slave match? • Are cable lengths (trunk lines and branch lines) appropriate? • Are any cables disconnected or loose? • Is terminating resistance applied to both ends of the trunk lines and nowhere else? • Is there excessive noise?
ON (green)	Flashing (red)	Communications timeout	The connection with the Master Unit timed out. A communications time-out error has occurred. Check the following items and restart the Slave Unit. <ul style="list-style-type: none"> • Does the baud rate of the Master and Slave match? • Are cable lengths (trunk lines and branch lines) appropriate? • Are any cables disconnected or loose? • Is terminating resistance applied to both ends of the trunk lines and nowhere else? • Is there excessive noise?

Refer to the *DeviceNet (CompoBus/D) Operation Manual (Cat. No. W267)* for details on error processing.

SECTION 6

Communications Program Examples

This section provides communications programs examples using CVM1 or CV-series PCs and using C200HX/C200HE/C200HG PCs.

6-1	CVM1 and CV-series PCs.....	40
6-2	C200HX/C200HG/C200HE PCs	47
6-3	CS1 PCs	54
6-3-1	Using Programs	54

6-1 CVM1 and CV-series PCs

The programming used in this section provides an example of writing and reading alarm 1 temperatures using message communications for all the E5ZE's control points from a ladder program in a CVM1 Programmable Controller.

Procedure

- 1,2,3...**
1. Transmit the program to the CVM1 PC.
 2. Set the CVM1 PC to RUN or MONITOR Mode.
 3. Set the alarm 1 temperature data to be written in order in words DM00020 to DM00027 for all control points (0 to 7). (This program will set the temperature to 100.0°C (03E8) for all control points.)
 4. Writing will be executed when bit CIO 013100 is turned ON at the CVM1 PC.
 5. When writing is completed, CIO 013100 will turn OFF.
 6. When the bit CIO 013101 is turned ON at the CVM1 PC, reading will be executed.
 7. When reading is completed, CIO 013101 will turn OFF.
 8. The data that has been read will be stored in order in words DM00060 to DM00067 for all control points (0 to 7).
 9. If an attempt is made to execute reading and writing simultaneously, only writing will be executed.

When bit CIO 10001 is ON, writing is performed, and when bit CIO 10006 is ON, reading is performed. If message communications are not executed properly, the same instructions will be executed.

Program Application Conditions

- Set the CVM1-DRM21-EV1 CompoBus/D Master Unit as a CPU Bus Unit to unit number 0.
- Use a CVM1-CPU11-EV2 CPU Unit.
- Set the communications parameters as follows:
 - Baud rate: 500 kbps
 - CVM1-DRM21-EV1 node address: 00
 - E5ZE node address: 32Refer to the *DeviceNet (CompoBus/D) Operation Manual (Cat. No. W267)* for details on using the CMND(194) instruction.
- E5ZE IN start address: CIO 2032 (This address is used only with fixed allocations.)

- The CVM1 work and data memory area details are described in the following tables.

Work Area		Contents
Word	Bit	
CIO 0100	010000	Indicates the interlock is ON. Turns ON when communications between the Master and E5ZE are normal and the E5ZE is in READY Mode.
	010001	Write Request Flag. Turns ON when bit CIO 013100 turns ON, and turns OFF when writing has been completed normally.
	010002	ON when a (1 shot) explicit message has been received.
	010003	---
	010004	---
	010005	ON when an explicit message response is normal.
	010006	Read Request Flag. Turns ON when bit CIO 013101 turns ON, and turns OFF when reading has been completed normally.
	010007	---
	010008	Turns ON when bit CIO 013100 turns ON.
	010009	Turns ON when bit CIO 013101 turns ON.
CIO 0131	013100	Write Start Bit
	013101	Read Start Bit

DM Area words	Contents
D00100 to D00105	Write control code
D00106 to D00111	Read control data
D00012 to D00019	FINS write command header code
D00020 to D00027	Alarm 1 temperature write data for control points 0 to 7
D00040 to D00047	FINS read command header code
D00054 to D00059	Response block header code storage area
D00060 to D00067	Alarm 1 temperature read data for control points 0 to 7
D00080 to D00082	Response code check area

CPU Bus Unit Area		Contents
Word	Bit	
CIO1500	150015	I/O link flag
	150014	Error flag

Ladder Program Example

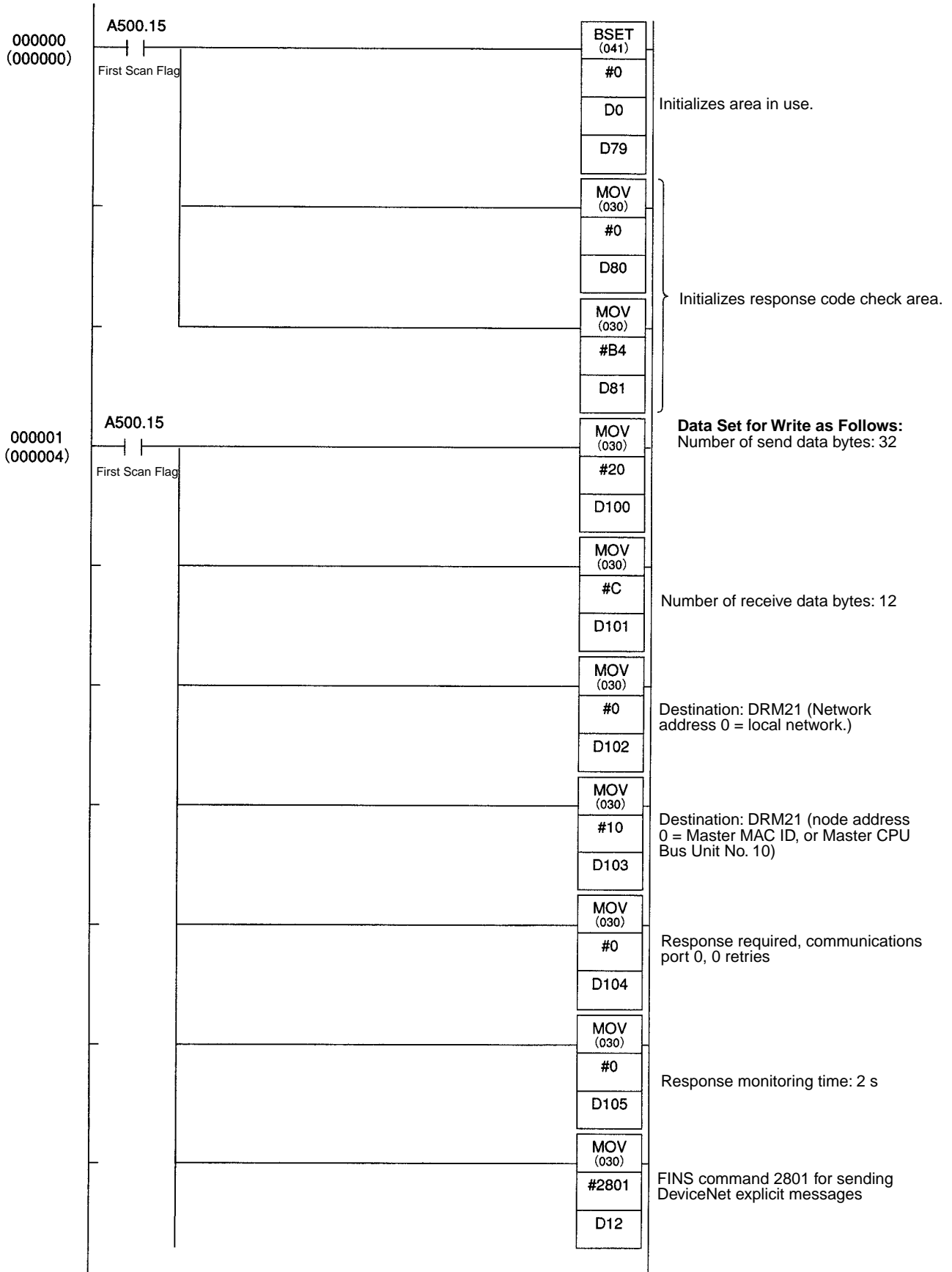

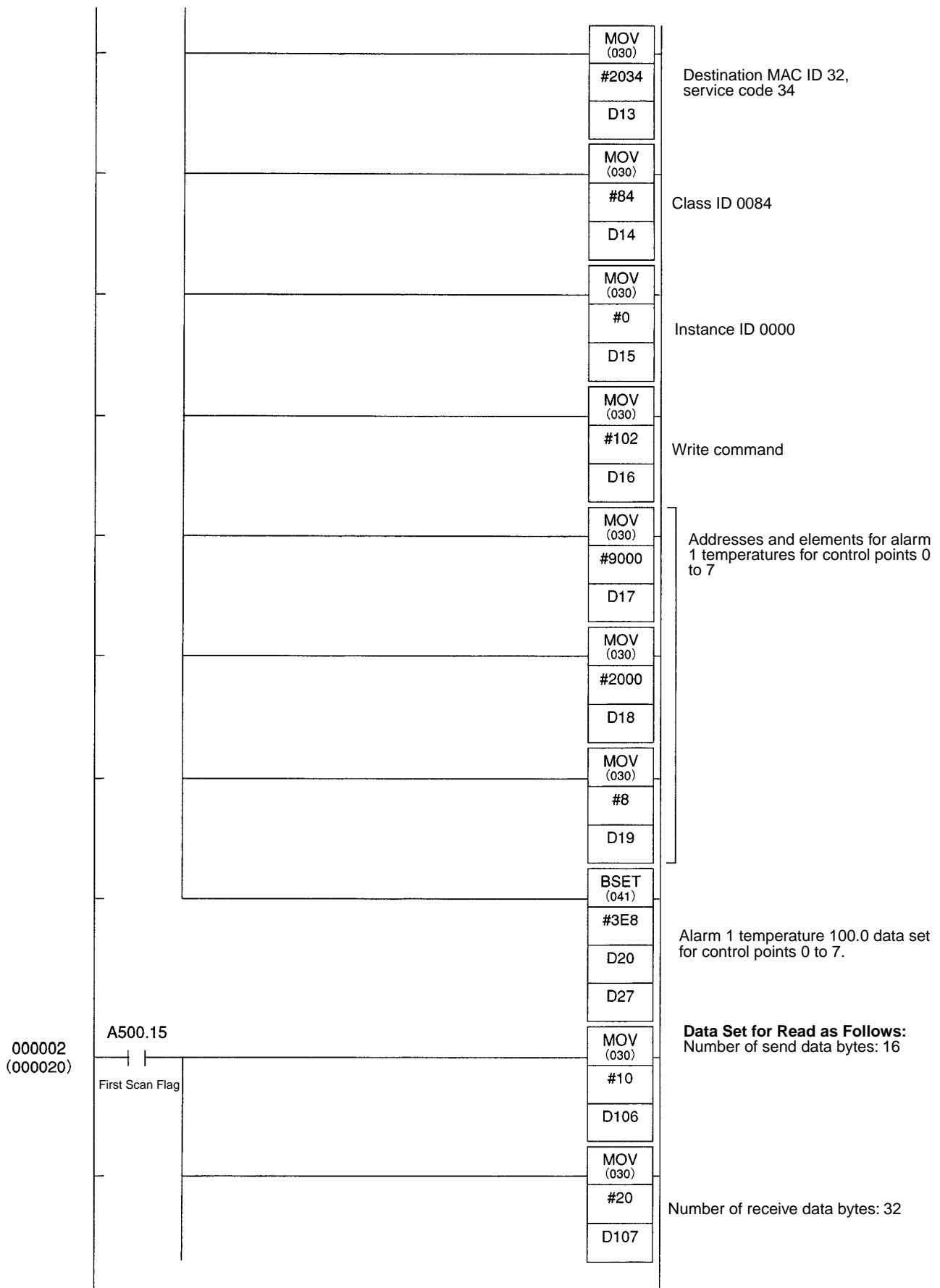

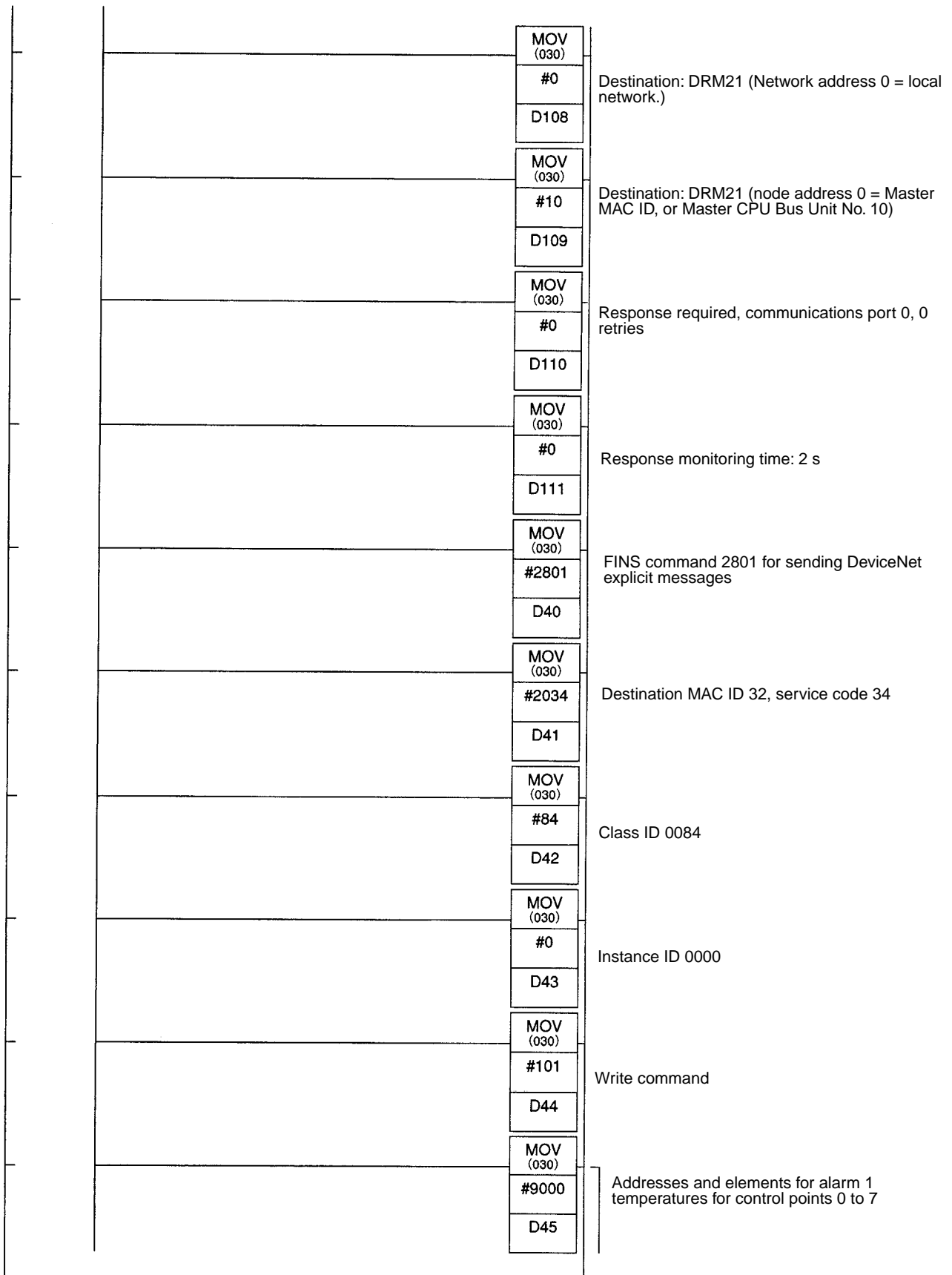

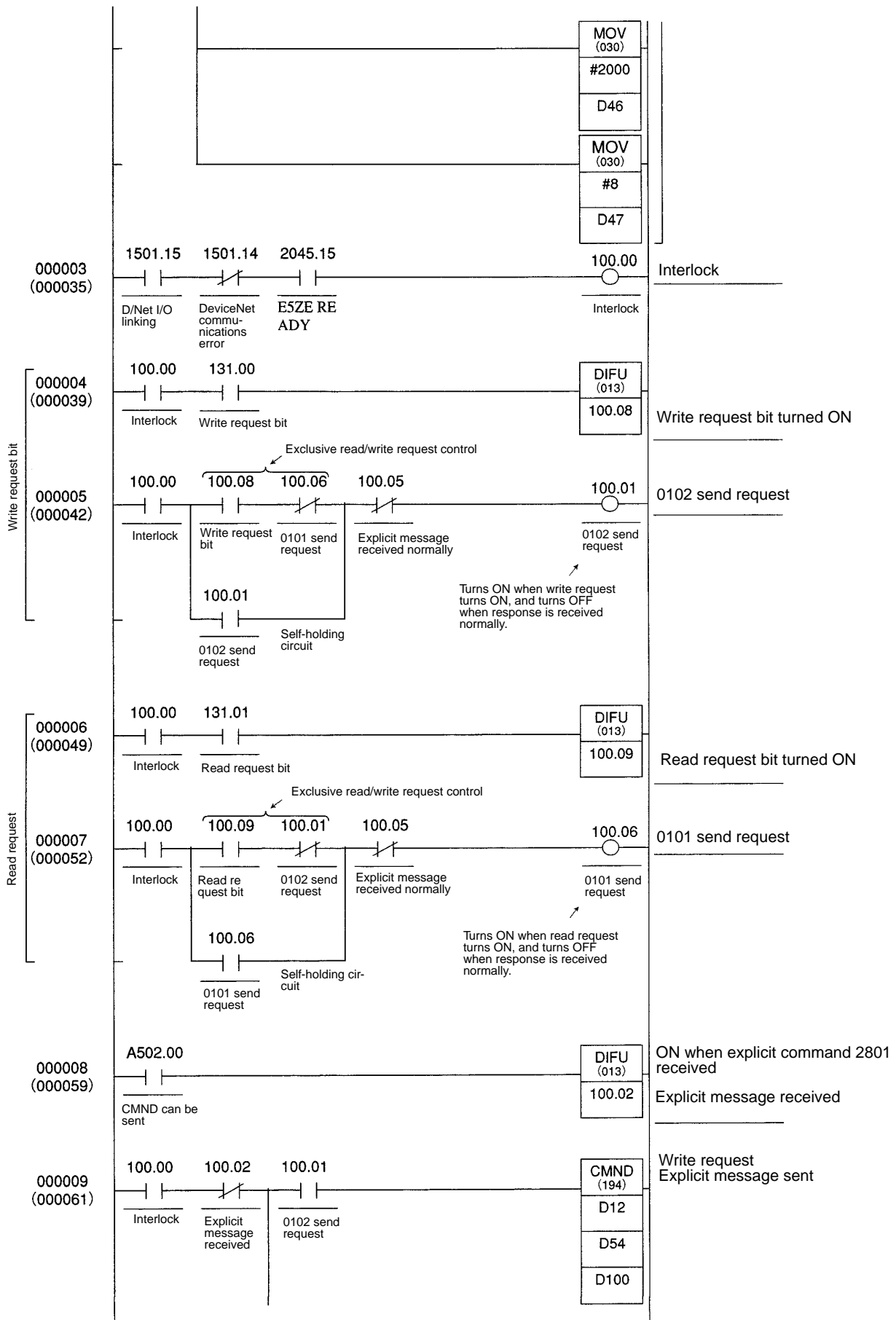

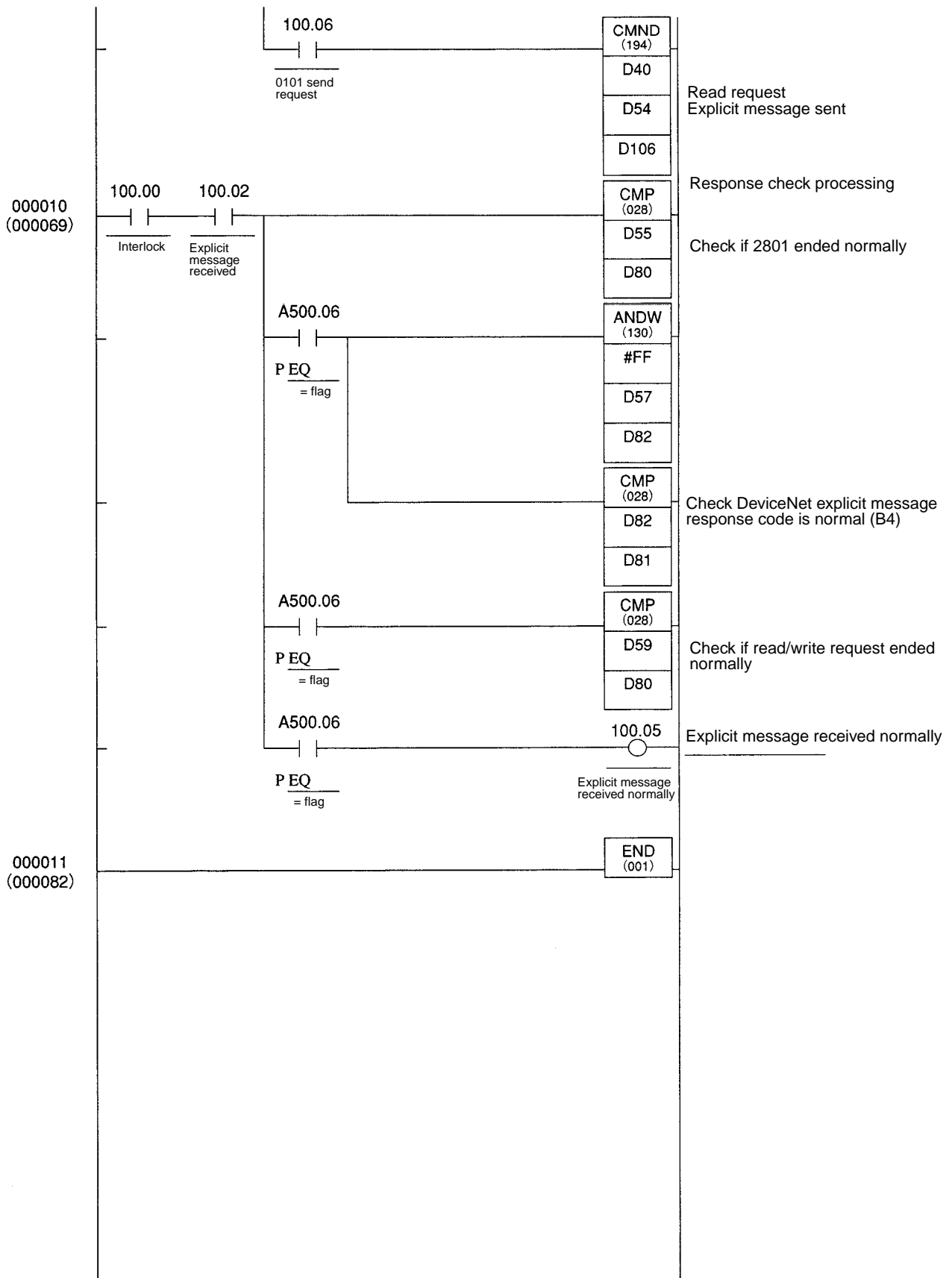

6-2 C200HX/C200HG/C200HE PCs

The programming used in this section provides an example of writing and reading alarm 1 temperatures using message communications for all the E5ZE's control points from a ladder program in a C200HX/C200HG/C200HE Programmable Controller.

Procedure

- 1,2,3...**
1. Transmit the program to the C200HX/C200HG/C200HE PC.
 2. Set the C200HX/C200HG/C200HE PC to RUN or MONITOR Mode.
 3. Set the alarm 1 temperature data to be written in order in words DM0020 to DM0027 for all control points (0 to 7). (This program will set the temperature to 100.0°C (03E8) for all control points.)
 4. Writing will be executed when bit CIO 06000 is turned ON at the C200HX/C200HG/C200HE PC.
 5. When writing is completed, CIO 05001 will turn OFF.
 6. When bit CIO 06001 is turned ON at the C200HX/C200HG/C200HE PC, reading will be executed.
 7. When reading is completed, CIO 05006 will turn OFF.
 8. The data that has been read will be stored in order in words DM0060 to DM 0067 for all control points (0 to 7).
 9. If an attempt is made to execute reading and writing simultaneously, only writing will be executed.

When bit CIO 05001 is ON, writing is performed, and when bit CIO 05006 is ON, reading is performed. If message communications are not executed properly, the same instructions will be executed.

Program Application Conditions

- Set the C200HW-DRM21-EV1 CompoBus/D Master Unit to unit number 0 as a CPU Bus Units.
- Use the CVM1-CPU21-E CPU Unit.
- Set the communications parameters as follows:
 - Baud rate: 500 kbps
 - C200H-DRM21-EV1 node address: 00
 - E5ZE node address: 32Refer to the *DeviceNet (CompoBus/D) Operation Manual (Cat. No. W267)* for details on using the IOWR(223) instruction.
- E5ZE IN start address: CIO 382 (This address is used only with fixed allocation.)
- The following tables show the IR Area 1 and DM Area contents. The function of all of these bits and words is defined by the user for the program.

- Some of the other bits that appear in the program are allocated to the Master Unit. Refer to the *DeviceNet (CompoBus/D) Operation Manual (Cat. No. W267)* for details.

Word	Bit	Contents
CIO 060	06000	Write Start Bit
	06001	Read Start Bit

DM Area words	Contents
D0008 to D0009	First word of write command response storage area
D0010	Response monitoring time
D0011	Command byte length
D0012 to D0015	DeviceNet explicit message FINS header code
D0016 to D0019	FINS command header code (write)
D0020 to D0027	Alarm 1 temperature write data for control points 0 to 7
D0036 to D0037	First word of read command response storage area
D0038	Response monitoring time
D0039	Command byte length
D0040 to D0043	DeviceNet explicit message FINS header code
D0044 to D0047	FINS command header code (read)
D0080 to D0082	Response block end code comparative data
D0054 to D0059	Response block header code storage area
D0060 to D0067	Alarm 1 temperature read data for control points 0 to 7

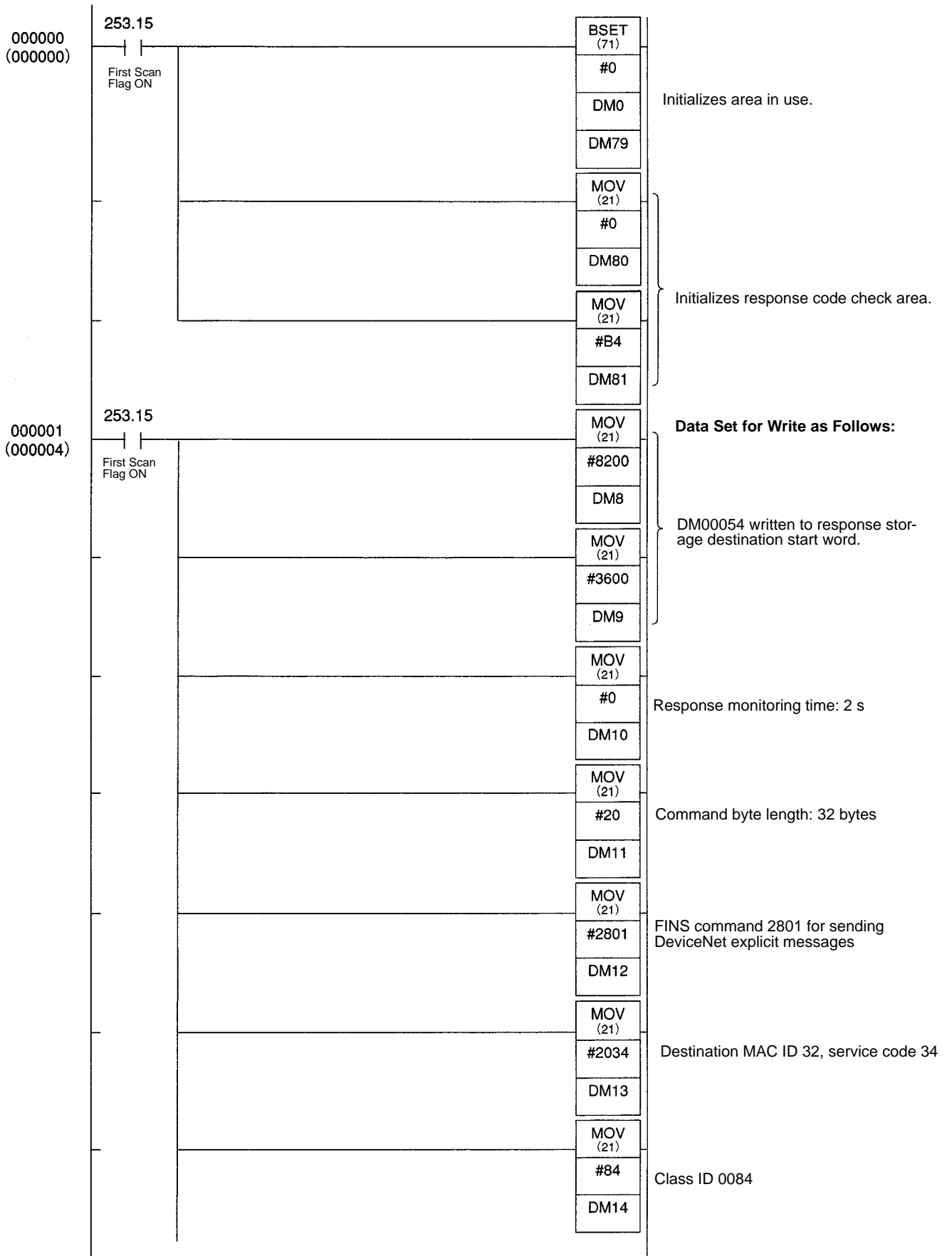

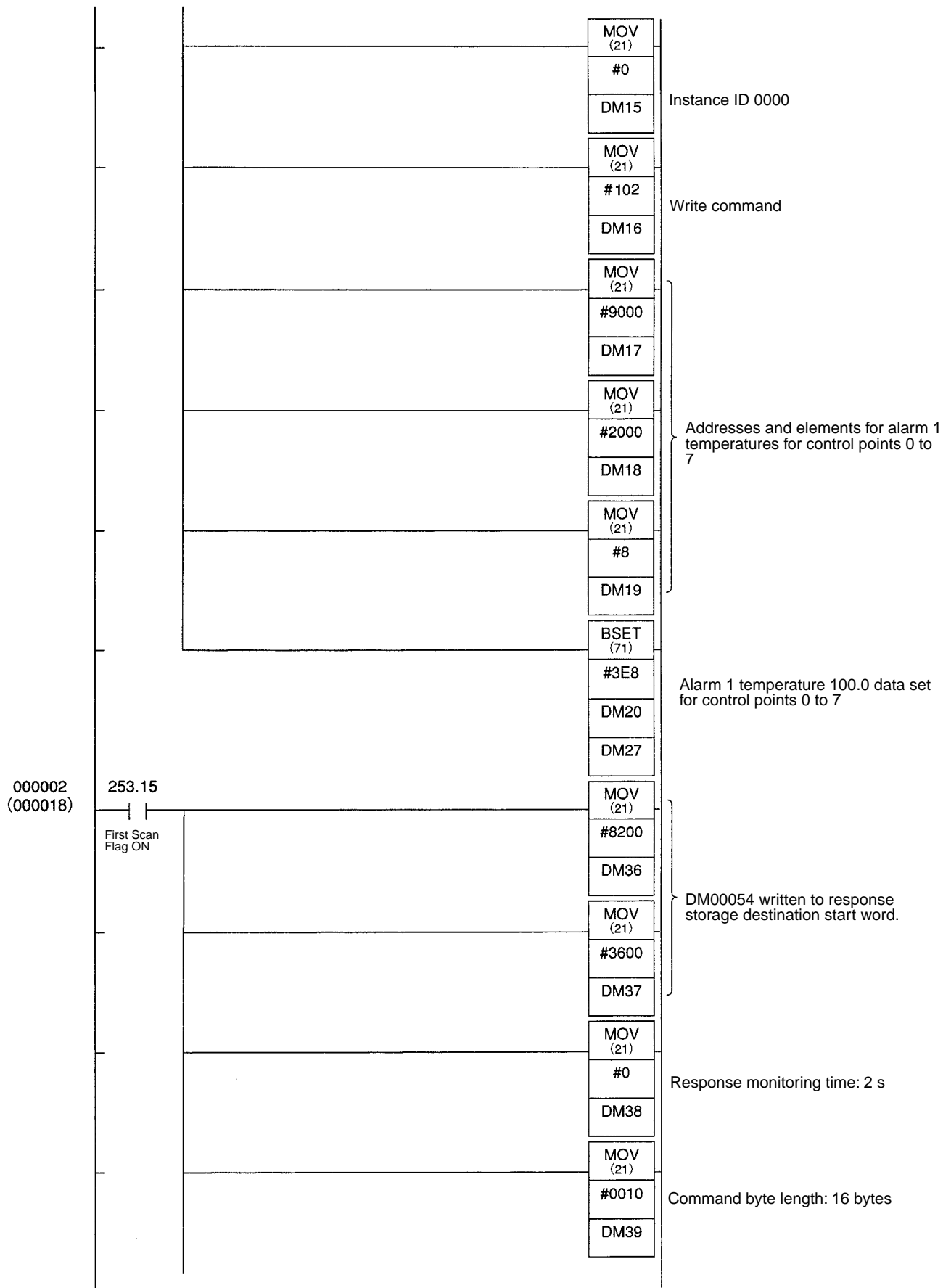

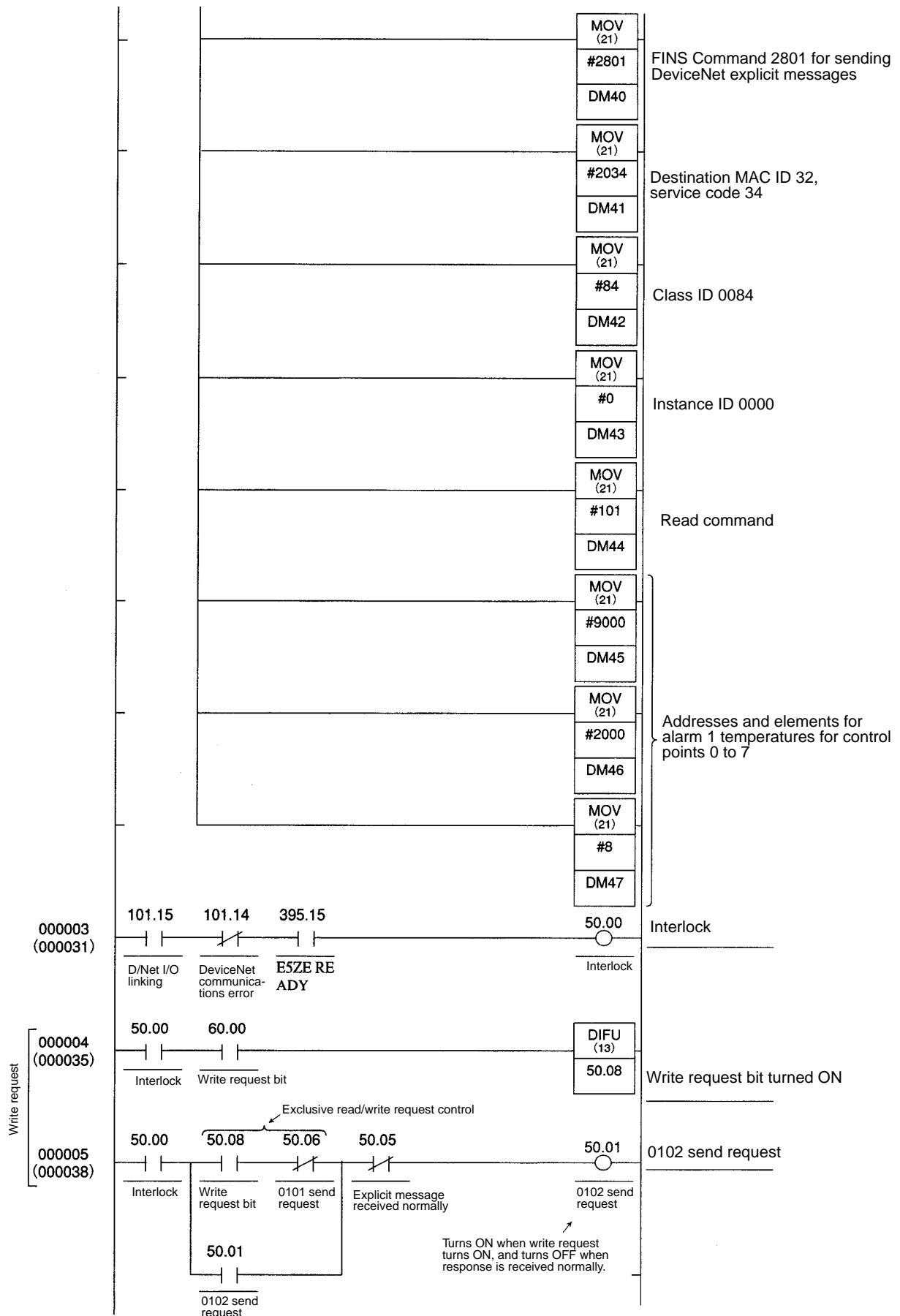

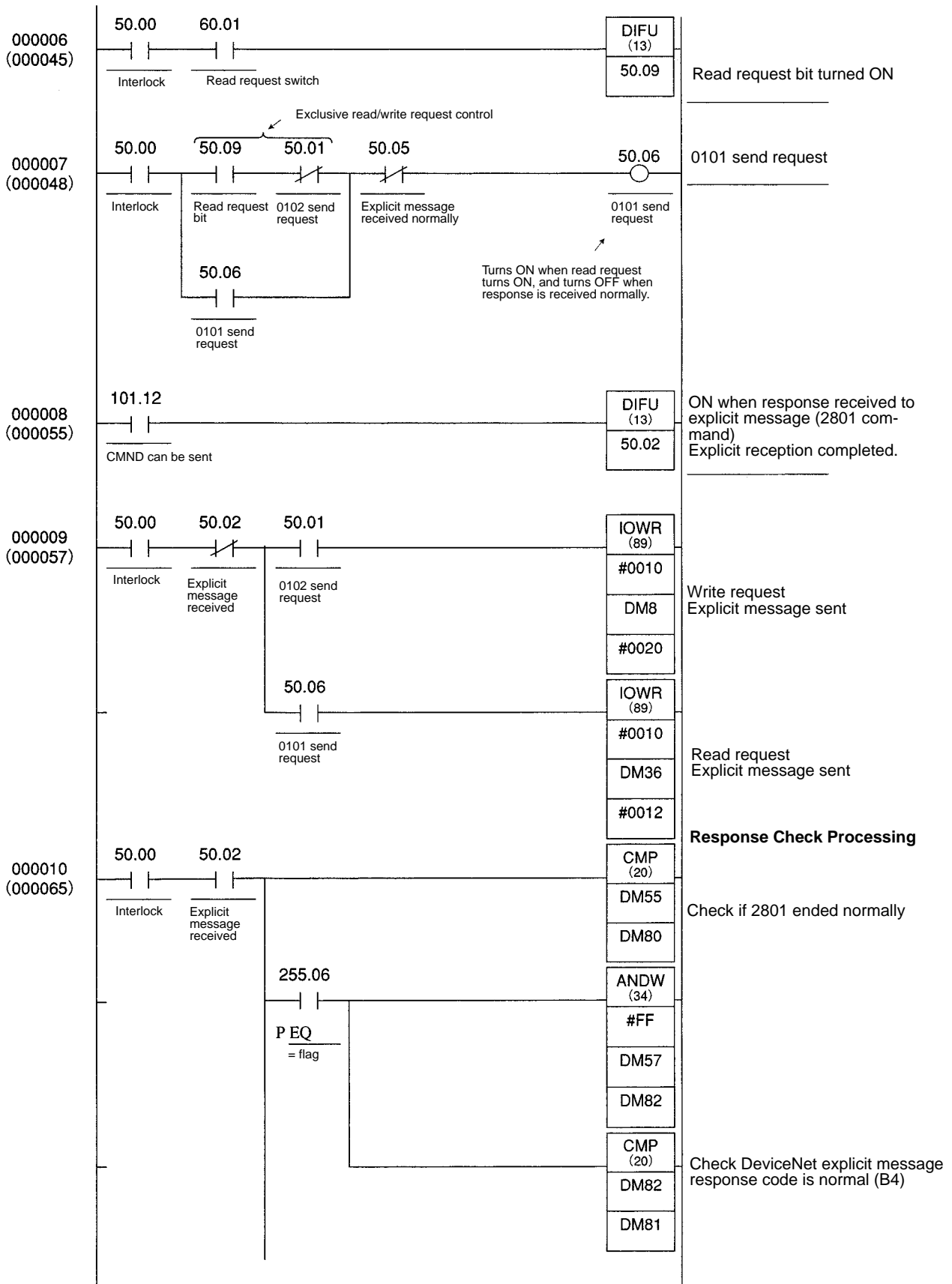

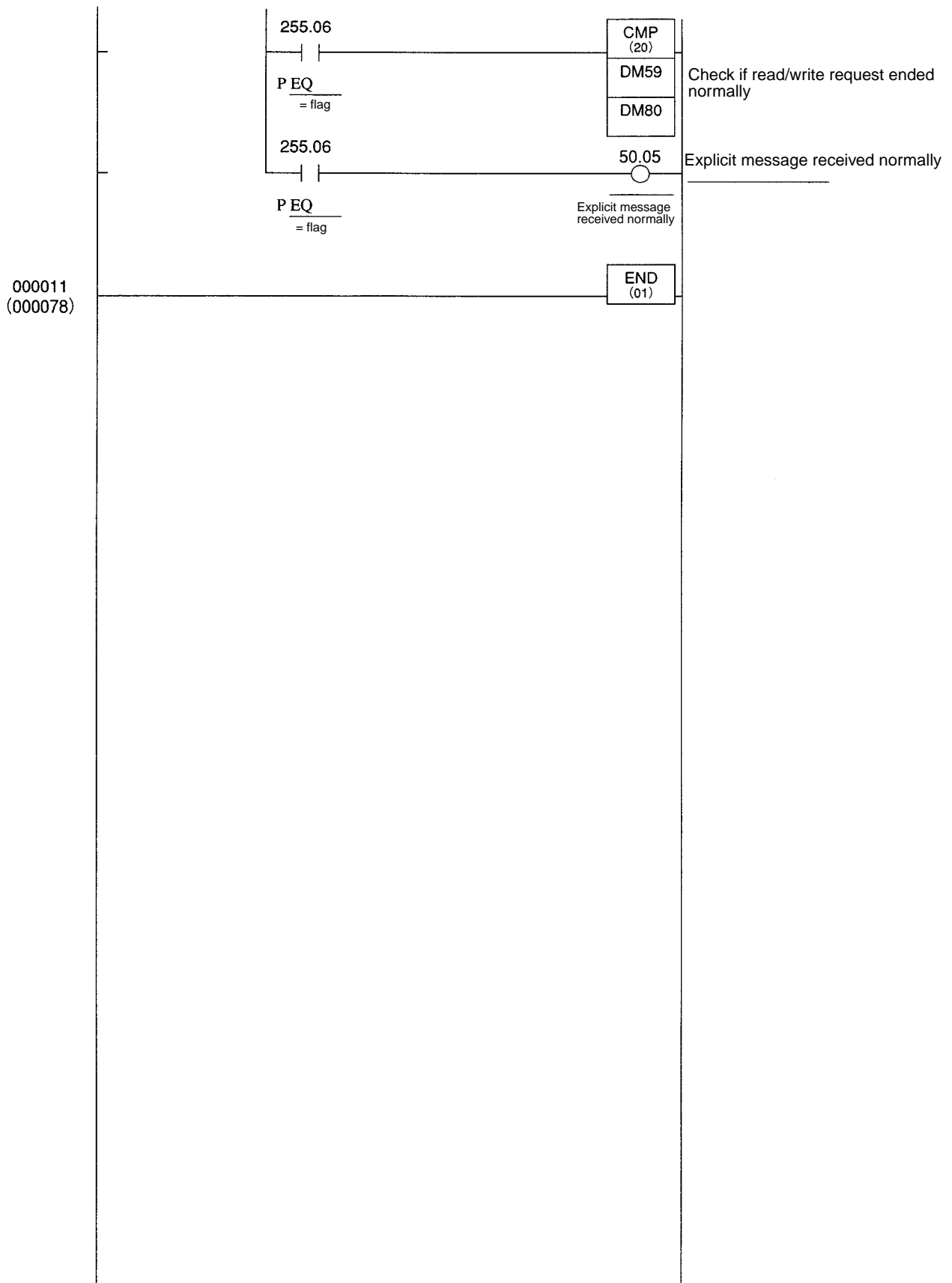

6-3 CS1 PCs

6-3-1 Using Programs

The programming used in this section provides an example of writing and reading alarm 1 temperatures using message communications for all the E5ZE's control points from a ladder program in a CS1 Programmable Controller.

Procedure

- 1,2,3...**
1. Transmit the program to the CS1 PC.
 2. Set the CS1 PC to RUN or MONITOR Mode.
 3. Set the alarm 1 temperature data to be written in order in words DM0020 to DM0027 for all control points (0 to 7). (This program will set the temperature to 100.0°C (03E8) for all control points.)
 4. Writing will be executed when bit CIO 013100 is turned ON at the CS1 PC.
 5. When writing is completed, CIO 010001 will turn OFF.
 6. When bit CIO 013101 is turned ON at the CS1 PC, reading will be executed.
 7. When reading is completed, CIO 10006 will turn OFF.
 8. The data that has been read will be stored in order in words DM0060 to DM0067 for all control points (0 to 7).
 9. If an attempt is made to execute reading and writing simultaneously, only writing will be executed.

When bit CIO 10001 is ON, writing is performed, and when bit CIO 10006 is ON, reading is performed. If message communications are not executed properly, the same instructions will be executed.

Program Application Conditions

- Set the CVM1-DRM21-EV1 DeviceNet Master Unit as a CPU Bus Unit to unit number 0.
- Use a CS1H-CPU67 Unit.
- Set the communications parameters as follows:
 - Baud rate: 500 kbps
 - CS1W-DRM21 node address: 00
 - E5ZE node address: 32
 Refer to the *CS1W-DRM21 DeviceNet Unit Operation Manual (Cat. No. W380)* for details on using the CMND(490) instruction.
- E5ZE IN start address: CIO 3332 (This address is used only with fixed allocation.)
- Used when Master Mode is enabled. The dot on the left of the Master 7-segment LED indicator will light or flash.

- The CVM1 work and data memory area details are described in the following tables.

Work Area		Contents
Word	Bit	
CIO 0100	010000	Indicates the interlock is ON. Turns ON when communications between the Master and E5ZE are normal, and the E5ZE is in READY Mode.
	010001	Write Request Flag. Turns ON when bit CIO 013100 turns ON, and turns OFF when writing has been completed normally.
	010002	ON when a (1 shot) explicit message has been received.
	010003	---
	010004	---
	010005	ON when an explicit message response is normal.
	010006	Read Request Flag. Turns ON when bit CIO 013101 turns ON, and turns OFF when reading has been completed normally.
	010007	---
	010008	Turns ON when bit CIO 013100 turns ON.
	010009	Turns ON when bit CIO 013101 turns ON.
CIO 0131	CIO 013100	Write Start Bit
	CIO 013101	Read Start Bit

DM Area words	Contents
D00100 to D00105	Write control code
D00106 to D00111	Read control data
D00012 to D00019	FINS write command header code
D00020 to D00027	Alarm 1 temperature write data for control points 0 to 7
D00040 to D00047	FINS read command header code
D00054 to D00059	Response block header code storage area
D00060 to D00067	Alarm 1 temperature read data for control points 0 to 7
D00080 to D00082	Response code check area

CPU Bus Unit Area		Contents
Word	Bit	
CIO1524	152415	I/O Link Flag
	152414	Error Flag

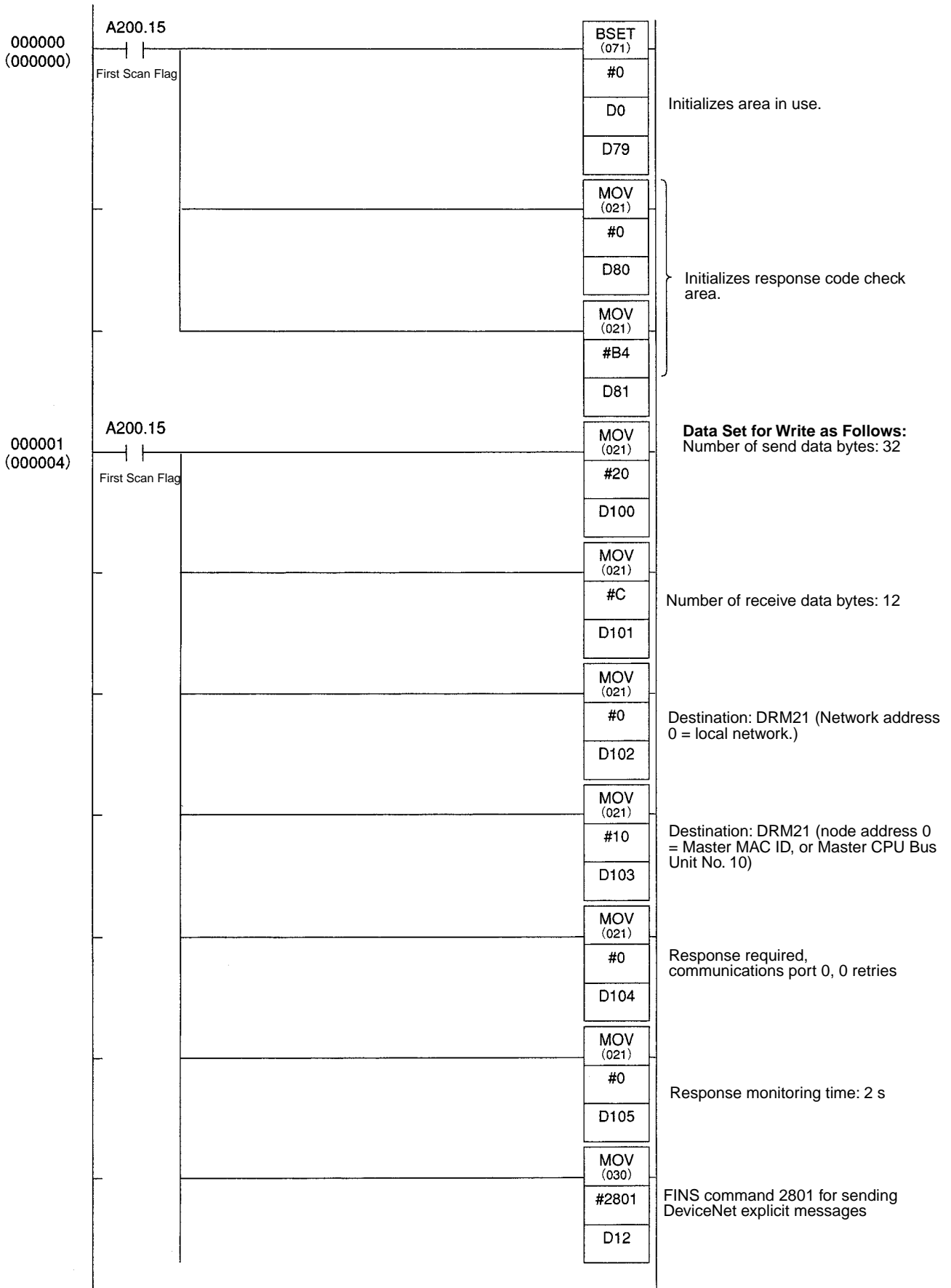

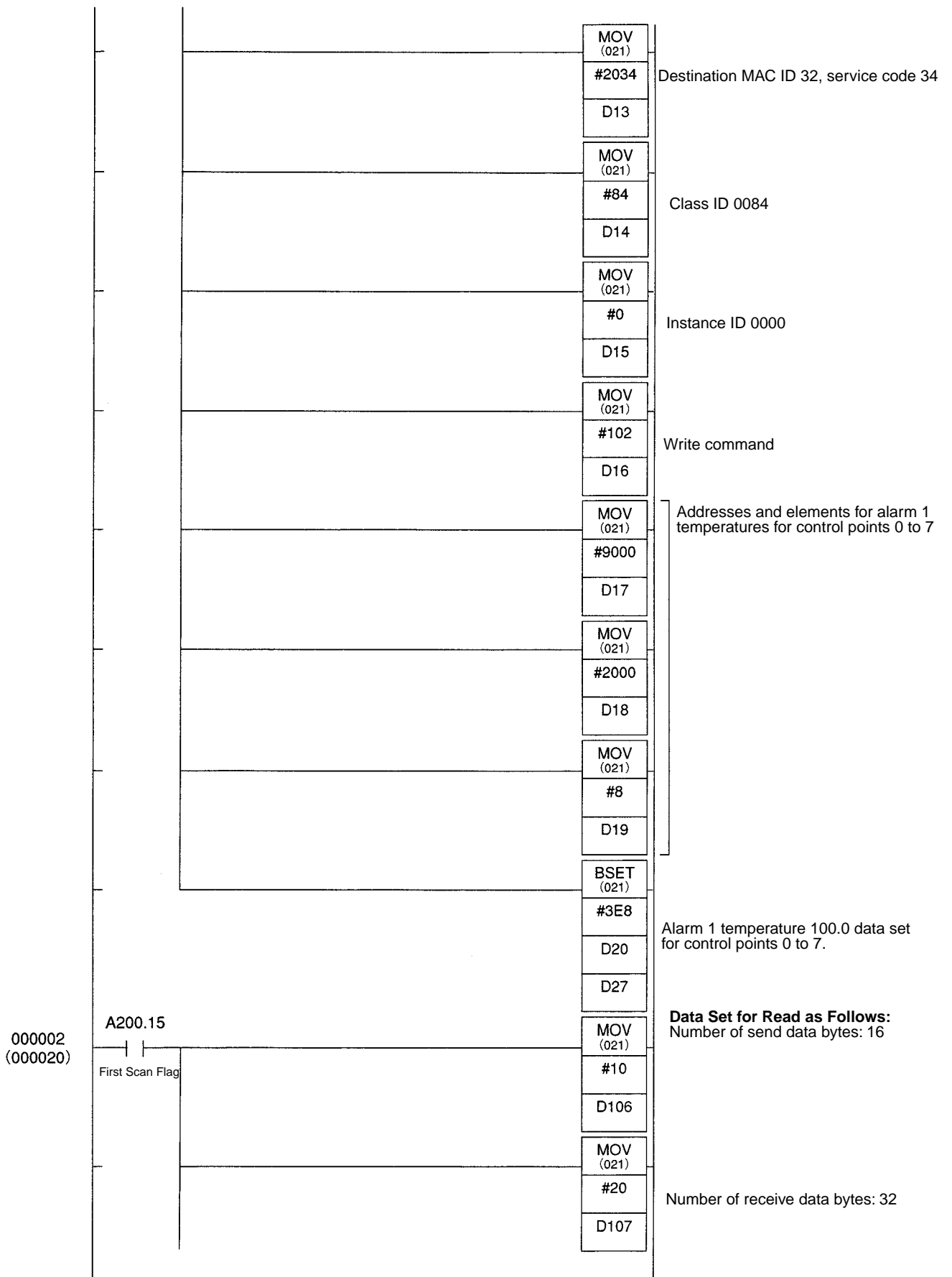

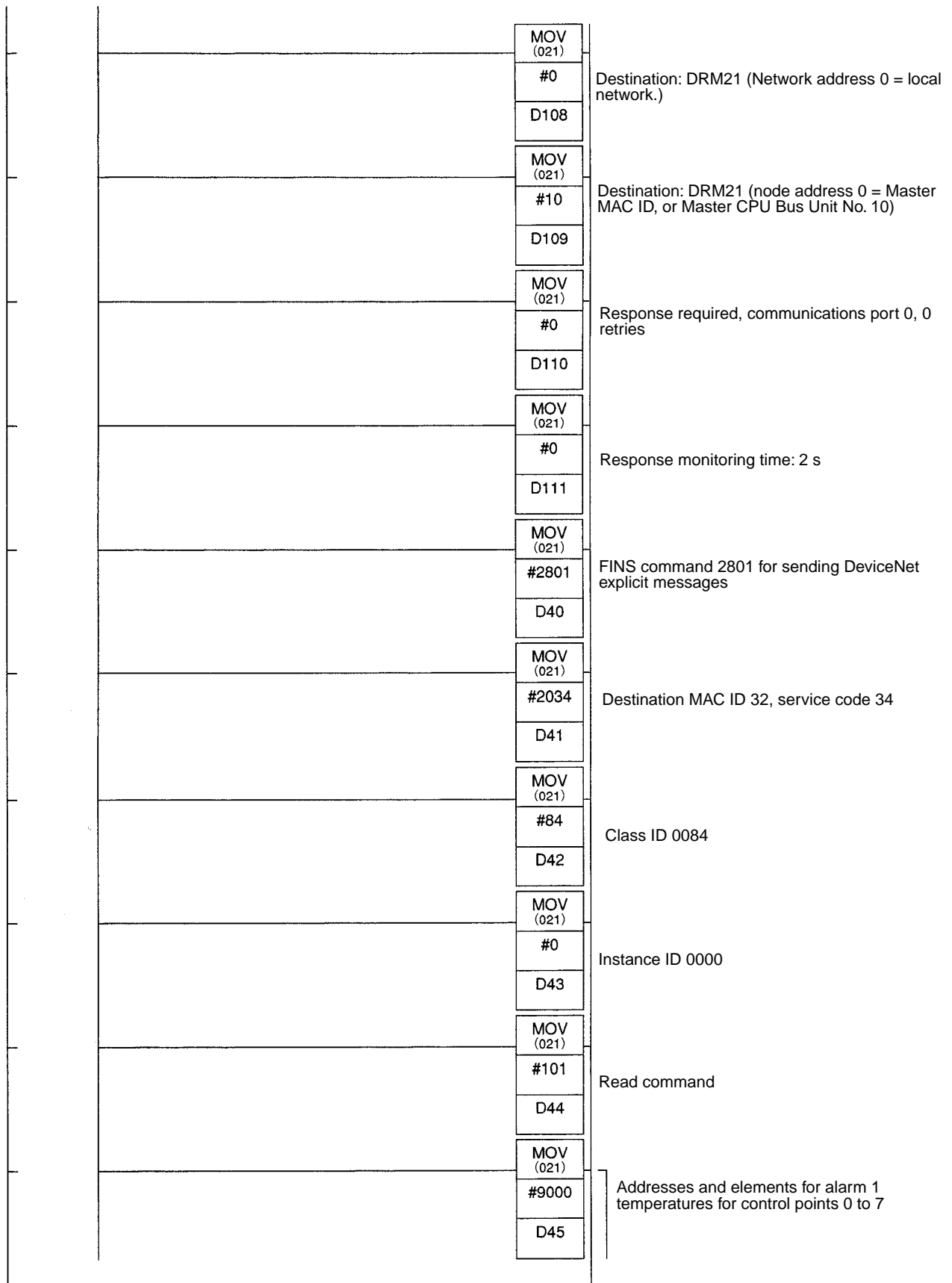

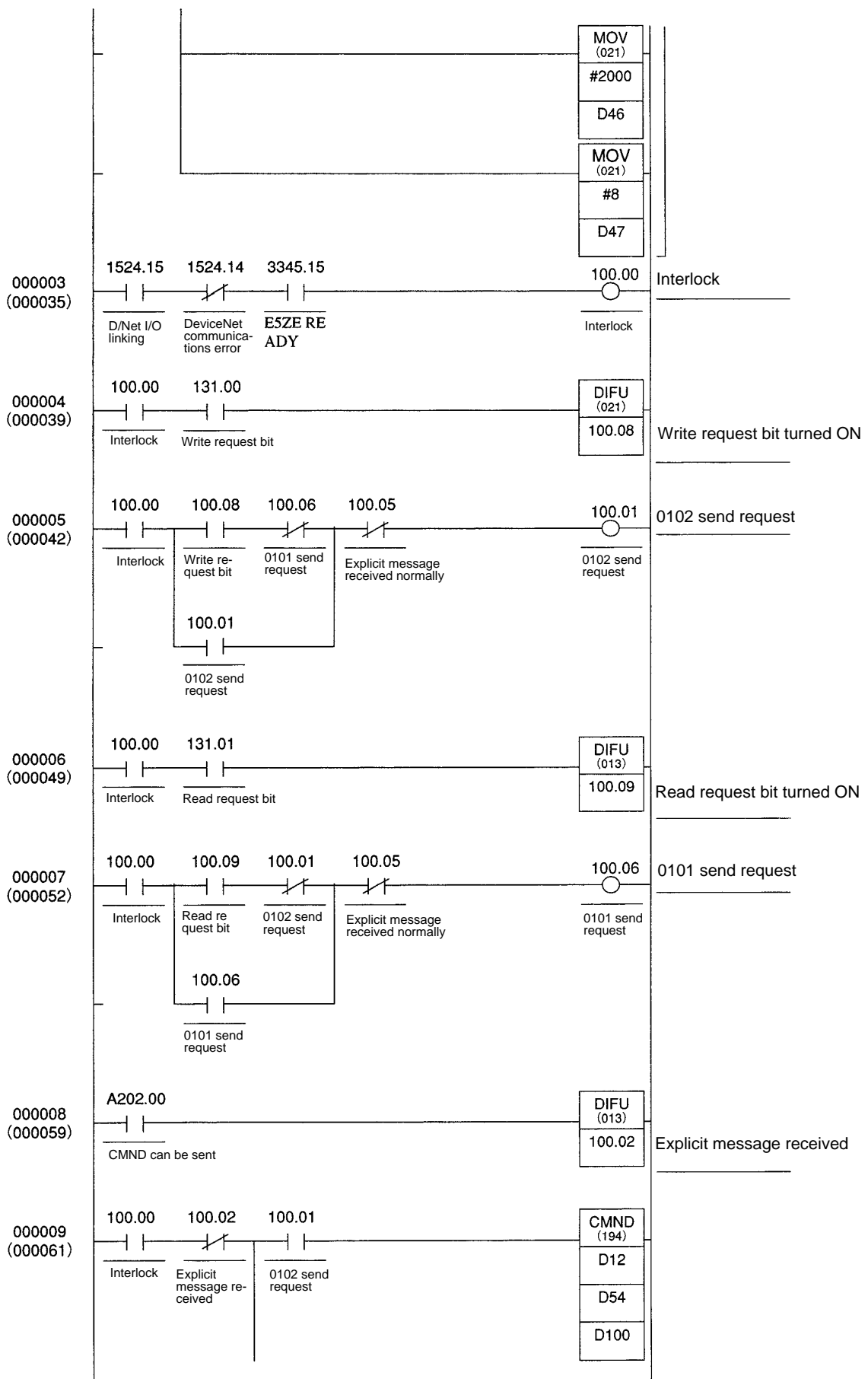

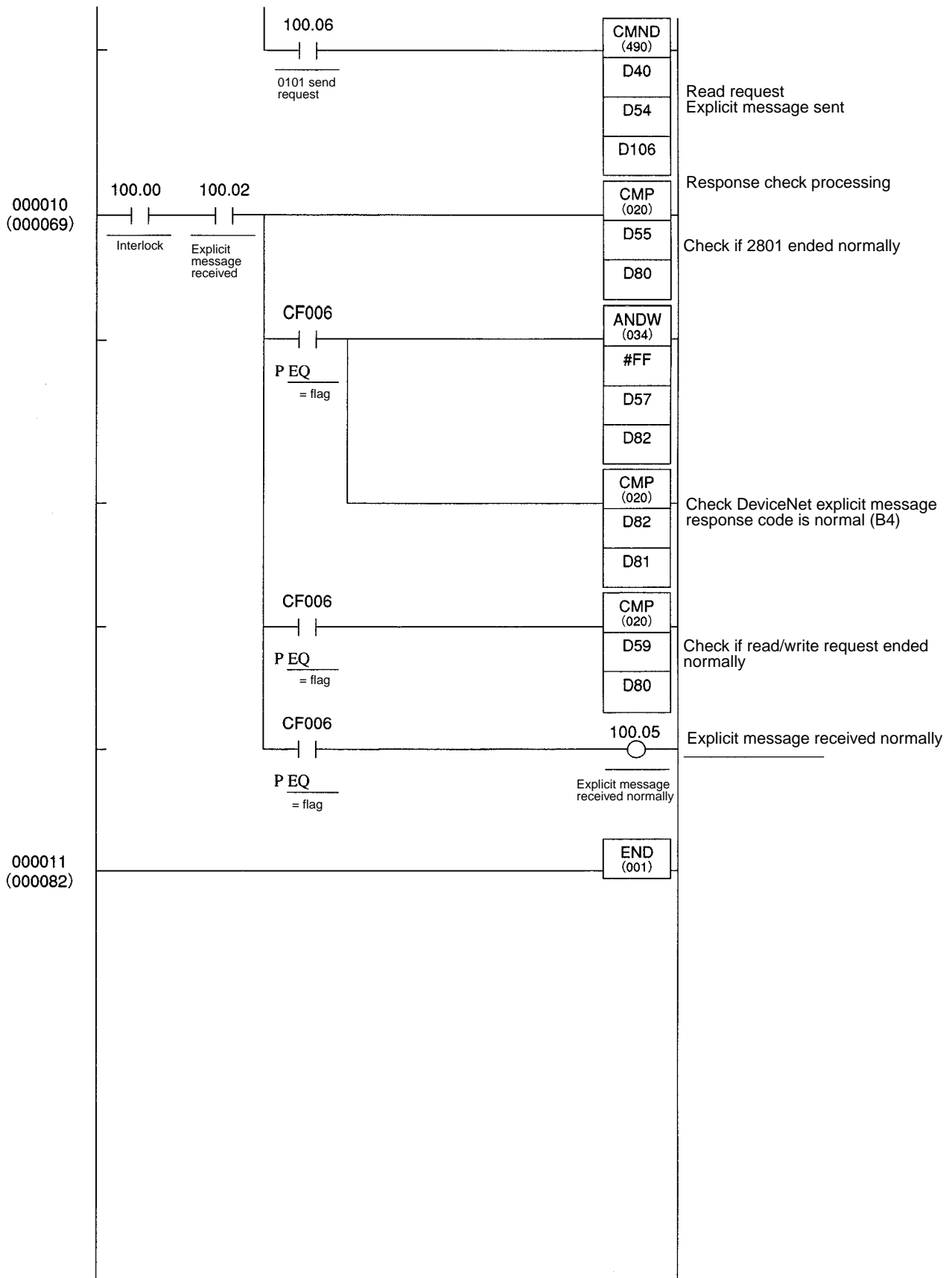

Appendix A

Multi-vendor Applications

Basic I/O Slave Device Protocol

General data	Compatible DeviceNet Specifications		Volume I - Release 2.0 Volume II - Release 2.0
	Header name	OMRON Corporation	Header ID = 47
	Device protocol name	Slaves: Generic	Protocol number = 0
	Manufacturer catalog number	W347	
	Manufacturer revision	1.3	
Physical conform- ance data	Network current consumption	24 VDC at 45 mA max.	
	Connector type	Open plug	
	Physical insulation	Yes	
	Supported indicators	Module, Network	
	MAC ID setting	DIP switch	
	Default MAC ID	0	
	Baud rate setting	DIP switch	
Communications data	Supported baud rates	125 kbps, 250 kbps, and 500 kbps	
	Predefined Master/Slave connection set	Group 2 only server	
	Dynamic connection support (UCMM)	None	
	Explicit message fragmentation support	Yes	

Object Mounting

Identity Object (0x01)

Object class	Attributes	Not supported
	Services	Not supported

Item		ID	Contents	Get (read)	Set (write)	Value
Object instance	Attributes	1	Vendor	Yes	No	47
		2	Product type	Yes	No	0
		3	Product code	Yes	No	305
		4	Revision	Yes	No	1.3
		5	Status (bits supported)	Yes	No	---
		6	Serial number	Yes	No	Unique for each Unit
		7	Product name	Yes	No	E5ZE
		8	State	No	No	---

Item		DeviceNet service	Parameter option
Object instance	Services	05 Reset	No
		0E Get_Attribute_Single	No

Message Router Object (0x02)

Object class	Attributes	Not supported
	Services	Not supported
Object instance	Attributes	Not supported
	Services	Not supported
Header specification addition	No	

DeviceNet Object (0x03)

Item		ID Contents	Get (read)	Set (write)	Value
Object class	Attributes	1 Revision	Yes	No	2
	Services	Not supported			

Item		ID Contents	Get (read)	Set (write)	Value
Object instance	Attributes	1 MAC ID	Yes	No	---
		2 Baud rate	Yes	No	---
		3 BOI	Yes	No	00 (hexadecimal)
		4 Bus Off counter	Yes	No	00 (hexadecimal)
		5 Allocation information	Yes	No	---
		6 MAC ID switch changed	No	No	---
		7 Baud rate switch changed	No	No	---
		8 MAC ID switch value	No	No	---
		9 Baud rate switch value	No	No	---

Item		DeviceNet service	Parameter option
Object instance	Services	0E Get_Attribute_Single	No
		4B Allocate_Master/Slave_Connection_Set	No
		4C Release_Master/Slave_Connection_Set	No

Assembly Object (0x04)

Object class	Attributes	Not supported
	Services	Not supported

Item		ID Contents	Get (read)	Set (write)	Value
Object instance	Attributes	3 Data	Yes	Yes	---

Item		DeviceNet service	Parameter option
Object instance	Services	0E Get_Attribute_Single	No
		10 Set_Attribute_Single	No

Connection Object (0x05)

Object class	Attributes	Not supported
	Services	Not supported
	Max. number of active connections	1

Item	Section	Information	Max. number of interfaces
Object interface 1	Interface type	Explicit Message	1
	Production trigger	Cyclic	---
	Transport type	Server	---
	Transport class	3	---

Item		ID Contents	Get (read)	Set (write)	Value
Object interface 1	Attributes	1 State	Yes	No	---
		2 Instance type	Yes	No	00 (hexadecimal)
		3 Transport class trigger	Yes	No	83 (hexadecimal)
		4 Produced connection ID	Yes	No	---
		5 Consumed connection ID	Yes	No	---
		6 Initial comm. characteristics	Yes	No	21 (hexadecimal)
		7 Produced connection size	Yes	No	FFFF (hexadecimal)
		8 Consumed connection size	Yes	No	FFFF (hexadecimal)
		9 Expected packet rate	Yes	Yes	---
		12 Watchdog time-out action	Yes	No	01 or 03
		13 Produced connection path length	Yes	No	00
		14 Produced connection path	Yes	No	---
		15 Consumed connection path length	Yes	No	00
		16 Consumed connection path	Yes	No	---
		17 Production inhibit time	Yes	No	---

Item		DeviceNet service	Parameter option
Object interface 1	Services	05 Reset	No
		0E Get_Attribute_Single	No
		10 Set_Attribute_Single	No

Item	Section	Information	Max. number of interfaces
Object interface 2	Interface type	Polled I/O	1
	Production trigger	Cyclic	---
	Transport type	Server	---
	Transport class	2	---

Item		ID Contents	Get (read)	Set (write)	Value
Object interface 2	Attributes	1 State	Yes	No	---
		2 Instance type	Yes	No	01 (hexadecimal)
		3 Transport class trigger	Yes	No	82 (hexadecimal)
		4 Produced connection ID	Yes	No	---
		5 Consumed connection ID	Yes	No	---
		6 Initial comm. characteristics	Yes	No	01 (hexadecimal)
		7 Produced connection size	Yes	No	1C00 (hexadecimal)
		8 Consumed connection size	Yes	No	1200 (hexadecimal)
		9 Expected packet rate	Yes	Yes	---
		12 Watchdog time-out action	Yes	No	00
		13 Produced connection path length	Yes	No	00
		14 Produced connection path	Yes	No	---
		15 Consumed connection path length	Yes	No	00
		16 Consumed connection path	Yes	No	---
		17 Production inhibit time	Yes	No	---

Item		DeviceNet service	Parameter option
Object interface 2	Services	05 Reset	No
		0E Get_Attribute_Single	No
		10 Set_Attribute_Single	No

Item	Section	Information	Max. number of interfaces
Object interface 3	Interface type	Bit strobed I/O	1
	Production trigger	Cyclic	---
	Transport type	Server	---
	Transport class	2	---

Item	ID	Contents	Get (read)	Set (write)	Value
Object interface 3	Attributes	1 State	Yes	No	---
		2 Instance type	Yes	No	01 (hexadecimal)
		3 Transport class trigger	Yes	No	82 (hexadecimal)
		4 Produced connection ID	Yes	No	---
		5 Consumed connection ID	Yes	No	---
		6 Initial comm. characteristics	Yes	No	01 (hexadecimal)
		7 Produced connection size	Yes	No	0800 (hexadecimal)
		8 Consumed connection size	Yes	No	0800 (hexadecimal)
		9 Expected packet rate	Yes	Yes	---
		12 Watchdog time-out action	Yes	No	00
		13 Produced connection path length	Yes	No	00
		14 Produced connection path	Yes	No	00_00_00_00_00_00
		15 Consumed connection path length	Yes	No	00
		16 Consumed connection path	Yes	No	00_00_00_00_00_00
		17 Production inhibit time	Yes	No	---

Item	DeviceNet service	Parameter option
Object interface 3	05 Reset	No
	0E Get_Attribute_Single	No
	10 Set_Attribute_Single	No

Part 2

Serial Communications

This part of the manual provides information required to use RS-232C communications through the RS-232C auxiliary setting jack on the Temperature Controller

RS-232C Auxiliary Setting Jack and Remote I/O

Data written with the remote I/O function is updated in the E5ZE every 200 ms. If different settings are made with the RS-232C auxiliary setting jack and remote I/O communications, the settings made with the RS-232C auxiliary setting jack will last only until the next time the value is refreshed for remote I/O communications.

RS-232C Auxiliary Setting Jack and FINS Messages

Data written for the RS-232C auxiliary setting jack and FINS message are both achieved using commands. If different settings are made with the RS-232C auxiliary setting jack and a FINS message, the last command that was executed will determine the value of the setting.

Saving Set Values

Any data sent with DeviceNet is automatically saved and will remain in memory even if the power supply is turned OFF. Data set from the RS-232C auxiliary setting jack, however, will not be saved unless the Memory Write Command (WE) is executed before power is turned OFF.

SECTION 1

Serial Communications Control

This section provides general information on serial communications and communications checks.

1-1	Communications Control Procedure	68
1-2	Block Format	69
1-3	FCS Calculations	69
1-4	Checks	70
1-5	Error Processing	70

1-1 Communications Control Procedure

The communications procedure of the E5ZE is a special conversation type. In each E5ZE system, all communications are initiated by the host computer of the system by sending a character string called command block to an E5ZE of the system. The E5ZE then sends a character string called response block back to the host computer, i.e., each time a block is transmitted, the transmission right is also transferred. Each block begins with a start character, @, and the unit number of the E5ZE and ends with an FCS and a terminator. The E5ZE sends a response block back to the host computer whenever the host computer sends a command block to the E5ZE. The response block is processed by the host computer.

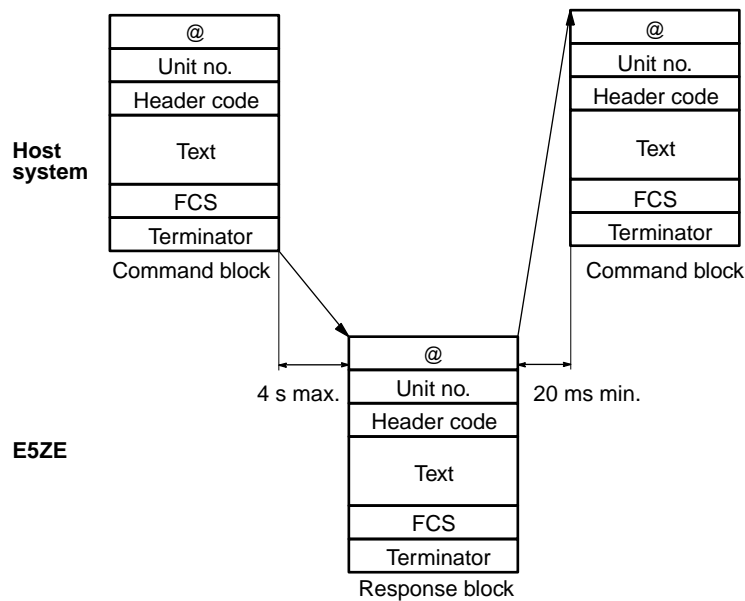

Note Command Block: A block sent from the host system. (Character string)
 Response Block: A block sent from the E5ZE. (Character string)



The host computer must be set up to read the responses sent by the E5ZE. If the host computer does not read any response, the reception buffer of the host computer may overflow.

- Communications after E5ZE Turned OFF and ON
 - The host computer can send a command block to the E5ZE at least 4 s after the E5ZE is turned ON.
 - When the E5ZE is turned OFF and ON, do not fail to initialize the reception buffer of the host computer before sending a command from the host computer.
- The E5ZE requires a maximum of 4 s to process a command block, which must be taken into consideration when writing programs for the E5ZE.
- An interval of 20 ms minimum is required for the host computer to send a command block after receiving a response block. If an interval less than 20 ms is set on the host computer, communications may not be possible.

1-2 Block Format

The following format is used for the command and response blocks used in E5ZE systems.

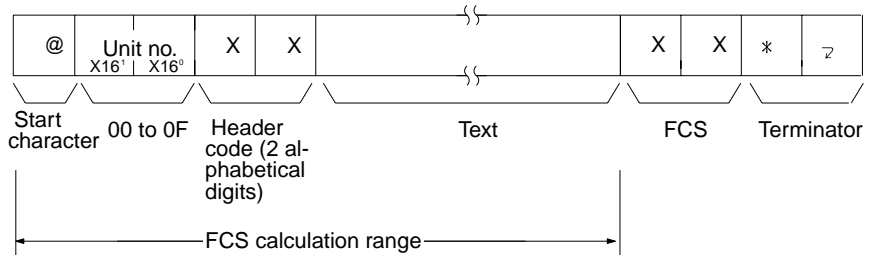

Start Character: Each block begins with a start character, @ (40H).

Unit Number: The unit number of the E5ZE is required so that the host computer can identify the E5ZE.

Header Code: The header code consists of two letters identifying the type of command being sent.

Text: The text consists of command or response data in detail.

FCS: The FCS is calculated as the exclusive OR of all characters from the start character through the final data character. The resulting 8-bit data is converted to two ASCII characters for transmission as an FCS.

Terminator: Each block ends with a terminator consisting of * (2AH) and a carriage return s (0DH).



If the host computer is connected to more than one E5ZE for RS-422 or RS-485 communications, each of the E5ZE must have a unique unit number, otherwise communications will not be possible.

1-3 FCS Calculations

Write a program for the host computer so that the host computer can calculate the FCS in each command block and each response block to ensure problem-free communications.

Calculation Example

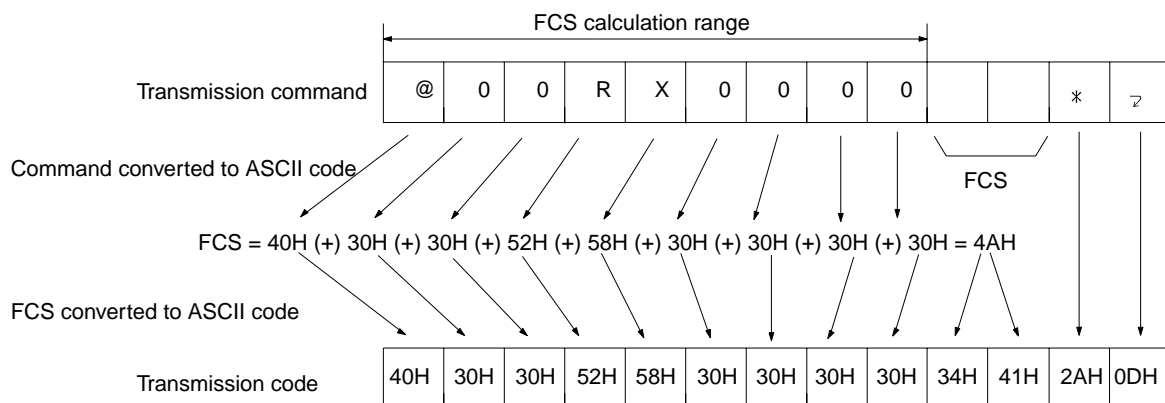

The result “4A” is transmitted as the FCS of the transmission command.

* Symbols

H: Hexadecimal code

(+): Exclusive OR

1-4 Checks

All communications errors and recovery from these communication errors must be processed at the host computer. The E5ZE has the following communications error detection functions.

Character Check

Vertical Parity Check

The E5ZE in vertical parity check operation checks the exclusive OR of each character.

Framing Check

The E5ZE determines that there is an error while the E5ZE is communicating with the host computer if the E5ZE detects a stop bit of 0.

Overrun Check

The E5ZE determines that there is an error while the E5ZE is communicating with the host computer if the E5ZE processing a character receives the next character.

Block Check

Format Check

The E5ZE in format check operation checks each command format that the E5ZE receives.

Numeric Data Check

The E5ZE in numeric data check operation checks the control point numbers and set values of the E5ZE.

FCS (Frame Check Sequence)

The E5ZE in FCS operation checks the start character @ to the exclusive OR of the last character in each block.



If there is a communications error which appears to be caused by noise, execute communications approximately 10 times and check if the communications error disappears. If communications errors occur frequently, change the communication speed between the E5ZE and the host computer or use an optical interface for the transmission path between the E5ZE and host computer.

1-5 Error Processing

If an error occurs in a command block or response block, refer to the following table to take necessary countermeasures.

Error	Remedy
The end code is not 00.	Check the contents of the end code.
An error code is read.	Check the contents of the error code.
The contents of the response block are abnormal.	Execute communications again.
No response block returns.	Make sure that the communications conditions of the host computer and E5ZE, connections between the host computer the E5ZE, the program used by the host computer connected to the E5ZE, and the settings of the E5ZE and host computer are correct.

SECTION 2

Commands and Responses

This section provides a list of commands, end codes, and error codes. Information on writing and reading data sets are also provided.

2-1	Commands	72
2-2	Writing Sets of Data	78
2-3	Reading Sets of Data	80
2-4	End Codes	82
2-5	Error Codes	85

2-1 Commands

Operational Status and Commands



The following provides a list of commands that can be used with the E5ZE.

If the following are designated when sending a command, a set of data can be written or read.

Memory bank no. and control point no.: A

Data code: AA

Refer to 2-2 Writing Sets of Data and 2-3 Reading Sets of Data for details.

@	Unit	Header code	MB	Control point	Data code			Data		FCS	*	z
---	------	-------------	----	---------------	-----------	--	--	------	--	-----	---	---

MB: Memory bank

Basic Commands for Temperature Control

OK: Valid

NO: Invalid

Command	Header code	Memory bank	Control point	Data code	Operation status			
					Operation stopped	Operating	Auto-tuning	
Set Point	Write	WS	0 to 7	0 to 7	00	OK	OK	NO
				A	00			
			A	0 to 7	00			
				A	00			
	Read	RS	0 to 7	0 to 7	00	OK	OK	OK
				A	00			
A				00				
Process Value	Read	RX	0	0 to 7	00	OK	OK	OK
				A	00			
Output Value	Read	RO	0	0 to 7	00	OK	OK	OK
					01			
					AA (see note)			
				A	00			
					01			
Proportional Band	Write	WB	0 to 7	0 to 7	00	OK	OK	NO
				A	00			
			A	0 to 7	00			
				A	00			
	Read	RB	0 to 7	0 to 7	00	OK	OK	OK
				A	00			
A				00				
Integral Time	Write	WN	0 to 7	0 to 7	00	OK	OK	NO
				A	00			
			A	0 to 7	00			
				A	00			
	Read	RN	0 to 7	0 to 7	00	OK	OK	OK
				A	00			
A				00				

Command		Header code	Memory bank	Control point	Data code	Operation status		
						Operation stopped	Operating	Auto-tuning
Derivative Time	Write	WV	0 to 7	0 to 7	00	OK	OK	NO
				A	00			
			A	0 to 7	00			
				A	00			
	Read	RV	0 to 7	0 to 7	00	OK	OK	OK
				A	00			
A				00				
Control Period	Write	WT	0 to 7	0 to 7	00	OK	OK	NO
					01			
					AA			
				A	00			
					01			
					AA			
			A	0 to 7	00			
					01			
					AA			
			A	0 to 7	00			
					01			
					AA			
	Read	RT	0 to 7	0 to 7	00	OK	OK	OK
					01			
AA								
A				00				
				01				
				AA				
Write	WU	0	0	00	OK	NO	NO	
				00				
Read	RU	0	0	00	OK	OK	OK	
				00				
Alarm Mode	Write	W#	0	0 to 7	00	OK	NO	NO
					01			
					AA			
				A	00			
					01			
					AA			
	Read	R#	0	0 to 7	00	OK	OK	OK
					01			
				AA				
				A				
				00				
				01				

Command		Header code	Memory bank	Control point	Data code	Operation status			
						Operation stopped	Operating	Auto-tuning	
Alarm Temperature	Write	W%	0 to 7	0 to 7	00	OK	OK	OK	
					01				
					AA				
			A	00					
				01					
				AA					
	A	0 to 7	00						
			01						
			AA						
	Read	R%	0 to 7	0 to 7	00	OK	OK	OK	
					01				
					AA				
A			00						
			01						
			AA						
A	0 to 7	00							
		01							
		AA							
Memory Bank Designation	Write	WM	0	0 to 7	00	OK	OK	NO	
				A	00				
	Read		RM	0	0 to 7				00
					A				00
Hysteresis	Write	WH	0 to 7	0 to 7	00	OK	OK	NO	
					01				
					AA				
			A	00					
				01					
				AA					
	A	0 to 7	00						
			01						
			AA						
	A	0 to 7	00						
			01						
			AA						
Read	RH	0 to 7	0 to 7	00	OK	OK	OK		
				01					
				AA					
		A	00						
			01						
			AA						
A	0 to 7	00							
		01							
		AA							
Status	Read	RX	0	0 to 7	02	OK	OK	OK	
				A	02				
Error	Read	RU	0	0	03	OK	OK	OK	

Note The contents of data codes will be read in numerical order if Output Value Read (RO) is used with the data code set to AA. Ignore the contents of data code 02 because the contents of data code 02 are not defined.

Commands Used According to Application

OK: Valid
NO: Invalid

Command	Header code	Memory bank	Control point	Data code	Operation status				
					Operation stopped	Operating	Auto-tuning		
Auto-tuning	Start	AS	0	0 to 7	00	NO	OK	NO	
				A	00				
				01					
	Stop	AP	0	0	00	OK	OK	OK	
Setting Unit	Write	Wt	0	0	00	OK	OK	OK	
	Read	Rt	0	0	00	OK	OK	OK	
Input Shift	Write	WI (see note 1)	0 to 7	0 to 7	00	OK	OK	NO	
				A	00				
				A	0 to 7				00
				A	00				
	Read	RI (see note 1)	0 to 7	0 to 7	00	OK	OK	OK	
				A	00				
A				0 to 7	00				
Manual Reset Value	Write	WK	0 to 7	0 to 7	00	OK	OK	NO	
				A	00				
				A	0 to 7				00
				A	00				
	Read	RK	0 to 7	0 to 7	00	OK	OK	OK	
				A	00				
A				0 to 7	00				
Ramp Value	Write	WR	0 to 7	0 to 7	00	OK	OK	OK	
				A	00				
				A	0 to 7				00
				A	00				
	Read	RR	0 to 7	0 to 7	00	OK	OK	OK	
				A	00				
A				0 to 7	00				
Present Set Point	Read	Rs	0	0 to 7	00	OK	OK	OK	
				A	00				
Manual Output Value	Write	WO	0	0 to 7	00	NO	OK (see note 2)	NO	
									01
				A	00				
					01				

Command	Header code	Memory bank	Control point	Data code	Operation status			
					Operation stopped	Operating	Auto-tuning	
Output Variable Limit Value	Write	WL	0 to 7	0 to 7	00	OK	OK	NO
					01			
				A	00			
			01					
			A	0 to 7	00			
				01				
	A	00						
	Read	RL	0 to 7	0 to 7	00	OK	OK	OK
					01			
				A	00			
01								
A			0 to 7	00				
			01					
Output Variable Change Rate Limit Value	Write	WG	0 to 7	0 to 7	OK	OK	NO	
				A				00
			A	0 to 7				00
				A				00
	Read	RG	0 to 7	0 to 7	OK	OK	OK	
				A				00
A	0 to 7	00						
Memory Write	WE	A	A	00	OK	OK	OK	
Initialize Setting Data	MC	---	---	---	OK	NO	NO	
Communication Test	TS	---	---	---	OK	OK	OK	

- Note**
1. Upper-case I (“ai”).
 2. Manual Output (WO) is valid if it is used for the E5ZE in manual operation and invalid if it is used for the E5ZE for 2-PID control.

Heater Burnout and SSR Failure Detection

OK: Valid
NO: Invalid

Command	Header code	Memory bank	Control point	Data code	Operation status			
					Operation stopped	Operating	Auto-tuning	
HB Alarm and HS Alarm Point	Write	WU	0	0	02	OK	NO	NO
	Read	RU	0	0	02	OK	OK	OK
Heater Burnout and SSR Failure Detection Current Value	Write	WW	0	0 to 7	00	OK	OK	OK
					01			
			A	00				
				01				
	Read	RW	0	0 to 7	00	OK	OK	OK
					01			
A			00					
			01					
Heater Current Value and SSR Leakage Current Value	Read	RZ	0	0 to 7	00	OK	OK	OK
					01			
			A	00				
				01				

Heating and Cooling Control

OK: Valid
NO: Invalid

Command	Header code	Memory bank	Control point	Data code	Operation status			
					Operation stopped	Operating	Auto-tuning	
Dead Band and Overlap Band	Write	WD	0 to 7	0 to 7	00	OK	OK	NO
				A	00			
			A	0 to 7	00			
				A	00			
	Read	RD	0 to 7	0 to 7	00	OK	OK	OK
				A	00			
Cooling Coefficient	Write	WC	0 to 7	0 to 7	00	OK	OK	NO
				A	00			
			A	0 to 7	00			
				A	00			
	Read	RC	0 to 7	0 to 7	00	OK	OK	OK
				A	00			
A	0 to 7	00						

Fuzzy Control

OK: Valid
NO: Invalid

Command	Header code	Memory bank	Control point	Data code	Operation status			
					Operation stopped	Operating	Auto-tuning	
Fuzzy Strength	Write	Wj	0 to 7	0 to 7	00	OK	OK	NO
				A	00			
			A	0 to 7	00			
				A	00			
	Read	Rj	0 to 7	0 to 7	00	OK	OK	OK
				A	00			
A	0 to 7	00						
Fuzzy Scale 1	Write	Wk	0 to 7	0 to 7	00	OK	OK	NO
				A	00			
			A	0 to 7	00			
				A	00			
	Read	Rk	0 to 7	0 to 7	00	OK	OK	OK
				A	00			
A	0 to 7	00						
Fuzzy Scale 2	Write	Wl (see note)	0 to 7	0 to 7	00	OK	OK	NO
				A	00			
			A	0 to 7	00			
				A	00			
	Read	Rl (see note)	0 to 7	0 to 7	00	OK	OK	OK
				A	00			
A	0 to 7	00						

Note Lower-case l (“el”).

Control Operation Start and Stop

OK: Valid
NO: Invalid

Command		Header code	Memory bank	Control point	Data code	Operation status		
						Operation stopped	Operating	Auto-tuning
Operation	Start	OS	0	0 to 7	00	OK	OK	NO
				A	00			
	Stop	OP	0	0 to 7	00	OK	OK	OK
				A	00			
Manual Operation	Start	OM	0	0 to 7	00	OK	OK	NO
				A	00			

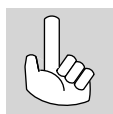

Status Read (RX) can be used with a data code to read a variety of data as shown in the following table.

Header code	Memory bank	Control point	Data code	Data to be read
RX	0	0 to 7 or A	00	Process value
			01	Output value
			02	Status
			03	Heater current value
			04	Present set point
			AA	The contents of data codes 00 to 02 in sequence
			BB	The contents of data codes 00 to 04 in sequence

2-2 Writing Sets of Data

Function

A single command block can enable all the memory banks or control points to share the same data or set the contents of all the data codes used by the E5ZE.

Commands

Use the following command format so that all the memory banks can share the same data and data code.

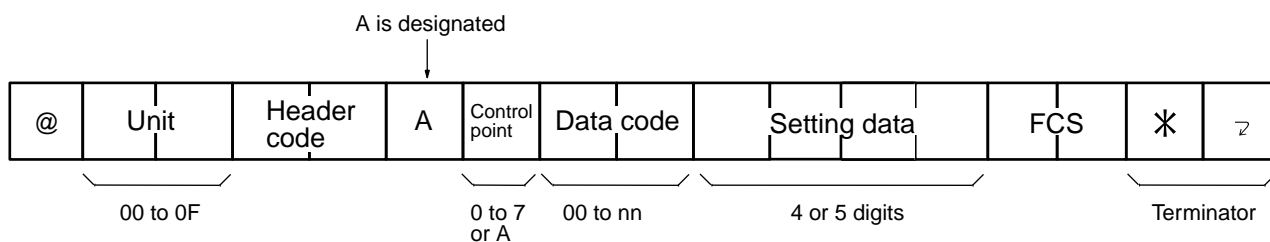

Use the following command format so that all the control points share the same data and data code.

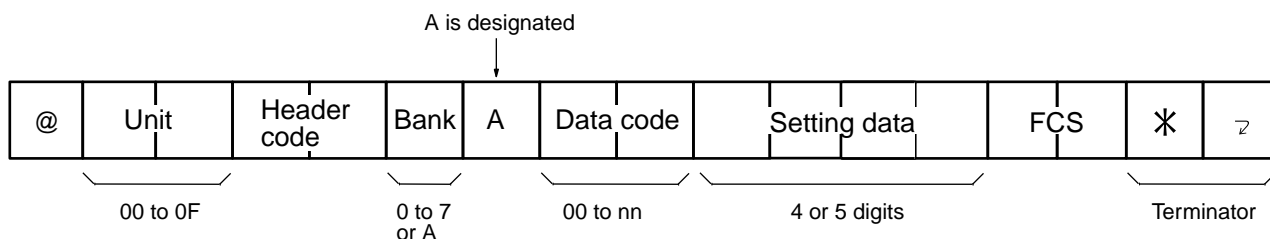

Use the following command format so that the contents of all data codes can be set.

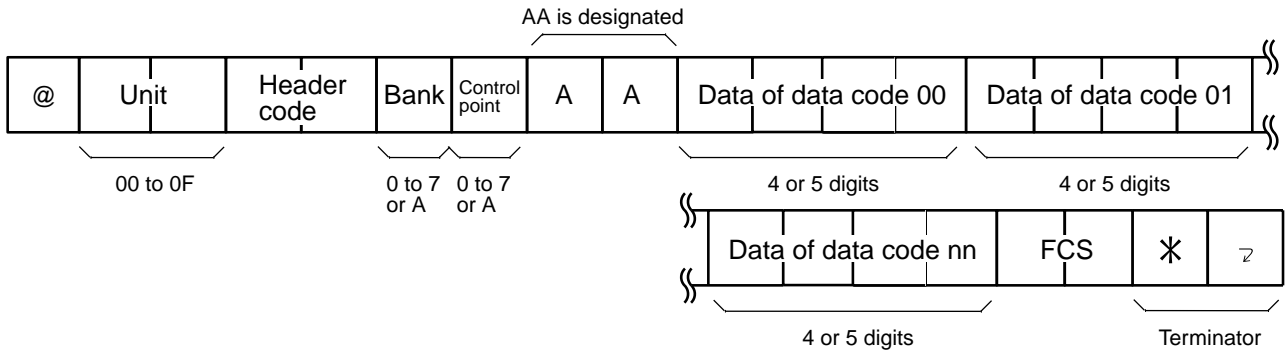

Response

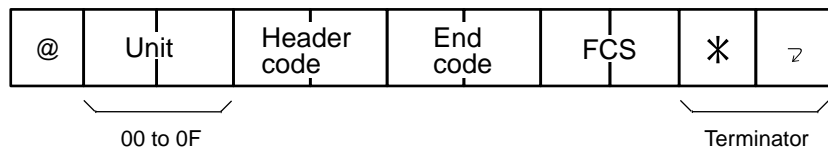

Communications Example

In this example, the following unit number, memory bank number, and set point of all the control points are set.

Unit no.: 1
 Memory bank no: 2
 Set point: 500°C

Command

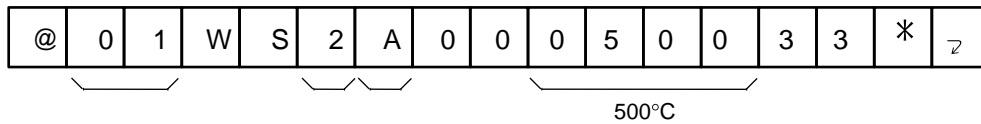

Response

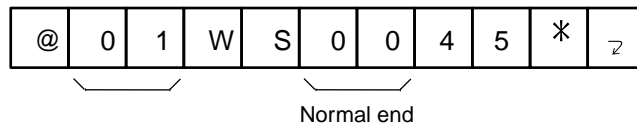

2-3 Reading Sets of Data

Function

A single command block can make it possible to read the contents of all the memory banks or control points, or the contents of all data codes.

Command

Designate A or AA for the set of memory bank data, control point data, or data code of the command block to read the set of data. A or AA can be used only once in the command block.

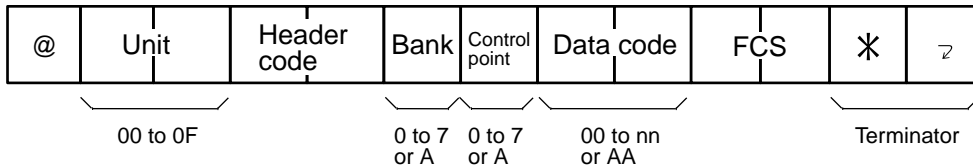

It is not possible to use A or AA only once in a command block (e.g., if A is used for the memory bank data, it cannot be used for the control point data and AA cannot be used for the data code).

Response

Use the following command format so that the contents of all the memory banks can be read.

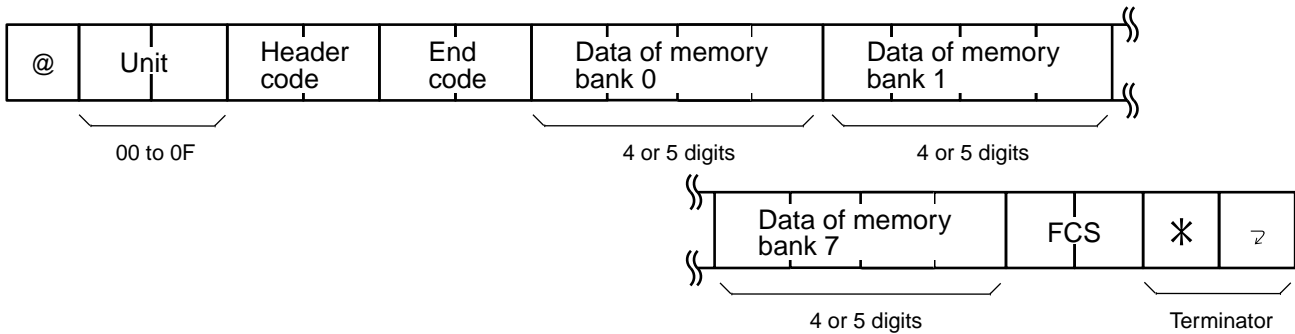

Use the following command format so that the contents of all the control points can be read.

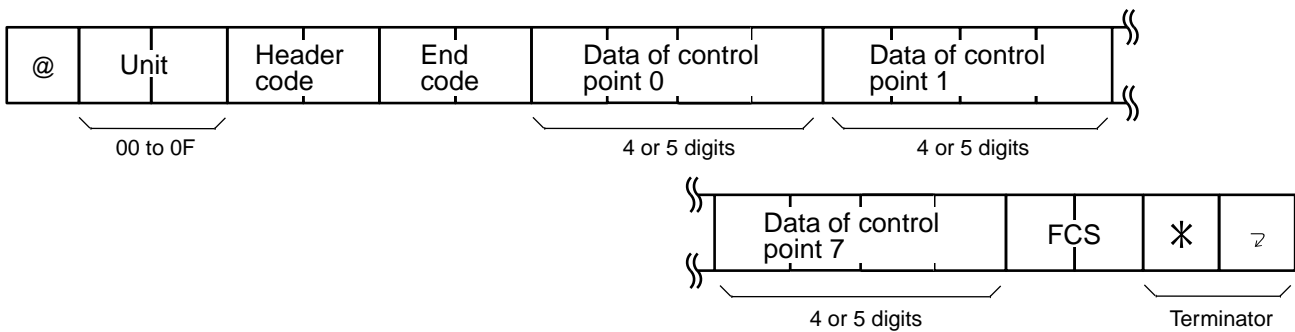

Use the following command format so that the contents of all data codes can be read.

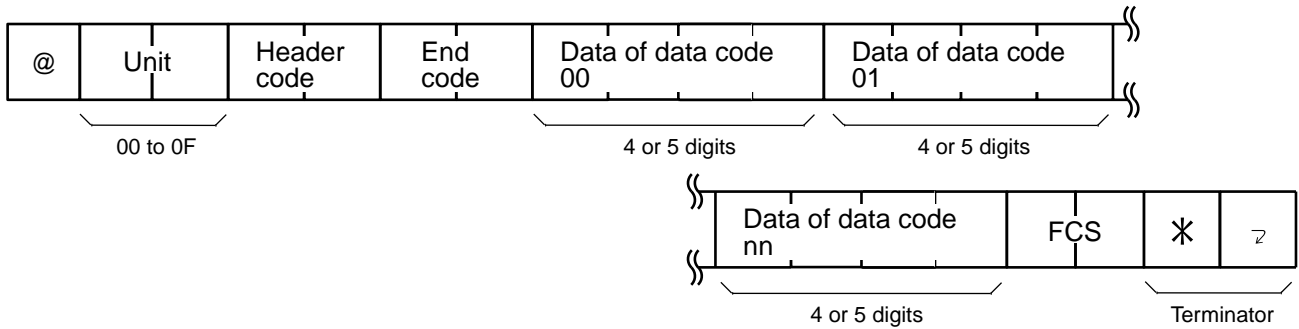

Communications Example

In this example, the following unit number, memory bank number, and set point of all the control points are set.

Unit no.: 1
 Memory bank no.: 2
 Set point: 500°C

Command

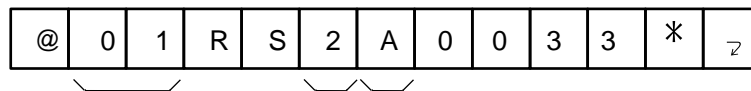

Response

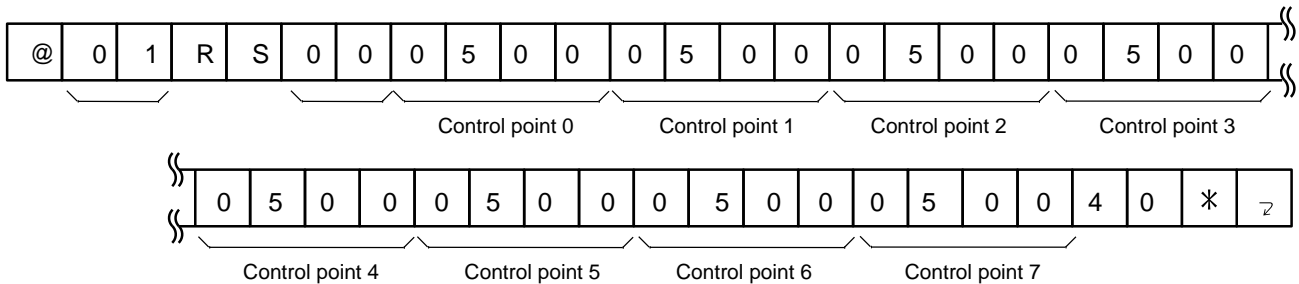

2-4 End Codes

List of End Codes

End code	Name	Command	Cause	Remedy
00	Normal End	---	---	---
01	Prohibited Command	WB, WN, WV, WI*, WS, WT, WH, WK, WL, WG, Wj, Wk, WI**, WD, WC, OS, OM	The designated control point is being auto-tuned.	Send the command after interrupting the auto-tuning of the control point.
		W#, MC	The E5ZE is in control operation or manual operation at the designated control point.	Send the command after interrupting the control operation or manual operation at the control point.
		WM	The memory bank designation method has been set to contact input designation.	Set the memory bank designation method to communications designation. Refer to the <i>E5ZE Operation Manual</i> for details.
			The designated control point is being auto-tuned.	Send the command after interrupting the auto-tuning of the control point.
		AS	The control operation at the designated control point is stopped.	Execute the auto-tuning after the E5ZE starts temperature control at the control point.
			The designated control point is already being auto-tuned.	Correct the program because the control point being auto-tuned does not accept Auto-tuning Start (AS).
		WO	The E5ZE was not in manual operation at the designated control point.	Send the command after sending Manual Operation Start (OM) to the E5ZE to start the manual operation.
		WU	The E5ZE is in temperature control operation or manual operation at the designated control point.	Send the command after interrupting the temperature control operation or manual operation at the control point.
			HB Alarm and HS Alarm Point Write (WU) with data code 02 was sent to an E5ZE model without HB or HS alarm function.	This command cannot be sent to any E5ZE model without HB or HS alarm function.
		WW, RW	These commands were sent to an E5ZE model without HB or HS alarm function.	These commands cannot be sent to any E5ZE model without HB or HS alarm function.
The HB or HS alarm function of the designated control point was not valid.	Before sending these commands, send HB Alarm and HS Alarm Point Write (WU) to the designated control point so that the HB and HS alarms of the designated control point will be valid.			
RZ	The E54-E8CT CT Input Unit is not connected to the E5ZE.	Connect the E54-E8CT CT Input Unit to the E5ZE.		
04	Invalid Address	---	A nonexisting control point, memory bank, or data code was designated.	Designate the control point, memory bank, and data code correctly.
			A was designated for the control point and memory bank and AA was designated for the data code simultaneously.	A or AA can be used only once in each command block.

End code	Name	Cause	Remedy
10	Parity Error	The data sent was not even parity.	Set the host system data to even parity.
		The parity was not detected correctly.	It is possible that E5ZE communications suffered noise interference. Separate the communication cable from other wires.
11	Framing Error	The stop bit was not detected.	It is possible that E5ZE communications suffered noise interference. Separate the communication cable from other wires.
12	Overrun Error	The reception buffer overflowed.	It is possible that E5ZE communications suffered noise interference. Separate the communication cable from other wires.
			Reduce the communications speed used for the communications between the E5ZE and host computer because the communications speed is too high for the E5ZE.
13	FCS Error	The FCS was calculated incorrectly.	Refer to <i>SECTION 1 Serial Communications Control</i> and make sure that the calculation of the FCS is correct.
		The FCS was not detected correctly.	It is possible that E5ZE communications suffered noise interference. Separate the communication cable from other wires.
14	Format Error	The format of the command block was incorrect.	Check the format of the command block. Make sure that the format of the command block is correct, especially whether the number of digits of the set temperature is four or five.
15	Numeric Error	The set data for the command was not within the setting range of the command.	Send data within the setting range.
		The negative (-) symbol was not added to the leftmost set value while the set data was a negative value.	Add the negative (-) symbol to the leftmost set data on the left.
18	Frame Length Error	The command block exceeded 510 characters.	Check the contents of the command block.
19	Invalid Command due to Error Status	The present alarm temperature set value is not within the alarm range set with Alarm Mode Write (W#).	Change the alarm temperature set value within the alarm range before setting the alarm mode.

End code	Name	Cause	Remedy
21	Invalid Command Due to Error Status	There is a temperature controller error.	<p>Check the type of temperature controller error with Output Operation Read (RU). Take the following countermeasures according to the kind of temperature controller error.</p> <p><u>Memory Error</u> Turn the power OFF and ON. If a memory error occurs again, send Initialize Setting Data (MC) and Memory Write (WE) in this order and turn the power OFF and ON again. If a memory error still occurs, the memory needs repairs.</p> <p><u>Cold Junction Compensation Error</u> The ambient operating temperature is -15°C or less, or 60°C or more. Use the E5ZE at an ambient operating temperature of -15° to 60°C.</p> <p><u>Set Data Error</u> The set point at some control points or in some memory banks are not within the setting range. Initialize Setting Data (MC) must be sent to initialize all the data items and reset the data items within the setting range.</p> <p><u>Other Errors</u> Turn the power OFF and ON. If the same errors occur, the E5ZE needs repairs.</p>

- Note**
1. Upper-case I (“ai”).
 2. **Lower-case l (“el”)

End Code Priority

If multiple end codes are generated by execution of a single command, only the end code with the highest priority will be returned with the response. End code priority, from highest to lowest, is as follows:

1. Framing errors
2. Parity errors
3. Overrun errors
4. Frame length errors
5. FCS errors
6. Command undefined errors
7. Invalid address
8. Format errors
9. Error status
10. Prohibited command
11. Numeric errors
12. Invalid commands due to error status

2-5 Error Codes

Command Undefined Error

The E5ZE will send back the following response block if the E5ZE cannot recognize the header code. In such cases, check the header code of the command block.

Response

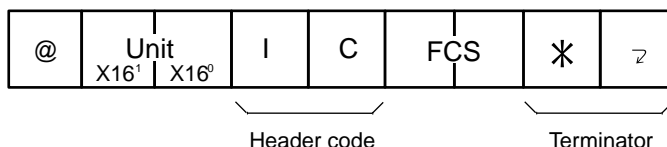

List of Error Codes

Error code	Name	Command	Cause	Remedy
E001	Memory Error	RX	The memory contents were destroyed.	Turn the power OFF and ON. If a memory error occurs again, send Initialize Setting Data (MC) and Memory Write (WE) in this order and turn the power OFF and ON again. If a memory error still occurs, the memory needs repairs.
E002	Sensor Input AD Error	RX	The sensor AD converter circuitry failed.	Turn the power OFF and ON. If a sensor input AD error occurs again, the sensor AD converter circuitry needs repairs.
E003	Cold Junction Compensation Error	RX	The ambient operating temperature is -15°C or less, or 60°C or more.	Use the E5ZE at an ambient operating temperature of -15° to 60°C.
E004	CT Input AD Error	RZ	The CT input AD converter circuitry failed.	Turn the power OFF and ON. If a CT input AD error occurs again, the CT input AD converter circuitry needs repairs.
E011	Sensor Error	RX	The wires of a temperature sensor connected to the E5ZE are burnt-out, shorted, or incorrectly wired.	Make sure that the wires of the temperature sensor are not burnt-out, shorted, or incorrectly wired.
E012	Upper Limit Error	RX	The process value at the designated control point was 20°C/40°F or more than the set point upper limit value.	Use the E5ZE so that the process value will not exceed the upper limit.
E013	Lower Limit Error	RX	The process value at the designated control point was 20°C/40°F or less than the set point lower limit value.	Use the E5ZE so that the process value will not be less than the lower limit.
E022	Heater Current Upper Limit Error	RZ	The process heater current value at the designated control point was 55.0 A or more.	The E5ZE cannot measure a heater current value of 55.0 A or more.
M001	Temperature Control Interrupted	Rs	The temperature control operation of the designated control point is stopped.	The ramp function does not operate and reading is not possible while operational control is stopped.

SECTION 3

Basic Temperature Control Commands

This section describes the basic temperature control commands.

3-1	Set Point Write: WS	88
3-2	Set Point Read: RS	89
3-3	Process Value Read: RX	90
3-4	Output Value Read: RO	92
3-5	Proportional Band Write: WB	93
3-6	Proportional Band Read: RB	94
3-7	Integral Time Write: WN	95
3-8	Integral Time Read: RN	96
3-9	Derivative Time Write: WV	97
3-10	Derivative Time Read: RV	98
3-11	Control Period Write: WT	99
3-12	Control Period Read: RT	100
3-13	Output Operation (Normal/Reverse) Write: WU	101
3-14	Output Operation (Direct/Reverse) Read: RU	102
3-15	Alarm Mode Write: W#	103
3-16	Alarm Mode Read: R#	104
3-17	Alarm Temperature Write: W%	106
3-18	Alarm Temperature Read: R%	107
3-19	Memory Bank Designation Write: WM	108
3-20	Memory Bank Designation Read: RM	109
3-21	Hysteresis Write: WH	110
3-22	Hysteresis Read: RH	111
3-23	Status Read: RX	112
3-24	Error Read: RU	115

3-1 Set Point Write: WS

Function

This command is used to write the set point required for temperature control to a control point.



1. Setting Unit Write (Wt) must be used to set the temperature setting unit of a control point to 1 or 0.1.
2. Set Point Write (WS) cannot be used at the designated control point being auto-tuned.
3. The possible setting data range will be -1,999 to 9,999 if the E5ZD-SDL Setting Display Unit is used with the E5ZE after pin number 4 of the FUNCTION switch is set to ON and the temperature setting unit is set to 0.1.

Setting Data Range

Setting unit		1		0.1	
°C or °F		°C	°F	°C	°F
Default		0000		00000	
Setting Data	K	-200 to 1300	-300 to 2300	-2000 to 13000	-3000 to 23000
	J	-100 to 0850	-100 to 1500	-1000 to 08500	-1000 to 15000
	R	0000 to 1700	0000 to 3000	00000 to 17000	00000 to 30000
	S	0000 to 1700	0000 to 3000	00000 to 17000	00000 to 30000
	T	-200 to 0400	-300 to 0700	-2000 to 04000	-3000 to 07000
	E	0000 to 0600	0000 to 1100	00000 to 06000	00000 to 11000
	B	0100 to 1800	0300 to 3000	01000 to 18000	03000 to 30000
	N	0000 to 1300	0000 to 2300	00000 to 13000	00000 to 23000
	L	-100 to 0850	-100 to 1500	-1000 to 08500	-1000 to 15000
	U	-200 to 0400	-300 to 0700	-2000 to 04000	-3000 to 07000
	W/Re5-26	0000 to 2300	0032 to 4100	00000 to 23000	00320 to 41000
	PL-II	0000 to 1300	0000 to 2300	00000 to 13000	00000 to 23000
	Pt100	-100 to 0500	-100 to 0900	-1000 to 05000	-1000 to 09000
	JPt100	-100 to 0500	-100 to 0900	-1000 to 05000	-1000 to 09000

Command

When Setting Unit is 1

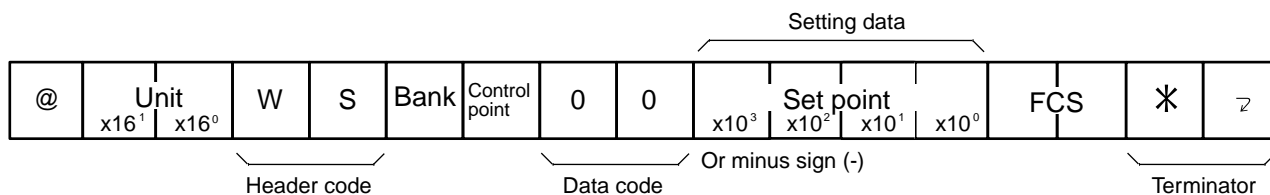

When Setting Unit is 0.1

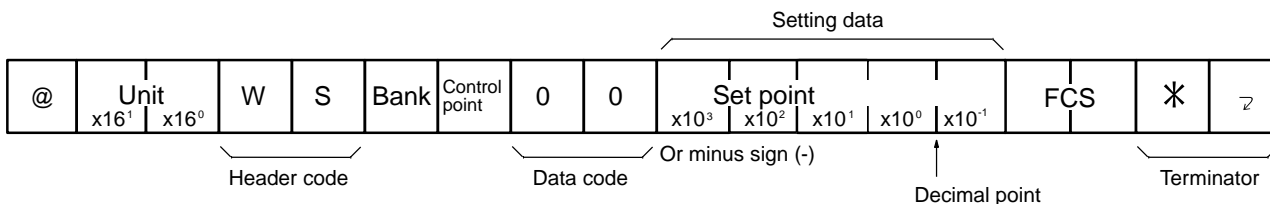

Response

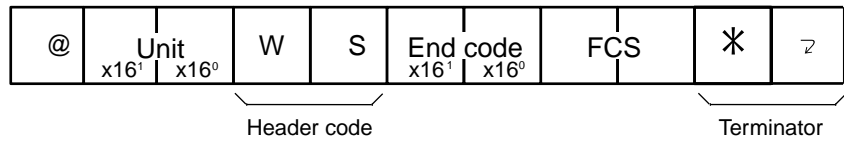

Communications Example

In this example, the E5ZE is operated with Set Point Write (WS) under the following conditions.

- Unit no.: 1
- Memory Bank no.: 2
- Control Point: 3
- Setting Unit: 0.1
- Set Point: -100.0°C

Command

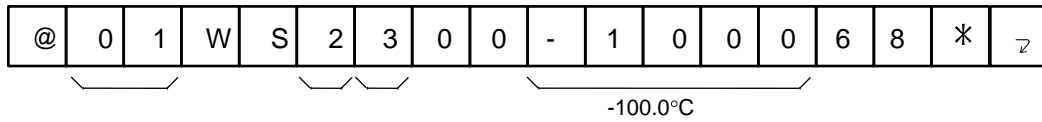

Response

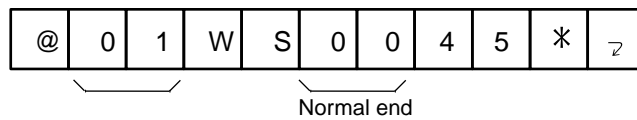

3-2 Set Point Read: RS

Function

This command is used to read the set points that have been set at a control point.

Command

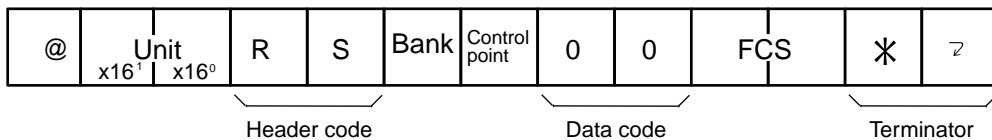

Response

When Setting Unit is 1

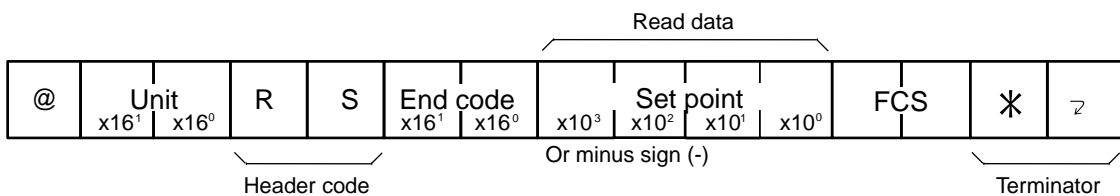

When Setting Unit is 0.1

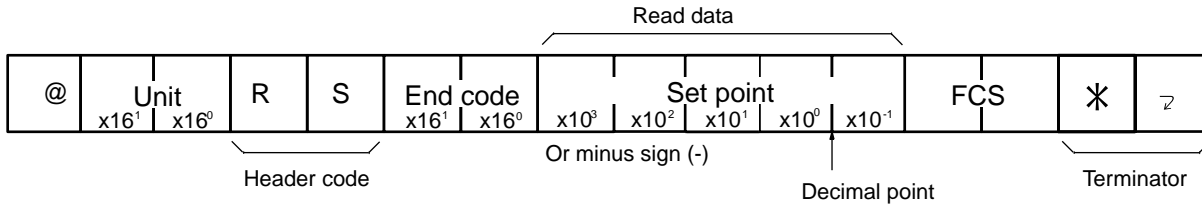

1. The response block for Set Point Read (RS) does not include read data if the end code of the response block is other than 00.
2. Refer to 2-4 End Codes.

Communications Example

In this example, the E5ZE is operated with Set Point Read (RS) under the following conditions.

- Unit no.: 1
- Memory Bank no.: 2
- Control Point: 3
- Setting Unit: 0.1
- Set Point: -100.0°C

Command

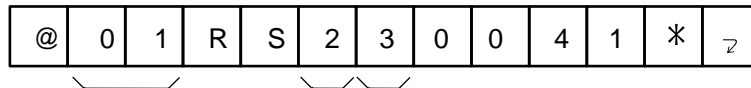

Response

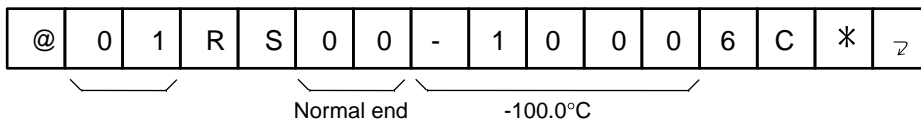

3-3 Process Value Read: RX

Function

This command is used to read the temperature being measured at a control point.

Command

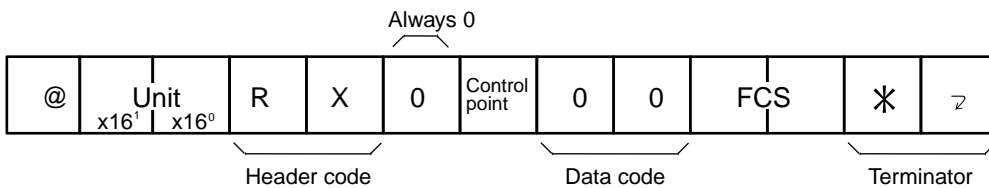

Response

When Process Value Unit is 1

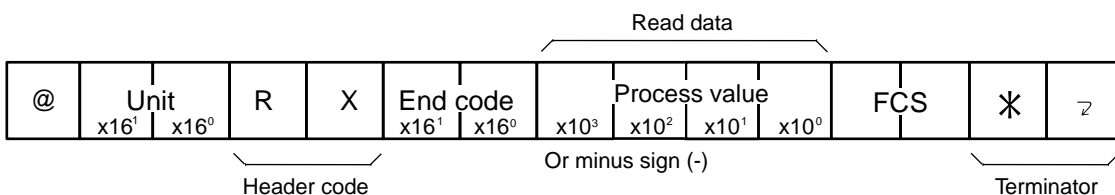

When Process Value Unit Set is 0.1

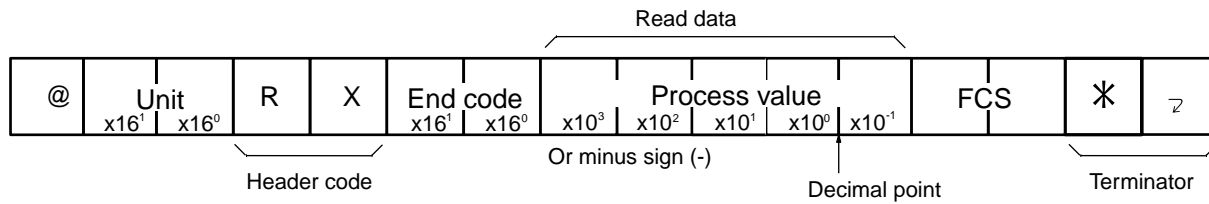

Response Block with Error Detected

The response block for Process Value Read (RS) will include an error code if an error is detected by the E5ZE while the E5ZE is processing the command.

When Process Value Unit is 1

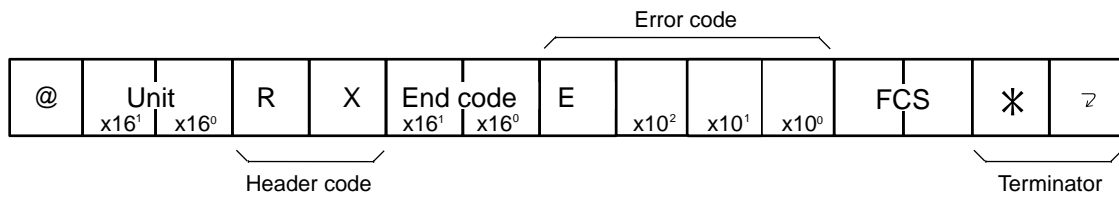

When Process Value Unit Set is 0.1

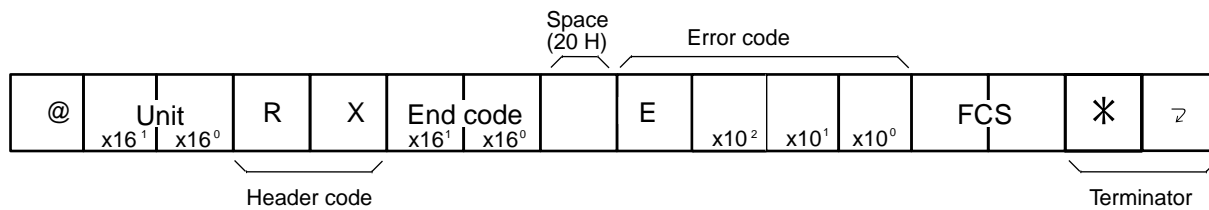

1. The response block for Process Value Read (RX) does not include read data or an error code if the end code of the response block is other than 00.
2. Refer to 2-4 End Codes.
3. Refer to 2-5 Error Codes.

Communications Example

In this example, the E5ZE is operated with Process Value Read (RX) under the following conditions.

Unit no.: 1
 Control Point: 3
 Process Value Unit: 1
 Process Value: 500°C

Command

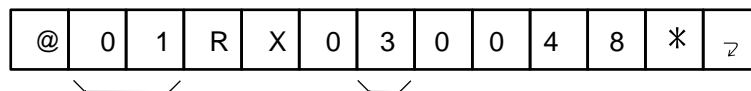

Response

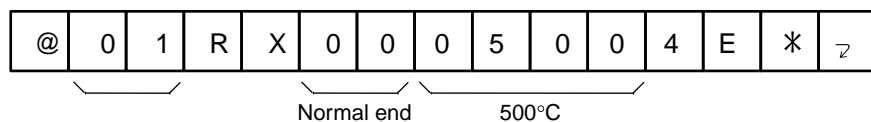

3-4 Output Value Read: RO

Function

This command is used to read the percentage of manipulated variable that has been set at a control point.



The percentage of the cooling-side output that has been set at a control point can be read provided that the E5ZE is a heating and cooling control model.

Command

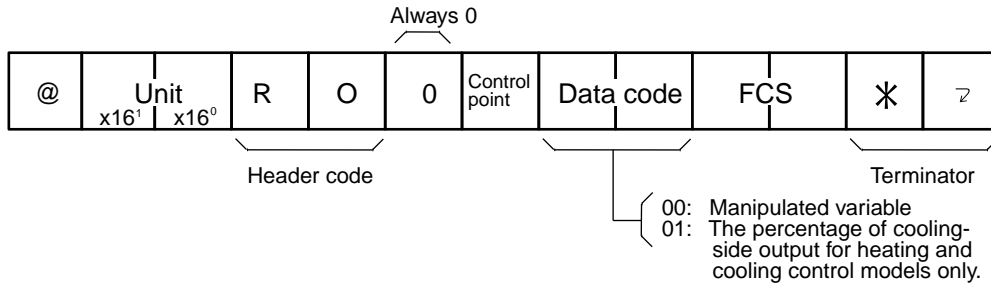

Response

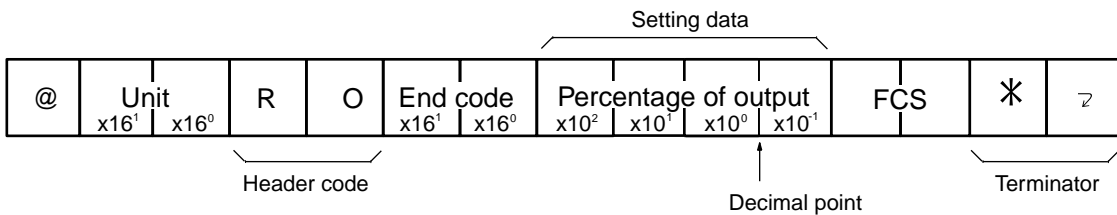

1. The response block for Output Value Read (RO) does not include read data if the end code of the response block is other than 00.
2. Refer to 2-4 End Codes.

Communications Example

In this example, the E5ZE is operated with MV Read (RO) under the following conditions.

Unit no.: 1
 Control point: 3
 Manipulated variable: 50.0%

Command

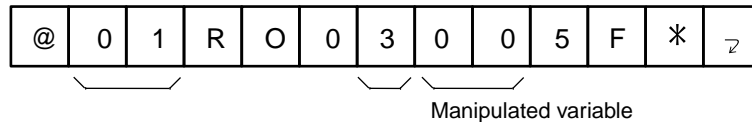

Response

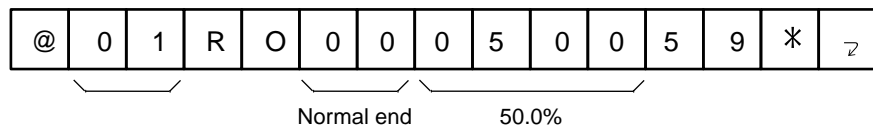

3-5 Proportional Band Write: WB

Function



This command is used to write proportional bands to a control point. Proportional Band Write (WB) cannot be used at a control point being auto-tuned.

Setting Data Range

Setting unit	0.1	
°C or °F	°C	°F
Default	0000	
Setting data	0000 to 9999	



If the constant P of a control point set to 0000 is used for temperature control with the E5ZE, the E5ZE will be in ON/OFF control operation at the control point.

Command

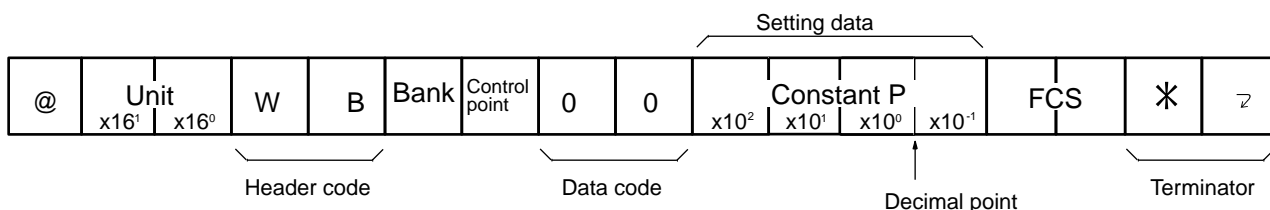

Response

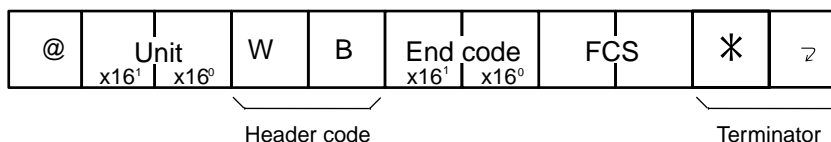

Communications Example

In this example, the E5ZE is operated with Proportional Band Write (WB) under the following conditions.

- Unit no.: 1
- Memory Bank no.: 2
- Control Point: 3
- Proportional Band: 40.0°C

Command

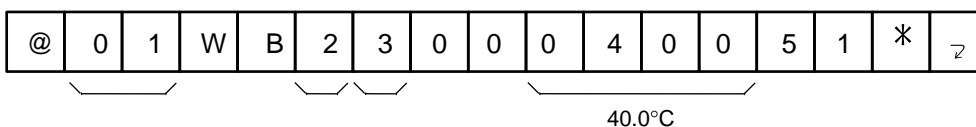

Response

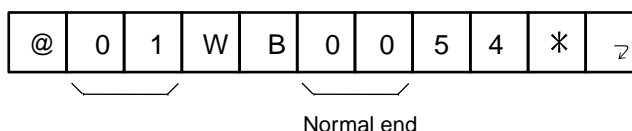

3-6 Proportional Band Read: RB

Function

This command is used to read the proportional bands that have been set at a control point.

Command

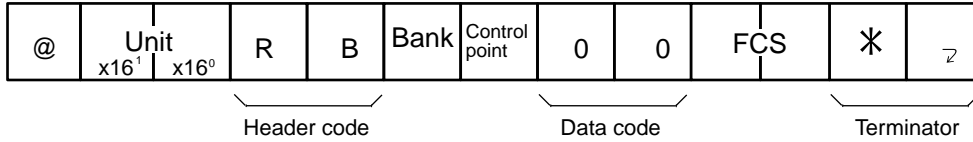

Response

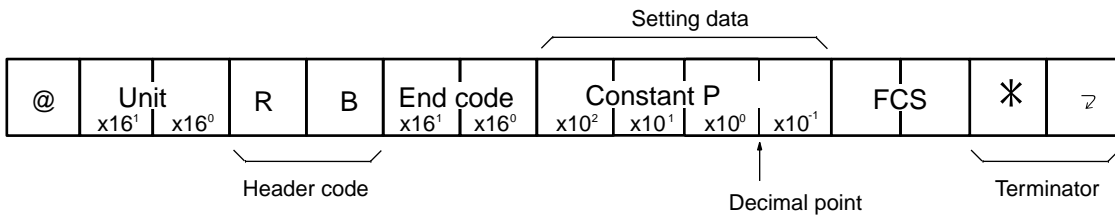

1. The response block for Proportional Band Read (RB) does not include read data if the end code of the response block is other than 00.
2. Refer to 2-4 End Codes.

Communications Example

In this example, the E5ZE is operated with Proportional Band Read (RB) under the following conditions.

Unit no.: 1
 Memory Bank no.: 2
 Control Point: 3
 Proportional Band: 40.0°C

Command

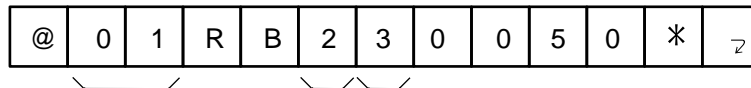

Response

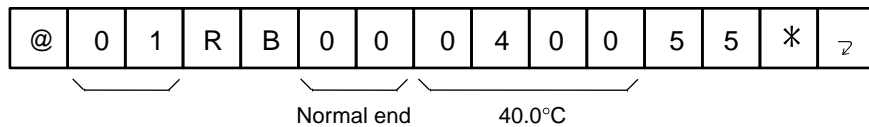

3-7 Integral Time Write: WN

Function



This command is used to write the integral time to a control point.
Integral Time Write (WN) cannot be used at a control point being auto-tuned.

Setting Data Range

Setting unit	1
Setting time unit	s
Default	0000
Setting data	0000 to 3999



If the constant I of a control point set to 0000 is used for temperature control with the E5ZE, the E5ZE will not be in integral operation at the control point.

Command

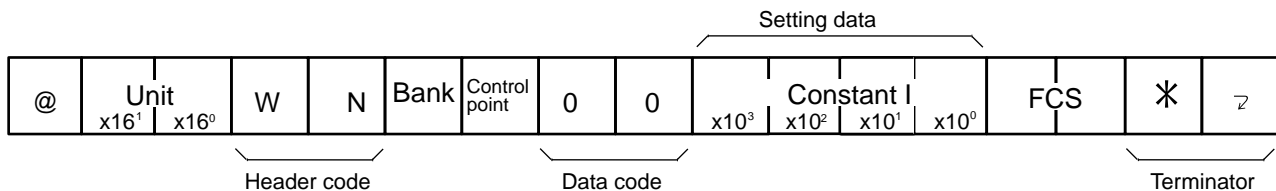

Response

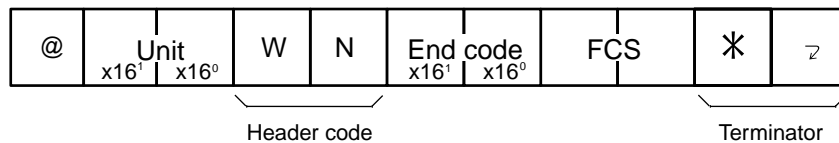

Communications Example

In this example, the E5ZE is operated with Integral Time Write (WN) under the following conditions.

- Unit no.: 1
- Memory Bank no.: 2
- Control Point: 3
- Integral Time: 50 s

Command

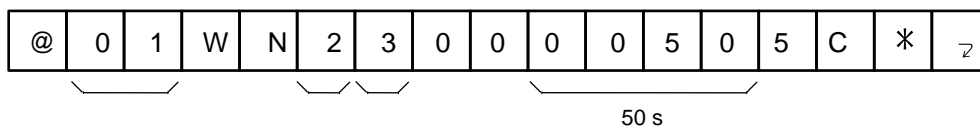

Response

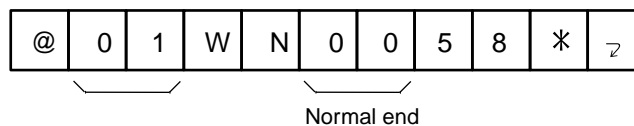

3-8 Integral Time Read: RN

Function

This command is used to read the integral time that have been set at a control point.

Command

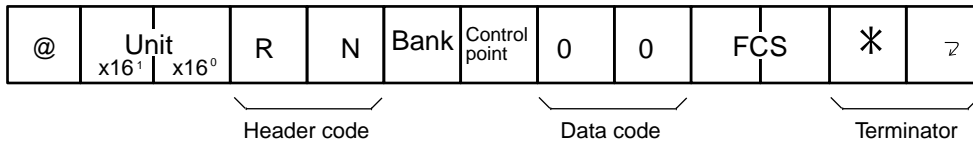

Response

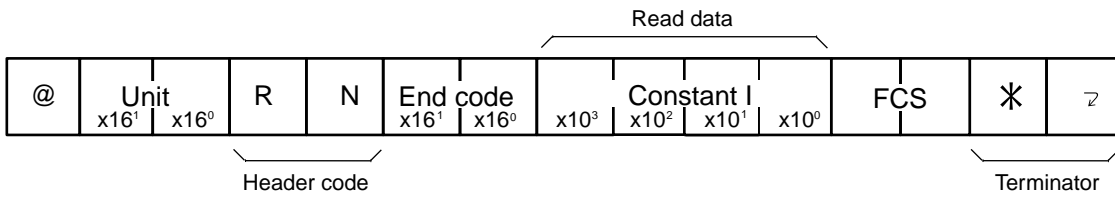

1. The response block for Integral Time Read (RN) does not include read data if the end code of the response block is other than 00.
2. Refer to 2-4 End Codes.

Communications Example

In this example, the E5ZE is operated with Integral Time Read (RN) under the following conditions.

Unit no.: 1
 Memory Bank no.: 2
 Control Point: 3
 Integral Time: 50 s

Command

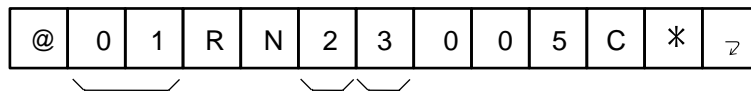

Response

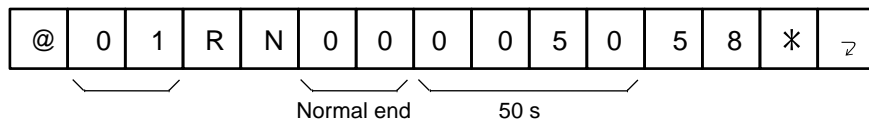

3-9 Derivative Time Write: WV

Function

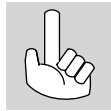

This command is used to write the derivative time to a control point. Derivative Time Write (WV) cannot be used at a control point being auto-tuned.

Setting Data Range

Setting unit	1
Setting time unit	s
Default	0000
Setting data	0000 to 3999



If the constant D of a control point set to 0000 is used for temperature control with the E5ZE, the E5ZE will not be in derivative operation at the control point.

Command

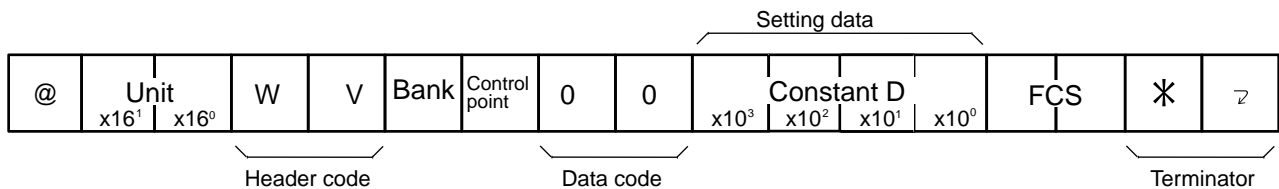

Response

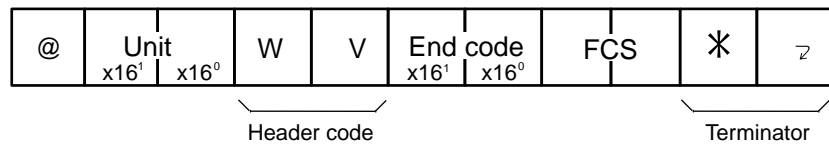

Communications Example

In this example, the E5ZE is operated with Derivative Time Write (WV) under the following conditions.

- Unit no.: 1
- Memory Bank no.: 2
- Control Point: 3
- Derivative Time: 10 s

Command

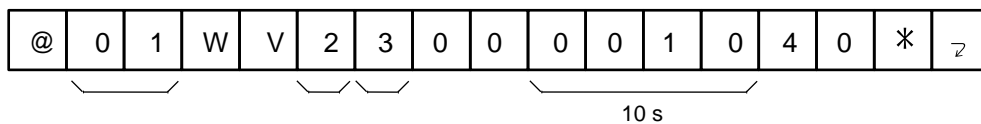

Response

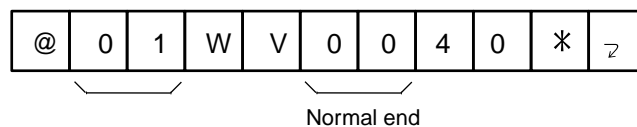

3-10 Derivative Time Read: RV

Function

This command is used to read the derivative time that have been set at a control point.

Command

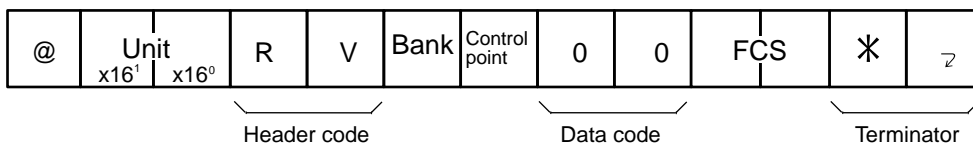

Response

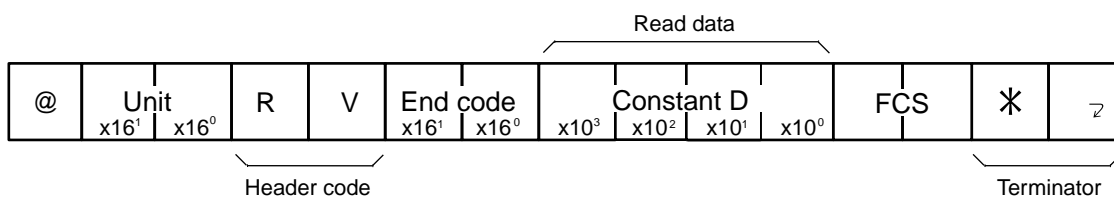

1. The response block for Derivative Time Read (RV) does not include read data if the end code of the response block is other than 00.
2. Refer to 2-4 End Codes.

Communications Example

In this example, the E5ZE is operated with Derivative Time Read (RV) under the following conditions.

Unit no.: 1
 Memory Bank no.: 2
 Control Point: 3
 Derivative Time: 10 s

Command

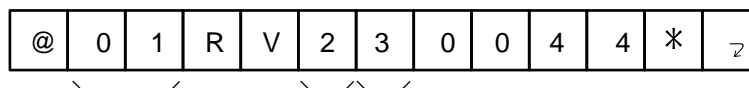

Response

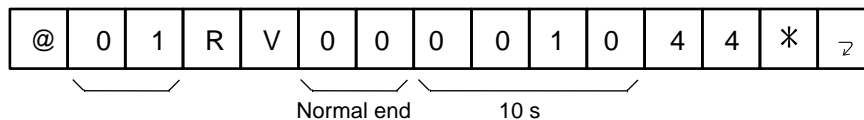

3-11 Control Period Write: WT

Function



This command is used to write the control period to a control point.

The Control Period Write (WT) cannot be used at a control point being auto-tuned.

Cooling-side control period can be written to a control point provided that the E5ZE is a heating and cooling control model.

Setting Data Range

Setting unit	1
Setting time unit	s
Default	0002
Setting data	0001 to 0099

Command

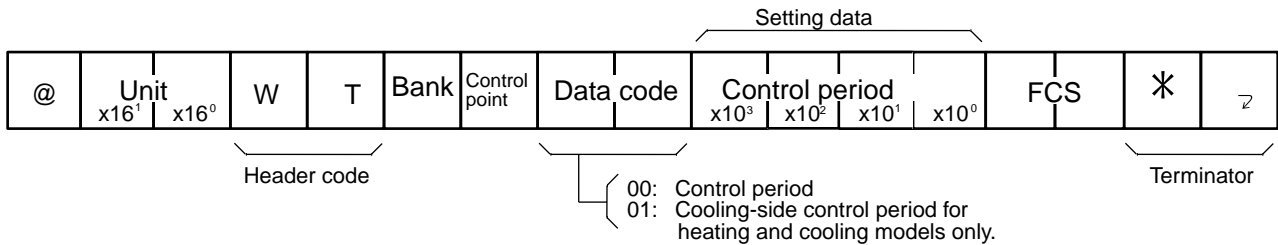

Response

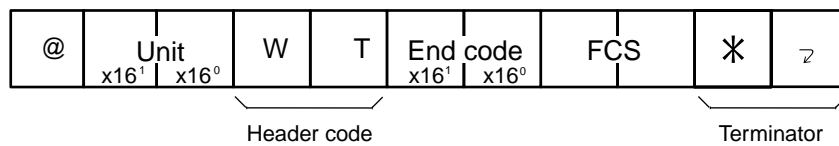

Communications Example

In this example, the E5ZE is operated with Control Period Write (WT) under the following conditions.

- Unit no.: 1
- Memory Bank no.: 2
- Control Point: 3
- Control Period: 5 s

Command

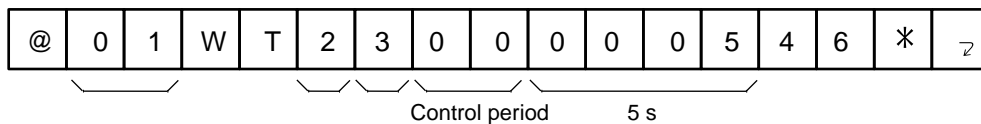

Response

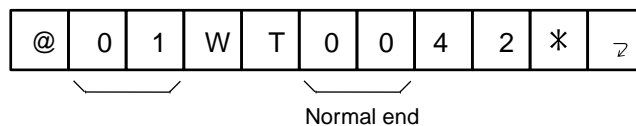

3-12 Control Period Read: RT

Function

This command is used to read the control period that have been set at a control point.



The cooling-side control period that have been set at a control point can be read provided that the E5ZE is a heating and cooling control model.

Command

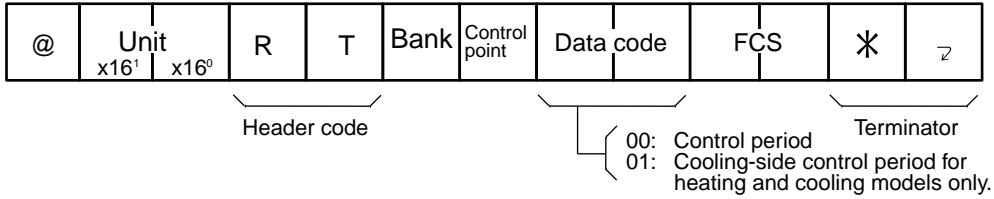

Response

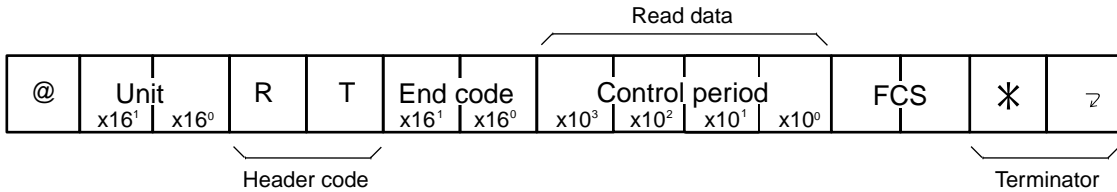

1. The response block for Control Period Read (RT) does not include read data if the end code of the response block is other than 00.
2. Refer to 2-4 End Codes.

Communications Example

In this example, the E5ZE is operated with Control Period Read (RT) under the following conditions.

Unit no.: 1
 Memory Bank no.: 2
 Control Point: 3
 Control Period: 5 s

Command

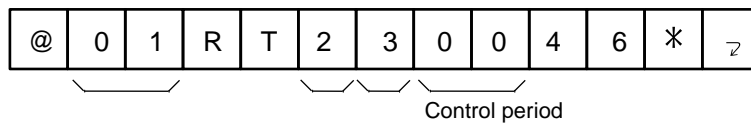

Response

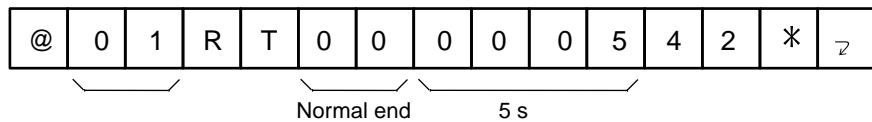

3-13 Output Operation (Normal/Reverse) Write: WU

Function



This command is used to designate the normal or reverse operation of a control point.

1. Output Operation Write (WU) enables the E5ZE in heating and cooling control operation to change its heating-side control to cooling-side control and vice versa at a control point simultaneously.
2. Output Operation Write (WU) cannot be used at a control point in manual operation, control operation or auto-tuning operation.

Setting Data Range

Default	0000 (All control points in reverse operation)
Setting code	00 to FF

Command

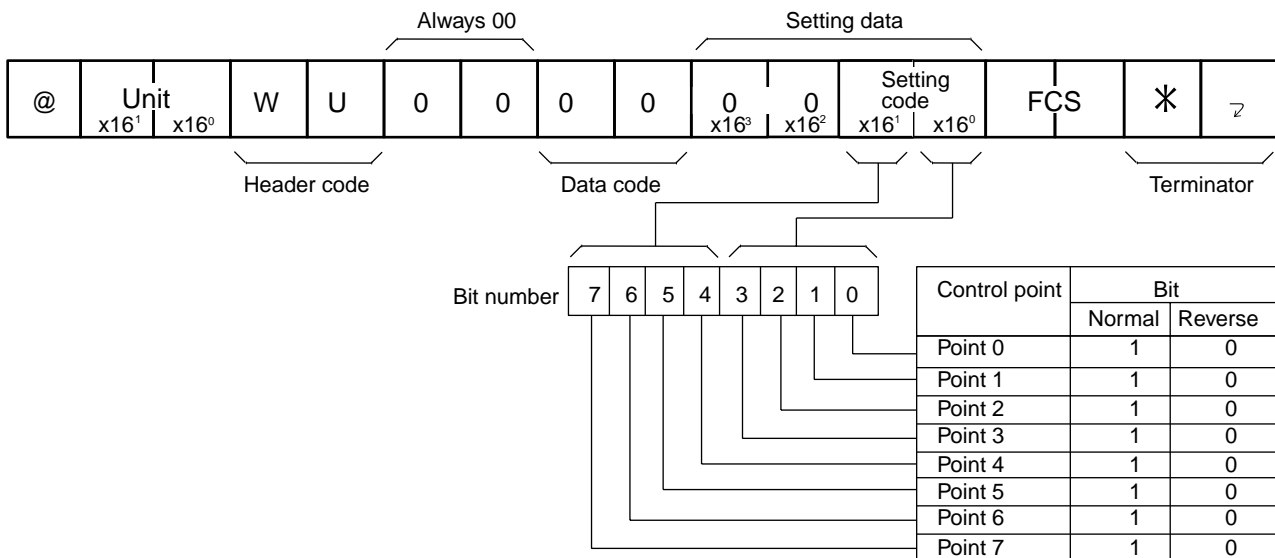

Response

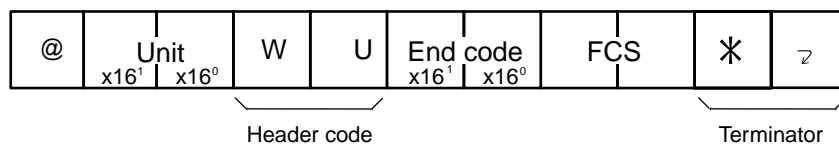

Communications Example

In this example, the E5ZE is operated with Output Operation Write (WU) under the following conditions.

Unit no.: 1

Control Points 0, 2, 4, and 6: Direct operation

Control Points 1, 3, 5, and 7: Reverse operation

Command

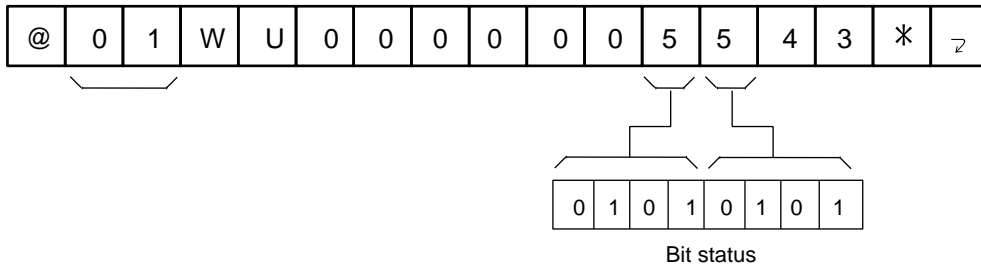

Response

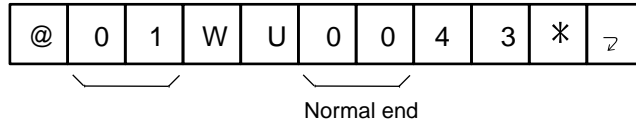

3-14 Output Operation (Direct/Reverse) Read: RU

Function

This command is used to read the output operation that has been set at a control point.

Command

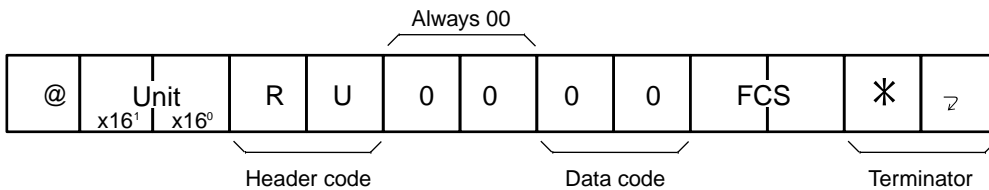

Response

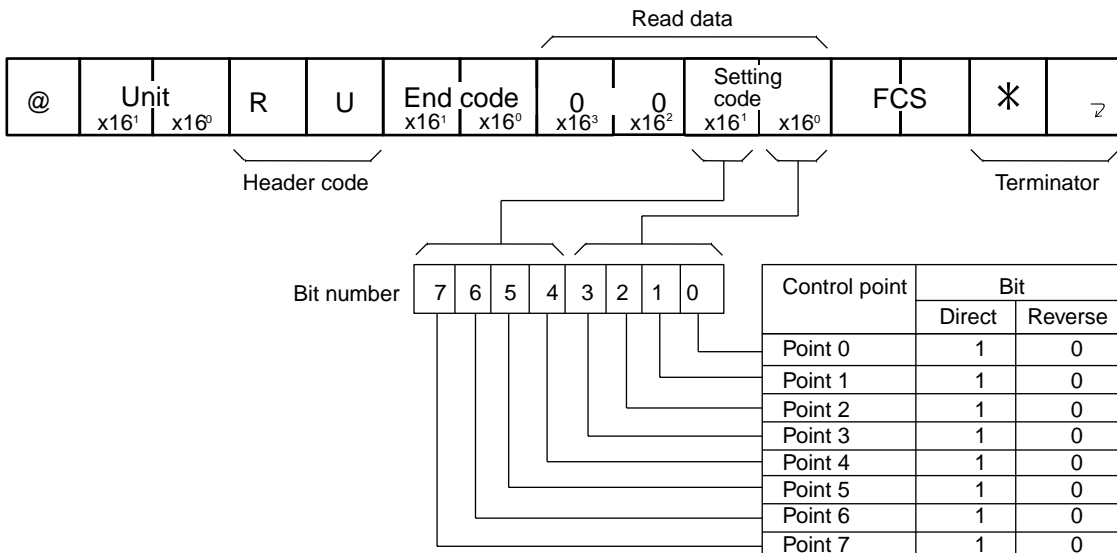

1. The response block for Output Operation Read (RU) does not include read data if the end code of the response block is other than 00.
2. Refer to 2-4 End Codes.

Communications Example

In this example, the E5ZE is operated with Output Operation Read (RU) under the following conditions

Unit no.: 1

Control Points 0, 2, 4, and 6: Direct operation

Control Points 1, 3, 5, and 7: Reverse operation.

Command

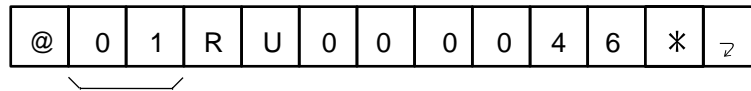

Response

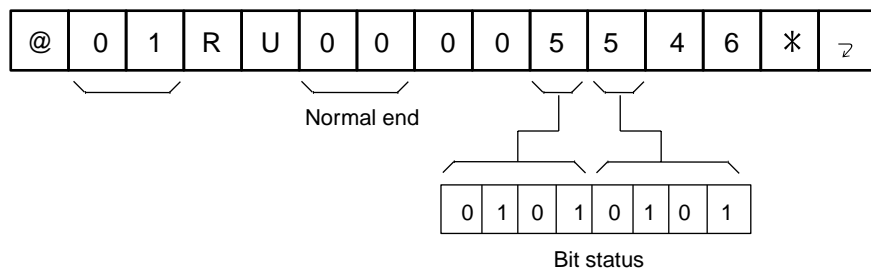

3-15 Alarm Mode Write: W#

Function



This command is used to designate the alarm mode of alarm 1 or 2 of a control point.

1. Alarm Mode Write (W#) cannot be used at a control point in manual operation, control operation or auto-tuning operation.
2. If the temperature control or manual operation at a control point is interrupted, all the alarm output of the control point will be OFF.

Setting Data Range

Alarm		Alarm 1	Alarm 2
Default		00	
Setting code	Alarm OFF	00	
	Upper- and lower-limit alarm	01	
	Upper-limit alarm	02	
	Lower-limit alarm	03	
	Upper- and lower-limit range alarm	04	
	Upper- and lower-limit alarm with standby sequence	05	
	Upper-limit alarm with standby sequence	06	
	Lower-limit alarm with standby sequence	07	
	Absolute-value upper-limit alarm	08	
	Absolute-value lower-limit alarm	09	
	Absolute-value upper-limit alarm with standby sequence	0A	
	Absolute-value lower-limit alarm with standby sequence	0B	
	HB and HS alarm	0C	

Command

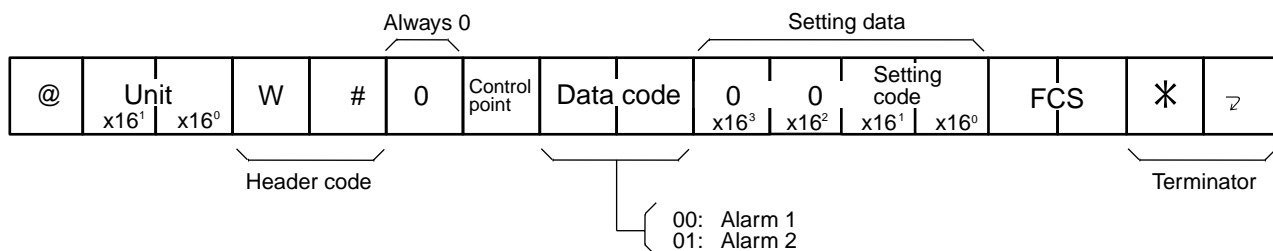

Response

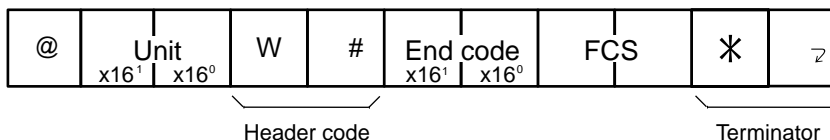

Communications Example

In this example, the E5ZE is operated with Alarm Mode Write (W#) under the following conditions.

- Unit no.: 1
- Control Point: 3
- Alarm 1 Mode: Upper-limit alarm

Command

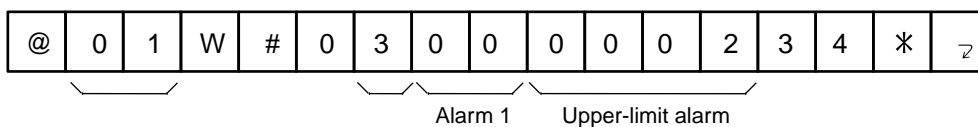

Response



3-16 Alarm Mode Read: R#

Function

This command is used to read the alarm mode that has been set at a control point.

Command

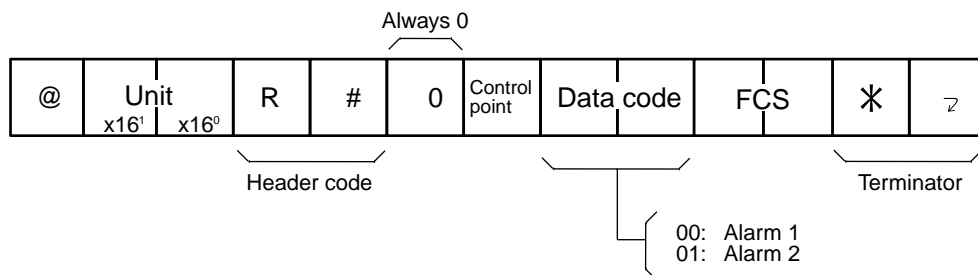

Response

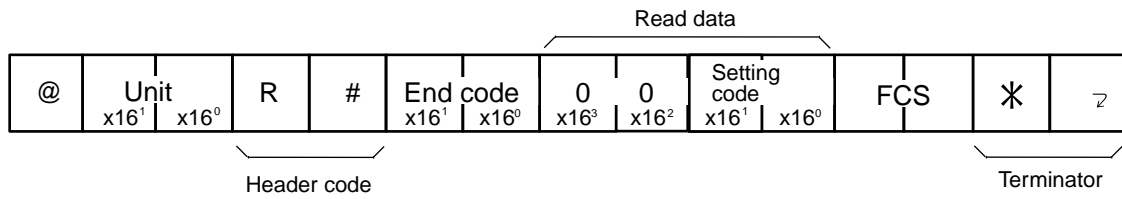

1. Refer to 3-15 Alarm Mode Write: W# for the setting code range of the response format.
2. The response block for Alarm Mode Read (R#) does not include read data if the end code of the response block is other than 00.
3. Refer to 2-4 End Codes.

Communications Example

In this example, the E5ZE is operated with Alarm Mode Read (R#) under the following conditions.

Unit no.: 1
 Control Point: 3
 Alarm 1 Mode: Upper-limit alarm

Command

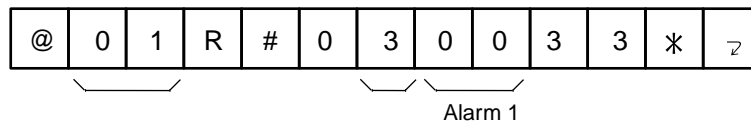

Response

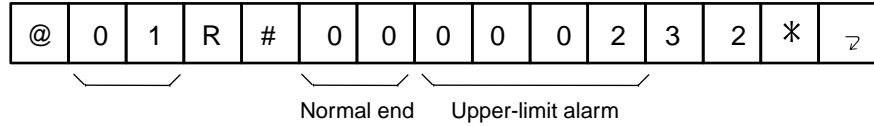

3-17 Alarm Temperature Write: W%

Function

This command is used to set the alarm temperatures for alarm 1 or 2 of a control point.

Setting Data Range

Setting unit		1		0.1	
°C or °F		°C	°F	°C	°F
Default		0000		00000	
Parameters	Alarm OFF	-999 to 9999		-9999 to 99999	
	Upper- and lower-limit alarm	0000 to 9999		00000 to 99999	
	Upper-limit alarm	-999 to 9999		-9999 to 99999	
	Lower-limit alarm	-999 to 9999		-9999 to 99999	
	Upper- and lower-limit range alarm	0000 to 9999		00000 to 99999	
	Upper- and lower-limit alarm with standby sequence	0000 to 9999		00000 to 99999	
	Upper-limit alarm with standby sequence	-999 to 9999		-9999 to 99999	
	Lower-limit alarm with standby sequence	-999 to 9999		-9999 to 99999	
	Absolute-value upper-limit alarm	-999 to 9999		-9999 to 99999	
	Absolute-value lower-limit alarm	-999 to 9999		-9999 to 99999	
	Absolute-value upper-limit alarm with standby sequence	-999 to 9999		-9999 to 99999	
	Absolute-value lower-limit alarm with standby sequence	-999 to 9999		-9999 to 99999	
	HB and HS alarm	---		---	



1. Setting Unit Write (Wt) must be used to set the temperature setting unit of a control point to 1 or 0.1.
2. It is unnecessary to set an alarm temperature if HB and HS alarm data is used as the parameters for Alarm Temperature Write (W%).

Command

When Setting Unit is 1

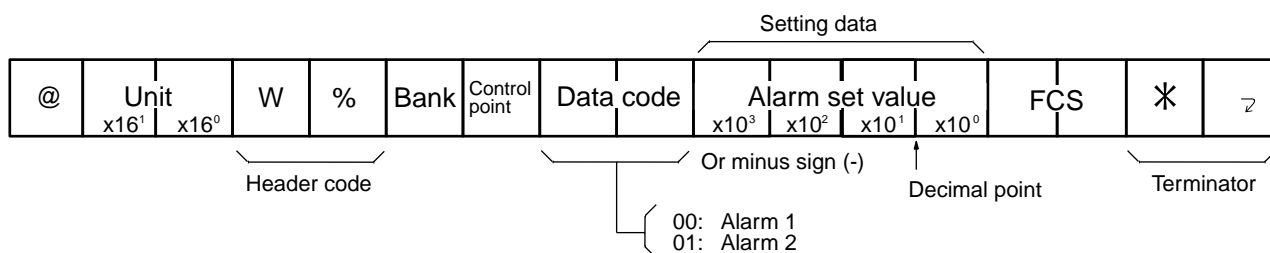

When Setting Unit is 0.1

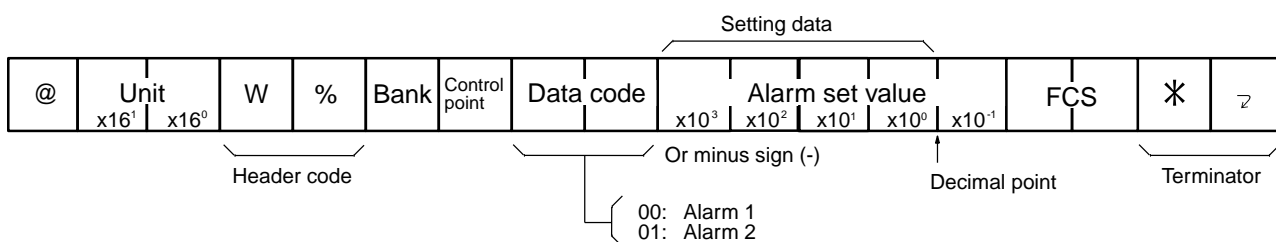

Response

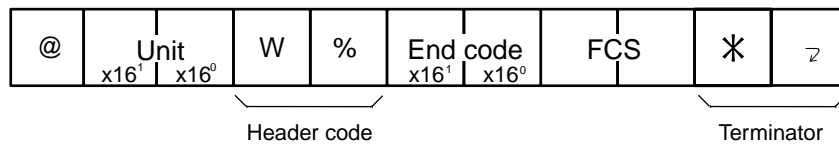

Communications Example

In this example, the E5ZE is operated with Alarm Temperature Write (W%) under the following conditions.

- Unit no.: 1
- Memory Bank no.: 2
- Control Point: 3
- Setting Unit: 1
- Alarm 1 Temperature: 50°C

Command

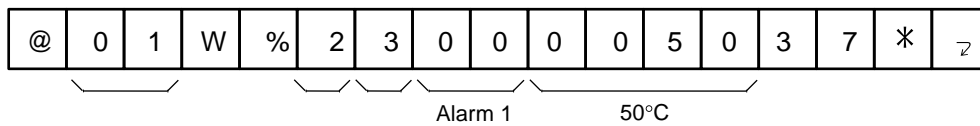

Response

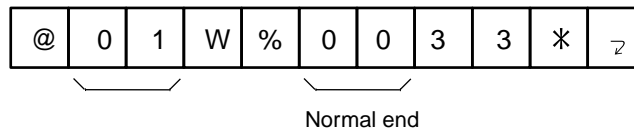

3-18 Alarm Temperature Read: R%

Function

This command is used to read the alarm temperatures that have been set at a control point.

Command

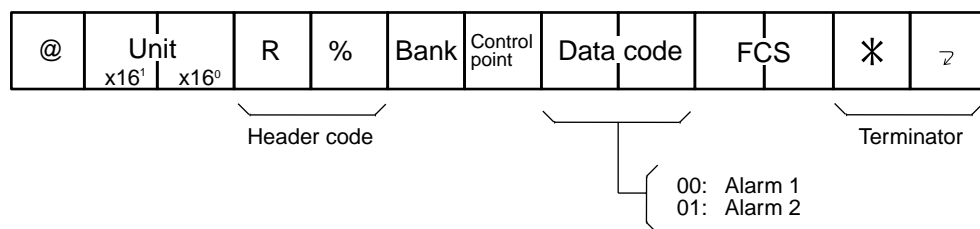

Response

When Setting Unit is 1

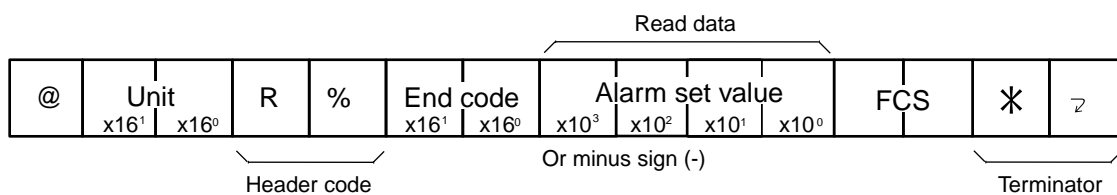

When Setting Unit is 0.1

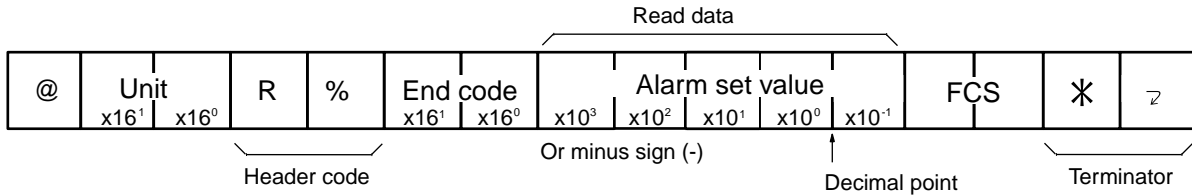

1. The response block for Alarm Temperature Read (R%) does not include read data if the end code of the response block is other than 00.
2. Refer to 2-4 End Codes.

Communications Example

In this example, the E5ZE is operated with Alarm Temperature Read (R%) under the following conditions.

- Unit no.: 1
- Memory Bank no.: 2
- Control Point: 3
- Setting Unit: 1
- Alarm 1 Temperature: 50°C

Command

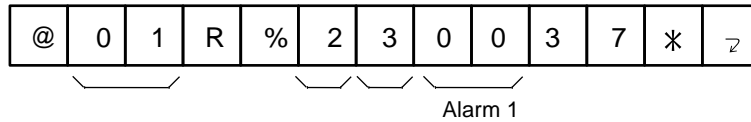

Response

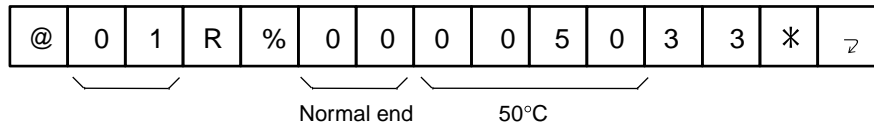

3-19 Memory Bank Designation Write: WM

Function

This command is used to designate the memory banks at a control point that are used for temperature control.



1. Memory Bank Designation Write (WM) cannot be used if the memory bank designation method is set to contact input designation.
2. Memory Bank Designation Write (WM) cannot be used at a control point being auto-tuned.
3. When the E5ZE is turned ON, the memory bank numbers previously selected through communications will be effective.

Setting Data Range

Default	0000 for all control points
Setting data	0000 to 0007

Command

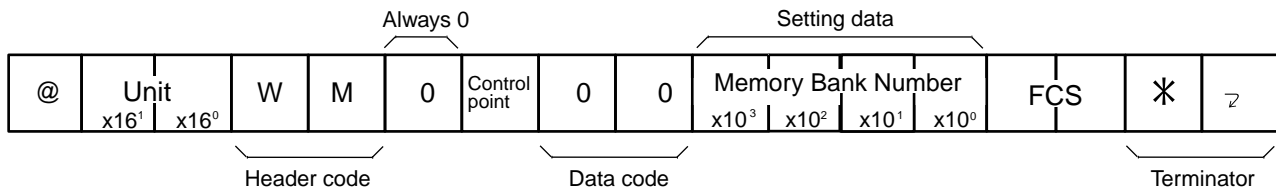

Response

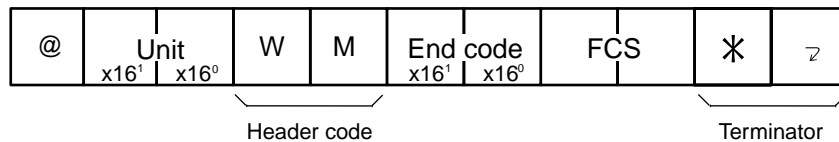

Communications Example

In this example, the E5ZE is operated with Memory Bank Designation Write (WM) under the following conditions.

- Unit no.: 1
- Control Point: 3
- Memory Bank no.: 2

Command

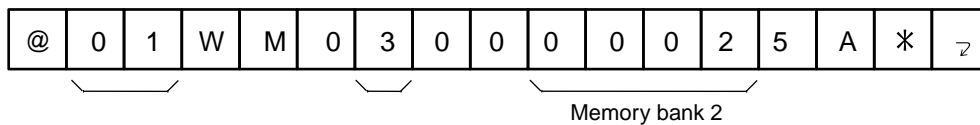

Response

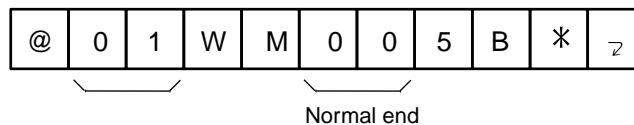

3-20 Memory Bank Designation Read: RM

Function

This command is used to read the memory banks that have been set at a control point.

Command

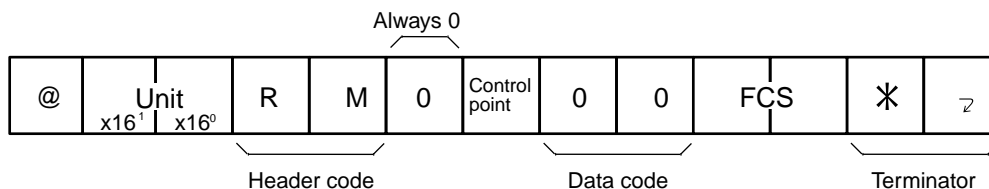

Response

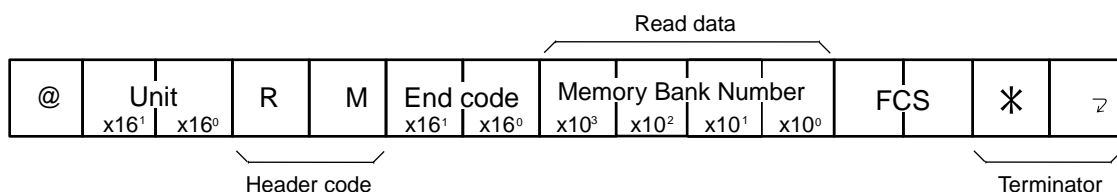

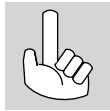

1. The response block for Memory Bank Designation Read (RM) does not include read data if the end code of the response block is other than 00.
2. Refer to 2-4 End Codes.

Communications Example

In this example, the E5ZE is operated with Memory Bank Designation Read (RM) under the following conditions.

Unit no.: 1
 Control Point: 3
 Memory Bank no.: 2

Command

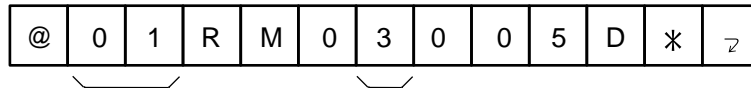

Response

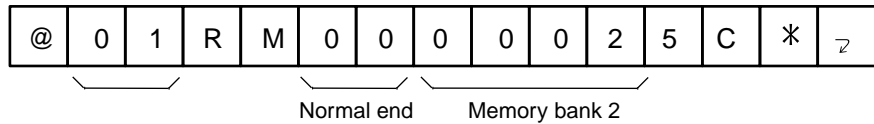

3-21 Hysteresis Write: WH

Function

This command is used to set the hysteresis of control outputs of a control point in ON/OFF operation.



1. Hysteresis Write (WH) cannot be used at a control point being auto-tuned.
2. Hysteresis Write (WH) is invalid if it is used for the E5ZE for 2-PID control.
3. The hysteresis of the cooling-side control outputs can be set provided that the E5ZE is a heating and cooling control model.

Setting Data Range

Setting unit	0.1	
°C or °F	°C	°F
Default	0008	0015
Setting data	0000 to 0999	

Command

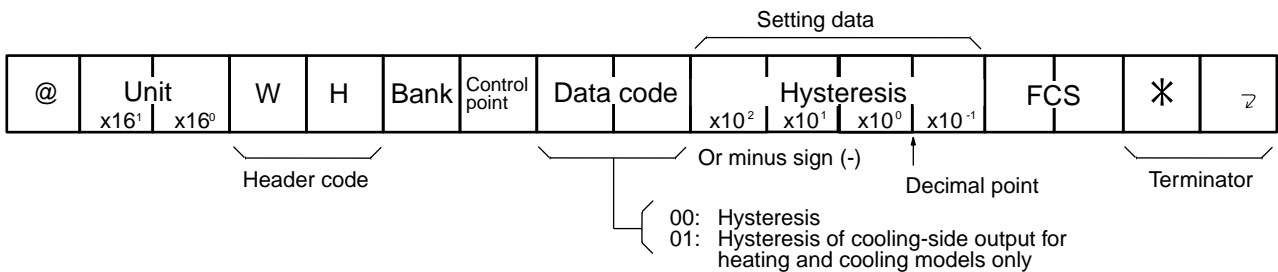

Response

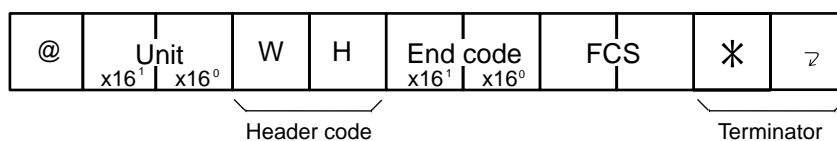

Communications Example

In this example, the E5ZE is operated with Hysteresis Write (WH) under the following conditions.

Unit no.: 1
 Memory Bank no.: 2
 Control Point: 3
 Hysteresis: 1.5°C

Command

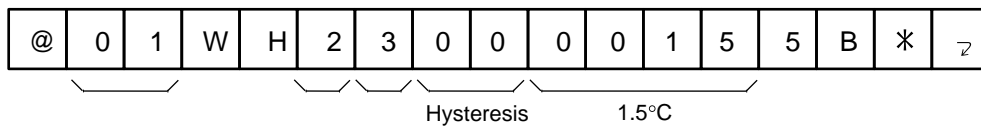

Response

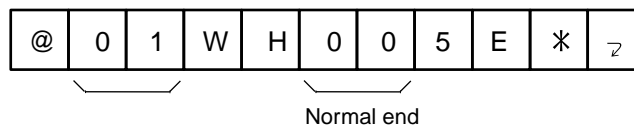

3-22 Hysteresis Read: RH

Function

This command is used to read the hysteresis of control outputs that have been set at a control point.



The hysteresis of the cooling-side control outputs can be read provided that the E5ZE is a heating and cooling control model.

Command

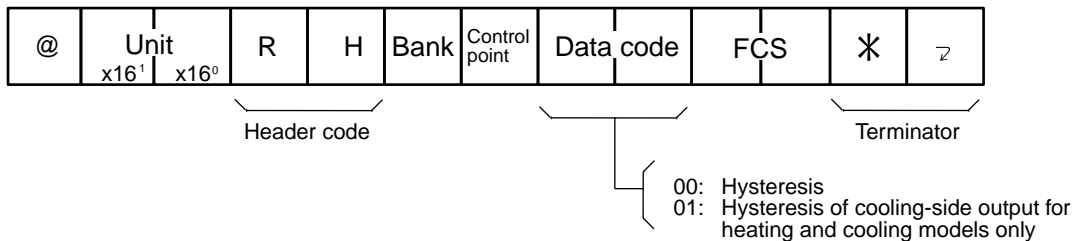

Response

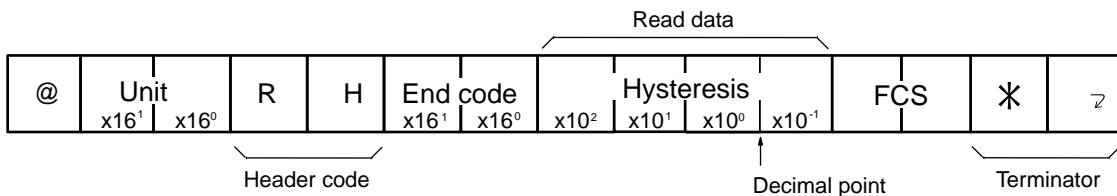

1. The response block for Hysteresis Read (RH) does not include read data if the end code of the response block is other than 00.
2. Refer to 2-4 End Codes.

Communications Example

In this example, the E5ZE is operated with Hysteresis Read (RH) under the following conditions.

Unit no.: 1
 Memory Bank no.: 2

Control Point: 3
 Hysteresis: 1.5°C

Command

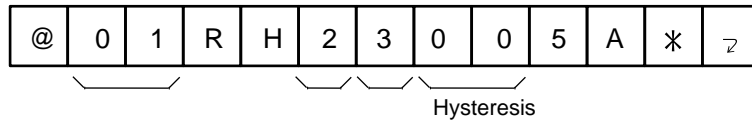

Response

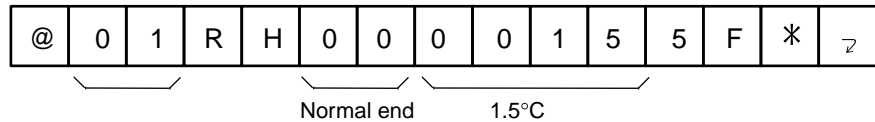

3-23 Status Read: RX

Function

This command is used to read the operating status.

Command

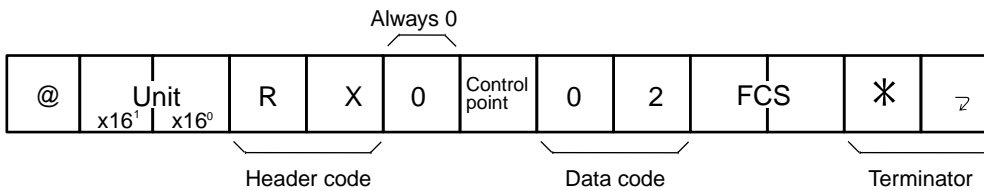

Response

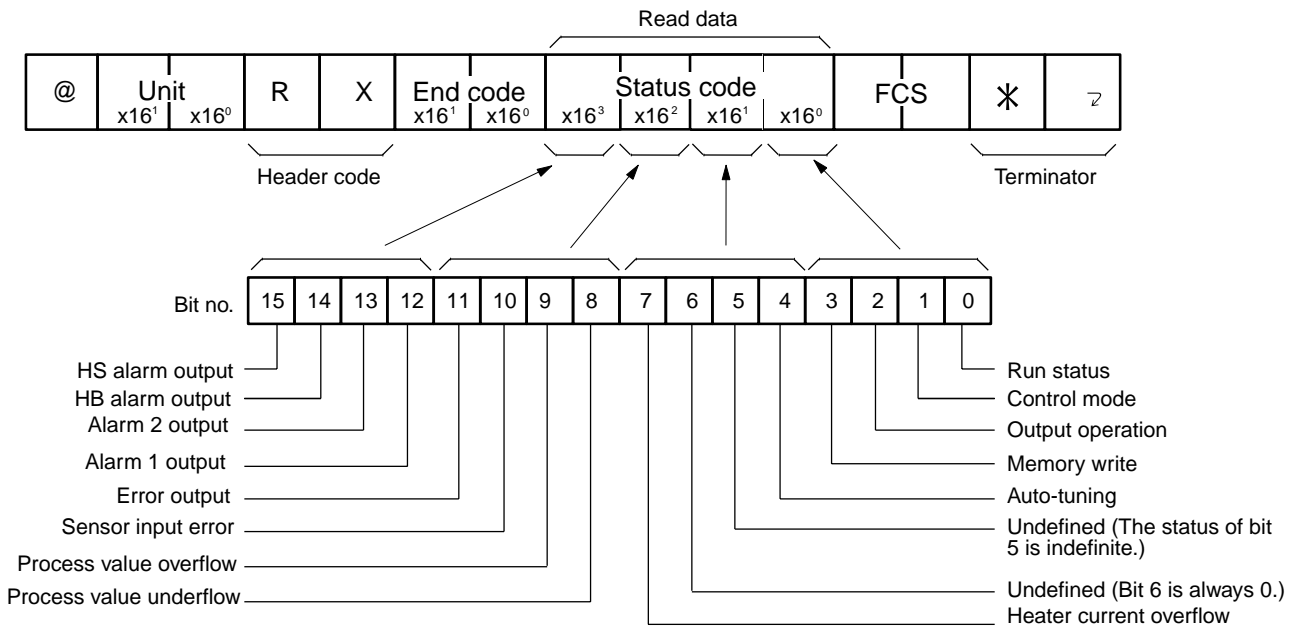

Bit no.	Function	Bit status		Bit no.	Function	Bit status	
		1	0			1	0
0	RUN Status	E5ZE is operating.	E5ZE is OFF.	8	Process Value Underflow	Process value is too low.	Process value is OK.
1	Control Mode	PID	Manual	9	Process Value Overflow	Process value is too high.	Process value is OK.
2	Output Operation	Direct operation	Reverse operation	10	Sensor Input Error	Sensor error.	Sensor is OK.
3	Memory Write	Not written	Written	11	Error Output	ON	OFF
4	Auto-tuning	Auto-tuning.	Not auto-tuning.	12	Alarm 1 Output	ON	OFF
5	Undefined (The status of bit 5 is indefinite.)	---	---	13	Alarm 2 Output	ON	OFF
6	Undefined (Bit 6 is always 0.)	---	0	14	HB Alarm Output	ON	OFF
7	Heater Current Overflow	Current is too large.	Current is normal.	15	HS Alarm Output	ON	OFF

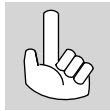

1. The response block for Status Read (RX) does not include read data if the end code of the response block is other than 00.
2. Refer to 2-4 End Codes.
3. The contents of temperature controller errors detected with Status Read (RX) can be checked with Error Read (RU). Refer to 3-24 Error Read: RU.

Communications Example

In this example, the E5ZE is operated with Status Read (RX) under the following conditions.

Unit no.: 1
 Control Point: 3
 RUN Status: ON (E5ZE is operating)
 Control Mode: 2-PID control
 Output Operation: Reverse operation
 Parameters: Written to memory
 Auto-tuning: Not auto-tuning
 Heater Current Overflow: Normal current
 Process Value: OK
 Sensor Input Error: Sensor is OK
 Error Output: OFF
 Alarm 1 Output: ON
 Alarm 2 Output: OFF
 HB Alarm Output: OFF
 HS Alarm Output: OFF

Command

@	0	1	R	X	0	3	0	2	4	A	*	Z
---	---	---	---	---	---	---	---	---	---	---	---	---

Response

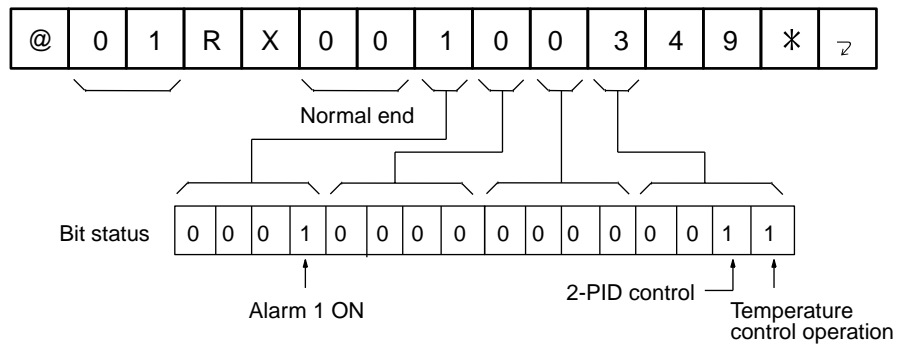

Bit Meanings in Detail

Meanings of other bits have been described previously.

Bit 0: RUN Status

Indicates the following operation control status of the E5ZE.

- Temperature control or manual operation
- OFF

Bit 1: Control Mode

Indicates the control mode of the E5ZE.

- 2-PID control mode (with ON/OFF control)
- Manual operation mode

Bit 2: Output Operation

Indicates the control output operation of the E5ZE.

- Direct operation
- Reverse operation

Bit 3: Memory Write

Indicates the existence or nonexistence of the setting data of the E5ZE.

- Not written
- Written

Bit 4: Auto-tuning

Indicates the auto-tuning status of the E5ZE.

- Auto-tuning
- Not auto-tuning.

Bit 7: Heater Current Overflow

This flag turns ON to indicate that the measured heater current has exceeded 55.0 A. The E5ZE continues temperature control even when this flag turns ON.

Bit 8: Process Value Underflow

This flag turns ON to indicate that the process value at a control point has dropped below the set point range by 20°C or 40°F or more. The E5ZE continues temperature control even when this flag turns ON.

Bit 9: Process Value Overflow

This flag turns ON to indicate that the process value at a control point has exceeded the set point range by 20°C or 40°F. The E5ZE continues temperature control even when this flag turns ON.

Bit 10: Sensor Input Error

This flag turns ON to indicate that the sensor connected to a control point has been incorrectly wired, that the sensor circuit is burnout, or that a temperature input from the sensor has exceeded the set point range. Although the E5ZE

continues temperature control even when this flag turns ON, the control output of the control point will be OFF until this flag turns OFF.

3-24 Error Read: RU

Function



This command is used to obtain information on errors that exist in the E5ZE. If an error exists in the E5ZE, the control output of a control point will be OFF and the E5ZE will turn an error output ON until the error is eliminated.

Command

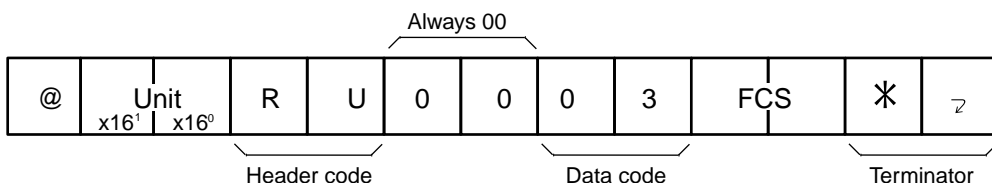

Response

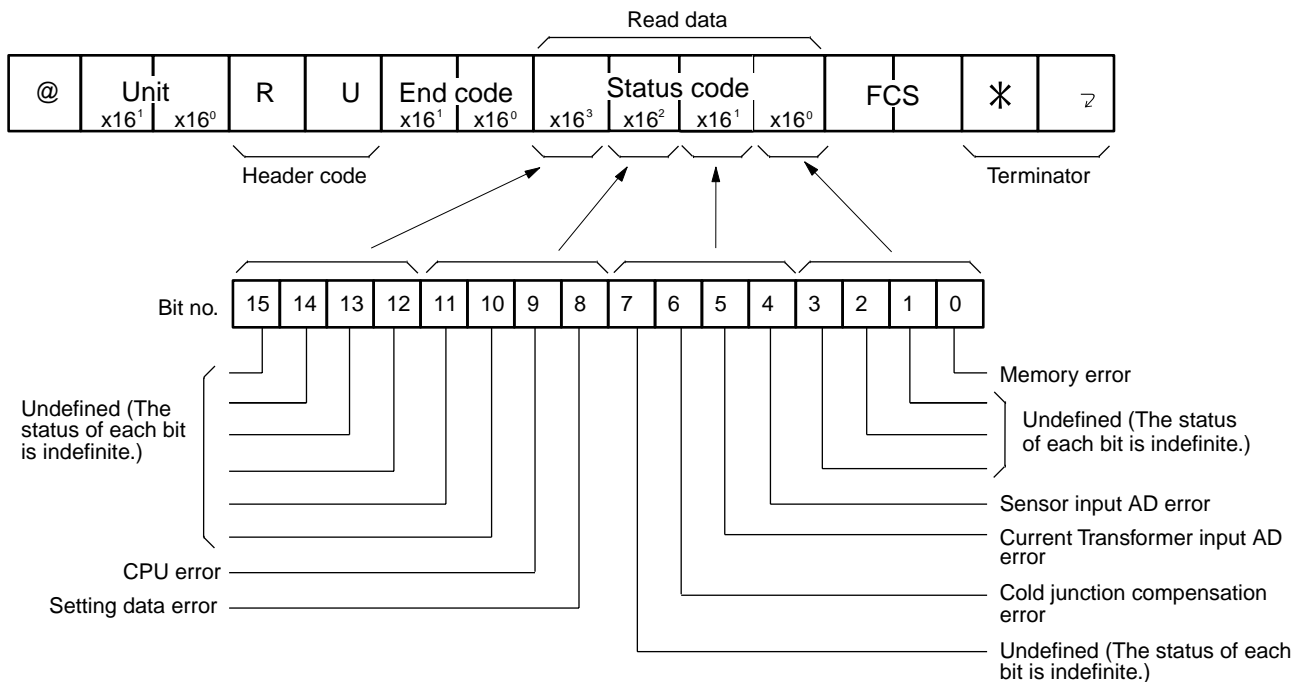

Bit No.	Contents	Bit status	
		1	0
0	Memory error	Error	Normal
1	Undefined (The status of each bit is indefinite.)	---	---
2		---	---
3		---	---
4	Sensor input AD error	Error	Normal
5	Current Transformer input AD error	Error	Normal
6	Cold junction compensation error	Error	Normal
7	Undefined (The status of each bit is indefinite.)	---	---

Bit No.	Contents	Bit status	
		1	0
8	Setting data error	Error	Normal
9	CPU error	Error	Normal
10	Undefined (The status of each bit is indefinite.)	---	---
11		---	---
12		---	---
13		---	---
14		---	---
15		---	---



1. The response block for Error Read (RU) does not include read data if the end code of the response block is other than 00.
2. Refer to 2-4 End Codes.

Communications Example

In this example, the memory error occurs, the unit number of which has been set to 1, is read by the Error Read (RU).

Command

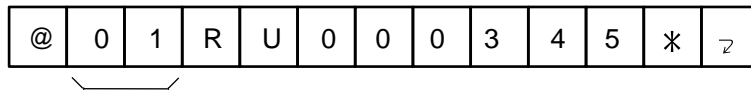

Response

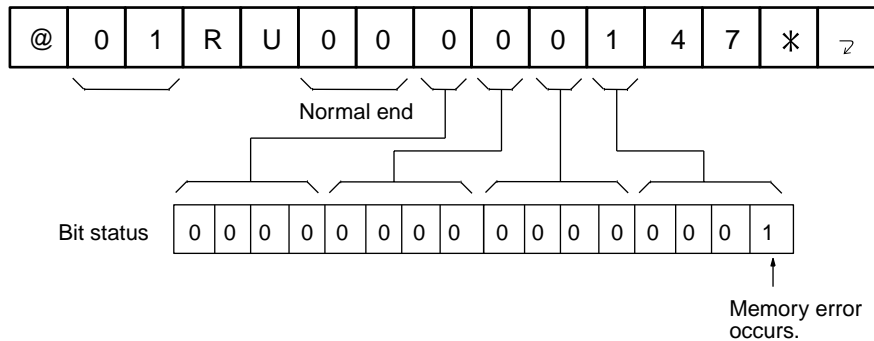

Readable Errors

Refer to the following for the kinds of errors and their meanings.

Memory Error

This error occurs in the following cases.

- The contents of the Memory are destroyed.
- The E5ZE is turned OFF before the E5ZE returns a response to Memory Write (WE) to the host computer.
- The CPU goes out of control.

The calibration data may be destroyed in the following case.

- A memory error occurs after the setting data are set to the factory-set default parameters with Initialize Setting Data (MC) and these parameters are written to the Memory with Memory Write (WE). In such cases, turn the E5ZE OFF and ON. If a memory error occurs again, the E5ZE needs calibration.

Sensor Input AD Error

This error occurs if the IC that converts sensor input values to the E5ZE to digital values fails or a peripheral circuit of the IC fails.

Current Transformer Input AD Error

This error occurs if the IC that converts CT input values to the E5ZE to digital values fails or a peripheral circuit of the IC fails.

Cold Junction Compensation Error

This error occurs in the following cases if the E5ZE is a thermocouple input model.

- The Cold Junction Compensator is not connected to the terminal block correctly.
- The terminals screws of the Cold Junction Compensator is loosened.
- The Cold Junction Compensator is broken.
- The ambient temperature drops below -15°C or exceeds 60°C .

Setting Data Error

This error occurs in the following cases. If a setting data error occurs, initialize the parameters with Initialize Setting Data (MC) within the permissible parameter setting ranges of the E5ZE.

- Setting data in the memory are destroyed.
- A set point of a control point is not within the allowable set point range.

CPU Error

This error occurs if the CPU or its peripheral circuitry is broken.

Reset the set point in the following cases.

- $^{\circ}\text{C}$ is changed to $^{\circ}\text{F}$ or vice versa with the FUNCTION switch.
- The input type connected to a control point is changed with the INPUT selector.

SECTION 4

Commands According to Application

This section describes the commands that are used according to the application.

4-1	Auto-tuning Start: AS	120
4-2	Auto-tuning Stop: AP	121
4-3	Setting Unit Write: Wt	121
4-4	Setting Unit Read: Rt	123
4-5	Input Shift Write: WI	124
4-6	Input Shift Read: RI	125
4-7	Manual Reset Value Write: WK	126
4-8	Manual Reset Value Read: RK	127
4-9	Ramp Value Write: WR	127
4-10	Ramp Value Read: RR	128
4-11	Present Set Point Read: Rs	129
4-12	Manual Output Value Write: WO	131
4-13	Output Variable Limit Value Write: WL	132
4-14	Output Variable Limit Value Read: RL	133
4-15	Output Variable Change Rate Limit Value Write: WG	134
4-16	Output Variable Change Rate Limit Value Read: RG	136
4-17	Memory Write:	136
4-18	Initialize Setting Data: MC	137
4-19	Communication Test: TS	138

4-1 Auto-tuning Start: AS

Function

This command is used to auto-tune a control point.

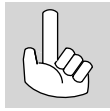

Auto-tuning Start (AS) is not accepted by a control point if the control point is already being auto-tuned or the operation of the control point has been interrupted.



The HB or HS alarm of a control point will not work if the control point is being auto-tuned.

Commands

With Control Point Designated

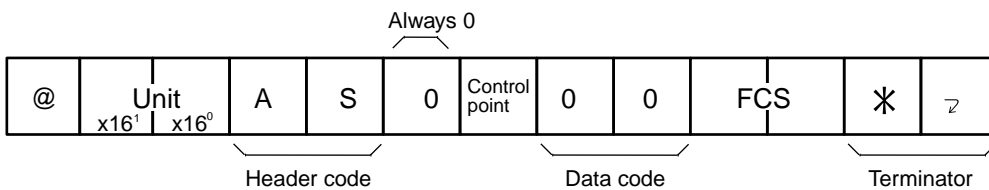

Auto-tuning of All Control Points

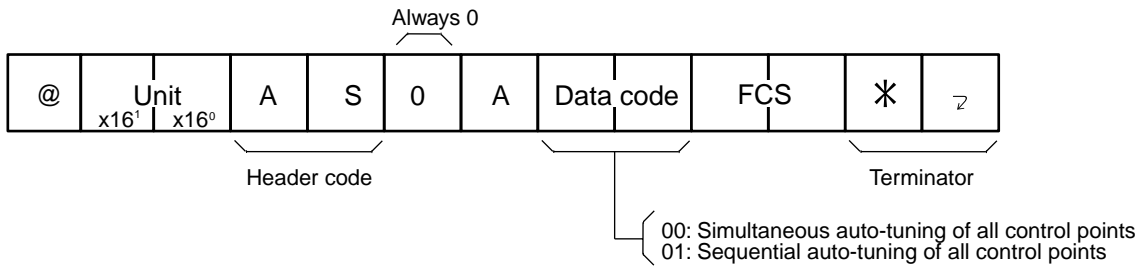

If the control point data of the command block is set to A and the data code of the command block is set to 00, all the control points will be auto-tuned simultaneously. If the control point data of the command block is set to A and the data code of the command block is set to 01, all the control points will be auto-tuned in sequence.

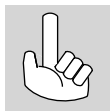

Sequential Auto-tuning of All Control Points:

If the data code of the command block is set to 01, all the control points will be auto-tuned in numerical order.

Response

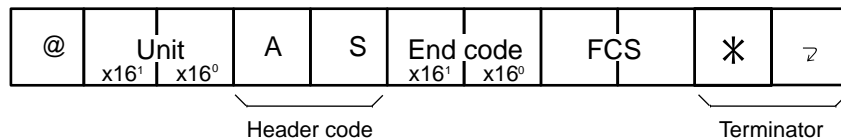

Communications Example

In this example, control point 3, the unit number of which has been set to 1, is auto-tuned with Auto-tuning Start (AS).

Command

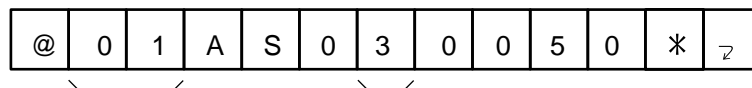

Response

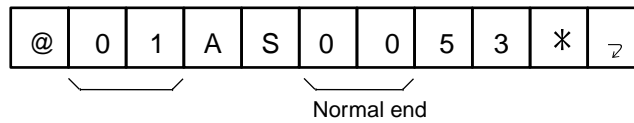

4-2 Auto-tuning Stop: AP

Function



This command is used to stop the auto-tuning of all the control points. Auto-tuning Stop (AP) cannot be used to stop the auto-tuning of a particular control point individually.

Command

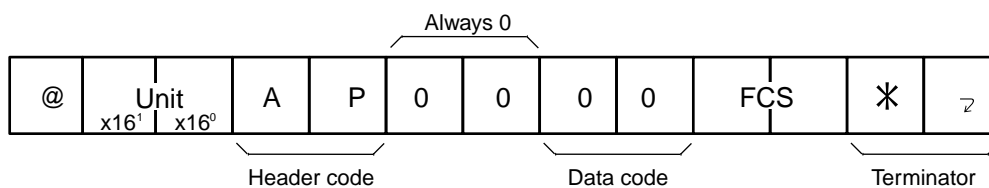

Response

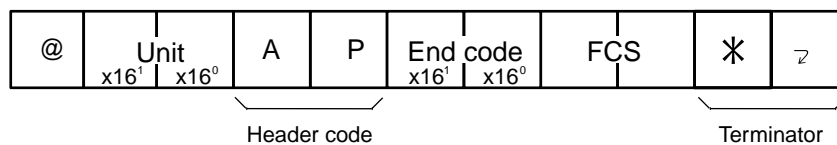

Communications Example

In this example, the auto-tuning of the control points, the unit number of which has been set to 1, is stopped.

Command

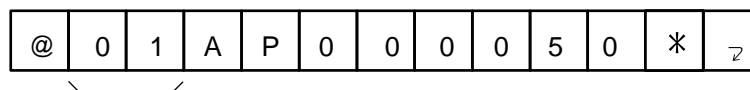

Response

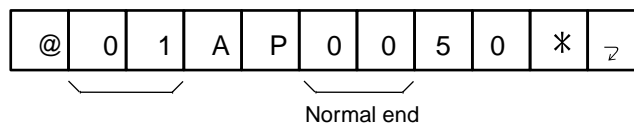

4-3 Setting Unit Write: Wt

Function



This command is used to set the temperature setting unit to 1 or 0.1.

1. The default temperature setting unit varies with the type of input type to be used with the E5ZE as described below.
 - Thermocouple: 1 (default value)
 - Platinum resistance thermometer: 0.1 (default value)
2. The digits of a setting data set with the E5ZE vary with the temperature setting unit if the E5ZE is operated with any of the following commands.
 - Set Point Write (WS) and Set Point Read (RS)

- Process Value Temperature Read (RX)
 - Alarm Temperature Write (W%) and Alarm Temperature Read (R%)
 - Present Set Point Read (Rs)
3. Setting Data Set before Changing Temperature Setting Unit:
- The temperature setting unit of a setting data set for a control point will remain unchanged after the temperature setting unit of the control point is changed.
 - When the E5ZE is operated with Setting Unit Read (Rt), the following parameters will be read.

If the temperature setting unit has been changed to 1 from 0.1:
Parameters will be rounded off (e.g., 1234.5 will be read as 1235).

If the temperature setting unit has been changed to 0.1 from 1:
Parameters with .0 added (e.g., 1234 will be read as 1234.0).

Setting Data Range

Input type	Thermocouple		Platinum resistance thermometer	
°C or °F	°C	°F	°C	°F
Default	0000 (Temperature setting unit: 1)		0001 (Temperature setting unit: 0.1)	
Setting code	0000 to 0001			

Command

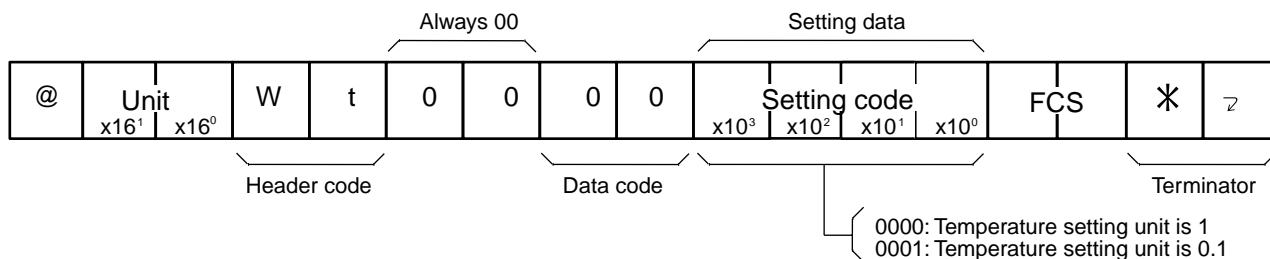

Response

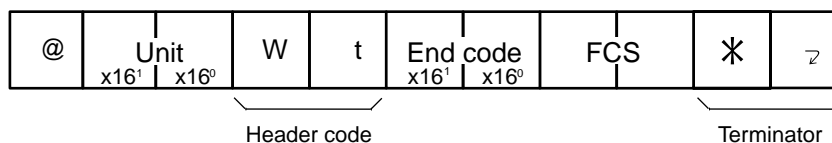

Communications Example

In this example, the E5ZE is operated with Setting Unit Write (Wt) under the following conditions.

Unit no.: 1
Temperature Setting Unit: 1

Command

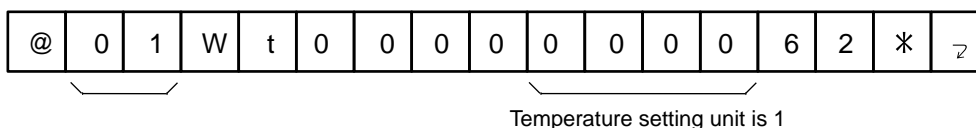

Response

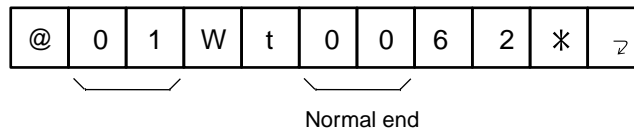

4-4 Setting Unit Read: Rt

Function

This command is used to read the setting unit that has been set with the E5ZE.

Command

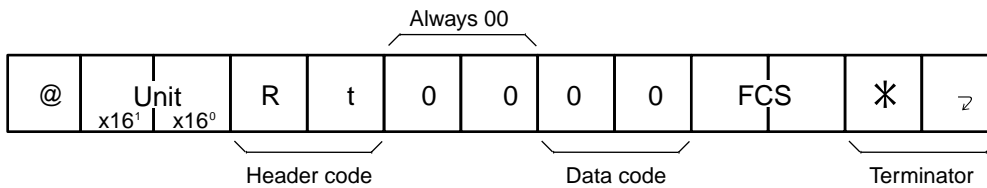

Response

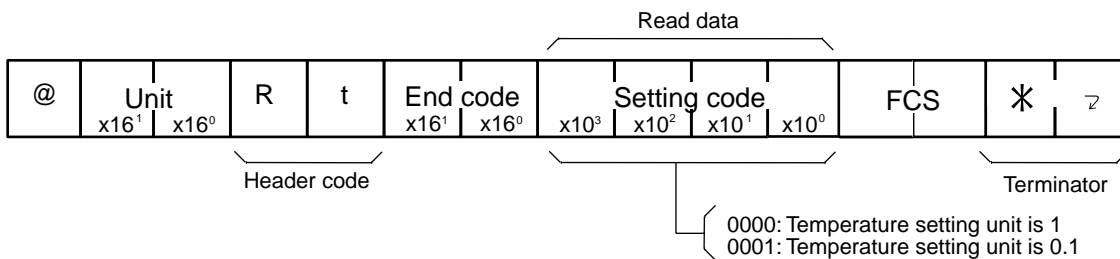

1. The response block for Setting Unit Read (Rt) does not include read data if the end code of the response block is other than 00.
2. Refer to 2-4 End Codes.

Communications Example

In this example, the E5ZE is operated with Setting Unit Read (Rt) under the following conditions.

Unit no.: 1

Temperature Setting Unit: 1

Command

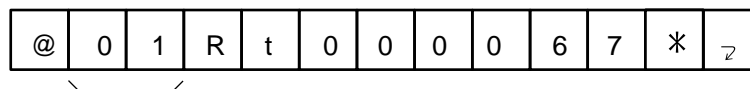

Response

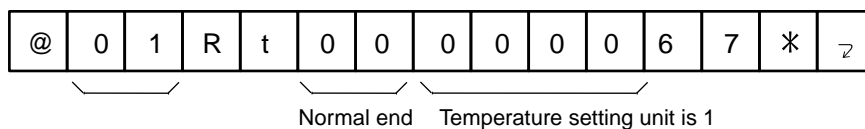

4-5 Input Shift Write: WI

Function

This command is used to write input shift values to shift the processes value. Input Shift Write (WI) cannot be used at a control point being auto-tuned.

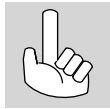

Setting Data Range

Setting unit	0.1	
°C or °F	°C	°F
Default	0000	
Setting data	-999 to 0999	

Command

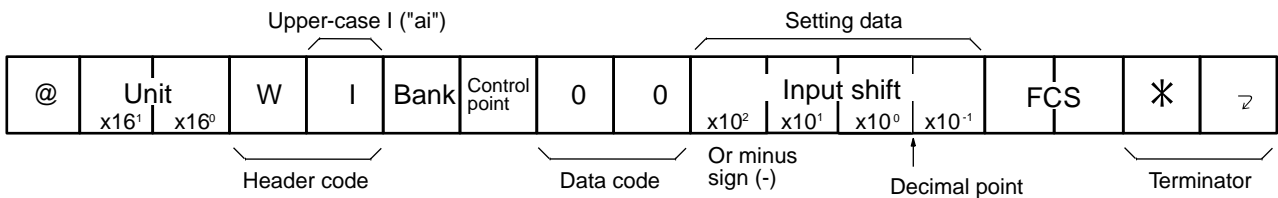

Response

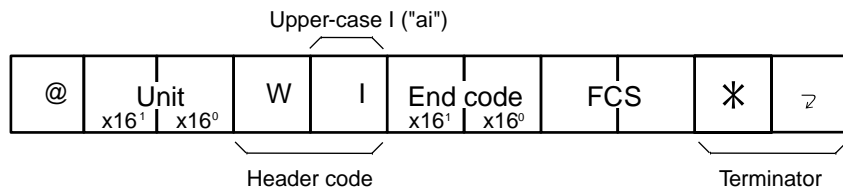

Communications Example

In this example, the E5ZE is operated with Input Shift Write (WI) under the following conditions.

- Unit no: 1
- Memory Bank no.: 2
- Control Point: 3
- Input Shift Value: -12.3°C

Command

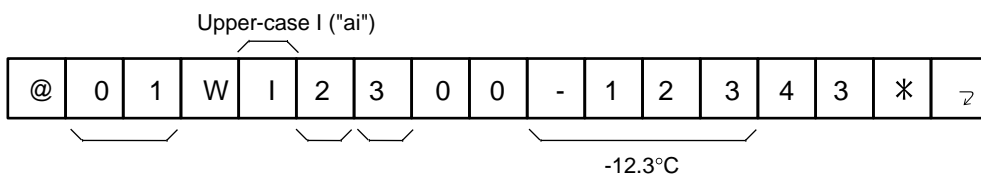

Response

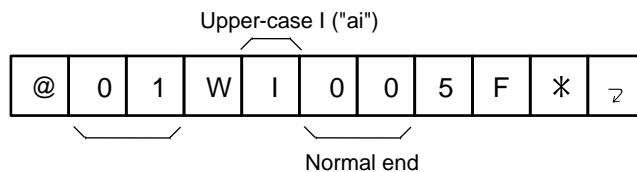

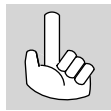

If the sensor input is 100°C, the processes value will be 87.7°C (i.e., $100 - 12.3 = 87.7$). The temperature read with Processes Value Read (RX) will be thus 87.7°C.

4-6 Input Shift Read: RI

Function

This command is used to read the input shift values that have been set at a control point.

Command

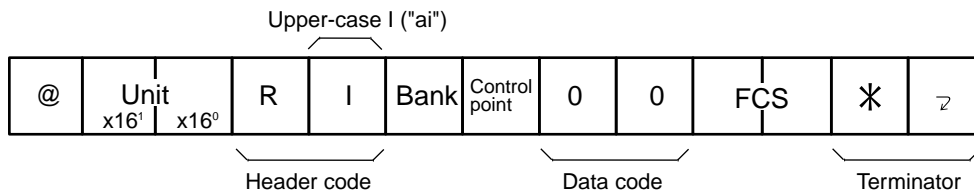

Response

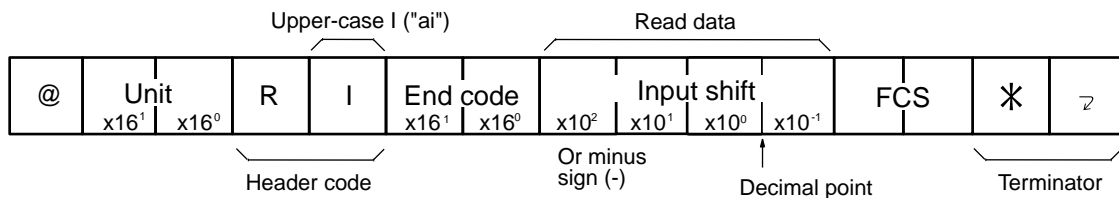

1. The response block for Input Shift Read (RI) does not include read data if the end code of the response block is other than 00.
2. Refer to 2-4 End Codes.

Communications Example

In this example, the E5ZE is operated with Input Shift Read (RI) under the following conditions.

Unit no.: 1
 Memory Bank no.: 2
 Control Point: 3
 Input Shift Value: -12.3°C

Command

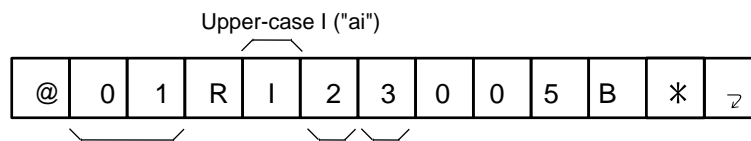

Response

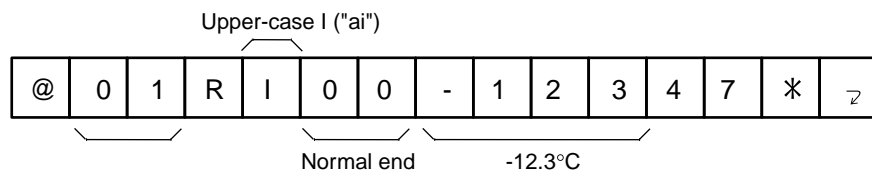

4-7 Manual Reset Value Write: WK

Function

This command is used to write the percentages of manual reset value to a control point when there are offset at the control point in P or PD control operation.



1. The offset at the control point can be corrected by adjusting the manual reset value written to the control point.
2. Manual Reset Value Write (WK) cannot be used at a control point being auto-tuned.

Setting Data Range

Setting unit	0.1
Manual reset value unit	%
Default	0500
Setting data	0000 to 1000

Command

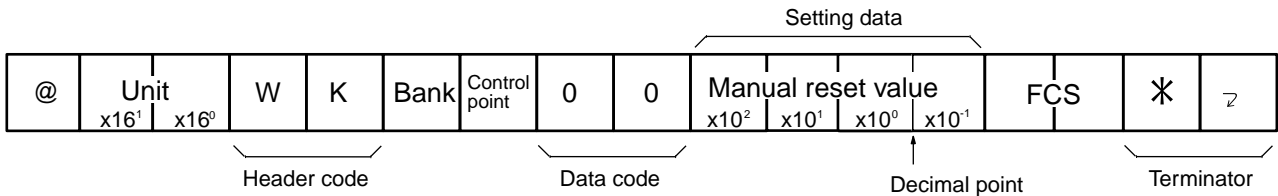

Response

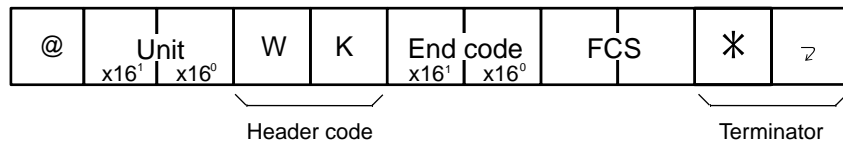

Communications Example

In this example, the E5ZE is operated with Manual Reset Value Write (WK) under the following conditions.

- Unit no.: 1
- Memory Bank no.: 2
- Control Point: 3
- Manual Reset Value: 70.0%

Command

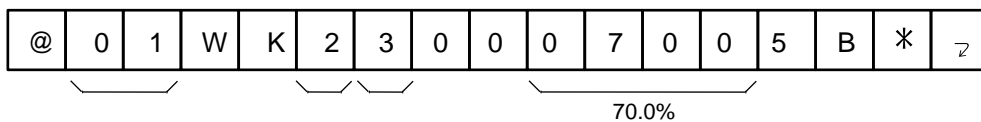

Response

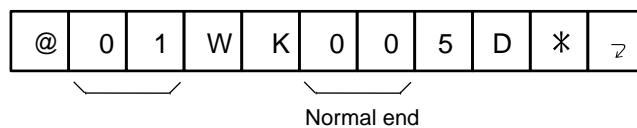

4-8 Manual Reset Value Read: RK

Function

This command is used to read the percentages of manual reset value that have been set at a control point.

Command

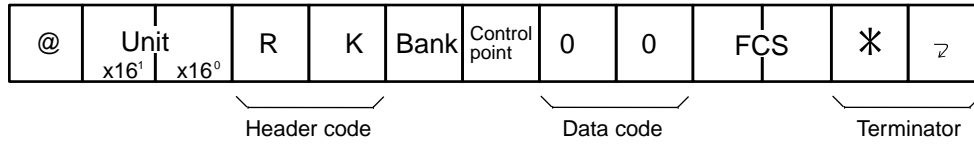

Response

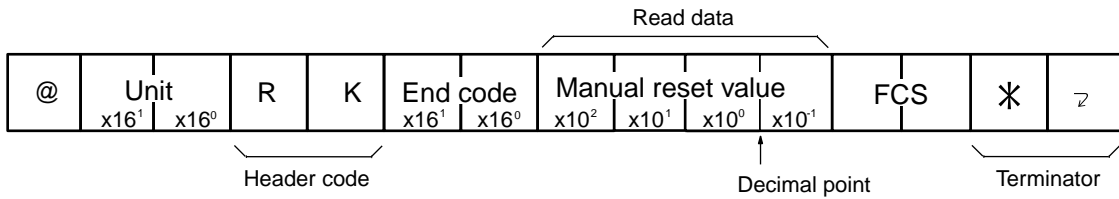

1. The response block for Manual Reset Value Read (RK) does not include read data if the end code of the response block is other than 00.
2. Refer to 2-4 End Codes.

Communications Example

In this example, the E5ZE is operated with Manual Reset Value Read (RK) under the following conditions.

Unit no.: 1
 Memory Bank no.: 2
 Control Point: 3
 Manual Reset Value: 70.0%

Command

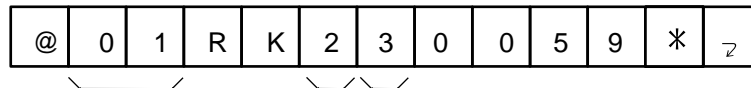

Response

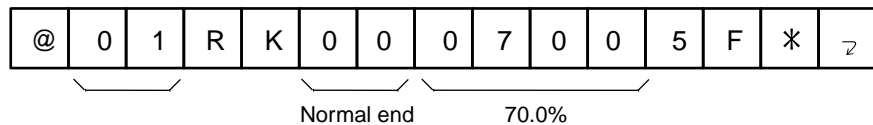

4-9 Ramp Value Write: WR

Function

This command is used to write ramp values to a control point to change the set point of the control point constantly.

Setting Data Range

Time	Second	Minute	Hour
Symbol	S	M	H

Setting unit	0.1					
Temperature unit	°C/s	°F/s	°C/min	°F/min	°C/h	°F/h
Default	000					
Setting data	000 to 999					

Command

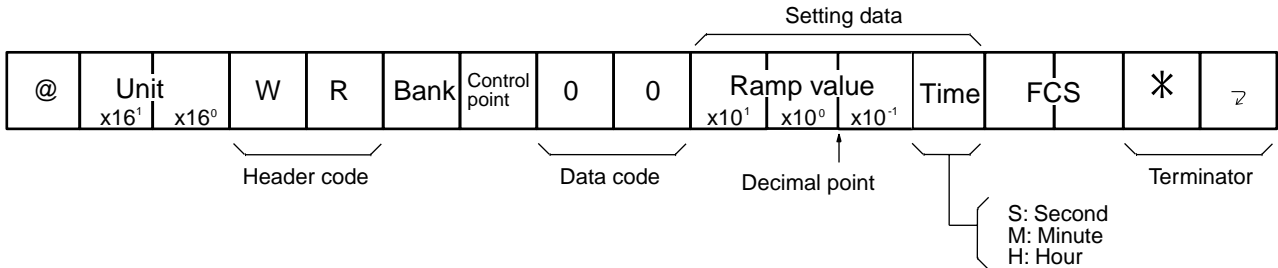

Response

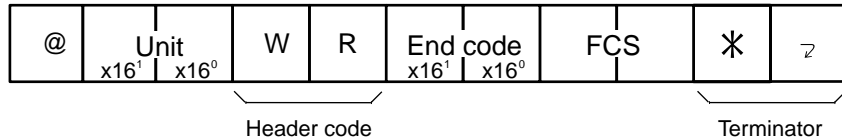

Communications Example

In this example, the E5ZE is operated with Ramp Value Write (WR) under the following conditions.

- Unit no.: 1
- Memory Bank no.: 2
- Control Point: 3
- Ramp Value: 10.0 min

Command

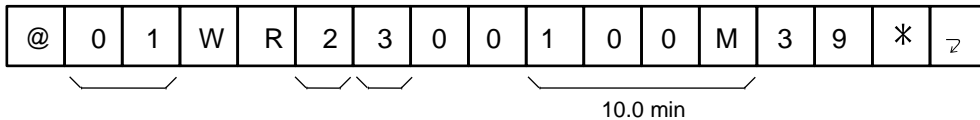

Response

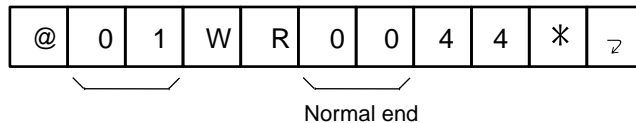

4-10 Ramp Value Read: RR

Function

This command is used to read the ramp values that have been set at a control point.

Command

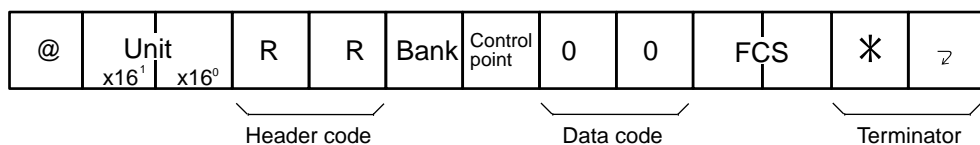

Response

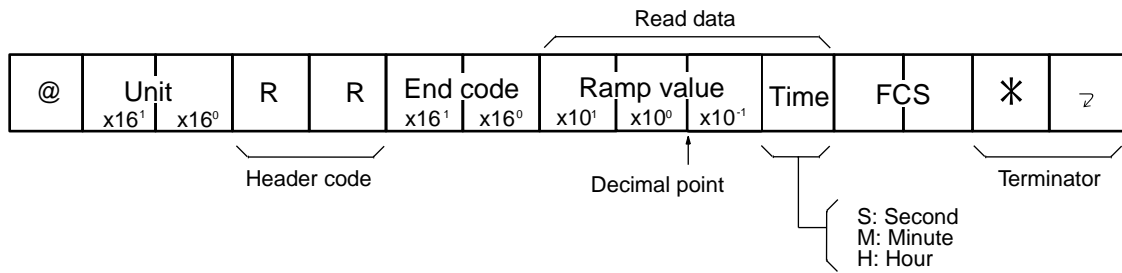

1. The response block for Ramp Value Read (RR) does not include read data if the end code of the response block is other than 00.
2. Refer to 2-4 End Codes.

Communications Example

In this example, the E5ZE is operated with Ramp Value Read (RR) under the following conditions.

Unit no.: 1
 Memory Bank no.: 2
 Control Point: 3
 Ramp Value: 10.0 min

Command

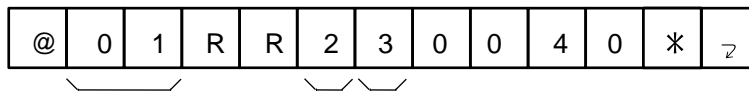

Response

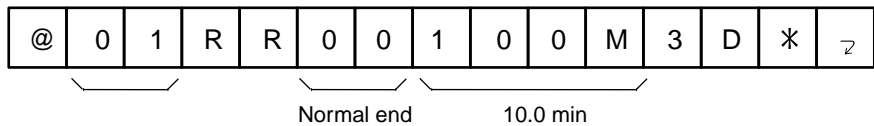

4-11 Present Set Point Read: Rs

Function

This command is used to read the present set point of a control point in ramp operation.

Command

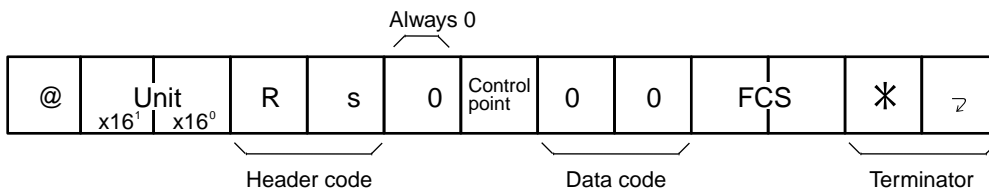

Response Formats of E5ZE in Temperature Control Operation

When Setting Unit is 1

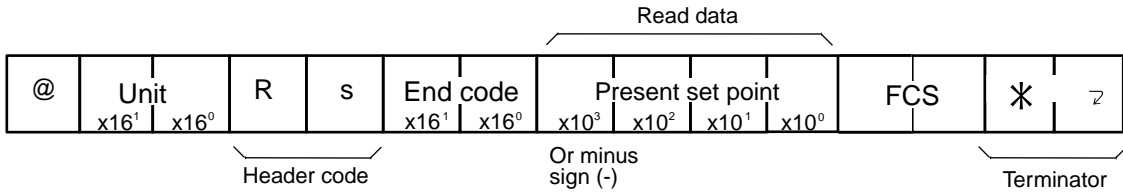

When Setting Unit is 0.1

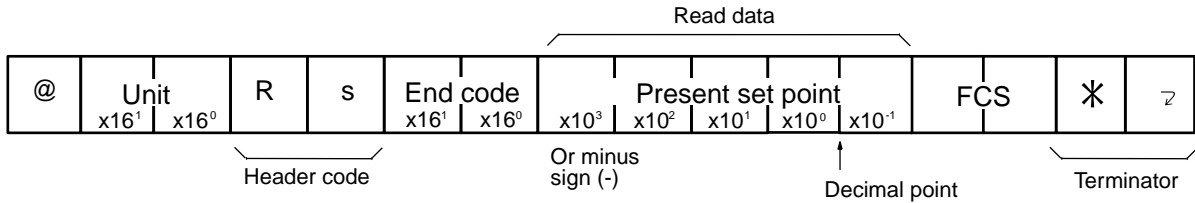

Response Formats of E5ZE not in Temperature Control Operation

Present Set Point Read (Rs) enables the E5ZE to read error codes when the E5ZE is not in temperature control operation.

When Setting Unit is 1

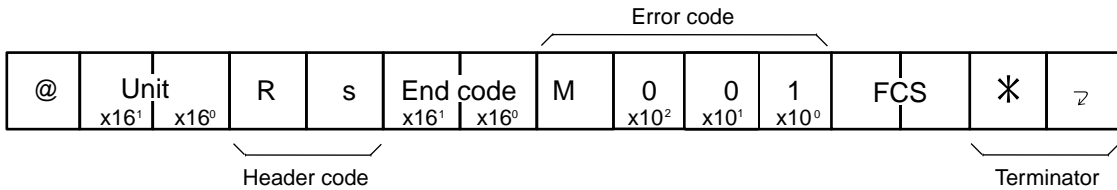

When Setting Unit is 0.1

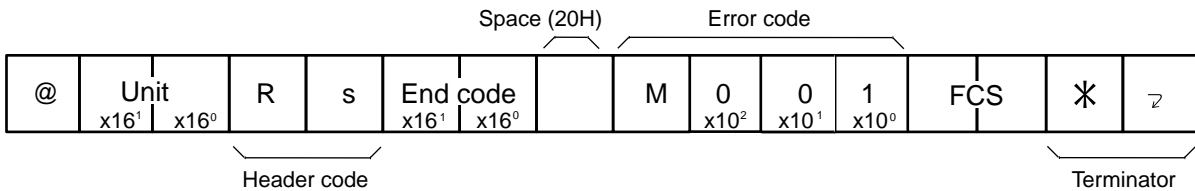

1. The response block for Present Set Point Read (Rs) does not include read data or an error code if the end code of the response block is other than 00.
2. Refer to 2-4 End Codes and 2-5 Error Codes.

Communications Example

In this example, the E5ZE is operated with Present Set Point Read (Rs) under the following conditions.

Unit no.: 1
 Control Point: 3
 Setting Unit: 1
 Present Set Point: 200°C

Command

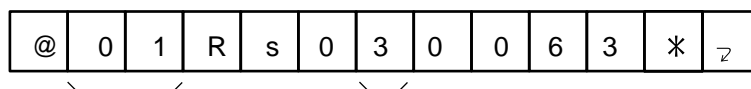

Response

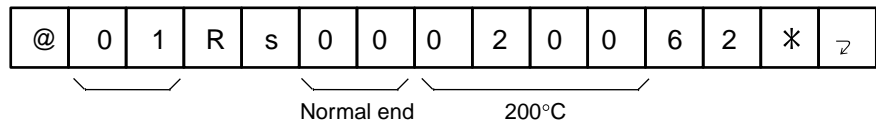

4-12 Manual Output Value Write: WO

Function



This command is used to write the percentage of manual output value to a control point.

1. Manual Output Value Write (WO) is used with the E5ZE only when the E5ZE is in manual operation.
2. The percentage of cooling-side output value can be written to a control point only if the E5ZE is a heating and cooling control model.
3. The E5ZE operates manually even if the E5ZE detects a sensor input error. Manual Output Value Write (WO), however, cannot be used with the E5ZE if the E5ZE detects a sensor input error.
4. If the E5ZE has an error, the E5ZE cannot operate manually and Manual Output Value Write (WO) cannot be used with the E5ZE.

Setting Data Range

Setting unit	0.1
Manual output value unit	%
Setting data	0000 to 1000

Command

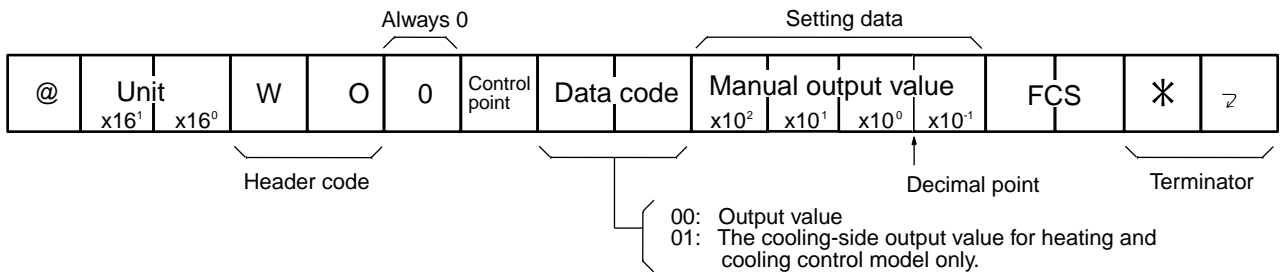

Response

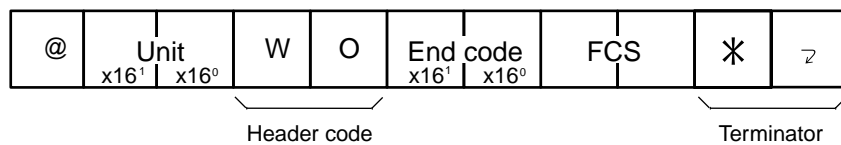

Communications Example

In this example, the E5ZE is operated with Manual Output Value Write (WO) under the following conditions.

Unit no.: 1
 Control Point: 3
 Manual Output Value: 50.0%

Command

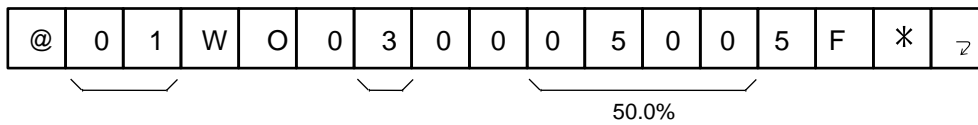

Response

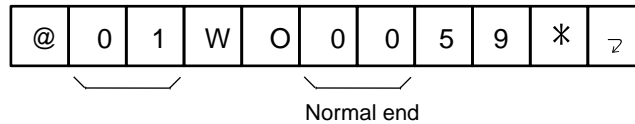

4-13 Output Variable Limit Value Write: WL

Function

This command is used to write control output variable limit values to a control point.



1. Output Variable Limit Value Write (WL) cannot be used at a control point being auto-tuned.
2. Cooling-side output variable limit values can be written to a control point provided that the E5ZE is a heating and cooling control model.



The output variable limit function will not work at a control point in the following cases.

- The E5ZE is in manual operation.
- The E5ZE has an error.
- The E5ZE detects a sensor input error.
- The E5ZE is stopped.

Setting Data Range

Setting item	Lower limit	Upper limit
Setting unit	0.1	
Output variable limit value unit	%	
Default	0000	1000
Setting data	0000 to 1000	



1. The output variable lower-limit value set at a control point must not be larger than the upper output variable limit value.
2. If the output variable lower-limit value set at a control point is 1000, the output value will be always 100.0%.
3. If the output variable upper-limit value set at a control point is 1000, the output value will be always 0.0%.
4. If an output variable limit value is set at a control point as both output variable lower-limit value and upper-limit value, the output value will be the output variable limit value.

Command

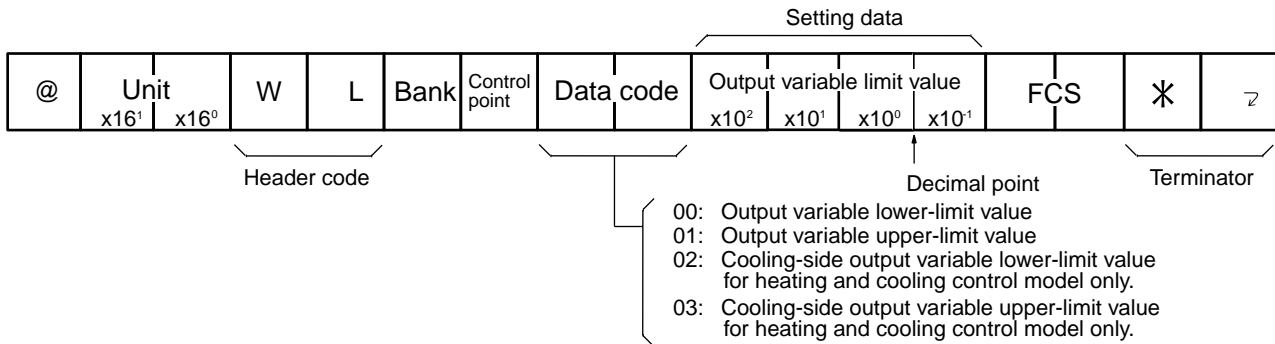

Response

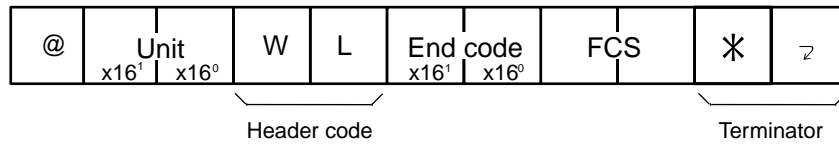

Communications Example

In this example, the E5ZE is operated with Output Variable Limit Value Write (WL) under the following conditions.

- Unit no.: 1
- Memory Bank no.: 2
- Control Point: 3
- Output Variable Lower-limit Value: 20.0%

Command

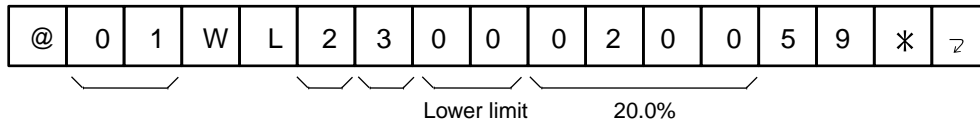

Response

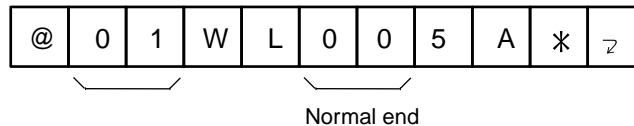

4-14 Output Variable Limit Value Read: RL

Function

This command is used to read the output variable limit values that have been set at a control point.



The cooling-side output variable limit values that have been set at a control point can be read provided that the E5ZE is a heating and cooling control model.

Command

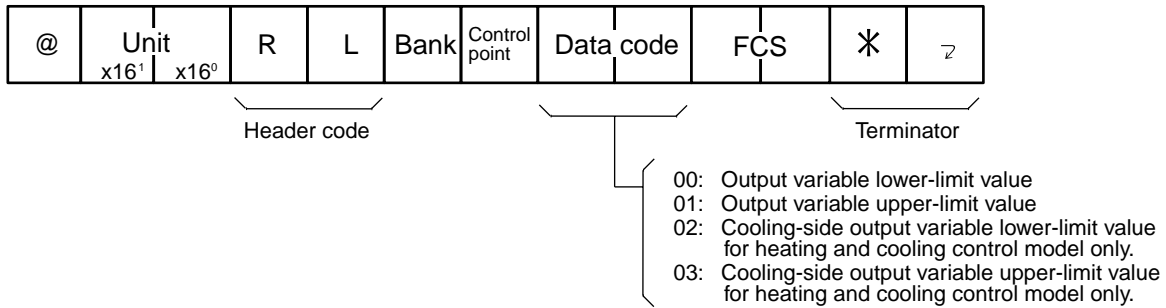

Response

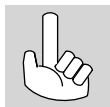
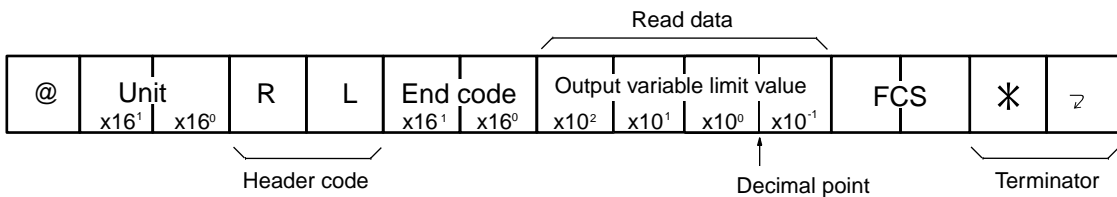

1. The response block for Output Variable Limit Value Read (RL) does not include read data if the end code of the response block is other than 00.
2. Refer to 2-4 End Codes.

Communications Example

In this example, the E5ZE is operated with Output Variable Limit Value Read (RL) under the following conditions.

Unit no.: 1
 Memory Bank no.: 2
 Control Point: 3
 Output Variable Lower-limit Value: 20.0%

Command

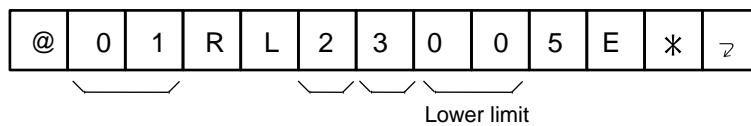

Response

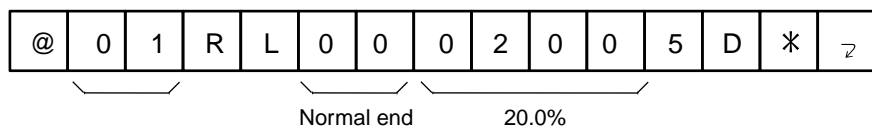

4-15 Output Variable Change Rate Limit Value Write: WG

Function

This command is used to write control output variable change rate limit values to a control point.



1. Output Variable Change Rate Limit Value Write (WG) cannot be used at a control point being auto-tuned.
2. The output variable change rate limit function will not work at a control point in the following cases.
 - An output variable change rate limit value of 0000 is used for the E5ZE.
 - The control point is being auto-tuned.
 - The E5ZE is in manual operation.

- The E5ZE has an error.

Setting Data Range

Setting unit	0.1
Change rate unit	%/(Sampling period)
Default	0000
Setting data	0000 to 1000



The percentage of output per sampling period of a control point must be set as the output variable change rate limit value.

Command

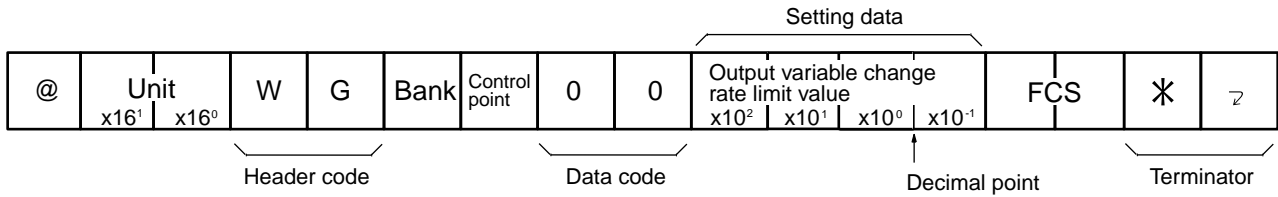

Response

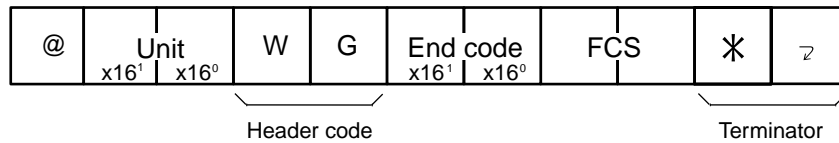

Communications Example

In this example, the E5ZE is operated with Output Variable Change Rate Limit Value Write (WG) under the following conditions.

- Unit no.: 1
- Memory Bank no.: 2
- Control Point: 3
- Output Variable Change Rate Limit Value: 60.0% per sampling period

Command

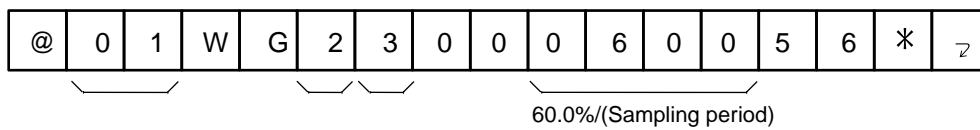

Response

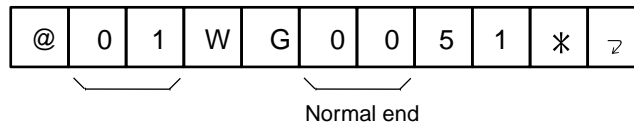

4-16 Output Variable Change Rate Limit Value Read: RG

Function

This command is used to read the output variable change rate limit values that have been set at a control point.

Command

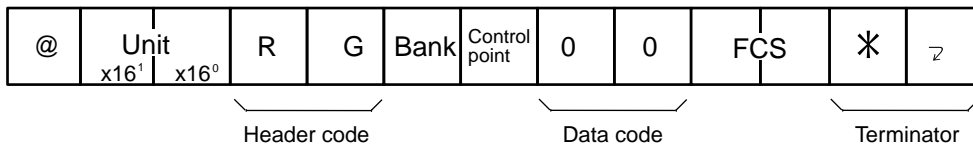

Response

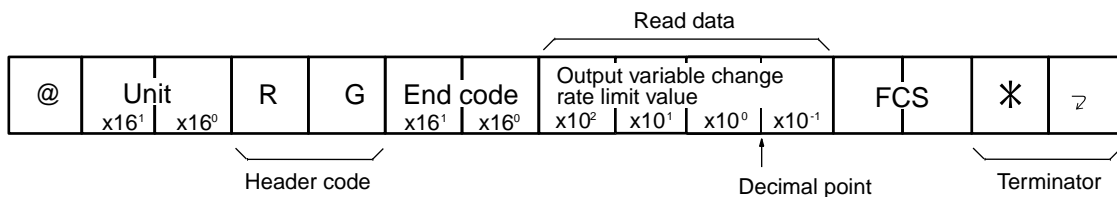

- The response block for Output Variable Change Rate Limit Value Read (RG) does not include read data if the end code of the response block is other than 00.
- Refer to 2-4 End Codes.

Communications Example

In this example, the E5ZE is operated with Output Variable Change Rate Limit Value Read (RG) under the following conditions.

Unit no.: 1
 Memory Bank no.: 2
 Control Point: 3
 Output Variable Change Rate Limit Value: 60.0% per sampling period

Command

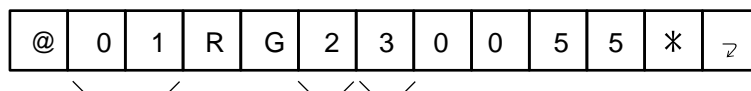

Response

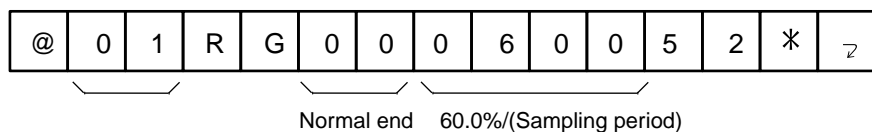

4-17 Memory Write: WE

Function

This command is used to write the setting data set with the E5ZE to the memory.



When the E5ZE is turned ON, the setting data stored in the memory will be read by the E5ZE automatically for temperature control use.



If the E5ZE is turned OFF before the E5ZE returns a response to Memory Write (WE) to the host computer connected to the E5ZE, the setting data set with the E5ZE may not be written to the memory, in which case a memory error will occur.

Command

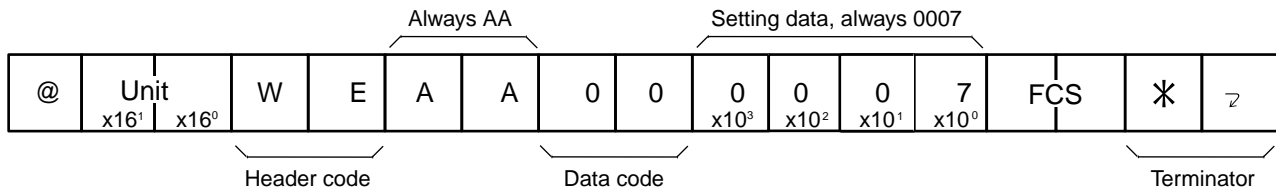

Response

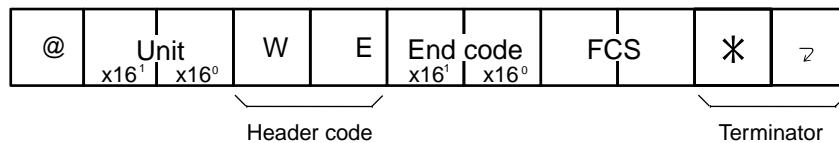

Communications Example

In this example, setting data, the unit number of which has been set to 1, are written to the memory with Memory Write (WE).

Command

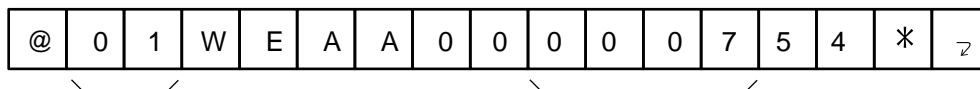

Response

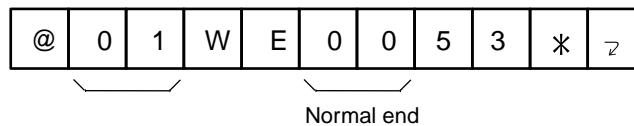

4-18 Initialize Setting Data: MC

Function

This command is used to set the memory to the factory-set default setting data.



1. Initialize Setting Data (MC) can be used only when the E5ZE is stopped.
2. Initialize Setting Data (MC) cannot be used to reset a particular control point or memory bank individually.
3. Initialize Setting Data (MC) does not affect the contents of the memory and saved calibration values. To initialize the stored set data of the E5ZE, send this command and then Memory Write (WE) with the factory-set setting data.



If the temperature unit is changed from °C to °F or vice versa or the input type connected to the E5ZE is changed at a control point, set the RAM to the factory-set default setting data and reset data with the E5ZE.

Command

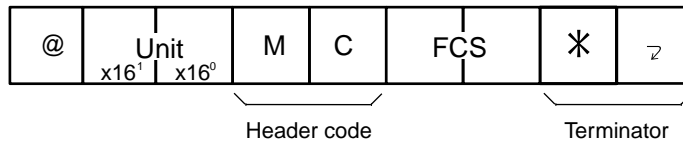

Response

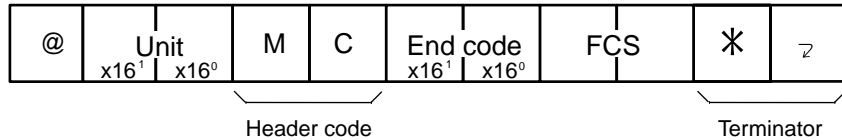

Communications Example

In this example, setting data, the unit number of which has been set to 1, are reset to the factory-set default setting data with Initialize Setting Data (MC).

Command

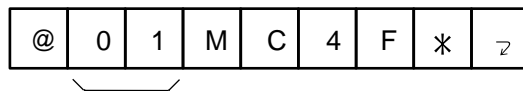

Response

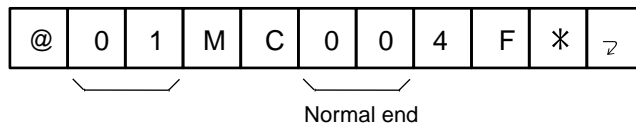

4-19 Communication Test: TS

Function

This command is used to enable a control point to send back to the host system connected to the E5ZE the character strings received at the control point from the host system.



Character strings can contain all characters except the following characters.
 @: (40H)
 \r: (carriage return) (0DH)

Command

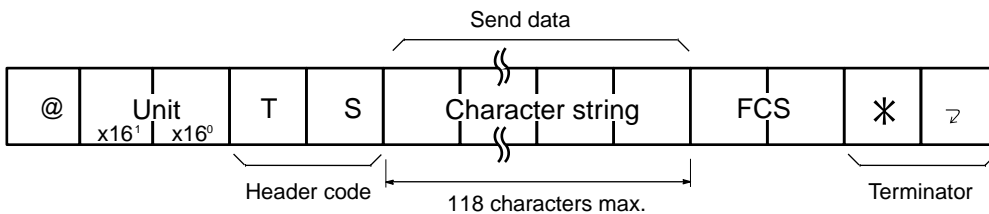

Response

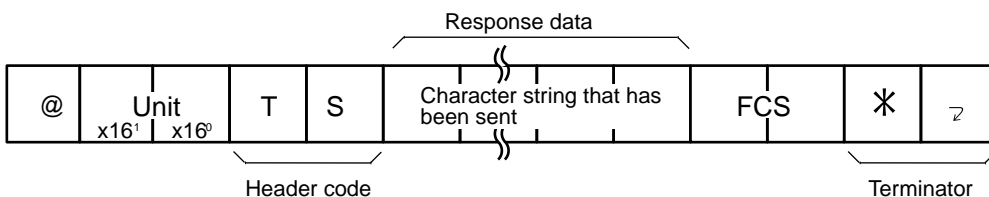

Response Block with Error Detected

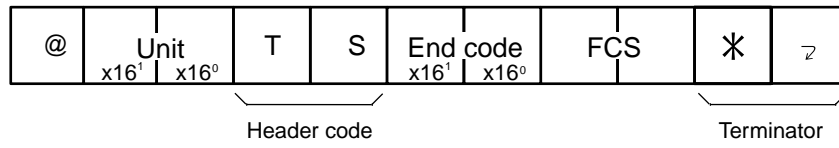

1. The contents of the error will be indicated by the end code in the response block.
2. Refer to 2-4 End Codes.

Communications Example

In this example, character string ABC123 is sent to the E5ZE, the unit number of which has been set to 1, with the Communication Test (TS).

Command

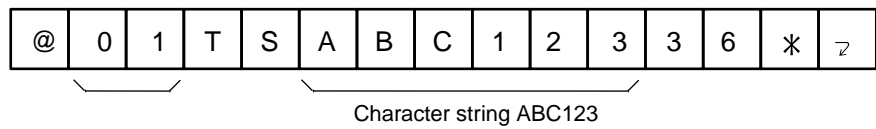

Response

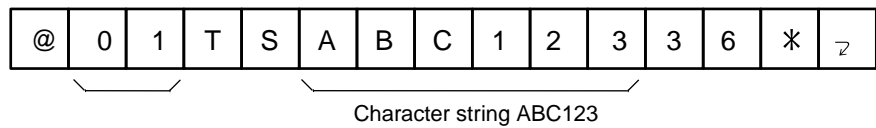

SECTION 5

Heater Burnout and SSR Failure Detection Commands

This section describes the commands used for heater burnout and SSR failure detection.

5-1	HB Alarm and HS Alarm Point Write: WU	142
5-2	HB Alarm and HS Alarm Point Read: RU	143
5-3	Heater Burnout and SSR Failure Detection Current Value Write: WW	144
5-4	Heater Burnout and SSR Failure Detection Current Value Read: RW	145
5-5	Heater Current Value and SSR Leakage Current Value Read: RZ	146

5-1 HB Alarm and HS Alarm Point Write: WU

Function

This command is used to designate the control points that are to have HB and HS alarms so that the control points can detect heater burnout and SSR failures.



1. The control points designated by HB Alarm and HS Alarm Point Write (WU) will have both HB and HS alarms.
2. HB Alarm and HS Alarm Point Write (WU) cannot be used if a control point is being auto-tuned.



The HB or HS alarm of a control point will not work if the control point is being auto-tuned.

Setting Data Range

Default	00 (None of the control points have HB or HS alarm.)
Setting code	00 to FF

Command

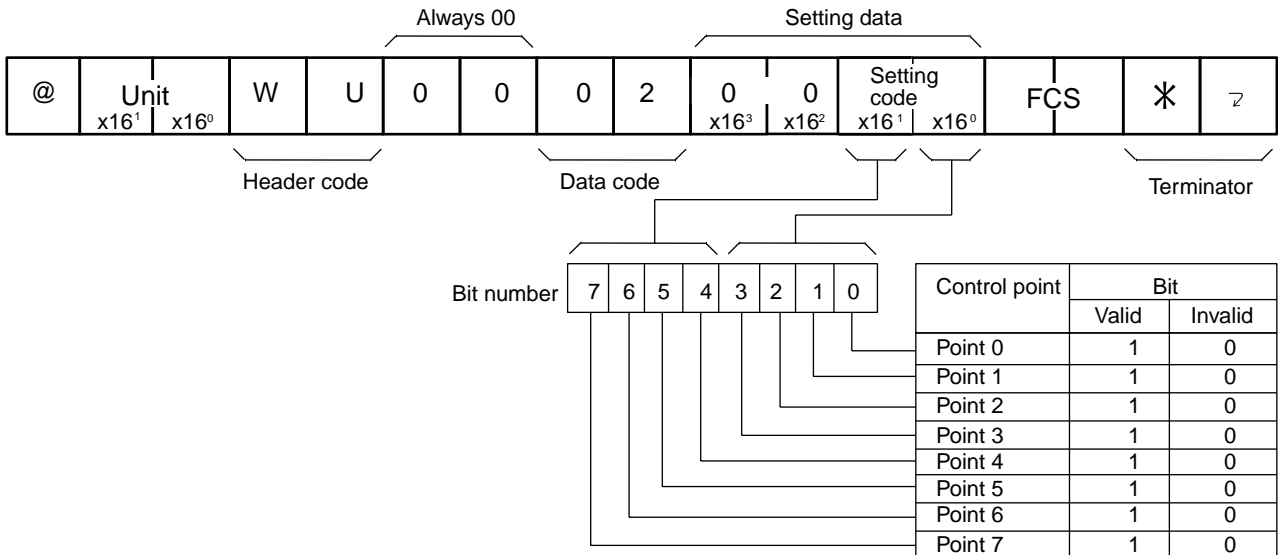

Response

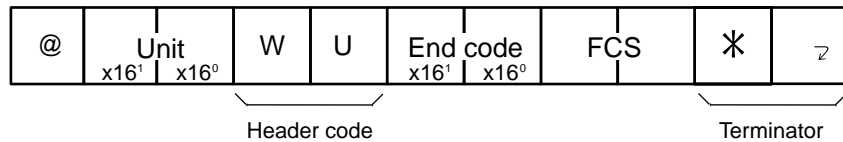

Communications Example

In this example, the E5ZE is operated with HB Alarm and HS Alarm Point Write (WU) under the following conditions.

Unit no.: 1

Control Points 0, 2, 4, and 6: Invalid

Control Points 1, 3, 5, and 7: Valid

Command

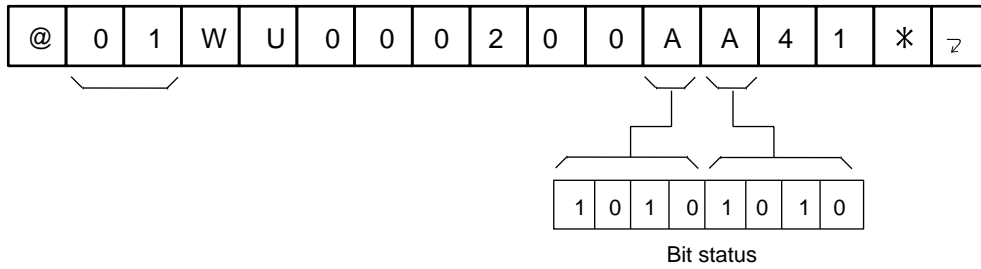

Response

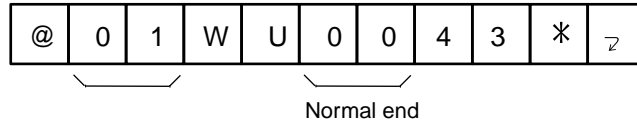

5-2 HB Alarm and HS Alarm Point Read: RU

Function

This command is used to read which control points have been set for HS and HB alarms.

Command

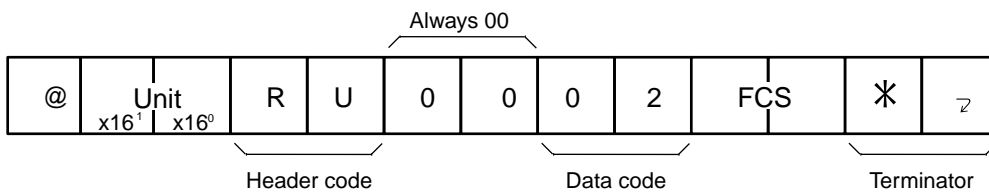

Response

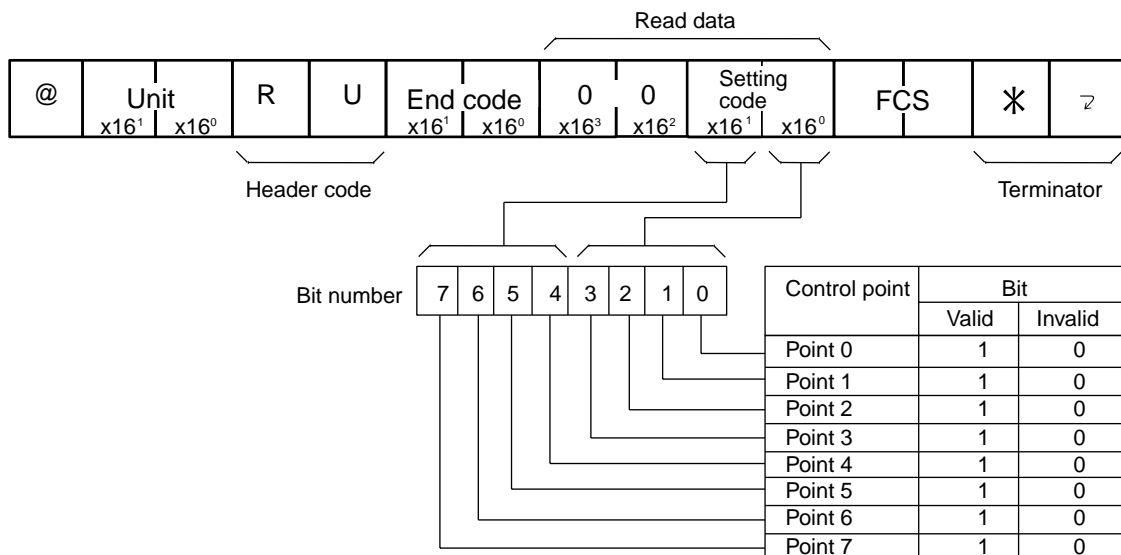

1. The response block for HB Alarm and HS Alarm Point Read (RU) does not include read data if the end code of the response block is other than 00.
2. Refer to 2-4 End Codes.

Communications Example

In this example, the E5ZE is operated with HB Alarm and HS Alarm Point Read (RU) under the following conditions.

Unit no.: 1

Control Points 0, 2, 4, and 6: Invalid

Control Points 1, 3, 5, and 7: Valid

Command

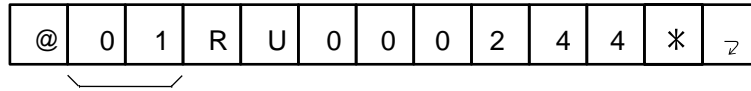

Response

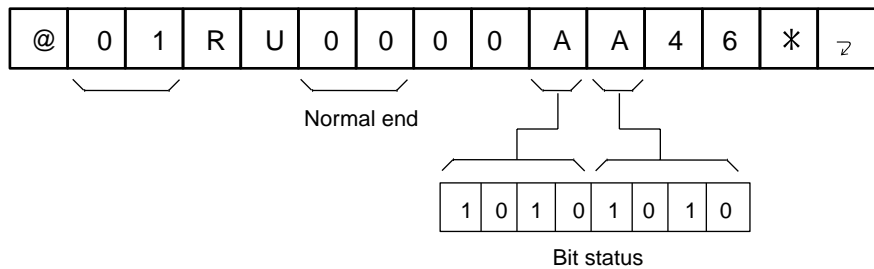

5-3 Heater Burnout and SSR Failure Detection Current Value Write: WW

Function

This command is used to set the current value at a control point to be used by the E5ZE to detect heater burnout or SSR failures at the control point.

Setting Data Range

Function	Heater burnout detection	SSR failure detection
Setting unit	0.1	
Current unit	A	
Default	0000	0005
Setting data	0000 to 0500	



Refer to the following to turn the HB alarm of a control point OFF or ON.

If the detection current value are set to 0000, the HB alarm will be always OFF.

If the detection current value are set to 0500, the HB alarm will be always ON.

Command

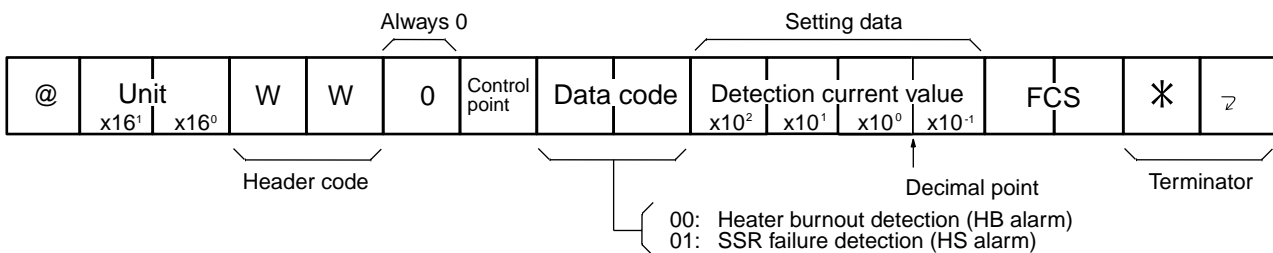

Response

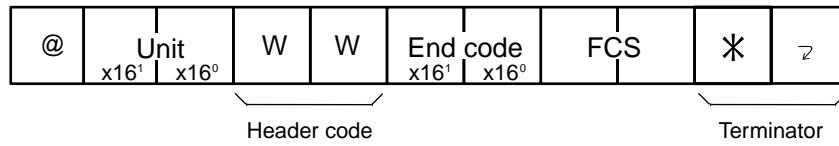

Communications Example

In this example, the E5ZE is operated with Heater Burnout and SSR Failure Detection Current Value Write (WW) under the following conditions.

Unit no.: 1

Control Point: 3

Heater Burnout Detection Current Value: 25.0 A

Command

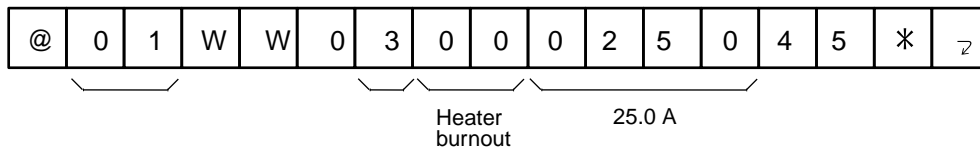

Response

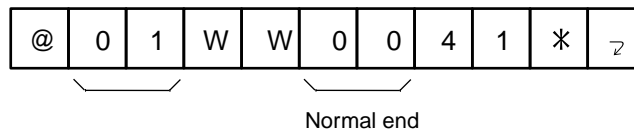

5-4 Heater Burnout and SSR Failure Detection Current Value Read: RW

Function

This command is used to read the current value set at a control point to be used by the E5ZE to detect heater burnout or SSR failures.

Command

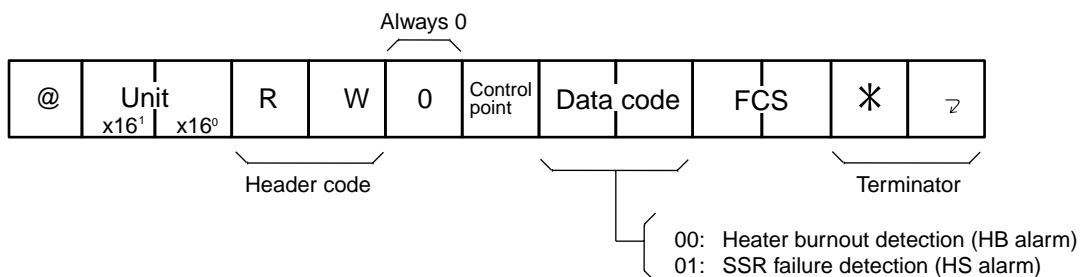

Response

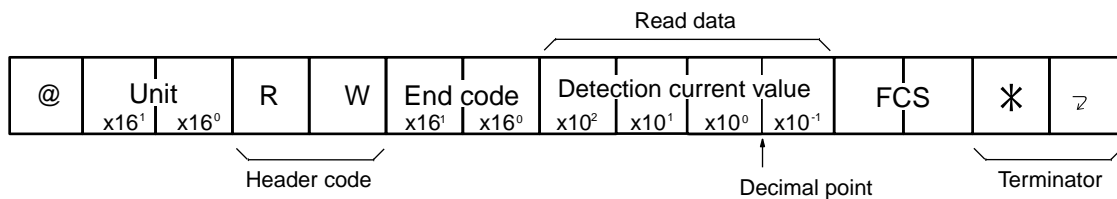

1. The response block for Heater Burnout and SSR Failure Detection Current Value Read (RW) does not include read data if the end code of the response block is other than 00.

2. Refer to 2-4 End Codes.

Communications Example

In this example, the E5ZE is operated with Heater Burnout and SSR Failure Detection Current Value Read (RW) under the following conditions.

Unit no.: 1
 Control Point: 3
 Heater Burnout Detection Current Value: 25.0 A

Command

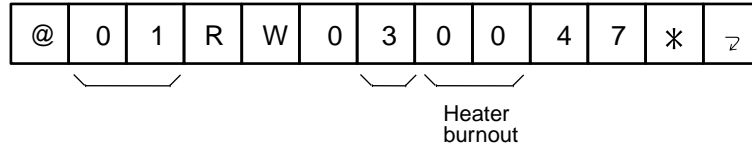

Response

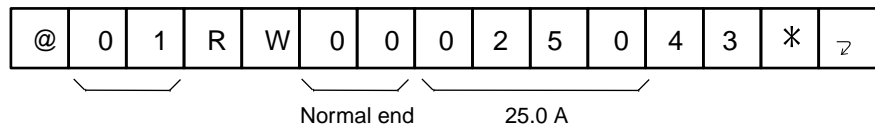

5-5 Heater Current Value and SSR Leakage Current Value Read: RZ

Function

This command is used so that the E5ZE can read the current value of the heater or the leakage current value of the SSR connected to a control point via the Current Transformer.



1. Heater Current Value: The current value of the heater measured at the control point with its control output turned ON.
2. SSR Leakage Current Value: The leakage current value of the SSR measured at the control point with its control output turned OFF.

Command

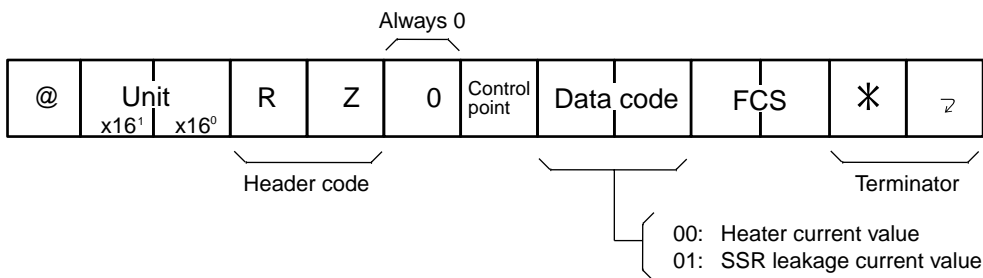

Response

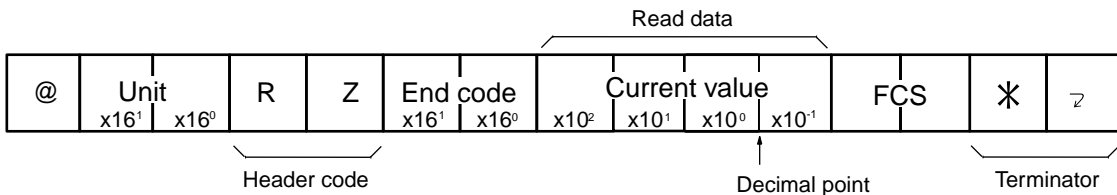

The current data of the response block for Heater Current Value and SSR Leakage Current Value Read (RZ) will be 0000 in the following cases.

The HB or HS alarm is not valid for the control point that has been designated.
 The operation of the control point that has been designated is stopped.

Response Block with Error Detected

The response block for Heater Current Value and SSR Leakage Current Value Read (RZ) will include an error code if an error is detected by the E5ZE while the E5ZE is processing the command.

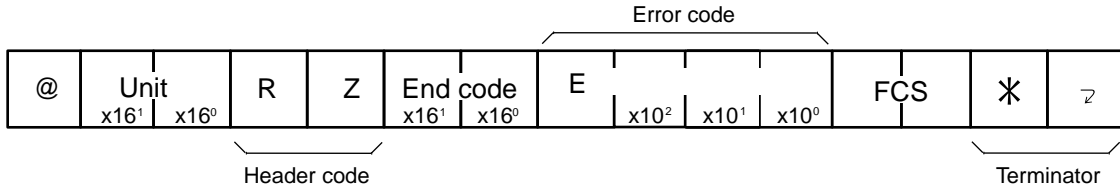

1. The response block for Heater Current Value and SSR Leakage Current Value Read (RZ) does not include read data or an error code if the end code of the response block is other than 00.
2. Refer to 2-4 End Codes and 2-5 Error Codes.

Communications Example

In this example, the E5ZE is operated with Heater Current Value and SSR Leakage Current Value Read (RZ) under the following conditions.
 Unit no.: 1
 Control Point: 3
 Heater Current Value: 25.6 A

Command

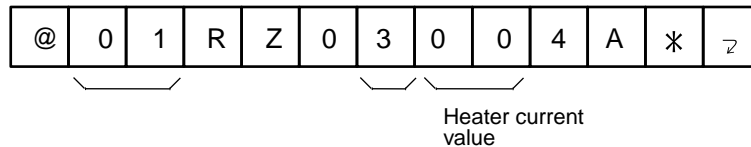

Response

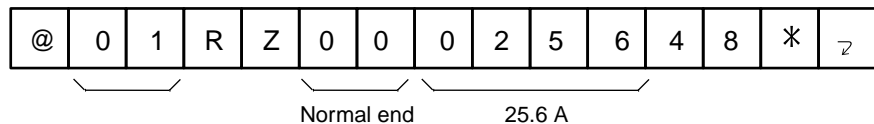

SECTION 6

Heating and Cooling Control Commands

This section describes the commands used for heating and cooling control.

6-1	Dead Band and Overlap Band Write: WD	150
6-2	Dead Band and Overlap Band Read: RD	151
6-3	Cooling Coefficient Write: WC	151
6-4	Cooling Coefficient Read: RC	152

6-1 Dead Band and Overlap Band Write: WD

Function

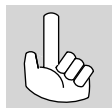

This command is used to write the dead band or overlap band of a control output in heating and cooling control operation.

- Refer to the following for the designation of the dead band or overlap band of a control output.
 - If positive parameters are set with Dead Band and Overlap Band Write (WD), the dead band of the control output will be designated.
 - If negative parameters are set with Dead Band and Overlap Band Write (WD), the overlap band of the control output will be designated.
- Dead Band and Overlap Band Write (WD) cannot be used at a control point being auto-tuned.

Setting Data Range

Setting unit	1	
°C or °F	°C	°F
Default	0000	
Setting data	-999 to 0999	

Command

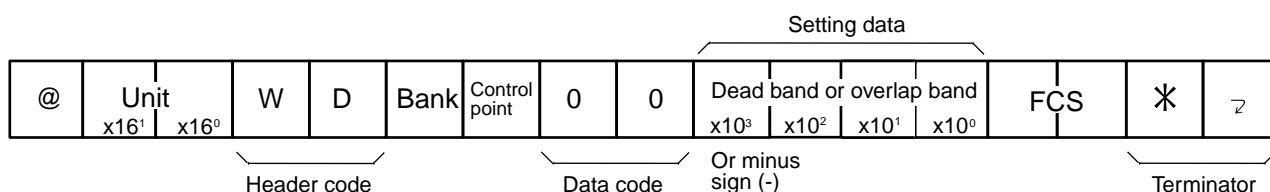

Response

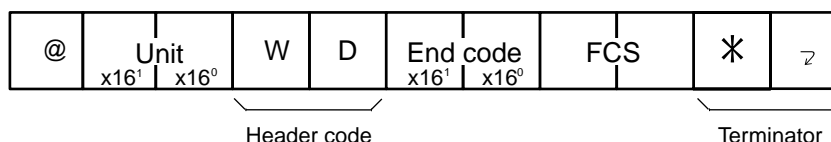

Communications Example

In this example, the E5ZE is operated with Dead Band and Overlap Band Write (WD) under the following conditions.

Unit no.: 1
 Memory Bank no.: 2
 Control Point: 3
 Overlap Band: 5°C

Command

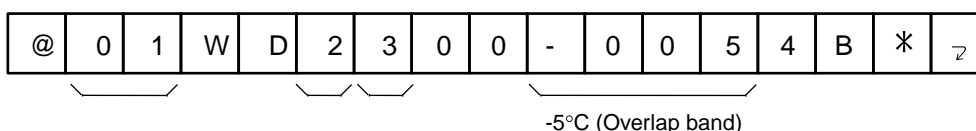

Response

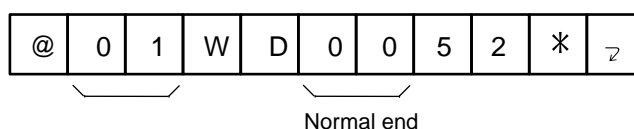

6-2 Dead Band and Overlap Band Read: RD

Function

This command is used to read the dead bands or overlap bands that have been set at a control point.

Command

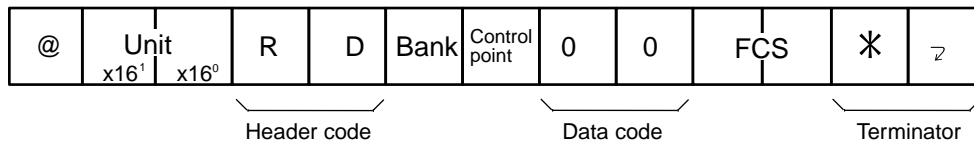

Response

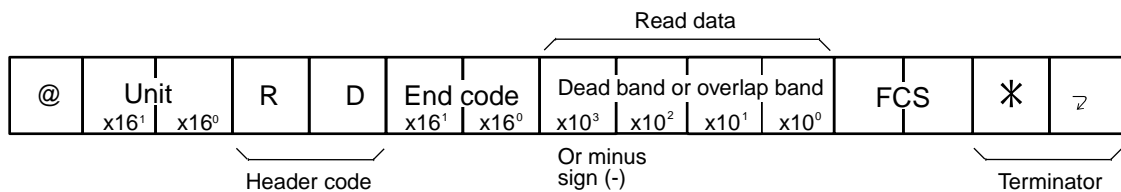

1. The response block for Dead Band and Overlap Band Read (RD) does not include read data if the end code of the response block is other than 00.
2. Refer to 2-4 End Codes.

Communications Example

In this example, the E5ZE is operated with Dead Band and Overlap Band Read (RD) under the following conditions.

Unit no.: 1
 Memory Bank no.: 2
 Control Point: 3
 Overlap Band: 5°C

Command

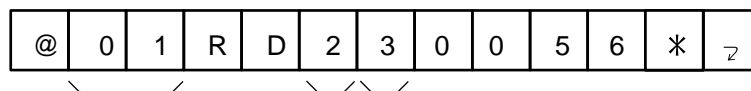

Response

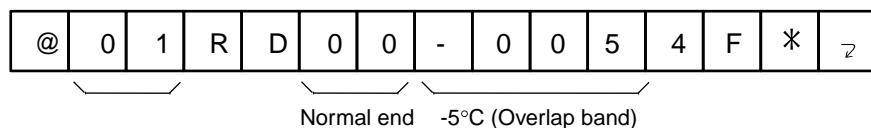

6-3 Cooling Coefficient Write: WC

Function

This command is used to write cooling coefficients that designate cooling-side proportional bands to a control point in heating and cooling control operation.



1. The cooling-side proportional band to be set a control point is calculated according to the cooling coefficient and proportional band. Refer to the following formula.
 Cooling-side proportional band = Cooling coefficient x Proportional band
2. Cooling Coefficient Write (WC) cannot be used at a control point being auto-tuned.

Setting Data Range

Setting unit	0.1
Default	0010
Setting data	0000 to 0100



If the cooling coefficient of a control point set to 0000 is used for temperature control with the E5ZE, the percentage of the cooling-side control output will be always 0.

Command

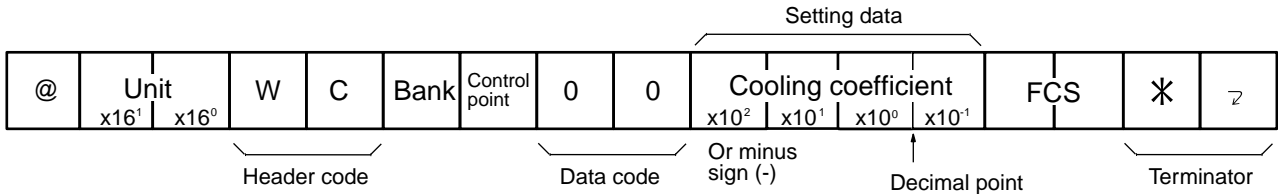

Response

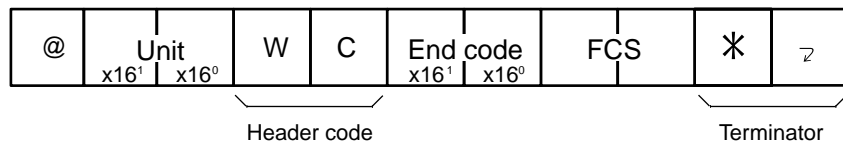

Communications Example

In this example, the E5ZE is operated with Cooling Coefficient Write (WC) under the following conditions.

- Unit no.: 1
- Memory Bank no.: 2
- Control Point: 3
- Cooling Coefficient: 1.5

Command

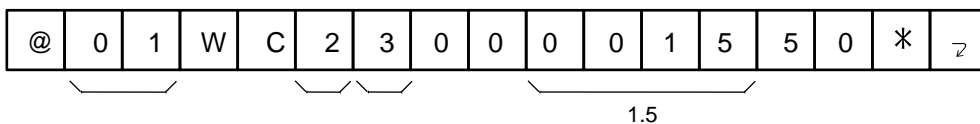

Response

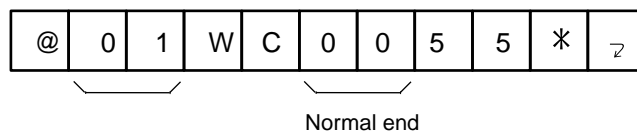

6-4 Cooling Coefficient Read: RC

Function

This command is used to read the cooling coefficients that have been set at a control point.

Command

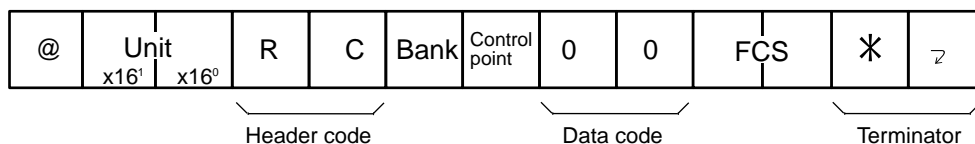

Response

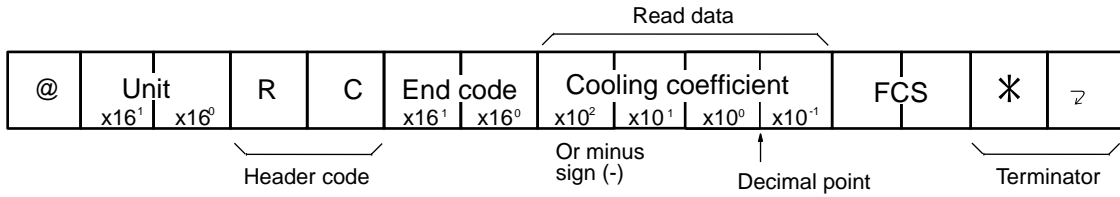

1. The response block for Cooling Coefficient Read (RC) does not include read data if the end code of the response block is other than 00.
2. Refer to 2-4 End Codes.

Communications Example

In this example, the E5ZE is operated with Cooling Coefficient Read (RC) under the following conditions.

Unit no.: 1
 Memory Bank no.: 2
 Control Point: 3
 Cooling Coefficient: 1.5

Command

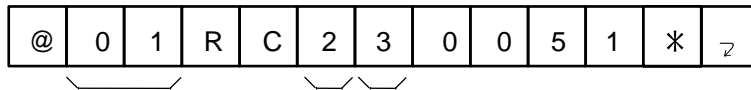

Response

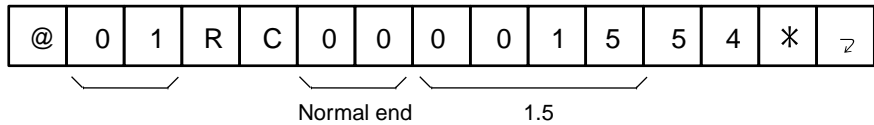

SECTION 7

Fuzzy Control Commands

This section describes the commands used for fuzzy control.

7-1	Fuzzy Strength Write: Wj.....	156
7-2	Fuzzy Strength Read: Rj.....	157
7-3	Fuzzy Scale 1 Write: Wk.....	157
7-4	Fuzzy Scale 1 Read: Rk.....	158
7-5	Fuzzy Scale 2 Write: Wl.....	159
7-6	Fuzzy Scale 2 Read: Rl.....	160

7-1 Fuzzy Strength Write: Wj

Function



This command is used to write fuzzy strength to a control point. Fuzzy Strength Write (Wj) cannot be used at a control point being auto-tuned.

Setting Data Range

Setting unit	1
Fuzzy strength unit	%
Default	0050
Setting data	0000 to 0099



If the fuzzy strength of a control point set to 0000 is used for temperature control with the E5ZE, the E5ZE will not be in fuzzy control operation.

Command

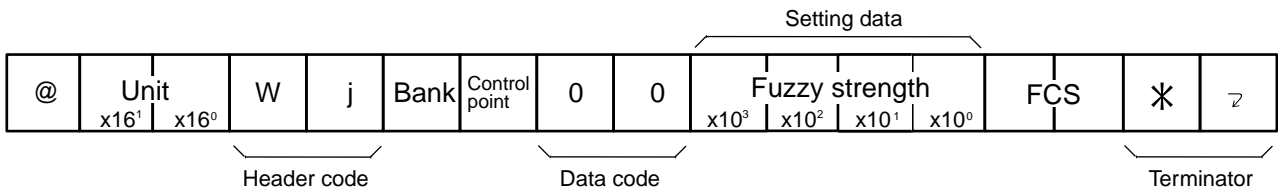

Response

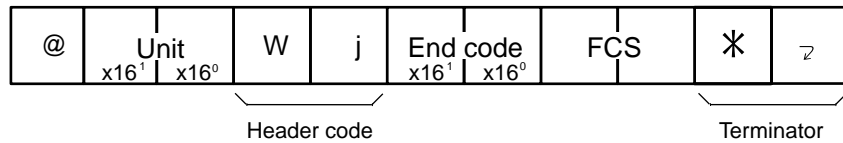

Communications Example

In this example, the E5ZE is operated with Fuzzy Strength Write (Wj) under the following conditions.

- Unit no.: 1
- Memory bank no.: 2
- Control point: 3
- Fuzzy strength: 45%

Command

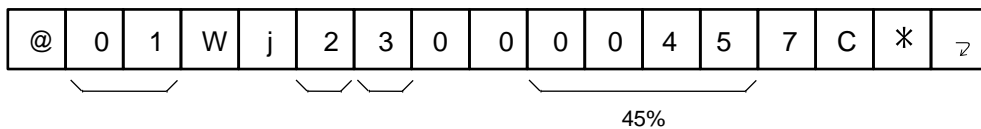

Response

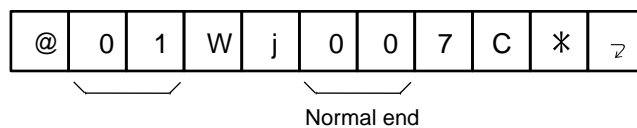

7-2 Fuzzy Strength Read: Rj

Function

This command is used to read the fuzzy strength that have been set at a control point.

Command

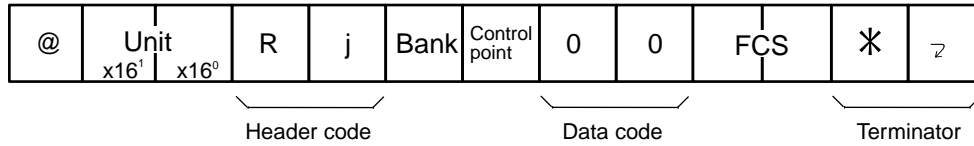

Response

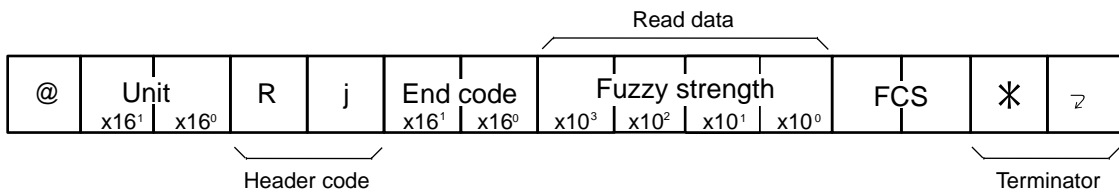

1. The response block for Fuzzy Strength Read (Rj) does not include read data if the end code of the response block is other than 00.
2. Refer to 2-4 End Codes.

Communications Example

In this example, the E5ZE is operated with Fuzzy Strength Read (Rj) under the following conditions.

Unit no.: 1
 Memory bank no.: 2
 Control point: 3
 Fuzzy strength: 45%

Command

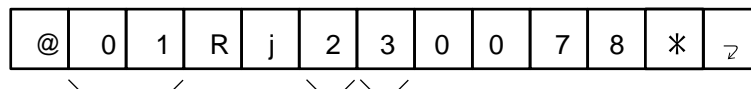

Response

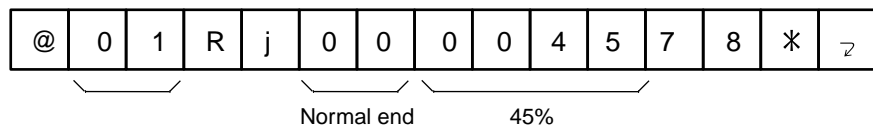

7-3 Fuzzy Scale 1 Write: Wk

Function

This command is used to write fuzzy scale 1 values to a control point for the E5ZE to determine external disturbance scales.



1. Fuzzy Scale 1 Write (Wk) cannot be used at a control point being auto-tuned.
2. Fuzzy scale 1 values for a control point being auto-tuned will be set automatically when the auto-tuning of the control point finishes.
3. The fuzzy scale 1 value of a control point will be automatically adjusted according to the PID constants. The fuzzy scale 1 value can be changed manually after PID constants are set for the bank.

Setting Data Range

Setting unit	0.1	
°C or °F	°C	°F
Default	9999	
Setting data	0002 to 9999	

Command

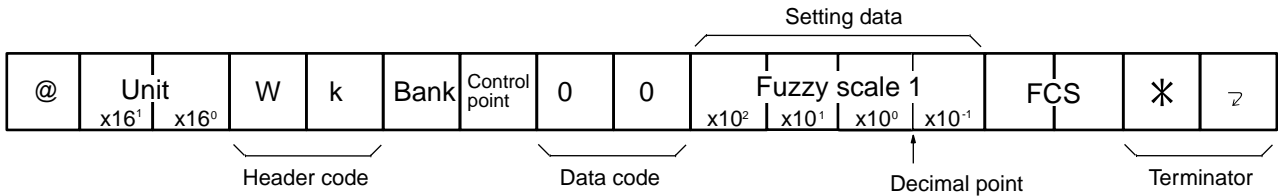

Response

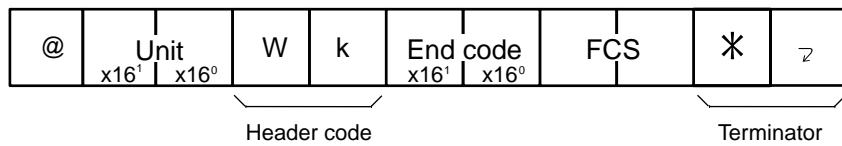

Communications Example

In this example, the E5ZE is operated with Fuzzy Scale 1 Write (Wk) under the following conditions.

- Unit no.: 1
- Memory bank no.: 2
- Control point: 3
- Fuzzy scale 1: 40.0°C

Command

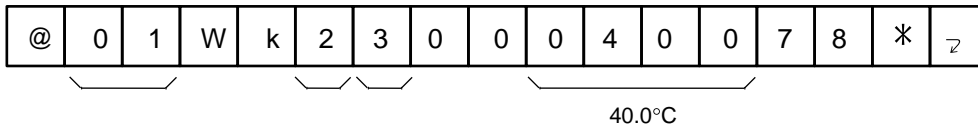

Response

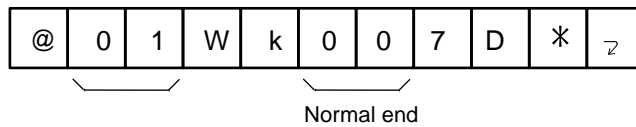

7-4 Fuzzy Scale 1 Read: Rk

Function

This command is used to read the fuzzy scale 1 values that have been set at a control point.

Command

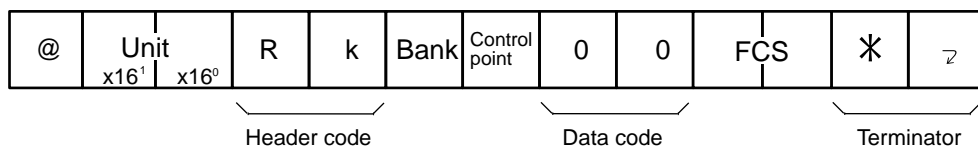

Response

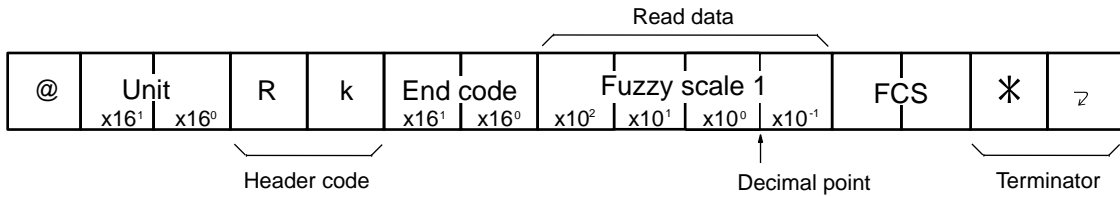

1. The response block for Fuzzy Scale 1 Read (Rk) does not include read data if the end code of the response block is other than 00.
2. Refer to 2-4 End Codes.

Communications Example

In this example, the E5ZE is operated with Fuzzy Scale 1 Read (Rk) under the following conditions.

Unit no.: 1
 Memory bank no.: 2
 Control point: 3
 Fuzzy scale 1: 40.0°C

Command

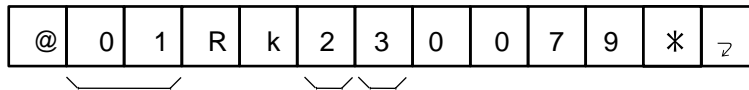

Response

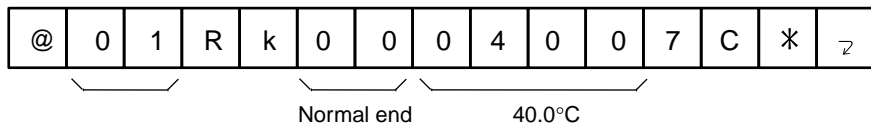

7-5 Fuzzy Scale 2 Write: Wl

Function

This command is used to write fuzzy scale 2 values to a control point for the E5ZE to determine the speeds of temperature changes due to external disturbance.



1. Fuzzy Scale 2 Write (Wl) cannot be used at a control point being auto-tuned.
2. Fuzzy scale 2 values for a control point being auto-tuned will be set automatically when the auto-tuning of the control point finishes.
3. The fuzzy scale 2 value of a control point will be automatically adjusted according to the PID constants. The fuzzy scale 2 value can be changed manually after PID constants are set for the bank.

Setting Data Range

Setting unit	0.01	
°C or °F	°C/s	°F/s
Default	9999	
Setting data	0020 to 9999	

Command

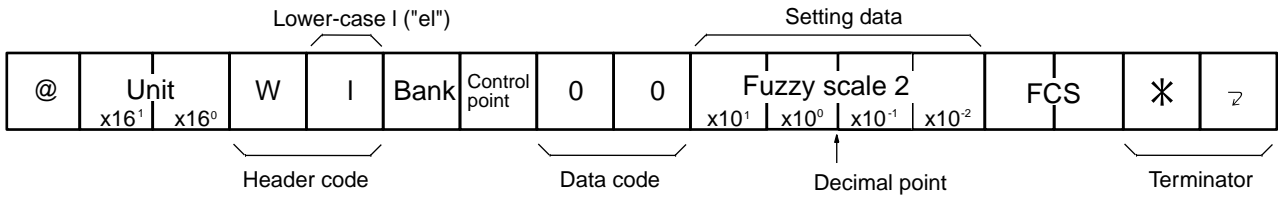

Response

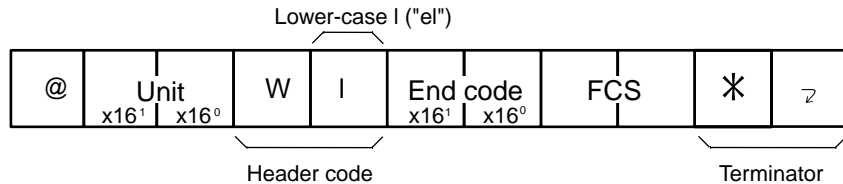

Communications Example

In this example, the E5ZE is operated with Fuzzy Scale 2 Write (WI) under the following conditions.

- Unit no.: 1
- Memory bank no.: 2
- Control point: 3
- Fuzzy scale 2: 3.00°C/s

Command

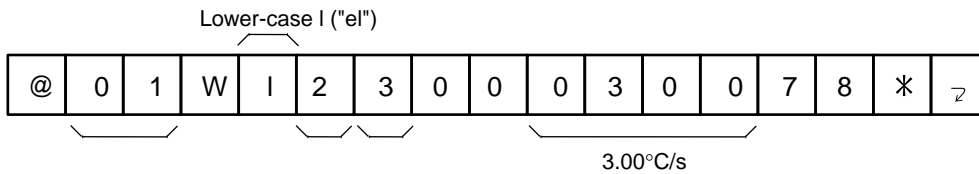

Response

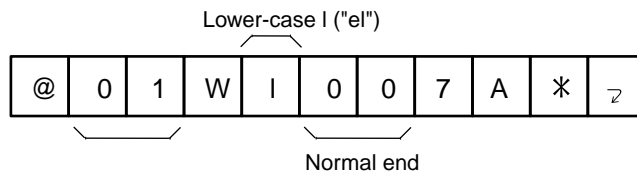

7-6 Fuzzy Scale 2 Read: Rl

Function

This command is used to read the fuzzy scale 2 values that have been set at a control point.

Command

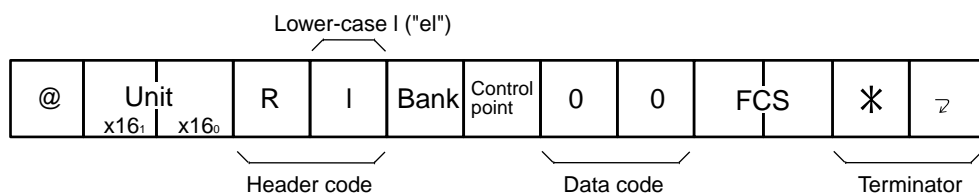

Response

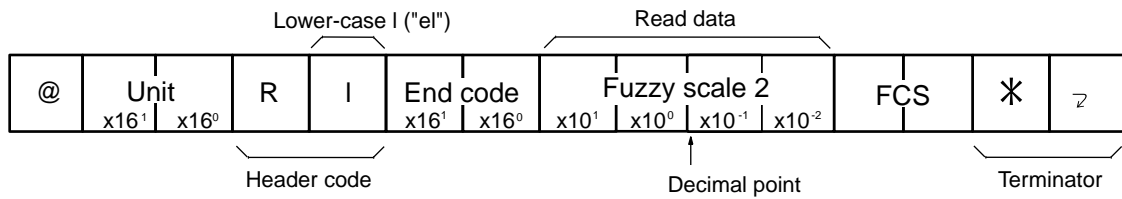

1. The response block for Fuzzy Scale 2 Read (RI) does not include read data if the end code of the response block is other than 00.
2. Refer to 2-4 End Codes.

Communications Example

In this example, the E5ZE is operated with Fuzzy Scale 2 Read (RI) under the following conditions.

Unit no.: 1
 Memory bank no.: 2
 Control point: 3
 Fuzzy scale 2: 3.00°C/s

Command

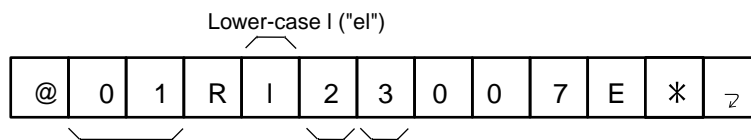

Response

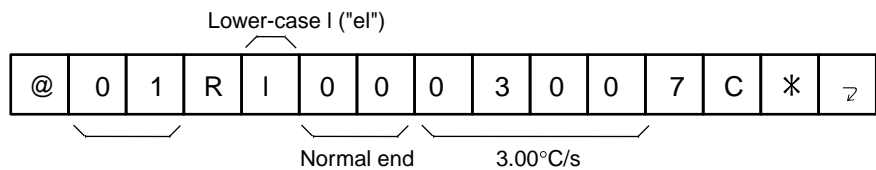

SECTION 8

Control Operation Start and Stop Commands

This section describes the commands used for starting and stopping operation.

8-1	Operation Start: OS	164
8-2	Operation Stop: OP	164
8-3	Manual Operation Start: OM	165

8-1 Operation Start: OS

Function

This command is used to designate a control point to start temperature control.



1. Operation Start (OS) cannot be used at a control point being auto-tuned.
2. Operation Start (OS) will be ignored by a control point in control operation.

Command

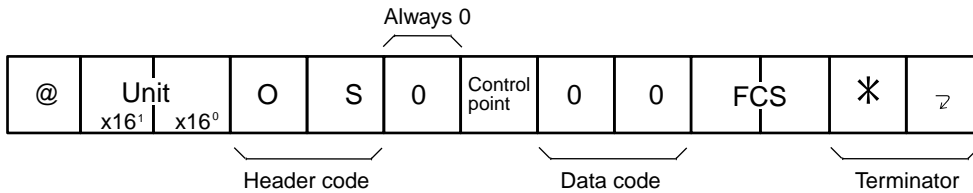

Response

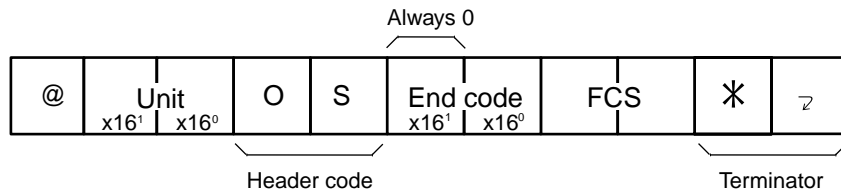

Communications Example

In this example, control point 3, the unit number of which has been set to 1, starts temperature control with Operation Start (OS).

Command

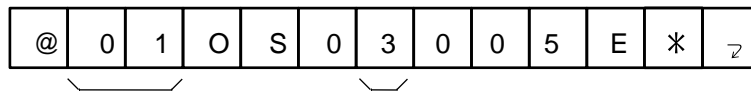

Response

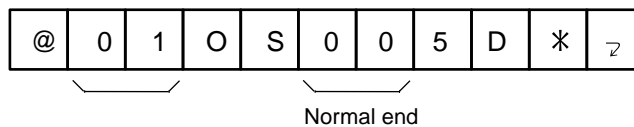

8-2 Operation Stop: OP

Function

This command is used to designate a control point to stop temperature control or manual operation.

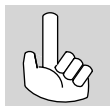

If a control point is stopped, all alarm output of the control point will be OFF.

Command

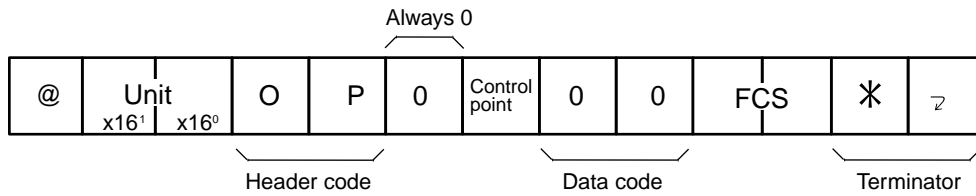

Response

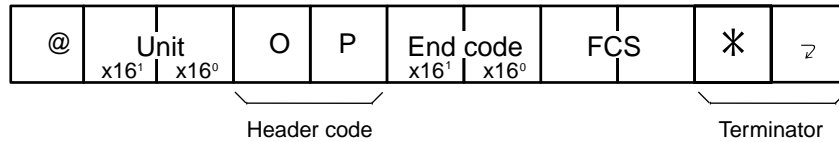

Communications Example

In this example, control point 3, the unit number of which has been set to 1, stops temperature control with Operation Stop (OP).

Command

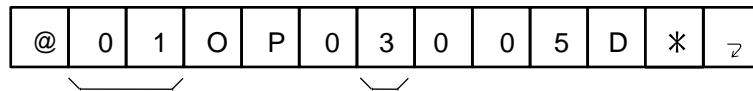

Response

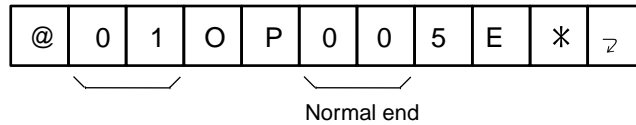

8-3 Manual Operation Start: OM

Function

This command is used to designate a control point to start manual operation with the output value that has been preset.



1. Manual Operation Start (OM) cannot be used at a control point being auto-tuned.
2. Manual Operation Start (OM) will be ignored by a control point in manual operation.

Command

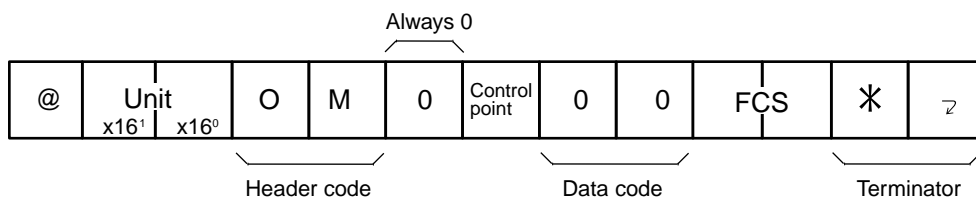

Response

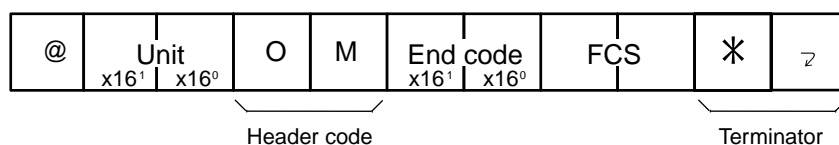

Communications Example

In this example, control point 3, the unit number of which has been set to 1, starts manual operation with Manual Operation Start (OM).

Command

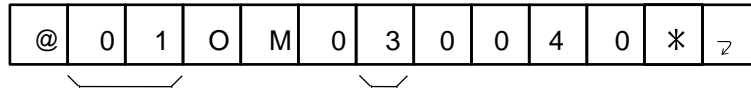

Response

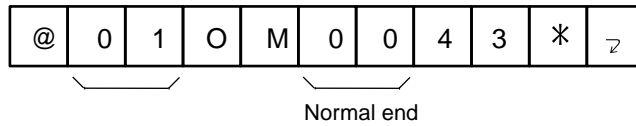

A

alarm mode 31
Alarm Mode Read R# 73, 104
Alarm Mode Write W# 73, 103
alarm status 11
Alarm Temperature Read R% 74, 107
Alarm Temperature Write W% 74, 106
AP 75, 121
AS 75
Auto-tuning Bit 114
Auto-tuning Start AS 75, 120
auto-tuning status 11
Auto-tuning Stop AP 75, 121

B

basic I/O slave device protocol 61
block format 69

C

C200HX/C200HE/C200HG PCs
 program example 47
cables
 connecting 6
character check 70
Cold Junction Compensation Error 117
command block 68
command format 18
commands 19
 according to application 119
 list 75
 control operation start and stop 163
 list 78
 fuzzy control
 list 77
 heater burnout and SSR failure detection 141
 list 76
 heating and cooling control 149
 list 77
 relationship between operating commands 28
 temperature control 87
 list 72
Communication Test TS 76, 138
communications
 errors 7, 33
 overview 3
 parameters 6
communications procedure 70

communications program examples 39
control data 20–21
Control Mode Bit 114
control output
 read, percentage 72
Control Period Read RT 73, 100
Control Period Write WT 73, 99
Cooling Coefficient Read RC 77, 152
Cooling Coefficient Write WC 77, 151
CPU Error 117
CS1 PCs
 program example 54
CVM1 and CV-series PCs
 program example 40

D

data
 reading 10
 sharing 78
Dead Band and Overlap Band Read RD 77, 151
Dead Band and Overlap Band Write WD 77, 150
delay time 15
Derivative Time Read RV 73, 98
Derivative Time Write WV 73, 97
DeviceNet 4
DeviceNet. See also explicit message communications

E

end codes
 checking 34
 list 82
 priority 84
error
 cold junction compensation 117
 CPU 117
 current transformer input AD 117
 detection 70
 memory 116
 processing 70
 sensor input AD 116
 setting data 117
error codes 34–35
 list 35
 meaning and processing 35
 undefined 85
error indicators 37
Error Read RU 74, 115

explicit message communications 4, 17
 command format 18
 commands 19
 sending 18, 21
 updating data 19

F

FCS 69–70
 calculations 69
flags 12
format check 70
Frame Check Sequence. See also FCS
framing check 70
Fuzzy Scale 1 Read Rk 77, 158
Fuzzy Scale 1 Write Wk 77, 157
Fuzzy Scale 2 Read Rl 77, 160
Fuzzy Scale 2 Write Wl 77, 159
Fuzzy Strength Read Rj 77, 157
Fuzzy Strength Write Wj 77, 156

H

HB Alarm and HS Alarm Point Read RU 76, 143
HB Alarm and HS Alarm Point Write WU 76, 142
header code 69
Heater Burnout and SSR Failure Detection Current Value Read RW 76, 145
Heater Burnout and SSR Failure Detection Current Value Write WW 76, 144
Heater Current Overflow Bit 114
Heater Current Value and SSR Leakage Current Value Read RZ 76, 146
Hysteresis Read RH 74, 111
Hysteresis Write WH 74, 110

I

indicators 37
Initialize Setting Data MC 76, 137
Input Shift Read RI 75, 125
Input Shift Write WI 75, 124
installation 5
instructions
 CMND(194/490) 20
 execution precautions 20
Integral Time Read RN 72, 96
Integral Time Write WN 72, 95

L-M

ladder program example 42
manipulated variable, read, percentage 92
manual operation 14
Manual Operation Start OM 78, 165
Manual Output Value Write WO 75, 131
Manual Reset Value Read RK 75, 127
Manual Reset Value Write WK 75, 126
MC 76, 137
Measured Temperature Read RX 72, 90
measurement values 21, 30
Memory Bank Designation Read RM 74, 109
Memory Bank Designation Write WM 74, 108
Memory Error 116
Memory Write Bit 114
Memory Write WE 76, 136
multi-vendor applications 61

N-O

numeric value check 70
objects 61
OM 78, 165
OP 78, 164
operating commands 28
operating status 12
Operation Start OS 78, 164
Operation Stop OP 78, 164
operation variables 27
OS 78, 164
Output Operation (Normal/Reverse) Read RU 73, 102
Output Operation (Normal/Reverse) Write WU 73, 101
Output Operation Bit 114
Output Value Read RO 72, 92
Output Variable Change Rate Limit Value Read RG 76, 136
Output Variable Change Rate Limit Value Write WG 76, 134
Output Variable Limit Value Read RL 76, 133
Output Variable Limit Value Write WL 76, 132
overrun check 70

P

Present Set Point Read Rs 75, 129
Process Value Overflow Bit 114

Process Value Read RX 72
Process Value Underflow Bit 114
process values
 reading 10
Proportional Band Read RB 72, 94
Proportional Band Write WB 72, 93

R

R# 73, 104
R% 74, 107
Ramp Value Read RR 75, 128
Ramp Value Write WR 75, 127
RB 72, 94
RC 77, 152
RD 77, 151
reading data 80
reading PC memory 19
reception buffer 68
remote I/O 4, 9
 delay time 15
 updating data 19
response block 68
RG 76, 136
RH 74, 111
RI 75, 125
Rj 77, 157
RK 75, 127
Rk 77, 158
RL 76, 133
RI 77, 160
RM 74, 109
RN 72, 96
RO 72, 92
RR 75, 128
RS 72, 89
Rs 75, 129
RT 73, 100
Rt 75, 123
RU 73–74, 76, 102, 115, 143
RUN Status Bit 114
RV 73, 98
RW 76, 145
RX 72, 74, 90, 112
RZ 76, 146

S

Sensor Input AD Error 116
Sensor Input Error Bit 114
Set Point Read RS 72, 89
Set Point Write WS 72, 88
set points 14
set values
 changing 28
 common 21
 monitoring 28
 setting 21, 31–32
Setting Data Error 117
Setting Unit Read Rt 75, 123
Setting Unit Write Wt 75, 121
setting unit, temperature
 read 75, 123
 write 75, 121
start character 69
startup 13
status
 reading 11
Status Read RX 74, 112

T

temperature control 13
terminator 69
text 69
TS 76, 138

U-W

unit number 69
vertical parity check 70
W# 73, 103
W% 74, 106
WB 72, 93
WC 77, 151
WD 77, 150
WE 76, 136
WG 76, 134
WH 74, 110
WI 75, 124
Wj 77, 156
WK 75, 126
Wk 77, 157

Index

WL 76, 132
WI 77, 159
WM 74, 108
WN 72, 95
WO 75, 131
word allocations 10
WR 75, 127
writing data 78
writing PC memory 19
WS 72, 88
WT 73, 99
Wt 75, 121
WU 73, 76, 101, 142
WV 73, 97
WW 76, 144

Revision History

A manual revision code appears as a suffix to the catalog number on the front cover of the manual.

Cat. No. H114-E1-01



The following table outlines the changes made to the manual during each revision. Page numbers refer to the previous version.

Revision code	Date	Revised content
1	December 2000	Original production