

Buffer Block S8T-DCBU-02

Prevents Equipment Stoppage, Data Loss, and Other Problems Resulting from Momentary Power Failures

- Provides a backup time of 500 ms at an output current of 2.5 A.
- Can be wired to the 24-V output from the S8VS, S82J, S82K, and S8PS Power Supplies.
- Connects to an S8TS Power Supply via an S8T-BUS03 Bus Line Connector.
- Parallel connections to up to four Blocks can be used to increase the backup time and current capacities.
- Complies with SEMI F47-0200 standard.

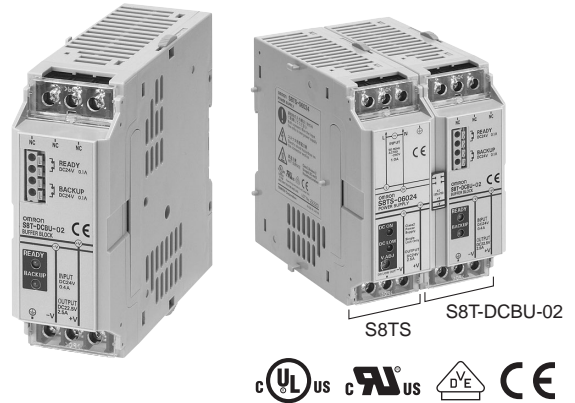

Ordering Information

■ Buffer Block

Input voltage	Output voltage (during backup operation)	Output current	Model number
24 VDC (24 to 28 VDC)	22.5 V	2.5 A	S8T-DCBU-02

■ Options (Order Separately)

Bus Line Connector (Connects to Buffer Block)

Type	Number of Connectors	Model number
DC bus line	1 Connector	S8T-BUS03
	10 Connectors (See note.)	S8T-BUS13

Note: One package contains 10 S8T-BUS03 Connectors.

Basic Configuration

Connection using Bus Line Connector

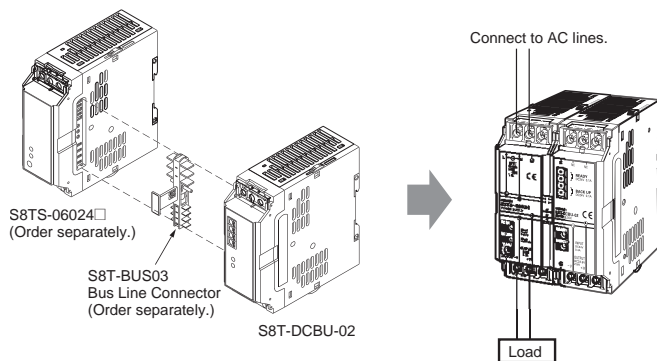

Connection via Wiring

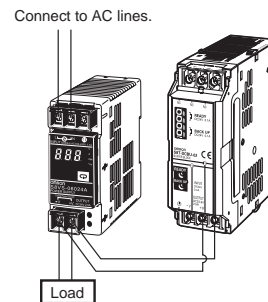

Specifications

■ Ratings/Characteristics

Item	Model	S8T-DCBU-02		
Input	Voltage	24 to 28 VDC		
	Current	Charging	0.4 A	
		Standby	0.18 A	
Output (See note 1.)	Backup operation	Output voltage	For 24 V: 22.5 V typ., 22.0 V min. For 28 V: 26.4 V typ., 25.8 V min.	
		Output current	2.5 A	
	Backup time (See note 2.)	Time required until the voltage drops from the fully charged level down to 21.6 VDC 1,000 ms min. (for an output current of 1.2 A) 500 ms min. (for an output current of 2.5 A)		
	Additional functions (See note 3.)	READY indicator	Yes (color: green)	
	READY output	Yes (relay: 24 VDC, 0.1 A max.)		
	Backup indicator	Yes (color: red)		
	Backup output	Yes (relay: 24 VDC, 0.1 A max.)		
	Overcurrent protection	Reverse-L drooping, automatic recovery, overcurrent detection point: 5.8 to 6.8 A		
	Overvoltage protection	Yes		
	Parallel operation	Possible (4 Blocks max.)		
	Series operation	Not possible		
Other	Ambient operating temperature	Refer to the derating curve in <i>Engineering Data</i> . (with no condensation or icing)		
	Storage temperature	-25 to 65°C		
	Ambient humidity	Operating: 25% to 85%; Storage: 25% to 90%		
	Dielectric strength (See note 4.)	1.0 kVAC for 1 minute (between all DC connection terminals and GR terminals; Detection current: 20 mA) 500 VAC for 1 minute (between all DC connection terminals/GR terminals and all signal output terminals; detection current: 20 mA)		
	Insulation resistance	100 MΩ min. (between all DC connection terminals and GR terminals) at 500 VDC		
	Vibration resistance (See notes 5 and 6.)	10 to 55 Hz, 0.375-mm single amplitude for 2 h each in X, Y, and Z directions		
	Shock resistance (See notes 5 and 6.)	150 m/s ² , 3 times each in ±X, ±Y, and ±Z directions		
	EMI	Radiated Emissions	Based on EN55011 Class B.	
	EMS		Conforms to EN61000-6-2	
	Approved standards		UL: UL508 (Listing, Class 2: Per UL1310) (See note 7.), UL60950, UL1604 (Class I/Division 2) cUL: CSA C22.2 No.14, No.60950, No.213 (Class I/Division 2) EN/VDE: EN50178 (=VDE0160), EN60950 (VDE0806)	
	SEMI standard		SEMI F47-0200	
	Weight		450 g max.	

- Note:**
- The output characteristics are specified at the power output terminals.
 - Refer to *Backup Time* on page 10 for details.
 - Refer to *Functions* on page 7 for details.
 - If the number of S8T-DCBU-02 Buffer Blocks to be connected is "N," set the detection current to 20 mA × N.
 - Specified by S8TS-06024□ connection.
 - Be sure to mount an End Plate (PFP-M: Order separately) on each end of the Buffer Block. Refer to *DIN Tracks* on page 14.
 - To comply with UL508 (Class 2: Per UL1310), connect one S8TS-06024□ to one S8T-DCBU-02 Buffer Block.

■ Reference Value

Item	Value	Definition
Reliability (MTBF)	135,000 hrs min.	MTBF stands for Mean Time Between Failures, which is calculated according to the probability of accidental device failures, and indicates reliability of devices. Therefore, it does not necessarily represent a life of the product.
Life expectancy	10 yrs. min.	The life expectancy indicates average operating hours under the ambient temperature of 40°C and a load rate of 50%. Normally this is determined by the life expectancy of the built-in aluminum electrolytic capacitor.

Connections

■ Block Diagram

S8T-DCBU-02

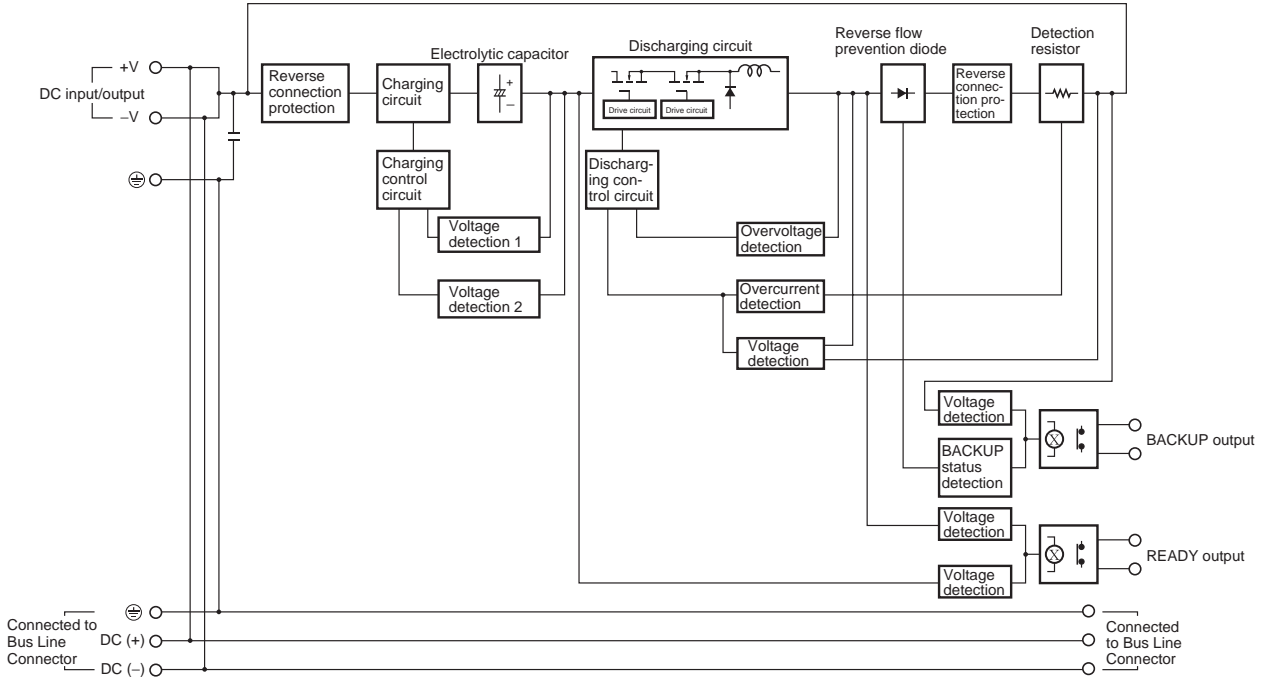

Operation

■ Application

Connectable Power Supplies

The following Power Supplies (SELV Power Supplies) can be connected. When connected to the following Power Supplies, the Buffer Block will function properly against a momentary power failure of at least 300 ms. (See note 1.)

S8TS Series: S8TS-06024□

S8VS Series: S8VS-06024□, S8VS-09024□□, S8VS-12024□□, S8VS-18024□□, and S8VS-24024□□

S82K Series: S82K-03024, S82K-05024, S82K-□09024, S82K-□10024, and S82K-□24024□

S82J Series: S82J-02524□□, S82J-05024□□, S82J-10024□□ (See note 2.), S82J-15024□□, S82J-30024□, and S82J-60024□

S8PS Series: S8PS-05024□□ (See note 2.), S8PS-10024□□ (See note 2.), S8PS-15024□□, and S8PS-30024□□

Note: 1. The backup current must be less than 5 A (parallel operation connection is required if the backup current exceeds 2.5 A) and the Buffer Block must be fully charged. If three or more S8T-DCBU-02 Buffer Block are used in parallel operation and the backup current exceeds 5 A, the momentary power failure time that can be compensated for will be reduced.

- When connected to the S82J-10024□□, S8PS-05024□□, or S8PS-10024□□ Power Supply, the output voltage may increase by approximately 4 V for approximately 10 to 50 ms after recovery from the momentary power failure. If any adverse effect is foreseen, connect a diode as shown below based on the guidelines given below.

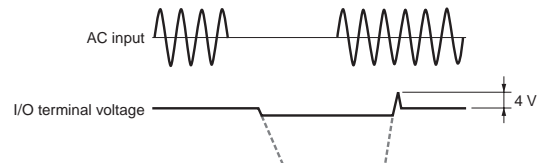

Guidelines for Selecting Diode

Type: Schottky barrier diode

Withstanding voltage (V_{RRM}): At least twice the rated output voltage

Forward current (I_F): At least twice the rated output current

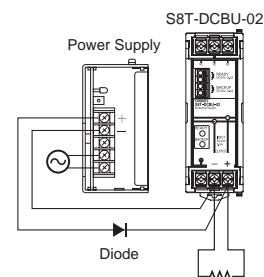

Power Supply To Be Connected

The power consumption of the S8T-DCBU-02 is approximately 10 W, so make sure that the output capacity of the power supply is sufficient.

If the S8T-DCBU-02 is connected to a previously installed power supply, the voltage may drop due to the power supply's overcurrent protection, or backup operations may not be possible.

Note: Connect a power supply within the specified derating range, considering the power consumption of the S8T-DCBU-02.

Selecting the Power Supply

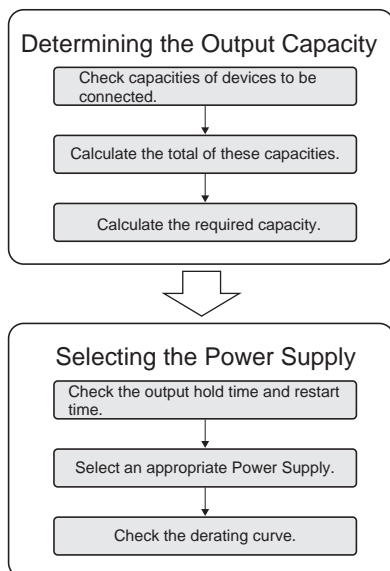

Determining the Output Capacity

1. Checking Capacities of Devices To Be Connected

Check the capacities (W) of the devices to be connected.

2. Calculating the Total Capacity (Including That of the S8T-DCBU-02 Buffer Block)

The S8T-DCBU-02 Buffer Block will consume the following power. Add this to the above capacities (W) to obtain the total capacity.

Vin = 24 V: 9.6 W max. (during charging)
 Vin = 28 V: 11.2 W max. (during charging)

Calculation of the Total Capacity

$$\text{Total capacity (W)} = \text{Capacities of devices (W)} + \text{Power consumption (W) of the S8T-DCBU-02}$$

3. Calculating the Required Output Capacity

Determine the rate of allowance and apply this allowance rate to the total capacity calculated above to obtain the output capacity required by the Power Supply. Be sure to provide a sufficient allowance rate.

Calculation of the Total Power Supply Capacity

$$\text{Required output capacity (W) of the Power Supply} > \text{Total capacity (W)} \div \text{Allowance factor}$$

Example: Output voltage: 24 V
 Capacities of devices: 36 W (output current: 1.5 A)
 Allowance factor: 0.8
 Required output capacity of the Power Supply > (36 W + 9.6 W) ÷ 0.8 = 57 W
 Therefore, an S8TS-06024□ Power Supply, S8VS-06024□ Power Supply, or a Power Supply with a larger capacity is required.

Selecting the Power Supply

1. Checking the Output Hold Time and Restart Time of the Power Supply

The relation between the momentary power failure time and the backup time required to compensate the failure is shown in the following illustration. As shown by the illustration, the backup time required from the S8T-DCBU-02 Buffer Block depends on the connected Power Supply even for the same momentary power failure time.

Calculation of the Required Backup Time

$$\text{Required backup time} > \text{Momentary power failure time} + \text{Restart time of Power Supply} - \text{Output hold time of Power Supply}$$

Relation between Momentary Power Failure and Backup Time

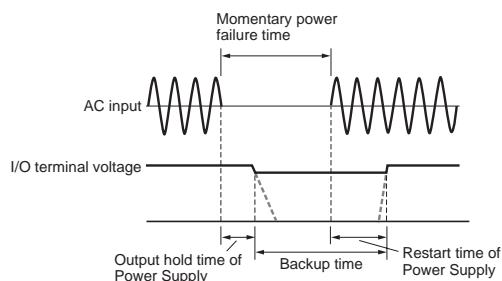

The output hold time and restart time of each Power Supply are shown in *Power Supply Output Hold Times (Reference Values)* on page 12 and *Power Supply Restart Times (Reference Values)* on page 13.

Example: S8T-DCBU-02: 1 Unit
 Connected power supply: S8TS-06024□ Power Supply
 Load current: 1 A
 AC current input voltage: 200 VAC
 Momentary power failure time: 300 ms
 Required backup time > 300 ms + 270 ms - 100 ms = 470 ms
 Refer to the graphs under *Backup Time* on page 10 to check whether the backup time is sufficient.

2. Selecting the Power Supply

After obtaining the output capacity required for the Power Supply and checking its output hold time and restart time as described above, select an appropriate Power Supply from the list under *Connectable Power Supplies* on page 3.

3. Checking the Derating Curve

Confirm that the total output capacity calculated in step 2, *Calculating the Total Capacity*, under *Determining the Output Capacity* is within the derating curve of the Power Supply. If the capacity exceeds the derating curve, increase the Power Supply capacity or use forced air cooling to reduce the ambient operating temperature.

Mounting

Mounting Direction

Standard mounting	Yes
Back-down mounting	No
Other mounting	No

Use standard mounting only. Improper mounting will interfere with heat dissipation and may occasionally result in deterioration of or damage to internal parts.

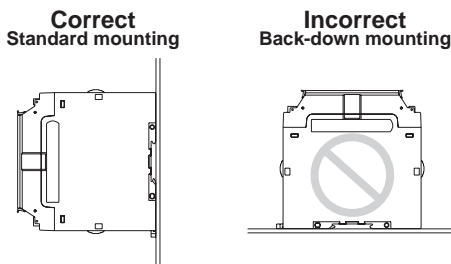

Connecting to the S8TS-06024□

When connecting one or more S8T-DCBU-02 Blocks to the S8TS-06024□ using Bus Line Connectors, connect them to either the left or right end of the Blocks. Heat dissipation will be interfered with if the S8T-DCBU-02 Blocks are not connected to the end.

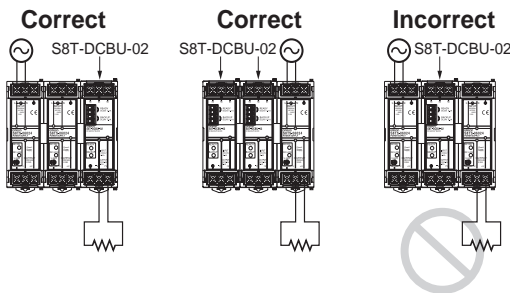

Wiring Connections

A load can be connected to either the power supply side or the S8T-DCBU-02 side.

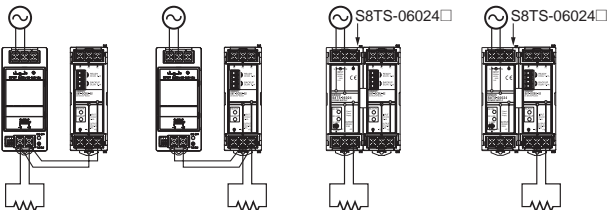

Note: Use the largest wire size possible and keep the wiring distance as short as possible. If the voltage drop caused by the wiring material is too large, the backup operation may not be sufficient.

Input Voltage

Input voltage range: 24 to 28 VDC

Confirm that an input voltage of at least 24 V is being supplied to the S8T-DCBU-02 input terminals.

Output Voltage

The output voltage for the backup operation is automatically adjusted internally by detecting the input voltage. The backup operation is started when the input voltage drops 2 V.

Note: The output voltage during the backup operation is a maximum of 2 V lower than the voltage input at an input voltage of 24 V.

Serial Connection

Two Blocks cannot be connected in series to increase the output voltage to 48 V or to create positive and negative outputs.

Parallel Operation Connection

The output current and backup time for the backup operation can be increased by connecting Blocks in parallel.

Standard number of Blocks for parallel operation: 2
Maximum number of Blocks for parallel operation: 4

The backup time will be greatly reduced if three or more Blocks are connected in parallel and the output current for the backup operation exceeds 5 A. Refer to *Backup Time* on page 10 for details on the backup time during parallel operation.

Note: Although the number of Blocks that can be connected when using the S8TS-06024□ is five when calculated from the current capacity of the Bus Line Connector, only a maximum of four S8T-DCBU-02 can actually be connected in parallel.

Using the Bus Line Connector

When connecting to the S8TS-06024□, always use the S8T-BUS03 Bus Line Connector. This Connector connects only the DC lines. It does not connect AC lines.

S8T-BUS03 Bus Line Connector

The S8T-BUS03 Bus Line Connector is equipped with a selector to prevent incorrect connection to a power supply unit with a different output voltage specification. Slide the selector to the 24 V position.

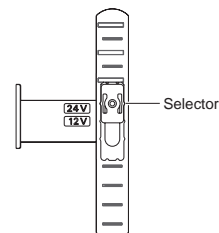

Inserting and Removing the Bus Line Connector

Pay attention to the following points to maintain electric characteristics.

- Do not insert and remove a Connector more than 20 times.
- Do not touch the Connector terminals.
- To remove a Connector, insert a flat-blade screwdriver alternately at both ends.

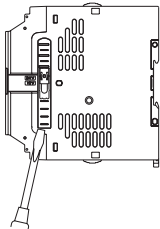

Mounting to DIN Track

To mount the Block to DIN Track, hook portion (A) of the Block onto the Track and press the Block in direction (B).

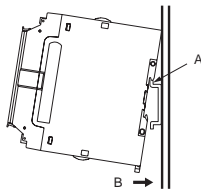

To dismount the Block, pull down portion (C) with a flat-blade screwdriver and pull out the Block.

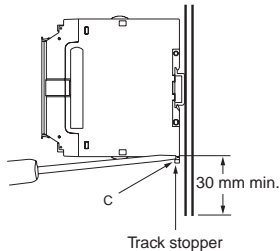

Checking Operation

After connecting the Blocks, check the Buffer Block using the following procedure to confirm that it operates correctly for momentary power failures on the AC input. Use this procedure for maintenance as well.

1. Turn ON the AC power supply that has been connected.
2. Check the READY indicator on the S8T-DCBU-02 to confirm that it is lit.

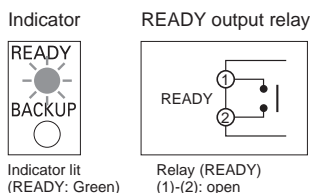

Note: Up to 60 seconds is required to charge the internal capacitor before the indicator lights.

3. Use a timer and create a momentary power failure on the AC input of the expected length of time. Considering variations in characteristics, using 140% or more of the power failure time is recommended.

Operation Check and Periodic Inspection

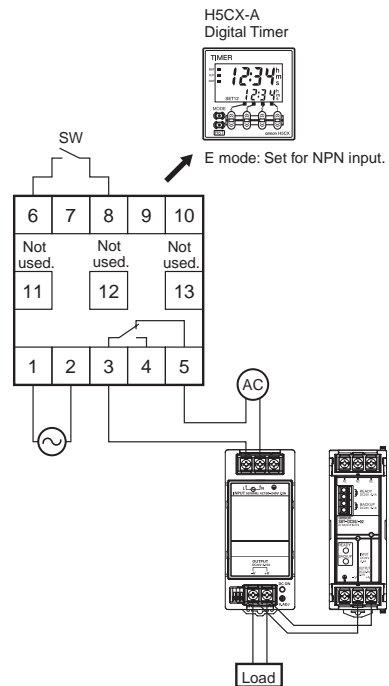

4. Check to confirm that the expected backup operation was performed. The operation of the BACKUP indicator and BACKUP output should be as shown below during the backup operation. Check these as well.

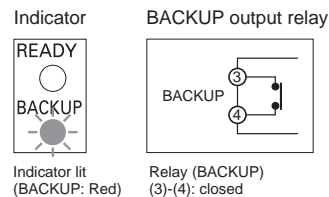

Note: Check the backup operation under conditions that are safe and will cause no problems if the backup operation fails.

■ Functions

READY Operation

The READY indicator and READY output will function as shown below after the internal capacitor is completely charged and the Block is ready to perform the backup operation. Up to 60 seconds is required for the capacitor to charge completely.

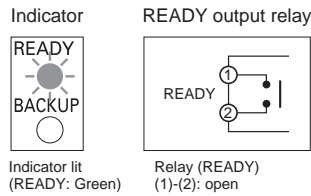

The following status will occur if there is an error in the charge voltage of the internal capacitor or the output voltage of the S8T-DCBU-02.

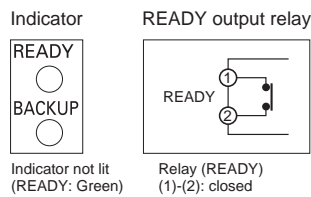

The backup operation will not be sufficient or will fail under the above status. If this status occurs, immediately remove the cause of the error, such as the following causes.

1. The connected DC voltage is 23 V or less.
2. The terminals have been connected in reverse or wiring is otherwise not correct.
3. The overvoltage protection circuit has operated.
4. The overcurrent protection circuit of the connected power supply has operated.

Note: The contact capacity of the output relay is 0.1 A at 24 VDC.

Backup Operation

The S8T-DCBU-02 will switch to the backup operation if a voltage drop is detected on the connected power supply.

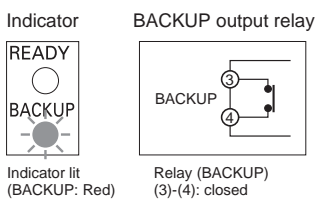

When the backup operation functions, the energy in the internal capacitor will be discharged to the load. When the voltage of the power supply then recovers, the S8T-DCBU-02 will start charging the capacitor. Up to 60 seconds is required to charge the capacitor completely. The backup operation may therefore not function for the required period if the backup operation starts while the capacitor is being charged.

The following are examples in which the backup operation may not be sufficient.

1. The backup operation starts within 60 seconds after turning ON the power supply.
2. The backup operation is started consecutively within 60 seconds of the previous backup operation.
3. A rapid change in the load or other factor causes the DC voltage to drop, resulting in the backup operation, and then the backup operation occurs again within 60 seconds.

The READY indicator and READY output will function as shown below when the internal capacitor is being charged.

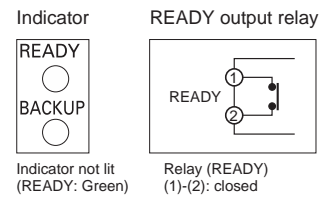

- Note:**
1. The contact capacity of the output relay is 0.1 A at 24 VDC.
 2. The backup operation may be repeatedly performed if the connected power supply is overloaded. Remove the cause of the overload immediately.
 3. The backup operation does not detect drops in the AC input.

Overcurrent Protection

The overcurrent protection circuit will operate at an overcurrent detection point of 5.8 to 6.8 A to automatically reduce the output voltage and protect equipment against shorts and overcurrents. Normal operation will be restored automatically when the overcurrent status is eliminated.

Note: Continuing operation in an overcurrent status may result in deterioration of or damage to internal parts.

Overvoltage Protection

If a voltage that is higher than the specified input voltage range is input or the output voltage exceeds the specified voltage, the overvoltage protection circuit will operate at between 31 and 36 V to shut OFF the output voltage and protect the load from damage due to overvoltages.

To restore operation, turn OFF the input power supply for 1 minute or longer and then turn it back ON.

- Note:**
1. Remove the cause of the overvoltage before turn the input power supply back ON.
 2. The backup operation will not be performed when the overvoltage circuit operates to shut OFF the output.

Reverse Connection Protection

The S8T-DCBU-02 will be protected even if the positive and negative I/O terminals are connected in reverse.

Nomenclature

Buffer Block

S8T-DCBU-02

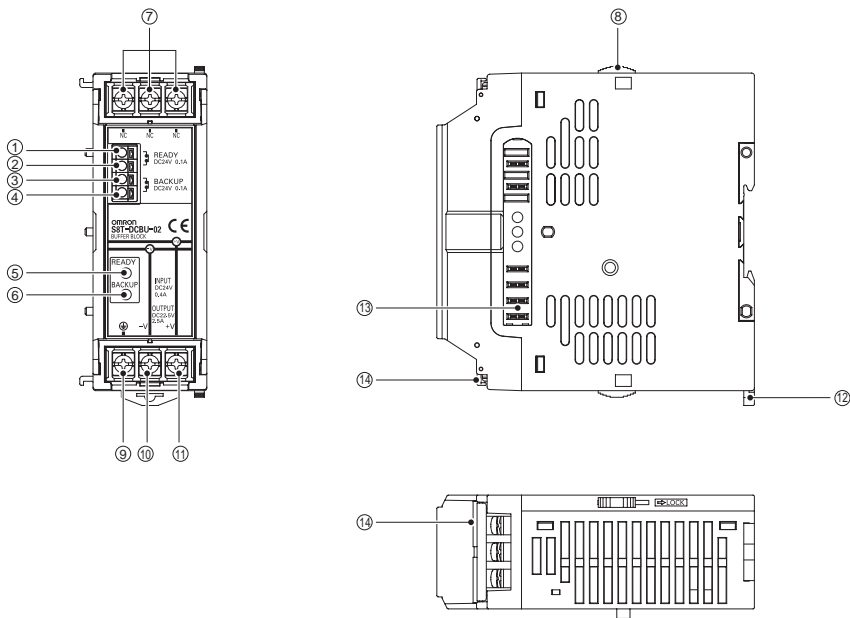

- ①, ②: READY Output: NC contact
- ③, ④: BACKUP Output: NC contact
- ⑤: READY Indicator (READY: Green)
- ⑥: BACKUP Indicator (BACKUP: Red)
- ⑦: NC
- ⑧: Slider

- ⑨: Protective Earth Terminal
- ⑩: I/O Terminal (-V)
- ⑪: I/O Terminal (+V)
- ⑫: Rail Stopper
- ⑬: Connecting part of Bus Line Connector
- ⑭: Terminal Block Cover

Bus Line Connector

S8T-BUS-03

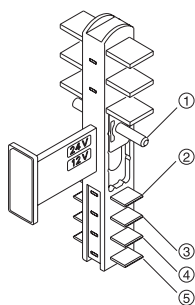

- ①: Selector
- ②: Ground Terminal
- ③: NC
- ④: DC Terminal (+V)
- ⑤: Bus Line DC Terminal (-V)

Engineering Data

Characteristics

Derating Curve

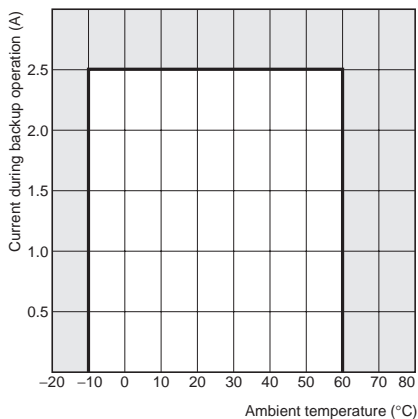

- Note:**
1. If natural air circulation is limited, use the forced air cooling to prevent overheating.
 2. The ambient temperature is measured at a point 50 mm below the Buffer Block.
 3. Check the derating curve for each power supply to be connected. Refer to *Connections to the S8TS (Reference Values)* on page 11 for details on the derating curves when connecting the Buffer Block to the S8TS-06024□ Power Supply.

Time Charts

Startup

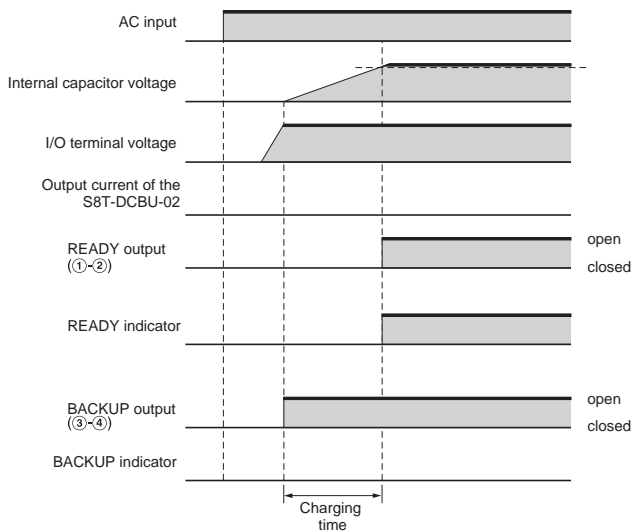

Momentary Power Failure or Voltage Drop

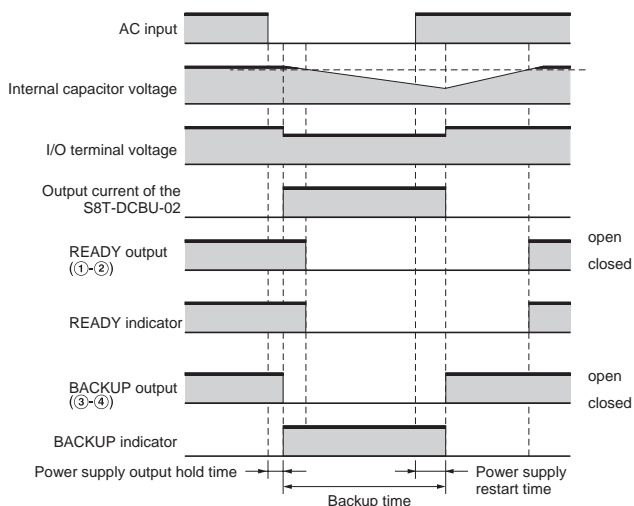

Power Supply Interrupted or Stopped

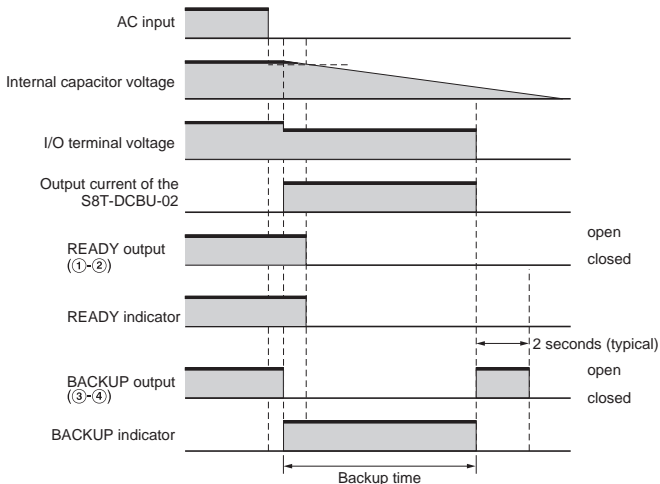

■ Backup Time

Single Operation

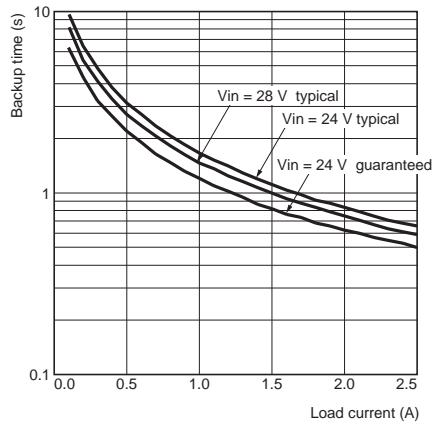

Parallel Operation with 2 Blocks

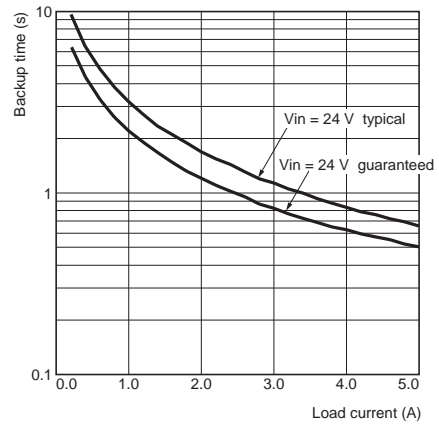

Parallel Operation with 3 Blocks

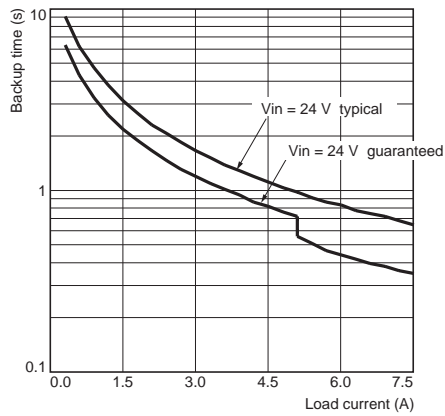

Parallel Operation with 4 Blocks

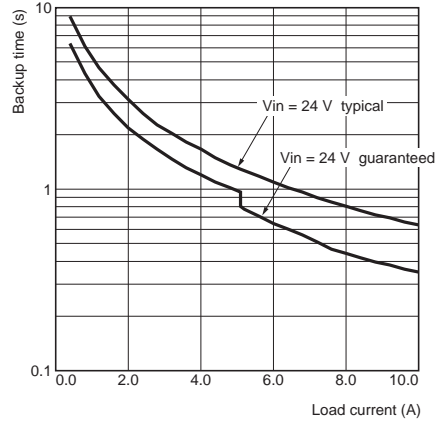

- Note:**
1. The backup time may be reduced if a fixed power load (such as a DC-DC converter) is connected.
 2. If the input voltage increases, the output voltage for the backup operation will also increase, reducing the backup time due to the higher power consumption of the load.

■ Connections to the S8TS (Reference Values)

Derating Curves of the S8TS-06024□ When Connecting to the S8TS-06024□

Number of S8TS-06024□ Blocks	S8TS-06024□ rated input	Number of S8T-DCBU-02 Blocks	Derating curve	Rated output power
1	200 to 240 VAC	1	*1	50 W
	100 to 120 VAC	1	*2	50 W
1 (+1) 2 2 (+1) 3 3 (+1) 4 4 (+1)	100 to 120/200 to 240 VAC	1	*3	44 W
		1	*4	110 W
		1	*5	98 W
		1	*6	170 W
		1	*7	152 W
		1	*8	230 W
		1	*9	206 W
		2	*10	40 W
		2	*11	40 W
1 (+1) 2 2 (+1) 3 3 (+1)	100 to 120/200 to 240 VAC	2	*12	34 W
		2	*13	100 W
		2	*14	88 W
		2	*15	160 W
		2	*16	142 W
		3	*17	30 W
1	200 to 240 VAC	3	*18	30 W
	100 to 120 VAC	3	*19	24 W
1 (+1) 2	100 to 120/200 to 240 VAC	3	*20	90 W
		3	*21	78 W
1	200 to 240 VAC	4	*22	20 W
	100 to 120 VAC	4	*23	20 W

- Note:**
- "+1" indicates the addition of one more S8TS-06024□ Basic Block if a redundant system is used.
 - If natural air circulation is limited, use forced air cooling to prevent overheating.
 - The ambient temperature is specified at a place 50 mm below the Product.
 - The energy consumption of the S8T-DCBU-02 (approximately 10 W per Block) from the S8TS-06024□ reduces the total output capacity when more than one S8TS-06024□ Block is connected.
 - The rated output current of the S8T-DCBU-02 is 2.5 A per Block regardless of the number of S8TS-06024□ Blocks that are connected.

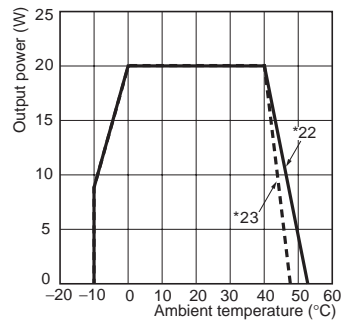
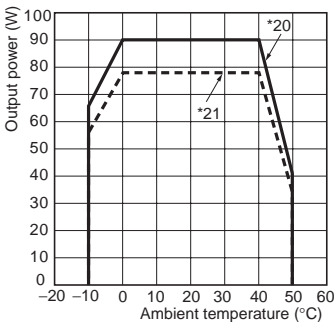
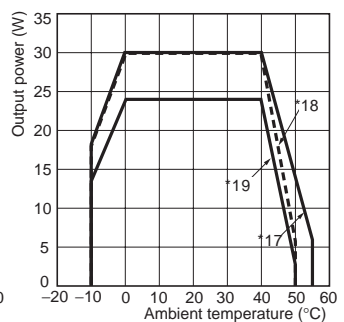
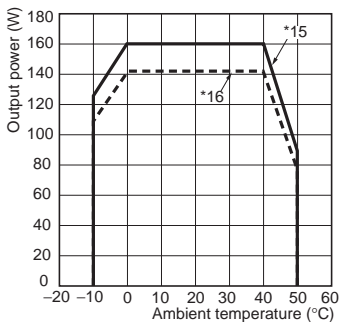
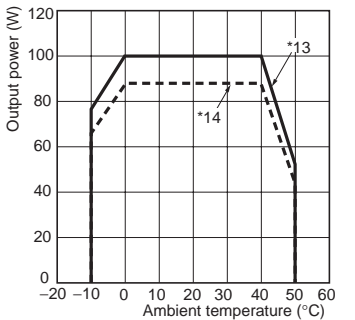
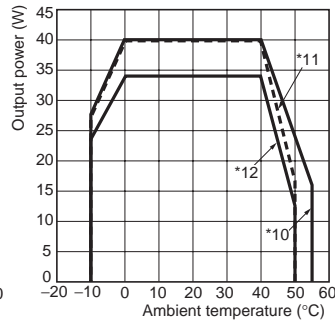
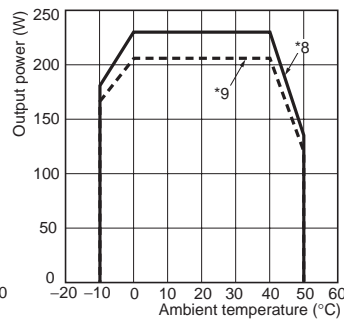
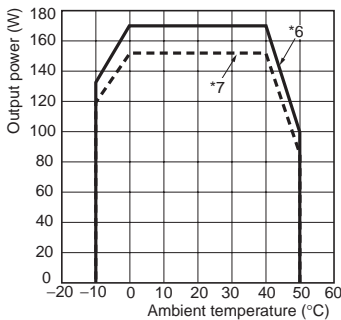
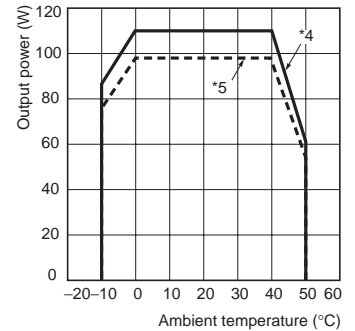
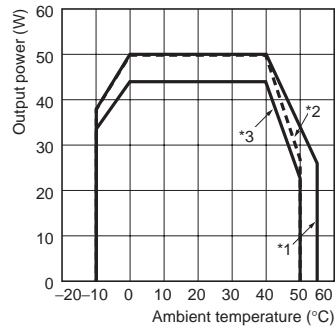

■ Power Supply Output Hold Times (Reference Values)

The rated currents are given for load currents.

Series	Model number	Load current (A)	Output hold time (ms)	
			100 VAC	200 VAC
S8TS	06024□	0.5	163	167
		1	98	100
		1.5	70	70
		2.1	56	58
S8VS	06024□	0.5	158	664
		1	88	382
		1.5	57	266
		2.1	36	194
	09024□□	1	118	508
		2	58	274
		2.95	34	176
	12024□□	1	262	262
		2	148	148
		3	102	102
		4.2	72	72
	18024□□	2	225	230
		4	107	120
		6	71	75
		6.3	65	70
	24024□□	2.5	170	170
		5	68	72
		7.5	52	56
		8.4	40	44
	S82K	03024	0.25	192
0.5			120	515
0.75			82	375
0.9			66	315
05024		0.5	118	505
		1	66	295
		1.5	41	200
		1.7	35	178
09024/ 10024		1	130	130
		2	67	73
		3	41	46
		3.4	34	39
P09024/ P10024		1	140	124
		2	75	68
		3	46	41
		3.4	41	36
24024□		2.5	164	170
		5	81	86
		7.5	50	56
		8.4	42	48
P24024□		2.5	185	192
		5	93	105
		7.5	60	67
		8.4	51	58

Series	Model number	Load current (A)	Output hold time (ms)	
			100 VAC	200 VAC
S82J	02524□□	0.2	170	700
		0.4	105	470
		0.6	74	345
		0.7	62	300
	05024□□	0.5	117	524
		1	65	300
		1.5	44	210
		1.7	38	185
	10024□□	1	133	600
		2	71	325
		3	46	210
		3.7	37	173
	15024□□	1.5	133	144
		3	66	73
		4.5	42	50
		5.3	34	40
	30024□	2.5	190	200
		5	100	105
		7.5	68	70
		10	48	50
60024□	2.5	353	365	
	5	193	203	
	7.5	130	138	
	10	98	104	
S8PS	05024□□	0.5	145	167
		1	98	100
		1.5	74	79
		1.7	72	75
	10024□□	1	160	160
		2	100	100
		3	70	70
		3.7	52	52
	15024□□	1.5	260	300
		3	128	130
		4.5	73	75
		5.3	50	52
	30024□□	2.5	440	440
		5	220	220
		7.5	131	132
		10	80	80

■ Power Supply Restart Times (Reference Values)

Series	Model number	Restart time (ms)					
		Momentary power failure time: 300 ms		Momentary power failure time: 500 ms		Momentary power failure time: 1,000 ms	
		100 VAC	200 VAC	100 VAC	200 VAC	100 VAC	200 VAC
S8TS	06024□	320	270	320	270	345	290
S8VS	06024□	220	5	280	95	380	155
	09024□□	220	5	286	100	390	157
	12024□□	360	248	400	288	432	322
	18024□□	230	198	247	216	263	235
	24024□□	5	5	5	5	15	5
S82K	03024	14	6	14	6	14	6
	05024	16	8	16	8	16	8
	09024/10024	5	5	60	52	65	60
	P09024/P10024	68	54	68	54	70	56
	24024□	86	52	86	52	86	52
	P24024	14	5	350	126	396	150
S82J	02524□□	11	10	11	10	12	11
	05024□□	188	72	200	82	224	100
	10024□□	175	4	198	82	218	98
	15024□□	210	76	216	76	218	76
	30024□	117	70	117	70	117	70
	60024□	158	86	158	86	158	86
S8PS	05024□□	196	172	208	174	292	224
	10024□□	225	180	233	187	287	217
	15024□□	225	184	240	198	337	252
	30024□□	325	304	330	325	340	335

Dimensions

Note: All units are in millimeters unless otherwise indicated.

■ Buffer Block

Buffer Block

S8T-DCBU-02

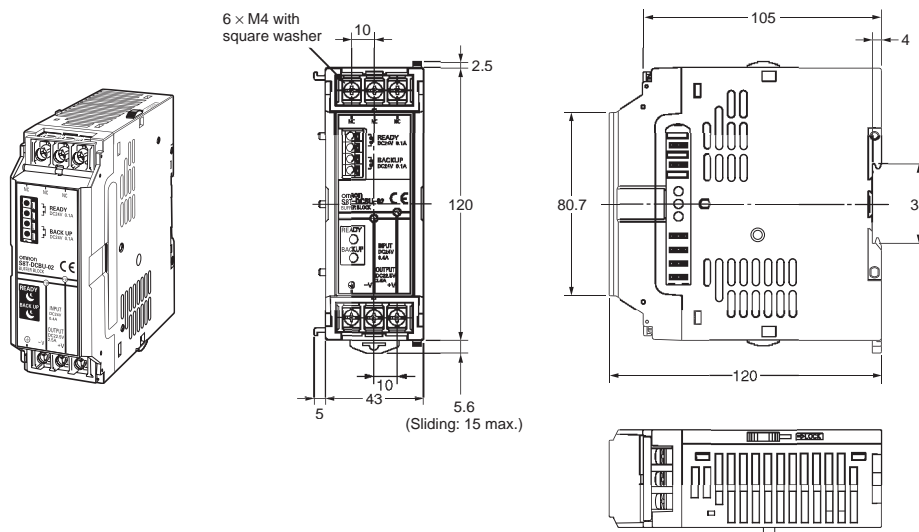

Bus Line Connector

S8T-BUS03

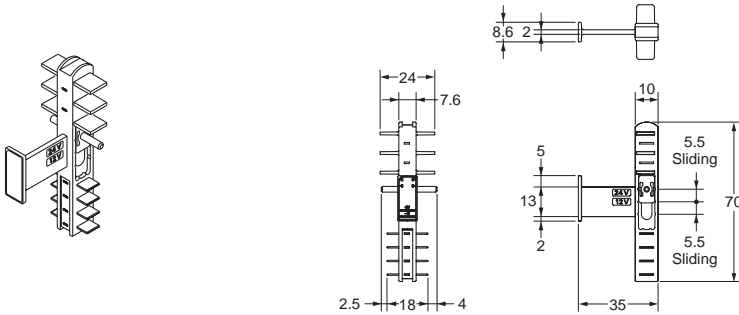

■ DIN Tracks

Mounting Tracks (Material: Aluminum)

PFP-100N

PFP-50N

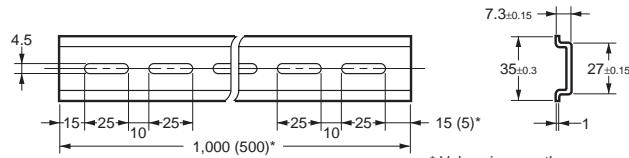
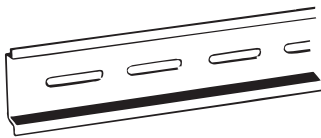

* Values in parentheses are for the PFP-50N.

PFP-100N2

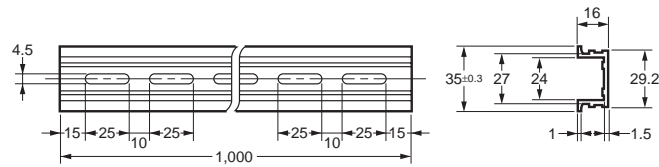
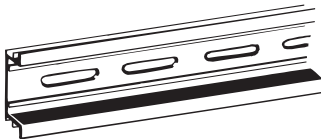

End Plate

PFP-M

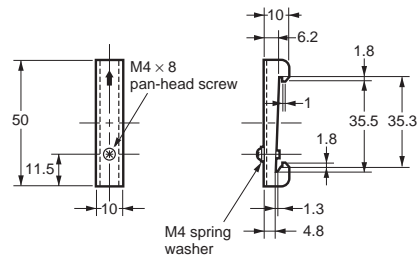



Safety Precautions

⚠ CAUTION

Installation and Environment

Minor fires may occasionally occur or wires may become detached causing the backup operation to fail if screws are not tightened properly. Tighten terminal screws to a torque of 1.08 N·m so that they do not become loose. 

Minor electric shock may occasionally occur. Do not remove the connector cover unless connecting the Bus Line Connector. 

Minor electric shock may occasionally occur and the backup operation will fail if the connector becomes disconnected. Be sure to lock the slider and track stopper securely when connecting the Basic Block and the S8T-DCBU-02 to prevent the connector from being disconnected due to vibration. 

Internal parts may occasionally deteriorate or be damaged and the backup operation may not be sufficient. Do not use the S8T-DCBU-02 for applications that subject the load to frequent inrush currents or overload currents. 

The S8T-DCBU-02 may occasionally be damaged. Do not allow any clippings or cuttings to enter the S8T-DCBU-02 during mounting. 

Operation

Minor burns may occasionally occur. Do not touch the S8T-DCBU-02 while power is being supplied or immediately after power is turned OFF. 

Minor electric shock may occasionally occur. Do not add or remove the S8T-DCBU-02 while power is being supplied. 

Maintenance

Minor electric shock may occasionally occur. Do not disassemble the S8T-DCBU-02 or touch the interior of the S8T-DCBU-02. 

■ Precautions for Safe Use

Observe the following precautions to ensure safety when using the S8T-DCBU-02.

Setting and Selecting Power Supply to be Connected

- Do not connect a power supply other than the ones specified below.
Specified Power Supply: S8TS Series, S8VS Series (SELV Power Supply) S82K Series, S82J Series, S8PS Series. Only power supplies with an output voltage of 24 V and an output capacity of 25 W or more can be connected.
- When selecting the power supply to be connected, take both the operation current and power of S8T-DCBU-02 into consideration, allowing sufficient margin.

Mounting

- The internal parts may occasionally deteriorate or be broken due to adverse heat radiation. Operate the S8T-DCBU-02 only under the specified conditions.
- Ensure sufficient heat dissipation when installing the Product to increase its long-term reliability.
- Install the Product so that a natural airflow occurs around it.

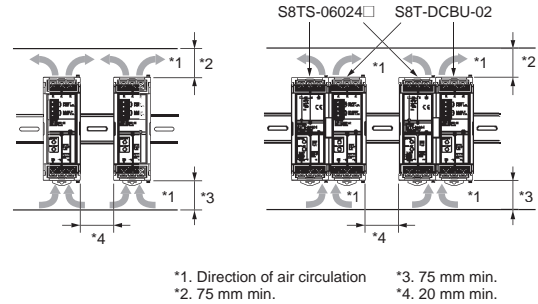

Installation/Wiring

- Minor electric shock or malfunction may possibly occur. Connect the ground wire completely.
- Minor fires may possibly occur. Check the terminals to be sure they are wired correctly.
- Do not apply a force greater than 100 N to the terminal block when tightening the terminals.
- Close the terminal cover to help prevent short-circuiting terminals with foreign objects.
- Be sure to remove the sheets covering the S8T-DCBU-02 before turning ON the power supply and confirm that nothing is interfering with heat dissipation.
- Use the wiring material specified in the following table to protect wires from smoking and burning due to load abnormalities. Also, the backup operation may not be sufficient due to voltage drop if thin wiring materials are used.

I/O Terminals

Load current	Number of connected S8T-DCBU-02	Recommended wire diameter
Up to 2.5 A	1	AWG 14 to 20 (cross-sectional area: 0.517 to 2.081 mm ²)
Up to 5.0 A	2	AWG 14 to 18 (cross-sectional area: 0.823 to 2.081 mm ²)
Up to 7.5 A	3	AWG 14 to 16 (cross-sectional area: 1.309 to 2.081 mm ²)
Up to 10 A	4	AWG 14 (cross-sectional area: 2.081 mm ²)

Signal output terminals: AWG 14 to 22 (Cross-sectional area: 0.326 to 1.309 mm²)
(Wire stripping length: 11 mm)

Installation Environment

- Do not install the S8T-DCBU-02 in places subjected to shock or vibration. A device such as a contact breaker may be a vibration source. Install the S8T-DCBU-02 as far as possible from possible sources of shock or vibration. Additionally, install a PFP-M End Plate on each end of the Product.
- If the S8T-DCBU-02 is used in an area with excessive high-frequency noise, be sure to separate the S8T-DCBU-02 as far as possible from the noise sources.

Ambient Operating Environment and Storage Environment

- Store the S8T-DCBU-02 at an ambient temperature of -25 to +65°C, and a relative humidity of 25% to 90%.
- The internal parts may occasionally deteriorate or be broken. Do not use the S8T-DCBU-02 outside the derating range (i.e., under conditions indicated by the shaded area () in the derating curve diagram on page 9.)
- Use the S8T-DCBU-02 at a relative humidity of 25% to 85%.
- Do not use the S8T-DCBU-02 where it would be subjected to direct sunlight.
- Do not use the S8T-DCBU-02 where it would be subjected to penetration of liquid, foreign substance, or corrosive gas.

Precautions in Using

- After connecting the devices to the S8T-DCBU-02, check whether sufficient backup is performed correctly by operating the S8T-DCBU-02.
- Check the load current using the actual system in advance to confirm that there is sufficient leeway in the backup time.
- Check to confirm that the READY indicator and the output function correctly. The backup operation may not be sufficient if the READY indicator and output do not function correctly.
- The S8T-DCBU-02 will perform the backup operation not only for instantaneous power interruptions or voltage drops, but also when the power supply is OFF. The backup time is particularly long for light loads. Check the devices connected to the S8T-DCBU-02 to be sure it has stopped operation correctly.

Periodic Inspection and Periodic Replacement

The S8T-DCBU-02 contains built-in electrolytic capacitors, which have a limited life. Perform periodic inspection and replacement. The performance of the electrolytic capacitor will deteriorate as the total operating time increases, eventually leading to insufficient performance. Refer to the following guidelines for periodic replacement.

Ambient temperature	Guideline of replacement	
	With space between the Units	Connected to S8TS
30°C max.	15 years	15 years
40°C	12 years	8.5 years
50°C	6 years	5.5 years (See note.)
60°C	3 years	---

Note: The load ratio of the S8TS is limited to 60% due to the derating curve.

Charging Batteries

If a battery is to be connected as the load, mount an overcurrent limiting circuit and an overvoltage protection circuit.

Handling the Bus Line Connector

- Do not drop the Bus Line Connector or subject it to strong shock.
- Do not connect and disconnect the Bus Line Connector more than 20 times. Also, do not touch the terminals on the Bus Line Connector. Connection failure may cause deterioration of electric performance.

Troubleshooting

The following table lists the errors that may occur when the S8T-DCBU-02 is used, along with their probable causes and remedies. Check the relevant items.

When	Cause	Description	Remedies
During installation	The S8TS-06024□ and S8T-DCBU-02 cannot be connected.	The Bus Line Connector is provided with a selector to prevent misconnection of 12-V and 5-V S8TS Blocks. Connection will not be possible if the selector is set for the wrong type of Block.	Set the selector on the Bus Line Connector to 24 V. Refer to <i>S8T-BUS03 Bus Line Connector</i> on page 5.
When checking operation (Refer to <i>Checking Operation</i> on page 6.)	The S8TS-06024□ connected in step 2 of the operation checking procedure does not operate.	The AC line is not connected by the S8T-BUS03 Bus Line Connector when the S8TS-06024□ is connected. The S8T-DCBU-02 may be connected between two S8TS-06024□ Blocks.	Connect the S8T-DCBU-02 to the right or left end of the connected Blocks. Refer to <i>Mounting</i> on page 5.
	The READY indicator on the S8T-DCBU-02 does not light in step 2 of the operation checking procedure when connected to the S8TS.	Power is supplied via the S8T-BUS03 Bus Line Connector when the S8T-DCBU-02 and S8TS are connected. The Bus Line Connector may not be connected.	Connect the S8T-DCBU-02 and S8TS-06024□ using an S8T-BUS03 Bus Line Connector. Refer to <i>Basic Configuration</i> on page 1.
		A Bus Line Connector that does not connect the DC line (such as the S8T-BUS02) may be connected.	Connect the S8T-DCBU-02 and S8TS-06024□ using an S8T-BUS03 Bus Line Connector. Refer to <i>Basic Configuration</i> on page 1.
	The READY indicator on the S8T-DCBU-02 does not light in step 2 of the operation checking procedure.	Up to 60 seconds is required to completely charge the internal capacitor after the power supply has been turned ON. The READY indicator will not turn ON immediately after the power supply is turned ON.	Check that the READY indicator lights after 60 seconds has passed since turning ON the power supply. Refer to <i>READY Operation</i> on page 7.
		The positive and negative I/O terminals on the S8T-DCBU-02 may be connected in reverse or the power supply may be connected to an incorrect terminal (e.g., an NC terminal).	Check the wiring to be sure it is correct. The internal circuits of the S8T-DCBU-02 will be protected even if the positive and negative terminals are reversed. Refer to <i>Reverse Connection Protection</i> on page 7.
		The voltage input to the S8T-DCBU-02 may be 23 V or less.	Check the I/O terminals on the S8T-DCBU-02 and adjust the voltage output by the power supply so that it is 24 V or higher. Refer to <i>Input Voltage</i> on page 5.
		Overcurrent protection on the connected power supply may have operated and the voltage may have dropped to below 23 V.	The S8T-DCBU-02 consumes 0.4 A, so the rated current of the connected power supply cannot be delivered completely to the load. Increase the capacity of the connected power supply. Refer to <i>Selecting the Power Supply</i> on page 4.
	The backup operation is not performed for the expected backup time in step 4 of the operation checking procedure.	The restart time of the connected power supply after recovery from momentary power failures may be too long.	The momentary power failure time differs from the backup time required to compensate for it. Change to a power supply with a shorter restart time or connect S8T-DCBU-02 Blocks in parallel to increase the backup time. Refer to <i>Selecting the Power Supply</i> on page 4.
		The voltage during the backup operation may be high, increasing the power consumption during the backup operation.	The output voltage during the backup operation is automatically adjusted based on detecting the voltage input to the S8T-DCBU-02. Connect S8T-DCBU-02 Blocks in parallel to increase the backup time. Refer to <i>Parallel Operation Connection</i> on page 5.
		The output current during the backup operation may be higher than expected.	Connect S8T-DCBU-02 Blocks in parallel to increase the backup time. Refer to <i>Parallel Operation Connection</i> on page 5.
The voltage output for the backup operation is low in step 4 of the operation checking procedure.	Overcurrent protection on the connected power supply may have operated and the voltage input to the S8T-DCBU-02 may have dropped to below 24 V.	The S8T-DCBU-02 consumes 0.4 A, so the rated current of the connected power supply cannot be delivered completely to the load. Increase the capacity of the connected power supply. Refer to <i>Selecting the Power Supply</i> on page 4.	
	The wiring to the load is too long or too thin, causing excessive voltage drop.	Use the thickest wire and shortest distance possible. The output voltage during backup will be up to 2 V lower than the input voltage. Refer to <i>Wiring Connections</i> on page 5.	

When	Cause	Description	Remedies
When checking operation (Refer to <i>Checking Operation</i> on page 6.)	The voltage output for the backup operation is low in step 4 of the operation checking procedure.	Overcurrent protection may have operated on the S8T-DCBU-02.	Allow for leeway for the load capacity in the application or increase the output current during the backup operation by connecting S8T-DCBU-02 Blocks in parallel. Refer to <i>Parallel Operation Connection</i> on page 5.
When checking operation (Refer to <i>Checking Operation</i> on page 6.)	The BACKUP indicator does not light in step 4 of the operation checking procedure.	The output hold time of the connected power supply may be sufficient to handle the momentary power failure.	Use a timer to increase the power failure of the AC input from the connected power supply and confirm that the BACKUP indicator lights. Refer to <i>Selecting the Power Supply</i> on page 4.
		The voltage output from the S8T-DCBU-02 during the backup operation may be lower because overcurrent protection has operated in the S8T-DCBU-02.	Allow for leeway for the load capacity in the application or increase the output current during the backup operation by connecting S8T-DCBU-02 Blocks in parallel. Refer to <i>Parallel Operation Connection</i> on page 5.
During actual operation	The READY indicator is not lit and the READY output is OFF.	The voltage input to the S8T-DCBU-02 may be 23 V or less.	Check the voltage at the I/O terminals of the S8T-DCBU-02 and adjust the voltage output by the power supply so that it is 24 V or higher. Refer to <i>Input Voltage</i> on page 5.
		A voltage of approximately 31 V or higher may be input to the I/O terminals of the S8T-DCBU-02, causing the overvoltage protection circuit to operate.	Clear the overvoltage protection (turn OFF the input power supply for 1 minute or longer and then turn it back ON). Refer to <i>Overvoltage Protection</i> on page 7.
	The backup time has become shorter.	It's possible that momentary power failures are occurring consecutively.	The backup time is measured when the built-in electrolytic capacitors are fully charged. If momentary power failures occur within one minute of each other, the charge will not be complete and the backup time will be shorter. Refer to <i>Backup Operation</i> on page 7.
		It's possible that the characteristics of the built-in electrolytic capacitors have deteriorated.	Electrolytic capacitors are built into the Block and these capacitors have a limited life. When an electrolytic capacitor exceeds its useful life, its capacity will decrease and other characteristics will deteriorate. This will cause the backup time to be shorter. Refer to <i>Operation Check and Periodic Inspection</i> on page 6 and to <i>Periodic Inspection and Periodic Replacement</i> on page 16.
	There is chattering on the READY output.	The input voltage of the S8T-DCBU-02 may be very close to 23 V.	Check the voltage at the I/O terminals of the S8T-DCBU-02 and adjust the voltage output by the power supply so that it is 24 V or higher. Refer to <i>Input Voltage</i> on page 5.
	The output voltage is not restored even after the power supply is restored following a momentary power failure.	Protection on the connected power supply may have operated, stopping the operation of the power supply.	Clear the protection function of the connected power supply.
The backup operation is performed repeatedly.		If more than one S8TS-06024□ Block is connected, one of the Blocks may be faulty.	Replace the faulty S8TS-06024□ Block.
		An overcurrent status caused by load fluctuation may exist in the power supply.	Allow for leeway for the load capacity in the application or increase the capacity of the connected power supply. Refer to <i>Backup Operation</i> on page 7.

Warranty and Application Considerations

Read and Understand this Catalog

Please read and understand this catalog before purchasing the products. Please consult your OMRON representative if you have any questions or comments.

Warranty and Limitations of Liability

WARRANTY

OMRON's exclusive warranty is that the products are free from defects in materials and workmanship for a period of one year (or other period if specified) from date of sale by OMRON.

OMRON MAKES NO WARRANTY OR REPRESENTATION, EXPRESS OR IMPLIED, REGARDING NON-INFRINGEMENT, MERCHANTABILITY, OR FITNESS FOR PARTICULAR PURPOSE OF THE PRODUCTS. ANY BUYER OR USER ACKNOWLEDGES THAT THE BUYER OR USER ALONE HAS DETERMINED THAT THE PRODUCTS WILL SUITABLY MEET THE REQUIREMENTS OF THEIR INTENDED USE. OMRON DISCLAIMS ALL OTHER WARRANTIES, EXPRESS OR IMPLIED.

LIMITATIONS OF LIABILITY

OMRON SHALL NOT BE RESPONSIBLE FOR SPECIAL, INDIRECT, OR CONSEQUENTIAL DAMAGES, LOSS OF PROFITS, OR COMMERCIAL LOSS IN ANY WAY CONNECTED WITH THE PRODUCTS, WHETHER SUCH CLAIM IS BASED ON CONTRACT, WARRANTY, NEGLIGENCE, OR STRICT LIABILITY.

In no event shall the responsibility of OMRON for any act exceed the individual price of the product on which liability is asserted.

IN NO EVENT SHALL OMRON BE RESPONSIBLE FOR WARRANTY, REPAIR, OR OTHER CLAIMS REGARDING THE PRODUCTS UNLESS OMRON'S ANALYSIS CONFIRMS THAT THE PRODUCTS WERE PROPERLY HANDLED, STORED, INSTALLED, AND MAINTAINED AND NOT SUBJECT TO CONTAMINATION, ABUSE, MISUSE, OR INAPPROPRIATE MODIFICATION OR REPAIR.

Application Considerations

SUITABILITY FOR USE

OMRON shall not be responsible for conformity with any standards, codes, or regulations that apply to the combination of products in the customer's application or use of the products.

Take all necessary steps to determine the suitability of the product for the systems, machines, and equipment with which it will be used.

Know and observe all prohibitions of use applicable to this product.

NEVER USE THE PRODUCTS FOR AN APPLICATION INVOLVING SERIOUS RISK TO LIFE OR PROPERTY WITHOUT ENSURING THAT THE SYSTEM AS A WHOLE HAS BEEN DESIGNED TO ADDRESS THE RISKS, AND THAT THE OMRON PRODUCTS ARE PROPERLY RATED AND INSTALLED FOR THE INTENDED USE WITHIN THE OVERALL EQUIPMENT OR SYSTEM.

Disclaimers

PERFORMANCE DATA

Performance data given in this catalog is provided as a guide for the user in determining suitability and does not constitute a warranty. It may represent the result of OMRON's test conditions, and the users must correlate it to actual application requirements. Actual performance is subject to the OMRON *Warranty and Limitations of Liability*.

CHANGE IN SPECIFICATIONS

Product specifications and accessories may be changed at any time based on improvements and other reasons. Consult with your OMRON representative at any time to confirm actual specifications of purchased product.

DIMENSIONS AND WEIGHTS

Dimensions and weights are nominal and are not to be used for manufacturing purposes, even when tolerances are shown.

ALL DIMENSIONS SHOWN ARE IN MILLIMETERS.

To convert millimeters into inches, multiply by 0.03937. To convert grams into ounces, multiply by 0.03527.

Cat. No. T029-E1-01A **In the interest of product improvement, specifications are subject to change without notice.**

OMRON Corporation

Industrial Automation Company

Industrial Devices and Components Division H.Q.

Power Electronics Department

Shiokoji Horikawa, Shimogyo-ku,

Kyoto, 600-8530 Japan

Tel: (81)75-344-7108/Fax: (81)75-344-7189

0903 (0603)