

**NS-Series**

**NS15-TX01□-V2**

**NS12-TS00□-V1/-V2, NS12-TS01□-V1/-V2**

**NS10-TV00□-V1/-V2, NS10-TV01□-V1/-V2**

**NS8-TV00□-V1/-V2, NS8-TV01□-V1/-V2**

**NS8-TV10□-V1, NS8-TV11□-V1**

**NS5-SQ00□-V1/-V2, NS5-SQ01□-V1/-V2**

**NS5-SQ10□-V2, NS5-SQ11□-V2**

**NS5-TQ00□-V2, NS5-TQ01□-V2**

**NS5-TQ10□-V2, NS5-TQ11□-V2**

**NS5-MQ00□-V2, NS5-MQ01□-V2**

**NS5-MQ10□-V2, NS5-MQ11□-V2**

# Programmable Terminals

## PROGRAMMING MANUAL

**OMRON**



## Introduction

Thank you for purchasing an NS-series Programmable Terminal.

NS-series PTs are designed to transfer data and information in FA production sites.

The CX-Designer is a software package that enables creating and maintaining screen data for OMRON NS-series Programmable Terminals.

Please be sure that you understand the functions and performance of the PT before attempting to use it. When using an NS-series PT, please also refer to the *NS Series Setup Manual* and the *CX-Designer Online Help*.

### Intended Audience

This manual is intended for the following personnel, who must also have knowledge of electrical systems (an electrical engineer or the equivalent).

- Personnel in charge of introducing FA systems into production facilities.
- Personnel in charge of designing FA systems.
- Personnel in charge of installing and connecting FA systems.
- Personnel in charge of managing FA systems and facilities.

### Precaution

- The user must operate the product according to the performance specifications described in the operation manuals.
- Do not use the PT touch switch input functions for applications where danger to human life or serious property damage is possible, or for emergency switch applications.
- Before using the product under conditions which are not described in the manual or applying the product to nuclear control systems, railroad systems, aviation systems, vehicles, combustion systems, medical equipment, amusement machines, safety equipment, and other systems, machines and equipment that may have a serious influence on lives and property if used improperly, consult your OMRON representative.
- Make sure that the ratings and performance characteristics of the product are sufficient for the systems, machines, and equipment, and be sure to provide the systems, machines, and equipment with double safety mechanisms.
- This manual provides information for connecting and setting up an NS-series PT. Be sure to read this manual before attempting to use the PT and keep this manual close at hand for reference during installation and operation.

### ©OMRON, 2002

All rights reserved. No part of this publication may be reproduced, stored in a retrieval system, or transmitted, in any form, or by any means, mechanical, electronic, photocopying, recording, or otherwise, without the prior written permission of OMRON.

No patent liability is assumed with respect to the use of the information contained herein. Moreover, because OMRON is constantly striving to improve its high-quality products, the information contained in this manual is subject to change without notice. Every precaution has been taken in the preparation of this manual. Nevertheless, OMRON assumes no responsibility for errors or omissions. Neither is any liability assumed for damages resulting from the use of the information contained in this publication.

## Notation and Terminology

The following notation and terminology are used in this programming manual.

### Notation

The following notation is used in this manual.

### Note

Indicates additional information on operation, descriptions, or settings.



### Precautions for Correct Use

Precautions for correct use describe items that are essential for functionality and performance when using the product, and operating methods for maintaining reliability.



## Terminology

PT	In this manual, indicates an NS-series Programmable Terminal.
NS Series	Indicates products in the OMRON NS□□ Series of Programmable Terminals.
PLC	Indicates Programmable Controllers in the OMRON SYSMAC CS/CJ, C, or CVM1/CV Series of Programmable Controllers.
CS Series	Indicates Programmable Controllers in the OMRON SYSMAC CS Series of Programmable Controllers: CS1G, CS1H, CS1G-H, or CS1H-H
CJ Series	Indicates Programmable Controllers in the OMRON SYSMAC CJ Series of Programmable Controllers: CJ1G, CJ1G-H, CJ1H-H, CJ1M, CP1H, CP1L, CJ2H, CJ2M References to "CJ1H-H" in this manual indicate the CJ1H-CPU□□H-R and CJ1H-CPU□□H. References to "CJ1H-H-R" indicate the CJ1H-CPU□□H-R. "CJ2" is used when referring specifically to only the CJ2 CPU Units.
C Series	Indicates Programmable Controllers in the OMRON SYSMAC C Series of Programmable Controllers: C200HS, C200HX/HG/HE-E/-ZE, CQM1, CQM1H, CPM1A, CPM2A, CPM2C
CVM1/CV Series	Indicates Programmable Controllers in the OMRON SYSMAC CV/CVM1 Series of Programmable Controllers: CV500, CV1000, CV2000, CVM1
Serial Communications Unit	Indicates a Serial Communications Unit for an OMRON CS/CJ-series PLC.
Serial Communications Board	Indicates a Serial Communications Board for an OMRON CS-series or CQM1H PLC.
Communications Board	Indicates a Communications Board for an OMRON C200HX/HG/HE-E/-ZE PLC.
CPU Unit	Indicates a CPU Unit in the OMRON SYSMAC CS/CJ, C, or CVM1/CV Series of Programmable Controllers.
CX-Designer	Indicates the OMRON CX-Designer (NS-CXDC1-V□).
Host	Indicates the PLC, FA computer, or personal computer functioning as the control device and interfaced with the NS-series PT.
Setup Manual	Unless otherwise indicated, indicates the <i>NS Series -V1/-V2 Setup Manual</i> (V083-E1-0□).

## Related Manuals

The following manuals are used for NS-series PTs. (The boxes at the end of the catalog numbers indicate the revision code.)

### Confirming Screen Configurations, Object Functions, and Host Communications

This manual

- **NS Series Programming Manual**.....**V073-E1-□**

Setting methods for normal functional objects and fixed objects can be displayed in the CX-Designer using online help. Use the online help for normal operation.

Use the *NS Series Programming Manual* for information on the operation of the PT or when setting methods are not clear or not complete enough when using the CX-Designer.

The *NS Series Programming Manual* describes mainly the operation of the PT and setting methods for functional and fixed objects. It does not provide detailed operating procedures for the CX-Designer. Use the online help provided with the CX-Designer to obtain information on CX-Designer operating methods.

- **NS Series -V1/-V2 Setup Manual**.....**V083-E1-□**

Provides information on NS Series V1 and V2 PTs (i.e., NS15-V□, NS12-V□, NS10-V□, NS8-V□, and NS5-V□).

Describes how to connect the PT to the host and peripheral devices, methods to setup communications and operation, and procedures for maintenance.

Refer to the *NS Series Programming Manual* (V073-E1-□) for information on PT functions and specific operating procedures.

### Confirming PT Functions, Operations, and Procedures

- **NS Series Setup Manual**.....**V072-E1-□**

Provides information on existing NS Series models (i.e., NS12, NS10, and NS7).

#### Using the NS-series Macro Function

- **Macro Reference (Installed from the CX-Designer CD-ROM.)**

The online help for the CX-Designer contains detailed information on the macro function of the NS-series macro functions. The Macro Reference contains essentially the same information, and it is installed on the hard disk as PDF Files when the CX-Designer is installed.

Use either the online help or the Macro Reference, whichever is more convenient.

### Confirming PLC Functions and Operation

- **PLC Operation Manuals**

Refer to the operation manuals for individual PLC Units (e.g., the CPU Unit, Special I/O Units, CPU Bus Units, Communications Units, etc.) to obtain information on PLC functions and operation.

# Contents

Introduction .....	P-1
Notation and Terminology .....	P-2
Related Manuals .....	P-4

## Section 1 Overview

1-1 NS-series PT Operation .....	1-1
1-1-1 How NS-series PTs Work at FA Production Sites .....	1-1
1-1-2 NS-series PT Operation .....	1-2
1-2 NS-series PT Functions .....	1-4
1-2-1 NS-series PT Functions.....	1-4
1-2-2 Differences between Models.....	1-7
1-2-3 Main NS-series Functions.....	1-9
1-2-4 NS-series Displays .....	1-11
1-3 Communicating with the Host.....	1-20
1-3-1 Host Registration and Address.....	1-20
1-3-2 Ethernet.....	1-20
1-3-3 Controller Link .....	1-20
1-3-4 NT Links .....	1-21
1-3-5 Host Link .....	1-22
1-3-6 EtherNet/IP .....	1-22
1-3-7 PT Memory .....	1-22
1-4 System Configuration .....	1-28
1-4-1 Peripheral Devices .....	1-28
1-4-2 Connecting to the Host.....	1-31
1-5 Procedure before Operation.....	1-32

## Section 2 NS Series Functions

2-1 Project Data .....	2-1
2-1-1 Project Configuration.....	2-1
2-1-2 Project Properties .....	2-3
2-2 NS Series Screen Types .....	2-9
2-2-1 Display Colors .....	2-9
2-2-2 Screen Configuration .....	2-10
2-2-3 Screen Numbers.....	2-11
2-2-4 Screen Types .....	2-12
2-2-5 Screen Objects .....	2-16
2-3 Internal Memory .....	2-18
2-3-1 Bit Memory (\$B) .....	2-18
2-3-2 Word Memory (\$W).....	2-18
2-3-3 Internal Holding Memory (\$HB/\$HW) .....	2-18
2-4 System Memory.....	2-19
2-4-1 System Bit Memory (\$SB).....	2-19
2-4-2 System Word Memory (\$SW).....	2-35
2-4-3 System Memory Compatibility with the NT Series .....	2-42

2-5	Communications Address Settings .....	2-47
2-5-1	Register Host.....	2-47
2-5-2	Communications Addresses .....	2-48
2-5-3	Directly Specifying Addresses.....	2-49
2-5-4	Tags.....	2-53
2-6	Fixed Objects.....	2-58
2-6-1	Common Fixed Object Settings .....	2-58
2-7	Registering/Using Library .....	2-64
2-8	Common Functional Object Functions .....	2-65
2-8-1	Table of Functional Object Settings.....	2-65
2-8-2	Address Settings (General Tab and Other Tabs) .....	2-66
2-8-3	Unit and Scale (General Tab).....	2-69
2-8-4	Numeral Display and Storage Type (General Tab) .....	2-71
2-8-5	Date and Time Format (General Tab) .....	2-78
2-8-6	Text Attributes.....	2-80
2-8-7	Setting Colors (Color/Shape Tab) .....	2-85
2-8-8	Background.....	2-86
2-8-9	Selecting Shape (Color/Shape Tab).....	2-87
2-8-10	Labels .....	2-89
2-8-11	Scroll Bars .....	2-93
2-8-12	Frames .....	2-94
2-8-13	Flicker (Extension Tab) .....	2-95
2-8-14	Write Settings (Extension Tab).....	2-100
2-8-15	Passwords (Extension Tab).....	2-104
2-8-16	Control Flags (Extension Tab).....	2-111
2-8-17	Macro (Extension Tab).....	2-112
2-8-18	Size/Position (Extension Tab).....	2-113
2-8-19	Change Input Order .....	2-115
2-8-20	String Table .....	2-116
2-9	Buttons .....	2-119
2-9-1	ON/OFF Buttons.....	2-119
2-9-2	Word Buttons .....	2-127
2-9-3	Command Buttons .....	2-135
2-10	Lamps .....	2-153
2-10-1	Bit Lamps .....	2-153
2-10-2	Word Lamps .....	2-157
2-11	Multifunction Objects.....	2-161
2-11-1	Functions That Can Be Executed Using Multifunction Objects .....	2-163
2-11-2	Execution Conditions for Multifunction Objects.....	2-164
2-11-3	Safety Functions .....	2-165
2-11-4	Writing and Reading Communications Addresses.....	2-167
2-11-5	Canceling Multifunction Object Processing .....	2-168
2-11-6	Converting from Other Objects to Multifunction Objects .....	2-169
2-11-7	Functional Object Property Settings.....	2-170
2-11-8	Detailed Settings for Each Function .....	2-178

- 2-12 Display and Input Objects .....2-239
  - 2-12-1 Numeral Display and Input .....2-239
  - 2-12-2 String Display and Input.....2-247
  - 2-12-3 Thumbwheel Switches.....2-252
  - 2-12-4 List Selection.....2-257
  - 2-12-5 Temporary Input Objects .....2-265
- 2-13 Display .....2-270
  - 2-13-1 Text.....2-270
  - 2-13-2 Bitmaps.....2-277
  - 2-13-3 Level Meters.....2-282
  - 2-13-4 Analogue Meter .....2-286
  - 2-13-5 Video Display .....2-291
  - 2-13-6 Consecutive Line Drawings .....2-296
- 2-14 Alarms and Events .....2-298
  - 2-14-1 Outline .....2-298
  - 2-14-2 Alarm/Event Display Objects .....2-309
  - 2-14-3 Alarm/Event Summary and History .....2-314
  - 2-14-4 Searching for Alarms and Events Using the Ladder Monitor.....2-322
- 2-15 Data Logs.....2-327
  - 2-15-1 Outline .....2-327
  - 2-15-2 Data Log Graphs .....2-336
  - 2-15-3 Example Setting Procedure .....2-347
- 2-16 Broken-line Graphs.....2-365
- 2-17 Data Blocks.....2-378
  - 2-17-1 What Is a Data Block?.....2-378
  - 2-17-2 Data Block Tables.....2-389
  - 2-17-3 Using Data Blocks.....2-400
- 2-18 System Clock.....2-406
  - 2-18-1 Date Object.....2-406
  - 2-18-2 Time Objects .....2-409
- 2-19 Machine Navigator Function .....2-412
  - 2-19-1 Machine Navigator .....2-412
  - 2-19-2 Contents Display .....2-421
  - 2-19-3 Usage Examples for Machine Navigator Function.....2-426
- 2-20 Special Functions.....2-431
  - 2-20-1 Operation Log Function .....2-431
  - 2-20-2 Alarm/Event History Function .....2-441
  - 2-20-3 Data Log Function.....2-443
  - 2-20-4 Error Log Function .....2-447
  - 2-20-5 Screen Saver Function.....2-449
  - 2-20-6 Buzzer Function .....2-451
  - 2-20-7 Clock Function .....2-453
  - 2-20-8 Starting External Applications.....2-454
  - 2-20-9 Device Monitor Function .....2-455
  - 2-20-10 Video Configuration .....2-479
  - 2-20-11 Programming Console Functions .....2-482

2-20-12	PLC Data Trace .....	2-486
2-21	System Settings and System Menu .....	2-498
2-22	Transferring Device Data .....	2-500
2-22-1	What Is Device Data Transfer? .....	2-500
2-22-2	Device Data Setting Dialog Box .....	2-501

**Section 3 Using PTs**

3-1	Procedure before Operation .....	3-1
3-2	Controlling Buzzers, Backlights, and Display .....	3-2
3-2-1	Sounding Buzzers .....	3-2
3-2-2	Stopping Buzzers .....	3-2
3-2-3	Controlling Backlights .....	3-3
3-2-4	Turning OFF Screen Display .....	3-3
3-2-5	Displaying Cleared Screens .....	3-3
3-3	Screen Display and Notification .....	3-5
3-3-1	Switching Screens .....	3-5
3-3-2	Finding Current Screen Numbers .....	3-9
3-4	Changing Numeral and Character String Display .....	3-10
3-4-1	Methods for Changing Numeral and Character String Display .....	3-10
3-5	Displaying Graphs .....	3-15
3-5-1	Changing Graph Displays .....	3-15
3-6	Inputting Numeral and Character Strings .....	3-17
3-6-1	Inputting Numerals .....	3-17
3-6-2	Inputting Character Strings .....	3-20
3-7	Using Alarm/Event Summary History Functions .....	3-22
3-8	Using Operation Log Functions .....	3-26
3-8-1	Settings for Operation Logs .....	3-27
3-8-2	Checking Operation Logs .....	3-27
3-9	Displaying and Setting System Clock .....	3-28
3-9-1	Displaying Date and Time .....	3-28
3-9-2	Setting Date and Time .....	3-28
3-10	Prohibiting and Allowing PT Operation .....	3-29
3-10-1	Prohibiting and Allowing System Menu Movement .....	3-29
3-10-2	Prohibiting and Allowing Input to All Screen Functional Objects .....	3-29
3-10-3	Prohibiting and Allowing Input for Individual Functional Objects .....	3-30
3-11	Using Memory Cards .....	3-31
3-11-1	Transferring Data Using Memory Cards .....	3-31
3-11-2	Saving Alarm/Event Histories to Memory Cards .....	3-31
3-11-3	Saving Data Logs to Memory Cards .....	3-31
3-11-4	Saving Operation Logs to Memory Cards .....	3-32
3-11-5	Saving Error Logs to Memory Cards .....	3-32
3-11-6	Saving Data Blocks to Memory Cards .....	3-32
3-11-7	Saving Captured Images to Memory Cards .....	3-32
3-12	Function Key Settings (NS15 Only) .....	3-33

**Section 4 Using Functions**

4-1 Application ..... 4-1

    4-1-1 When Monitoring Bits Turn ON ..... 4-1

    4-1-2 Always Reading PLC Word Contents ..... 4-6

    4-1-3 Changed Bit Status ..... 4-8

    4-1-4 For Numeral/String Input ..... 4-11

    4-1-5 For Button Operation By User ..... 4-12

    4-1-6 When Screens Are Switched ..... 4-12

**Section 5 Troubleshooting and Maintenance**

5-1 Errors ..... 5-1

5-2 Error Messages ..... 5-6

    5-2-1 Troubleshooting Data Transfers from the CX-Designer ..... 5-6

    5-2-2 Troubleshooting Errors when Turning ON Power ..... 5-9

    5-2-3 Troubleshooting Errors at Startup ..... 5-12

    5-2-4 Troubleshooting Errors when Switching Screens ..... 5-13

    5-2-5 Troubleshooting Errors for Functional Objects ..... 5-15

    5-2-6 Troubleshooting Errors during System Menu Operation ..... 5-16

    5-2-7 Communications Errors and Countermeasures ..... 5-18

    5-2-8 Troubleshooting Macros ..... 5-28

    5-2-9 Troubleshooting Errors with EtherNet/IP Communications ..... 5-30

**Appendices**

Appendix-1 Specifications ..... A-1

    A-1-1 Display Specifications ..... A-1

    A-1-2 Specifications for Display Elements ..... A-5

    A-1-3 Special Functions ..... A-9

Appendix-2 List of Models ..... A-10

    A-2-1 PT Models ..... A-10

Appendix-3 PLC Memory Areas ..... A-12

    A-3-1 OMRON C-series PLC Memory Areas (Same for 1:1 and 1:N NT Links) ..... A-12

    A-3-2 OMRON CVM1 and CV-series PLC Memory Areas ..... A-12

    A-3-3 OMRON CS-series CS1G, CS1H, CS1G-H, and CS1H-H PLC Memory Areas ..... A-13

    A-3-4 OMRON CJ-series CJ1G, CJ1G/H-H, CJ1M, and CJ2H PLC Memory Areas ..... A-14

    A-3-5 List of Areas with Bit Access ..... A-15

Appendix-4 Addresses for Functional Objects ..... A-16

    A-4-1 Using Direct Addresses ..... A-16

    A-4-2 Using Tags ..... A-22

Appendix-5 Controller Link Network Status Read List ..... A-29

Appendix-6 Additional NS Series Functions ..... A-32





# Section 1 Overview

This section provides an outline of the NS-series PTs, including their functions, features, connection types, and communication methods. It gives an understanding of the capabilities of the NS-series PTs.

1-1 NS-series PT Operation .....	1-1
1-2 NS-series PT Functions .....	1-4
1-3 Communicating with the Host .....	1-20
1-4 System Configuration .....	1-28
1-5 Procedure before Operation .....	1-32

# 1-1 NS-series PT Operation

The NS-series Programmable Terminals (PTs) are sophisticated operator interfaces that can automatically display information and perform operations as required at FA production sites. This section describes the role and operations of the NS-series PTs for beginning users.

## 1-1-1 How NS-series PTs Work at FA Production Sites

### Monitoring Line Operating Status

The system and device operating status can be displayed in real time. Graphs can be used to improve visual expressions to display data in an easy-to-understand format.



### Instructions for FA Staff

PTs can be used to notify operators if there is a system or device error and provides information on appropriate countermeasures.

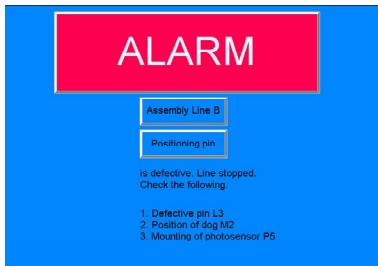

### Replacing Control Panel Switches

NS-series PTs have a touch panel. Buttons and other functional objects on the displayed screen can be operated by touch.

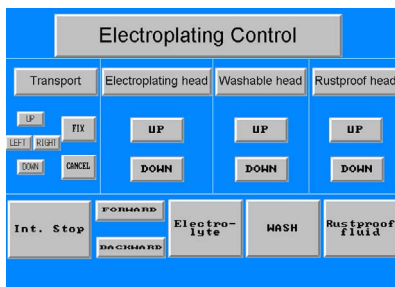

## 1-1-2 NS-series PT Operation

### Displaying Screens

The data to be displayed on the screens (screen data) is created using the CX-Designer on a personal computer and the data is stored in the PT. The required screen can be displayed by a command from the host or by operating the touch switches.

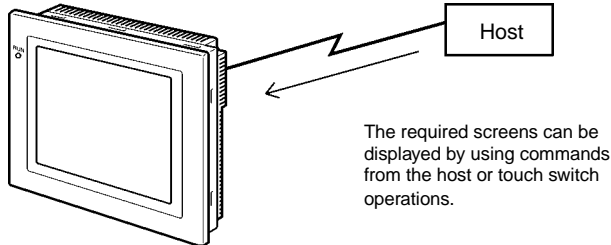

### Reading Data from the Host

NS-series PTs connect to the host using NT Links, Ethernet (for NS15-TX01□-V2, NS12-TS01(B)-V1/-V2, NS10-TV01(B)-V1/-V2, NS8-TV□1(B)-V1/-V2, NS5-SQ□1(B)-V1, NS5-SQ□1(B)-V2, NS5-TQ□1(B)-V2, or NS5-MQ□1(B)-V2), or Controller Link (when Controller Link Interface Unit is installed) communications to automatically read required data from the host.

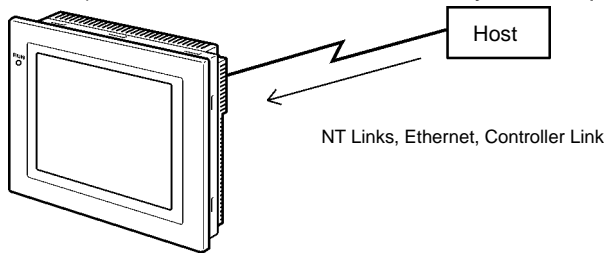

### Sending Data to the Host

Data entered on the touch panel, (button ON/OFF status, numerals, and character strings) can be sent to the host.

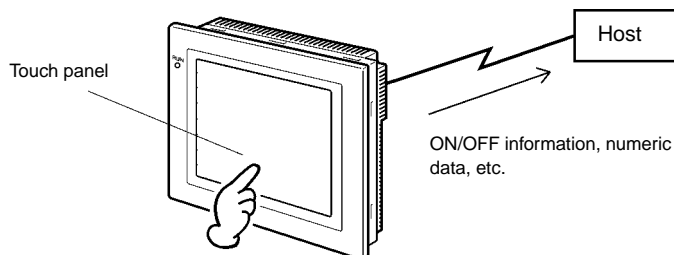

### Screen Data

The screen data displayed on PTs is created using CX-Designer on a personal computer. Screen data is transferred to the PT by connecting the PT and the personal computer using an RS-232C cable, a USB cable, or Ethernet (NS15-TX01□-V2, NS12-TS01(B)-V1/-V2, NS10-TV01(B)-V1/-V2, NS8-TV□1(B)-V1/-V2, NS5-SQ01(B)-V1, NS5-SQ□1(B)-V2, NS5-TQ□1(B)-V2, or S5-MQ□1(B)-V2).

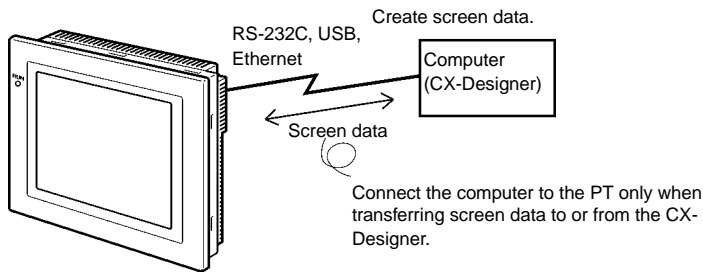

Screen data can also be transferred using Memory Cards.

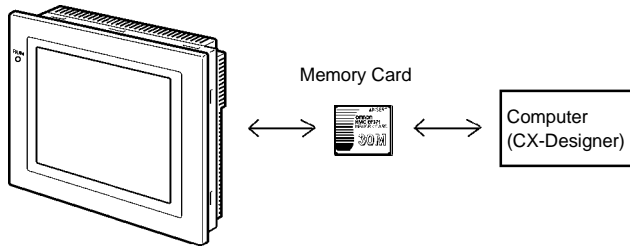

## 1-2 NS-series PT Functions

This section describes the features and main functions of the NS-series PTs.

### 1-2-1 NS-series PT Functions

#### Slim Body

1. Greater sophistication and reduced body thickness (panel depth 40 mm max.). (See note.)
2. Communications cable connectors housed inside Unit to eliminate protruding connectors.

Note: When mounted to a panel of the recommended thickness (1.6 to 4.8 mm).

#### Structure Suitable for FA Environments

1. Uses backlight with twice the life of previous OMRON PTs. (Return the PT to your nearest OMRON service center for replacement (at user expense).
2. IP65F (see note) or NEMA4 equivalent watertight construction.

Note: May not be applicable in environments with long-term exposure to oil.

#### Two standard-feature Ports for Serial Communications, Ports A and B, Enabling Connection to Both CX-Designer and the Host

1. Communications with the host via the other port are possible while still connected to CX-Designer.
2. Bar code data can be read from a bar code reader via the other port while communicating with the host.

#### Ethernet Interface

Ethernet communications with the host are possible for the NS15-TX01□-V2, NS12-TS01(B)-V1/-V2, NS10-TV01(B)-V1/-V2, NS8-TV□1(B)-V1/-V2, NS5-SQ01(B)-V1, NS5-SQ□1(B)-V2, NS5-TQ□1(B)-V2, or NS5-MQ□1(B)-V2.

Ethernet/IP communications with the host are also possible with for the NS15-TX01□-V2, NS12-TS01(B)-V2, NS10-TV01(B)-V2, NS8-TV01(B)-V2, NS5-SQ11(B)-V2, NS5-TQ11(B)-V2, and NS5-MQ11(B)-V2. The project version, however, must be 8.0 or higher. Tag message communications can be used when connected to the CJ2H-CPU□□-EIP or the CJ2M-CPU3□ using EtherNet/IP.

#### Controller Link Interface Unit

Installing a Controller Link Interface Unit enables using a Controller Link Network to send and receive large data packets flexibly and easily among OMRON PLCs and IBM PC/AT or compatible computers.

Note: The Controller Link Interface Unit is supported by the NS15, NS12, and NS10 only.

#### Display Video Images with a Video Input Unit

Installing a Video Input Unit enables displaying images from a video camera or Vision Sensor.

**NS Series Programming Manual**

**High Resolution and Large Display for a Wider Range of Display Possibilities**

Display possibilities have been greatly increased with a larger display and higher resolution.

The NS15-TX01□-V2 uses an 1024-dot horizontal × 768-dot vertical, 256-color, 15.0-inch, bright TFT LCD.

The NS12-TS0□-V1/-V2 uses an 800-dot horizontal × 600-dot vertical, 256-color, 12.1-inch, bright TFT LCD.

The NS10-TV0□-V1/-V2 uses a 640-dot horizontal × 480-dot vertical, 256-color, 10.4-inch, bright TFT LCD.

The NS8-TV□□-V1 uses a 640-dot horizontal × 480-dot vertical, 256-color, 8.0-inch bright TFT LCD.

The NS8-TV0□-V2 uses a 640-dot horizontal × 480-dot vertical, 256-color, 8.4-inch bright TFT LCD.

The NS5-SQ0□-V1/V2 uses a 320-dot horizontal × 240-dot vertical, 256-color, 5.7-inch STN LCD.

The NS5-SQ1□-V2 uses a 320-dot horizontal × 240-dot vertical, 256-color, 5.7-inch bright TFT LCD. (Lot number 2110 or earlier: STN LCD.)

The NS5-TQ□□-V2 uses a 320-dot horizontal × 240-dot vertical, 256-color, 5.7-inch bright TFT LCD.

The NS5-MQ□□-V2 uses a 320-dot horizontal × 240-dot vertical, 16-grayscale monochrome, 5.7-inch bright STN LCD.

For BMP or JPEG images, 32,000-color displays (4,096 colors for the NS5-SQ0□, 16 grayscales for the NS5-MQ) are supported.

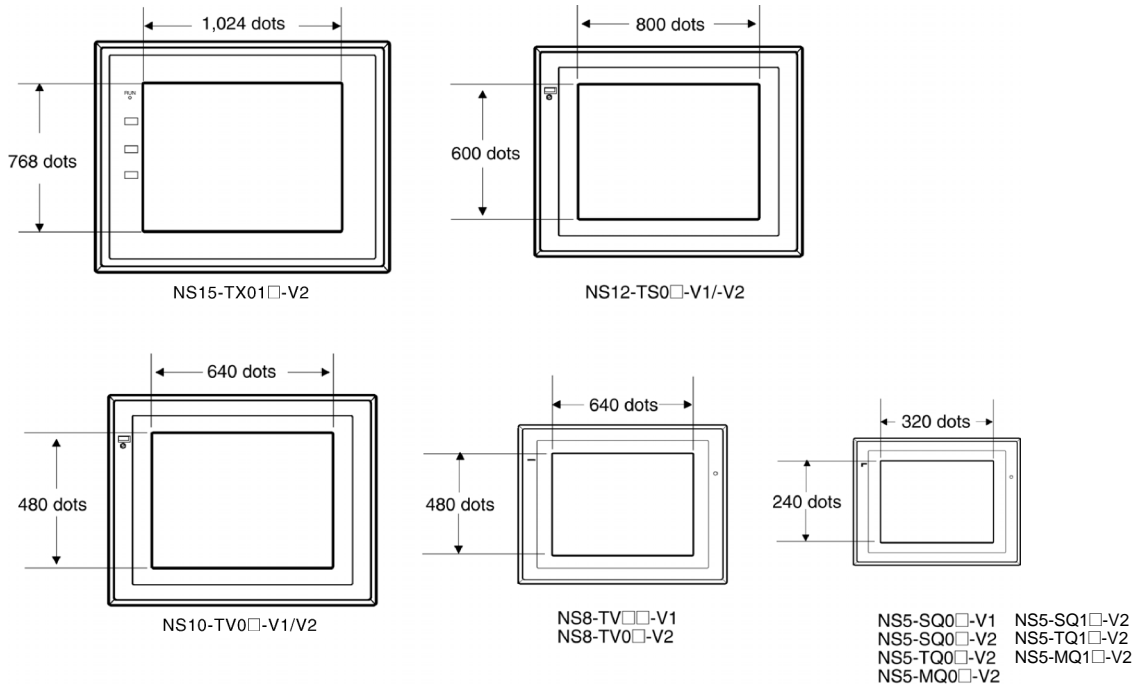

**More Precise Touch Switches**

The NS12-TS0□-V1, NS10-TV0□-V1, NS5-SQ0□-V1, and NS5-SQ/TQ/MQ-V2 touch switches have 16-dot × 16-dot per element resolution and the NS8-TV□□-V1 touch switches have 20-dot × 20-dot per element resolution.

The NS15-TX01□-V2 uses an analog touch panel.

**Fast System Program and Screen Data Replacement Using Memory Cards**

1. Screen data can be written on site simply by mounting an HMC-EF\*\*\* Memory Card on the PT.

2. System programs can also be stored on Memory Cards with NS-series PTs.
3. Operation log data that contains alarm history data, data log data, error log data, functional object operations, screen display history, and macro execution history can be stored on Memory Cards. Data is saved in CSV files, which are easy to use on a personal computer.

### Screen Data Confirmation Function

Screens can be checked even if CX-Designer is not connected, by using the System Menu on the PT.

### Large Increase in Object Capacity

The number of objects that can be registered to screens has been increased dramatically. This allows screens with better display to be created. Refer to *Display Specifications* in *Appendix 1 Specifications* for details.

### Character Display in Windows Fonts

Fonts used in Windows can be used in fixed (text) displays.

### Simple Upgrades

The system program can be replaced using a Memory Card.

### Conforms to International Standards

The PT conforms to UL standards, CSA standards, and EC Directives.

### Multiple Windows

Up to 3 pop-up windows can be displayed at the same time on a normal screen. Commands to switch screens can also be given from the host.

### Strong Processing Functions Using Macros

1. Various instructions are available, including arithmetic operations, bit operations, logic operations, comparison operations, screen controls (open, close, etc.), and object movement.
2. Processing can be performed independently from the host or data from the host can be further processed and the results can be displayed on the screen.
3. Host data processing can be transferred to macros to reduce the load on the host.

### Multiple Label Registration

1. Up to 16 different languages or labels for production lines can be registered on one screen in the NS-series PTs.
2. The displayed label can be switched during operation.

### More than 1,000 Standard Parts

NS-series PTs provide not only touch switches and lamps, but also complicated parts such as toggle switches and 7-segment displays. It is easy to create attractive screens simply by pasting on the CX-Designer.

## 1-2-2 Differences between Models

The NS15, NS12, NS10, NS8, and NS5 have different screen sizes.

Also, some models support only serial communications while others also support communications via the Ethernet.

Model	Color	Display panel	Ethernet
NS15-TX01S-V2	Silver	15.0-inch bright TFT	10/100Base-T
NS15-TX01B-V2	Black	15.0-inch bright TFT	10/100Base-T
NS12-TS00-V1	Ivory	12.1-inch bright TFT	Not available
NS12-TS00B-V1	Black	12.1-inch bright TFT	Not available
NS12-TS01-V1	Ivory	12.1-inch bright TFT	10/100Base-T
NS12-TS01B-V1	Black	12.1-inch bright TFT	10/100Base-T
NS10-TV00-V1	Ivory	10.4-inch bright TFT	Not available
NS10-TV00B-V1	Black	10.4-inch bright TFT	Not available
NS10-TV01-V1	Ivory	10.4-inch bright TFT	10/100Base-T
NS10-TV01B-V1	Black	10.4-inch bright TFT	10/100Base-T
NS8-TV□0-V1	Ivory	8.0-inch bright TFT	Not available
NS8-TV□0B-V1	Black	8.0-inch bright TFT	Not available
NS8-TV□1-V1	Ivory	8.0-inch bright TFT	10/100Base-T
NS8-TV□1B-V1	Black	8.0-inch bright TFT	10/100Base-T
NS12-TS00-V2	Ivory	12.1-inch bright TFT	Not available
NS12-TS00B-V2	Black	12.1-inch bright TFT	Not available
NS12-TS01-V2	Ivory	12.1-inch bright TFT	10/100Base-T
NS12-TS01B-V2	Black	12.1-inch bright TFT	10/100Base-T
NS10-TV00-V2	Ivory	10.4-inch bright TFT	Not available
NS10-TV00B-V2	Black	10.4-inch bright TFT	Not available
NS10-TV01-V2	Ivory	10.4-inch bright TFT	10/100Base-T
NS10-TV01B-V2	Black	10.4-inch bright TFT	10/100Base-T
NS8-TV00-V2	Ivory	8.4-inch bright TFT	Not available
NS8-TV00B-V2	Black	8.4-inch bright TFT	Not available
NS8-TV01-V2	Ivory	8.4-inch bright TFT	10/100Base-T
NS8-TV01B-V2	Black	8.4-inch bright TFT	10/100Base-T
NS5-SQ00-V1	Ivory	5.7-inch STN	Not available
NS5-SQ00B-V1	Black	5.7-inch STN	Not available
NS5-SQ01-V1	Ivory	5.7-inch STN	10/100Base-T
NS5-SQ01B-V1	Black	5.7-inch STN	10/100Base-T
NS5-SQ00-V2	Ivory	5.7-inch STN	Not available
NS5-SQ00B-V2	Black	5.7-inch STN	Not available
NS5-SQ01-V2	Ivory	5.7-inch STN	10/100Base-T
NS5-SQ01B-V2	Black	5.7-inch STN	10/100Base-T
NS5-SQ10-V2 (See note.)	Ivory	5.7-inch TFT	Not available
NS5-SQ10B-V2 (See note.)	Black	5.7-inch TFT	Not available
NS5-SQ11-V2 (See note.)	Ivory	5.7-inch TFT	10/100Base-T
NS5-SQ11B-V2 (See note.)	Black	5.7-inch TFT	10/100Base-T
NS5-TQ00-V2	Ivory	5.7-inch bright TFT	Not available
NS5-TQ00B-V2	Black	5.7-inch bright TFT	Not available
NS5-TQ01-V2	Ivory	5.7-inch bright TFT	10/100Base-T
NS5-TQ01B-V2	Black	5.7-inch bright TFT	10/100Base-T



### NS Series Programming Manual

Model	Color	Display panel	Ethernet
NS5-TQ10-V2	Ivory	5.7-inch bright TFT	Not available
NS5-TQ10B-V2	Black	5.7-inch bright TFT	Not available
NS5-TQ11-V2	Ivory	5.7-inch bright TFT	10/100Base-T
NS5-TQ11B-V2	Black	5.7-inch bright TFT	10/100Base-T
NS5-MQ00-V2	Ivory	5.7-inch monochrome STN	Not available
NS5-MQ00B-V2	Black	5.7-inch monochrome STN	Not available
NS5-MQ01-V2	Ivory	5.7-inch monochrome STN	10/100Base-T
NS5-MQ01B-V2	Black	5.7-inch monochrome STN	10/100Base-T
NS5-MQ10-V2	Ivory	5.7-inch monochrome STN	Not available
NS5-MQ10B-V2	Black	5.7-inch monochrome STN	Not available
NS5-MQ11-V2	Ivory	5.7-inch monochrome STN	10/100Base-T
NS5-MQ11B-V2	Black	5.7-inch monochrome STN	10/100Base-T

Note: The specifications of NS5-SQ1□-V2 PTs with lot number 2110 (manufactured January 21, 2010) or earlier are given below.

Item	Specification
Display panel	Color STN LCD
Display colors	256 colors (4,096 colors for BMP/JPEG images)
View angle	Left: 50°, Right: 50°, Top: 45°, Bottom: 50°

## 1-2-3 Main NS-series Functions

The NS-series PTs have the following main functions.

### Display Functions

#### Screen Displays

Large, high - resolution screen with many graphic functions.

1024 x 768 - dot (horizontal x vertical), 256 - color, 15.0-in, bright TFT LCD  
NS15-TX01□-V2

800 x 600 - dot (horizontal x vertical), 256 - color, 12.1-in, bright TFT LCD  
NS10-TV0□-V1/-V2

640 x 480 - dot (horizontal x vertical), 256 - color, 10.4-in, bright TFT LCD  
NS8-TV□□-V1

640 x 480 - dot (horizontal x vertical), 256 - color, 8.0-in, bright TFT LCD  
NS8-TV0□-V2

640 x 480 - dot (horizontal x vertical), 256 - color, 8.4-in, bright TFT LCD  
NS5-SQ0□-V1/-V2

320 x 240 - dot (horizontal x vertical), 256 - color, 5.7-in, STN LCD  
NS5-SQ1□-V2 (See note.)

320 x 240 - dot (horizontal x vertical), 256 - color, 5.7-in, TFT LCD  
NS5-TQ□□-V2

320 x 240 - dot (horizontal x vertical), 256 - color, 5.7-in, bright TFT LCD  
NS5-MQ□□-V2

320 x 240 - dot (horizontal x vertical), 5.7-in, 16-grayscale monochrome  
STN LCD

#### Characters

Display characters at various sizes. Characters can be flashed or character colors can be changed.

#### Fixed Objects

Lines, poly lines, rectangles, polygons, circles, oval, arcs, and sectors can be displayed. Objects can be filled in various colors and flashed.

#### Internal Memory Data

The contents of registers in internal memory (\$B, \$W, \$HB, \$HW, \$SB, and \$SW) can be displayed.

#### Graphs

Bar graphs, analog meters, broken - line graphs, and trend (data logging) graphs are supported.

#### Lamps

Lamps controlled by the host can be lit or flashed. Different graphics can be used for lit and not lit status.

#### Alarms/Events

Host bit status can be used to automatically display messages and related information (e.g., time stamps).

Alarms and events can be displayed one line at a time, in lists, or in histories.

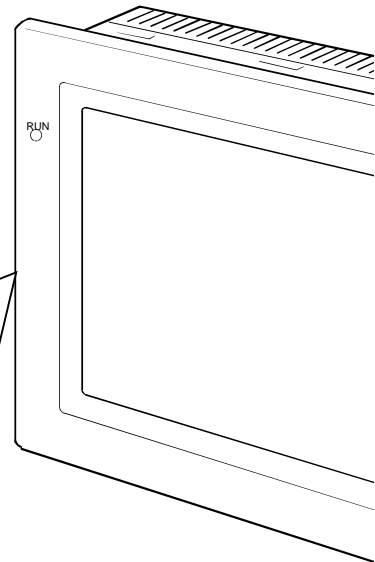

Note: Lot number 2110 or earlier use an STN LCD.

### Communications Functions: Host Communications

Any of five communications methods can be used: 1:1 NT Links, 1:N NT Links (standard or high speed), Ethernet, Ethernet/IP (Ethernet: NS15-TX01□-V2, NS12-TS01(B)-V1/-V2, NS10-TV01(B)-V1/-V2, NS8-TV□1(B)-V1/-V2, NS5-SQ01(B)-V1, NS5-SQ□1(B)-V2, NS5-TQ□1-V2, and NS5-MQ□1-V2), or Controller Link. Host data can be read and displayed, and data can be input and sent to the host, for buttons, numeral display and input objects, and character display and input objects.

### Output Functions: Buzzer

The buzzer in the PT can be controlled

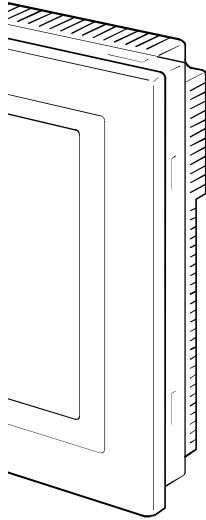

#### Input Functions

##### **Inputting via Touch Switches**

Buttons can be displayed easy input by touching the screen. Input functions include sending data to the host and switching the display screen.

##### **Pop-up Windows**

Windows that overlap the current screen can be opened, closed, and moved. Various objects can be registered for pop-up windows, and up to three pop-up windows can be displayed at the same time. Accessing the required windows when needed enables more effective use of screens.

##### **Numeral/Character String Input**

Touch switches can be used to input numerals and character strings. The input data can be sent to the host, and inputs can also be prohibited using controls from the host.

##### **Bar Code Reader Inputs**

Data read from bar code readers can be input to character string display and input objects.

##### **Control Flags**

Allocating host addresses to control bits enables controlling display of functional objects and enabling or disabling input functions from the host.

#### System Functions

##### **System Menu**

System setting and maintenance are performed from the system menu displayed on the screen.

##### **Creating Screen Data**

The CX-Designer running on a personal computer is used to create screen data and record it in memory built into the PT. Screen data can also be saved on Memory Cards in the PT.

##### **Screen Saver**

A screen saver increases the life of the backlight.

##### **Built-in Clock**

The built-in clock enables displaying dates and times.

##### **Device Monitor Function**

When connected to a PLC via a 1:1 NT Link, 1:N NT Link, or Ethernet, the PLC's operating mode can be changed, words in the PLC can be read or written, error information can be written, etc.

##### **Data Transfers**

Screen data and system programs can be transferred by the Transfer Data function on the CX-Designer or by using Memory Cards. Data can also be transferred to the PT through a PLC and ladder program data, for example, can be transferred through a PT to a PLC.

##### **Operation Logging and Alarm/Event History**

A history can be kept of screen switches, functional object operation, and macro execution. The times and frequency that specific addresses turn ON can also be kept in a history.

##### **Data Logging for Trend Graphs and Background Execution**

The contents of addresses displayed for trend graphs can be logged, even while the graph is not being displayed (background execution).

##### **Macros**

Calculations data can be set as screen data to perform calculations at specific times during PT operation. Calculations include arithmetic, bit operations, logic operations, and comparisons. Various commands are also provided, e.g., to move objects or pop-up windows, manipulate character strings, etc.

##### **Starting External Applications**

Ladder monitor or other applications can be started from the system menu.

##### **Printing**

Screens can be printed out on a printer connected with an USB cable NS15, NS12, NS10, NS8, or NS5-□□1□-V2 only.

##### **Programming Console Function**

The PT can perform Programming Console functions by placing a Memory Card containing a program into the PT.

##### **NS Switch Box**

The comments of a specified PLC address can be displayed and data at the address can be monitored or changed.

### 1-2-4 NS-series Displays

A variety of elements can be displayed on one screen, including character strings, numerals, graphs, lamps, and buttons. The screen data displayed on NS-series PTs is created using CX-Designer.

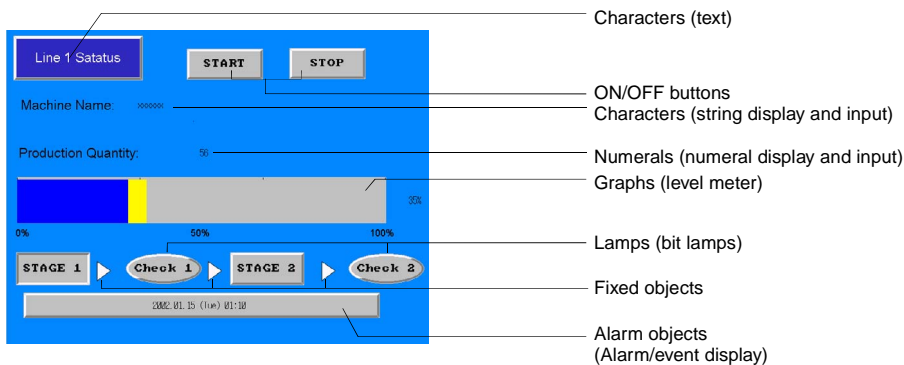

#### Fixed Objects

A fixed object is merely graphic data displayed on the screen. Unlike functional objects, fixed objects cannot exchange data with the host, execute operations, or change display attributes (except for flickering). There are seven types of fixed objects: Lines, circles/ovals, arcs, sectors, polylines, polygons, and rectangles.

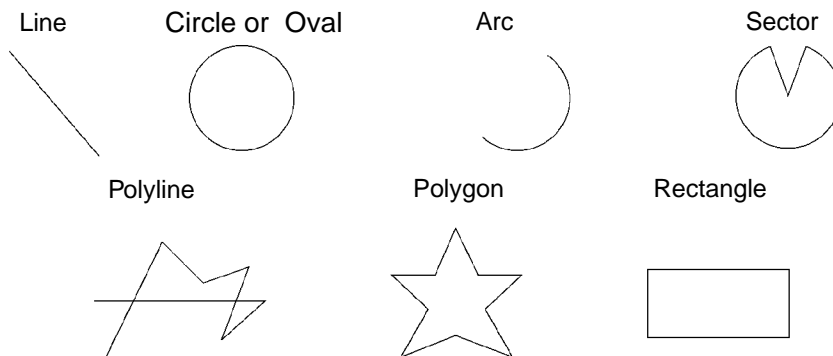

#### Buttons

Buttons can be registered to the screens as required. There are three types of buttons: ON/OFF buttons, word buttons, and command buttons. The following functions can be executed by touching the buttons on the screen.

- Turn bits ON or OFF (ON/OFF buttons).
- Write numerals to words (word buttons).
- Switch the displayed screen (command buttons).
- Transfer numeral or character string data (command buttons).
- Open, close, or move pop-up screens (command buttons).
- Display the System Menu (command buttons).
- Stop the buzzer (command buttons).

Buttons can be lit depending on the status of the allocated address.

Also, inputs from the host can be controlled (enabled or disabled) by allocating the address of a control flag.

There are three display shapes for buttons: Rectangle, select shape (ON/OFF buttons and word buttons), and circle (for ON/OFF buttons only). When the select shape option is used, the display shape is specified for the ON and OFF status of the allocated address.

There are two types of button labels: Fixed string display and ON/OFF switch display (for ON/OFF buttons only). In addition, the label can be displayed on multiple lines.

**Lamps**

There are two types of functional objects, bit lamps and word lamps, that change the display status depending on the status of the allocated address.

The color and shape of the lamps can be changed depending on the ON/OFF status of bits for bit lamps or the contents of words for word lamps.

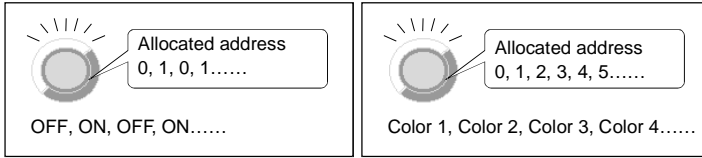

Bit lamp

Word lamp

Fixed character strings can be displayed as lamp labels. In addition, multiple lines can be displayed.

**Numeral Display and Input**

Numerals stored at the allocated address can be displayed and data can be input to the allocated address. Four different data formats can be displayed as required, including decimal and hexadecimal, and data can be stored as required in any of eleven data formats, including signed integers and BCD. Host values can be converted and displayed at a specified scale or displayed with units, such as mm or g.

Also, inputs from the host can be controlled (enabled or disabled) by assigning the address of a control flag.

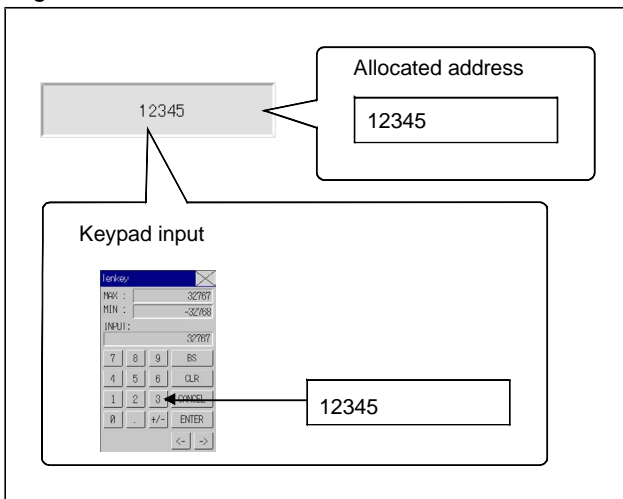

**NS Series Programming Manual**

**String Display and Input**

Character string data stored at allocated addresses can be displayed and can be input to the address. Bar code data can be read using a bar code reader.

Also, inputs from the host can be controlled (enabled or disabled) by allocating the address of a control flag.

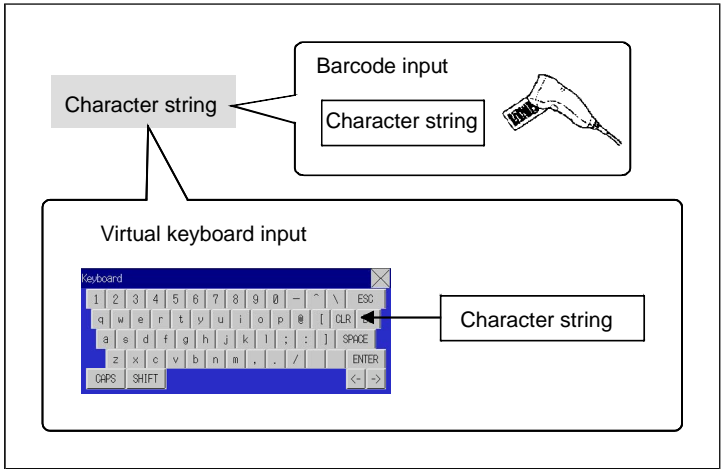

**Thumbwheel Switches**

The numerical contents of the allocated address can be input by incrementing or decrementing the numeral using the + and – buttons for each digit.

Also, inputs from the host can be controlled (enabled or disabled) by allocating the address of a control flag.

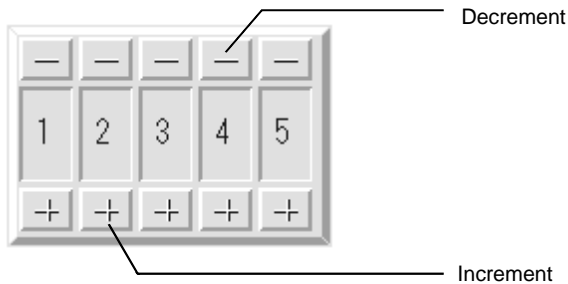

**List Selections**

Allocated addresses or character string data stored in text files can be displayed in a list and specific character strings can be specified from the list.

Also, inputs from the host can be controlled (enabled or disabled) by allocating the allocated address of a control flag.

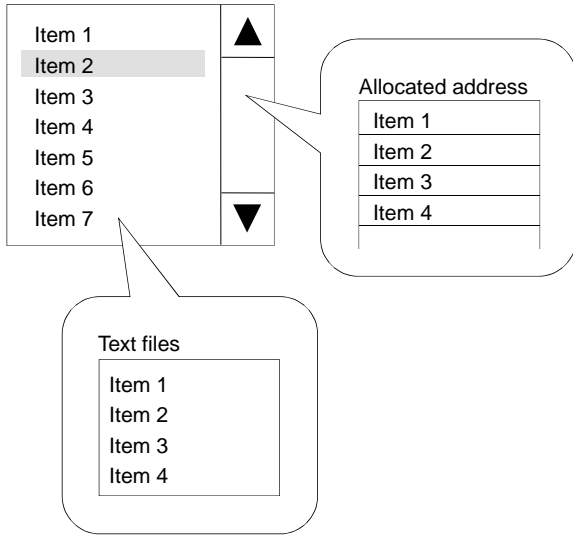

**Text**

Preset character strings can be displayed.

Display characters can also be changed.

The following three methods are available for changing displayed characters.

- Indirect Specification From a Text File  
A list of character strings to be displayed can be stored in a text file and any character string in the text file can be specified for display.
- Indirect Specification From a Character String Table  
Any character string can be specified for display from preset character strings in a character string table.
- Message Indicator Function  
Character strings and background colors to be displayed can be registered for each status number and any registered status can be specified for display.

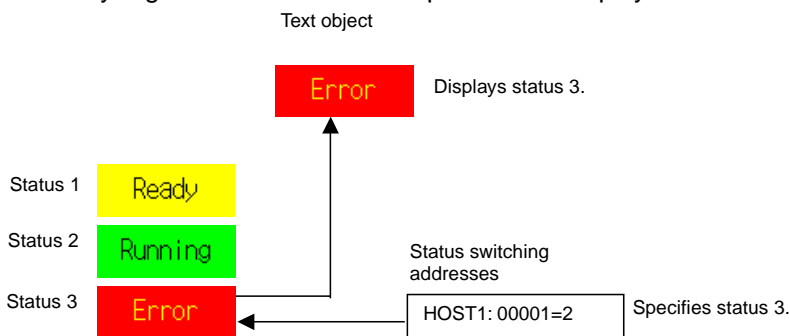

**Bitmaps**

Bitmaps are functional objects that display bitmap files or JPEG files. Complex pictures or photographic images that cannot be drawn can be displayed on the screen. The display can also switch among different images depending on the contents of the specified address.

**Level Meters**

The current value of the allocated address can be displayed by coloring the specified range. The dis-

play direction (up, down, left, or right), different color for each specified range, and whether or not scaling will be used can be set.

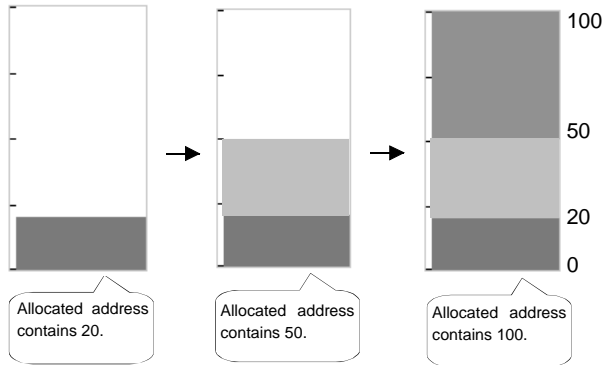

### Analog Meters

An analog meter displays the current value for the allocated address by coloring regions or by means of a needle. The shape can be selected from a quarter circle, semi-circle, and full circle.

The display direction (up, down, left, or right), incremental direction for the meter (clockwise or anti-clockwise), and whether or not scaling will be used can be set.

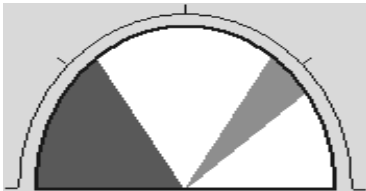

### Broken-line Graphs

Broken-line graphs display the present values for multiple consecutive allocated addresses on one graph.

Up to 256 line graphs can be displayed in one broken-line graph display region.

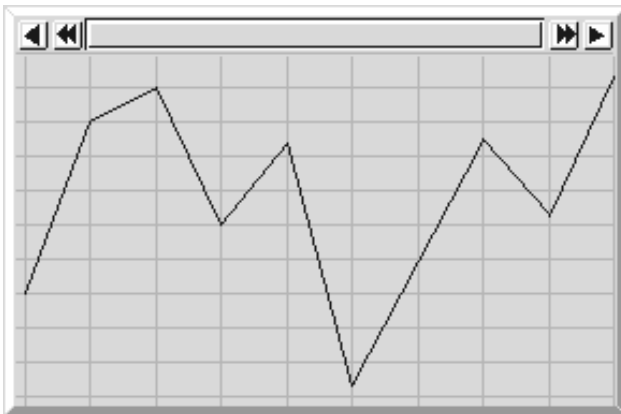

### Data Log Graphs

The data log function saves changes over time in the contents of the allocated address. The saved data can be displayed for each data logging group.

Data can be read (sampled) even if the data log graph is not displayed.



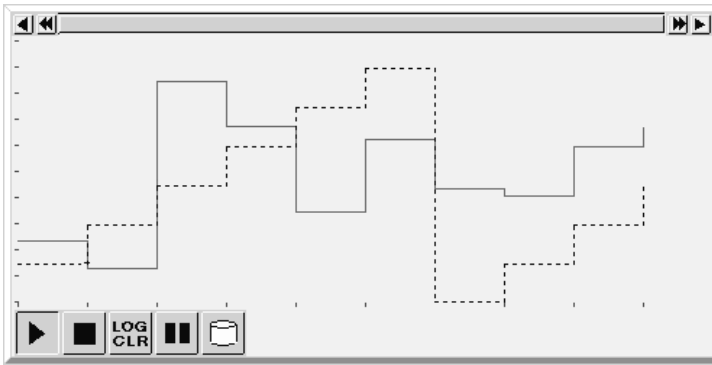

**Alarms and Events**

The alarm/event function reports alarms based on changes in bit status. There are two functional objects: Alarm/event displays and alarm/event summary and history.

Alarm/event display objects display a pre-registered message and the date and time of the alarm or event when the monitored bit turns ON.

Either one message or multiple messages (using the flowing string function) can be displayed.

The alarm/event summary and history functional object displays a list of messages. The display order can be switched between displaying in order of occurrence, order of frequency, and by alarm level. Also, the history and data to be displayed when an alarm is generated can be selected.

**System Clock**

The system clock displays the current date and time. The date and time can also be changed.

**Data Blocks**

Data blocks (recipes) enable reading/writing values and character strings from/to memory areas, such as those in a PLC. Data blocks can be used to easily change the setup of the system. Create the data in a CSV file and store it in the PT beforehand. This data can be changed while operating the PT.

Example: Setting width (numeric value), height (numeric value), and color (character string) in the PLC. (Refer to the figure shown below.)

Set width: 150, height: 54, and color: blue for product B. Just select product B to set these three items in the PLC. If product A is selected a width for 100, a height of 52, and a color of red are set in the PLC.

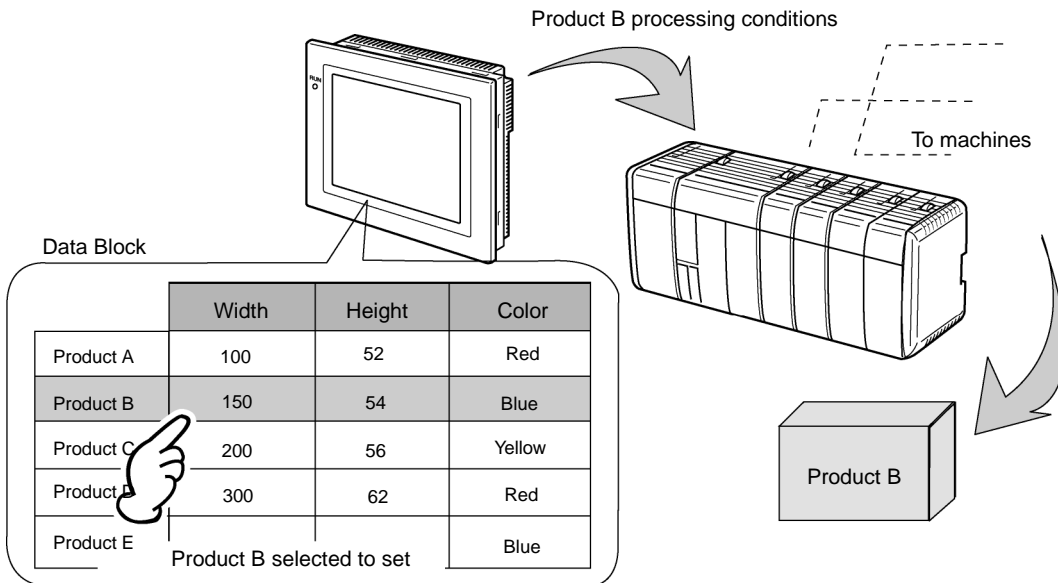

Using data blocks, users do not need to save data in the PLC beforehand, so that the memory of the PLC can be saved and the ladder program can be reduced. Data blocks also have the following features.

- Data in CSV format can be edited and managed on a computer.
- Data can be edited on the PT.
- Data can be written to a Memory Card.
- Data from read from a Memory Card.
- Process values and character strings can be handled.
- Maximum number of rows: 1,000. Maximum number of columns: 500. Data blocks with both 1,000 rows and 500 columns, however, cannot be set.

## Video Displays

Installing a Video Input Unit (NS-CA001) on the NS12, NS10, or NS8 enables displaying images output from video devices, such as video cameras or Vision Sensors, to be displayed on the PT. Up to four video devices can be connected to the PT. There are two input methods: NTSC and PAL.

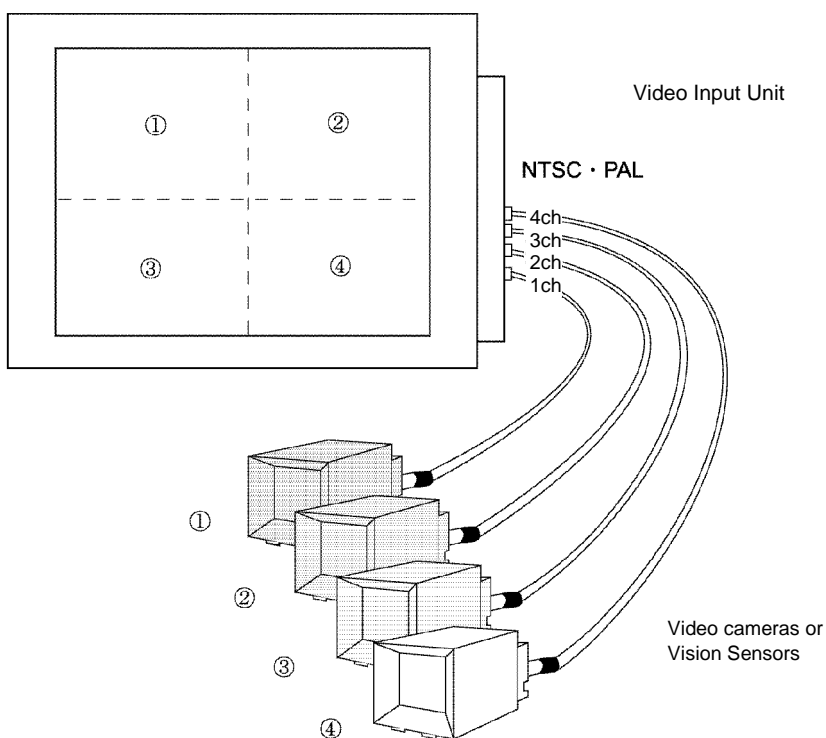

With an NS15,\* NS12, NS10, or NS8 PT, an NS-CA002 RGB/Video Input Unit can be mounted to display receive an external video or RGB signal for display on the NS-series PT.

\*: Video inputs cannot be used with the NS15 PT. Only analog RGB inputs can be used.

## Consecutive Line Drawing

Polylines can be drawn by using the contents of communications addresses as coordinates of the vertex points. These shapes differ from regular polylines because the shapes can be changed actively.

**NS Series Programming Manual**

The communications address' values specify each vertex's X and Y coordinates.

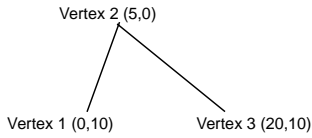

Value of communications address 1: 0  
Value of communications address 2: 10 } Coordinates of vertex 1  
Value of communications address 3: 5  
Value of communications address 4: 0 } Coordinates of vertex 2  
Value of communications address 5: 20  
Value of communications address 6: 10 } Coordinates of vertex 3

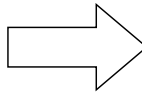

Vertices change as the values of the communications addresses change.

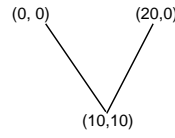

Value of communications address 1: 0  
Value of communications address 2: 0  
Value of communications address 3: 10  
Value of communications address 4: 10  
Value of communications address 5: 20  
Value of communications address 6: 0

**Multifunction Objects**

Multifunction Objects are functional objects that can execute multiple functions in order with a one-touch operation.

The set functions are executed one after the other when the Multifunction Object is pressed or the value at a specified address changes. Up to 32 functions can be set for each execution condition.

The Multifunction Object function enables operations that were performed using a combination of macros and multiple functional objects to be performed in one operation.

Executed in one operation.

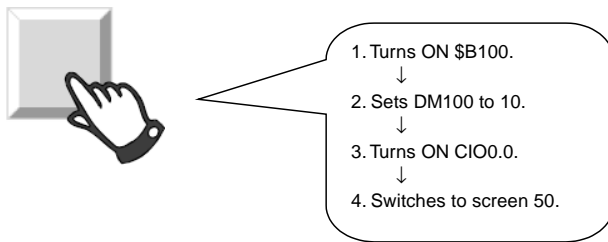

\* Safety functions can be set as an execution condition for when the Multifunction Object is pressed, e.g., Double Press, ON Delay, OFF Delay, and Prohibit Simultaneous Press

**Contents Display**

Contents Display is a functional object that switches character string and image file display according to its status. Character string displays and image files are indicated by the term "contents" and settings for switching display is referred to as the settings for switching contents.

The character string and image combinations and the communications address for switching display for each status (i.e., each contents number) are made in the settings for switching contents.

Contents display switches the displayed character string/images according to the specified communications address. The contents display can also be switched in connection with any alarms/events that occur or are cleared.

**Example Settings for Switching Contents**

Contents No.	Contents	
	String	Image
0	Close the front cover.	Manual1.bmp
1	Replace the battery.	Manual2.bmp

**NS Series Programming Manual**

Contents switching address value: 0

Character string ———— Close the front cover.

Manual1.bmp ———— 

Displays the character string and image registered to contents number 0.



Contents switching address value: 1

The battery must be replaced.

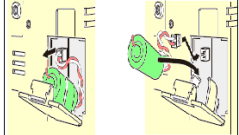

Switches to display the character string and image registered to contents number 1.

## 1-3 Communicating with the Host

### 1-3-1 Host Registration and Address

With NS-series PTs, data required for display can be accessed and the words and bits where the entered data will be stored can be allocated to any area in the PLC.

The allocated words and bits are read from and written to directly, the display status changed for the objects on the PT screen, and the PT status controlled or reported.

Communications with multiple PLCs are also possible with NS-series PTs. Host names are registered for the connected PLCs and any area in the PLC can be accessed by specifying the host name and address. Connect to the host using one of the following methods.

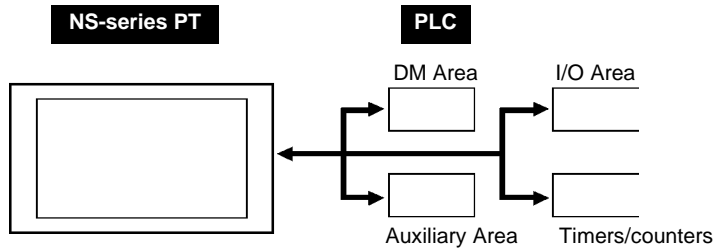

- 1:1 NT Link
- 1:N NT Links (standard, high speed)
- Ethernet
- Controller Link (When Controller Link Interface Unit is installed.)
- Host Link
- Temperature Controller Connection
- Memory Link
- Connection with PLCs and other devices from other manufacturers.
- EtherNet/IP

Up to 100 registrations are possible for hosts.

Refer to the *Host Connection Manual: Temp. Control, MemLink* for details on Temperature Controller connections and Memory Links. Refer to the *Host Connection Manual: Multivendor Connection* for details on connecting to another company's PLC.

### 1-3-2 Ethernet

Hosts connected on the Ethernet can communicate with devices that support FINS (Factory Interface Network Service) messages. FINS is a standard OMRON communications service. NS-series PTs can read and write data, word contents, and bit status from supported PLC Ethernet Units without having to be concerned about protocols.

The following PLCs can be connected using Ethernet.

CS1G/CS1H-E(V1), CS1G/CS1H-H, CVM1/CV, CJ1G, CJ1G-H/ CJ1H-H, CJ1M, CP1H, CP1L, CJ2H, and CJ2M.

### 1-3-3 Controller Link

The Controller Link is an FA network that can send and receive large data packets among OMRON PLCs and IBM PC/AT or compatible computers. The Controller Link supports data links that enable data sharing and a message service that enables sending and receiving data when required.

The following PLCs can be connected using Controller Link: CS1G/CS1H-E(V1), CS1G/CS1H-H, CVM1/CV, C200HX/HG/HE(-Z), and CVM1(-V2), CQM1, CJ1G, CJ1G-H/ CJ1H-H, CJ1M, CJ2H, and CJ2M.

Note: The Controller Link Interface Unit is supported by the NS15, NS12, and NS10 only.

### 1-3-4 NT Links

The NT Link protocol was specially designed to enable high-speed communications with OMRON PLCs.

The following PLCs can be connected using NT Links.

CPM1A, CPM2A, CPM2C, CQM1, CQM1H, C200HS, C200HX/HG/HE-E/-ZE, CS1G/CS1H-E(V1), CS1G/CS1H-H, CVM1/CV (V1 or later), CJ1G, CJ1G-H/ CJ1H-H, CJ1M, CP1H, CP1L, CP1E, CJ2H, and CJ2M

In addition to the 1:1 NT Links, where one PT serial port is connected to one PLC, NS-series PTs can also use the 1:N NT Links, where up to eight PTs are connected to one PLC.

The following PLCs can be connected using a 1:N NT Links.

CQM1H, C200HX/HG/HE-E/-ZE, CS1G/CS1H-E(V1), CS1G/CS1H-H, CJ1G, CJ1G-H/ CJ1H-H, CJ1M, CP1H, CP1L, CP1E, CJ2H, and CJ2M.

NS-series PTs also support a high-speed 1:N NT Link that allows faster communications. The following PLCs can be connected using a high-speed 1:N NT Links.

CS1G/CS1H (V1 or later), CS1G/CS1H-H, CJ1G, CJ1G-H/ CJ1H-H, CJ1M, CP1H, CP1L, CP1E, CJ2H, and CJ2M.

In later sections, the term “NT Link” will be used when describing the NT Link communications method in general, “1:1 NT Link” will be used when describing the 1:1 NT Link connection method only, and “1:N NT Link” will be used when describing the 1:N NT Link connection method only. Furthermore, differentiation will be made between standard and high-speed 1:N NT Links when required. If only “1:N NT Link” is noted, the description will refer to both standard and high-speed 1:N NT Links.

#### NT Link Features

NT Links have the following features.

1. NT Links facilitate high-speed communications with PLCs. The high-speed 1:N NT Link, which enables even faster communications, is also supported.
2. Data can be written to PLC memory areas in bit units. This allows other bits in the word to which a touch switch has been allocated to be used for another applications, such as lamp allocations. However, data is written in word units only in the DM and EM Areas, so other bits in the word to which touch switches are allocated cannot be used for other applications in these memory areas.
3. NS-series PTs can be connected without switching PLC operating modes.
4. Up to eight PTs can be connected to one PLC port when 1:N NT Links are used and all ports can be used simultaneously. Up to eight ports can be used simultaneously for high-speed 1:N NT Links also.  
Normal 1:N NT Links and high-speed 1:N NT Links cannot, however, both be used on the same PLC port.
5. If a Communications Board is mounted in the CPU Unit option slot on a C200HX/HG/HE-E/-ZE PLC, up to three standard 1:N NT Link systems (up to 24 PTs) can be connected. Only standard 1:N NT Link connections can be made. Refer to the *C200HX/HG/HE Communications Boards Operation Manual (W304-E1-□)* for information on Communications Boards.
6. If a Serial Communications Board is mounted in the CPU Unit Inner Board slot on CQM1H PLCs, up to two standard 1:N NT Link systems (up to 16 PTs) can be connected. Only standard 1:N NT Link connections can be made. Refer to *CQM1H Serial Communications Board Operation Manual (W365-E1-□)* for information on Serial Communications Boards.
7. If a Serial Communications Board is mounted to the CPU Unit Inner Board slot or a Serial Communications Unit is mounted to the Backplane of a CS1G/H or CS1G/H PLC, multiple standard or high-speed 1:N NT Link systems can be connected. Refer to *CS/CJ Series Serial Communications Boards and Unit Operation Manual (W336-E1-□)* for information on Serial Communications Boards and Serial Communications Units.
8. If the PLC supports the device monitor function, the PLC operating mode can be switched from the PT and the present values of words can be displayed or changed.

### 1-3-5 Host Link

The Host Link method uses a 1:1 connection between the host and a PT to read and display word and bit data from the host. Many PLC models can be connected using Host Link.

The following PLCs can be connected to NS-series PTs using Host Link. The PLCs are connected via their built-in serial port or a Host Link Unit supported by the PLC.

C Series

C200HS, C200HX/HG/HE(-Z), CQM1, CQM1H, CPM2A/CPM2C, CPM1/CPM1A, C500, C1000H, and C2000H

CV Series

CV500, CV1000, CV2000, and CVM1

CS/CJ Series

CS1G/CS1H, CS1G-H/CS1H-H, CJ1G, CJ1G-H/CJ1H-H, CJ1M, CP1H, CP1L, CJ2H, and CJ2M

Refer to *Host Connection Manual: Host Link* for details on Host Link communications settings.

### 1-3-6 EtherNet/IP

EtherNet/IP is an industrial multivendor network protocol that uses Ethernet. The specification is an open standard managed by the ODVA (Open DeviceNet Vendors Association) as is DeviceNet, and it is used for a variety of industrial devices. With NS-series PTs, communications can be performed with CS/CJ-series EtherNet/IP Units and CJ2H-CPU□□-EIP or CJ2M-CPU3□ Units with a built-in EtherNet/IP port.

Also, it is possible to perform tag message communications when using a CPU Unit with a built-in EtherNet/IP port. These CPU Units contain a tag name server, so if tag names and an address table are stored in advance in the CPU Unit, it is possible to perform access from the NS-series PT using only the tag names.

### 1-3-7 PT Memory

PT memory is made up of internal memory and system memory.

#### Internal Memory

The internal memory in the PT can be read and written by the user. Internal memory can be allocated as required for settings, such as the addresses for functional objects.

The internal memory is divided into four sections.

Memory	Contents
\$B	Bit Memory Bit memory is used for I/O flags and signal information. Up to 32 Kbits (32,768 bits).
\$W	Word Memory Word memory is used to store numeral and character string data. Each word contains 16 bits, but consecutive words can be used as required for character strings and 32-bit data. Up to 32 Kwords (32,768 words).
\$HB	Internal Holding Bit Memory Internal Holding Bit Memory is used for I/O flags and signal information. Up to 8 Kbits (8,192 bits) can be used. Values are held even when the power supply to the PT is turned OFF.
\$HW	Internal Holding Word Memory Internal Holding Word Memory is used to store numeral and character string data. Each word contains 16 bits, and consecutive words can be used as required for character strings and 32-bit data. Up to 8 words (8,192 words) can be used. Values are held even when the power supply to the PT is turned OFF.

**Reference**

- ◆ Internal memory cannot be read and written from the host.

**System Memory**

System memory is used to change information between the host and the PT, such as controlling the PT and notifying the host of PT status.

The system memory is divided into two sections.

Memory	Contents
\$SB	System Bit Memory The system bit memory contains 64 bits with predefined functions.
\$SW	System Word Memory The system word memory contains 41 words with predefined functions.

The functions for each \$SB and \$SW address are outlined on the following tables.

**Reference**

- ◆ System memory can be allocated as host addresses or as internal memory. Refer to the **System Settings and Project Properties** in the *CX-Designer Online Help* for details on setting methods.
- ◆ The NS-series PT will automatically update the system memory wherever it is allocated. The update timing will be different depending on whether \$SB or \$SW is used directly or whether an address in the allocated memory is used.

**\$SB**

Address	Operation	Classification
0	Operation Signal (Pulse) Repeatedly turns ON and OFF during PT operation.	NS status notification
1	Operation Signal (Always ON) Always ON during operation.	
2	Screen Switch Strobe ON: Switches screen, OFF: System turns OFF automatically after screen switched.	
3	System Menu Change Prohibit (ON: Prohibited, OFF: Enabled)	NS status control
4	Battery Low	NS status notification
5	Numeral and Character Input Detection ON: Inputting, OFF: Not inputting	NS status notification
6	Backlight Brightness Adjustment (High) (Adjusted when ON.)	NS status control
7	Backlight Brightness Adjustment (Middle) (Adjusted when ON.)	
8	Backlight Brightness Adjustment (Low) (Adjusted when ON.)	
9	Backlight Control (Screen Saver Start/Cancel)	NS status control
10	Backlight Flash Control ON: Flash, OFF: Lit	NS status control
11	Backlight Status ON: Not lit, OFF: Lit	NS status notification
12	Continuous Buzzer (ON: Buzzer ON, OFF: Buzzer OFF)	NS status control



## NS Series Programming Manual

Address	Operation	Classification
13	Short Intermittent Buzzer (ON: Buzzer ON, OFF: Buzzer OFF)	
14	Long Intermittent Buzzer (ON: Buzzer ON, OFF: Buzzer OFF)	
15	Notification/Control of Video	NS status notification and control
16	Port A NT Link Priority Registration (for 1:N)	NS status control
17	Port B NT Link Priority Registration (for 1:N)	
18	Ten Key Pad Display with Temporary Input	NS status control
19	Input Disable (ON: Disabled, OFF: Enabled) To clear input disable, touch the screen and enter the password for the password level set under \$SW13 in the dialog box that will be displayed prompting password input.	NS status control
20	Contrast Adjustment (+10 levels) (NS5 only)	NS status control
21	Contrast Adjustment (+1 level) (NS5 only)	
22	Contrast Adjustment (-1 level) (NS5 only)	
23	Contrast Adjustment (-10 levels) (NS5 only)	
24	Video Capture	NS status notification and control
25	Start Printing/Capture Screen	NS status control
26	Stop Printing	
27	Test Pattern Printing	
28	Printer head-cleaning (Ignored for PictBridge.)	
29	Update Printer Status	
30	Printer Busy Status/Capture Busy Status	NS status notification
31	Notification of Printer Error/Capture Screen Error	NS status notification
32	Alarm/Event History Initialization (Executed when ON.)	NS status notification and control
33	Alarm/Event History Save (Executed when ON.)	NS status notification and control
34	Internal Holding Memory (\$HB/\$HW) Initialization (Executed when ON.)	NS status notification and control
35	Data Log Initialization (Executed when ON.)	NS status notification and control
36	Data Log Save (Executed when ON.)	
37	Operation Log Initialization (Executed when ON.)	
38	Operation Log Save (Executed when ON.)	
39	Functional Object Operation Log Execution (ON: Execute, OFF: Not execute)	NS status control
40	Screen Switch Operation Log Execution (ON: Execute, OFF: Not execute)	
41	Macro Execution Operation Log Execution (ON: Execute, OFF: Not execute)	
42	Error Log Initialization (Executed when ON.)	NS status notification and control
43	Error Log Save (Executed when ON.)	
44	Reserved (Do not access.)	-

## NS Series Programming Manual

Address	Operation	Classification
45	Macro Error Dialog Box Display Control (ON: Without displaying an error dialog box, the relevant macro processing will be canceled and the previous status returned. Execution of macro processing set elsewhere will be stopped. OFF: Displays an error dialog box, cancels the relevant macro processing, and returns the previous status. Execution of macro processing set elsewhere will be stopped.)	NS status control
46	Macro Error Notification (Turns ON when a macro error is generated. Stays ON when an error is detected until this bit is turned OFF using a user macro or a functional object.)	NS status notification
47	History Processing Error Flag (Turns ON when an error is generated while a CSV file is being created or a Video Capture is being performed.)	NS status notification
48	Memory Card Free Space Check Flag	NS status notification
49	Stop Memory Card	NS status notification and control
50	Memory Card Removing Status (Power OFF)	NS status notification
51	Periodical Data Log Save in Process Flag	NS status notification
52	Data Block Operation Complete Flag	NS status notification
53	Prohibit Screen Save Startup (ON: Disabled)	NS status notification and control
54	Password Level 1 Operable Status	NS status notification
55	Password Level 2 Operable Status	NS status notification
56	Password Level 3 Operable Status	NS status notification
57	Password Level 4 Operable Status	NS status notification
58	Password Level 5 Operable Status	NS status notification
59	Reserved (Do not access.)	–
60	Reserved (Do not access.)	–
61	Reserved (Do not access.)	–
62	Reserved (Do not access.)	–
63	Reserved (Do not access.)	–

## \$SW

Address	Operation	Classification
0	Display screen number (The screen is switched when this number is written)	NS status notification and control
1	Display pop-up screen 1 number (If the specified screen is a base screen, the request is ignored and the page number of the current pop-up screen is written.) The current pop-up screen is closed for 0.	
2	Pop-up screen 1 display position (upper left X coordinate)	
3	Pop-up screen 1 display position (upper left Y coordinate)	
4	Display pop-up screen 2 number	
5	Pop-up screen 2 display position (upper left X coordinate)	
6	Pop-up screen 2 display position (upper left Y coordinate)	
7	Display pop-up screen 3 number	
8	Pop-up screen 3 display position (upper left X coordinate)	
9	Pop-up screen 3 display position (upper left Y coordinate)	
10	Display label number (The label is switched when this number is written.)	
11	Destination (0: Printer, 1: Memory Card)	NS status control
12	Backlight Brightness Adjustment (1 to 32) (NS5-SQ1/-TQ1 only)	NS status control
13	Password number for input disable clear	NS status control

## NS Series Programming Manual

Address	Operation	Classification	
14	Current time (min, s)	NS status notification	
15	Current date and time (day, hour)		
16	Current date and time (year, month)		
17	Current day (day of the week)		
18	No. of generated alarms and events		
19	ID number for generated alarms and events		
20	ID number for cleared alarms and events		
21	Alarm/event ID when alarm/event object macro executed (Stores the displayed or selected alarm or event ID number when a macro is executed using an alarm/event object.)		
22	Reserved (Do not access.)		–
23	Macro execution error number (The error is ignored when the number is 0. The value will be held when an error is detected until 0 is written using a user macro or functional object.)	NS status notification	
24	Macro error screen number (FFFFh for project macros.)		
25	Macro error object ID number (FFFFh for project/screen macros.)		
26	Error macro execution timing 0: When loading a project 4: Alarm/Event ON 5: Alarm/Event OFF 10: When loading a screen 11: When unloading a screen 20: Touch ON 21: Touch OFF 22: Before inputting numeral and string 23: Before writing numeral and string 25: Before changing numeral and string 26: When selecting a list 30: When pressing alarm/event display area 31: When selecting alarm/event summary and history		
27	Offset value for index I0		NS status control
28	Offset value for index I1		
29	Offset value for index I2		
30	Offset value for index I3		
31	Offset value for index I4		
32	Offset value for index I5		
33	Offset value for index I6		
34	Offset value for index I7		
35	Offset value for index I8		
36	Offset value for index I9		
37	Data log group number		
38	Data block error number	NS status notification	
39	Authentication level		

### NS Series Programming Manual

Address	Operation	Classification
40	<p>Range for Initializing Alarm/Event History Makes the optional settings for initialization of alarm/event histories using \$SB32.</p> <p>The alarm/event history to be initialized using the value stored at \$SW40 can be specified as follows.</p> <p>0: All alarm/event history data            1: Confirmed alarm/event history data only            2: Cleared alarm/event history data only            3: Cleared and confirmed alarm/event history data only            4: Resolved alarm/event history data and number of occurrences</p>	NS status control

#### Reference

- ◆ Refer to *2-4 System Memory* for information on the numeral formats written to system memory.
- ◆ Refer to *System Word Memory* under *2-4 System Memory* for information on the date formats written to \$SW14 to \$SW17.
- ◆ System memory allocations in the PLC area can be allocated the same way as for the NT Series. For details, refer to *2-4-3 System Memory Compatibility with the NT Series*.

## 1-4 System Configuration

This section shows the system configuration used for NS-series PTs. Refer to *Appendix 2 List of Models* for details on formats.

### 1-4-1 Peripheral Devices

The following peripheral devices can be connected to NS-series PTs.

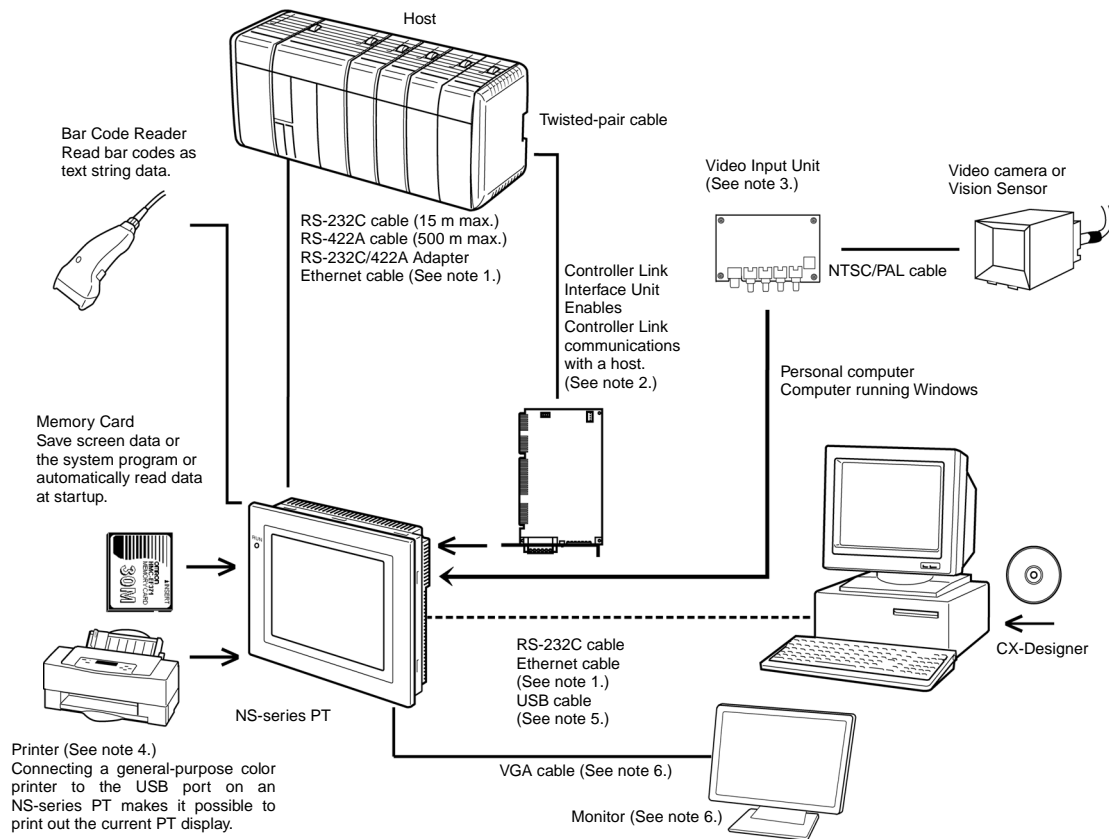

Note 1: Only the following models support Ethernet: NS15-TX01□, NS12-TS01(B), NS10-TV01(B), NS8-TV□1(B), NS5-SQ□1(B), NS5-TQ□1(B), and NS5-MQ□1(B)

Note 2: Only the following models support the Controller Link Interface Unit: NS15-TX01□, NS12-TS0□, and NS10-TV0□. (The NS5 and NS8 do not support the Controller Link Interface Unit.)

Note 3: Only the following models support the Video Input Unit: NS15-TX01□, NS12-TS0□, NS10-TV0□, and NS8-TV□□. (The NS5 does not support the NS-CA001 Video Input Unit. The NS15 supports only the NS-CA002 RGB/Video Input Unit. With the NS15 PT, the NS-CA002 can be used only for analog RGB input. It cannot be used for video display.)

Note 4: General-purpose color printers cannot be connected directly to NS5-SQ□(B)-V□, NS5-TQ□(B)-V□, or NS5-MQ□(B)-V□ PT.

Note 5: Refer to the *Setup Manual* (Cat. No. V083) to connect the PT and computer with a USB cable.

Note 6: A monitor can be connected only to the NS15-TX01□.

**PTs (Refer to the appendices in the *NS Series Setup Manual*.)**

**Recommended Bar Code Readers (Refer to 3-4 *Connecting to Bar Code Readers* in the *NS Series Setup Manual*.)**

OMRON V520-RH21-6/V400-H111/V400-H211 Bar Code Reader

**RS-232C/RS-422A Converter (Refer to the appendices in the *NS Series Setup Manual*.)**

OMRON NS-AL002 Converter

**Recommended Memory Cards (Refer to 3-6 *Using Memory Cards* in the *NS Series Setup Manual*.)**

Model	Memory capacity	Memory type
HMC-EF183	128-MB	Flash memory
HMC-EF283	256-MB	Flash memory
HMC-EF583	512-MB	Flash memory

**CX-Designer (Refer to 3-3 *Connecting the CX-Designer* in the *NS Series Setup Manual*.)**

OMRON CX-Designer

NS-CXDC1-V□ CX-Designer (CD-ROM)

**Video Input Unit (Refer to section 3-7 in the *NS Series Setup Manual*.)**

OMRON NS-CA001

**Controller Link Interface Unit (Refer to section 5-2 in the *NS Series Setup Manual*.)**

OMRON NS-CLK21

**USB-compatible Printer (Refer to the 3-5 *Connecting to Printers* in the *NS Series Setup Manual*.)**

### Reference

- ◆ The following optional products are also available.

#### Anti-reflection Sheets

NS15-KB004	(Anti-reflection Sheets for NS15)
NS12-KBA04	(Anti-reflection Sheets for NS12/NS10)
NS7-KBA04	(Anti-reflection Sheets for NS8)
NT30-KBA04	(Anti-reflection Sheets for NS5)

#### Anti-reflection Protective Covers

NS12-KBA05	(Protective Covers for NS12/NS10)
NS7-KBA05	(Protective Covers for NS8)
NT31C-KBA05	(Protective Covers for NS5)

#### Transparent Protective Covers

NS12-KBA05N	(Protective Covers for NS12/NS10)
NT7-KBA05N	(Protective Covers for NS8)
NT31C-KBA05N	(Protective Covers for NS5)

#### Chemical-resistive Covers

NT30-KBA01	(Chemical-resistive Covers for NS5)
------------	-------------------------------------

#### Replacement Battery

CJ1W-BAT01	(Replacement Battery for NS12/NS10/NS8/NS5)
------------	---------------------------------------------

#### Attachment

	(For replacing NT Series with NS Series)
NS12-ATT01 (B)	(For replacing NT625C/631/631C Series with NS12/10 Series)
NS12-ATT02	(For replacing NT610C Series with NS12/10 Series)
NS8-ATT01	(For replacing NT620S/620C/600S Series with NS8 Series)
NS8-ATT02	(For replacing NT600M/600G/610G/612G with NS8 Series)

## 1-4-2 Connecting to the Host

The NS-series PTs provide the following two serial communications ports.

**Serial port A:**

9-pin D-sub connector

RS-232C host (CX-Designer or bar code reader can be connected. See note.)

**Serial port B:**

9-pin D-sub connector

RS-232C host (CX-Designer or bar code reader can be connected. See note.)

Note: Only one of these can be connected to each port.

Ethernet communications with the host and CX-Designer are possible for the NS15-TX01□-V2, NS12-TS01(B)-V1/-V2, NS10-TV01(B)-V1/-V2, NS8-TV□1(B)-V1/-V2, NS5-SQ01(B)-V1, NS5-SQ□1(B)-V2, NS5-TQ□1(B)-V2, and NS5-MQ□1(B)-V2.

**Ethernet interface:**

8-pin modular connector

10/100Base-T

With the NS15, NS12, and NS10, a Controller Link Interface Unit (NS-CLK21) can be installed to enable communications with a Controller Link Network.

**Controller Link interface:**

Special Connector

Specified shielded twisted-pair cable



**NS Series Programming Manual**

# 1-5 Procedure before Operation

Perform the following procedure to start the PT.

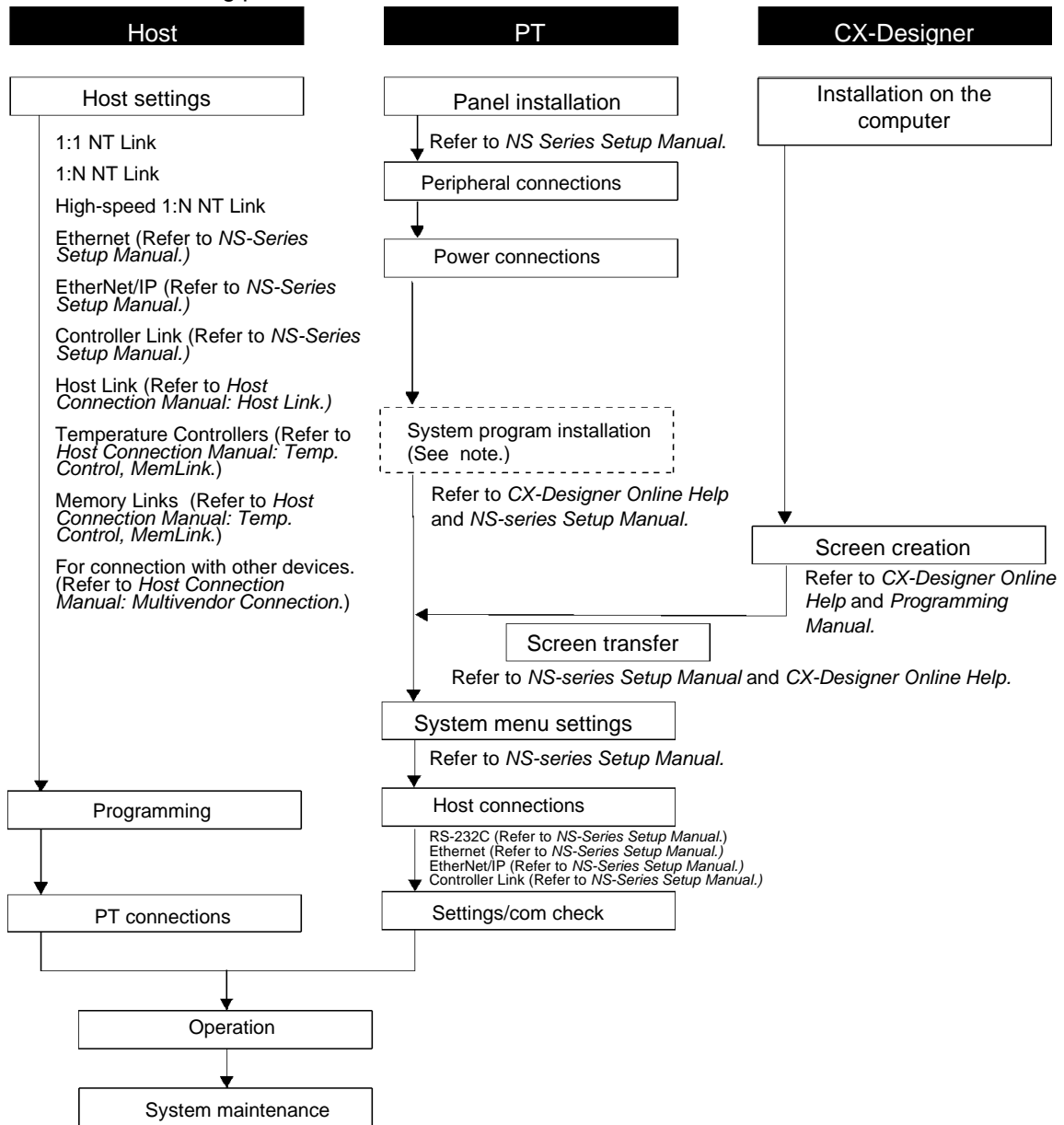

Note: The system program is installed only in special circumstances, such as when the system program is replaced or repaired. (The system program is included with the NS-CXDC1-V□ CX-Designer.)

## NS Series Programming Manual

Refer to the following device and software manuals.

Device/Software	Manual name	Manual No.
NS Series	Setup Manual (NS7/NS10/NS12)	V072-E1-□
	Macro Reference Manual	Included with CX-Designer
NS Series (-V1/V2)	Setup Manual (NS15-V2, NS12-V1/ V2, NS10-V1/V2, NS8-V1/V2, NS5-V1/V2)	V083-E1-□
	Host Connection Manual	V085-E1-□
NS-series Ladder Monitor	NS-series Ladder Monitor Operation Manual	V082-E1-□
PLC	SYSMAC C200HS Installation Guide	W236
	SYSMAC C200HS Operation Manual	W235
	SYSMAC C200HX/HG/HE-E/-ZE Installation Guide	W302
	SYSMAC C200HX/HG/HE Operation Manual	W303
	SYSMAC C200HX/HG/HE (-ZE) Operation Manual	W322
	SYSMAC CQM1 Operation Manual	W226
	SYSMAC CQM1H Operation Manual	W363
	SYSMAC CV Series CV500/CV1000/CV2000/CVM1 Operation Manual: Ladder Diagrams	W202
	SYSMAC CPM1A Operation Manual	W317
	SYSMAC CPM2A Operation Manual	W352
	SYSMAC CPM1/CPM1A/CPM2A/CPM2C/SRM1(-V2) Programming Manual	W353
	SYSMAC CPM2C Operation Manual	W356
	SYSMAC CP series CP1H/CP1L CPU UNIT Programming Manual	W451
	SYSMAC CP series CP1L CPU UNIT Operation Manual	W462
	SYSMAC CP series CP1H CPU UNIT Operation Manual	W450
	SYSMAC CS Series Operation Manual	W339
	SYSMAC CS/CJ Series Serial Communications Boards/Units Operation Manual	W336
	SYSMAC CJ Series Operation Manual	W393
	SYSMAC CS/CJ Series Programming Manual	W394
	SYSMAC CS/CJ Series Instruction Reference Manual	W340
	SYSMAC CS/CJ Series Programming Console Operation Manual	W341
	SYSMAC CS/CJ Series Communications Commands Reference Manual	W342
	SYSMAC CJ Series CJ2 CPU Unit Hardware User's Manual	W472
	SYSMAC CJ Series CJ2 CPU Unit Software User's Manual	W473
	SYSMAC CP Series CP1E CPU Unit Hardware User's Manual	W479
	SYSMAC CP Series CP1E CPU Unit Software User's Manual	W480
	Programming Devices/Software	SYSMAC Support Software Operation Manual: C-series PLCs
SYSMAC Support Software Operation Manual: CVM1 PLCs		W249
SYSMAC CPT User Manual and Quick Start Guide		W332 W333
CX-Programmer User Manual		W437
Ethernet Unit	SYSMAC CS/CJ Series Ethernet Unit Operation Manual	W343
	SYSMAC CVM1/CV Series Ethernet System Manual	W242
	FINS Commands Reference Manual	W227
	SYSMAC CS and CJ Series Ethernet Units Operation Manual Construction of Networks	W420
	SYSMAC CS and CJ Series Ethernet Units Operation Manual Construction of Applications	W421

**NS Series Programming Manual**

<b>Device/Software</b>	<b>Manual name</b>	<b>Manual No.</b>
EtherNet/IP Unit	SYSMAC CS/CJ Series EtherNet/IP Units Operation Manual	W465
Controller Link Support Board	Controller Link Support Board Operation Manual	W307
	Controller Link Support Board for PCI Bus Operation Manual	W383
Controller Link Unit	Controller Link Unit Operation Manual	W309
	Optical Ring Controller Link Units Operation Manual	W370



## Section 2 NS Series Functions

This section provides a detailed explanation of NS Series functions and CX-Designer setting methods.

2-1	Project Data .....	2-1
2-2	NS Series Screen Types.....	2-9
2-3	Internal Memory.....	2-18
2-4	System Memory.....	2-19
2-5	Communications Address Settings.....	2-47
2-6	Fixed Objects.....	2-58
2-7	Registering/Using Library .....	2-64
2-8	Common Functional Object Functions .....	2-65
2-9	Buttons.....	2-119
2-10	Lamps .....	2-153
2-11	Multifunction Objects.....	2-161
2-12	Display and Input Objects .....	2-239
2-13	Display.....	2-270
2-14	Alarms and Events.....	2-298
2-15	Data Logs.....	2-327
2-16	Broken-line Graphs.....	2-365
2-17	Data Blocks .....	2-378
2-18	System Clock.....	2-406
2-19	Machine Navigator Function .....	2-412
2-20	Special Functions.....	2-431
2-21	System Settings and System Menu.....	2-498
2-22	Transferring Device Data .....	2-500

## 2-1 Project Data

### 2-1-1 Project Configuration

Data is created in units called "projects."

This section describes in detail the data that makes up projects.

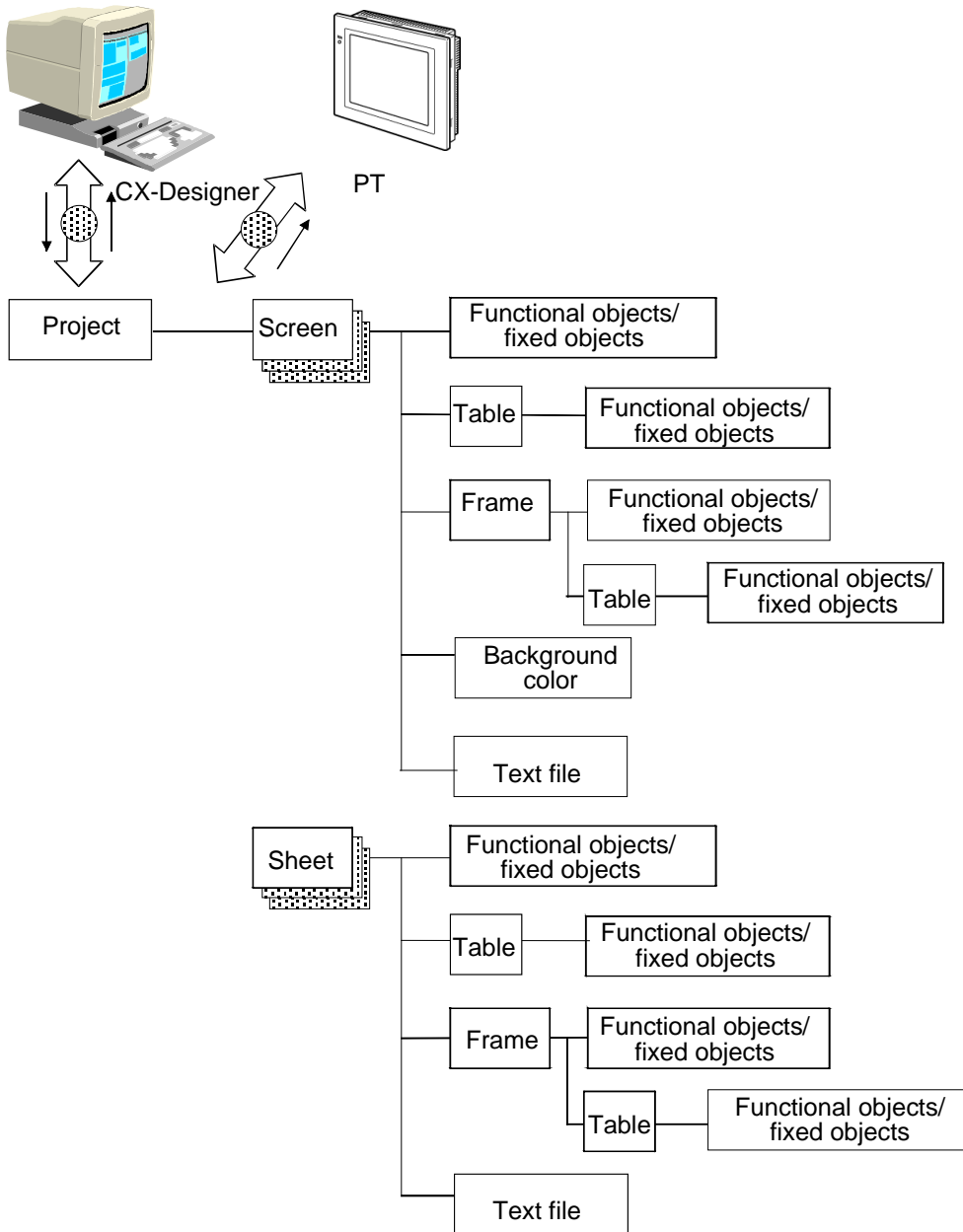

## Data Elements

Name	Contents
Project	All data, such as screen data and settings files, are created in units called projects.
Screen	A screen number is allocated to each screen and up to 4,000 screens can be created in each project.
Sheets	Sheets are screens that can be displayed in layers on normal screens. Sheets are useful when the same images are to be displayed on more than one screen. Up to 32 sheets can be created in each project.
Functional Objects	Functional objects include buttons, lamps, numeral display and input objects, and string display and input objects. Various screens can be created by setting the properties for each functional object in the dialog boxes. Up to 1,024 functional objects can be used in one screen. (See note.)
Fixed Objects	Fixed objects are unlike functional objects in that they do not have monitor or input functions. Although fixed objects can be set to flicker, they are otherwise displayed in a constant state. There are seven types of fixed objects: Lines, circles/ovals, arcs, sectors, polylines, polygons, and rectangles. Up to 2,048 fixed objects can be used in one screen. (See note.)
Tables	The table function combines multiple functional objects into a single table format. Up to 256 functional objects can be combined into one table.
Frames	A frame object enables creating areas on a screen so that only part of the screen can be switched to another page. Frames consist of more than one page, and the displayed contents of the functional objects created on each page can be switched using the page switching function of the frame. Up to 256 frame pages can be created for each frame. Up to 256 functional objects can be used on each frame page. Up to 10 frames can be created for each screen.
Back-grounds	A background is a graphic screen that is displayed as the background of another screen. Note: Backgrounds cannot be set for sheets.
Text Files	Text files are used to browse character strings and screen file names displayed by list selection objects, text objects, and bitmap objects.
Flicker settings	The flicker settings make fixed and functional objects flicker at specified intervals. Ten flicker types can be registered for each screen. For fixed objects, a selection can be made from three prepared flicker types.
Password settings	This function asks for a password to be entered when functional objects are manipulated. A password of up to 16 characters can be set. Up to 5 passwords can be set for one project.
Data log settings	Data log settings are used to register changes over time to the contents of an address. Settings can be made for 100 groups, including the log timing. Up to 16 addresses can be set for one group. Up to 50 addresses can be set for constant logging.
Group specifications	This function performs mutually exclusive operations when buttons are pressed. If the same group number is set to multiple buttons, this function ensures that only one button can be turned ON. Groups 1 to 16 can be selected for one screen. The group specification function is used with ON/OFF buttons.
Numeral unit and scale settings	This function facilitates unit name display and scale conversion display for numeral display objects. Up to 1,000 numeral unit and scale settings can be made for one project.
Dialog settings	This function displays a confirmation message when data is written to functional objects. Any confirmation message can be set. Up to 200 write confirmation messages can be set for one project.
Alarm and event settings	This function always monitors signals registered as alarms or events and records any value change (e.g., from OFF to ON.) The registered data can be displayed simply in the alarm and event objects or can be displayed in a list. Up to 5,000 alarms and events can be registered for one project.
Data Block setting	This function writes and reads preset data to a PLC.
Broken-line graph group setting	This function registers a communications address to be displayed in the broken-line graph. When a broken-line graph group has been set, the new graph can be displayed over the existing graph display. Up to 16 groups can be registered. Up to 256 communications addresses can be set in each group.
Symbol table	This function manages the variables that are registered in a project. Variables can be registered, changed, and deleted.

Name	Contents
String Table Setting	This function manages character strings used in projects. Character strings registered in the string table can be used by more than one functional object. Up to 10,000 character strings can be registered for each project.
Settings for switching contents	This function manages character strings and image files (called "contents") to be displayed. Registered contents can be displayed using the Contents Display. Up to 10,000 contents can be registered for each screen.
Operation Log Setting	The operation log records the following operations. <ul style="list-style-type: none"> <li>• Operations with functional objects</li> <li>• Operations that switch screens</li> <li>• Operations that execute macros</li> <li>• Operations that turning ON and OFF communications addresses (Used to record the operations of external devices.)</li> </ul> A message of up to 32 characters can be set for operations with functional objects and communications addresses. Up to 16 communications addresses can be set for one project.
Device Data Transfer Settings	This function transfers data from transfer sources to transfer destinations when specified conditions are met.

Note: With product data versions earlier than 8.1, a total of 1,024 functional objects, graphs, frames, and tables can be placed on one screen.

### Note

- ◆ A total of up to 1,024 functional objects, frames, and tables can be placed in one screen.  
Up to 2,048 graphic displays can be placed in one screen.

## 2-1-2 Project Properties

Set the properties for the project currently being edited. The following items can be set using this function.

Settings	Contents
Title	Sets the project title (up to 64 characters).
Switch label	Sets the number of labels (1 to 16) and the label names (up to 15 characters).
Macro	Sets the macros to be used for the project.
Language selection	Sets the system language to Japanese or English.
Pop-up menu	Sets the popup menu used to set Word Button, Command Button, String Display & Input objects.
Macro option	Sets "\n" in character strings as the line feed code when the message box macro (MSGBOX) is used.
Numeral input option	Sets whether to display the current string in the display fields when entering values in numeral display and input objects, or whether to clear the current string and enter the new string.
Input Status Color	Sets the text and background colors when inputting numerals or character strings in numeral display and input objects, string display and input objects, and temporary input objects.
Data format	Sets the data format when specifying the line number for indirectly specified files.

Project properties can be changed at any time while screen data is being created.

### Procedure

1. Select **PT - Project Properties**.
  2. The Project Properties Dialog Box will be displayed.
  3. Make the settings and then click the **OK** Button.
- The setting method for each setting item is explained below.



**NS Series Programming Manual**

**Title**

Select the **Title** Tab. Set a title up to 64 characters.

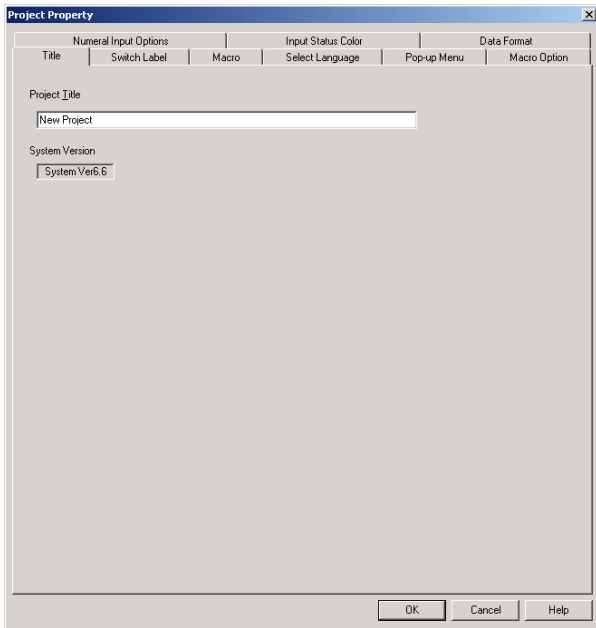

**Switching Labels**

1. Select the **Switch label** Tab.
2. Make the switch label settings.

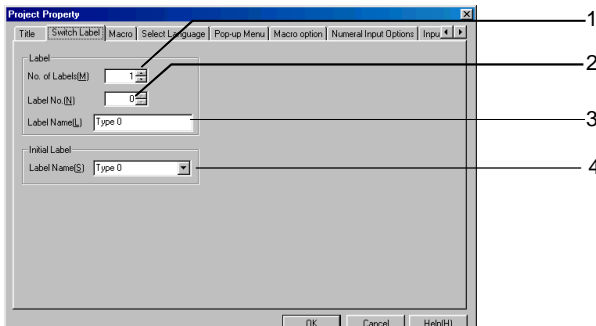

No.	Settings	Contents
1	Number of labels	Set how many labels can be switched (1 to 16).
2	Switch No.	Set the label number.
3	Label name	Set the name for each label number (up to 15 characters).
4	Initial label	Set the label number to show on the screen after power to the PT is turned ON. The default setting is 0.

**NS Series Programming Manual**

**Macros**

1. Select the **Macro** Tab.
2. Set the macros to be used for the project. Refer to *Section 1 Outline of Macro Function* in the *Macro Reference* included on the CX-Designer CD-ROM.

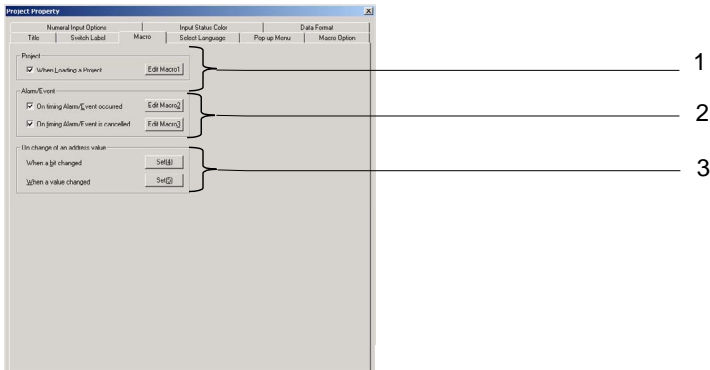

No.	Settings	Contents
1	Project	Specify whether to execute the macro when loading a project. Click the <b>Edit Macro</b> Button to perform programming.
2	Alarm/Event	Specify whether to execute the macro when an alarm/event occurs or when an alarm/event is cancelled. Click the <b>Edit Macro</b> Button to perform programming.
3	When changing value	Specify whether to execute the macro when a specified address (bit) is turned ON/OFF or when the value in a specified address (word) changes. For details on setting methods, refer to <i>System Settings and Project Properties</i> in the <i>CX-Designer Online Help</i> .

### Language Setting

1. Click the **Select Language** Tab.
2. Select the system language for the PT.

The system language will be displayed on the PT for system menus, keypads, messages, dialog boxes, etc.

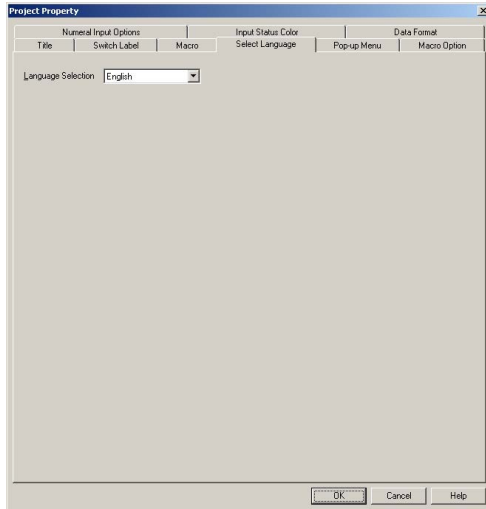

### Pop-up Menu Setting

1. Click the **Pop-up Menu** Tab.
2. Make the settings for the pop-up menu used to set word button, command button, string display, and string input objects.

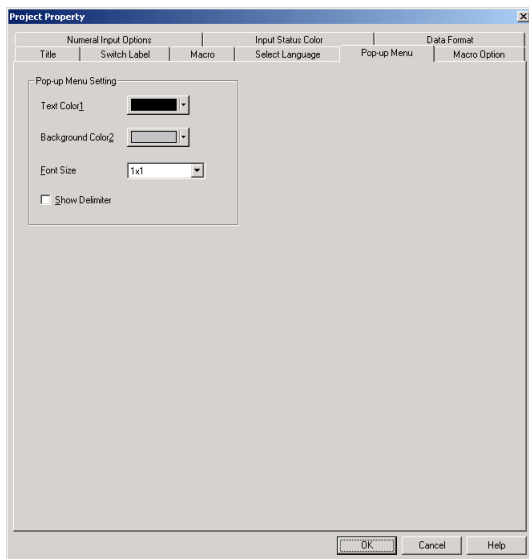

### Macro Option

1. Click the **Macro Option** Tab.
2. Select the option to recognize “\n” in character strings as the line feed code and to display multiple-line messages when using the message box macro (MSGBOX).

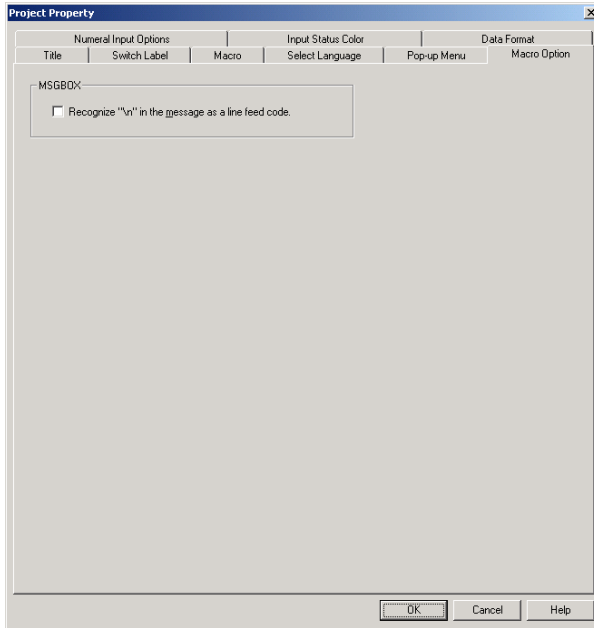

### Numeral Input Option

1. Click the **Numeral Input Options** Tab.
2. Set whether to display the present value when entering values in numeral display and input objects, or whether to clear the present value and enter the new value.

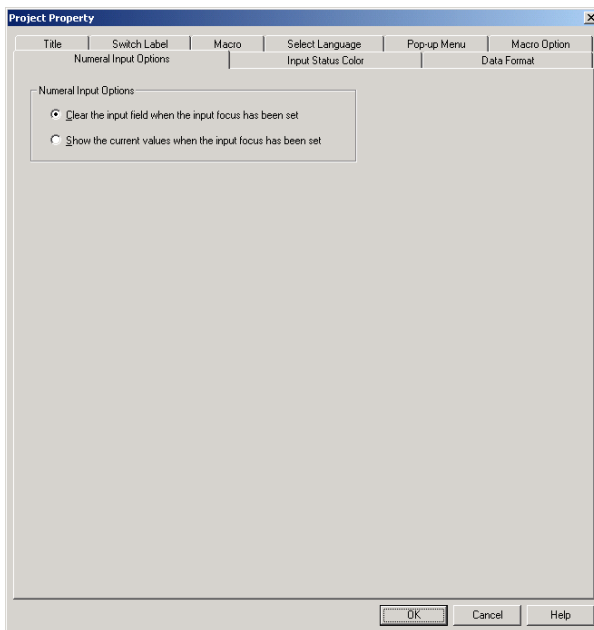

**NS Series Programming Manual**

**Input Status Color**

1. Click the **Input Status Color** Tab.
2. Set the text and input status background colors when inputting numerals or character strings in numeral display and input objects, string display and input objects, and temporary input objects.

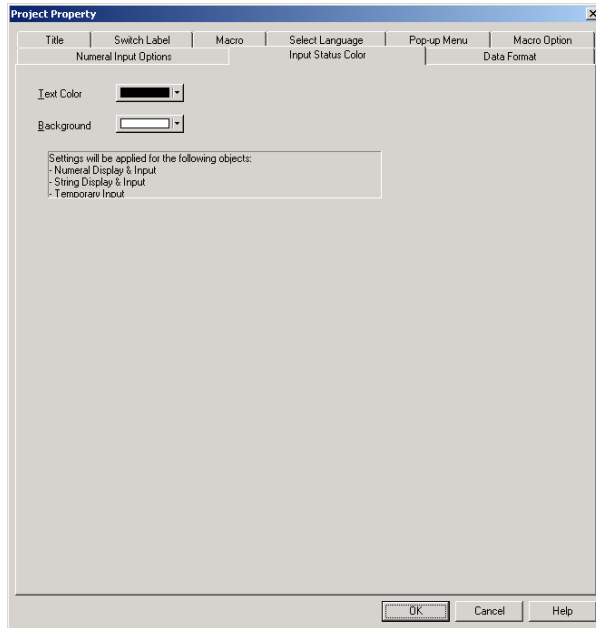

**Data Format**

1. Click the **Data Format** Tab.
2. Select either BCD or binary as the data format when specifying the line numbers for indirectly specified files.

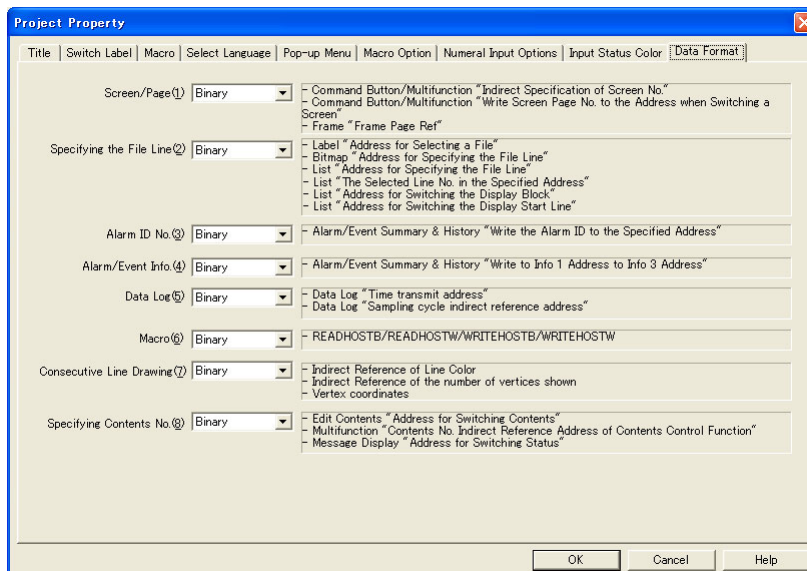

## 2-2 NS Series Screen Types

### 2-2-1 Display Colors

Up to 256 colors can be used in NS Series displays (16-grayscale monochrome display for the NS5-MQ). BMP and JPEG images can be displayed with up to 32,000 colors (16 grayscales for the NS5-MQ).

Select the color to be displayed from the *Color setting* Dialog Box displayed when creating screens using CX-Designer.

An alternative indirect method for specifying display colors is to change the display color based on the contents of a set address.

#### Note

- ◆ BMP and JPEG files created with more than 32,000 colors will be reduced to 32,000 colors for display.
- ◆ Set a color code of between 0 and FF at the communications address to indirectly specify the display color. If a value other than 0 to FF is set at the address, the display color will be undefined.

### Monochrome Display

The NS5-MQ□□-V2 features 16-grayscale monochrome display. All display colors are converted to 16 grayscale levels. Even BMP, JPEG, and other color image data is internally converted by the NS5-MQ and displayed in 16 grayscale levels.

#### Note

- ◆ Although screen data for the NS5-MQ□□-V2 is displayed in 16 grayscale levels on the CX-Designer displays and the NS5-MQ□□-V2 screen, the data will be displayed in color if it is converted to data for a PT model with color displays on the CX-Designer or transferred to a PT with a color display screen. The color codes that are used when creating the screen data for the NS5-MQ□□-V2 will be displayed for screen data and the image colors will be used for BMP and JPEG data.
- ◆ All screen data created for PTs with color displays will be displayed in 16 grayscale levels on the CX-Designer if the screen data is converted for the NS5-MQ□□-V2 or it is transferred to the NS5-MQ□□-V2.

### Through Display

If layers of objects are displayed, the background color for the object on top will normally overwrite the object underneath and the bottom object will no longer be visible.

Some objects can be set so that the background will not be filled.

If the object is set for no tiling, the background of the object will not have a color and other objects under the background or the screen background color will show through.

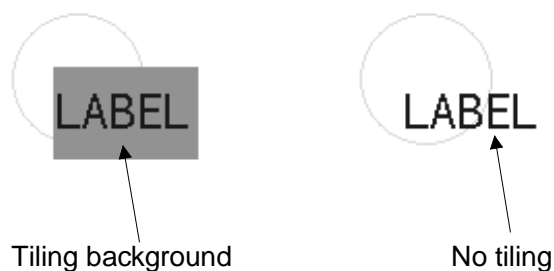

**No Tiling**

Labels, numeral display and input objects, string display and input objects, list selection objects, thumbwheel switches, broken-line graphs, alarm/event displays, alarm/event summary & histories, dates, times, data log graphs, rectangles, circle/ovals, polygons, and sector can be set for no tiling.

**Screen Background Colors**

The background color for each screen can be set under **Background color** in the screen attributes. The screen attributes are set using CX-Designer as properties for each screen.

**Character Colors**

The color of the characters themselves can also be set.

The character color is set as one of the properties when setting the labels for each object using CX-Designer. Character colors can also be specified indirectly.

**2-2-2 Screen Configuration**

NS15, NS12, NS10, NS8, and NS5 screens have the following configurations:

- NS5: 320 dots horizontal and 240 dots vertical
- NS10 and NS8: 640 dots horizontal and 480 dots vertical
- NS12: 800 dots horizontal and 600 dots vertical
- NS15: 1024 dots horizontal and 768 dots vertical

Each point on the screen is specified using X (horizontal) and Y (vertical) coordinates. The origin of the coordinates (0,0) is the upper left corner.

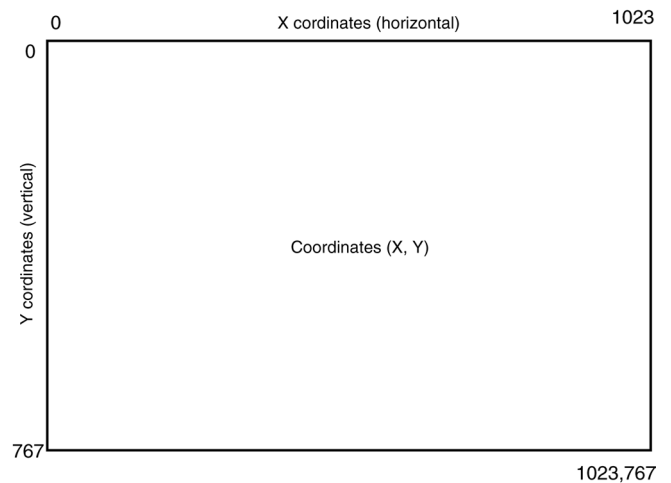
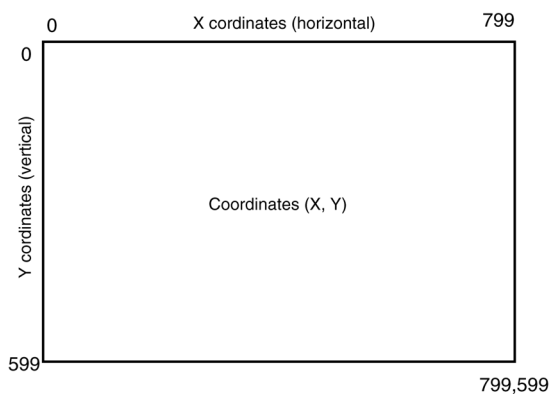
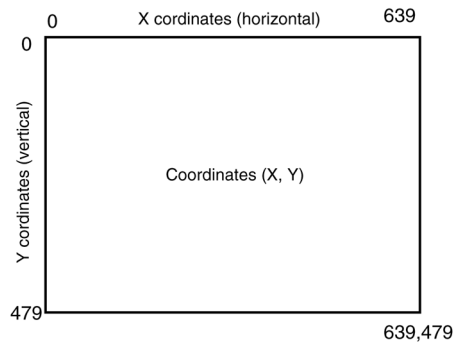
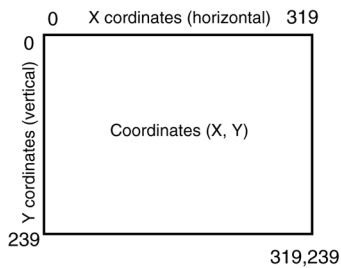

### 2-2-3 Screen Numbers

NS-series screens are categorized and controlled using screen numbers.

Screen numbers are used to specify the display screen when the PT is started or when switching the displayed screen.

Except for the System Menu Screen for which specific functions have been set, up to 4,000 screens can be set for NS-series PTs. Any number between 0 and 3,999 can be set for these screens.

In addition, up to 32 sheets can be registered for layered display on normal screens. Any number between 0 and 31 can be set for these sheets.

When PT screens are created using the CX-Designer, the screen number is specified and the objects to be displayed are registered.



### 2-2-4 Screen Types

The following two screen types are available.

Screen	Contents
User Screens	Used to create normal screens. <ul style="list-style-type: none"> <li>• Normal screens (base screens) Basic screens displayed during PT operation.</li> <li>• Pop-up screens Pop-up screens that can be displayed layered on top of base screens.</li> </ul>
Sheets	Sheets are screens used when the same images are to be displayed on more than one screen. Used in layers on normal screens.

There are also frames that have a switching function that switches the display on specific areas in the screen.

Name	Contents
Frame	Objects can be created on each page of the frames in the screen.

*Reference*

◆ Refer to *Creating Screens* in the *CX-Designer Online Help* for details on creating screens.

#### User Screens

##### • Normal Screens

Normal screens are basic screens displayed during PT operation.

Any functional objects or fixed objects can be created for normal screens.

Up to 4,000 screens can be created for each project and any number between 0 and 3,999 can be allocated to the screens.

##### • Pop-up Screens

Only one normal screen at a time can be displayed during PT operation, but pop-up screens can be layered on top of normal screens. Pop-up screens are created the same way as normal screens. These pop-up screens can be used to display user keypads or help screens.

Up to three pop-up screens can be opened at a time.

Normal Screen

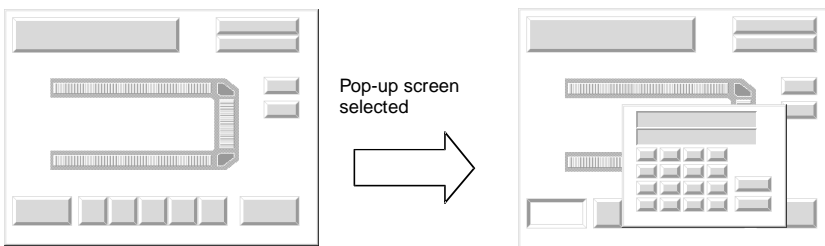

Pop-up Screen

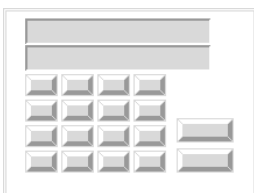

### Reference

- ◆ Pop-up screens are created the same way as normal screens. After a screen is created, specify under the screen properties whether it will be a normal screen or pop-up screen. Screen number 0, however, cannot be set as a pop-up screen.
- ◆ Data Block Tables and Video Displays cannot be created on pop-up screens. For details, refer to *Creating Screens* in the *CX-Designer Online Help*.

### Sheets

Sheets are screens that can be displayed in layers on standard screens.

If a functional object, such as screen switching buttons or date display, is used in multiple screens, the functional object can be registered to a sheet. By then setting which sheet is applicable to which screen, the functional object can be used on all applicable screens.

Normal Screen

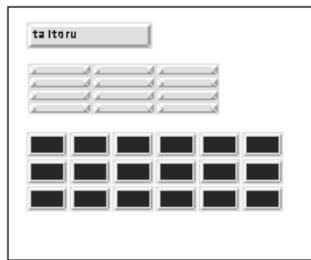

Sheet applied

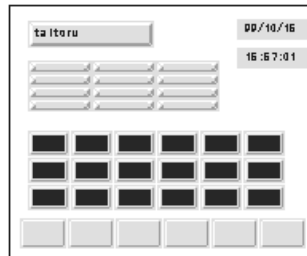

Sheet

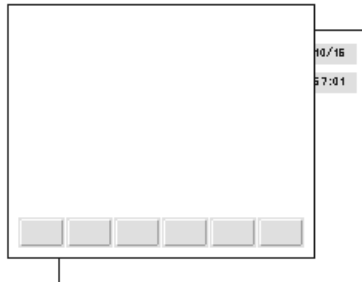

**Reference**

- ◆ Up to 32 sheets can be created for each project.  
Up to 1,024 functional objects can be created in one sheet, the same as for normal screens.
- ◆ Up to 10 sheets can be applied over one user screen.
- ◆ If multiple sheets are applied to a normal screen and if the position of the functional objects for the normal screen and the sheets overlaps, the standard screen objects will be displayed on top. The sheet objects will be displayed in order, with the object with the highest screen number on top.

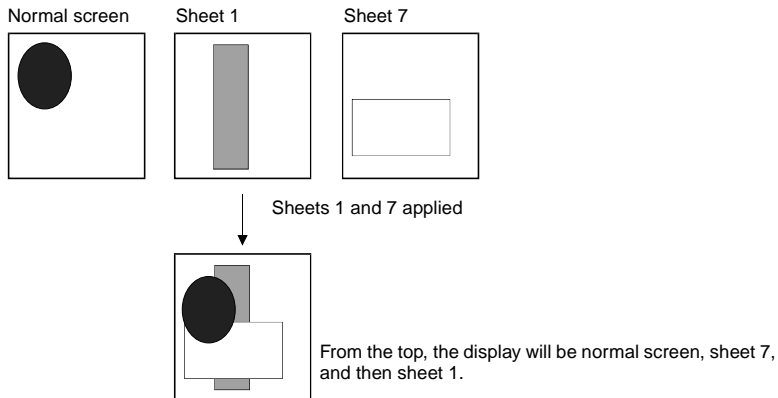

- ◆ Video Displays and Data Block Tables cannot be created on sheets.

## Frames

A frame object enables creating areas on a screen so that only part of the screen can be switched to another page. Frames consist of more than one page based on the user settings and the displayed contents of the functional objects configuring each page can be switched based on PT or PLC status.

Frames can contain fixed objects, functional objects, and tables.

Created frames registered in a library can be easily reused at many different locations or on different screens.

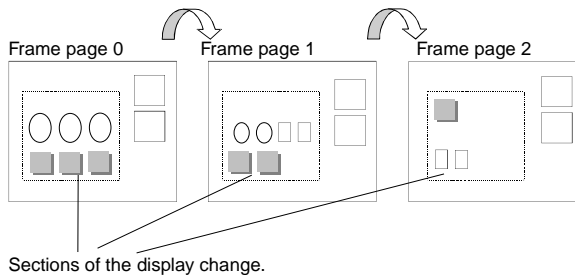

### Reference

- ◆ If frames are switched frequently, the display update may take some time and communications may be delayed. Care must be taken because this means that sometimes data will not be logged or the momentary ON/OFF buttons may not operate normally.
- ◆ Make sure the functional objects in the frame do not protrude from the frame. If the objects do protrude from the frame when it is created, they will be displayed incorrectly outside the frame.
- ◆ Up to 10 frames can be created within one screen.  
Up to 256 functional objects can be created in one frame page. The total number of functional objects that can be created in one screen, including the functional objects on each frame page and the functional objects outside frames, is 1,024.

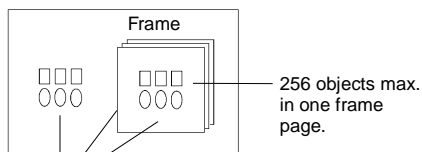

























Total of 1,024 objects overall.  
Each frame also counted as 1 object.

- ◆ Video Displays and Data Block Tables cannot be created in frames.

## 2-2-5 Screen Objects



### Functional Objects

The following functional objects can be used.

Icon	Name	Function
	ON/OFF Button	Controls the ON/OFF status of the specified write address. The action type can be selected from momentary, alternate, SET, or RESET.
	Word Button	Sets numeric data at the specified address. The contents can also be incremented and decremented.
	Command Button	Performs special processing, such as switching screens, controlling pop-up screen and Video display, etc.
	Bit lamp	Turns ON and OFF according to the ON/OFF status of the specified address.
	Word lamp	Lights in 10 steps according to the contents of the specified address (0 to 9).
	Multifunction Object	Executes multiple functions at the same time when the object is pressed or the value at a specified address changes.
	Text	Displays the registered character string.
	Numeral Display & Input	Numerically displays the word data from the specified address and input data from a tenkey pad.
	String Display & Input	Displays the character string from the word data from the specified address and input data from a keyboard.
	List Selection	Displays the registered character strings in a list for selection.
	Thumbwheel Switch	Numerically displays the word data from the specified address and increment and decrement the data when increment/decrement buttons are pressed.
	Analogue Meter	Displays graphs in three colors in circles, semi-circles, or quarter circles for the word data at the specified addresses.
	Level Meter	Displays levels in three colors for the word data at the specified address.
	Broken-line Graph	Displays broken-line graphs for the word data at the specified addresses.
	Bitmap	Displays screen data. Image data in BMP and JPEG format can be displayed.
	Video Display	Displays pictures imported from video devices, such as a video camera or Vision Sensor.
	Alarm/Event Display	Displays alarms or events that have occurred in order of priority.
	Alarm/Event Summary History	Displays a list of alarms/events and the history.
	Date	Displays and sets a date.
	Time	Displays and sets a time.
	Temporary Input	Provides a temporary display of an input value or character string.
	Data Log Graph	Displays trend graphs for the word data at the specified addresses.
	Data Block Table	Writes to and reads from PLC preset recipe data, such as instructions for manufacturing process.
	Consecutive Line Drawing	Displays a polyline shape that can be changed with the contents of communications addresses.
	Contents display	Displays the contents (character strings or image files) according to the contents switching setting.







## Tables and Frames

The following frames and tables are available.

Icon	Name	Contents
	Frame	Switches the specified rectangle area (frame).
	Table	Displays functional objects in a table format.

## Fixed Objects

The following fixed objects can be used.

Icon	Name	Contents
	Rectangle	Displays a rectangle.
	Circle/Oval	Displays a circle or ellipse.
	Line	Displays a line or arrow.
	Polyline	Displays a polyline.
	Polygon	Displays a polygon.
	Sector	Displays a sector.
	Arc	Display an arc.

## 2-3 Internal Memory

The internal memory in the PT can be read and written by the user. Internal memory can be allocated as required for settings, such as the communications addresses of functional objects.

The internal memory is divided into bit and word sections.

### 2-3-1 Bit Memory (\$B)

The bit memory in a PT is indicated by \$B. Up to 32,768 bits can be used. Addresses from \$B0 to \$B32767 can be read and written by the user.

Bit memory is used for signal information that indicate ON/OFF status for functional object addresses and control flags.

### 2-3-2 Word Memory (\$W)

The word memory in PTs is indicated by \$W. Up to 32,768 words can be used. Addresses from \$W0 to \$W32767 can be read and written by the user.

Word memory is used to store all numeral and character string data, including data for allocated addresses for functional objects.

Each word contains 16 bits, but consecutive words can be used as required for character strings and 32-bit data.

#### Note

- ◆ Internal memory cannot be read and written directly from the host.
- ◆ The internal memory size is fixed at 32,768 bits for \$B and 32,768 words for \$W.

### 2-3-3 Internal Holding Memory (\$HB/\$HW)

The memory in PTs that holds values even when the power to the PT is turned OFF is indicated by \$HB and \$HW. \$HB holds 8,192 bits and \$HW holds 8,192 words. Any address from \$HB0 to \$HB8191 or \$HW0 to \$HW8191 can be read and written by the user.

\$HB is used for signal information that indicates ON/OFF status for functional object addresses and control flags. \$HW is used to store numeral and character string data, including data for allocated addresses for functional objects.

Each word in \$HW contains 16 bits, but consecutive words can be used as required for character strings and 32-bit data.

## 2-4 System Memory

System memory is used for exchanging information between the host and the PT, such as for controlling the PT and notifying the host of PT status.

The system memory is divided into bit and word sections.

### 2-4-1 System Bit Memory (\$SB)

System bit memory is used to exchange information between the host and the PT, such as for controlling the PT and notifying the host of PT status, in bit units.

The system bit memory contains 64 bits with predefined functions.

The system bit memory is listed in the following table.

Address	Classification	Function
\$SB0	Notification	RUN Signal (Pulse)
\$SB1	Notification	RUN Signal (Always ON)
\$SB2	Notification	Screen Switch Strobe
\$SB3	Control	Prohibit Shifting to System Menu
\$SB4	Notification	Battery Low
\$SB5	Notification	Data Input Detector
\$SB6	Control	Brightness Adjust, High
\$SB7	Control	Brightness adjust, middle
\$SB8	Control	Brightness adjust, low
\$SB9	Control	Backlight Control (Screen Saver Start/Cancel)
\$SB10	Control	Control Backlight Flashing
\$SB11	Notification	Backlight Status
\$SB12	Control	Continuous Buzzer
\$SB13	Control	Short Intermittent Buzzer
\$SB14	Control	Long Intermittent Buzzer
\$SB15	Notification/control	Notification/control of Video
\$SB16	Control	Processing Priority Registration for Port A (NT Link 1:N)
\$SB17	Control	Processing Priority Registration for Port B (NT Link 1:N)
\$SB18	Control	Display Keypad with Temporary Input
\$SB19	Control	Prohibit Input
\$SB20	Control	Contrast Adjustment (+10 levels) (NS5 only)
\$SB21	Control	Contrast Adjustment (+1 level) (NS5 only)
\$SB22	Control	Contrast Adjustment (-1 level) (NS5 only)
\$SB23	Control	Contrast Adjustment (-10 levels) (NS5 only)
\$SB24	Notification/control	Video Capture
\$SB25	Control	Start Printing/Capture Screen (Not supported by NS5-□Q0□.)
\$SB26	Control	Stop Printing
\$SB27	Control	Test Pattern Printing
\$SB28	Control	Printer head-cleaning (Ignored for PictBridge.)
\$SB29	Control	Update Printer Status
\$SB30	Notification	Printer Busy Status/Capture Busy Status
\$SB31	Notification	Notification of Print Error/Capture Screen Error
\$SB32	Notification/control	Initialize Alarm/Event History
\$SB33	Notification/control	Save Alarm/Event History
\$SB34	Notification/control	Internal Holding Memory (\$HB/\$HW) Initialization
\$SB35	Notification/control	Initialize Data Log
\$SB36	Notification/control	Save Data Log
\$SB37	Notification/control	Initialize Operation Log
\$SB38	Notification/control	Save Operation Log
\$SB39	Control	Log Functional Object Operation
\$SB40	Control	Log Switch Screen Operation
\$SB41	Control	Log Macro Operation



**NS Series Programming Manual**

Address	Classification	Function
\$SB42	Notification/control	Initialize Error Log
\$SB43	Notification/control	Save Error Log
\$SB44	–	Reserved
\$SB45	Control	Macro error display control
\$SB46	Notification	Notification of Macro Error
\$SB47	Notification	Logging Process or Video Capture Error Flag
\$SB48	Notification	Memory Card Free Space Check Flag
\$SB49	Notification/control	Stop Memory Card
\$SB50	Notification	Memory Card Removing Status (Power OFF)
\$SB51	Notification	Periodical Data Log Save in Process Flag
\$SB52	Notification	Data Block Operation Complete Flag
\$SB53	Notification/control	Prohibit Screen Saver Startup
\$SB54	Notification	Password Level 1 Operable Status
\$SB55	Notification	Password Level 2 Operable Status
\$SB56	Notification	Password Level 3 Operable Status
\$SB57	Notification	Password Level 4 Operable Status
\$SB58	Notification	Password Level 5 Operable Status
\$SB59	–	Reserved
\$SB60	–	Reserved
\$SB61	–	Reserved
\$SB62	–	Reserved
\$SB63	–	Reserved

Note: The notification bits are not write-prohibited. Also, the system will not restore values, except when the status has changed.

**Note**

- ◆ The NS-series PT may operate incorrectly if addresses that are reserved by the system are accessed. Do not access these addresses.

System memory is allocated to PLC areas as shown below.

Set the allocation addresses for the system memory on the Initial Tab Page of the CX-Designer. Select **PT – System Settings** to access the Initial Tab Page.

\$SB = m

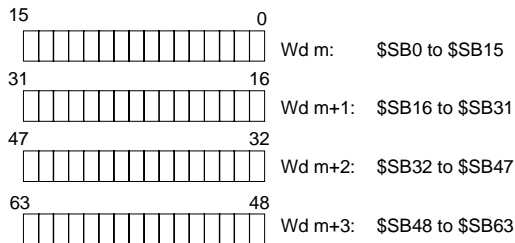

**Note**

- ◆ The method for allocating system memory in the PLC areas is the same as for the NT Series. Refer to 2-4-3 System Memory Compatibility with the NT Series for details.
- ◆ Set a BOOL variable with 64 elements when allocating a tag.

**RUN Signal (Pulse) (\$SB0)**

\$SB0 notifies the host memory and PT memory that the PT is operating (normal operation on normal screens.) During operation, \$SB0 alternates between ON and OFF according to the interval set for RUN signals (pulses).

**NS Series Programming Manual**

\$SB0 will not turn OFF and ON if no communications between \$SB0 and the allocated address is set in the CX-Designer system settings.

Status	RUN signal status	Operation when status cleared
System Menu (including device monitor)	Stops notification.	Restarts notification.
Transfer	Stops notification.	Restarts notification.
Error (See note.)	Stops notification.	Restarts notification.
Start	Stops notification.	Starts notification.
Screen saver	Continues to alternate ON/OFF notification.	Continues to alternate ON/OFF notification.

Note: An error dialog box (X dialog box) is displayed.

**RUN Signal (Always ON) (\$SB1)**

\$SB1 notifies the host memory and PT memory that the PT is operating (normal operation on normal screens.) During operation, \$SB1 turns ON according to the interval set for RUN signals (pulses) in the \$SB and \$SW.

\$SB1 will not turn ON if no communications between \$SB1 and the allocated address is set in the CX-Designer system settings.

Status	RUN signal status	Operation when status cleared
System Menu (including device monitor)	Stops notification.	Restarts notification.
Transfer	Stops notification.	Restarts notification.
Error (See note.)	Stops notification.	Restarts notification.
Start	Stops notification.	Starts notification.
Screen saver	Continues to notify ON.	Continues to notify ON.

Note: An error dialog box (X dialog box) is displayed.

If the status is changed to System Menu, transfer, or another status, the notification will stop but OFF notification will not be made before the status change.

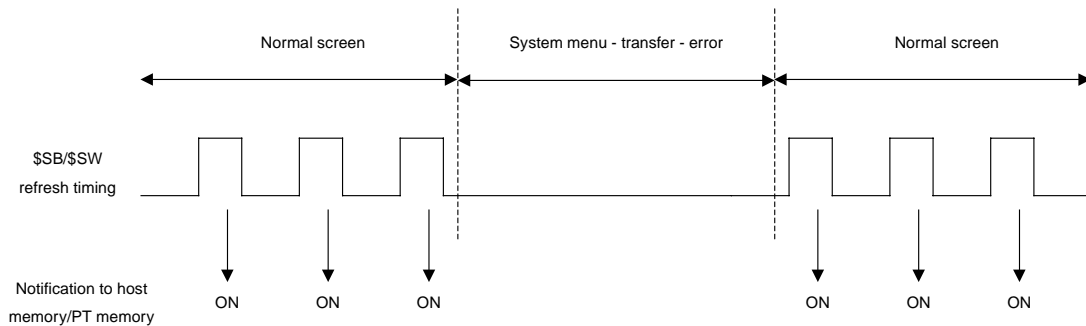

**Note** Include programming that regularly accesses the RUN signal and confirms that the PT is operating normally.

**Screen Switch Strobe (\$SB2)**

\$SB2 is for notification of screen switching.

Immediately after the screen is switched, \$SB2 is turned ON the next time \$SB/\$SW is refreshed and then turned OFF at the following \$SB/\$SW refresh.

Notification is made when the screen switches to a normal (base) screen.

**NS Series Programming Manual**

Timing	Screen switch strobe notification
From base screen to base screen	Yes
From non-base screen to base screen (See note.)	No
Open, close, move pop-up screen	No
Move to System Menu	No
Move to transfer	No
Startup initial screen display	No
Move to screen saver	No
Frame switch	No
Screen switch failure (switched to non-existent screen)	No

Note: Applicable to System Menu, transfer, and screen saver.

\$SB2 will not turn OFF if no communications between \$SB2 and the allocated address is set in the CX-Designer system settings.

The screen switch strobe will operate as shown in the following diagram if a screen switch is performed after another screen switch.

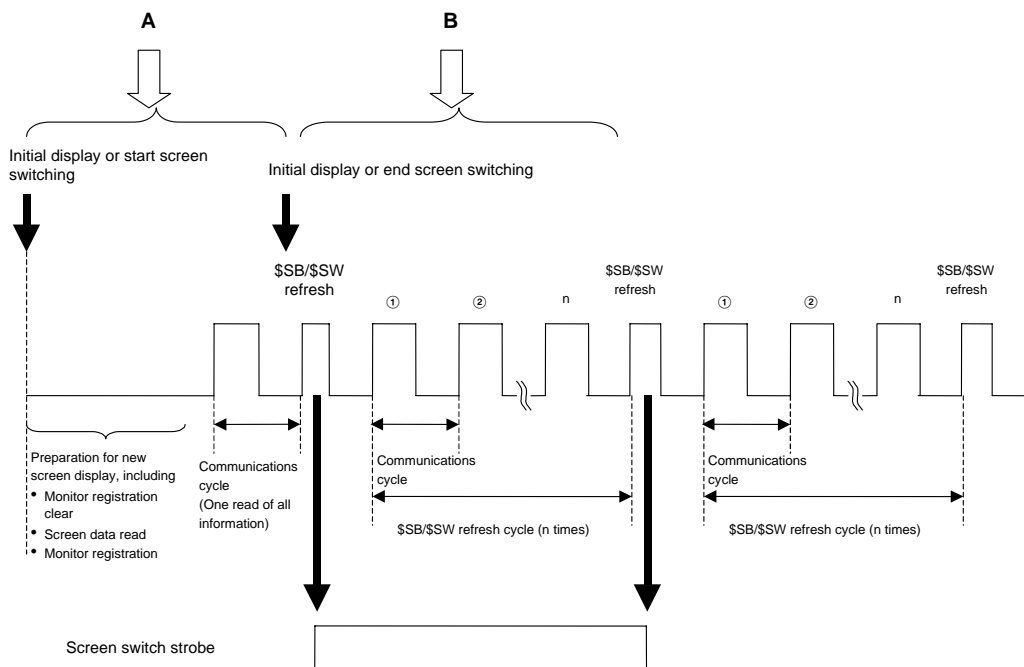

**Switching to Another Base Screen during “A”**

The PT moves to the next screen switch processing without making screen switch strobe notification for the first screen.

**Switching to Another Base Screen during “B”**

The PT moves to the next screen switch processing without turning OFF screen switch strobe notification for the first screen.

**Prohibit Shifting to System Menu (\$SB3)**

\$SB3 prohibits transfer to System Menu. If \$SB3 is turned ON, transfer to System Menu is prohibited by pressing the two points on the screen. Transfer from an error dialog box to the System Menu when an error is generated is not prohibited.

**Battery Low (\$SB4)**

\$SB4 is for notification of a drop in the PT battery voltage. \$SB4 turns ON when the voltage drops and turns OFF when the battery is replaced and the voltage returns to normal.

### Data Input Detector (\$SB5)

\$SB5 detects numeral and character input. \$SB5 turns ON when numeral and character (virtual keyboard) input dialog boxes are opened and turns OFF when these dialog boxes are closed.

If *Input from Pop-up Screen* is specified as the input method in the input functional object for numeral or character string display and input, \$SB5 will turn ON when the pop-up screen is opened and will turn OFF when the focus is moved to another object. If *Other Input Method (command button, etc.)* is specified, \$SB5 will turn ON when the focus is on the object and will turn OFF when the focus leaves the object.

### Brightness Adjust (\$SB6, \$SB7, and \$SB8)

\$SB6 to \$SB8 are used to adjust backlight brightness.

\$SB6 is used to adjust the backlight brightness to high. The brightness can be adjusted to high by turning ON \$SB6.

\$SB7 is used to adjust the backlight brightness to middle. The brightness can be adjusted to middle by turning ON \$SB7.

\$SB8 is used to adjust the backlight brightness to low. The brightness can be adjusted to low by turning ON \$SB8.

If the screen saver has started, the screen saver will remain even if \$SB6, \$SB7, or \$SB8 is turned ON.

With NS5-SQ1/-TQ1 PTs with lot number 15Z0 or earlier, \$SW12 is used to adjust the brightness of the backlight. If \$SB6 to \$SB8 and \$SW12 are changed at the same time, the backlight brightness will be changed to the setting for which the change was detected last inside the PT.

#### Note

- ◆ If more than one of these bits turns ON at the same time, the priority order of brightness is high, middle, and then low.
- ◆ If bits \$SB6 to \$SB8 are all turned OFF, the background brightness will be high.
- ◆ If external adjustment of the brightness is specified for the NS15 backlight from the System Menu, \$SB6 to \$SB8 cannot be used to adjust the brightness of the backlight. Refer to the NS-series PT Setup Manual for information on the System Menu settings for the backlight brightness.

### Backlight Control (Screen Saver Start/Cancel, \$SB9)

When \$SB9 turns ON, the backlight will go out 3 seconds later and the screen saver will start. When \$SB9 turns OFF, the screen saver is canceled and the backlight turns ON. Even if the screen saver is set to OFF on the PT Tab Page of the System Settings, the screen saver will start when this bit turns ON. The screen saver will also be canceled if the screen is touched while the screen saver is being displayed. If \$SB9 is turned ON while the Control Backlight Flashing bit (\$SB10) is ON, the backlight will flash. \$SB9 will turn OFF.

### Control Backlight Flashing (\$SB10)

\$SB10 controls backlight flashing. When \$SB10 turns OFF, the backlight is lit and when \$SB10 turns ON, the backlight flashes.

If the screen saver has started, the screen saver will remain and the screen will not flash even if \$SB10 is turned ON. If \$SB10 is ON when the screen saver is closed, the screen will start flashing after the screen saver has closed.

If the screen is switched to System Menu while the backlight is flashing (i.e., \$SB10 is turned ON), the flashing will stop. The flashing will start again when the screen is changed back from System Menu.

If an error dialog box is displayed while the backlight is flashing (i.e., \$SB10 is turned ON), the flashing will stop. The flashing will start again when the error dialog box is closed.

**Backlight Status (\$SB11)**

\$SB11 indicates the status of the backlight. \$SB11 turns ON while the backlight is not lit.

**Buzzers (\$SB12, \$SB13, and \$SB14)**

Bits \$SB12 to \$SB14 are used to sound buzzers. \$SB12 starts a continuous buzzer, \$SB13 starts a short intermittent buzzer (0.5 s intervals), and \$SB14 starts a long intermittent buzzer (1 s intervals).

When bits \$SB12 to \$SB14 turn ON, the buzzer sounds while the bit remains ON.

Bits \$SB12 to \$SB14 all turn OFF if the buzzer is stopped using the command buttons.

The buzzers sound only when the buzzer sound setting in the System Menu is set to ON in the CX-Designer system settings. (The buzzer will not sound if this setting is set to OFF or ERROR ON.)

**Note**

- ◆ If more than one of these bits turns ON, the priority order for the buzzers is continuous, short intermittent, and then long intermittent.

**Notification/Control of Video (\$SB15)**

\$SB15 controls the display of video images. When there is a video display object in the screen after screen switching, \$SB15 will turn ON. When there is no video display object, \$SB15 will turn OFF.

When a video display object is positioned in the screen during display and \$SB15 is turned OFF with the video image displaying, the video image will cease being displayed.

If \$SB15 is turned ON in this non-display state, the video image will be displayed.

**Note**

- ◆ If \$SB15 is turned ON or OFF while a message dialog is being displayed, the video image will be displayed or non-displayed after the dialog is deleted.

**Processing Priority Registration (\$SB16 and \$SB17)**

\$SB16 and \$SB17 are used to register processing priorities for serial ports A and B, respectively.

When multiple PTs are connected using standard or high-speed NT Links (for 1:N), one PT can be registered for priority processing. The PT with bits \$SB16 and \$SB17 set to ON will be given priority, with improved display and touch switch response speed.

This registration will be cleared if \$SB16 and \$SB17 are turned OFF and the response speed will return to normal.

**Note**

- ◆ If more than one PT is registered for priority processing, the most recently registered PT will be given priority.

The unit number of the PT with priority registration can be checked by monitoring (reading) the CS-series, CJ-series, CP1H, CP1L, CP1E, CJ2H, CJ2M, C200HX/HG/HE-E/-ZE, or CQM1H words. Refer to the manual for the PLC for information on how to monitor words in the PLC.

The contents of the words that reflect the status of standard and high-speed NT Links (for 1:N) are shown in the following table.

**NS Series Programming Manual**

Word	Bit	Function
C200HX/HG/HE-E/-ZE 265 (internal RS-232C port) 284 (port A) (See note 1.) 285 (port B) (See note 1.)	0	Unit 0 Peripheral Port PT Communications Flag, ON when connected
	1	Unit 1 Peripheral Port PT Communications Flag, ON when connected
	2	Unit 2 Peripheral Port PT Communications Flag, ON when connected
	3	Unit 3 Peripheral Port PT Communications Flag, ON when connected
CS Series and CJ Series AR393 (internal RS-232C port) AR394 (peripheral port)	4	Unit 4 Peripheral Port PT Communications Flag, ON when connected
	5	Unit 5 Peripheral Port PT Communications Flag, ON when connected
	6	Unit 6 Peripheral Port PT Communications Flag, ON when connected
	7	Unit 7 Peripheral Port PT Communications Flag, ON when connected
	8	Unit 0 Peripheral Port PT Priority Registered Flag, ON when given priority
CIO 1909 (port 1) (See note 2.) CIO 1919 (port 2) (See note 2.)	9	Unit 1 Peripheral Port PT Priority Registered Flag, ON when given priority
	10	Unit 2 Peripheral Port PT Priority Registered Flag, ON when given priority
	11	Unit 3 Peripheral Port PT Priority Registered Flag, ON when given priority
n + 9 (port 1) (See note 3.) n + 19 (port 2) (See note 3.)	12	Unit 4 Peripheral Port PT Priority Registered Flag, ON when given priority
	13	Unit 5 Peripheral Port PT Priority Registered Flag, ON when given priority
	14	Unit 6 Peripheral Port PT Priority Registered Flag, ON when given priority
	15	Unit 7 Peripheral Port PT Priority Registered Flag, ON when given priority
CQM1H		
IR 202 (port 1) (See note 2.)		
IR 203 (port 2) (See note 2.)		

- Note 1. Port on the Communications Board.  
 2. Port on the Serial Communications Board.  
 3. Port on the Serial Communications Board.  
 n = 1500 + 25 × Serial Communications Unit No. (CIO Area)

**Display Keypad with Temporary Input (\$SB18)**

\$SB18 changes the keypad displayed for a Numeral Display & Input or Data Block Table object. The following keypads will be displayed according to the bit status.

\$SB18: ON

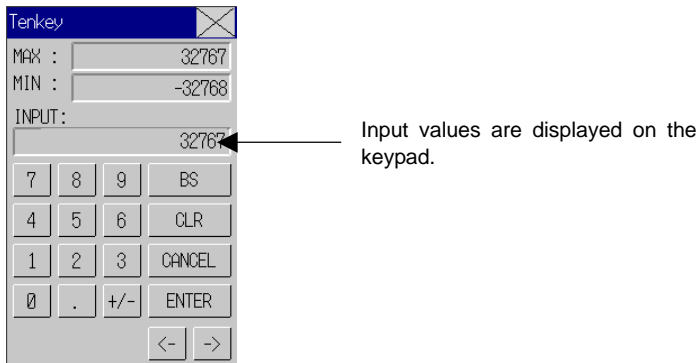

\$SB18: OFF



**Note**

- ◆ A keypad with temporary input is not displayed on the test screen. The normal keypad is always displayed.
- ◆ If display of the unit name is specified for Numeral Display & Input objects, the unit will also be added to the keypad with a temporary input field.

**Input Prohibit (\$SB19)**

\$SB19 prohibits input. Input to base and pop-up screens is prohibited when \$SB19 is turned ON. However, \$SB and \$SW controls, e.g., screen switching using SW0, are not prohibited. Input using tenkey pads, error dialog boxes, or other dialog boxes displayed by the system is not prohibited either.

To clear input prohibit, turn OFF \$SB19 from the host or enter the password specified using \$SW13 in the password dialog box displayed when the screen is touched. The system automatically turns OFF \$SB19 if a password is used to clear input prohibit.

If \$SW13 is not a value between 1 and 5, \$SB19 (input prohibit clear) will be turned OFF without displaying the password dialog box when the screen is touched.

If a password character string has not been set under the password settings for the password number specified using \$SW13, \$SB19 will be turned OFF without displaying the password dialog box, i.e., input prohibit is cleared when the screen is touched.

**Reference**

- ◆ The password character string for each login level is set under either **PT - Password** on the CX-Designer or **System Menu - Password** on the PT.
- ◆ Use the Touch Switch Lock Control Flag to not display the password input dialog box used to cancel input prohibition when the screen is touched and keep input prohibited. Refer to 3-10-2 *Prohibiting and Allowing Input to All Screen Functional Objects* for information on the Touch Switch Lock Control Flag.

**Contrast Adjustment (\$SB20, \$SB21, \$SB22, and \$SB23) (For NS5-SQ with Lot Number 2110 or Earlier, or NS5-MQ Only)**

\$SB20 to \$SB23 are used to adjust contrast.

\$SB20 increases the contrast by 10.

\$SB21 increases the contrast by 1.

\$SB22 decreases the contrast by 1.

\$SB23 decreases the contrast by 10.

These bits turn OFF automatically once the contrast has been adjusted.

If \$SB20 to \$SB23 is turned ON while displaying the screen saver, the screen saver will remain.

**Note**

- ◆ If more than one of these bits turns ON at the same time, the order of priority is \$SB20, \$SB21, \$SB22, and then \$SB23.
- ◆ Contrast can be adjusted in 100 gradations.
- ◆ No processing will be executed for the NS15, NS12, NS10, and NS8 even if these bits are turned ON.

**Video Capture (\$SB24)**

\$SB24 captures the image being displayed and saves it as BMP format on a Memory Card. When \$SB24 is turned ON, the captured data will be output to \LOG\CAPTURE under the Memory Card directory as XXX\_VideoXX\_XXX.bmp. If an error occurs during the operation, \$SB24 will turn OFF and \$SB47 will turn ON.

The following rules will be used for saving captured data.

The screen number, position of the image, and the file number will be automatically added to the file name when executing the video capture.



9999 \_ VideoLT \_ 999. bmp

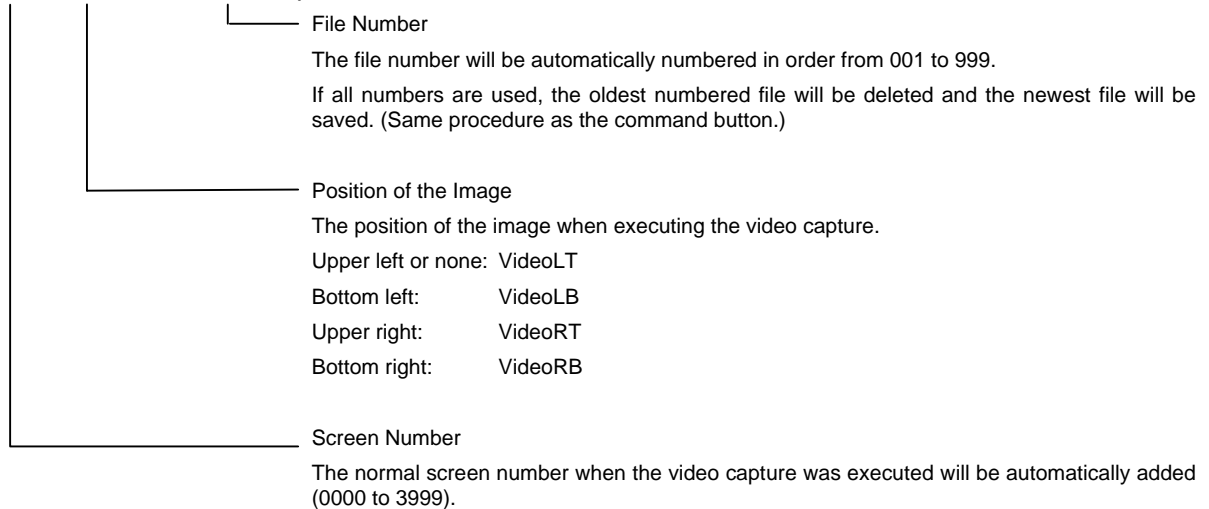

### Start Printing/Capture Screen (\$SB25) (Not supported by NS5-□Q0□.)

\$SB25 starts printing the screen displayed on the PT, or capturing and saving it as a bitmap file on the Memory Card. When "1" is stored in \$SW11 and \$SB25 is turned ON, the currently displayed screen is captured and a screen\_cap\_XXX.bmp file is output to the LOG\CAPTURE folder in the Memory Card directory. If a value other than "1" is stored in \$SW11 and \$SB25 is turned ON, the currently displayed screen is printed. \$SB25 will remain ON until turned OFF either from the host or by using a functional object. Printing or screen capture will not be started again while the screen is being printed or a bitmap file is being output, even if \$SB25 is turned ON again.

screen \_ cap \_ 999. bmp

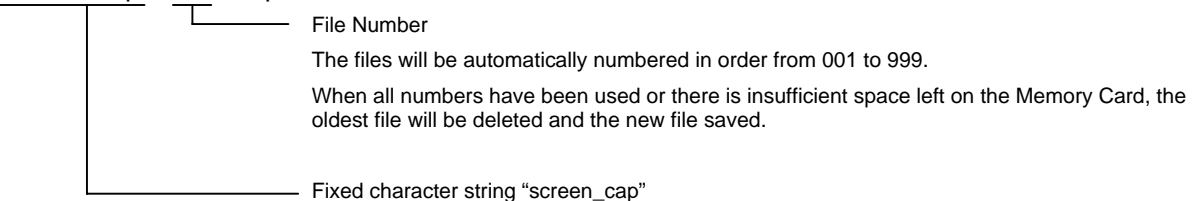

#### Note

- ◆ When a video object is on the screen, the video image can not be printed or saved as a BMP file by using \$SB25.
- ◆ \$SB26 to \$SB29 will not function while "1" is stored in \$SW11.

### Stop Printing (\$SB26)

\$SB26 stops printing the screen displayed on the PT. If \$SB26 is turned ON while \$SB30 is ON, printing is stopped and then \$SB30 turns OFF. If printing has already started, it may not be possible to stop it even if \$SB26 is turned ON.

### Test Pattern Printing (\$SB27)

\$SB27 starts printing a printer test pattern. When \$SB27 is turned ON, printing the test pattern is started. \$SB27 will remain ON until turned OFF either from the host or using a functional object. The test printing operation depends on the printer. Refer to the manual for your printer for details. When a PictBridge-compatible printer is used, a special test pattern will be printed by the PT.



**Printer head-cleaning (\$SB28)**

\$SB28 starts cleaning the printer head. When \$SB28 is turned ON, the cleaning of the head is started. \$SB28 will remain ON until turned OFF either from the host or using a functional object. The head cleaning operation depends on the printer. Refer to the manual for your printer for details. If a PictBridge-compatible printer is being used, the setting of \$SB28 will be ignored.

**Update Printer Status (\$SB29)**

\$SB29 controls the Printer Busy Status (\$SB30) and the Notification of Printer Error (\$SB31). When \$SB29 is turned ON, \$SB30 and \$SB31 turn ON and OFF. If printer operation has completed normally, however, \$SB31 will not turn ON. If a PictBridge-compatible printer is being used, the printer may not output a printer error to \$SB31. If an error is not output, turn ON Start Printing/Capture Screen (\$SB25) or Update Printer Status (\$SB29) to output the printer error to \$SB31.

**Printer Busy Status/Capture Busy Status (\$SB30)**

\$SB30 turns ON when the following operations are being executed: Start Printing, Test Pattern Printing, Printer head-cleaning, and Capture Screen. \$SB30 turns OFF automatically when these operations have been completed. It also turns OFF if the Stop Printing bit turns ON when printing a screen.

**Notification of Printer Error/Capture Screen Error (\$SB31)**

\$SB31 turns ON when any of the following operations end in an error: Start Printing, Capture Screen, Test Pattern Printing, Printer head-cleaning, or Update Printer Status. It also turns ON if a printer is not detected when the PT is started or if an error is detected, including USB port errors, printer not connected errors, broken connection errors, no paper errors, no ink errors, and other hardware printer errors. \$SB31 turns OFF when all errors related to Start Printing, Capture Screen, Test Pattern Printing, Printer head-cleaning, or Update Printer Status have been eliminated.

**Note**

- **Checking Printer Operating Status**

\$SB30 and \$SB31 can be used to check operating status and to check for errors. Use these bits are shown in the following flowchart.

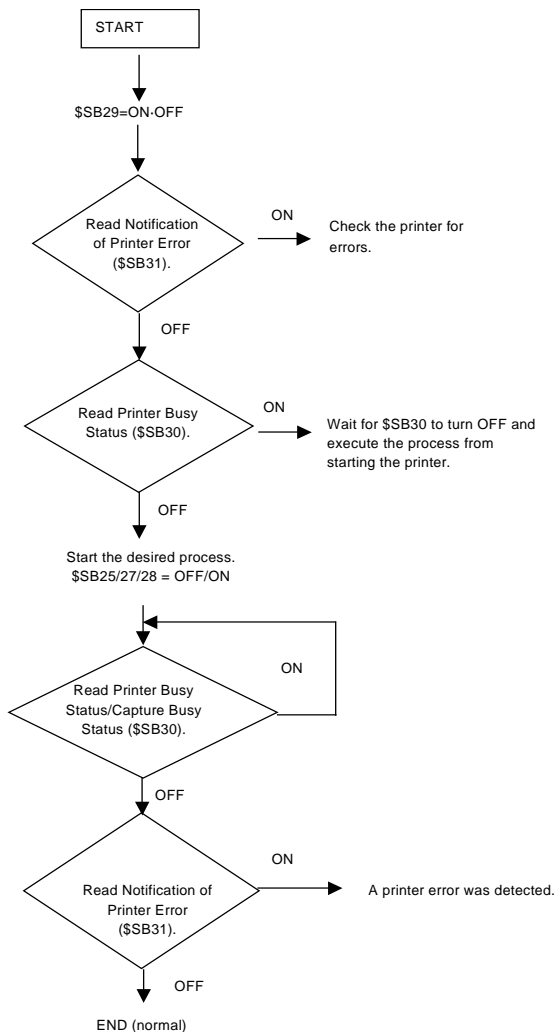
**Initialize Alarm/Event History (\$SB32)**

\$SB32 initializes alarm and event history data. When \$SB32 is turned ON, the alarm and event history information recorded in the PT is initialized. Once the initialization has been completed, the system automatically turns OFF \$SB32. The history data to be initialized can be specified using \$SW40.

**Save Alarm/Event History (\$SB33)**

\$SB33 saves alarm and event history data. When \$SB33 is turned ON, the alarm and event history data is saved to the Memory Card as a CSV file. Once the data has been saved, the system automatically turns OFF \$SB33.

Alarm data is output to log\Alarm.csv (classified into high, middle, and low level alarms) and event data is output to \log\Event.csv files on the Memory Card. The file names are fixed, and files previously output to the Memory Card will be overwritten.

If no alarms have accumulated, alarm data will not be saved. (\$SB33 will turn OFF and \$SB47 will not turn ON.)

If no events have accumulated, event data will not be saved. (\$SB33 will turn OFF and \$SB47 will not turn ON.)

If an error occurs during the save operation (e.g., the Memory Card is not in place, there is insufficient free disk space, or the Memory Card is damaged), \$SB33 will turn OFF and \$SB47 will turn ON.

No error message will appear on the screen, however, when an error occurs.

If \$SB32 and \$SB33 turn ON simultaneously, initialization will be executed first. For this reason, Alarm.CSV and Event.CSV files will not be created.

### **Internal Holding Memory (\$HB/\$HW) Initialization (\$SB34)**

\$SB34 initializes the internal holding memories. When \$SB34 is turned ON, the internal holding memories (\$HB0 to \$HB8191 and \$HW0 to \$HW8191) are initialized. Once the initialization has been completed, the system automatically turns OFF \$SB34.

### **Initialize Data Log (\$SB35)**

\$SB35 initializes the data log data. When "0" is stored in \$SW37 and \$SB35 is turned ON, data log information for all groups recorded by the PT is initialized. If a group number is stored in \$SW37 and \$SB35 is turned ON, the data log information for that group only will be initialized. Once the initialization has been completed, the system automatically turns OFF \$SB35.

### **Save Data Log (\$SB36)**

\$SB36 saves data log data. When "0" is stored in \$SW37 and \$SB36 is turned ON, log data for all groups is saved to the Memory Card as a CSV file. If a group number is stored in \$SW37 and \$SB36 is turned ON, the data log information for that group only will be saved as a CSV file. Once the data has been saved, the system automatically turns OFF \$SB36.

When "0" is stored in \$SW37 and \$SB36 is turned ON, the data is saved to a series of files called Trend001.CSV to Trend999.CSV in the Memory Card in the directory \log\ trend. If a group number is stored in \$SW37 and \$SB36 is turned ON, the data is saved to a series of files called Trd00001.CSV to Trd99999.CSV. The name of the folder will be the name of the output file. Trd00 to Trd99 can be changed using the data log settings. Each time data is saved, a new file is automatically created, incrementing the file numbered each time. Up to 999 files can be saved. Only up to 099 CSV files will be saved in each folder if the output file names are six characters or longer. When the number of files exceeds 999, existing files are overwritten in order beginning with Trend001.CSV or Trd###001CSV.

If there is no accumulated data log, the group number and data collection address will be output. (\$SB36 will turn OFF and \$SB47 will not turn ON.)

If an error occurs during the save operation (e.g., the Memory Card is not in place, there is insufficient free disk space, or the Memory Card is damaged), \$SB36 will turn OFF and \$SB47 will turn ON.

No error message will appear on the screen, however, when an error occurs.

If \$SB35 and \$SB36 turn ON simultaneously, initialization will be executed first. For this reason, no Trend#.CSV file will be created.

### **Initialize Operation Log (\$SB37)**

\$SB37 initializes the operation log data. When \$SB37 is turned ON, the operation log information recorded in the PT is initialized. Once the initialization has been completed, the system automatically turns OFF \$SB37.

**NS Series Programming Manual**

**Save Operation Log (\$SB38)**

\$SB38 saves operation log data. When \$SB38 is turned ON, the operation log data is saved to the Memory Card as a CSV file. Once the data has been saved, the system automatically turns OFF \$SB38.

The data is output to a file called Operat.csv in the Memory Card \log\ directory.

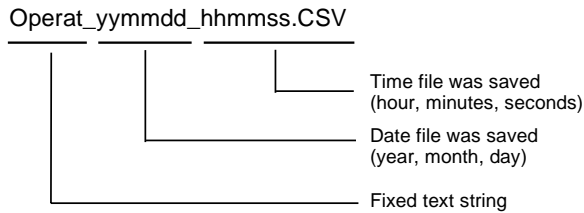

If there is no accumulated data log, only the title line will be output. (\$SB33 will turn OFF and \$SB47 will not turn ON.)

If an error occurs during the save operation (e.g., the Memory Card is not in place, there is insufficient free disk space, or the Memory Card is damaged), \$SB38 will turn OFF and \$SB47 will turn ON.

No error message will appear on the screen, however, when an error occurs.

If \$SB37 and \$SB38 turn ON simultaneously, initialization will be executed first. For this reason, no Operat.CSV file will be created.

**Note**

- ◆ For project versions earlier than version 8.0, operation log data is output to a file called Operat.CSV in the Memory Card\log\directory. The file name is always the same, so any previously output data is overwritten.

**Operation Log Control (\$SB39, \$SB40, and \$SB41)**

Bits \$SB39 to \$SB41 control the operation log. \$SB39 controls functional object operations and changes to communications addresses. \$SB40 controls screen switching operations, and \$SB41 controls macro operations.

When each of the bits \$SB39 to \$SB41 turn ON, the relevant logging operation starts. The logging operation is ended when the bits turn OFF.

**Screen Switching**

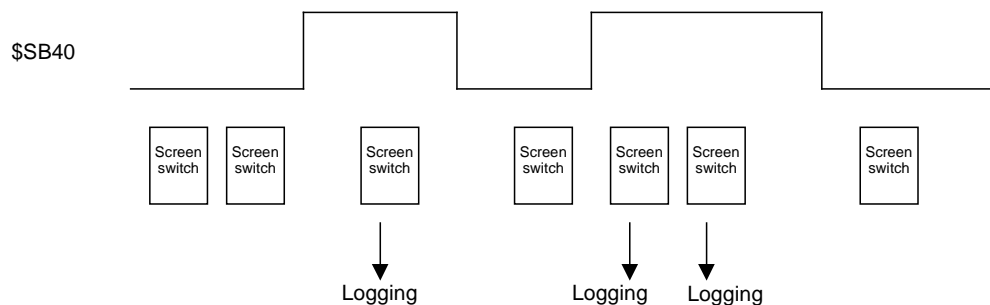

Any instance of screen switching executed while \$SB40 is ON will be logged.

**Initialize Error Log (\$SB42)**

\$SB42 initializes the error log data. When \$SB42 is turned ON, the error log information recorded in the PT is initialized. Once the initialization has been completed, the system automatically turns OFF \$SB42.

### Save Error Log (\$SB43)

\$SB43 saves error log data. When \$SB43 is turned ON, the error log data is saved to the Memory Card as a CSV file. Once the data has been saved, the system automatically turns OFF \$SB43.

The data is output to a file called MacroErr.csv in the Memory Card \log\ directory. The file names are fixed and files previously output to the Memory Card will be overwritten.

If there is no accumulated data log, only the title line will be output. (\$SB43 will turn OFF and \$SB47 will not turn ON.)

If an error occurs during the save operation (e.g., the Memory Card is not in place, there is insufficient free disk space, or the Memory Card is damaged), \$SB43 will turn OFF and \$SB47 will turn ON.

No error message will appear on the screen, however, when an error occurs.

If \$SB42 and \$SB43 turn ON simultaneously, initialization will be executed first. For this reason, no MacroErr.CSV file will be created.

#### Reference

- ◆ Log data can be output in multibyte code or Unicode. This enables outputting data displayed in other languages as log data. For details on using other languages, refer to *Reference – Multi-language Display* in the *CX-Designer Online Help*.

### Macro Error Dialog Control (\$SB45)

\$SB45 changes the processing for macro errors. If \$SB45 turns ON, no error dialog box is displayed when a macro error occurs but the execution of macro processing is stopped. If \$SB45 is turned OFF, an error dialog box will be displayed and macro execution will be stopped.

#### Note

- ◆ When a macro error occurs, processing of the macro where the error occurred will be interrupted regardless of whether or not \$SB45 is ON or OFF, but other macro processing will continue.

### Notification Macro Error (\$SB46)

\$SB46 turns ON when a macro execution error occurs.

\$SB46 will remain ON until turned OFF from the host, using a functional object, or other method.

If a macro error occurs when values are being changed, the macro error notification is executed after the Macro Error Dialog Box is closed by pressing the OK Button. Macro error notification will be executed immediately after any other macro error occurs.

### Logging Process Error Flag (\$SB47)

\$SB47 turns ON if an error occurs during alarm, data log, operation history, error log processing, or video capture.

\$SB47 will remain ON until turned OFF from the host, using a functional object, or other method.

### Memory Free Space Check (\$SB48)

\$SB48 turns ON when the free space on the Memory Card mounted to the PT drops below a specified size when saving data to the Memory Card.

The amount of free space that will trigger the warning is set using *Free Space* under *CX-Designer System Setting – Initial*. The default is 1,024 Kbytes.

### Stop Memory Card (\$SB49)

\$SB49 is turned ON to remove the Memory Card. When \$SB49 is turned ON, the Memory Card power

supply turns OFF and the Memory Card can be removed from the PT. \$SB49 automatically turns OFF after the Memory Card has been removed.

### Memory Card Removing Status (Power OFF) (\$SB50)

\$SB50 notifies the result of executing \$SB49. When \$SB49 is turned ON and the Memory Card can be removed, \$SB50 turns ON. After the Memory Card has been removed and \$SB49 automatically turns OFF, and \$SB50 also automatically turns OFF.

This bit indicates the power supply status of the Memory Card. If \$SB50 is OFF, it indicates that the power is ON.

### Periodical Data Log Save in Process Flag (\$SB51)

\$SB51 turns ON when the data log is being periodically saved. When saving is completed, the system automatically turns \$SB51 OFF.

### Data Block Operation Complete Flag (\$SB52)

\$SB52 turns ON when command button data block control has been completed. \$SB52 will remain ON until it is turned OFF from the host, using a functional object, or other method.

### Prohibit Screen Saver Startup (\$SB53)

Bit \$SB53 stops the screen saver from starting. When \$SB53 is ON, the screen saver will not start. When \$SB53 is OFF, the screen saver will be started/canceled normally by the Screen Saver Start/Cancel Bit (\$SB9) as specified with the *Screen Saver* settings on the System Settings Window's PT Tab Page.

The following table shows the operation of the NS-series PT when the status of \$SB9 or \$SB53 changes.

Status of \$SB9	Status of \$SB53	Operation
OFF	OFF → ON	Screen display continues. (The screen saver will not start.)
OFF	ON → OFF	The screen saver starts after the Screen Saver Startup Time specified in the System Settings Window.
ON	OFF → ON	The screen saver is canceled.
ON	ON → OFF	The screen saver starts after 3 s.
OFF → ON	OFF	The screen saver starts after 3 s.
ON → OFF	OFF	The screen saver is canceled.
OFF → ON	ON	Screen display continues. (The screen saver will not start.)
ON → OFF	ON	Screen display continues. (The screen saver will not start.)

### Password Level Operable Status (\$SB54 to \$SB58)

If passwords are being used with the password level function, flags \$SB54 to \$SB58 indicate the range of functional objects that can be manipulated in the window.

Example: Authenticating level 3

\$SB54 ON	}	Operations are allowed on functional objects set to levels 1 to 3.
\$SB55 ON		
\$SB56 ON		
\$SB57 OFF	}	Operations are not allowed on functional objects set to level 4 or 5.
\$SB58 OFF		

If the functional object's Display setting in the Control Flag Tab is set for *Indirect Address* and *Display When Address ON* and the status flag is indirectly specified, the status flag can be used to display only the functional objects that are operable in that current password level.

\$SB54 is turned ON when level 1 or higher authentication is completed. \$SB54 is turned OFF when authentication is cancelled.

\$SB55 is turned ON when level 2 or higher authentication is completed. \$SB55 remains OFF during level 1 and is turned OFF when authentication is cancelled.

\$SB56 is turned ON when level 3 or higher authentication is completed. \$SB56 remains OFF during level 2 or lower and is turned OFF when authentication is cancelled.

\$SB57 is turned ON when level 4 or higher authentication is completed. \$SB57 remains OFF during level 3 or lower and is turned OFF when authentication is cancelled.

\$SB58 is turned ON when level 5 or higher authentication is completed. \$SB58 remains OFF during level 4 or lower and is turned OFF when authentication is cancelled.

**Reference**

- ◆ The status flags will not operate if the *Function mode* is set to enable a password without levels in the Password Setting Dialog Box. Refer to 2-8-15 Passwords (Extension Tab) for details on password settings.

System bit memory (\$SB) can be allocated to the following areas on the host PLC.

Symbol	C-series PLCs	Allocation	CVM1/CV-series PLCs	Allocation	CS/CJ-series PLCs	Allocation
None	I/O area (IR)	○	I/O area (CIO)	○	I/O area (CIO)	○
H	HR Area	○	_____	—	HR Area	○
A	AR Area	○	AR Area	×	AR Area	○
L	LR Area	○	_____	—	LR Area (See note 1.)	○
T	Timer present values	×	Timer present values	×	Timer present values	×
TU	_____	—	_____	—	Timer Completion Flags	×
C	Counter present values	×	Counter present values	×	Counter present values	×
CU	_____	—	_____	—	Counter Completion Flags	×
W	_____	—	_____	—	Work Area	○
TK	_____	—	_____	—	Task Flags	×
D	DM Area	○	DM Area	○	DM Area	○
E	EM Area (See note 2.) (Current bank)	○	EM Area (Current bank)	○	EM Area (Current bank)	○
E0_	_____	—	_____	—	EM Area Bank 0	○
§	§	§	§	§	§	§
E18_	_____	—	_____	—	EM Area Bank 18	○

- Note 1. LR 00000 to LR 00199 are converted to and used as I/O area words CIO 01000 to CIO 01199.
- Note 2. C200HX/HG/HE-E/-ZE PLCs are the only C-series PLCs that support the EM Area (EM). All bits in the AR Area for CVM1/CV-series PLCs are allocated for system functions and cannot be used for any other application. The ranges for each area vary with the PLC model. Refer to Appendix 3 PLC Memory Areas. Refer to System Settings and Project Properties in the CX-Designer Online Help for details on allocation methods.

Set a BOOL variable with 64 elements when allocating a tag.



## 2-4-2 System Word Memory (\$SW)

System word memory (\$SW) is used to exchange information between the host and the PT in word units, such as for controlling the PT and notifying the host of PT status.

The system word memory contains 41 items with predefined functions.

The system word memory is listed in the following table.

Address	Classification	Function
\$SW0	Notification/control	Current screen number
\$SW1	Notification/control	Current pop-up screen 1 number
\$SW2	Notification/control	Position of pop-up screen 1 (X coordinate)
\$SW3	Notification/control	Position of pop-up screen 1 (Y coordinate)
\$SW4	Notification/control	Current pop-up screen 2 number
\$SW5	Notification/control	Position of pop-up screen 2 (X coordinate)
\$SW6	Notification/control	Position of pop-up screen 2 (Y coordinate)
\$SW7	Notification/control	Current pop-up screen 3 number
\$SW8	Notification/control	Position of pop-up screen 3 (X coordinate)
\$SW9	Notification/control	Position of pop-up screen 3 (Y coordinate)
\$SW10	Notification/control	Current label number
\$SW11	Control	Destination (0: Printer, 1: Memory Card)
\$SW12	Control	Backlight Brightness Adjustment (1 to 32) (See note 2.)
\$SW13	Control	Password number for canceling input prohibition
\$SW14	Notification	Current time (min, s)
\$SW15	Notification	Current date and time (day, hour)
\$SW16	Notification	Current date (year, month)
\$SW17	Notification	Current day (day of the week)
\$SW18	Notification	No. of alarm/event occurred
\$SW19	Notification	Occurred alarm/event ID
\$SW20	Notification	Cancelled alarm/event ID
\$SW21	Notification	Alarm/event ID of alarm/event object macro
\$SW22	–	Reserved
\$SW23	Notification	Macro error number
\$SW24	Notification	Screen No. Having Macro Error
\$SW25	Notification	Object ID Having Macro Error
\$SW26	Notification	Macro Timing Having Error
\$SW27	Control	Offset value for index I0
\$SW28	Control	Offset value for index I1
\$SW29	Control	Offset value for index I2
\$SW30	Control	Offset value for index I3
\$SW31	Control	Offset value for index I4
\$SW32	Control	Offset value for index I5
\$SW33	Control	Offset value for index I6
\$SW34	Control	Offset value for index I7
\$SW35	Control	Offset value for index I8
\$SW36	Control	Offset value for index I9
\$SW37	Control	Data log group number
\$SW38	Notification	Data block error number
\$SW39	Notification	Authentication Level
\$SW40	Control	Range for initializing alarm/event history

Note 1: The notification words are not write-prohibited. In addition, the system will not restore values, except when the status has changed.

Note 2: Applies only to NS5-SQ1/-TQ1 PTs with lot number 15Z0 or later.



Words in the PLC are allocated to system word memory (\$SW). Set the allocation addresses for the system memory on the Initial Tab Page. You can select the data type to store in memory to BCD or binary for each group by pressing the **System Memory List** Button on the Initial Tab Page.

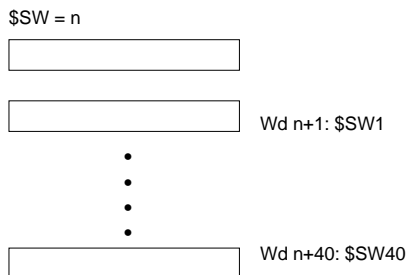

### Note

- ◆ System memory allocations in the PLC areas can be allocated the same way as for the NT Series. For details, refer to 2-4-3 *System Memory Compatibility with the NT Series*.
- ◆ Set an array variable with 41 elements when allocating a tag. The data type must be UINT, INT, UINT\_BCD, CHANNEL, or WORD.

### Current Screen Number (\$SW0)

\$SW0 stores the screen number for the current screen. (Stored in BCD or binary.)

If a screen number is written to \$SW0, the display will switch to that screen.

The display will not switch to that screen, however, if that screen does not exist or if it is a pop-up screen. In such cases, no error message will be displayed but the system will change the screen number stored in \$SW0 back to the original screen number. (\$SB2 screen switch strobe will not be notified.)

If screens are switched frequently, the display update may take some time and communications may be delayed.

If no initial display screen exists, screen 0 will be initially set to \$SW0.

If screens are switched while displaying the screen saver, the screen saver will be canceled.

### Current Pop-up Screen 1 Number (\$SW1)

\$SW1 stores the screen number for the current pop-up screen 1. (Stored in BCD or binary.)

The value "0" will be stored in \$SW1 if no pop-up screen is open.

If a screen number is written to \$SW1, that pop-up screen will be displayed.

The display will not switch to that screen, however, if that screen does not exist or if it is a base screen. In such cases, no error message will be displayed but the system will change the screen number stored in \$SW1 back to the original screen number.

If pop-up screens are opened and closed frequently, the display update may take some time and communications may be delayed.

The pop-up screen will close if 0 is written to \$SW1. Also, 0 will be set to the pop-up screen display position (\$SW2 and \$SW3).

If a pop-up screen is opened, closed, or switched while displaying the screen saver, the screen saver will be canceled.

### Position of Pop-up Screen 1 (\$SW2 and \$SW3)

\$SW2 and \$SW3 store the display position for pop-up screen 1. (Stored in BCD or binary.)

The upper left X coordinate for pop-up screen 1 is stored in \$SW2 and the upper left Y coordinate is stored in \$SW3.

If the display position is written directly to \$SW2 and \$SW3, the pop-up screen will move to the specified position.

The display size is limited so that the pop-up screen does not protrude outside the screen display range. The display position will be such that the whole pop-up screen is displayed.

If pop-up screens are moved while the screen saver is displayed, the screen saver will be canceled.

The display position when pop-up screen 1 is opened cannot be specified using \$SW2 and \$SW3.

#### **Current Pop-up Screen 2 Number (\$SW4)**

\$SW4 stores the screen number for the current pop-up screen 2. (Stored in BCD or binary.)

The value "0" will be stored in \$SW4 if no pop-up screen is open.

If a screen number is written to \$SW4, that pop-up screen will be displayed.

The display will not switch to that screen, however, if that screen does not exist or if it is a base screen. In such cases, no error message will be displayed but the system will change the screen number stored in \$SW4 back to the original screen number.

If pop-up screens are opened and closed frequently, the display update may take some time and communications may be delayed.

The pop-up screen will close if 0 is written to \$SW4. Also, 0 will be set for the pop-up screen display position (\$SW5 and \$SW6).

If a pop-up screen is opened, closed, or switched while the screen saver is displayed, the screen saver will be canceled.

#### **Position of Pop-up Screen 2 (\$SW5 and \$SW6)**

\$SW5 and \$SW6 store the display position for pop-up screen 2. (Stored in BCD or binary.)

The upper left X coordinate for pop-up screen 2 is stored in \$SW5 and the upper left Y coordinate is stored in \$SW6.

If the display position is written directly to \$SW5 and \$SW6, the pop-up screen will move to the specified position.

The display size is limited so that the pop-up screen does not protrude outside the screen display range. The display position will be such that the whole pop-up screen is displayed.

If a pop-up screen is opened, closed, or switched while the screen saver is displayed, the screen saver will be canceled.

The display position when pop-up screen 2 is opened cannot be specified using \$SW5 and \$SW6.

#### **Current Pop-up Screen 3 Number (\$SW7)**

\$SW7 stores the screen number for the current pop-up screen 3. (Stored in BCD or binary.)

The value "0" will be stored in \$SW7 if no pop-up screen is open.

If a screen number is written to \$SW7, that pop-up screen will be displayed.

The display will not switch to that screen, however, if that screen does not exist or if it is a base screen. In such cases, no error message will be displayed but the system will change the screen number stored in \$SW7 back to the original screen number.

If pop-up screens are opened and closed frequently, the display update may take some time and communications may be delayed.

The pop-up screen will close if 0 is written to \$SW7. Also, 0 will be set to the pop-up screen display position (\$SW8 and \$SW9).

If a pop-up screen is opened, closed, or switched while the screen saver is displayed, the screen saver will be canceled.

#### **Position of Pop-up Screen 3 (\$SW8 and \$SW9)**

\$SW8 and \$SW9 store the display position for pop-up screen 3. (Stored in BCD or binary.)

The upper left X coordinate for pop-up screen 3 is stored in \$SW8 and the upper left Y coordinate is stored in \$SW9.

If the display position is written directly to \$SW8 and \$SW9, the pop-up screen will move to the specified position.

The display size is limited so that the pop-up screen does not protrude outside the screen display range. The display position will be such that the whole pop-up screen is displayed.

If a pop-up screen is opened, closed, or switched while the screen saver is displayed, the screen saver will be canceled.

The display position when pop-up screen 3 is opened cannot be specified using \$SW8 and \$SW9.

### Current Label Number (\$SW10)

\$SW10 stores the current label number. (Stored in BCD, between 0 and 15, or in binary, between 0 and F.)

If a label number is written to \$SW10, the display will switch to that label.

No error message will be displayed if a label number that does not exist has been specified but the system will store the original label number in \$SW10.

### Destination (0: Printer, 1: Memory Card) (\$SW11)

\$SW11 is used to specify whether to print the screen or save the screen capture data to the Memory Card. Store "0" in \$SW11 and turn ON \$SB25 to execute printing. Store "1" in \$SW11 and turn ON \$SB25 to execute screen capture.

### Backlight Brightness Adjustment (\$SW12) (NS5-SQ1/-TQ1 with Lot Number 15Z0 or Later Only)

\$SW12 is used to adjust the brightness of the backlight. Store 1 to 32. If \$SB6 to \$SB8 and \$SW12 are changed at the same time, the backlight brightness will be changed to the setting for which the change was detected last inside the PT.

### Password Number for Canceling Input Prohibition (\$SW13)

\$SW13 is used to specify the password number for clearing input prohibit when \$SB19 is ON. (Stored in BCD or binary.) The password dialog box will be displayed if the screen is touched when \$SB19 is ON. However, the value stored in \$SB13 immediately after touching the screen will be used for the password.

Touch the screen when input is prohibited by \$SB19 to display a password dialog box. The value stored in \$SW13 immediately after the screen has been touched will be used as the password number.

### Current Date and Time (\$SW14, \$SW15, \$SW16, and \$SW17)

Words \$SW14 to \$SW17 store the current date and time in BCD or binary.

The storage formats are shown below.

\$SW14 stores the minutes and seconds.

Bit 15                      8 7                      0



BCD: min (00 to 59) s (00 to 59)

Binary: min (00 to 3B) s (00 to 3B)

\$SW15 stores the date and hour.

Bit 15                      8 7                      0

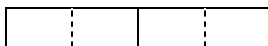

BCD: date (01 to 31) hour (00 to 23)

Binary: date (01 to 1F) hour (00 to 17)

\$SW16 stores the year (last two digits) and month.

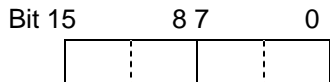

BCD: year (00 to 99) month (01 to 12)

Binary: year (00 to 63) month (01 to 0C)

\$SW17 stores the day of the week.

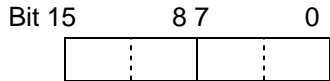

BCD/binary: (00 fixed) day of week (00 to 06)

Sun: 00; Mon: 01; Tue: 02; Wed: 03; Thur: 04; Fri: 05; Sat: 06

### No. of Alarm/Event Occurred (\$SW18)

\$SW18 stores the number of generated alarms and events. (Stored in BCD or binary.)

The total number of alarms and events is stored.

### Alarm/Event ID Storage (\$SW19, \$SW20, and \$SW21)

The last generated alarm or event ID number is written to \$SW19. (Stored in BCD or binary.)

The last cleared alarm or event ID number is written to \$SW20. (Stored in BCD or binary.)

The alarm or event ID displayed on the relevant alarm/event display object is written to \$SW21 when the Pressing a Display Area macro is executed. Alternatively, the alarm/event ID number selected when the Selecting an Alarm/Event macro is executed for the alarm/event summary/history object is written to \$SW21. (Stored in BCD or binary.) If the macro is executed when nothing is displayed on the alarm/event display object or alarm/event summary & history object, then nothing will be written to \$SW21.

### Macro Error Number (\$SW23)

The macro execution error number is stored in \$SW23. There are no errors if 0 is stored in \$SW23.

The error number is held until 0 is written to \$SW23 from the host, using a functional object, or other method. (Stored in BCD or binary.)

#### Note

- ◆ The following values are set to \$SW23, depending on the macro error.
 

1: Program error	2: 0 allocation error
3: BCD error	4: Argument value error
- ◆ The last generated macro execution error number is stored in \$SW23 if macros are executed alternatively as follows: no error, error, no error, etc.

### Screen No. Having Macro Error (\$SW24)

The screen number where the macro error occurred is stored in \$SW24. FFFFh is stored for project macros. (Stored in BCD or binary.)

### Object ID Having Macro Error (\$SW25)

The ID number of the functional object where the macro error occurred is stored in \$SW25. FFFFh is stored for project/screen macros. (Stored in BCD or binary.)

### Macro Timing Having Error (\$SW26)

The macro execution timing when the macro error occurred is stored in \$SW26. (Stored in BCD or binary.)

- 0 (0): When loading a project
- 4 (4): Alarm/Event ON

- 5 (5): Alarm/Event OFF
- 16 (10): When loading a screen
- 17(11): When unloading a screen
- 32 (20): Touch ON
- 33 (21): Touch OFF
- 34 (22): Before Inputting Numeral and String
- 35 (23): Before Writing Numeral and String
- 37 (25): When Changing Numeral or String
- 38 (26): When selecting a list
- 48 (30): When pressing a Display Area
- 49 (31): When selecting an Alarm/Event

Note: The values inside parentheses ( ) are binary.

### Index (\$SW27 to \$SW36)

\$SW27 to \$SW36 store index numbers. Each of the index numbers correspond to I0 to I9 set using address input. (Stored in BCD or binary.)

If an illegal value is set in BCD as the index number (e.g., AAAAh) when stored in BCD, the index will operate as index 0. (Values between –999 and 9999 (BCD) or between –32768 and 32767 (binary) can be specified as index values.)

### Data Log Group Number (\$SW37)

\$SW37 stores a data log group number (Stored in BCD or binary.). When \$SB35 (Initialize Data Log) or \$SB36 (Save Data Log) is turned ON, the data log for the group number stored in \$SW37 is either initialized or saved.

When the data logs for all groups are initialized or saved, “0” is stored in \$SW37.

### Data Block Error Number (\$SW38)

The numbers of any errors that occur during command button – data block control execution are stored in \$SW38 (in BCD or binary).

- 0 (0): Normal end
- 10 (A): The specified group number does not exist, i.e., the specified number is not between 1 and 100 or the specified number between 1 and 100 has not been registered.
- 11 (B): The specified record number does not exist, i.e., the specified number is not between 0 and 999 (exceeds the maximum number of records per group) or data has not been registered for the specified number between 0 and 999.
- 12 (C): An attempt was made to insert data into a file for which the set number of records for that group have already been registered.
- 13 (D): The file does not exist in the specified location or it cannot be opened.
- 14 (E): A CSV file cannot be created to save the data.
- 15 (F): A write error (e.g., insufficient space) occurred when writing the CSV file.
- 16 (10): A communications error occurs when writing or reading the communications address.
- 17 (11): The sum of the specified beginning address in PT memory and the record size exceeds \$W32767.
- 18 (12): Memory cannot be acquired for reading or writing.

Note: The values inside parentheses ( ) are binary.

### Authentication Level (\$SW39)

If passwords are being used with the password level function, the current authentication level is contained in \$SW39. When the authentication is cleared, \$SW39 will contain 0. Use this word to display the authentication level or check the authentication level from the host.

**Reference**

- ◆ The password setting will not operate if the *Function mode* is set to enable passwords without levels in the Password Setting Window. Refer to 2-8-15 Passwords (*Expansion Tab*) for details on setting passwords.

**Range for Initializing Alarm/Event History (\$SW40)**

The option settings for initialization of alarm/event histories are made using \$SB32.

The alarm/event history to be initialized using the value contained in \$SW40 can be specified as shown in the following table.

\$SW40 value	Alarm/event history data initialized	Remarks
0	All alarm/event history data	Initializes all alarms/events, including current and unconfirmed alarms/events.
1	Cleared and confirmed alarm/event history data only	Initializes alarms/events including current alarms/events.
2	Cleared alarm/event history data only	Initializes alarms/events including unconfirmed alarms/events.
3	Confirmed alarm/event history data only	
4	Resolved alarm/event history data and number of occurrences	Initializes alarms/events including unconfirmed alarms/events. The current number of alarm/event occurrences will be set to 1.

Alarm/event history data is checked using the alarm/event summary/history object. Set the alarm history as the display data for the alarm/Event Summary/History object.

If \$SW40 contains a value other than 0 to 4, \$SB32 will not initialize when turned ON.

**Note**

- ◆ All values stored in system word memory can be selected from either BCD or binary. Select BCD or binary data storage for each group by pressing the **System Memory List** Button under **Settings - System Setting - Initial**.
- ◆ BCD values starting with Fh will be handled as negative values. (The value range for system word memory is -999 to 9999.)
- ◆ All addresses not specified above are reserved for system use. Do not access reserved addresses.

System word memory can be allocated to the following areas in the host PLC.

Symbol	C-series PLCs	Allocation	CVM1/CV-series PLCs	Allocation	CS/CJ-series PLCs	Allocation
None	I/O area (IR)	○	I/O area (CIO)	○	I/O area (CIO)	○
H	HR Area	×	————	—	HR area	○
A	AR Area	○	Auxiliary Area	×	Auxiliary Area	○
L	Link Area	○	————	—	LR Area (See note 1.)	○
T	Timer present values	×	Timer present values	×	Timer present values	×
TU	————	—	————	—	Timer Completion Flags	×
C	Counter present values	×	Counter present values	×	Counter present values	×
CU	————	—	————	—	Counter Completion Flags	×

Symbol	C-series PLCs	Allocation	CVM1/CV-series PLCs	Allocation	CS/CJ-series PLCs	Allocation
W	_____	—	_____	—	Work Area	○
TK	_____	—	_____	—	Task Flags	×
D	DM Area	○	DM Area	○	DM Area	○
E	EM Area (See note 2.) (Current bank)	○	EM Area (Current bank)	○	EM Area (Current bank)	○
E0_	_____	—	_____	—	EM Area Bank 0	○
§	§	§	§	§	§	§
E18_	_____	—	_____	—	EM Area Bank 18	○

Note 1. LR 00000 to LR 00199 are converted to and used as I/O area words CIO 01000 to CIO 01199.

2. C200HX/HG/HE-E/-ZE PLCs are the only C-series PLCs that support the EM Area (EM).

All bits in the CVM1/CV-series Auxiliary Area are allocated for system functions and cannot be used for any other application.

Set an array variable with 41 elements when allocating a tag. The data type must be UINT, INT, UINT\_BCD, CHANNEL, or WORD.

The ranges for each area vary with the PLC model. Refer to *Appendix 3 PLC Memory Areas*.

Refer to *System Settings and Project Properties* in the *CX-Designer Online Help* for details on allocation methods.

### 2-4-3 System Memory Compatibility with the NT Series

The method for allocating system memory in the PLC areas can be changed to the same method as for the NT30/620 and NT31/631 Series.

System memory in the NS Series can be allocated in the PLC areas as a PT status control area, PT status notification area, and Window control area, the same as the NT Series system memory.

This makes it easy to use PLC ladder programs as is when converting from the NT Series to the NS Series.

#### Note

- ◆ PLC area operations for functions that are unique to the NT Series will not operate in the NS Series.
- ◆ System memory that contains functions unique to the NS Series cannot be allocated to the PLC areas. Set \$SB and \$SW directly, e.g., by using a functional object or other object, when using system memory for these unique functions.
- ◆ This function will not work when connected to a PLC that is not manufactured by OMRON.
- ◆ Only numerical values in BCD format can be stored in the PLC areas if compatibility with the NT Series is enabled.
- ◆ Compatibility with NT-series PTs will be lost if tags are set as allocation addresses.

#### NT30/620 Series

The PT status control area allocations are listed in the following table.

Word	Function	Corresponding system memory
n	Screen number (control only) (See note.)	\$SW0 (currently displayed screen number)
n+1	Not used	—
n+2	Not used	—



Word	Function	Corresponding system memory
n+3	PT control bits	See the following table.
n+4	Not used	–

Note: Only numeric values in BCD format can be stored.

### PT Status Control Bits

Bit	Function	Corresponding system memory
15	Not used	–
14	Not used	–
13	Continuous Buzzer (See note 2.)	\$SB12 (Continuous Buzzer)
12	Short Intermittent (See note 2.)	\$SB13 (Short Intermittent)
11	Initialize Alarm History (See note 2.)	\$SB32 (Initialize alarm/event history)
10	Not used	–
9	Long Intermittent (See note 2.)	\$SB14 (Long Intermittent)
8	Backlight Mode (ON: Lit, OFF: Flashing) (See note 1.)	\$SB10 (Backlight Flash Control)
7	Print Screen (See note 2.)	\$SB25 (Start Printing/Capture Screen)
6	Not used	–
5	Not used	–
4	Not used	–
3	Not used	–
2	Not used	–
1	Not used	–
0	Not used	–

Note 1: The operation for Backlight Mode is different if NT compatibility is not used.

(The options if NT compatibility is not used are as follows: ON: Flashing, OFF: Lit.)

2: Notification will not be provided in the allocated PLC address even if the corresponding \$SB is directly manipulated. The value at the PLC address is always written to \$SB.

The PT status notification area allocations are listed in the following table.

Word	Function	Corresponding system memory
m	Screen Number (notification only) (See note 1.)	\$SW0 (currently displayed screen number)
m+1	Not used (always 0) (See note 2.)	–
m+2	PT Status Notification Bits	See the following table.

Note 1: Only numeric values in BCD format can be stored.

2: "0" is always written to the allocated address.

### PT Status Notification Bit

Bit	Function	Corresponding system memory
15	PT Operation Status	\$SB1 (RUN Signal (always ON))
14	Not used	–
13	Battery	\$SB4 (Battery voltage low notification)
12	Screen Switch Strobe	\$SB2 (Screen Switch Strobe)
11	Not used	–
10	Not used	–
9	Not used	–
8	Not used	–
7	Printer Busy Status	\$SB30 (Printer Busy Status/Capture Busy Status)



Bit	Function	Corresponding system memory
6	Not used	–
5	Not used	–
4	Not used	–
3	Not used	–
2	Not used	–
1	Not used	–
0	Not used	–

The window control area allocations are shown in the following table.

NS Series pop-up screens do not distinguish between global windows and local windows like the NT Series. The screens are differentiated as pop-up screen 1 (k to k+2), pop-up screen 2 (k+3 to k+5), and pop-up screen 3 (k+6 to k+8).

Word	Function	Corresponding system memory
k	Global Window Screen No. (See note.)	\$\$SW1 (Current Pop-up Screen 1 Number)
k +1	Global Window X Coordinate (See note.)	\$\$SW2 (Position of Pop-up Screen 1 (X Coordinate))
k +2	Global Window Y Coordinate (See note.)	\$\$SW3 (Position of Pop-up Screen 1 (Y Coordinate))
k +3	Local Window 1 Screen No. (See note.)	\$\$SW4 (Current Pop-up Screen 2 Number)
k +4	Local Window 1 X Coordinate (See note.)	\$\$SW5 (Position of Pop-up Screen 2 (X Coordinate))
k +5	Local Window 1 Y Coordinate (See note.)	\$\$SW6 (Position of Pop-up Screen 2 (Y Coordinate))
k +6	Local Window 2 Screen No. (See note.)	\$\$SW7 (Current Pop-up Screen 3 Number)
k +7	Local Window 2 X Coordinate (See note.)	\$\$SW8 (Position of Pop-up Screen 3 (X Co- ordinate))
k +8	Local Window 2 Y Coordinate (See note.)	\$\$SW9 (Position of Pop-up Screen 3 (Y Co- ordinate))

Note: Only numeric values in BCD format can be stored.

### NT31/631 Series

The PT status control area allocations are shown in the following table.

Word	Function	Corresponding system memory
n	Screen Number (control and notification) (See note.)	\$\$SW0 (currently displayed screen number)
n+1	Not used	–
n+2	Not used	–
n+3	PT control bit	See the following table.
n+4	Not used	–

Note: Only numeric values in BCD format can be stored.

### PT Status Control Bit

Bit	Function	Corresponding system memory
15	Not used	–
14	Not used	–
13	Continuous Buzzer (See note 2.)	\$\$SB12 (Continuous Buzzer)
12	Short Intermittent (See note 2.)	\$\$SB13 (Short Intermittent)
11	Not used	–

Bit	Function	Corresponding system memory
10	Not used	–
9	Long Intermittent (See note 2.)	\$SB14 (Long Intermittent)
8	Backlight Mode (ON: Lit, OFF: Flashing) (See note 1.)	\$SB10 (Backlight Flash Control)
7	Print Screen (See note 2.)	\$SB25 (Start Printing/Capture Screen)
6	Not used	–
5	Not used	–
4	Not used	–
3	Not used	–
2	Not used	–
1	Initialize Alarm History (See note 2.)	\$SB32 (Initialize alarm/event history)
0	Not used	–

Note 1: The operation for Backlight Mode is different if NT compatibility is not used. (The options if NT compatibility is not used are as follows: ON: Flashing, OFF: Lit.)

2: Notification will not be provided in the allocated PLC address even if the corresponding \$SB is directly manipulated. The value at the PLC address is always written to \$SB.

The PT status notification allocations are shown in the following table.

Word	Function	Corresponding system memory
m	Not used (always 0)	–
m+1	PT Status Notification Bit	See the following table.

#### PT Status Notification Bit

Bit	Function	Corresponding system memory
15	PT Operation Status	\$SB1 (RUN Signal (always ON))
14	Not used	–
13	Battery	\$SB4 (Battery voltage low notification)
12	Screen Switch Strobe	\$SB2 (Screen Switch Strobe)
11	Not used	–
10	Not used	–
9	Not used	–
8	Not used	–
7	Printer Busy Status	\$SB30 (Printer Busy Status/Capture Busy Status)
6	Not used	–
5	Not used	–
4	Not used	–
3	Not used	–
2	Not used	–
1	Not used	–
0	Not used	–

The window control area allocations are shown in the following table.

NS Series pop-up screens do not distinguish between global windows and local windows like the NT Series. The pop-up screens are handled as pop-up screen 1 (k to k+2), pop-up screen 2 (k+3 to k+5), and pop-up screen 3 (k+6 to k+8), based on the order they are opened.

Word	Function	Corresponding system memory
k	Global Window Screen No. (See note.)	\$SW1 (Current Pop-up Screen 1 Number)
k + 1	Global Window X Coordinate (See note.)	\$SW2 (Position of Pop-up Screen 1 (X Coordinate))

**NS Series Programming Manual**

Word	Function	Corresponding system memory
k +2	Global Window Y Coordinate (See note.)	\$\$SW3 (Position of Pop-up Screen 1 (Y Coordinate))
k +3	Local Window 1 Screen No. (See note.)	\$\$SW4 (Current Pop-up Screen 2 Number)
k +4	Local Window 1 X Coordinate (See note.)	\$\$SW5 (Position of Pop-up Screen 2 (X Coordinate))
k +5	Local Window 1 Y Coordinate (See note.)	\$\$SW6 (Position of Pop-up Screen 2 (Y Coordinate))
k +6	Local Window 2 Screen No. (See note.)	\$\$SW7 (Current Pop-up Screen 3 Number)
k +7	Local Window 2 X Coordinate (See note.)	\$\$SW8 (Position of Pop-up Screen 3 (X Coordinate))
k +8	Local Window 2 Y Coordinate (See note.)	\$\$SW9 (Position of Pop-up Screen 3 (Y Coordinate))

Note: Only numeric values in BCD format can be stored.

**Setting Method**

1. Select PT – System Setting.
2. The System Settings Dialog Box will be displayed. Select the Initial Tab Page.
3. Select the *Allow system memory compatibility with NT* checkbox and select the corresponding NT Series.
4. Make the PLC address allocations for the PT Status Control, PT Status Notification, and Window Control Areas.

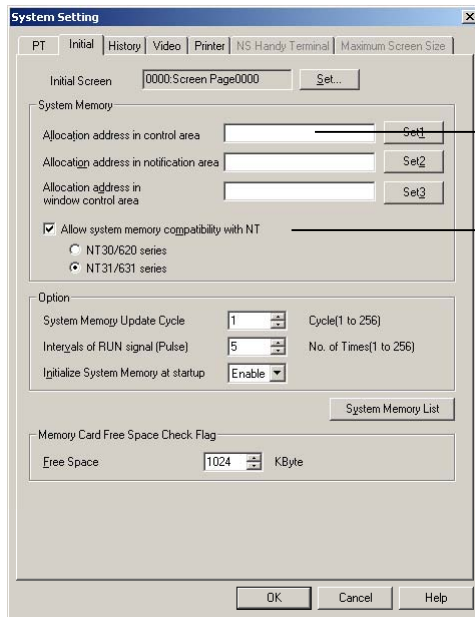

4. Set PLC address to allocate.

3. Select this option and select the series.

**Note**

- ◆ Internal memory addresses cannot be allocated for PT Status Control, PT Status Notification, and Window Control Areas.
- ◆ Leave the input field blank if not allocating addresses for the Window Control Area.

## 2-5 Communications Address Settings

NS-series PTs have improved network functions and can communicate with multiple hosts. Host names are registered for the connected hosts and any area in the host can be accessed by specifying the host name and area.

With NS-series PTs, data required for display can be accessed and the words and bits that store the entered data can be allocated from any area in the PLC.

The allocated words and bits are read from and written to directly, the display status changed for the objects on the PT screen, and the PT status controlled or reported.

Refer to System Settings and Project Properties and Creating Functional Objects in the CX-Designer Online Help for details on registering hosts and setting addresses.

Refer to the Host Connection Manual: Temp. Control, MemLink for details on connecting Temperature Controllers. Refer to the Host Connection Manual: Multivendor Connection for details on connecting to another company's PLC.

### 2-5-1 Register Host

#### Procedure

1. Select **PT – Comm. Setting**.
2. The Comm. Setting Dialog Box will be displayed.
3. Select the connection method being used for the host connection (Serial Port A, Serial Port B, Ethernet, or Controller Link) and click the **Add Host** Button.

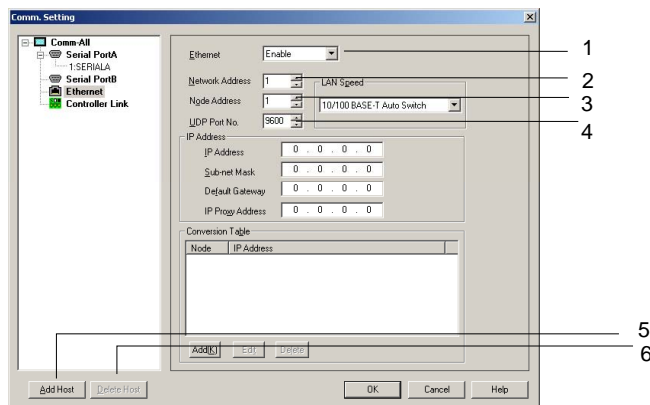

4. The host will be added. Make the host settings.  
The host settings depend on the connection method. For details, refer to *System Setting and Project Properties* in the online help of the CX-Designer.

#### Note

- ◆ When the NSH Series is set as the PT model, do not set a host connection other than serial port A.
- ◆ If “/” characters are used in the host names of a project created in CX-Designer, the “/” characters will be converted to “\_” characters when the project is opened in CX-Designer.
- ◆ To delete a registered host, select the host in the Comm. Setting Dialog Box, and then click the **Delete Host** Button.
- ◆ To connect to the host using EtherNet/IP, select *Ethernet* in the Comm. Setting Dialog Box.

## 2-5-2 Communications Addresses

Memory in the host is accessed from an NS-series PT by using addresses called communications addresses. There are two types of communications addresses.

- Direct addresses
- Tags

A direct address specifies a specific element in host memory by using an area name and numeric address. A tag specifies a network variable set in the PLC. Tags can be used if the project version is 8.0 or higher and connection is made to the CJ2H-CPU□□-EIP or the CJ2M-CPU3□ using EtherNet/IP.

### Data Types

The CX-Designer has the ability to associate names and comments with communications addresses. In addition, the physical type of data stored at the communications address can be specified.

The following 17 types of data can be used with an NS-series PT.

Data type	Description
BOOL	Bit
CHANNEL	Word
UINT	Address of 1-word unsigned binary value
INT	Address of 1-word signed binary value
UINT_BCD	Address of 1-word unsigned BCD value
UDINT	First address of 2-word unsigned binary value
DINT	First address of 2-word signed binary value
UDINT_BCD	First address of 2-word unsigned BCD value
ULINT	First address of 4-word unsigned binary value
LINT	First address of 4-word signed binary value
ULINT_BCD	First address of 4-word unsigned BCD value
REAL	First address of 2-word floating-point value
LREAL	First address of 4-word floating-point value
WORD	Address of 16-bit character string
DWORD	First address of 32-bit character string
LWORD	First address of 64-bit character string
STRING	Literal character string of 1 to 255 characters

### Note

- ◆ STRING communications addresses cannot be created with the CX-Designer. To use STRING communications addresses, copy STRING symbols from a symbol table of the CX-Programmer to a symbol table of the CX-Designer.
- ◆ For communications addresses, all direct address data that is not set to BOOL will be treated by the NS-series PT as CHANNEL data. Data type settings other than BOOL and CHANNEL are provided for compatibility with the symbol tables of the CX-Programmer.
- ◆ The data types for internal memory are BOOL (\$B/\$HB/\$SB) and CHANNEL (\$W/\$HW/\$SW).
- ◆ If tags are used, the data type must be set to a size that is appropriate for the functional component (bit, 1 word, or 2 words). For details, refer to *2-8-4 Numeral Display and Storage Type and Appendix A-4-2 Using Tags*.
- ◆ STRING tags can store character data of 1 byte times the number of characters set for the tag. For example, up to ten characters can be stored if the number of characters of a STRING tag is set to ten and all characters are single-byte and stored in multibyte code. Up to five characters can be stored if all characters are double-byte and stored in multibyte code. If the characters are stored in Unicode, up to five characters can be stored. If STRING tags are used, set the number of characters and character code so that the storable character string data size is not exceeded.
- ◆ Only BOOL and CHANNEL can be set for the data type if the project version is lower than version 8.0.

### Array Variables (Tags Only)

One-dimensional array variables can be created with the CX-Programmer. An array specification is used when multiple variables are used with the same data attribute to manage these variables as a group.

Array variables can be used with NS-series PTs by copying array variables from the CX-Programmer's symbol table to the CX-Designer's symbol table.

#### Note

- ◆ Array variables cannot be created with the CX-Designer. Also, the number of array elements cannot be changed.
- ◆ All data types except STRING and NUMBER can be set with the CX-Programmer. (The NUMBER data type is not supported by NS-series PTs.)

### Data Structures (Tags Only)

Data structure can be created with the CX-Programmer. In the CX-Designer, a data structure will be separated into its members, and each will be treated as one variable. Arrays in data structures will be separated into individual elements and each will be treated as a separate variable. Members and elements can be created as individual variables in the CX-Designer.

## 2-5-3 Directly Specifying Addresses

### Address Settings

Addresses are specified using the following formats.

#### Bit Access

- Internal Addresses: [Memory area name][bit number]  
Example: \$B1, \$SB20
- Specifying Host Addresses:  
[Host name]:[area name][5-digit word number].[2-digit bit address]  
Example: HOST1:00001.11

#### Word Access

- Internal Addresses: [Memory area name][word number]  
Example: \$W00001
- Specifying Host Addresses: [Host name]:[area name][5-digit word number]  
Example: HOST1:DM00001

The address settings can be entered directly or from the Address Settings Dialog Box.

### Address Setting Dialog Box

The following three methods can be used to input set the address in the Address Setting Dialog Box.

- Directly specifying the address
- Inputting a symbol (For details on symbols, refer to the heading *Symbols* below.)
- Selecting a registered symbol

#### Method 1: Directly Inputting an Address

Select the **Input Direct Address** Tab from the *Switch Input* Options. Specify the host, area, and address ("number").

**NS Series Programming Manual**

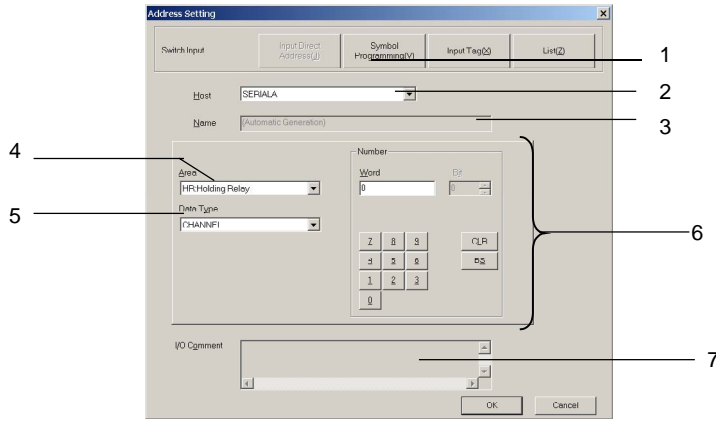

No.	Setting	Details
1	Switch	Switches the input method.
2	Host	Select the pre-registered host name or PT memory (internal PT memory).
3	Name	Displays the name set for the communications address.
4	Area	Select the area name.
5	Data type	Specifies the type of data stored at the communications address.
6	Number	Specify the word address and bit address.
7	I/O Comment	Displays the I/O comment set for the communications address.

**Reference**

- ◆ Indexes cannot be set in the Address Setting Dialog Box. Enter a index directly into the input area. An index is an address whose contents is used to determine the address that is referenced. Refer to *Creating Functional Objects* in the *CX-Designer Online Help* for details.
- ◆ Leading zeros may be omitted from addresses.  
For example, both \$B10 and \$B00010 are acceptable.  
Serial A:DM1 and Serial A:DM00001 are also both acceptable.
- ◆ The numeric address for communications addresses of other company’s devices are sometimes input using hexadecimal numbers. When doing so, input a 0 between the area name and address number.  
Example: Mitsubishi A-series Controllers
  - X0A3: Correct input
  - XA3: Incorrect input
 If a 0 is not input, the number will be treated as a symbol without an address. It is not necessary to input a 0 between the area name and the address number if hexadecimal is not used to input the address number. (It is also acceptable to input a 0.)  
Example: Mitsubishi A-series Controller  
M3 and M00003 are both acceptable.
- ◆ The device set as the host determines which areas and other settings are displayed.

**Method 2: Inputting a Symbol**

Use this method when symbols are being used to edit screens.

Select the **Symbol Programming** Tab from the *Switch Input* Options. Input the symbol name in the *Name or Address* Field. It is possible to input just the symbol name, without inputting the area and address.

**NS Series Programming Manual**

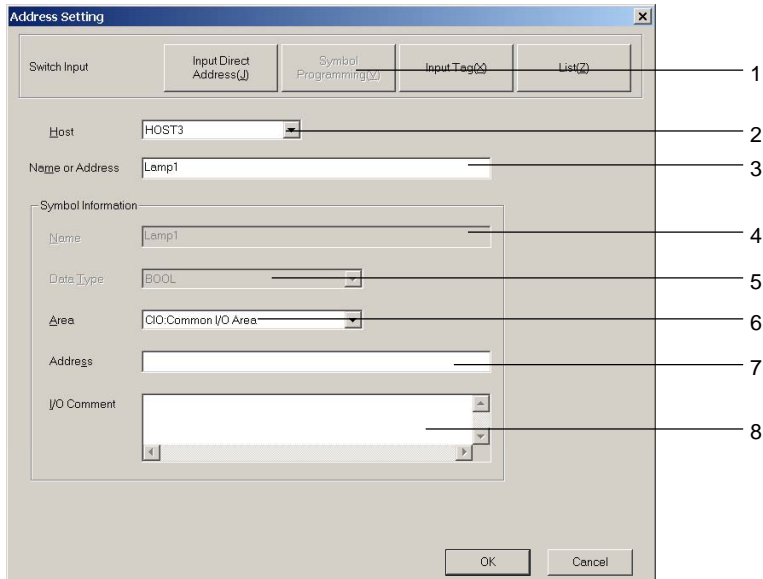

No.	Setting	Details
1	Switch	Switches the input method.
2	Host	Select the pre-registered host name or PT memory (internal PT memory).
3	Name or Address	Input the name of the desired symbol.
4	Name	Displays the symbol name set in the <i>Name or Address</i> Field.
5	Data	Displays the data type that can be set. (CHANNEL stands for word data.)
6	Area	When a symbol name that is not registered in the symbol table has been set in the <i>Name or Address</i> Field, select the area name here. When a symbol name that is registered in the symbol table has been set in the <i>Name or Address</i> Field, that symbol's area name will be displayed here.
7	Address	When a symbol name that is not registered in the symbol table has been set in the <i>Name or Address</i> Field, set the address here. When a symbol name that is registered in the symbol table has been set in the <i>Name or Address</i> Field, that symbol's address name will be displayed here.
8	I/O Comment	When a symbol name that is not registered in the symbol table has been set in the <i>Name or Address</i> Field, set an I/O comment here. When a symbol name that is registered in the symbol table has been set in the <i>Name or Address</i> Field, that symbol's I/O comment will be displayed here.

**Note**

- ◆ With any one of the input methods, a communications address can be input when specifying the address. In this case, input the address in the *Name or Address* Field. The address can be input with an index

**Method 3: Selecting a Registered Symbol**

Select the List Tab from the *Switch* Options. Select the desired symbol from the list of symbols registered in the symbol table.



**NS Series Programming Manual**

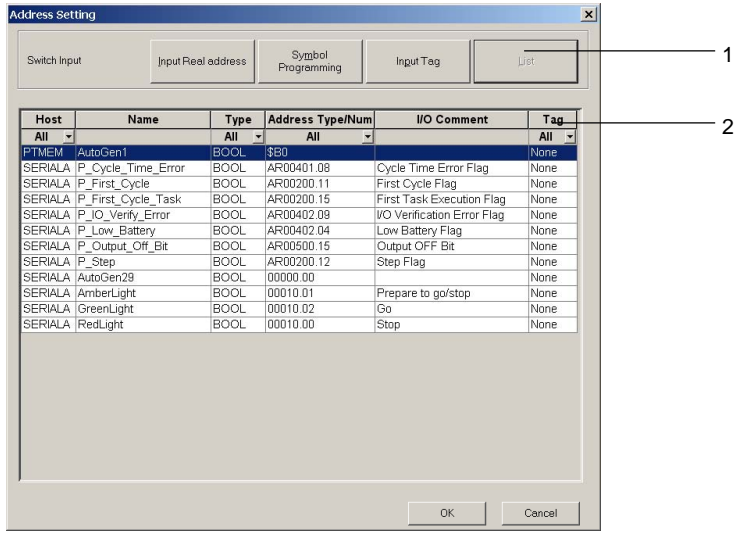

No.	Setting	Details
1	Switch	Switches the input method.
2	Symbol table	A list of the registered symbol is displayed in the symbol table. Select the desired symbol .

**Symbols**

In the CX-Designer, it is possible to set a symbol as the data referenced by a functional object instead of a directly specified host address or internal memory address.

**Inputting an Address**



**Inputting a Symbol**



Program maintenance can be simplified by converting the program to text so that the text indicates the contents of each program address. Text comments can be added to each address to explain the contents, but a more effective technique is specifying label names and symbol names in the address.

In the example above, the address SerialA:00048 is specified as a name with symbol TimeInterval.

This name can be used instead of the address. When the I/O configuration is changed, the variable names allow you to make global changes to the entire project just by changing the address associated with the symbol name so it isn't necessary to change the addresses in the program individually. In the CX-Designer, names and comments can be specified for address constants.

Symbols are registered in the symbol table. Registered symbols can be input in any communications address setting.



**NS Series Programming Manual**

2. Drag and drop the tag to the CX-Designer's symbol table to copy it.

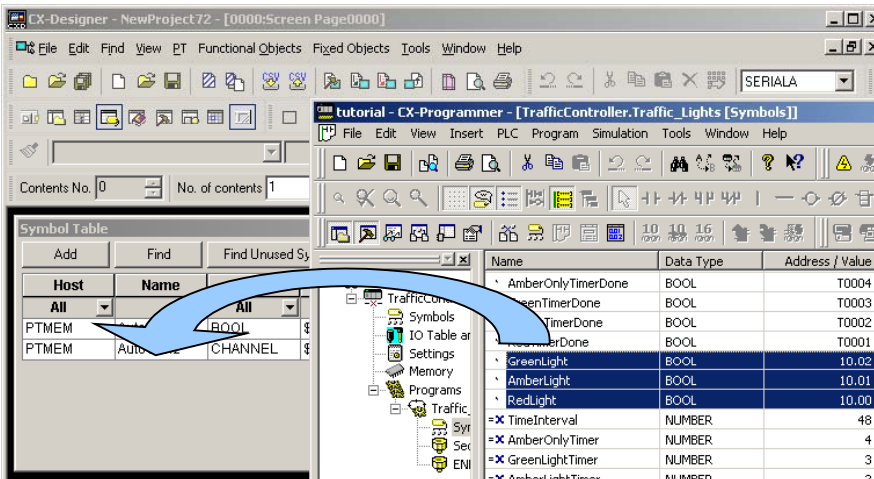

3. A dialog box for selecting the host for which the tag will be set will be displayed. Select a host that can use tags, and then click the **OK** Button.

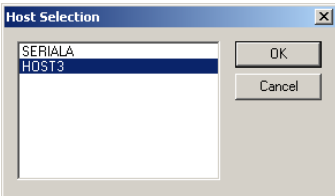

4. The tag will be registered in the symbol table of the CX-Designer.

**Registering New Tags in the Symbol Table**

1. Click the **Add** Button in the CX-Designer's Symbol Table Dialog Box.

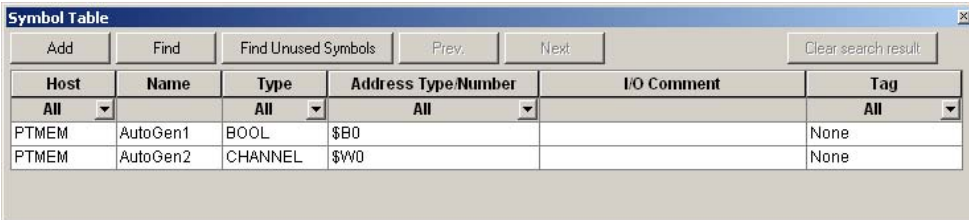

2. The Address Setting Dialog Box will be displayed. Click the **Input Tag** Button.

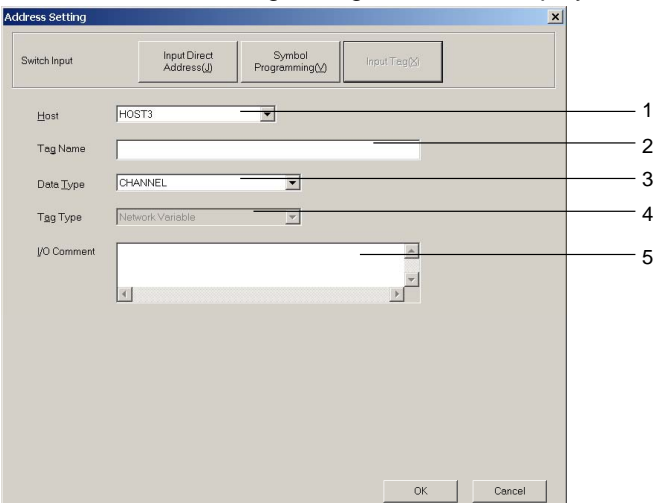



**NS Series Programming Manual**

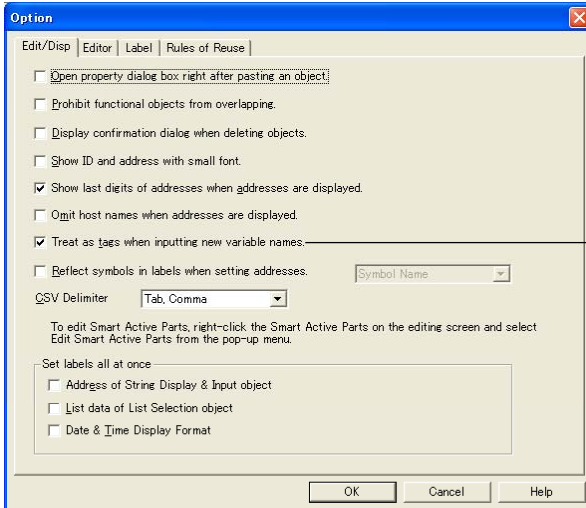

Select this option.

4. Click the **OK** Button.

5. Input the new tag in the *Communications Address* Field. Refer to *Registering New Tags in the Symbols Table* for information on the characters that can be used for tags.



The data type of tags that are created depends on the settings for the communications address.

Setting	Storage type	Data type set for tag
Items that can be set only to BOOL		BOOL
Items set together with storage type	INT	INT
	UINT	UINT
	DINT	DINT
	UDINT	UDINT
	REAL	REAL
	BCD2 (1 word, unsigned)	UINT_BCD
	BCD2 (2 words, unsigned)	UDINT_BCD
Other items	Other storage types	CHANNEL
		CHANNEL

**Note**

- ◆ Even if the *Treat As Tags When Inputting New Variable Names Option* is selected in the Option Dialog Box, tags will be treated as direct addresses or variable names of direct addresses in the following cases.
  - Direct addresses are input.
  - A host that cannot use tags is specified.

**Converting from Direct Addresses to Tags**

Direct addresses that have been registered in symbol tables (including symbols without addresses) can be converted to tags.

Use the following procedure for conversion. The following example assumes that SERIALA is a host that does not support tags and that HOST3 is a host that supports tags.

**NS Series Programming Manual**

1. Select the direct address (symbol) to be converted in the symbol table.

Host	Name	Type	Address Type Number	I/O Comment	Tag
All	All	All	All		All
PTMEM	AutoGen1	BOOL	\$B0		None
PTMEM	AutoGen2	CHANNEL	\$W0		None
SERIALA	Lamp1	BOOL	00000.00	Lamp1	None

2. Double-click the address to display the Address Setting Dialog Box. Click the **Input Tag** Button.

Click here.

3. The host setting, data type, and I/O comment will be inherited if the host supports tags. If the host does not support tags, the host will be changed to a host that support tags.

If the host before conversion does not support tags, it will be changed to support them.

The host setting before the change will be inherited if the host that was set before the change supports tags.

4. Adjust the settings as required, and then click the **OK** Button.

5. The address will be converted to a tag.

Host	Name	Type	Address Type Number	I/O Comment	Tag
All	All	All	All		All
PTMEM	AutoGen1	BOOL	\$B0		None
PTMEM	AutoGen2	CHANNEL	\$W0		None
HOST3	Lamp1	BOOL	\$W0	Lamp1	Network Symbol

Converted to tag.

**Note**

- ◆ Tags can be converted to direct addresses.

## 2-6 Fixed Objects

### 2-6-1 Common Fixed Object Settings

Unlike functional objects, fixed objects do not have many functions. Fixed objects display fixed data. The following seven types of fixed objects can be used.

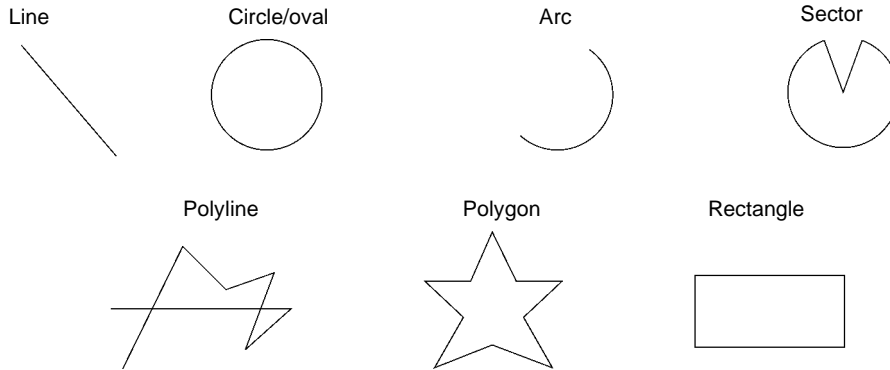

Name	Details
Rectangle	Draws a rectangle.
Circle/Oval	Draws an inscribed circle or oval within a specified rectangle.
Line	Draws a straight line or arrow.
Polyline	Draws a series of specified lines.
Polygon	Draws a polygon from a series of specified lines.
Sector	Draws a circle and then a sector from a specified angle in that circle.
Arc	Draws a circle and then an arc from a specified angle in that circle.

All display properties for fixed objects, such as color and size, are set in the Fixed Object Property Setting Dialog Box. The properties for each fixed object are displayed, with the items that cannot be set for that particular fixed object shown in gray (i.e., invalid).

Select the object for which the properties are to be set and then select **PT – Functional Object Properties** or click the right mouse button and select **Properties** from the pop-up menu. The menu items on the pop-up menu will depend on the selected fixed object.

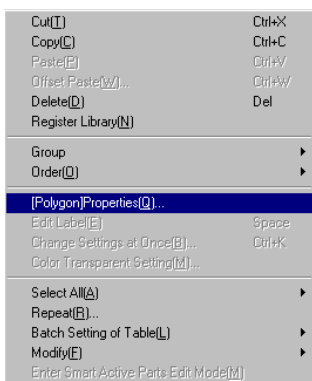

### Fixed Object Property

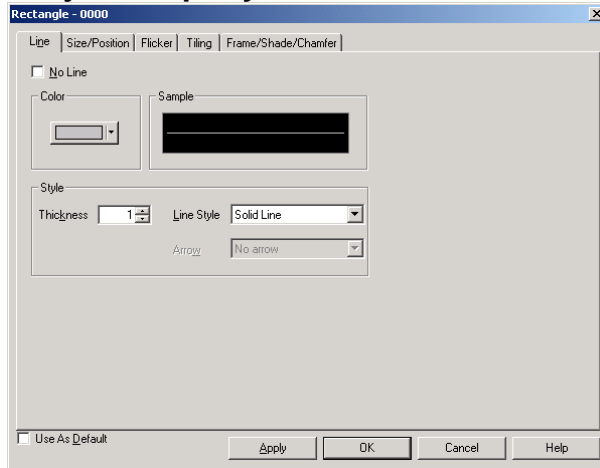

- Line: Set the line color and type.
- Size/position: Set the position and size of the fixed object. (Displayed for fixed objects other than lines.)
- Start/end: Set the start and end points for lines. (Displayed only for lines.)
- Flicker: Set the flicker display.
- Tiling: Set the display color for the fixed object. (Displayed for fixed objects other than lines, polylines, and arcs.)
- Frame/shade/ chamfer: Set frames, shading, colors, and beveling for these. (Displayed for fixed objects other than lines, polylines, and arcs.)

### Line

Set the type of lines for the fixed object.

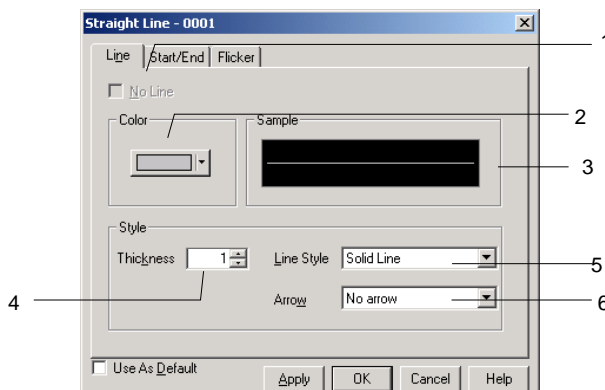

No.	Setting	Details
1	No line	Select whether or not to use frame lines.
2	Color	Set the line color.
3	Sample	Displays the current selected combination.
4	Thickness	Set the line thickness.
5	Line style	Set the line type. Select from the 5 types of lines shown in the list. Solid lines Broken lines Dotted lines 1-dot chain lines 2-dot chain lines
6	Arrow	Select one of the following: No arrow, Start arrow, End arrow, Both ends arrow



**Note**

- ◆ Arrows can be set only for straight lines.

**Size and Position**

Set the size and display position of the fixed object.

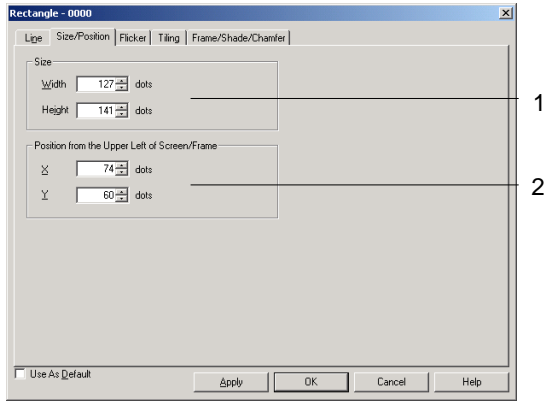

No.	Setting	Details
1	Size	Specify the width and height of the fixed object in dot units.
2	From Top Left of Screen/Frame	Specify the position (upper left X and Y coordinates) of the object from upper left of the screen or frame. (X coordinate: 0 to 2,559; Y coordinate: 0 to 1,919)

**Reference**

- ◆ Set the position so that the object is not outside the screen or frame area.
- ◆ Validation can be performed to check for fixed objects outside the screen or frame area. For details on error checks, refer to *Validation* in the *CX-Designer Online Help*.

**Start and End**

Set the display position for the line.

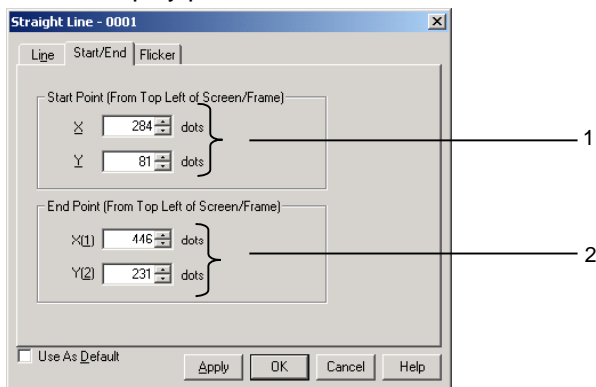

No.	Setting	Details
1	Start point (from top left of screen or frame)	Specify the position for the start point of the line in bit units, from the top left of the screen or frame. (X coordinate: 0 to 2,560; Y coordinate: 0 to 1,920)
2	End point (from top left of screen or frame)	Specify the position for the end point of the line in bit units, from the top left of the screen or frame. (X coordinate: 0 to 2,560; Y coordinate: 0 to 1,920)

**Reference**

- ◆ Care must be taken when setting the start and end points of lines within frames so that the line is not positioned outside the frame area. Be careful when setting the position so that the line is not outside the screen.
- ◆ Validation can be performed to check for lines outside the screen or frame area. For details on error checks, refer to *Validation* in the *CX-Designer Online Help*.

**Flicker**

Make settings on the Flicker Tab Page to make fixed objects flicker (flash).

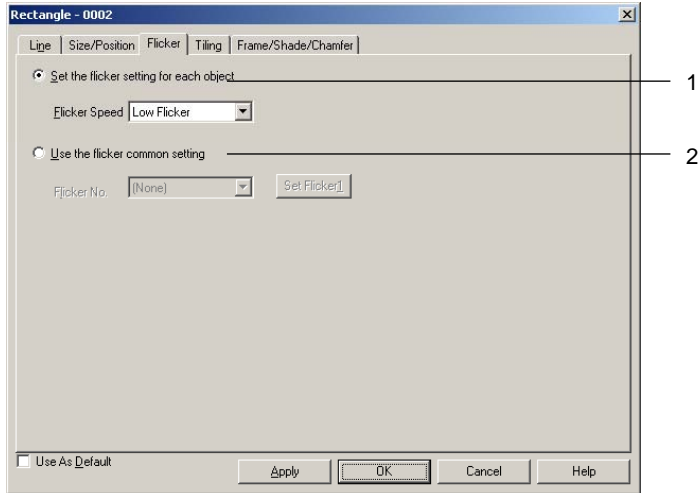

No.	Item	Details
1	Set the flicker setting for each object	Alternately displays the fixed object display color and its inverse color. The following three flicker speed options can be selected. Low flicker Middle flicker High flicker
2	Use the flicker common setting	Used to select the flicker method from the Flicker No. options set under <b>PT – Flicker – Flicker Settings</b> . Refer to 2-8-13 <i>Flicker (Extension Tab)</i> for details on flicker settings.

**Note**

- ◆ Select **None** under *Flicker Speed* or *Flicker No.* to have the object not flicker.
- ◆ If inverse flicker is selected under the flicker common settings, the whole fixed object will be displayed in inverse colors, including straight lines, continuous straight lines, and arc, regardless of the flicker range setting.
- ◆ If inverse flicker is set for a 3-dot frame or 5-dot frame under the flicker common settings, the outside of the fixed object (screen background) of polygons and sectors will also be displayed in inverse colors.

**NS Series Programming Manual**

**Tiling**

Set the color for the fixed object.

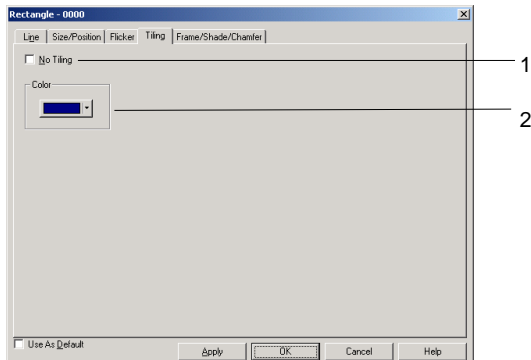

No.	Setting	Details
1	No Tiling	Select whether or not to tile the object.
2	Color	Set the object color.

**Frame, Shade, and Beveling**

Specify the frame, shading color, size, and bevel setting for the three-dimensional display of fixed objects.

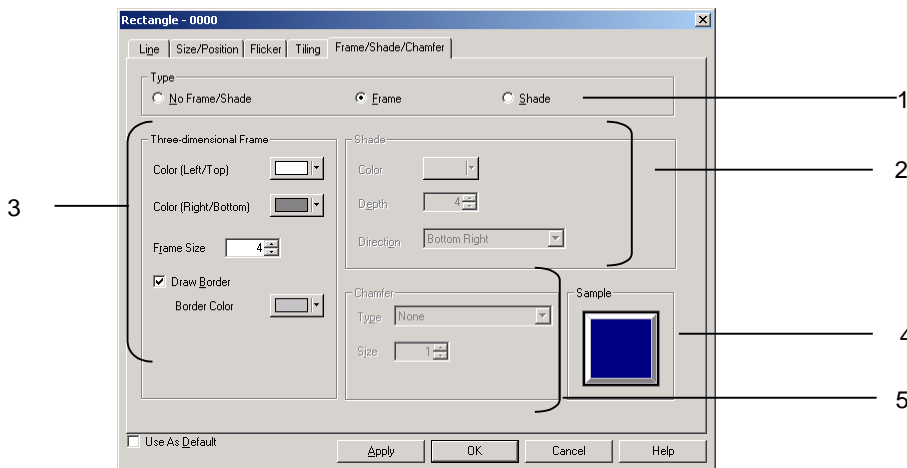

No.	Setting	Details
1	Type	Select one of the following three types of fixed objects. No frame or shade, Frame, or Shade
2	Shade	Set the shade color, depth, and direction. Select the <i>Shade</i> Option. Set the color with the <b>Color</b> setting. Set the depth under <b>Depth</b> . Select one of the four shade direction types. Top Left, Top Right, Bottom Left, or Bottom Right
3	Three-dimensional Frame	Set the frame color, size, and border. Select the <i>Frame</i> Option. Set the color with the <b>Color (Left/Top)</b> and <b>Color (Right/Bottom)</b> settings. The size of the frame is set under <b>Frame Size</b> . When drawing a frame border, select the <i>Draw Border</i> Option to draw the frame border and specify the color with the <b>Border Color</b> setting.
4	Sample	The current settings will be reflected.

No.	Setting	Details
5	Chamfer	Set a bevel. <b>Type</b> Select one of the following three bevel choices. None: No bevel Radius of curve: Rounds the corners using the bevel size setting for the radius. Cut: Cuts off an isosceles triangle from each corner based on the bevel size setting. <b>Size</b> Specify the bevel size.

**Note**

- ◆ Only shade settings can be made for polygons and sectors.

## 2-7 Registering/Using Library

The library contains pieces of data that registered functional and/or fixed objects created on CX-Designer.

If complicated fixed objects or other frequently used objects are registered to the library by category, those fixed objects can be displayed as required.

When functional objects are registered to the library, the property settings for those objects are also registered.

When frames are registered, all of the information within the frame is registered and can be used as is.

Objects can be easily registered and reused, using the drag-and-drop function.

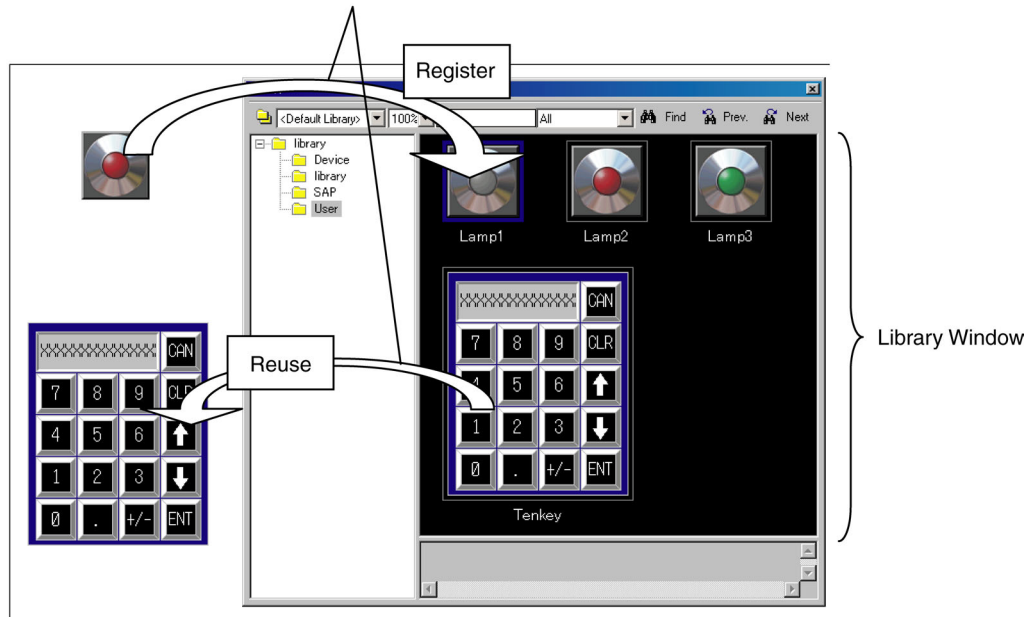

### Reference

- ◆ The computer's available free disk space determines how many library items can be registered.
- ◆ Video Displays and Data Block Tables cannot be registered in the library.
- ◆ For details on registering and reusing libraries, refer to *Editing Objects* in the *CX-Designer Online Help*.

## 2-8 Common Functional Object Functions

### 2-8-1 Table of Functional Object Settings

	Communications Address (See note 1.)	Unit and Scale	Numeral Display Type	Date and Time	Text Attributes	Color	Background	Shape	Label	Scroll Bar	Frame	Flicker	Write Settings	Password	Control Flag (See note 2.)	Macro	Size/Position
ON/OFF Buttons	○	-	-	-	-	○	-	○	○	-	○	○	○	○	○	○	○
Word Buttons	○	-	-	-	-	○	-	○	○	-	○	○	○	○	○	○	○
Command Buttons	○	-	-	-	-	○	-	-	○	-	○	○	-	○	○	○	○
Bit lamps	○	-	-	-	-	○	-	○	○	-	○	○	-	-	△	○	○
Word lamps	○	-	-	-	-	○	-	○	○	-	○	○	-	-	△	○	○
Numeral display and input objects	○	○	○	-	○	-	○	-	-	-	○	○	○	○	○	○	○
String display and input objects	○	-	-	-	○	-	○	-	-	-	○	○	○	○	○	○	○
Temporary input	-	-	-	-	○	-	○	-	-	-	○	-	-	-	-	-	○
Thumbwheel switches	○	○	○	-	○	-	○	-	-	-	○	○	○	○	○	○	○
List selection objects	○	-	-	-	○	-	○	-	-	○	○	○	-	○	○	○	○
Labels	○	-	-	-	-	-	○	-	○	-	○	○	-	-	△	-	○
Bitmaps	○	-	-	-	-	-	-	-	-	-	○	○	-	-	△	-	○
Level display objects	○	-	○	-	-	○	○	-	-	-	○	○	-	-	△	-	○
Analog meters	○	-	○	-	-	○	○	-	-	-	○	○	-	-	△	-	○
Video Display	-	-	-	-	-	-	-	-	-	-	○	-	-	-	-	-	○
Alarm/Event display objects	○	-	-	○	○	-	○	-	-	-	○	○	-	○	○	○	○
Alarm/Event summary and history objects	○	-	-	○	○	-	○	-	-	○	○	○	-	○	○	○	○
Data log graphs	○	-	○	○	-	-	○	-	-	○	○	○	-	-	○	-	○
Broken-line graphs	○	-	○	-	-	-	○	-	-	○	○	○	-	-	○	-	○
Data Block Table	○	-	○	-	○	-	○	-	-	○	○	-	○	○	○	○	○
Date objects	○	-	-	○	○	-	○	-	-	-	○	○	○	○	○	-	○
Time objects	○	-	-	○	○	-	○	-	-	-	○	○	○	○	○	-	○
Consecutive line drawings	○	-	-	-	-	○	-	-	-	-	-	-	-	-	-	-	○
Multifunction Object	○	-	○	-	○	○	-	○	○	○	○	○	○	○	○	○	○
Contents display	○	-	-	-	-	-	-	-	-	○	○	○	-	-	○	-	○

○: Supported, -: Not supported

Note 1: Communications address can be set in the General Tab Page as well as other Tab Pages.

Note 2: ○: Controls input and display. △: Controls display only.

**Note**

- ◆ If functional objects that receive inputs are overlapped, the objects may not operate properly. When creating a screen, do not overlap the following functional objects.
  - ON/OFF Buttons
  - Word Buttons
  - Command Buttons
  - Numeral display and input objects
  - String display and input objects
  - Thumbwheel switches
  - List selection objects
  - Multifunction Object
  - Alarm/Event display objects
  - Alarm/Event summary and history objects
  - Data log graphs
  - Broken-line graphs
  - Date objects
  - Time objects
  - Data Block Table
  - Contents display

**2-8-2 Address Settings (General Tab and Other Tabs)**

If addresses are set in the properties of functional objects, the colors can be made to change depending on the status read via communications and the host can be notified when objects are pressed.

For example, the write address when an ON/OFF Button is pressed, as well as display address 1 and display address 2 are set on the General Tab Page for an ON/OFF Button.

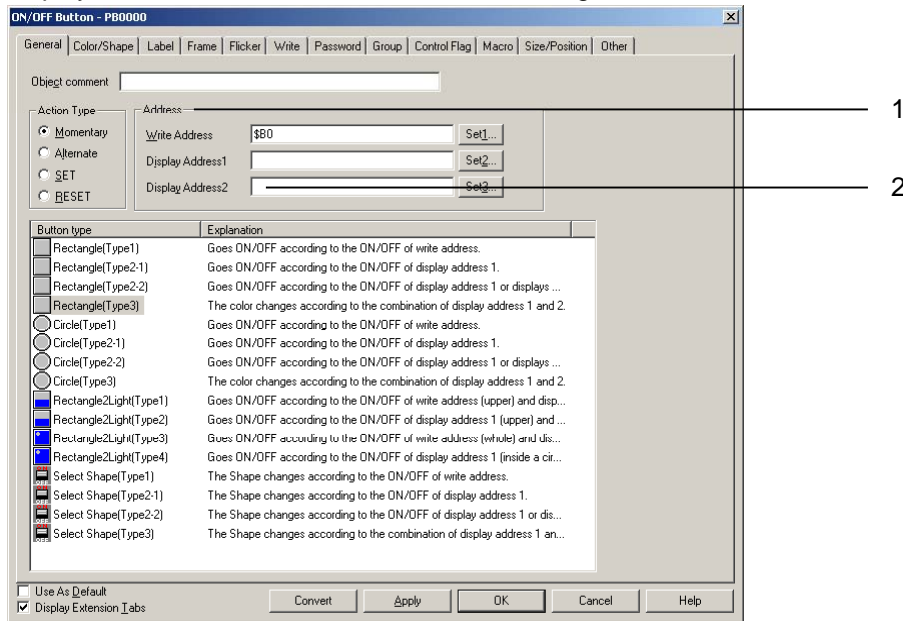

No.	Setting	Details										
1	Address setting	<p>Enter the address to be set. The addresses that can be set depends on the functional object and the setting items.</p> <p>For example, only bits can be set to functional objects such as ON/OFF buttons or lamps that read the ON/OFF status of addresses. Refer to <i>Appendix 4 Address for Functional Objects</i>. If an address that cannot be set is entered, a message saying that the address is incorrect will be displayed when the OK Button is pressed.</p>										
2	Index setting	<p>If an index is specified for a particular address, the address can be automatically changed to a value to which the index value has been added.</p> <p>Ten index types, I0 to I9, can be set and each type corresponds to \$SW27 to \$SW36. Refer to <i>2-4 System Memory</i> for information on system memory (\$SW27 to \$SW36).</p> <p>Example Usage of Indexes                      Address setting: HOST1: 00000I0                      The address for communications will automatically change based on the I0 value.</p> <table border="1" style="margin-left: 40px;"> <thead> <tr> <th>I0 value</th> <th>Address</th> </tr> </thead> <tbody> <tr> <td>0</td> <td>HOST1:00000</td> </tr> <tr> <td>1</td> <td>HOST1:00001</td> </tr> <tr> <td>2</td> <td>HOST1:00002</td> </tr> <tr> <td>⋮</td> <td>⋮</td> </tr> </tbody> </table>	I0 value	Address	0	HOST1:00000	1	HOST1:00001	2	HOST1:00002	⋮	⋮
I0 value	Address											
0	HOST1:00000											
1	HOST1:00001											
2	HOST1:00002											
⋮	⋮											

**Reference**

- ◆ When specifying indexes, the index (between I0 and I9) is added at the end of the address.  
 Example: Setting HOST1:DM00000I9



Move the cursor to the end of "HOST1: DM00000" and enter "I9".

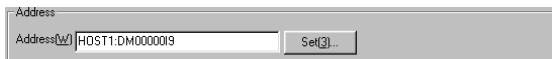

- ◆ An index cannot be entered from the Address Setting Dialog Box.
- ◆ If the address exceeds the setting range as a result of the index being specified, the address will be invalid and communications will not be processed.
- ◆ If the *Use as default* option is selected when an address is set to a functional object, that setting will be enabled even for other projects. The operation in such cases is described below.

If there is a host with the same host name, that host name will be applied.

Example:

If "HOST1" is created as the number 2 host for project 1 and "HOST1" is created as the number 2 host for project 2:

If the functional object for which HOST1:00000 is set is registered using the default value for project 1, HOST1:00000 will be set when that functional object is created for project 2.

If there is no host with the same host name, the default value (\$B0, \$W0) will be used.

Example:

If "HOST1" is created for the number 2 host for project 1 and no host is registered as the number 2 host for project 2.

Refer to *Editing Object* in the *CX-Designer Online Help* for details on the registering as an existing value option.

- ◆ Indexes cannot be set for tags.



**NS Series Programming Manual**

**Address Settings**

The host name, area type, and address are set in the Address Setting Dialog Box. Select *PT memory* from the list of host names when specifying the PT internal memory. The area types that can be selected depend on the model of host that is registered.

Select **PT – Communication Setting** to display the Comm. Setting Dialog Box and set the host name.

Example: Address Setting Dialog Box for communications with OMRON C-series PLCs

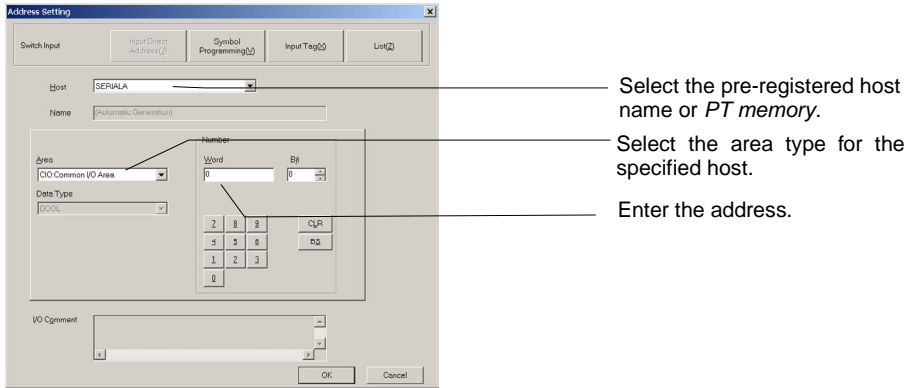

**Host Name**

Select the pre-registered host name or *PT memory*.  
If *PT memory* is selected, the internal PT memory is accessed.

**Area Type**

Select the area type for the selected host name.  
The area types that can be selected change depending on the selected host name.  
If *PT memory* is selected under *Host name*, the internal memory areas outlined in the following table can be specified.

**Area Types when PT Memory Selected**

Area type	Details
\$B	Internal bit memory
\$W	Internal word memory
\$SB	System bit memory
\$SW	System word memory
\$HB	Internal holding bit memory
\$HW	Internal holding word memory

**Inputting Addresses**

Use the numeric buttons 0 to 9 below the input field to enter the address.  
Press the **CLR** Button to clear the address and the **BS** Button to delete the last character in the address.

**Reference**

- ◆ The addresses that can be set depend on the functional object and the setting items.  
For example, only bits can be set for functional objects, such as ON/OFF buttons or lamps, that read the ON/OFF status of specified address bits.  
Refer to *Appendix 4 Address for Functional Objects*.
- ◆ Indexes cannot be set in the Address Setting Dialog Box. Enter indexes directly.

### 2-8-3 Unit and Scale (General Tab)

For numeral display objects and thumbwheel switches, scale conversions can be included in the display. The unit can also be displayed for numeral display objects. The unit and scale display settings are made on the General Tab Page of the Functional Object Properties Dialog Box.

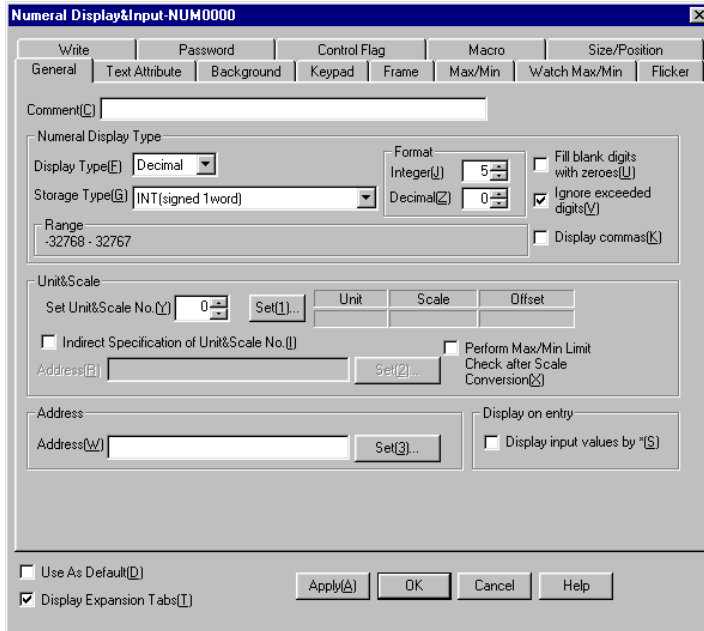

#### Note

- ◆ If *Indirect specification of unit and scale No.* is selected in the Functional Object Properties Dialog Box, the contents at the address is taken as the unit and scale number and the unit number is switched accordingly. The display unit or scale conversion coefficient can be switched from the host using this indirect specification method. Indirect specification is not possible for units and scales numbers for thumbwheel switches.

#### Unit and Scale: Setting

Set the unit name and scale (magnification) combinations for the numerals to be displayed. Click the **Set** Button in the *Unit and Scale* column on the General Tab Page in the Functional Object Property Dialog Box to set the unit and scale.

Up to 1,000 units-scale combinations can be registered. Only the set information is downloaded to the PT.

**NS Series Programming Manual**

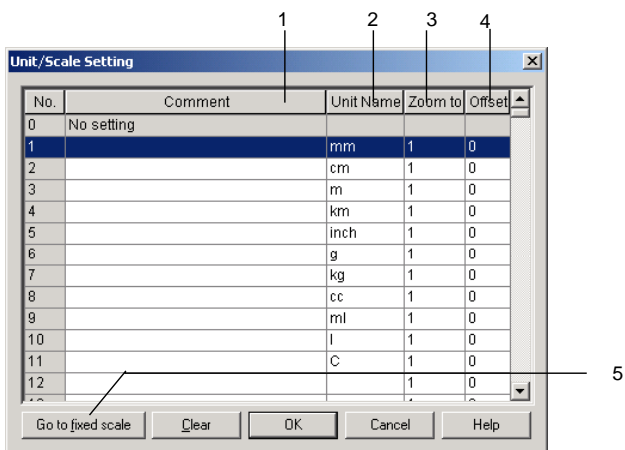

No.	Setting	Details
1	Comment	Sets comments for units (16 characters).
2	Unit name	Sets the name of the unit (up to 8 characters).
3	Scale	Sets the magnification (approximately ±1.175494351e-38 to approximately ±3.402823466e+38). The magnification can be set in integers, decimals, and indices. Fractions cannot be set.
4	Offset	Sets the offset value (approximately ±1.175494351e-38 to approximately ±3.402823466e+38).
5	Go to fixed scale Button	Displays a pre-registered fixed scale (after unit No. 1001).

**Editing Units and Scales**

Double-click each item in the Unit & Scale Setting Dialog Box to edit the units and scales.

Example: When the address is set to \$W1000, unit to mm, scale to 100, and offset value to 50:

\$W1000 contents	Formula	Display value
0	$50 + 0 \times 100$	50 mm
1	$50 + 1 \times 100$	150 mm
2	$50 + 2 \times 100$	250 mm
100	$50 + 100 \times 100$	10,050 mm

**Reference**

- ◆ If a decimal with many digits is set as the scale, the test and PT display values may differ. The contents of the address, however, will be the same.
- ◆ The scale for a thumbwheel switch must be set to a power of 10, and the offset must be set to 0. If any other values are set, the thumbwheel switch may not operate properly.

## 2-8-4 Numeral Display and Storage Type (General Tab)

The following display and storage formats can be specified for functional objects that handle numeric values.

The display and storage formats for numerals are set on the General Tab Page.

### Display Type

Display Type	Details
Decimal	BCD and real number storage formats can be specified. Word: -32,768 to 32,767 (signed) 0 to 65,535 (unsigned) 2-word: -2,147,483,648 to 2,147,483,647 (signed) 0 to 4,294,967,295 (unsigned)
Hexadecimal	BCD and real number storage formats cannot be specified. Word: 0000 to FFFF (unsigned) 2-word: 00000000 to FFFFFFFF (unsigned)
Binary	BCD and real number storage formats cannot be specified. Word: 0000000000000000 to 1111111111111111 (unsigned) 2-word: 00000000000000000000000000000000 to 11111111111111111111111111111111 (unsigned)
Octal	BCD and real number storage formats cannot be specified. Word: 000000 to 177777 (unsigned) 2-word: 0000000000 to 3777777777 (unsigned)

Real numbers have floating decimal points. BCD are numerals with each digit of the decimal number displayed in 4-bit binary code.

When display formats other than decimal are selected, real number and BCD cannot be selected for the storage type.

Once decimal has been selected as the display type, real number or BCD can be selected for the storage type. If other display formats are then selected, UINT (1-word unsigned) is automatically set as the storage format.

### Storage Types

Storage Type	Details																																				
INT (signed, 1 word)	Stores as 2-byte integer at the write destination address. (-32,768 to 32,767 in decimal) The data format is described below. The most significant bit is treated as the sign. (0: Positive, 1: Negative) <table style="margin-left: 20px;"> <tr> <td style="text-align: center;">b15</td> <td style="border: 1px solid black; padding: 2px;">1</td> <td style="border: 1px solid black; padding: 2px;">0</td> <td style="border: 1px solid black; padding: 2px;">1</td> <td style="border: 1px solid black; padding: 2px;">0</td> <td style="border: 1px solid black; padding: 2px;">0</td> <td style="border: 1px solid black; padding: 2px;">0</td> <td style="border: 1px solid black; padding: 2px;">0</td> <td style="border: 1px solid black; padding: 2px;">1</td> <td style="border: 1px solid black; padding: 2px;">0</td> <td style="border: 1px solid black; padding: 2px;">0</td> <td style="border: 1px solid black; padding: 2px;">0</td> <td style="border: 1px solid black; padding: 2px;">1</td> <td style="border: 1px solid black; padding: 2px;">0</td> <td style="border: 1px solid black; padding: 2px;">0</td> <td style="border: 1px solid black; padding: 2px;">0</td> <td style="border: 1px solid black; padding: 2px;">1</td> <td style="text-align: center;">b0</td> </tr> <tr> <td></td> <td style="text-align: center;">2<sup>15</sup></td> <td style="text-align: center;">2<sup>14</sup></td> <td style="text-align: center;">2<sup>13</sup></td> <td style="text-align: center;">2<sup>12</sup></td> <td style="text-align: center;">2<sup>11</sup></td> <td style="text-align: center;">2<sup>10</sup></td> <td style="text-align: center;">2<sup>9</sup></td> <td style="text-align: center;">2<sup>8</sup></td> <td style="text-align: center;">2<sup>7</sup></td> <td style="text-align: center;">2<sup>6</sup></td> <td style="text-align: center;">2<sup>5</sup></td> <td style="text-align: center;">2<sup>4</sup></td> <td style="text-align: center;">2<sup>3</sup></td> <td style="text-align: center;">2<sup>2</sup></td> <td style="text-align: center;">2<sup>1</sup></td> <td style="text-align: center;">2<sup>0</sup></td> <td></td> </tr> </table> <p style="margin-left: 20px;">↑ Sign</p> <p>Example: 1010 0001 0001 0001  <math>-1 \times 2^{15} + 2^{13} + 2^8 + 2^4 + 2^0 = -32768 + 8192 + 256 + 16 + 1 = -24303</math>            If there is an overflow, bits 16 and later are ignored.            For example, if 1 is added to 1111111111111111(-1), it will become 0000000000000000(0).</p>	b15	1	0	1	0	0	0	0	1	0	0	0	1	0	0	0	1	b0		2 <sup>15</sup>	2 <sup>14</sup>	2 <sup>13</sup>	2 <sup>12</sup>	2 <sup>11</sup>	2 <sup>10</sup>	2 <sup>9</sup>	2 <sup>8</sup>	2 <sup>7</sup>	2 <sup>6</sup>	2 <sup>5</sup>	2 <sup>4</sup>	2 <sup>3</sup>	2 <sup>2</sup>	2 <sup>1</sup>	2 <sup>0</sup>	
b15	1	0	1	0	0	0	0	1	0	0	0	1	0	0	0	1	b0																				
	2 <sup>15</sup>	2 <sup>14</sup>	2 <sup>13</sup>	2 <sup>12</sup>	2 <sup>11</sup>	2 <sup>10</sup>	2 <sup>9</sup>	2 <sup>8</sup>	2 <sup>7</sup>	2 <sup>6</sup>	2 <sup>5</sup>	2 <sup>4</sup>	2 <sup>3</sup>	2 <sup>2</sup>	2 <sup>1</sup>	2 <sup>0</sup>																					

**NS Series Programming Manual**

Storage Type	Details
UINT (unsigned, 1 word)	<p>Stores as 2-byte integer at the write destination address. (0 to 65,535 in decimal)</p> <p>The data format is described below.</p> <div style="text-align: center;"> </div> <p>Example: 1010 0001 0001 0001</p> $2^{15} + 2^{13} + 2^8 + 2^4 + 2^0 = 32768 + 8192 + 256 + 16 + 1 = 41233$ <p>If there is an overflow, bits 32 and later are ignored.</p> <p>For example, if 1 is added to 11111111111111111111111111111111(-1), it will become 00000000000000000000000000000000(0).</p>
DINT (signed, 2 words)	<p>Stores as 4-byte integer at the write destination address. (*2,147,483,648 to 2,147,483,647 in decimal)</p> <p>The data format is described below.</p> <p>The most significant bit is treated as the sign. (0: Positive, 1: Negative)</p> <div style="text-align: center;"> </div> <p>The set address and the address + 1 are used (2 words) and displayed as one numeral.</p> <p>Example: 1010 0001 0001 0001 1010 0001 0001 0001</p> $-1 \times 2^{31} + 2^{29} + 2^{24} + 2^{20} + 2^{16} + 2^{15} + 2^{13} + 2^8 + 2^4 + 2^0 =$ $-2147483648 + 536870912 + 16777216 + 1048576 + 65536 + 32768 + 8192 + 256 + 16 + 1 = -1592680175$
UDINT (unsigned, 2 words)	<p>Stores as 4-byte integer at the write destination address. (0 to 4,294,967,295 in decimal)</p> <p>The data format is described below.</p> <div style="text-align: center;"> </div> <p>The set address and the address + 1 are used (2 words) and displayed as one numeral.</p> <p>Example: 1010 0001 0001 0001 1010 0001 0001 0001</p> $2^{31} + 2^{29} + 2^{24} + 2^{20} + 2^{16} + 2^{15} + 2^{13} + 2^8 + 2^4 + 2^0 = 2147483648 + 536870912 + 16777216 + 1048576 + 65536 + 32768 + 8192 + 256 + 16 + 1 = 2702287121$

NS Series Programming Manual

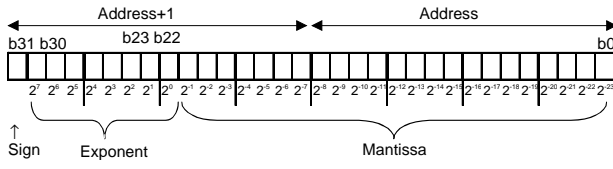
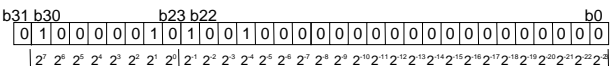
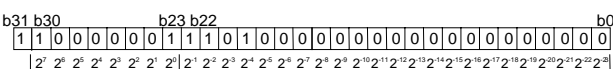
Storage Type	Details
<p>REAL (real number)</p>	<p>Stores as 4-byte real number at the write destination address.                      (Can be set in decimal between approximately <math>\pm 1.175494351 \times 10^{-38}</math> and approximately <math>\pm 3.402823466 \times 10^{+38}</math> (7 digits enabled)).                      Four-byte real numbers that conform to IEEE754.                      Displayed as real number = <math>(-1)^{\text{signed}} \times -1.[\text{mantissa}] \times 2^{\text{index}-127}</math>.                      The data format is described below.                      Bits 0 to 22 (23 bits) are the mantissa, bits 23 to 30 (8 bits) are the exponent, and bit 31 indicates the sign (0: positive; 1:negative).</p>  <p>The set address and the address + 1 are used (2 words) and displayed as one numeral.                      Real numbers are divided into 5 types: Normalized numbers, non-normalized numbers, zero, infinity, and non-numbers.</p> <p><b>Normalized Numbers</b>                      If the exponent is 00000001 to 11111111,                      and the mantissa is 000000000000000000000000 to 11111111111111111111111111111111,                      this is called a normalized number.                      Example 1: 0100 0001 0100 1000 0000 0000 0000 0000                      If the sign, exponent, and mantissa are separated, the number will appear as shown below.</p>  <p>Sign: +                      Exponent: <math>2^7 + 2^1 = 128 + 2 = 130</math>                      Mantissa: <math>2^{-1} + 2^{-4} = 0.5 + 0.0625 = 0.5625</math>                      Real number = <math>(1 + 0.5625) \times 2^{(130-127)} = 1.5625 \times 8 = 12.5</math>                      Example 2: 1100 0000 1110 0000 0000 0000 0000 0000                      If the sign, exponent, and mantissa are separated, the number will appear as shown below.</p>  <p>Sign: -                      Exponent: <math>2^7 + 2^0 = 128 + 1 = 129</math>                      Mantissa: <math>2^{-1} + 2^{-2} = 0.5 + 0.25 = 0.75</math>                      Real number = <math>-(1 + 0.75) \times 2^{(129-127)} = -1.75 \times 4 = -7</math></p>

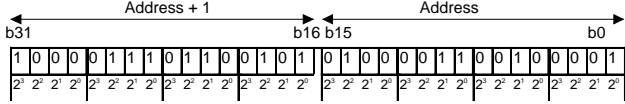
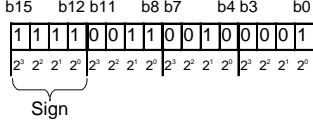
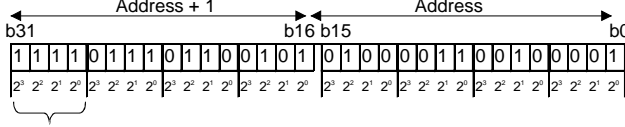

NS Series Programming Manual

Storage Type	Details
<p>BCD2 (unsigned, 2 words)</p>	<p>Stores as 4-byte BCD at the write destination address. (0 to 99,999,999 in decimal) The data format is described below. The set address and the address + 1 are used (2 words) and displayed as one numeral.</p>  <p>Example: 1000 0111 0110 0101 0100 0011 0010 0001  1<sup>st</sup> digit: <math>2^0 = 1</math>; 2<sup>nd</sup> digit: <math>2^1 = 2</math>; 3<sup>rd</sup> digit: <math>2^1 + 2^0 = 3</math>; 4<sup>th</sup> digit: <math>2^2 = 4</math>  5<sup>th</sup> digit: <math>2^2 + 2^0 = 5</math>; 6<sup>th</sup> digit: <math>2^2 + 2^1 = 6</math>; 7<sup>th</sup> digit: <math>2^2 + 2^1 + 2^0 = 7</math>; 8<sup>th</sup> digit: <math>2^3 = 8</math>  BCD value: 87654321</p> <p>Values between 0 and 9 can be obtained for each digit. Higher values (A to F) cannot be expressed in BCD. The display for numeral display and input will be [#####].</p>
<p>BCD 1 (signed (leftmost digit: F), 1 word)</p>	<p>Stores as 2-byte BCD at the write destination address. (-999 to 9,999 in decimal) The data format is described below. The leftmost digit (bits 12 to 15) is treated as the sign. (Negative when the leftmost digit is F(1111).)</p>  <p>Example: 1111 0011 0010 0001  1<sup>st</sup> digit: <math>2^0 = 1</math>; 2<sup>nd</sup> digit: <math>2^1 = 2</math>; 3<sup>rd</sup> digit: <math>2^1 + 2^0 = 3</math>; 4<sup>th</sup> digit: 1111, therefore negative.  BCD value: -321</p> <p>Values between 0 and 9 are possible for each digit. Higher values (A to F) cannot be expressed in BCD. (F can be stored only in the leftmost digit.) The display for numeral display and input will be [####].</p>
<p>BCD 1 (signed (leftmost digit: F), 2 words)</p>	<p>Stores as 4-byte BCD at the write destination address. (-9999999 to 99,999,999 in decimal) The data format is described below. The leftmost digit (bits 28 to 31) is treated as the sign. (Negative when the leftmost digit is F(1111).) The address set under numeral display and input and the address + 1 are used (2 words) and displayed as one numeral.</p>  <p>Example: 1111 0111 0110 0101 0100 0011 0010 0001  1st digit: <math>2^0 = 1</math>; 2nd digit: <math>2^1 = 2</math>; 3rd digit: <math>2^1 + 2^0 = 3</math>; 4th digit: <math>2^2 = 4</math>  5th digit: <math>2^2 + 2^0 = 5</math>; 6th digit: <math>2^2 + 2^1 = 6</math>; 7th digit: <math>2^2 + 2^1 + 2^0 = 7</math>;  8th digit: 1111, therefore negative.  BCD value: -7654321</p> <p>Values between 0 and 9 can be obtained for each digit. Higher values (A to F) cannot be expressed in BCD. (F can be stored only in the leftmost digit.) The display for numeral display and input will be [#####].</p>





## Using Tags

If screens are to be created using tags, the storage type and the size of the tag data type (1 word or 2 words) must be the same in the settings for functional objects that handle numbers.

The following table gives the combinations of storage types and compatible data types. CHANNEL can be used with all storage types.

Storage type	Data type of corresponding tag (See note.)
INT	INT, CHANNEL
UINT	UINT, CHANNEL
DINT	DINT, CHANNEL
UDINT	UDINT, CHANNEL
REAL	REAL, CHANNEL
BCD2 (1 word, unsigned)	UINT_BCD, CHANNEL
BCD2 (2 words, unsigned)	UDINT_BCD, CHANNEL
BCD1 (signed (leftmost digit: F), 1 word)	WORD, CHANNEL
BCD1 (2 words, signed (leftmost digit: F))	DWORD, CHANNEL
BCD2 (1 word, signed (leftmost bit))	WORD, CHANNEL
BCD2 (2 words, signed (leftmost bit))	DWORD, CHANNEL

Note: The above data types also apply to tags that are array variables.

### Note

- ◆ You can use the CX-Designer's error check to confirm whether the storage type matches the data type of tags set for functional components. For details on the error check, refer to "validation" in the online help for the CX-Designer.
- ◆ Depending on the settings for functional objects, there will be items for specifying BCD or binary in the Project Properties Dialog Box under **PT – Properties** in the CX-Designer.  
For these items, the error check finds only whether the size matches. It will not check whether the data type matches. Therefore, be sure to set tags with the correct data type when making the settings.
- ◆ ULINT, LINT, ULINT\_BCD, LREAL, and LWORD can be set as the data type for tags, but tags set with these data types cannot be used for functional objects because there are no compatible storage types. They can be used only for the READCMEM and WRITECMEM macros.
- ◆ If direct addresses are set, there are no restrictions on the data type resulting from the storage type.

### 2-8-5 Date and Time Format (General Tab)

The display formats outlined below can be used for functional objects that display date and time. In most cases, the date and time format is set on the General Tab Page.

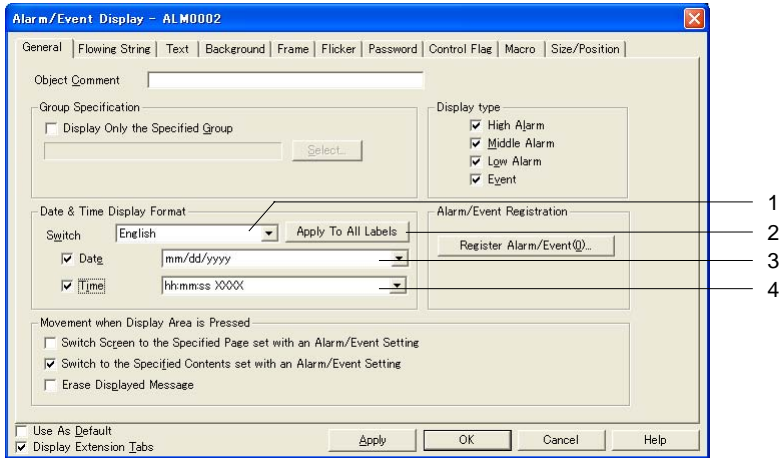

No.	Setting	Details
1	Switch	Switches labels. The date and time display format can be set for each label.
2	Apply the same value to all labels	Applies the data display format and time display format to all of the selected labels. This button can be used only when the ON Check Box for the data or time is selected. This button cannot be used in the following cases. <ul style="list-style-type: none"> <li>• When the <i>Date &amp; Time Display Format</i> Check Box is selected on the Edit/Disp Tab Page in the Option Dialog Box accessed from the <b>Tools – Option</b> Menu Command</li> <li>• When there is only one label</li> <li>• When the ON Check Boxes for the data and time are cleared</li> </ul>
3	Date	Select the date display format from the list. For some functional objects, you can select whether or not to display the date. For the functional objects with that option, tick the check box to display the date.
4	Time	Select the time display format from the list. For some functional objects, you can select whether or not to display the time. For the functional objects with that option, tick the check box to display the time.

**NS Series Programming Manual**

Display item	Display format																																																																																								
Date	<p>yyyy: year (4 digits);                      yy: year (2 digits)                      mm: month (2 digits)                      MMM. month in 3 characters, e.g., Feb                      MMMM month full spell out, e.g., February                      dd: day of month (2 digits)                      ddd: day of the week (1 Japanese characters, e.g., 土)                      dddd: day of the week (3 Japanese characters, e.g., 土曜日)                      DDD: day of the week (3 characters, e.g., Sat)</p> <table border="0"> <tr> <td data-bbox="512 517 975 551">Display formats</td> <td data-bbox="975 517 1439 551">Display examples</td> </tr> <tr> <td>yyyy[JY]mm[JM]dd[JD] dddd</td> <td>2000年06月17日 土曜日</td> </tr> <tr> <td>yy[JY]mm[JM]dd[JD] dddd</td> <td>00年06月17日 土曜日</td> </tr> <tr> <td>yyyy[JY]mm[JM]dd[JD] (dddd)</td> <td>2000年06月17日 (土曜日)</td> </tr> <tr> <td>yy[JY]mm[JM]dd[JD] (dddd)</td> <td>00年06月17日 (土曜日)</td> </tr> <tr> <td>yyyy[JY]mm[JM]dd[JD]</td> <td>2000年06月17日</td> </tr> <tr> <td>yy[JY]mm[JM]dd[JD]</td> <td>00年06月17日</td> </tr> <tr> <td>yyyy/mm/dd dddd</td> <td>2000/06/17 土曜日</td> </tr> <tr> <td>yy/mm/dd dddd</td> <td>00/06/17 土曜日</td> </tr> <tr> <td>yyyy/mm/dd (dddd)</td> <td>2000/06/17 (土曜日)</td> </tr> <tr> <td>yy/mm/dd (dddd)</td> <td>00/06/17 (土曜日)</td> </tr> <tr> <td>yyyy/mm/dd</td> <td>2000/06/17</td> </tr> <tr> <td>yy/mm/dd</td> <td>00/06/17</td> </tr> <tr> <td>ddd mm/dd/yyyy</td> <td>土 06/17/2000</td> </tr> <tr> <td>ddd mm/dd/yy</td> <td>土 06/17/00</td> </tr> <tr> <td>(ddd) mm/dd/yyyy</td> <td>(土)06/17/2000</td> </tr> <tr> <td>(ddd) mm/dd/yy</td> <td>(土)06/17/00</td> </tr> <tr> <td>yyyy.mm.dd dddd</td> <td>2000.06.17 土曜日</td> </tr> <tr> <td>yy.mm.dd dddd</td> <td>00.06.17 土曜日</td> </tr> <tr> <td>yyyy.mm.dd (dddd)</td> <td>2000.06.17 (土曜日)</td> </tr> <tr> <td>yy.mm.dd (dddd)</td> <td>00.06.17 (土曜日)</td> </tr> <tr> <td>yyyy.mm.dd</td> <td>2000.06.17</td> </tr> <tr> <td>yy.mm.dd</td> <td>00.06.17</td> </tr> <tr> <td>ddd mm.dd.yyyy</td> <td>土 06.17.2000</td> </tr> <tr> <td>ddd mm.dd.yy</td> <td>土 06.17.00</td> </tr> <tr> <td>(ddd) mm.dd.yyyy</td> <td>(土)06.17.2000</td> </tr> <tr> <td>(ddd) mm.dd.yy</td> <td>(土)06.17.00</td> </tr> <tr> <td>yyyy-mm-dd</td> <td>2000-06-17</td> </tr> <tr> <td>mm/dd/yyyy</td> <td>02/23/2001</td> </tr> <tr> <td>mm/dd/yy</td> <td>02/23/01</td> </tr> <tr> <td>DDD,MMMM dd,yyyy</td> <td>Fri,February 23,2001</td> </tr> <tr> <td>MMMM dd,yyyy</td> <td>February 23,2001</td> </tr> <tr> <td>DDD,MMM dd,yy</td> <td>Fri,Feb 23,01</td> </tr> <tr> <td>MMM dd,yy</td> <td>Feb 23,01</td> </tr> <tr> <td>dd/mm/yyyy</td> <td>23/02/2001</td> </tr> <tr> <td>dd/mm/yy</td> <td>23/02/01</td> </tr> <tr> <td>DDD/dd/mm/yyyy</td> <td>Fri/23/02/2001</td> </tr> <tr> <td>DDD/dd/mm/yy</td> <td>Fri/23/02/01</td> </tr> <tr> <td>DDD,dd MMMM,yyyy</td> <td>Fri,23 February,2001</td> </tr> <tr> <td>dd MMMM,yyyy</td> <td>23 February,2001</td> </tr> <tr> <td>DDD,dd MMM,yy</td> <td>Fri,23 Feb,01</td> </tr> <tr> <td>dd MMM,yy</td> <td>23 Feb.01</td> </tr> <tr> <td>dd.mm.yy</td> <td>23.02.01</td> </tr> <tr> <td>DDD.dd.mm.yy</td> <td>Fri.23.02.01</td> </tr> </table>	Display formats	Display examples	yyyy[JY]mm[JM]dd[JD] dddd	2000年06月17日 土曜日	yy[JY]mm[JM]dd[JD] dddd	00年06月17日 土曜日	yyyy[JY]mm[JM]dd[JD] (dddd)	2000年06月17日 (土曜日)	yy[JY]mm[JM]dd[JD] (dddd)	00年06月17日 (土曜日)	yyyy[JY]mm[JM]dd[JD]	2000年06月17日	yy[JY]mm[JM]dd[JD]	00年06月17日	yyyy/mm/dd dddd	2000/06/17 土曜日	yy/mm/dd dddd	00/06/17 土曜日	yyyy/mm/dd (dddd)	2000/06/17 (土曜日)	yy/mm/dd (dddd)	00/06/17 (土曜日)	yyyy/mm/dd	2000/06/17	yy/mm/dd	00/06/17	ddd mm/dd/yyyy	土 06/17/2000	ddd mm/dd/yy	土 06/17/00	(ddd) mm/dd/yyyy	(土)06/17/2000	(ddd) mm/dd/yy	(土)06/17/00	yyyy.mm.dd dddd	2000.06.17 土曜日	yy.mm.dd dddd	00.06.17 土曜日	yyyy.mm.dd (dddd)	2000.06.17 (土曜日)	yy.mm.dd (dddd)	00.06.17 (土曜日)	yyyy.mm.dd	2000.06.17	yy.mm.dd	00.06.17	ddd mm.dd.yyyy	土 06.17.2000	ddd mm.dd.yy	土 06.17.00	(ddd) mm.dd.yyyy	(土)06.17.2000	(ddd) mm.dd.yy	(土)06.17.00	yyyy-mm-dd	2000-06-17	mm/dd/yyyy	02/23/2001	mm/dd/yy	02/23/01	DDD,MMMM dd,yyyy	Fri,February 23,2001	MMMM dd,yyyy	February 23,2001	DDD,MMM dd,yy	Fri,Feb 23,01	MMM dd,yy	Feb 23,01	dd/mm/yyyy	23/02/2001	dd/mm/yy	23/02/01	DDD/dd/mm/yyyy	Fri/23/02/2001	DDD/dd/mm/yy	Fri/23/02/01	DDD,dd MMMM,yyyy	Fri,23 February,2001	dd MMMM,yyyy	23 February,2001	DDD,dd MMM,yy	Fri,23 Feb,01	dd MMM,yy	23 Feb.01	dd.mm.yy	23.02.01	DDD.dd.mm.yy	Fri.23.02.01
Display formats	Display examples																																																																																								
yyyy[JY]mm[JM]dd[JD] dddd	2000年06月17日 土曜日																																																																																								
yy[JY]mm[JM]dd[JD] dddd	00年06月17日 土曜日																																																																																								
yyyy[JY]mm[JM]dd[JD] (dddd)	2000年06月17日 (土曜日)																																																																																								
yy[JY]mm[JM]dd[JD] (dddd)	00年06月17日 (土曜日)																																																																																								
yyyy[JY]mm[JM]dd[JD]	2000年06月17日																																																																																								
yy[JY]mm[JM]dd[JD]	00年06月17日																																																																																								
yyyy/mm/dd dddd	2000/06/17 土曜日																																																																																								
yy/mm/dd dddd	00/06/17 土曜日																																																																																								
yyyy/mm/dd (dddd)	2000/06/17 (土曜日)																																																																																								
yy/mm/dd (dddd)	00/06/17 (土曜日)																																																																																								
yyyy/mm/dd	2000/06/17																																																																																								
yy/mm/dd	00/06/17																																																																																								
ddd mm/dd/yyyy	土 06/17/2000																																																																																								
ddd mm/dd/yy	土 06/17/00																																																																																								
(ddd) mm/dd/yyyy	(土)06/17/2000																																																																																								
(ddd) mm/dd/yy	(土)06/17/00																																																																																								
yyyy.mm.dd dddd	2000.06.17 土曜日																																																																																								
yy.mm.dd dddd	00.06.17 土曜日																																																																																								
yyyy.mm.dd (dddd)	2000.06.17 (土曜日)																																																																																								
yy.mm.dd (dddd)	00.06.17 (土曜日)																																																																																								
yyyy.mm.dd	2000.06.17																																																																																								
yy.mm.dd	00.06.17																																																																																								
ddd mm.dd.yyyy	土 06.17.2000																																																																																								
ddd mm.dd.yy	土 06.17.00																																																																																								
(ddd) mm.dd.yyyy	(土)06.17.2000																																																																																								
(ddd) mm.dd.yy	(土)06.17.00																																																																																								
yyyy-mm-dd	2000-06-17																																																																																								
mm/dd/yyyy	02/23/2001																																																																																								
mm/dd/yy	02/23/01																																																																																								
DDD,MMMM dd,yyyy	Fri,February 23,2001																																																																																								
MMMM dd,yyyy	February 23,2001																																																																																								
DDD,MMM dd,yy	Fri,Feb 23,01																																																																																								
MMM dd,yy	Feb 23,01																																																																																								
dd/mm/yyyy	23/02/2001																																																																																								
dd/mm/yy	23/02/01																																																																																								
DDD/dd/mm/yyyy	Fri/23/02/2001																																																																																								
DDD/dd/mm/yy	Fri/23/02/01																																																																																								
DDD,dd MMMM,yyyy	Fri,23 February,2001																																																																																								
dd MMMM,yyyy	23 February,2001																																																																																								
DDD,dd MMM,yy	Fri,23 Feb,01																																																																																								
dd MMM,yy	23 Feb.01																																																																																								
dd.mm.yy	23.02.01																																																																																								
DDD.dd.mm.yy	Fri.23.02.01																																																																																								

**NS Series Programming Manual**

Display item	Display format	
Time	hh: hour, mm: minutes, ss: seconds, xxxx: 午前/午後, XXXX: AM/PM	
	Display formats	Display examples
	xxxx hh[Jh]mm[Jm]ss[Js]	午後01時51分25秒
	xxxx hh[Jh]mm[Jm]	午後01時51分
	hh[Jh]mm[Jm]ss[Js]	13時51分25秒
	hh[Jh]mm[Jm]	13時51分
	xxxx hh:mm:ss	午前10:15:20
	xxx hh:mm	午前10:15
	hh:mm:ss XXXX	10:15:20 AM
	hh:mm XXXX	10:15 AM
	hh:mm:ss	10:15:20
	hh:mm	10:15
	nn ms (See note.)	1000 ms
	n s (See note.)	1 s

Note: Only data log objects can be used.

**Reference**

- ◆ Depending on the settings at the CX-Designer, the Japanese characters shown below will be displayed at the PT.

Display at CX-Designer	Display at PT
[JY]	年
[JM]	月
[JD]	日
[Jh]	時
[Jm]	分
[Js]	秒

**2-8-6 Text Attributes**

The text attributes such as font, size, and color can be set for functional objects that display characters. The text attributes are set on the Text Tab Page.

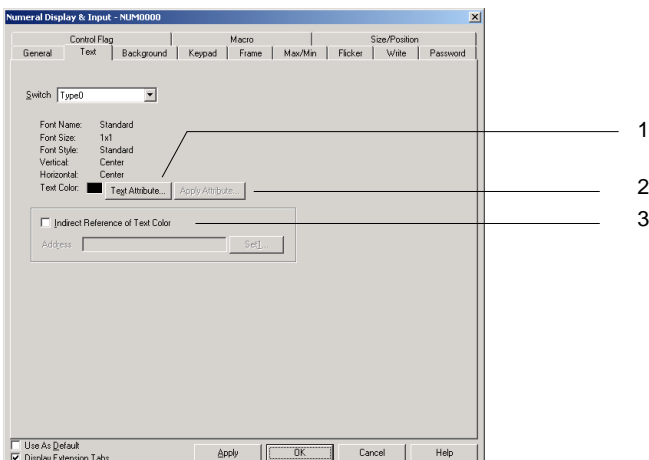

No.	Setting	Details
1	Text Attribute Button	Click the <b>Text Attribute</b> Button to display the Text Attribute Dialog Box. Set the font, size, and other text attributes.
2	Apply Attribute Button	If multiple labels are being set, the text attributes for one label can be applied to all labels. Click the <b>Apply Attribute</b> Button to display the Apply Text Attribute Dialog Box and select the attributes to be applied. The <b>Apply Attribute</b> Button cannot be used if there is only one label.
3	Indirect Reference of Text Color	When this option is selected, the label's color can be changed using the value of a preset communications address. Set a valid color code (0 to FF) in the communications address.

## PT Fonts

Raster, vector, scalable font, and 7-segment fonts can be displayed on PTs.

Raster fonts display the font itself as a bitmap and can be used for all functional objects that display characters.

Vector fonts display multiple points that show coordinates of characters and the border that connect those points. Vector fonts can only be used only for buttons, lamps, multifunction objects, and labels.

A scalable font is a font that expresses character shapes as the coordinates of the base point and a collection of lines.

The scalable font can be used for all functional objects that display text.

The 7-segment font uses a 7-segment LED-type font. The following characters can be displayed: 0 to 9, A to F, the plus and minus signs (+ and -), periods (.), commas (,), spaces ( ), and colons (:).

The 7-segment font can be used for all functional objects that display text.

## Raster Fonts

The following raster fonts can be used.

Font	Characters that can be displayed	Base sizes	Magnification
Rough	Half-width alphanumerics, Katakana, Greek, Coptic, Cyrillic	8 × 8	1 × 1, 1 × 2, 2 × 1, 2 × 2, 3 × 3, 4 × 4, 8 × 8
Standard	Half-width alphanumerics, Katakana, full-width JIS1 and JIS2 standard characters, Greek, Coptic, Cyrillic, Korean, simplified Chinese	8 × 16, 16 × 16	1 × 1, 1 × 2, 2 × 1, 2 × 2, 3 × 3, 4 × 4, 8 × 8
Fine	Half-width alphanumerics, Katakana, full-width JIS1 and JIS2 standard characters, Greek, Coptic, Cyrillic	16 × 32, 32 × 32	1 × 1, 1 × 2, 2 × 1, 2 × 2, 3 × 3, 4 × 4, 8 × 8
Gothic numeral	0 to 9, A to F, +, -, decimal point, comma, space, and colon	---	8 × 16, 16 × 32, 24 × 48, 32 × 64, 48 × 96, 64 × 128

## Vector Fonts

All vector fonts installed on the personal computer using CX-Designer can be used, e.g., Arial.

Vector fonts can be used when displaying labels for ON/OFF buttons, word buttons, command buttons, bit lamps, word lamps, and Multifunction Objects, or when displaying fixed character strings using fixed text strings.

### Scalable Font

The following scalable font can be used.

Font	Size	Horizontal magnification
Scalable Gothic	6 to 255 pixels	50% to 200%

The scalable font can be enlarged or reduced horizontally.



### Seven-segment Font

The following 7-segment font can be used.

Font	Sizes
7-segment numeral	8x14, 12x21, 16x27, 20x34, 24x41, 32x54, 48x82, 64x108, 80x135, 96x161, 112x188, 128x216, 160x269, 200x336 (See note.)

Note: For the NS5, NSJ5, and NSH5, sizes 8x14 to 96x161 can be used.

The following characters can be displayed in 7-segment font: 0 to 9, A to F, the plus and minus signs (+ and -), periods (.), commas (,), spaces ( ), and colons (:).

#### Reference

- ◆ Precautions When Using Raster Fonts
  - If \ is entered using raster fonts, a backslash will be displayed on the PT.
- ◆ Vector fonts cannot be used if text is used for character strings or to indirectly specify character color or background color.
- ◆ Refer to the appendices for details on the characters that can be displayed.
- ◆ The scalable font can be used for project versions 7.0 or higher.
- ◆ The 7-segment font and Gothic numeral font can be used for project versions 7.0 or higher.
- ◆ Only characters that can be displayed in the Gothic numeral or 7-segment font will display correctly. Other characters will not be displayed correctly.
- ◆ Use the scalable font if displaying text in Thai.
- ◆ If background fill is set to OFF when 7-segment numeral fonts are displayed on the PT, then a rough outline will be displayed for the fonts. Set the background fill to ON to display the fonts smoothly.

### Setting Text Attributes

Click the **Text Attribute** Button to display the Text Attribute Dialog Box. Set the font, size, and other text attributes.

**NS Series Programming Manual**

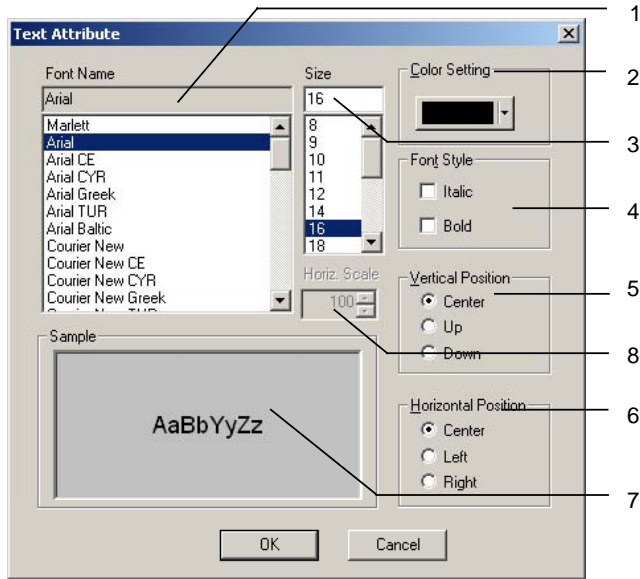

No.	Setting	Details
1	Font Name	Select the font from the list.
2	Color Setting	Sets the display character color.
3	Size	Sets the font size. Set the magnification for raster and 7-segment fonts and character size for vector and scalable fonts.
4	Font style	Sets bold or italics. This selection can be made only for vector fonts.
5	Vertical position	Select the vertical position as the up, center, or down.
6	Horizontal position	Select the horizontal position as left, center, or right.
7	Sample	Displays a sample at the current settings.
8	Horizontal magnification	With the scaled font, a magnification between 50% and 200% can be specified.

**Applying Text Attribute**

Text attributes such as font, size, and color can be applied to other labels. Click the **Apply Attribute** Button on the Label Tab Page (or Text Attribute Tab Page) to display the Apply Text Attribute Dialog Box. Select the attributes to be applied to other labels.

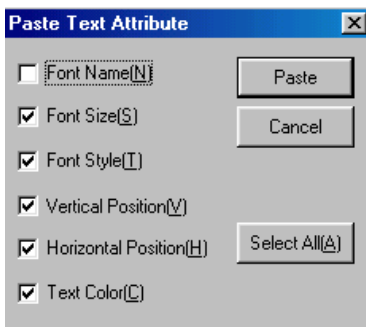



**Types of Attributes for Application**

<b>Attribute type</b>	<b>Details</b>
Font name	Selected font types
Font size	Sets the font size. Set the magnification for raster and 7-segment fonts and character size for vector and scalable fonts.
Font style	Bold, italic (for vector fonts only)
Vertical position	Up, center, down
Horizontal position	Left, center, right
Text color	Character color

### 2-8-7 Setting Colors (Color/Shape Tab)

Set the ON and OFF colors for buttons and lamps. Specify the shape of the button or lamp then click the **Color1(OFF)** or **Color2(ON)** Button on the Color/Shape Tab Page and select the color from the Color Setting Dialog Box. The label color can also be set indirectly from an address by selecting the *Indirect* Option.

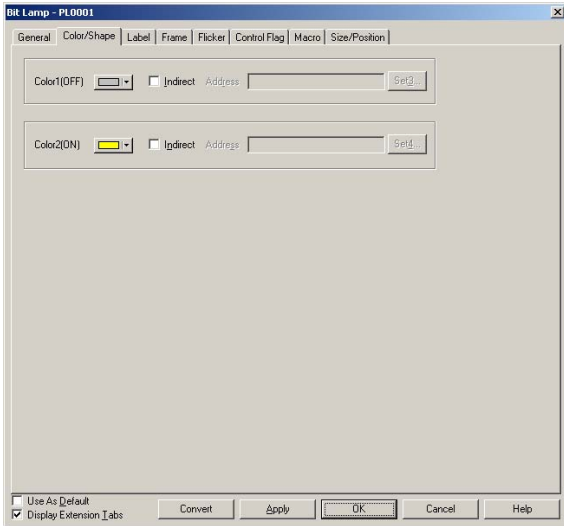

**Note**

- ◆ The color settings will not be displayed if *Select shape* is selected for the object shape.
- ◆ If an indirect reference of Text Color is set, set a color code between 0 and FF to the address. Check the color codes and display colors in the Color Setting Dialog Box.  
If a value other than 0 to FF is set as the address, the display color will be invalid.

#### Color

Color is set from the Color Setting Dialog Box.

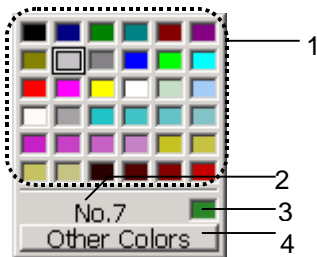

No.	Setting	Details
1	Color palette	Select from one of the 36 colors registered in the color palette (favorite colors).
2	Color code	Indicates the color code of the selected color.
3	Current color	Displays the selected color when that color is not registered in the color palette.
4	Other Colors Button	Click this button to select a color that is not registered in the color palette.

The following dialog box can be displayed by clicking the **Other Colors** Button. Use the Color Setting Dialog Box to select a color that is not registered in the color palette or register a color in the color palette.

**NS Series Programming Manual**

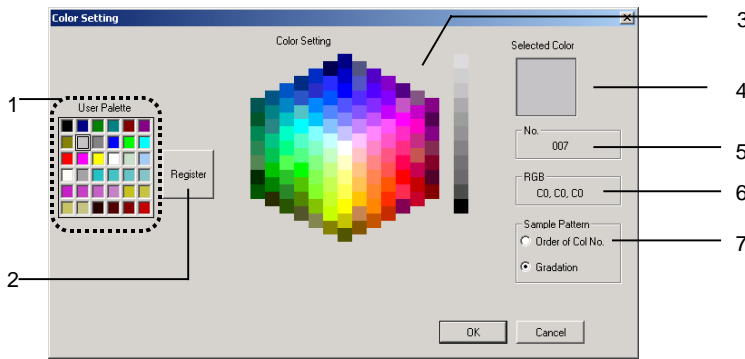

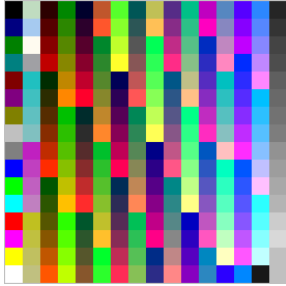
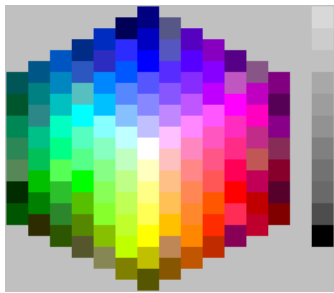
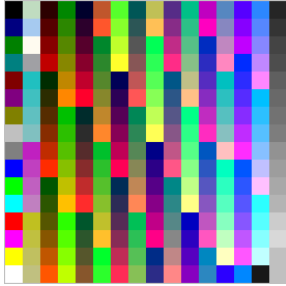
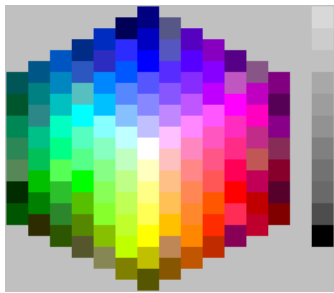
No.	Setting	Details
1	User Palette	Displays the colors that have been registered as favorite colors in the color palette.
2	Register	Registers the selected color in the color palette.
3	Color Setting	Displays all of the available colors.
4	Selected Color	Displays the selected color.
5	No.	Displays the selected color's color code.
6	RGB	Displays the selected colors RGB values (in hexadecimal).
7	Sample Pattern	The Color Setting display can be set to <i>Order of Col No.</i> (color code matrix) or <i>Gradation</i> . The Order of Col No. display shows all 256 colors. The Gradation display shows only 138 colors, but makes it easy to change the color slightly by selecting a nearby color tone.
		<table border="0" style="width: 100%;"> <tr> <td style="width: 50%; vertical-align: top;"> <p>Order of Col No. (arranged by color code)</p>  </td> <td style="width: 50%; vertical-align: top;"> <p>Gradation</p>  </td> </tr> </table>
<p>Order of Col No. (arranged by color code)</p> 	<p>Gradation</p> 	

**2-8-8 Background**

Set the tile color for the background of functional objects. Click the **Color** Button to tile the background and select the background color from the Color Setting Dialog Box. The functional object's background color can also be set indirectly from an address by selecting the *Indirect Reference of Color* Option.

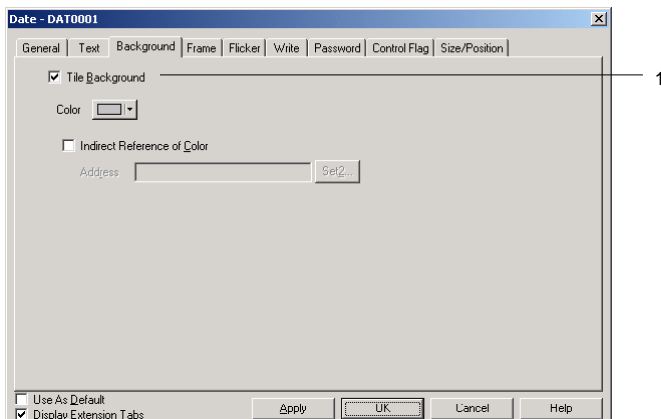

**NS Series Programming Manual**

No.	Setting	Details
1	Tile background	Select this option to tile the background. (Selected in default settings.) Deselect this option to leave the background transparent.

**Note**

- ◆ If an indirect reference of color is set, set a color code between 0 and FF to the address. If a value other than 0 to FF is set as the address, the display color will be invalid.

**2-8-9 Selecting Shape (Color/Shape Tab)**

If a shape can be specified for the selected lamp or button functional object, the shape displayed on the Color/shape Tab Page can be selected. Click the **Select** Button to select from a variety of shape types.

For some shape types, a pair of ON and OFF shapes can be set.

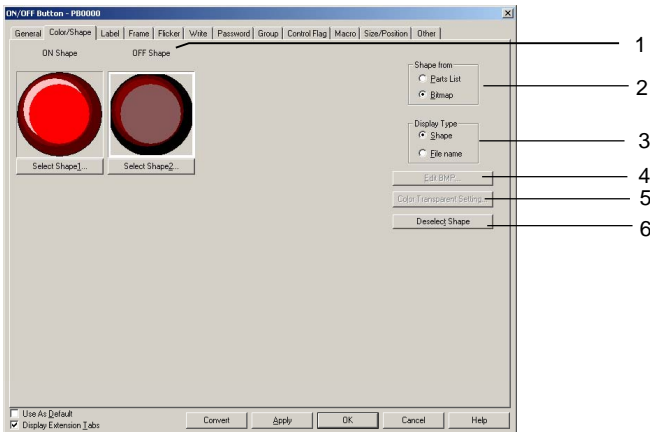

No.	Setting	Details
1	Selected image display area	The image or file name of the shape selected in 2, above, will be displayed.
2	Shape from	If <i>Parts List</i> is selected and a Select Shape Button is clicked, the Select Shape Dialog Box will be displayed. If <i>Bitmap</i> is selected and a shape specification button is clicked, the Select File Dialog Box will be displayed.
3	Display Type	If <i>Shape</i> is selected, an image of the selected shape will be displayed. If <i>File name</i> is selected, the file name of the selected shape will be displayed.
4	Edit BMP	If the displayed BMP or JPEG image is selected and the Edit Button is clicked, the image editor will start and editing will be enabled.
5	Color Transparent Setting	Click this button to display the Transparent Color Setting Dialog Box and enable setting transparent colors for bitmaps.
6	Deselect shape	Click this button to cancel the selection of a shape.

**Note**

- ◆ The frame and background within the frame will be transparent if both frame and border are set to OFF on the Frame Tab Page.

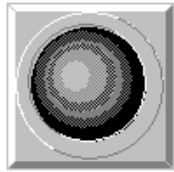

Frame and border set to ON.

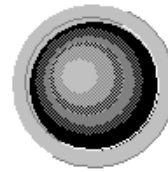

Frame and border set to OFF.

**Selecting Shape**

Select the shape to be displayed in the Select Shape Dialog Box. Click the shape type to be displayed as the functional object and click the **OK** Button to set that selection.

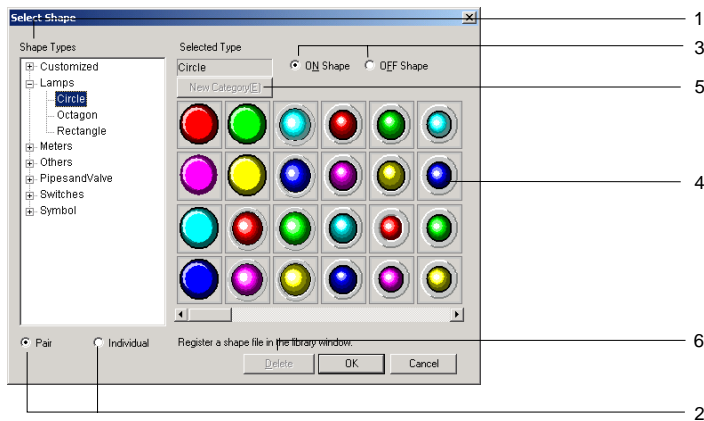

No.	Setting	Details
1	Shape Types	Select the shape type group that will be displayed on the shape selection list. If the group is selected from the directory tree, the specified group will be displayed on the shape selection list.
2	Pair/Individual	Select this option to automatically set the ON/OFF shapes in pairs. This option will be disabled (grayed out) for fixed objects for which ON/OFF pairs are not available. Select <i>Individual</i> to select the ON and OFF shapes individually.
3	ON Shape/ OFF Shape	Switch the display between ON and OFF shapes. This option will be disabled (grayed out) for shapes for which ON/OFF pairs are not available.
4	Shape selection list	Displays the shapes that can be selected. Click the shape to be selected for display.
5	New Category/ Edit Category	Click this button to add a shape type category name to the shape type directory tree or to change an existing category name. The buttons will be enabled when Customized is selected in the directory tree. When the New Category Button is clicked, a New Category Dialog Box will be displayed. Input the shape type name and click the OK Button. The new name will appear under Customized in the directory tree. Up to 7 categories can be added. When a shape type under Customized is selected, the button will change to enable changing shape type names. If the Edit Category Button is clicked, a dialog box will appear to enable changing the name. Input the new name and click the OK Button.
6	Delete	Deletes shapes from under Customized in the directory tree. Select shape to be deleted and click the Delete Button. A confirmation dialog box will be displayed. Click the OK Button to delete.

### Reference

- ◆ A shape created in the CX-Designer can be used as a selectable shape. For details, refer to *Creating Functional Objects* in the *CX-Designer Online Help*.

## Color Transparent Setting for Bitmaps

Click the **Color Transparency Setting** Button to display the following dialog box. The color transparency of bitmaps for selected object shapes can be set. Color transparency can be applied to individual bitmaps or to all bitmaps for selected object shapes.

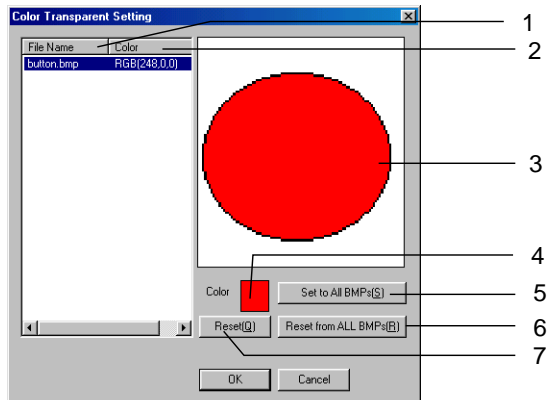

No.	Setting	Details
1	File Name	Displays all the bitmaps in the project folder. However, only files that conform to the following conditions can be displayed. The file name must contain no more than 12 characters (8 file name characters and 4 file extension characters (.bmp)). The file name can contain only alphanumeric characters, underscores (_), dollar signs (\$), and periods (.).
2	Color	Displays the specified color.
3	BMP display	Displays the selected bitmap.
4	Display color	Sets the color for the selected bitmap file.
5	Set to All BMPs	Applies the color of the selected bitmap to all bitmaps.
6	Reset from All BMPs	Cancels the color setting for all bitmaps in the project folder.
7	Reset	Resets the color setting for all selected bitmaps.

## 2-8-10 Labels

Up to 16 different labels (characters) can be set for each functional object. Multiple labels can be set for each project. This means that screen data and settings can be combined without separating projects simply by using different labels, e.g., Japanese and English. All labels can be switched (e.g., Japanese to English) with a one-touch operation by using the PT label switching function. The label text colors can be set from an address by selecting *Indirect reference of text color*. All of these label functions are set on the Label Tab Page of each Functional Object Properties Dialog Box.

NS Series Programming Manual

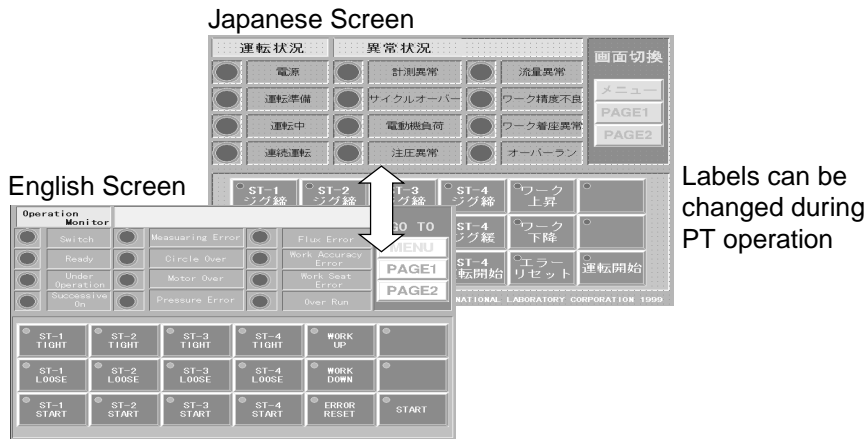

- Reference**
- ◆ The number of labels is set under **PT - Project properties**. Refer to *Project Properties* in *Section 2 NS Series Functions*.
  - ◆ Labels can be switched by setting the desired label number from the host to system memory address \$SW10.
  - ◆ For ON/OFF buttons, bit lamps, labels, and Multifunction Objects, select a character string from the character string table to be displayed as a label. Refer to *2-8-20 String Table* for details.

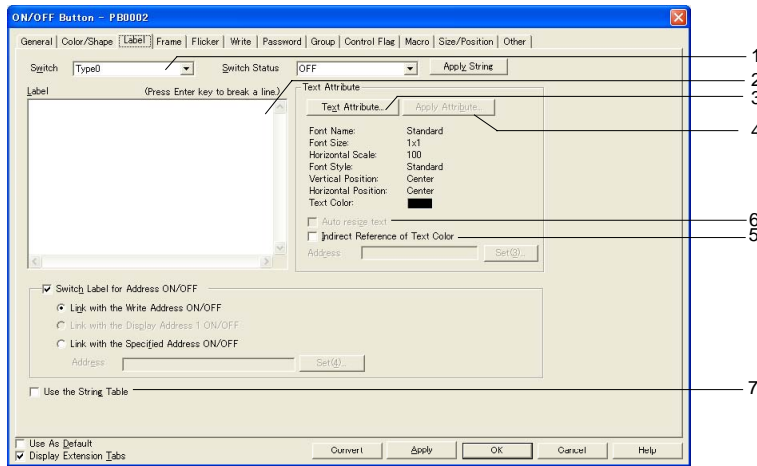

No.	Setting	Details
1	Switch	Switches labels.
2	Label	Enter the character string to be displayed as a label. (Labels and Multifunction Objects: Up to 256 characters; Other functional objects: Up to 64 characters)
3	Text Attribute Button	Displays the Text Attribute Dialog Box. Set the text attributes such as font, size, and color for the label.
4	Apply Attribute Button	Displays the Apply Text Attribute Dialog Box. This option applies the text attribute for the current label to other labels. It is disabled (grayed out) when only 1 label is registered.
5	Indirect Reference of Text Color	Select this check box to change the label text color based on the value at a specified address. Set a color code between 0 and FF at the address.
6	Fit the Object Size	Select this check box to automatically adjust fonts to the size of objects when vector fonts are selected.
7	Use the String Table	Select this checkbox to select a label string from the strings registered in the string table. (ON/OFF buttons, bitmaps, labels, and Multifunction Objects only)

### Refer to the String Table

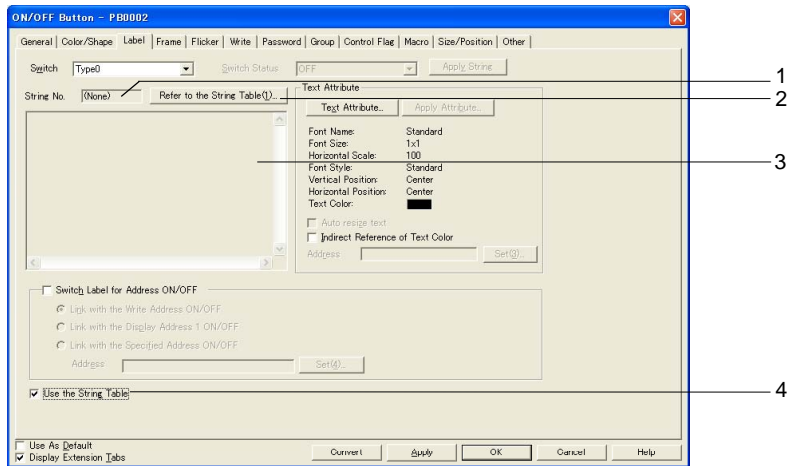

No.	Item	Details
1	String No.	Displays the string number selected from the string table.
2	Refer to the String Table	Selects the string to be displayed as a label from the string table displayed when the Refer to the String Table Button is clicked.
3	String	Displays the string selected from the string table. Up to 1,024 characters can be displayed.
4	Use the String Table	Deselect this option to directly input and set the label string.

#### Note

- ◆ Line feeds in label character strings are counted as 2 characters.
- ◆ The display color will be invalid if a value other than 0 to FF is set to the address when an indirect reference of text color is selected.
- ◆ While the functional object with a label is selected, press the Space Key to edit the label directly. Then press the Tab Key or click a functional object other than the current object to set the character string. Press the ESC Key to cancel the edit operation during input.
- ◆ Always use the Japanese version of CX-Designer running on Japanese Windows when editing Japanese-language text in labels. If the English version of CX-Designer is used, the Japanese-language text may not be displayed correctly.
- ◆ If the *Fit the Object Size* option is selected, a scale can be set for the object size. Select **Tools – Option – Label** to set the scale.
- ◆ The vector font cannot be used when referencing the string table for label strings.



**NS Series Programming Manual**

**Automatically Setting the Symbol Name or I/O Comment as the Label Text**

When the communications address is set for the following functional objects, the symbol name or I/O comment can be automatically set as the label text.

- ON/OFF Buttons (when setting the Write Address)
- Word Buttons (when setting the Write Address)
- Bit Lamps (when setting the Display Address)
- Word Lamps (when setting the Display Address)

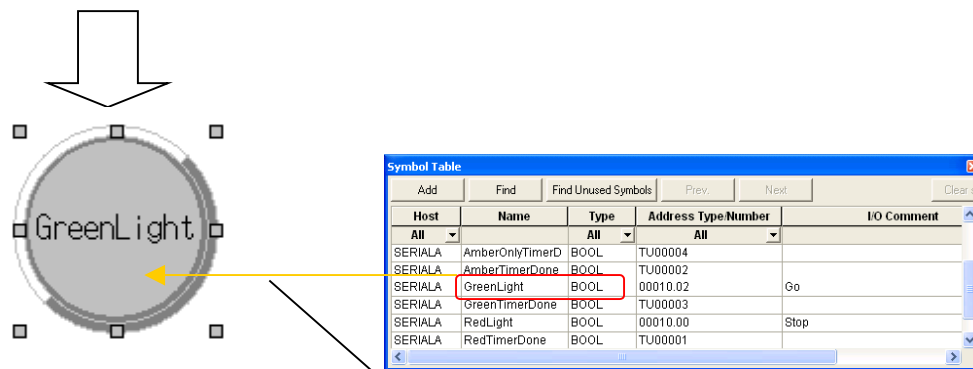
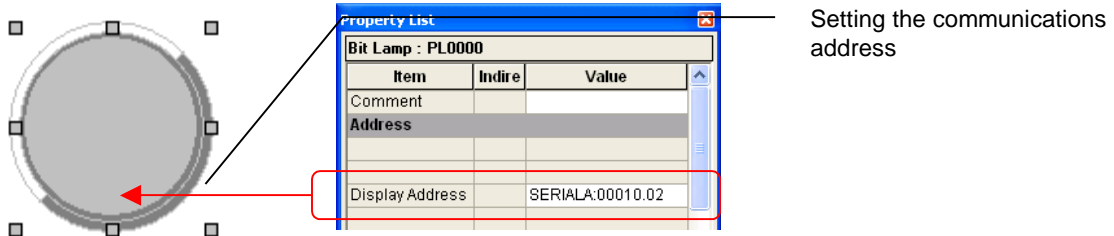

The name of the communications address that was set is automatically set in the label.

Procedure:

1. Select **Tools – Option** to display the Option Dialog Box. Open the Edit/Disp Tab.
2. Select the *Reflect to label when an address is set* Option and select either the Symbol Name or I/O comment as the label text.

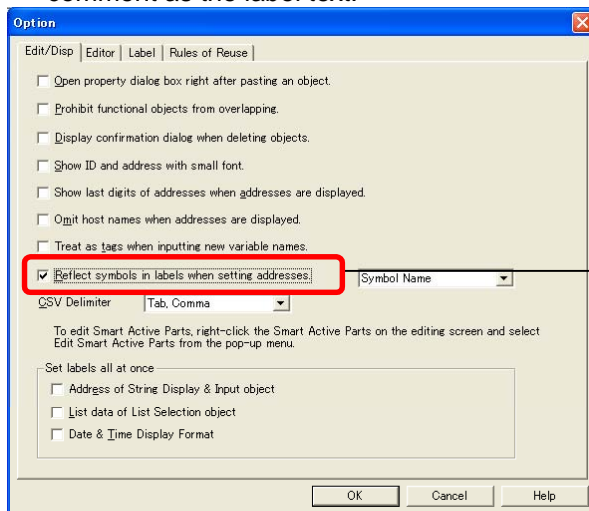

Check the box as shown, and select either *Symbol Name* or *I/O Comment* for the label character string.

3. Create the functional objects.
4. Set the communications address for each functional object from one of the following locations.

**NS Series Programming Manual**

- The *Address* Field of the functional object's Property Setting Dialog Box
- The *Address* Field of the Property List.
- Address Tool Bar
- Edit Properties Window (List Edit)
- 5. The symbol names or I/O comments that have been set will be automatically set as label character strings.

**Note**

- ◆ If there are two or more labels, the symbol names and I/O comments will be set for the character strings for all of the labels.
- ◆ Symbol names and I/O comments will not be set automatically in the following cases:
  - When the communications address is replaced by another one.
  - When a symbol name or I/O comment is changed from a symbol table after the label character string has been set.
  - When communications address settings other than those indicated above have been set.
  - When the communications address is set by a method other than those indicated in step 4.
- ◆ In the same way, when setting communications addresses in the Alarm/Event Details Dialog Box, symbol names or I/O comments can be set as alarm messages.

**2-8-11 Scroll Bars**

For functional objects that display data in a list format, display/no display, scroll width, button size, and other settings can be made for the scroll bar for the displayed object.

The scroll bar settings are made on the Scroll Bar Tab Page of the Functional Object Properties Dialog Box.

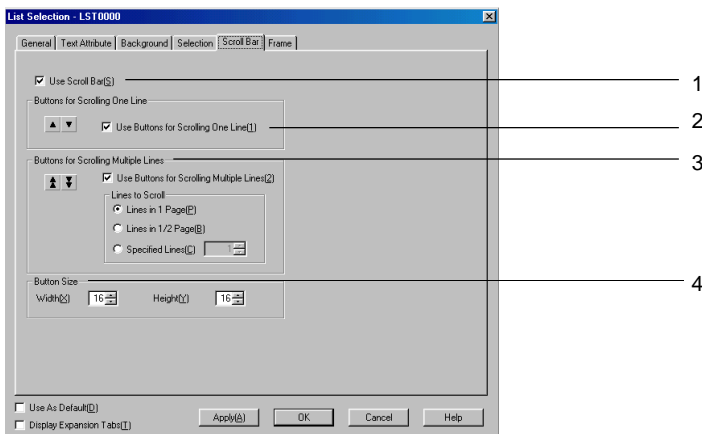

No.	Setting	Details		
1	Use scroll bar	Select <i>Use scroll bar</i> if a scroll bar is to be used.		
2	Buttons for Scrolling One Line	Select <i>Use Buttons for Scrolling One Line</i> to enable a scroll button that moves up or down one line each time it is pressed.		
3	Buttons for Scrolling Multiple Lines	Select <i>Use Buttons for Scrolling Multiple Lines</i> to enable a scroll button that moves up or down by the specified number of lines each time it is pressed. Select the number of lines to be scrolled from the option listed below.		
		Lines to Scroll	Lines in 1 Page	Scrolls up or down the displayed number of lines (i.e., one page).
		Lines in 1/2 Page	Scrolls up or down the half the number displayed number of lines (i.e., half a page).	
		Specified lines	Scrolls up or down the specified number of lines.	
4	Button size	Set the size of the scroll buttons in dot units (16 to 48).		

**NS Series Programming Manual**

**2-8-12 Frames**

The color and size of buttons, lamps, and other frames can be set. The frame settings are made on the Frame Tab Page of the Functional Object Properties Dialog Box.

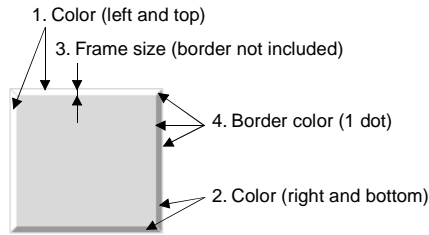

Note: The numbers in the above diagram correspond to the descriptions below.

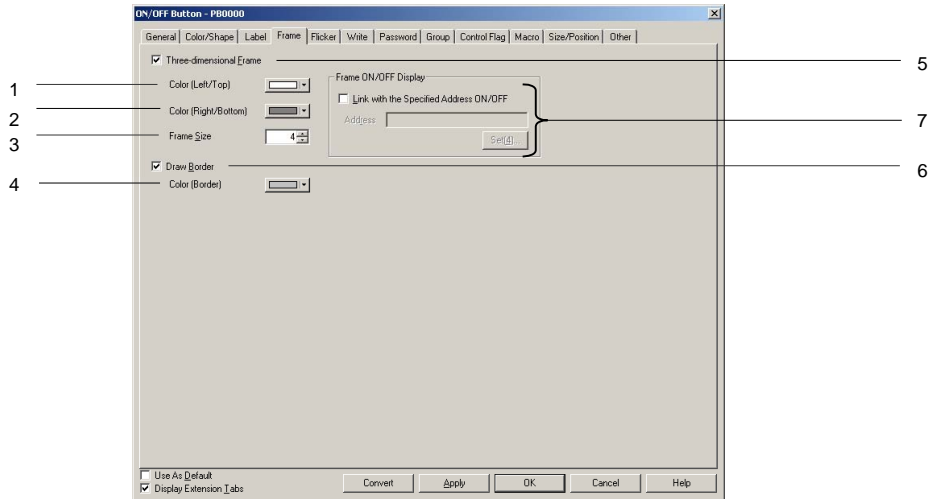

No.	Setting	Details
5	Three-dimensional Frame	Select <b>Three-dimensional Frame</b> to add a frame to the object. De-select <b>Three-dimensional Frame</b> to not have a frame for the object.
6	Draw border	Select <b>Draw border</b> to draw a border on the frame. De-select this option if no border is to be drawn.
7	Frame ON/OFF display	Select <b>Link with address ON - OFF</b> to have the frame raised or depressed, depending on whether the specified address is ON (1) or OFF(0).

**Frame ON/OFF Display**

- Link with Address ON/OFF

The button shape is updated when the specified address turns ON (1) or OFF (0).

Select the **Link with address ON/OFF** and click the **Set** Button to make the address settings.

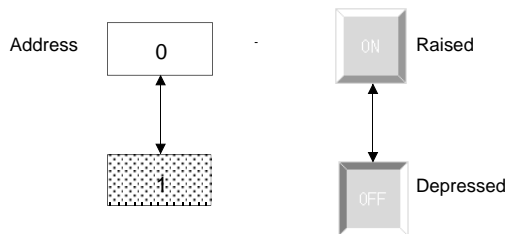

### 2-8-13 Flicker (Extension Tab)

The flicker settings make functional objects flicker at specified intervals. Select a flicker type from the 10 registered types. The flicker settings are made on the Flicker Tab Page of the Functional Object Properties Dialog Box. Flicker settings can be made for each screen.

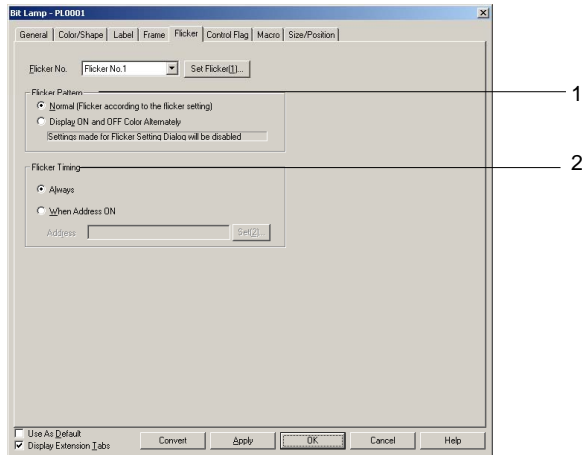

No.	Setting	Details
1	Flicker Pattern (bit lamps only)	When <i>Normal</i> is selected, flickering will be performed with the inverse of the display color. If <i>Display ON and OFF Colors Alternately</i> is selected, the ON and OFF colors of the object will be display alternately according to the flicker timing.
2	Flicker Timing	Select <i>Always</i> to make the object flicker continuously. Select <i>When address ON</i> to make the object flicker while a specified address is ON. The object will not flicker, however, if the flicker control flag is disabled.

Control flag	Flickering	Flicker/no flicker
Enabled	Always	Flickers
	When address ON.	Flickers
	When address OFF.	Does not flicker.
Disabled	Always	Does not flicker.
	When address ON.	Does not flicker.
	When address OFF.	Does not flicker.

**NS Series Programming Manual**

**Flicker Settings**

The flicker speed and area can be set separately for each flicker number.

Click the **Flicker setting** Button on the Flicker Tab Page to make these flicker settings.

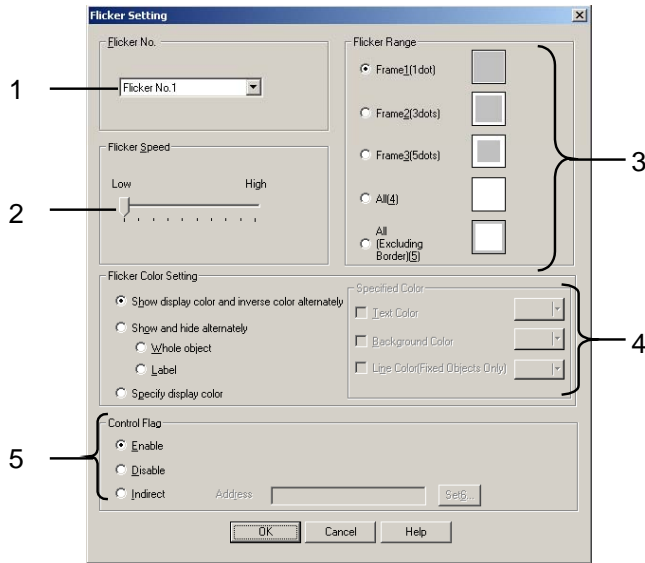

No.	Setting	Details
1	Flicker No.	Set the flicker number between 1 and 10.
2	Flicker speed	Sets the flicker speed.
3	Flicker range	Select one of the following 5 of flicker ranges.
4	Flicker color settings	Sets the flicker method and color for flicker.
	Show display color and inverse color alternately	Repeats alternate display of the display color and its inverse color.
	Show and hide alternately	Repeatedly alternates between showing and hiding display of the whole object or the label string.
	Specify display color	Repeats alternate display of the current display color and the specified color. The color for flicker can be specified as <i>Text Color</i> , <i>Background Color</i> , or <i>Line Color</i> . Select the checkbox under <i>Specified Color</i> for what color is to be changed (text, background, or line color) and specify the color.
5	Control flag	When set to <i>Enabled</i> : The object flickers. When set to <i>Disabled</i> : The object does not flicker. When set to <i>Indirect</i> : Switches between enabled and disabled when the specified address turns ON and OFF. Only bits can be set for indirect.

**Note**

- ◆ The flicker settings can also be made under **PT - Flicker setting**.
- ◆ At the slowest flicker speed, the object will flicker approximately every 2 seconds. At the fastest speed, the object will flash approximately every 200 ms. The flicker speed can be set in 200-ms units. Flicker speed settings can be made for each screen. The flicker speed will differ slightly depending on the volume of screen data.
- ◆ Flicker settings can be made for each screen.  
The flicker settings are shared for all objects on the same screen. If the flicker settings are changed for a particular functional object, the new settings will be reflected for all functional objects with the same flicker number in that screen.
- ◆ Depending on the set color, the inverse color during flickering may differ between the PT and the CX-Designer test mode.
- ◆ If the control flag is set to *Indirect*, the display color will return to the original color when the set address turns OFF. For this reason, the whole screen is refreshed.
- ◆ When the bit lamps are set to **Select Shape**, they will not flicker, even if **Display ON and OFF Colors Alternately** are selected in the flicker method settings.
- ◆ Flicker will not occur if all the checkboxes under *Specify Color* are deselected, even if *Specify display color* is selected under *Flicker Color Settings*. Always select the checkbox for the flicker target and specify the color.

The following three flicker display methods can be selected.

**Show Display Color and Inverse Color Alternately**

This option repeats alternate display of the display color and its inverse color. The flicker action occurs at the specified flicker speed and in the specified flicker range.

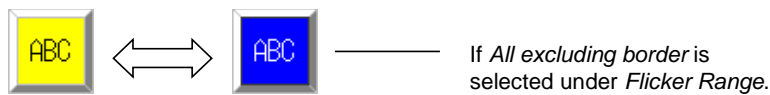

**Note**

- ◆ The flicker action is the same as for NS system versions 6.6 and lower.

**Show and Hide Alternately**

Repeatedly alternates between showing and hiding display of the whole object or the label string. The flicker action occurs at the specified flicker speed.

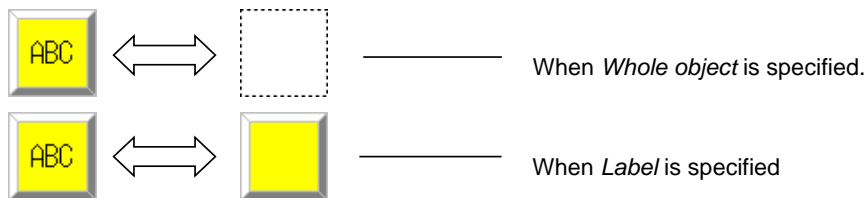

### Specify Display Color

Repeats alternate display of the current display color and the specified color. The text color, background color, or line color can be specified.

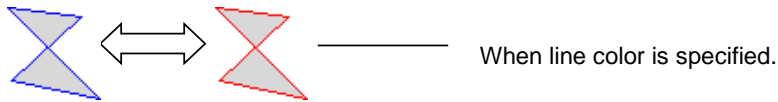
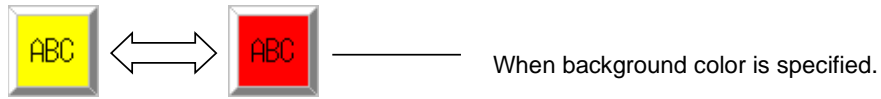
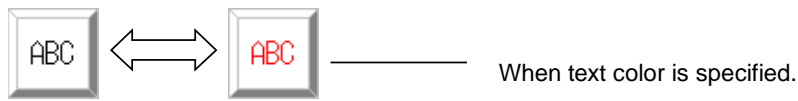

When *Background color* is specified, the background excluding the frame is displayed in the specified color.

The supported flicker methods depend on the functional or fixed object.

Functional/Fixed object	Show display color and inverse color alternately	Show and hide alternately		Specify display color		
		Whole object	Label	Text color	Background color	Line color
ON/OFF buttons	○	○	○	○	○	×
Word buttons	○	○	○	○	○	×
Command buttons	○	○	○	○	○	×
Bit lamps	○	○	○	○	○	×
Word lamps	○	○	○	○	○	×
Labels	○	○	○	○	○	×
Numeral display and input	○	○	○	○	○	×
String display and input	○	○	○	○	○	×
List Selection	○	×	×	×	×	×
Thumbwheel switch	○	×	×	×	×	×
Analog meter	○	×	×	×	×	×
Level meter	○	×	×	×	×	×
Broken-line graph	○	×	×	×	×	×
Bitmaps	○	×	×	×	×	×
Alarm/event display	○	○	△ (See note 1.)	△ (See note 1.)	○	×
Alarm/Event Summary/History	○	×	×	×	×	×
Date	○	○	○	○	○	×
Time	○	○	○	○	○	×
Data Log Graph	○	×	×	×	×	×
Video Display	–	–	–	–	–	–
Temporary Input	–	–	–	–	–	–
Continuous Line Drawings	–	–	–	–	–	–
Contents Display (for string display)	○	○	○	○	○	×
Contents Display (for image display)	○	○	×	×	×	×
Multifunction Object	○	○	○	○	○	△ (See note 3.)
Data Block Table	–	–	–	–	–	–
Rectangle	○	○	×	×	○	○
Circle/Oval	○	○	×	×	○	○
Straight Line	△ (See note 2.)	○	×	×	○	○
Continuous Straight Line	△ (See note 2.)	○	×	×	○	○
Polygon	○	○	×	×	○	○
Sector	○	○	×	×	○	○
Arc	△ (See note 2.)	○	×	×	○	○

○: Flicker, ×: No flicker, △: Action depends on settings, –: Flicker function not supported

Note 1: The object will not flicker if *Flowing text* is selected in the alarm/event display property settings.

2: The whole object will flicker, regardless of the flicker range settings.

3: The object will flicker only if the shape is set as a polygon or sector.



**Note**

- ◆ A functional object will not flicker if an unsupported flicker method is specified in the property settings for that object.

**2-8-14 Write Settings (Extension Tab)**

A confirmation message can be set to be displayed when data is written using buttons and other functional objects that are manipulated. Any confirmation message can be set. The write settings are made on the Write Tab Page of the Functional Object Properties Dialog Box. (For Multifunction Objects, make the setting on the General Tab Page.)

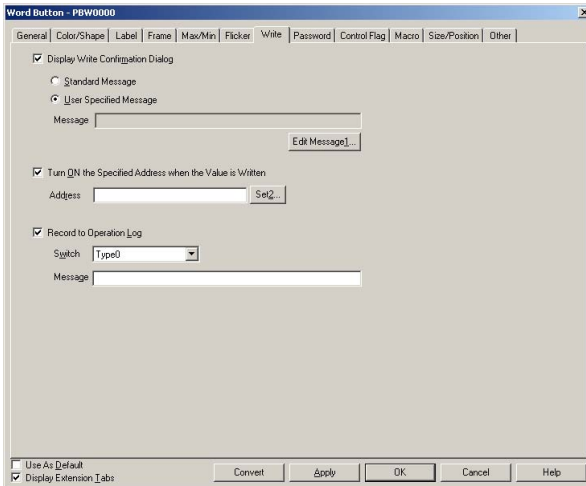
**Using Standard Messages**

Select *standard message* on the Write Tab Page. The standard message shown below will be displayed.

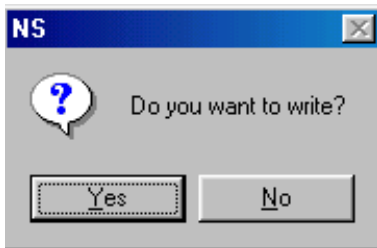
**Note**

- ◆ The message may protrude outside the screen when displayed on the PT, depending on the length of the entered message. If the message goes outside the screen, edit the message and insert a carriage return at an appropriate spot.





**NS Series Programming Manual**

**User-specified Messages**

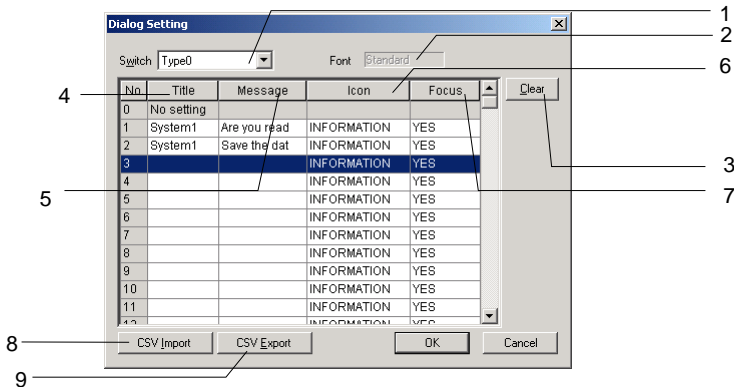
Any confirmation message can be specified. Select *User specified message* on the Write Tab Page and click the **Edit message** Button.

The Dialog Setting Dialog Box will be displayed. Select a message from the list.



No.	Setting	Details
1	Switch	Switches labels.
2	Font	Displays the font name (fixed to <i>Standard</i> ).
3	Clear	Clears the selected message.
4	Title	Changes the Message Dialog Box title. (Up to 64 characters.)
5	Message	Changes the contents of the message. (Up to 256 characters.)
6	Icon	There are 4 icons available. <div style="display: flex; justify-content: space-around; align-items: center;"> <div style="text-align: center;"> STOP</div> <div style="text-align: center;"> QUESTION MARK</div> <div style="text-align: center;"> EXCLAMATION MARK</div> <div style="text-align: center;"> INFORMATION</div> </div>
7	Focus	Changes the default focus position when the message is displayed. Select <b>Yes</b> to change the focus to <i>Yes</i> , and select <b>No</b> to change the focus to <i>No</i> .
8	CSV import	Imports a message from a CSV file.
9	CSV export	Exports a registered message to a CSV file.

**Editing Messages**

To register or edit a message, double-click the line in the message list. When the following settings are input, the following confirmation message will be displayed.

Title: System1

Message: Are you really sure to execute?

Icon: QUESTION

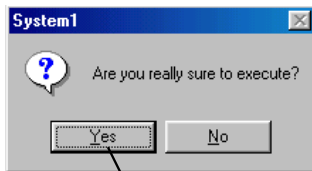

Gets focus in Test Mode.

**Note**

- ◆ Focus settings are only enabled in test mode.  
They are not displayed on the PT.
- ◆ The message may protrude outside the screen when displayed on the PT, depending on the length of the entered message. If the message goes outside the screen, edit the message and insert a carriage in an appropriate spot.
- ◆ Messages can also be set by selecting **PT – Dialog Setting**.

**Importing and Exporting CSV Files**

The CSV import and export functions are useful when there are a lot of confirmation messages and you want to edit them efficiently.

Click the **CSV Import** or **CSV Export** Button at the bottom of the Dialog Setting Dialog Box.

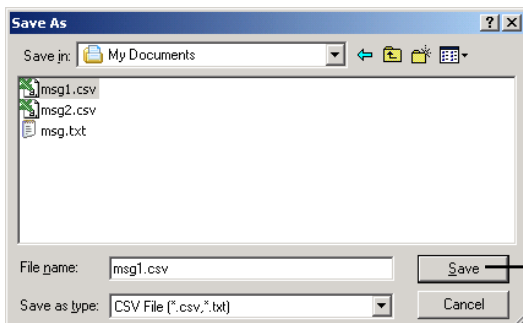

Changes to **Open** for CSV file import.

A File Specification Dialog Box will be displayed. If importing from a CSV file, select the name of the file to be imported and press the **Open** Button. If exporting to a CSV file, enter the name of the file in the *File name* input field and click the **Save** Button. The output CSV file will be displayed in the following format. Display for Microsoft Excel

	A	B	C	D	E
1	No.	Icon	Default For	Label(Type0)Title	Label(Type0)Message
2	1	question	no	System1	Are you sure to execute?
3	2	question	yes	System1	Do you want to save the data?

The icon and default focus settings are shown on the following table.

Icon	STOP: Stop (X) symbol QUESTION: Question mark	EXCLAMATION: Exclamation mark INFORMATION: Information (i) symbol
Focus	Yes: Yes	No: No

The set numerals and character strings can be all edited together because the efficient editing functions of market software can be used. Once editing has been completed, import the file again to enable the settings.

### Turn ON the Specified Addresses when the Value is Written

A specified address can be turned ON (1) whenever a button is pressed or a value is entered and written. Turn OFF the address from a PLC or other external device.

#### *Reference*

- ◆ Set the same host address for the write address on the General Tab and the address set under *Turn ON the specified address when the value is written (confirmed)*.

If a different host is set, the address set under *Turn ON the specified address when the value is written (confirmed)* may turn ON before the write address contents have been changed, depending on the communications timing.

- ◆ When exporting data, specify the CSV file's character code (multibyte code or Unicode).
- ◆ It is also possible to import CSV files that were exported from the CX-Designer.

### Record Operation Log

Select *Record Operation log* to keep a history of functional object operations during PT operation. Set the message character strings added to the operation log to 32 characters or less for each label.

Refer to *2-20-1 Operation Log Function* for information on operation log functions and settings.

### 2-8-15 Passwords (Extension Tab)

A password can be set for when entering data to functional objects during PT operation. Refer to *Common Functional Object Settings* in 2-8 *Common Functional Object Functions* for functional objects to which passwords can be set.

There are two password functions: the password function and login function.

Password function: The password must be input before an operation on a password-protected functional object.

Password function (with level function): The password must be input before an operation on a password-protected functional object. Once the password is input, all object operations allowed at that authentication level and lower levels can be performed until the authentication is cleared.

**Note**

- ◆ If a password is set for a button or other functional object, operation will not be possible until the password is input, delaying operation. Therefore, do not set passwords for functional objects that control machine operation.

#### Password Function

The password must be input before an operation on a password-protected functional object. An operation can be performed on a functional object only if the password is at the protection level set for that functional object. The password must be input each time that an operation is performed on the functional object.

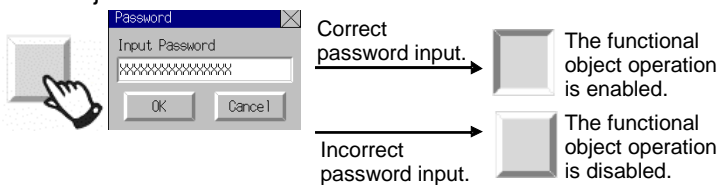

#### Password Function (with level function)

When passwords with levels have been set, a password will be required the first time a password-protected functional object is manipulated. Inputting the password set for the functional object will authenticate that password level, enabling manipulating functional objects in the same and lower levels. Functional objects with higher-level passwords cannot be manipulated. Level 1 is the lowest level and level 5 is the highest level.

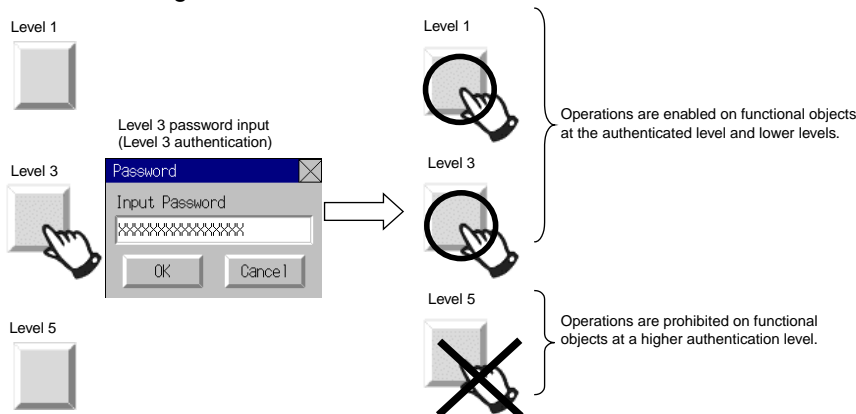

To manipulate functional objects with higher-level passwords, you must first cancel authentication. Authentication can be canceled using the following methods.

- Authentication is canceled if the PT is restarted.
- Authentication is canceled if the user presses a Command Button set to cancel authentication.
- Authentication is canceled if a specified timeout time elapses without performing an operation.

The timeout monitor is disabled in some NS-series PT operating conditions.

Status	Timeout monitor
Displaying user screen	Enabled
Displaying screen saver	Enabled
Displaying system dialog	Disabled
Displaying transfer screen	Disabled
System menu screen	Disabled

### Note

- ◆ The PT starts with authentication canceled. When the PT starts, it does not display the specified screen specified after authentication is canceled; it displays the initial screen specified on the System Setting Dialog Box's Initial Tab Page.
- ◆ The verification status will be cleared if any of the following functions are used.
  - Memory Card transfers
  - Device Monitor (NS15 only)
  - PLC data tracing
  - Ladder Monitor
  - C Programming Console
  - CS Programming Console

### Using Passwords with Levels

Passwords with level can be used to display screen suitable to the operation to prevent inappropriate operation, including operating errors. The level authentication screen can be displayed as the startup screen. Command buttons on this screen can be used, for example, to provide separate authentication levels for operators vs. managers. The screen can be switched depending on the level that is authenticated.

A level would be set for each command buttons, for example level 1 for operators and level 5 for managers. All screens displayed after authentication (e.g., device operation monitoring screens and maintenance screens) would contain a command button to cancel authentication. The password settings would specify that the authentication screen be displayed when authentication is canceled.

1. An operator or manager would press the command button set for them on the authentication screen and then enter the password in the password input dialog box to authenticate the appropriate level.
2. If the level is authenticated, either the operator's screen or the manager's screen would be displayed. These screens would be user application screen for device operation monitoring, maintenance, etc.
3. When work was completed and the PT left, the command button to cancel authentication would be pressed, switching the display back to the authentication screen. (It is possible to switch to any specified screen after authentication is canceled.)

**NS Series Programming Manual**

Password Tab Page in Password Setting Dialog Box

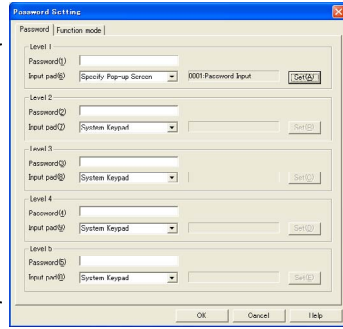

Passwords and keyboard screens are set for levels 1 and 5.

Model Selection Tab Page in Password Setting Dialog Box

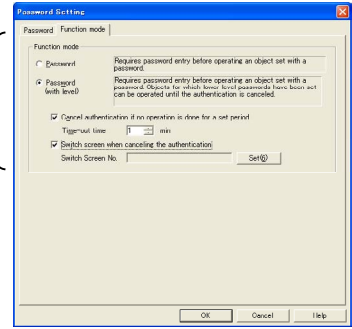

The password function with levels is enabled and the authentication screen is specified for display after authentication is canceled.

The passwords for levels 1 and 5 are set for command buttons to change the screen.

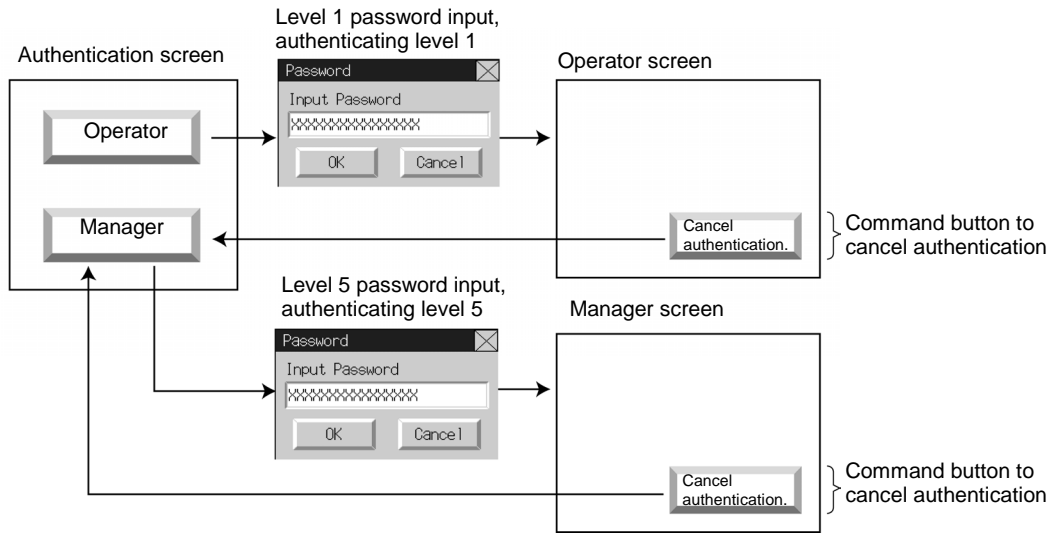

## Setting Passwords

Click the **Set password** Button on the Password Tab Page to set a password. Level 1 to level 5 passwords can be set. The set password is shared by all functional objects.

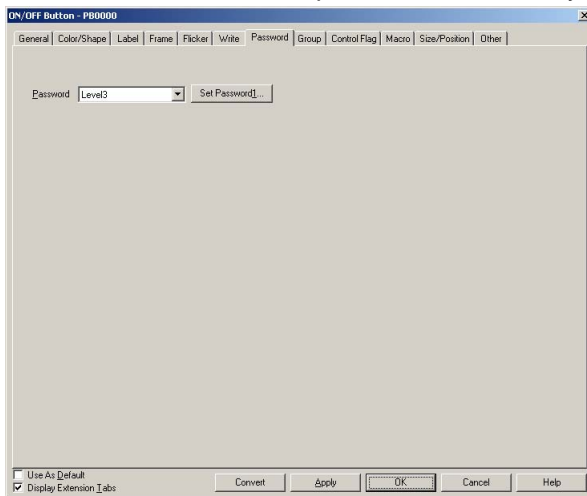

Operation of functional objects with set passwords will only be permitted if the password that matches the password character string for the specified level is entered when the operation is received by the object.

### The password input keyboard can be specified from the pop-up window.

With PT system version 8.2 or higher, a user-created pop-up window can be used as the keyboard screen for inputting the password character string. This allows the user to set the keyboard screens for inputting passwords.

For each of the five password levels, the system keypad or a user-created pop-up window can be specified for the keyboard, and the pop-up window to be used as a user-created keyboard can be set.

#### Note

- ◆ Only the following objects can be placed on the password input keyboard.
  - Command Buttons (Function selection: Key Button)
  - Temporary Inputs (Function selection: Temporary Input Field)
  - Label objects



## Password Setting Properties

This section describes the password settings for PT system version 8.2 or higher.

To set a password, click the **Set Password** Button on the Password Tab Page from the functional object properties.

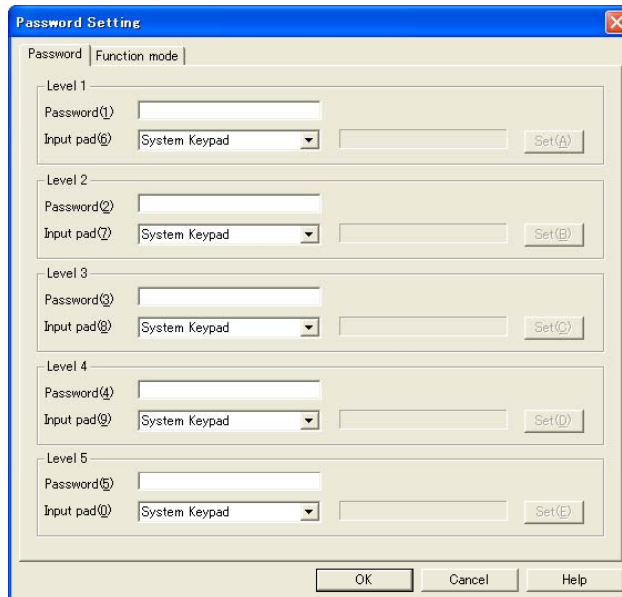

**Password:** Set the password and keypad for each level from 1 to 5.

**Function mode:** Select the *Password* or *Password (with level)* Option.

### Note

- ◆ The Password Setting Dialog Box can also be displayed with the following operations.
  - Double-click **Password** in the Project Workspace Window's Common Settings Tab Page.
  - Click the **Set Password** Button in the Password Tab Page of the functional object's Property Dialog Box.

**NS Series Programming Manual**

**Password**

Set the password and keypad for each level from 1 to 5.

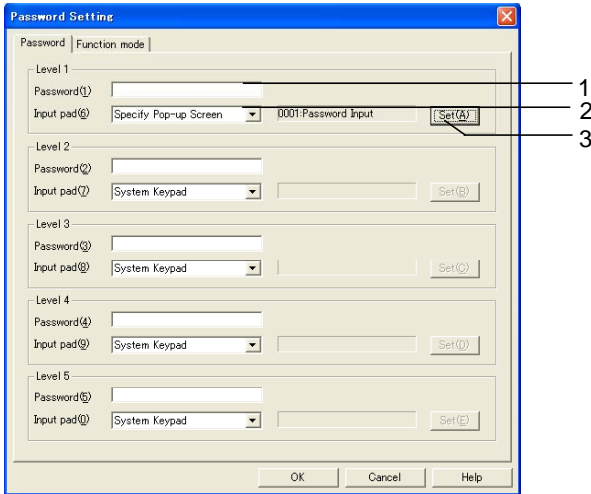

No.	Setting	Details
1	Password	Set the password for each level (up to 16 alphanumeric characters).
2	Keypad (See note.)	Select the standard system keypad or select specifying a pop-up window.
3	Specified screen No. (See note.)	When specifying a pop-up window is selected, set the pop-up window to be opened for password input.

Note: A pop-up window can be specified for the keypad only for PT system version 8.2 or higher.

**Note**

- ◆ Passwords must be 16 characters maximum and can include only one-byte alphanumeric characters.
- ◆ Passwords can also be set under **PT - Password**.

If a functional object with a password set is pressed during PT operation, a Password Dialog Box will be displayed. Press the input area to display the keyboard screen that has been set for that level. Use this keyboard to enter the password.

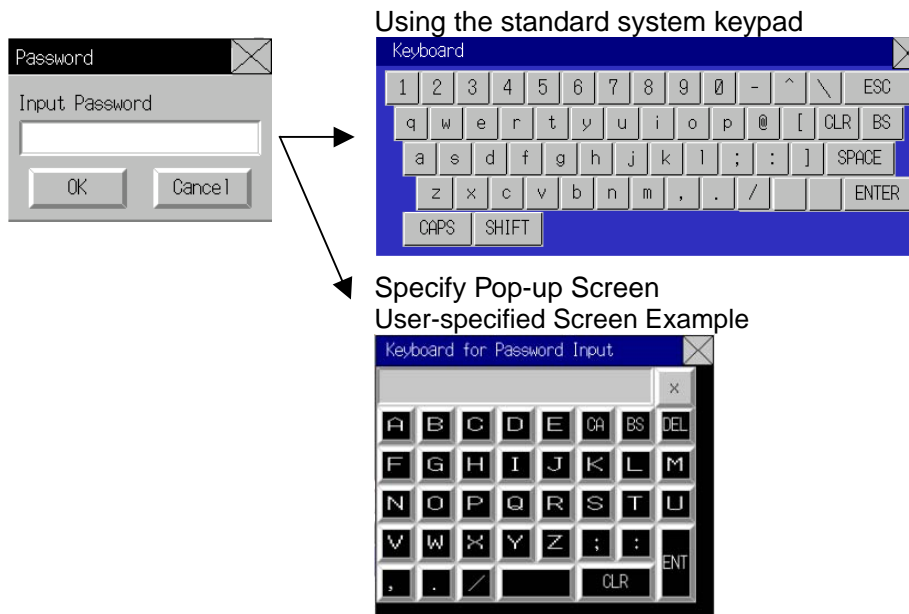

**Note**

- ◆ A different dialog box will be displayed in test mode.

**Function Mode**

Select the *Password* or *Password (with level)* Option.

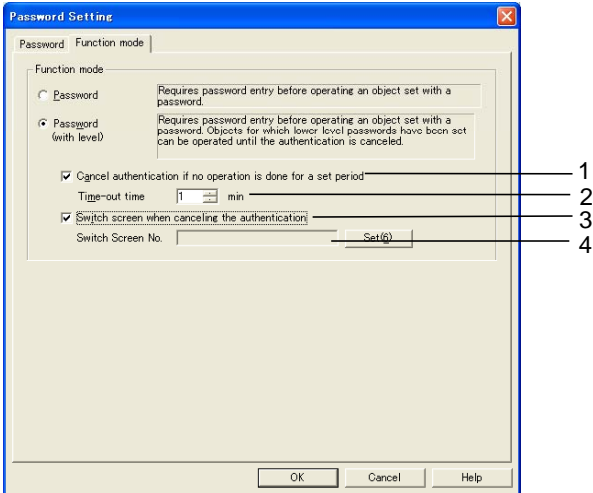

No.	Setting	Details
1	Cancel authentication if no operation is done for a set period	If this check box is selected, authentication will be automatically cancelled if no screen operation is performed within the specified timeout time after level authentication.
2	Time-out Time	Sets the time until authentication is cancelled. Can be set from 1 to 60 (minutes).
3	Switch screen when canceling authentication	If this check box is selected, the screen will be switched to the screen specified when authentication is cancelled for a timeout or by a Command Button.
4	Screen Switch No.	Set the screen to switch to when authentication is cancelled.

**Note**

- ◆ If a pop-up window is used as the password keyboard, the keyboard screen will be closed when the input is entered or cancelled, just as it is with the system keypad.  
A button operation is required to close the pop-up window. Register a macro for a functional object and set it so to close the pop-up window.

**Macro Setting Example: Closing a Pop-up Window**

Under the properties of the functional object, select *Touch OFF* on the Macro Tab Page and then click the **Macro Edit** Button.

A pop-up window can be closed by setting CLOSEPOPW(-1) in the *Program* Field.

For details, refer to the *NS series Macro Reference*.

### 2-8-16 Control Flags (Extension Tab)

Control flags control the input and display of functional objects. Control flags can be used for an interlock function and are used to enable display or enable input depending on the ON (1) or OFF(0) status of the address. The control flag settings are made on the Control Flag Tab Page of the Functional Object Properties Dialog Box.

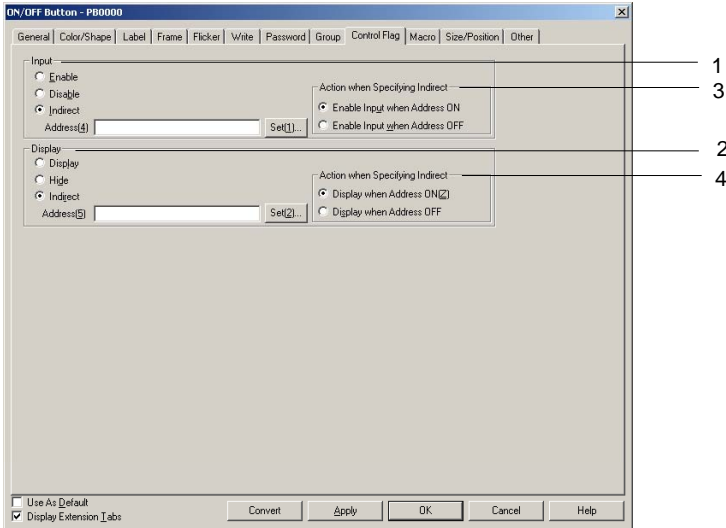

No.	Setting	Details
1	Input	Sets whether or not input will be enabled for buttons and other functional objects. Switches between input enable and disable when the specified address turns ON and OFF, if <i>Indirect</i> is specified. Only bits can be set for indirect.
2	Display	Sets whether or not the functional object will be displayed. Switches between display and no display when the specified address turns ON and OFF, if <i>Indirect</i> is specified. Only bits can be set for indirect.
3	Action When Specifying Indirect	Sets the input timing for indirect address specifications. Enable Input When Address ON: Input will be enabled when the specified address is ON and disabled when it is OFF. Enable Input When Address OFF: Input will be enabled when the specified address is OFF and disabled when it is ON.
4	Action When Specifying Indirect	Sets the display timing for indirect address specifications. Display When Address ON: Display will be enabled when the specified address is ON and disabled when it is OFF. Display When Address OFF: Display will be enabled when the specified address is OFF and disabled when it is ON.

**Note**

- ◆ If numeral display and input objects and string display and input objects are set to not display, input will be disabled regardless of the input enable/disable setting. Input will be enabled for other functional objects that accept inputs if the settings enable input but do not display the object. For example, if the ON/OFF button is set to input enable and no display, a transparent button can be created.

### 2-8-17 Macro (Extension Tab)

The macro function allows users to create and execute simple programs. Arithmetic operations, discrimination between conditions, and other functions that are not supported by functional objects can be added by the user. This section describes how to set macro execution using the Functional Object Properties Dialog Box. For details, refer to *NS-series Macro Reference*.

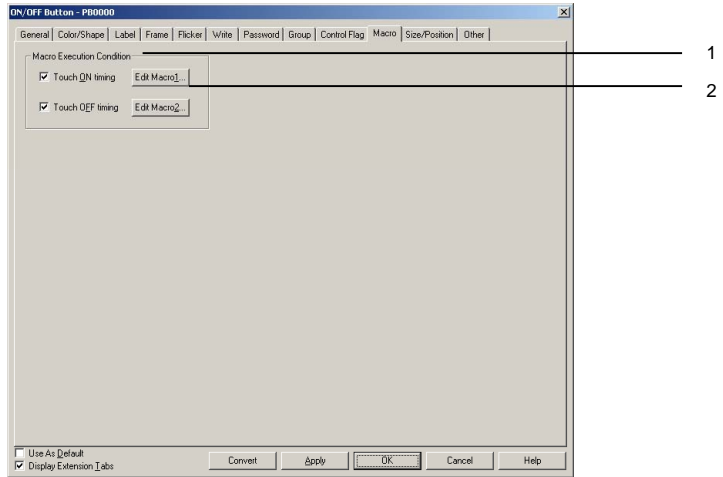

No.	Setting	Details
1	Macro execution condition	For functional objects with macro function, specifies whether or not the functional object will be executed for each condition.
2	Edit Macro	Click the <b>Edit Macro</b> Button to create new macro or edit macro.

### 2-8-18 Size/Position (Extension Tab)

Display and set the size of the functional object and the position from the upper left of the screen (frame/table).

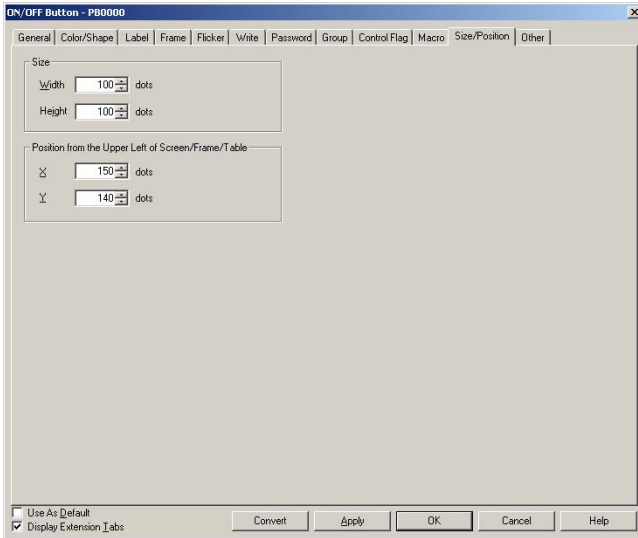

#### Size

Set the height and width of the functional object in dot units. The height can be set between 1 and 1,920 and the width between 1 and 2,560.

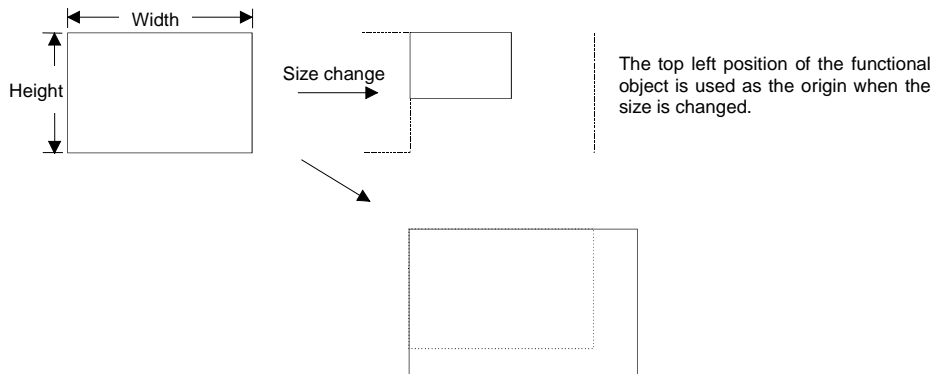

#### Note

- ◆ The object may protrude outside the screen or frame, depending on the set size. The section outside the screen or frame will not be displayed.

## Position

Specify the horizontal position (X coordinate) and vertical position (Y coordinate) of the functional object from the top left of the screen or frame. The horizontal position can be set between 0 and 2,559 and the vertical position between 0 and 1,919. Set the horizontal and vertical positions in dot units.

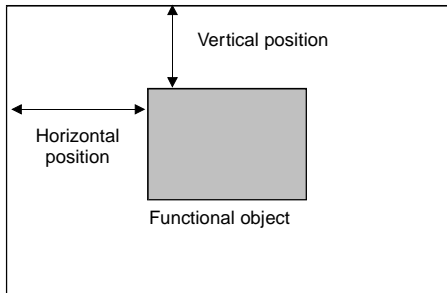

Screen or frame

## Reference

- ◆ Set the position so that the object is not outside the screen or frame area.  
An error check can be performed to check for functional objects outside the screen or frame area. Refer to *Validation* in the *CX-Designer Online Help* for details on error checks.
- ◆ The Video Display must be positioned so that it is entirely on the screen. It cannot extend outside of the screen. Refer to *2-13-5 Video Display* for details.

### 2-8-19 Change Input Order

The input order that was set on the Keypad Tab Page of the Property Dialog Box for numeral input and display objects or string input and display objects can be changed here. Select **Change Input Order** from the PT Menu.

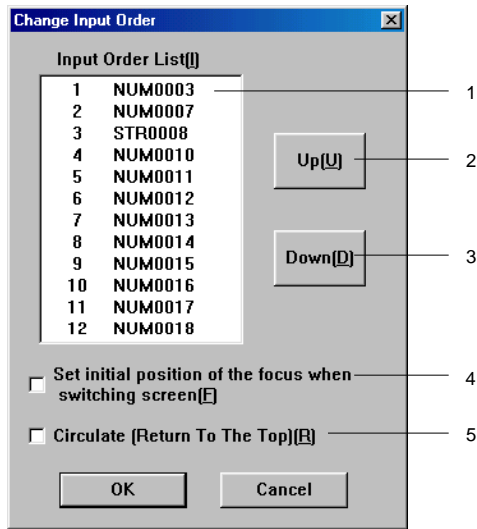

No.	Setting	Details
1	Input Order List	Displays the current input order and object ID. (The corners of objects selected in the list will flash on the project editing screen. They will not flash, however if they are located on a on pages where the frames cannot be seen.)
2	Up	Moves the input order of the selected object up one in the input order list.
3	Down	Moves the input order of the selected object down one in the input order list.
4	Set initial position of the focus when switching screen	Enables or disables the input order on the destination screen when switching screens.
5	Circulate	Select this check box to move the focus to the first object in the list after an input has been made for the last object in the list. This function will not work for objects that can be input when they are on sheets.



### 2-8-20 String Table

The string table function manages character strings used in projects.

Strings registered in the string table can be used by ON/OFF buttons, bit lamps, Multifunction Objects, labels, and alarm/event functions.

Any changes to strings registered in the string table are automatically reflected in the functional objects.

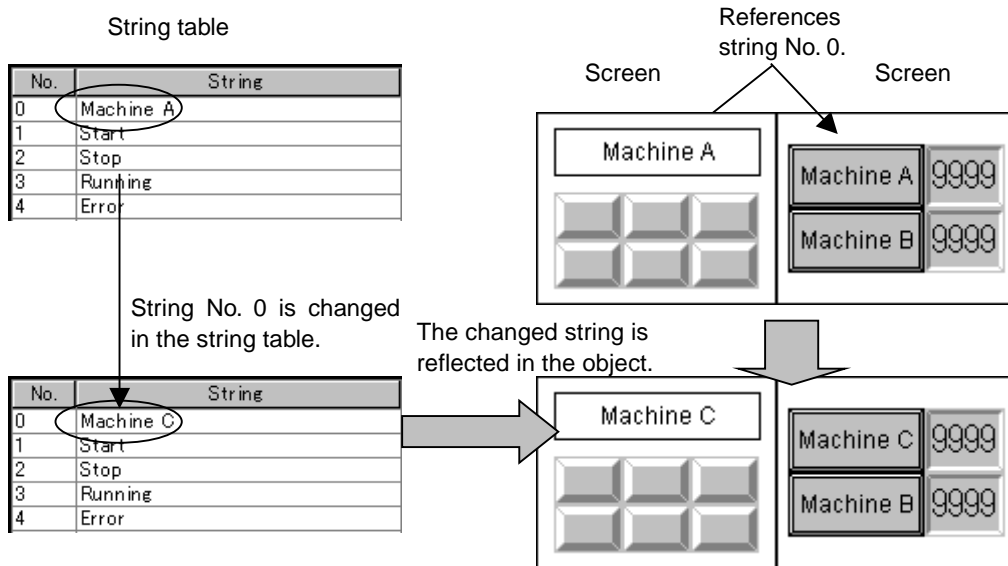

Up to a maximum of 10,000 strings can be registered in a string table and each string can be up to a maximum of 1,024 characters. The maximum setting file size that can be registered for one project, however, is 5 MB. Do not set any value larger than this. The setting file name is `txttable.cfg`. You can check the size of the current setting file by selecting **Tools – Resource Report** from the CX-Designer menus.

Registered strings can be changed as a group by importing/exporting CSV files. The string table can be exported as a CSV file, edited or translated, and then imported. All of the data in the edited CSV file can then be registered together in the string table.

**Note**

- ◆ The size of the settings file depends on the number of registered characters and labels. Use the following table as a guide.

File size	No. of labels	Number of registered statuses	No. of characters in each string
5.0 MB	1	10,000	256
4.9 MB	1	2,500	1,024
4.8 MB	2	10,000	120
4.7 MB	2	1,200	1,024
4.9 MB	16	10,000	10
4.7 MB	16	150	1,024

**NS Series Programming Manual**

**Registering Strings**

To register a string in a string table, select **PT – String Table** in the CX-Designer or click the Refer to the **String Table** Button in the functional object Property Dialog Box.

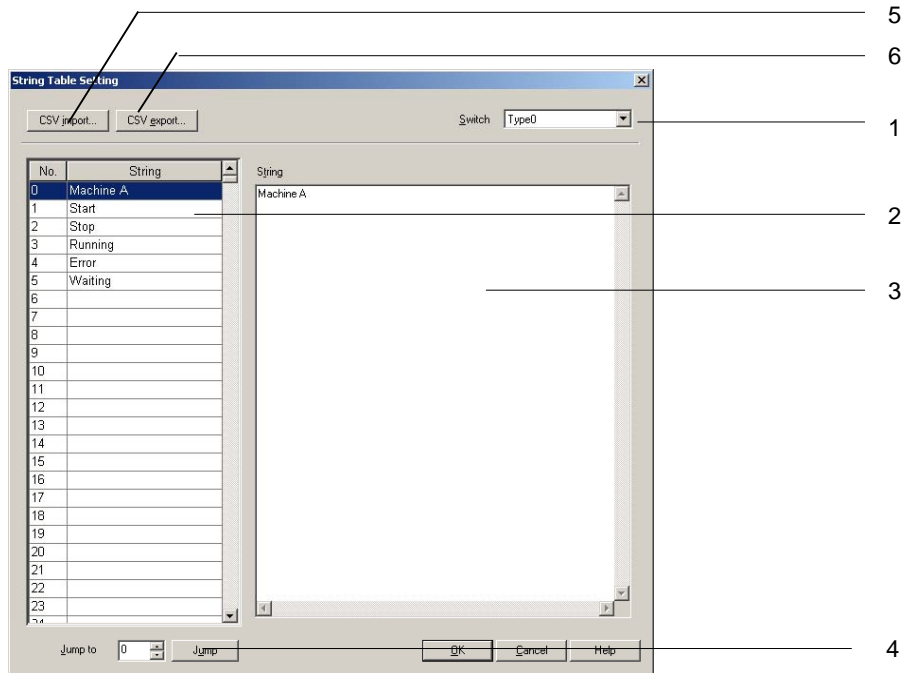

No.	Item	Details
1	Switch	Switches labels.
2	String list	Displays a list of the strings registered in the string table.
3	String input field	The string selected from the string list is displayed and can be edited. Up to 1,024 characters can be registered in a string. (Single- and double-byte characters are counted as one character. Carriage returns are counted as two characters.)
4	Jump	Specify a string number and click the <b>Jump</b> Button to jump to the specified string.
5	CSV import	Strings can be imported from CSV files.
6	CSV export	The contents of the string table can be exported to CSV files.

**Note**

- ◆ Strings can be copied, pasted, and otherwise manipulated in the string list by using the following procedures.
  - Copy: Press the **Ctrl + C** Keys or right-click the mouse and select **Copy** from pop-up menu.
  - Paste: Press the **Ctrl + V** Keys or right-click the mouse and select **Paste** from pop-up menu.
  - Clear: Press the **Del** Key or right-click the mouse and select **Clear** from pop-up menu.
  - Move input focus to the string input field: Press the **Esc**, **F12**, or **Tab** Keys.
  - Move cursor to *Switch* and press the **Shift + Tab** Keys.
- ◆ Registered strings can be exported as a group to a CSV file and edited. Refer to *Importing/Exporting CSV Files* later in this section for details.

**NS Series Programming Manual**

**Importing/Exporting CSV Files**

The CSV import/export function is useful for translating or editing as a group strings registered in the string table.

Click either the **CSV import** or **CSV export** Button in the String Table Setting Window to execute import or export.

No	Type0	Type1
0	Running	実行中
1	Stop	停止
2	Waiting	待機中
3	Error	異常発生中
...	...	...
9999	Input the data again.	入力し直してください。

No.	Item	Details
1	String No.	Sets the string number (0 to 9999).
2	Label	Sets the string for each label (up to 1,024 characters).
3	Title	The title for each item is displayed in the first row of the CSV file. Do not change the title row.

**Note**

- ◆ An error will be displayed and the import canceled when importing CSV files if the CSV file format is different (e.g., if the title line has changed or the number of labels has changed.)
- ◆ For any CSV files with strings of more than 1,024 characters, the first 1,024 characters will be imported but the remaining characters will be ignored.
- ◆ Lines in CSV files with string numbers outside the range will be ignored. Only lines with string numbers inside the range will be imported.

## 2-9 Buttons

### 2-9-1 ON/OFF Buttons

An ON/OFF Button is a functional object that turns the status of a specified address ON or OFF using a touch switch input.

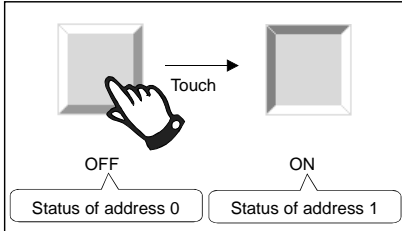

Select **Functional Objects - ON/OFF Button** or the  icon in CX-Designer to create an ON/OFF Button.

#### Note

- ◆ When the display is switched to a screen with many objects, press the position where the ON/OFF Button is located to enable input even if the object display on the screen has not been completed yet. The processing does not start until the screen display has been completed, so a short time may lapse before processing is executed.
- ◆ ON/OFF buttons can be changed to Multifunction Objects.  
If changed to a Multifunction Object, the button can be changed to a lamp or multiple functions can be executed at once when the button is pressed.  
Refer to 2-11 *Multifunction Objects* for information on converting to a Multifunction Object.

### Settings for Functional Object Properties

This section describes the settings in the Functional Object Properties Dialog Box for ON/OFF Buttons.

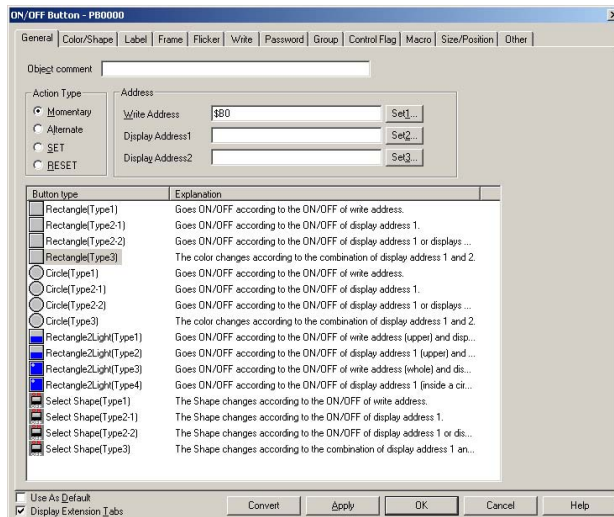

- |              |                                                            |
|--------------|------------------------------------------------------------|
| General:     | Sets the address, action type, and other basic operations. |
| Color/shape: | Sets the button display color and shape.                   |
| Label:       | Sets the label display.                                    |
| Frame:       | Sets the button frame display.                             |
| Flicker:     | Sets the flicker display. (See note.)                      |

**NS Series Programming Manual**

- Write: Sets the contents of the write confirmation message when the ON/OFF Button is pressed. (See note.)
- Password: Sets the password to be entered when the ON/OFF Button is pressed. (See note.)
- Group: Sets group numbers to exclusive buttons. (See note.)
- Control Flag: Sets enable/disable input and display/no display for objects. (See note.)
- Macro: Sets macros to be executed. (See note.)
- Size/Position: Sets the object size and position. (See note.)
- Other: Sets the input sound for individual touch switches to OFF. (See note.)

Note: These tabs are displayed when *Display Extension Tabs* Option is selected.

**General Tab Page**

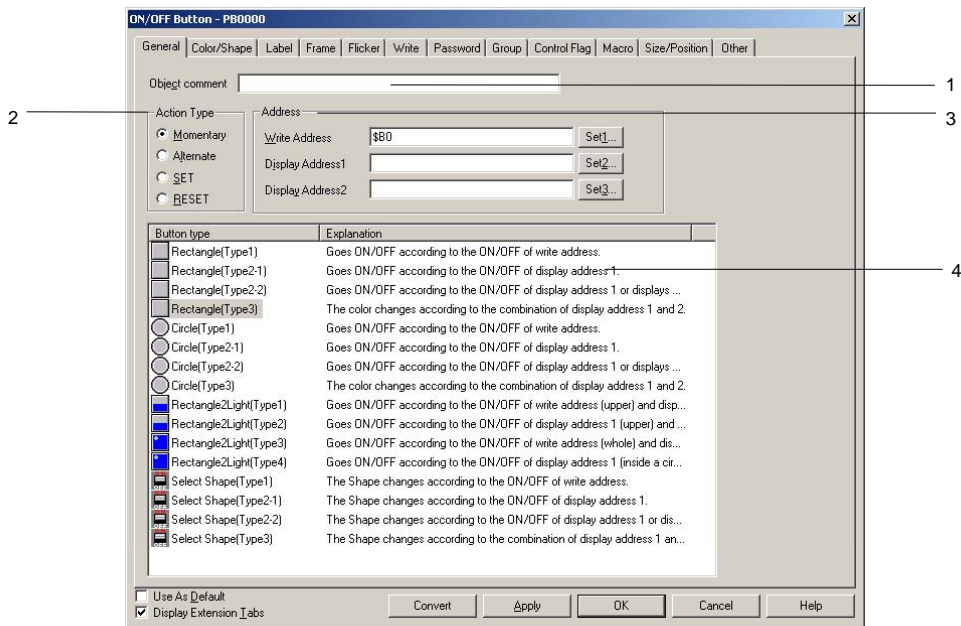

Sets the button action type and address.

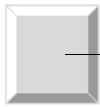
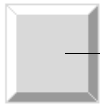
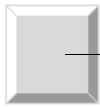
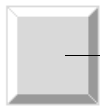
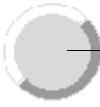
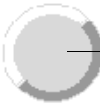
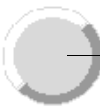
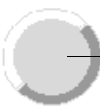

NS Series Programming Manual

No.	Setting	Details
1	Object comment	Sets an explanatory comment for the pasted object. (Up to 32 characters.)
2	Action type	Select an operation for when the button is pressed from the following 4 options.
	Momentary	Writes 1 to the write address when the button is pressed and writes 0 to when the button is released.
	Alternate	Alternates between writing 0 and 1 to the write address when the button is pressed.
	SET	Writes 1 to the write address when the button is pressed.
	RESET	Writes 0 to the write address when the button is pressed.
3	Address	Sets the write and read addresses for button operations.
4	Button type	Select the button shape and action type from the following 13 options. All buttons write 1 or 0 to the write address when they are pressed. Depending on the button type, some buttons change their status, e.g., their color, when the contents of the specified address change.
	Rectangle (Type 1)	The button color changes based on whether the write address is ON or OFF.  — Accesses the write address.
	Rectangle (Type 2-1)	The button color changes based on whether the display address is ON or OFF.  — Accesses the display address.
	Rectangle (Type 2-2)	The button color changes based on whether display address 1 is ON or OFF. The button color also changes when the button is pressed.  — Accesses display address 1.
	Rectangle (Type 3)	Changes the button color based on the status of display address 1 and display address 2 (i.e., 1/1, 1/0, 0/1, or 0/0).  — Accesses display address 1 and display address 2.
	Circle (Type 1)	A circle button with the same action as Rectangle (Type 1).  — Accesses the write address.
	Circle (Type 2-1)	A circle button with the same action as Rectangle (Type 2-1).  — Accesses display address 1.
	Circle (Type 2-2)	A circle button with the same action as Rectangle (Type 2-2).  — Accesses display address 1.
	Circle (Type 3)	A circle button with the same action as Rectangle (Type 3).  — Accesses display address 1 and display address 2.

**NS Series Programming Manual**

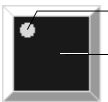
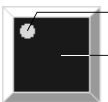
No.	Setting	Details
4	Rectangle 2 Light (Type 1)	The top color changes based on whether the write address is ON or OFF and the bottom color changes based on whether display address 1 is ON or OFF. 
	Rectangle 2 Light (Type 2)	The top color changes based on whether display address 1 is ON or OFF and the bottom color changes based on whether display address 2 is ON or OFF. 
	Rectangle 2 Light (Type 3)	The whole button color changes based on whether the write address is ON or OFF and the color of a circle inside the button changes based on whether display address 1 is ON or OFF. 
	Rectangle 2 Light (Type 4)	The color of the circle inside the button changes based on whether display address 1 is ON or OFF and the whole button color changes based on whether display address 2 is ON or OFF. 
	Select Shape (Type 1)	The button shape changes based on whether the write address is ON or OFF. Various button shapes can be set by selecting from the list.
	Select Shape (Type 2-1)	The button shape changes based on whether display address 1 is ON or OFF. Various button shapes can be set by selecting from the list.
	Select Shape (Type 2-2)	The button shape changes based on whether display address 1 is ON or OFF. The button shape also changes when the button is pressed. Various button shapes can be set by selecting from the list.
	Select Shape (Type 3)	Changes the button shape based on the status of display address 1 and display address 2 (i.e., 1/1, 1/0, 0/1, or 0/0). Various button shapes can be set by selecting from the list.

**Note**

- ◆ If frames are switched frequently, the display update may take some time and communications may be delayed. Care must be taken because this means that sometimes the momentary ON/OFF buttons may not operate normally.

**Color/Shape Tab Page**

The Color/Shape Tab Page is used to select the ON/OFF Button display status.

If *Select shape* is selected under *Button type*, select a display shape from the list. For all other cases, select one of the 256 colors. Depending on the button type, only colors 1 and 2 may be used, or all colors 1 to 4 may be used.

Similarly for shape specification, only shapes 1 and 2 may be used or all shapes 1 to 4 may be used, depending on the button type.

**NS Series Programming Manual**

**Color**

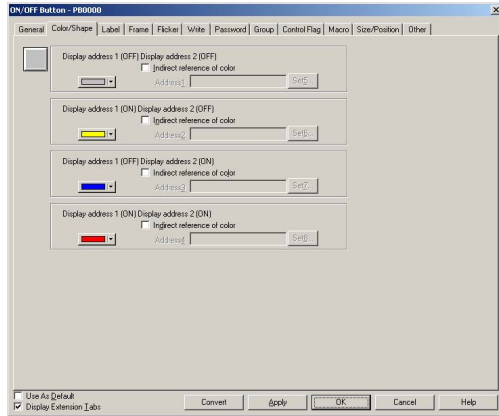

**Colors 1 to 4**

The display methods for colors 1 to 4 depends on the ON/OFF Button type.

Button type	Display	
Rectangle (Type 1)	Whole button color	Write address on 0: OFF color Write address on 1: ON color
Rectangle (Type 2-1)	Whole button color	Display address 1 on 0: OFF color Display address 1 on 1: ON color
Rectangle (Type 2-2)	Whole button color	Display address 1 on 0: OFF color Display address 1 on 1: ON color When button is pressed: ON color
Rectangle (Type 3)	Whole button color	Display address 1/display address 2 on 0/0: 1 (OFF)      2 (OFF) Display address 1/display address 2 on 1/0: 1(ON)      2 (OFF) Display address 1/display address 2 on 0/1: 1(OFF)      2 (ON) Display address 1/display address 2 on 1/1: 1(ON)      2 (ON)
Circle (Type 1)	Same as for Rectangle (Type 1).	
Circle (Type 2-1)	Same as for Rectangle (Type 2-1).	
Circle (Type 2-2)	Same as for Rectangle (Type 2-2).	
Circle (Type 3)	Same as for Rectangle (Type 3).	
Rectangle 2 Light (Type 1)	Top color	Write address on 0: OFF color Write address on 1: ON color
	Bottom color	Display address 1 on 0: OFF color Display address 1 on 1: ON color
Rectangle 2 Light (Type 2)	Top color	Display address 1 on 0: OFF color Display address 1 on 1: ON color
	Bottom color	Display address 2 on 0: OFF color Display address 2 on 1: ON color
Rectangle 2 Light (Type 3)	Inside circle color	Display address 1 on 0: OFF color Display address 1 on 1: ON color
	Whole button color	Write address on 0: OFF color Write address on 1: ON color
Rectangle 2 Light (Type 4)	Inside circle color	Display address 1 on 0: OFF color Display address 1 on 1: ON color
	Whole button color	Display address 2 on 0: OFF color Display address 2 on 1: ON color
Select shape (Type 1)	Cannot be set here. The setting screen will be displayed for specifying the shape.	
Select shape (Type 2-1)	Cannot be set here. The setting screen will be displayed for specifying the shape.	
Select shape (Type 2-2)	Cannot be set here. The setting screen will be displayed for specifying the shape.	
Select shape (Type 3)	Cannot be set here. The setting screen will be displayed for specifying the shape.	

Refer to *Setting Colors* in *2-8 Common Functional Object Functions* for information on how to set colors.



**NS Series Programming Manual**

**Reference**

- ◆ To change the button color based on the contents of an address, select *Indirect Reference* and allocate an address. Set a hexadecimal color code to the address. If a value other than 0 to FF is set the display color will be invalid.

**Select Shape**

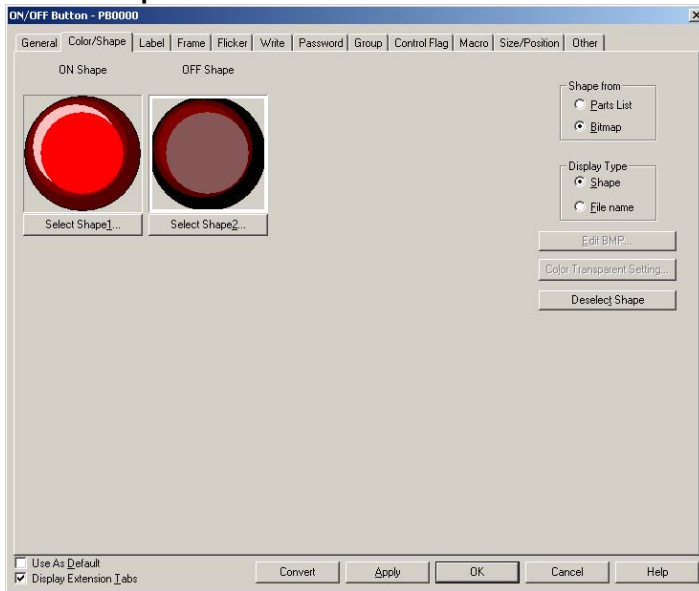

**Shapes 1 to 4**

If shapes with ON/OFF pairs are specified, the shape for OFF (shapes 2 or 4) will be automatically selected when the shape for ON (shape 1 or 3) is selected.

Button type	Display
Button types except select shape	Cannot be set here. The setting screen will be displayed for setting colors.
Select shape (Type 1)	Write address on 1: ON shape Write address on 0: OFF shape
Select shape (Type 2-1)	Display address on 1: ON shape Display address on 0: OFF shape
Select shape (Type 2-2)	Display address on 1: ON shape Display address on 0: OFF shape When button is pressed: ON shape
Select shape (Type 3)	Display address 1/display address 2: 1/0 Shape 1 Display address 1/display address 2: 0/0 Shape 2 Display address 1/display address 2: 1/1 Shape 3 Display address 1/display address 2: 0/1 Shape 4

Refer to *Selecting Fixed Objects in 2-8 Common Functional Object Functions* for information on how to set fixed objects.

**Label Tab Page**

Use the Label Tab Page to set labels to the ON/OFF Button. Refer to *Labels in 2-8 Common Functional Object Functions* for basic settings information. This section describes how to make settings for ON/OFF Buttons only.

Labels can be switched when the ON/OFF Button turns ON and OFF.

**NS Series Programming Manual**

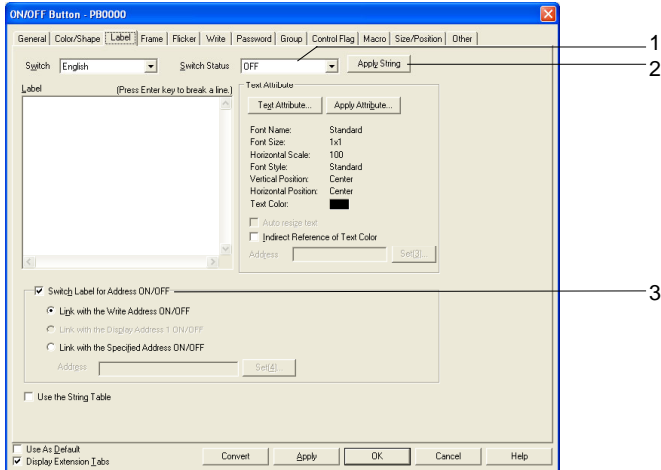

No.	Setting	Details
1	Switch Status	Select <i>ON</i> or <i>OFF</i> from the displayed list and edit the label for when the specified address is ON/OFF. The ON/OFF label is switched each time the button is clicked.
2	Apply String	Uses the current character string for all object states. The string is used as the label not only for the selected object, but for all other object states as well. If the Switch Status cannot be set, then the Apply String Button can also not be set.
3	Switch Labels for Address ON/OFF	Switches the label when the specified address turns ON or OFF. <i>ON/OFF</i> is also enabled when <i>Switch labels for Address ON/OFF</i> is selected.
	Link with Write Address ON/OFF	Switches label display when the Write Address, which is specified on the General Tab Page, turns ON or OFF.
	Link with Display Address1 ON/OFF	Switches label display when Display Address1, which is specified on the General Tab Page, turns ON or OFF.
	Link with the Specified Address ON/OFF	Switches label display when the specified address turns ON or OFF.

**Frame**

Specify the color and size of the button frame to change the shape or color when the button is depressed or raised. Refer to *Frames* under *2-8 Common Functional Object Functions* for details.

**Note**

- The buttons are not linked to write address ON/OFF or the raised/depressed status of the frame when the button action type is *Momentary*, *SET*, or *RESET*. The frame is concave when the button is pressed. To make the frame concave when the write address is ON, set the same address as the write address to *Link with the specified address ON/OFF*.

**Flicker (Extension Tab)**

Make flicker settings to make the functional object flicker (flash). Refer to *Flicker* under *2-8 Common Functional Object Functions* for details.

**Write (Extension Tab)**

Use the write to display a confirmation dialog box before writing values to a write address. The confirmation message can be changed. Refer to *Write Settings* under *2-8 Common Functional Object Functions* for details.

## Password (Extension Tab)

Set a password for when buttons are pressed. Five passwords of up to 16 characters each can be set. One password can be requested for each object. Refer to *Passwords* under *2-8 Common Functional Object Functions* for details.

## Group (Extension Tab)

Group is used to create buttons that are to be exclusively controlled (i.e., only one button can be selected out of multiple buttons). If the same group number is set to multiple buttons, this function ensures that only one button can be turned ON. Group numbers are specified on the Group Tab Page of the ON/OFF Button Properties Dialog Box. Groups 1 to 16 can be selected for one screen.

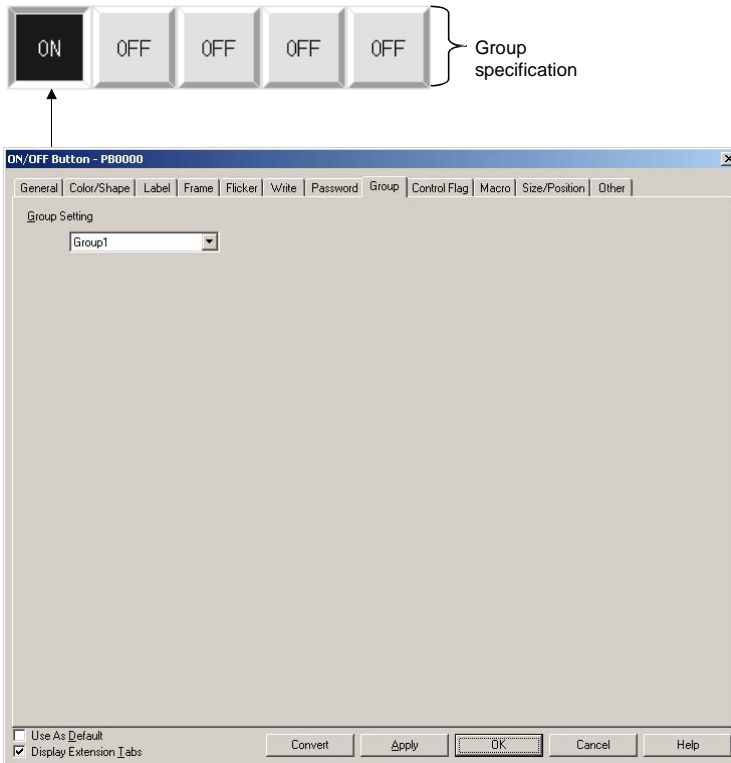

### Note

- ◆ Group settings are enabled only when *Momentary*, *Alternate*, or *SET* button action is selected in the properties settings. If the action type is set to *RESET*, the buttons will not operate according to group settings.
- ◆ If the button is set to *Alternate* action and is pressed when ON, the button will turn OFF.
- ◆ This function is different from the group function executed by selecting **Edit - Group – Group** from the menu bar or right-clicking and selecting **Group** from the pop-up menu.
- ◆ Set the same host address to buttons with the same group number. The buttons will not operate normally if different host addresses are allocated.
- ◆ If the same group number is set to several Multifunction Objects, they will also be subject to exclusive operation.

## Control Flags (Extension Tab)

Control flags control the input and display of functional objects. Use control flags to enable display or input when the contents of an address turn ON or OFF. Refer to *Control Flags* under *2-8 Common Functional Object Functions* for details.

### Macros (Extension Tab)

Macros can be specified for ON/OFF Buttons.

Macros executed by the following triggers can be registered.

Trigger	Details
Touch ON	Executes macro when the button is pressed.
Touch OFF	Executes macro when the button is released.

Refer to the CX-Designer's *NS-series Macro Reference* for information on setting macros.

### Size/Position (Extension Tab)

Displays and sets the functional object size and position. Refer to *Size/Position* under *2-8 Common Functional Object Functions* for details.

### Other (Extension Tab)

The touch switch input sound for ON/OFF buttons can be individually turned OFF. The touch switch input sound will be turned OFF for all objects (regardless of the individual settings) if the touch switch input sound (Key Press Sound) has been set to OFF in the PT's System Menu or in the System Setting PT Tab Page in the CX-Designer.

## 2-9-2 Word Buttons

Word Buttons either write values to a specified address or increase or decrease the value of the contents or a specified address when the button is pressed. Items on a pop-up menu can also be selected and the values specified to those items written to the address.

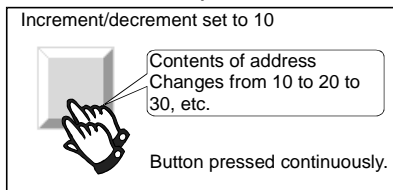

Select **Functional Objects - Word Button** or the  icon in CX-Designer to create a Word Button.

#### Note

- ◆ When the display is switched to a screen with many objects, press the position where the Word Button is located to enable input even if the object display on the screen has not been completed yet. The processing does not start until the screen display has been completed, so a short time may lapse before processing is executed.

- ◆ Word buttons can be changed to Multifunction Objects.

If changed to a Multifunction Object, the button can be changed to a lamp or multiple functions can be executed at once when the button is pressed.

Refer to *2-11 Multifunction Objects* for information on converting to a Multifunction Object.

### Settings for Functional Object Properties

This section describes the settings items in the Functional Object Properties Dialog Box for Word Buttons.

**NS Series Programming Manual**

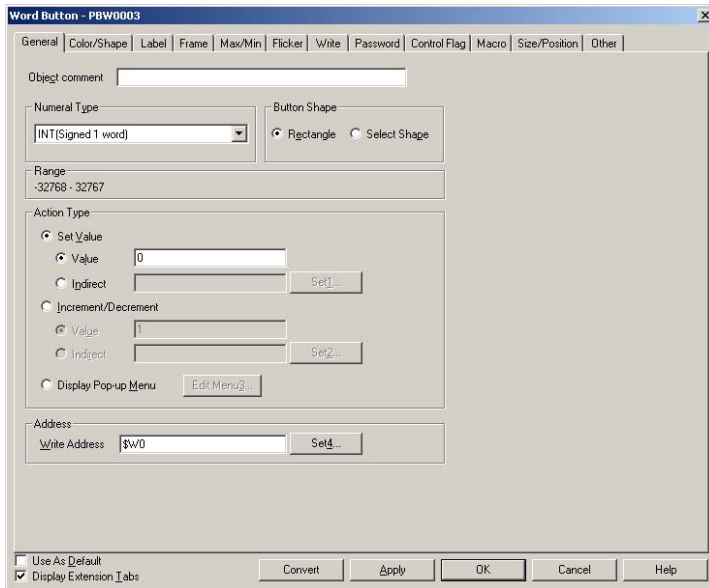

- General: Sets the address, action type, and other general operations.
- Color/shape: Sets the button display color and shape.
- Label: Sets the label display.
- Frame: Sets the button frame display.
- Max/Min: Sets the maximum and minimum limits for address contents when Word Button is pressed.
- Flicker: Sets the flicker display. (See note.)
- Write: Sets the contents of the write confirmation message when the Word Button is pressed. (See note.)
- Password: Sets the password to be entered when the Word Button is pressed. (See note.)
- Control flag: Sets enable/disable input and display/no display for objects. (See note.)
- Macro: Sets macros to be executed. (See note.)
- Size and Position: Sets the object size and position. (See note.)
- Other: Sets the input sound for individual touch switches to OFF. (See note.)

Note: These tabs are displayed when *Display Extension Tabs* Option is selected.

**General Tab Page**

Sets the button action type and address.

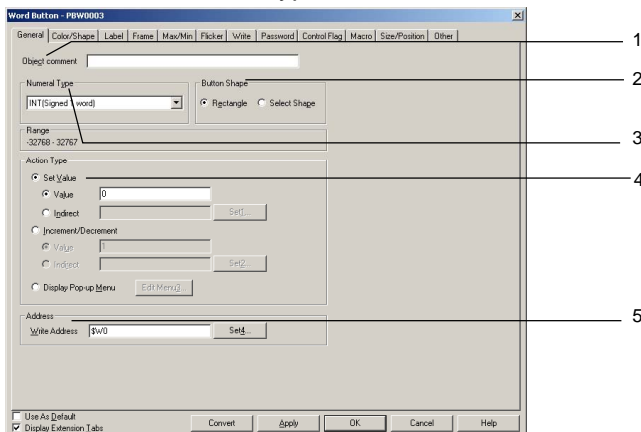

No.	Setting	Details
1	Object comment	Sets an explanatory comment for the pasted object. (Up to 32 characters.)

No.	Setting	Details
2	Button shape	Specifies the displayed button shape. Select <i>Rectangle</i> to display buttons of various colors. If <i>Select shape</i> is selected, the shape can be selected from the Shape Types Selection Dialog Box on the Color/shape Tab Page.
3	Numeral Type	Select the write format for the numeral when the button is clicked from the following eleven types. INT (signed, 1 word) UINT (unsigned, 1 word) DINT (signed, 2 words) UDINT (unsigned, 2 words) REAL (real number) BCD2 (unsigned, 1 word) BCD2 (unsigned, 2 words) BCD1 (signed (leftmost digit: F), 1 word) BCD1 (signed (leftmost digit: F), 2 words) BCD2 (signed (leftmost bit: 1), 1 word) BCD2 (signed (leftmost bit:1), 2 words) Refer to <i>Numeral Display and Storage Type</i> in 2-8 Common Functional Object Functions for details on numeral storage types.

NS Series Programming Manual

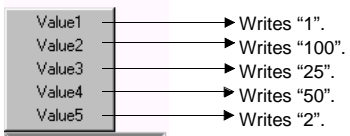
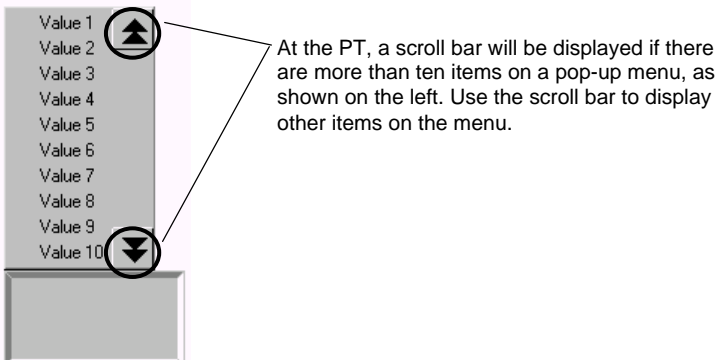
No.	Setting	Details
4	<p>Action type</p> <p>Set Value</p> <p>Increment/decrement</p> <p>Display Pop-up menu</p>	<p>Select one of the following three types of action.</p> <p>Sets a set value to the write address when the button is pressed. The numeric value can only be input as a decimal. Hexadecimal values cannot be input. To input hexadecimal values to the PLC, first convert the hexadecimal number to decimal and then input the converted value. Example: To write FFFF, set “-1” in decimal (for signed values). When indirect is selected, the contents of the set address are written.</p> <p>When the button is pressed, the contents of the address are incremented or decremented and set. Example: If <i>Increment/decrement</i> is set to “10”, the contents of the address will increase by 10 each time the button is pressed. If <i>Increment/ decrement</i> is set to “-10”, the contents of the address will decrease by 10 each time the button is pressed. When indirect is selected, the contents of the set address becomes the increment/decrement value. When the maximum or minimum limit is exceeded, the action will be changed based on the settings on the MAX/MIN Tab Page. Refer to <i>MAX/MIN Tab Page</i> for details.</p> <p>When the button is pressed, a pop-up menu will be displayed and the write value can be selected from the menu. Set the character strings (up to 64 characters) that will be displayed on the pop-up menu and the values that will be written when the items on the pop-up menu are selected. As many pop-up menus as there are label switches can be set. If labels are switched during PT operation, the displayed pop-up menu will also change. Up to 32 items can be set on pop-up menus. Example</p>  <p>Click the <b>Edit</b> Button to edit the pop-up menu.</p>  <p>At the PT, a scroll bar will be displayed if there are more than ten items on a pop-up menu, as shown on the left. Use the scroll bar to display other items on the menu.</p>
5	Address	Sets the write address for button operations. Only words can be specified.

### Editing Pop-up Menus

Click the **Edit Menu3** Button on the General Tab Page to display the Pop-up Setting Dialog Box.

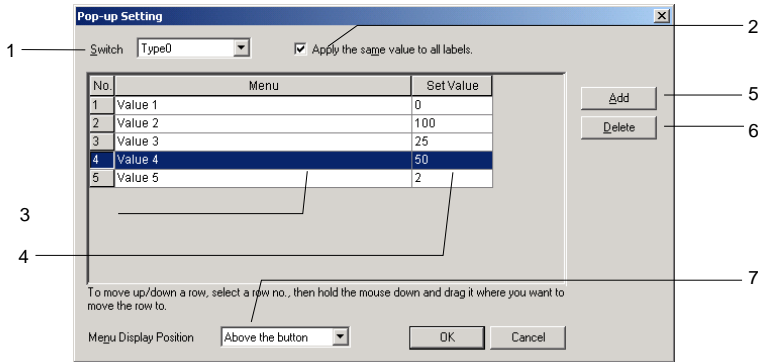

No.	Setting	Details
1	Switch	Switches labels.
2	Apply the same value to all labels.	This option applies the same Set Value to all labels.
3	Menu list	Sets the heading name displayed in the pop-up menu. The name can be up to 64 characters long.
4	Set Value	Specifies the value that will be written to the communications address when the corresponding menu item is selected.
5	Add	Adds a menu item below of the currently selected row. If there is no row selected, a new row is added to the bottom of the list.
6	Delete	Deletes the currently selected menu item.
7	Menu display position	Sets one of the following display positions for the pop-up menu. <ul style="list-style-type: none"> <li>• Above the button</li> <li>• Below the button</li> </ul>

**Note**

- ◆ When a row has been selected by clicking the row number, the row can be dragged and dropped in another location to change its order in the list.

### Color/Shape Tab Page

Specify the color and shape of the button.

If *Rectangle* is selected as the button shape, one of 256 colors can be selected. If *Select shape* is selected under *Button type*, select a display shape from the list.



**NS Series Programming Manual**

**Color**

The following Dialog Box is displayed when *Increment/Decrement* or *Display Pop-up Menu* is selected as the Action Type.

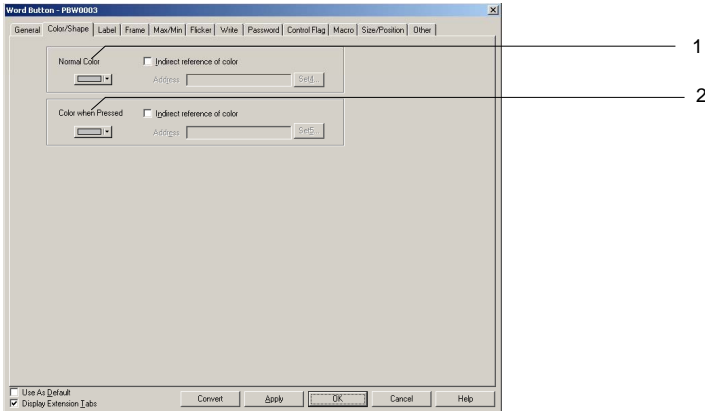

The following Dialog Box is displayed when *Set Value* is selected as the Action Type.

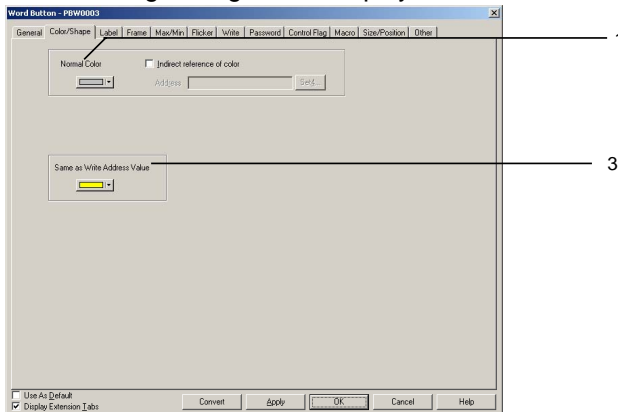

No.	Setting	Details
1	Normal Color	Sets the normal display color for the Set Button.
2	Color when Pressed	Sets the color when the button is pressed. Set the pressed color when <i>Increment/decrement</i> or <i>Pop-up menu display</i> is selected as the button action type.
3	Same as Write Address Value	Sets the color that will be displayed when the contents of the write address match the set value for <i>Set Value</i> button action types. When the values do not match, the button color will be that set as the normal color. Multiple word buttons can be used as exclusive buttons by specifying the same word address and changing each of the values set to <i>Set Value</i> .

Refer to *Setting Colors* in *2-8 Common Functional Object Functions* for information on how to set colors.

**Select Shape**

The following Dialog Box is displayed when *Increment/Decrement* or *Display Pop-up Menu* is selected as the Action Type.

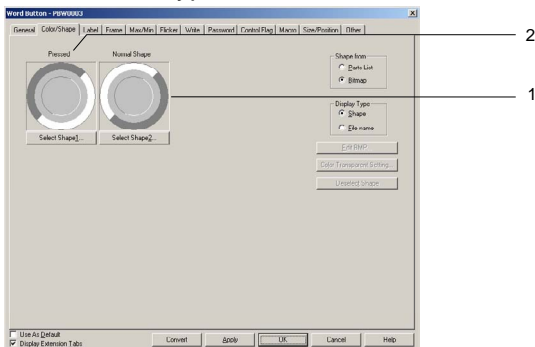

**NS Series Programming Manual**

The following Dialog Box is displayed when *Set Value* is selected as the Action Type.

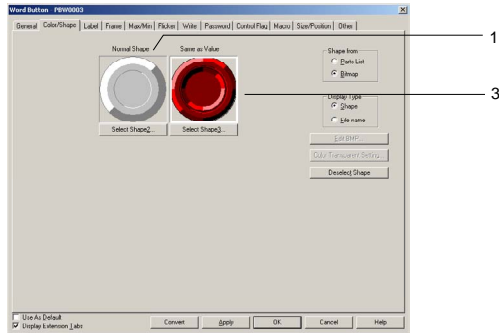

No.	Setting	Details
1	Normal shape	Click the <b>Select Shape</b> Button to set the button's normal shape.
2	Pressed	Click the <b>Select Shape</b> Button to set the button's shape when it is pressed.
3	Same as value	Sets the button shape that will be displayed when the contents of the write address match the set value for <i>Set Value</i> button action types. When the values do not match, the button shape will be that set as the normal shape.

Refer to *Selecting Shape* in *2-8 Common Functional Object Functions* for information on how to set fixed objects.

**Label Tab Page**

Set a label for each button. Refer to *Labels* in *2-8 Common Functional Object Functions* for basic settings information.

**Frame Tab Page**

Specify the colors and sizes of the button frame to change the shape or color when the button is depressed or raised. Refer to *Frames* under *2-8 Common Functional Object Functions* for details.

**Maximum/Minimum Limits Tab Page**

Set the maximum and minimum limits for the contents of the write address. The setting range for maximum and minimum limits depends on the numeral types.

If the action type is *Increment/decrement*, the value can be returned to the maximum or minimum limit if the limits are exceeded.

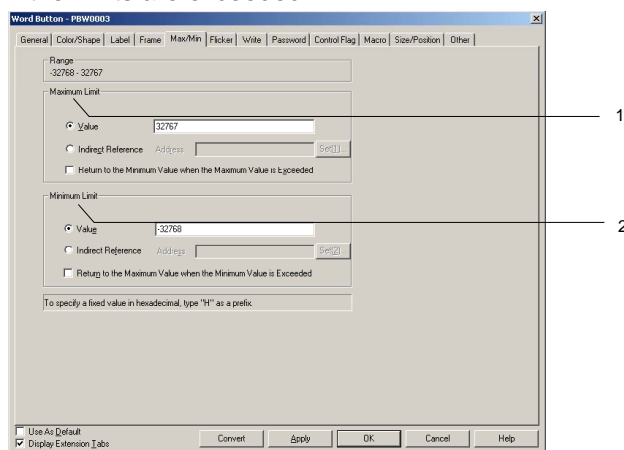

No.	Setting	Details
1	Maximum limit	<p>Sets the maximum limit. Select either value or indirect reference.</p> <p>If the action type is <i>Increment/decrement</i> and <i>Return to the Minimum Value when the Maximum Value is exceeded</i> is selected, the value will be returned to the minimum limit and set if the maximum limit is exceeded.</p> <p>Example If the Word Button is pressed at a current value of 998 at the following settings: Maximum limit of 1,000, minimum limit of 0, increment/decrement set to 5, and <i>Return to the Minimum Value when the Maximum Value is exceeded</i> not selected: Stays at 998.</p> <p>If <i>Return to the Minimum Value when the Maximum Value is exceeded</i> is selected: Writes "0".</p>
2	Minimum limit	<p>Sets the minimum limit. Select either value or indirect reference.</p> <p>If the action type is <i>Increment/decrement</i> and <i>Return to the Maximum Value when the Minimum Value is exceeded</i> is selected, the value will be returned to the maximum limit and set if the minimum limit is exceeded.</p> <p>Example: If the Word Button is pressed at a current value of 3 at the following settings: Maximum limit of 1,000, minimum limit of 0, increment/decrement set to -5, and <i>Return to the Maximum Value when the Minimum Value is exceeded</i> is not selected: Stays at 3.</p> <p>If <i>Return to the Maximum Value when the Minimum Value is exceeded</i> is selected: Writes "1000".</p>

The setting ranges for maximum and minimum limits depend on the *Numeral types* set on the General Tab Page. If a value is set under *Value* that exceeds the range set under *Numeral types* and the OK Button is pressed, a message stating that the setting range has been exceeded will be displayed and the setting will not be made.

### Flicker Tab Page

Make flicker settings to make the functional object flicker (flash). Refer to *Flicker* under 2-8 Common Functional Object Functions for details.

### Write Tab Page

Use the write to display a confirmation dialog box before writing values to a write address. The confirmation message can be changed. Refer to *Write Settings* under 2-8 Common Functional Object Functions for details.

### Password Tab Page

Set a password for when buttons are pressed. Five passwords of up to 16 characters each can be set. One password can be requested for each object. Refer to *Passwords* under 2-8 Common Functional Object Functions for details.

### Control Flag Tab Page

Control flags control the input and display of functional objects. Use control flags to enable display or input when the contents of an address turn ON or OFF. Refer to *Control Flags* under 2-8 Common Functional Object Functions for details.

### Macro Tab Page

Macros can be specified for Word Buttons.

Macros executed by the following triggers can be registered.

Trigger	Details
Touch ON	Executes macro when the button is pressed.
Touch OFF	Executes macro when the button is released.

Refer to the CX-Designer's *NS-series Macro Reference* for information on setting macros.

### Size/position Tab Page

Displays and sets the functional object size and position. Refer to *Size/Position* under 2-8 Common Functional Object Functions for details.

### Other (Extension Tab)

The touch switch input sound for ON/OFF buttons can be individually turned OFF. The touch switch input sound will be turned OFF for all objects (regardless of the individual settings) if the touch switch input sound (Key Press Sound) has been set to OFF in the PT's System Menu or in the System Setting Window's PT Tab Page in the CX-Designer.

## 2-9-3 Command Buttons

A Command Button is a functional object that switches screens and transmits character codes.

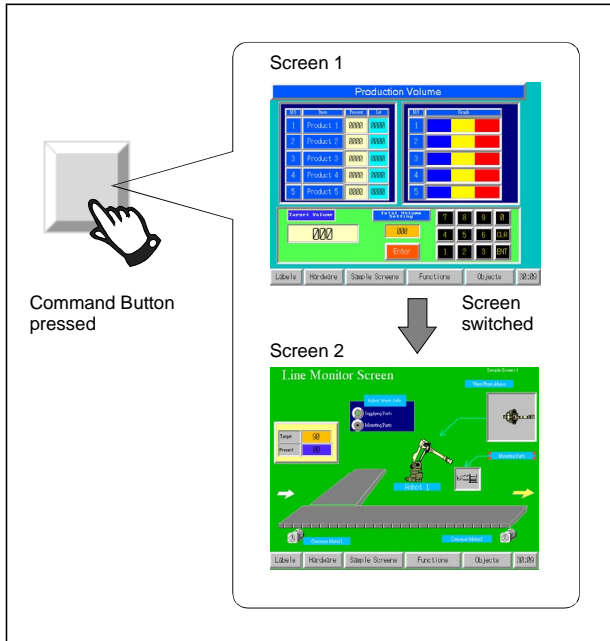

Select **Functional Objects - Command Button** or the  icon in CX-Designer to create a Command Button.

### Note

- ◆ When the display is switched to a screen with many objects, press the position where the Command Button is located to enable input even if the object display on the screen has not been completed yet. The processing does not start until the screen display has been completed, so a short time may lapse before processing is executed.
- ◆ Command buttons can be changed to Multifunction Objects.

If changed to a Multifunction Object, the button can be changed to a lamp or multiple functions can be executed at once when the button is pressed.

Refer to 2-11 *Multifunction Objects* for information on converting to a Multifunction Object.

### Settings for Functional Object Properties

This section describes the settings items in the Functional Object Properties Dialog Box for Command Buttons.

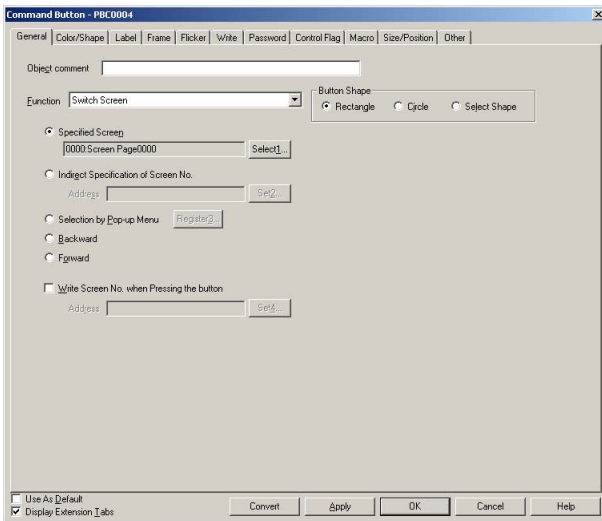

- General: Sets the types of functions and operations for the Command Button.
- Color/shape: Sets the button display color.
- Label: Sets the label display.
- Frame: Sets the button frame display.
- Flicker: Sets the flicker display.(See note.)
- Write: Sets the write confirmation message when the button is pressed. (See note.)
- Password: Sets the password to be entered when the Command Button is pressed. (See note.)
- Control flag: Sets enable/disable input and display/no display for objects. (See note.)
- Macro: Sets macros to be executed. (See note.)
- Size/position: Sets the object size and position. (See note.)
- Other: Sets the input sound for individual touch switches to OFF. (See note.)

Note: These tabs are displayed when *Display Extension Tabs* Option is selected.

### General Tab Page

Sets the types of functions and operations for the button.

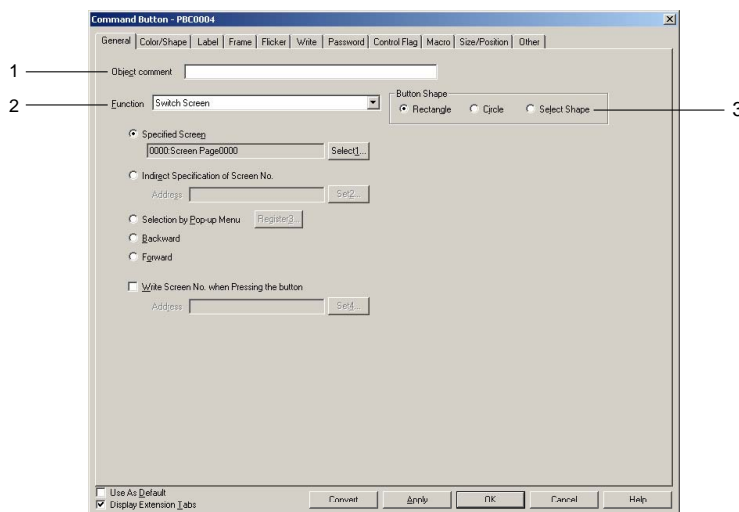

**NS Series Programming Manual**

No.	Setting	Details
1	Object comment	Sets an explanatory comment for the pasted object (up to 32 characters).
2	Function	Used to select the functions that will operate when the Command Button is pressed. <i>Switch screen, Key Button, Control Pop-up screen, Display System Menu, stop buzzer, none, Video control-video capture, Video control-Contrast Adjustment, Video control-Vision Sensor Console Output, Data Block Control, and Authentication Cancellation</i> can be selected as required. The detailed settings differ with each function.
3	Button shape	Used to select Rectangle, Circle, or Select Shape.

**Switch Screen**

The screen can be switched when the button is pressed and released again. The destination screen for the switch screen can be selected from the following five types.

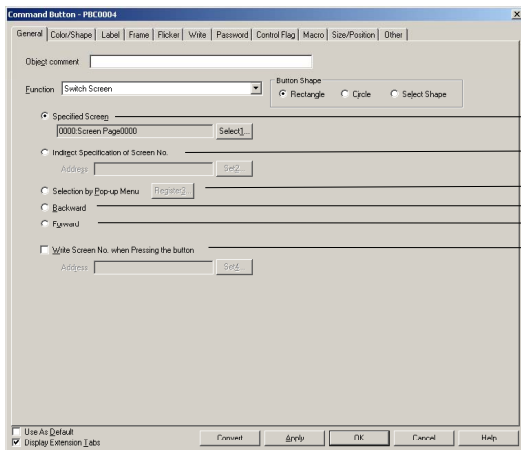

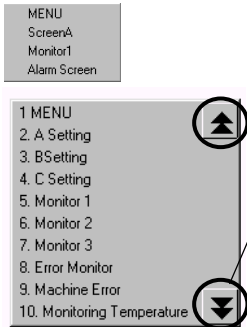
No.	Setting	Details
1	Specified screen	Switches to a specified page number.
2	Indirect Specification of Screen No.	Reads the contents of a specified address as the page number and switches to that specified screen page number.
3	Selection by Pop-up Menu	Displays a pop-up menu for screen selection. (Up to 32 items of up to 64 characters each). The display position of the pop-up menu can be specified to be above or below the Command Button.  
4	Backward	The last 32 page switching operations are recorded and the pages can be returned based on this record. Switches to pop-up screens cannot be recorded.
5	Forward	If the <i>Backward</i> function has been used to go back to previous pages, the <i>Forward</i> function can be used to move ahead to later pages.
6	Write Screen Page No. to the Address when Switching a Screen	The destination screen number can be written to a specified address when screens are switched. Click the check box on the left and specify the write address.

**Note**

- ◆ If screens are opened and closed frequently, the display update may take some time and communications may be delayed.
- ◆ Use the *Indirect Specification of Screen No.* option to use the *Command Button Switch Screen* function to display the System Menu. The System Menu is displayed when “4002” (BCD) or “FA2” (binary) is written to the specified address. The *Specified screen* option cannot be used to switch to the System Menu.  
The display can also be switched to the System Menu by selecting the *Display System menu* function. Refer to *Display System Menu*.
- ◆ The data format (BCD or binary) is set by selecting **PT – Project Properties** and using the *Data Format* Tab Page.

**Key Buttons**

A Key Button is an object that transmits a specified character code to the numeral display and input or character string display field in focus. Character codes (combinations of 0 to 9 and A to F) can be transmitted to the numeral display and input object. The transmitted code will, however, be displayed in the display type for the Numeral display and Input object. For example, if the display is in decimal format, character codes including characters A to F cannot be transmitted.

The settings at the destination determine whether the transmitted character string will be ASCII or Unicode. For example, if the destination string display and input object are set to ASCII, the transmitted character string will be stored in ASCII. If the Command Button is set to a pop-up screen, the code will still be transmitted to the base screen if the focus is on that base screen. Special control codes, (e.g., BS: backspace, CLR: clear, etc.) can also be transmitted as required by the application.

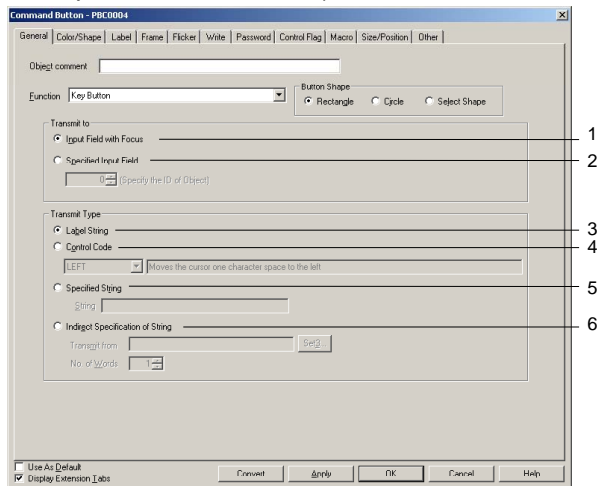

No.	Setting	Details
1	Input field with focus	Transmits the character string to the input field ( <i>Numeral display and input or String display and input</i> ) that is in focus.
2	Specified input field	Sets functional object ID numbers when transmitting to a specific functional object. (See note.)
3	Label string	Transmits the character code for characters set to labels. Up to 64 characters can be transmitted, i.e., the entire registered label can be transmitted.
4	Control code (Refer to the next page)	Select the specific control code from the list. Only for list display when <i>S PAGE UP</i> (scroll bar previous page) or similar items are selected.
5	Specified string	Transmits the character code (up to 256 characters) for a specified string other than labels.
6	Indirectly specification of string	Transmits a specified number of words from a specified address as the character code.

Note: A functional object on the base screen or pop-up screen must be set as the destination. The destination cannot be a functional object on a different screen, e.g., a functional object on the base screen cannot be used as the destination from a pop-up screen. Functional objects on sheets also cannot be used as the destination. When creating a Command Button on a sheet, the destination must be a functional object with a specified ID number on a base screen or pop-up screen using that sheet.

### Reference

- ◆ Functional object ID numbers can be checked by selecting **View – Show ID** (click on Show ID) or opening the Functional Object Properties Dialog Box.



Specify the 4-digit number displayed here if using *Specified Input Field* to specify the ID number. (In the above example, "7" is specified.)

Refer to *Create Screens* in the *CX-Designer Online Help* for information on ID displays.

- ◆ Set *Input Field with Focus* to transmit to other screens. Data cannot be transmitted even if the ID number is set under *Specified Input Field*.

### Control Codes

Control code	Explanation
LEFT	Moves the cursor one character space to the left, deleting the character to the left of the original cursor position.
RIGHT	Moves the cursor one character space to the right, inserting a space to the right of the original cursor position.
CLR	Clears the input data.
CAN	Cancel the input data.
BS	Deletes one character to the left of the cursor.
DEL	Deletes one character to the right of the cursor.
RET	Confirms the input characters.
ENT	Confirms the input characters and moves the focus to the next registered data input object.
±	Reverses the sign of the numeral in the data input field. This option is invalid for character string display.
***.*	Adds a decimal point to the data input field. Use this option when entering real numbers.
HOME	Moves the focus to the data input object at the top left of the screen.
F UP	Moves the focus to the closest data input object above.
F DOWN	Moves the focus to the closest data input object below.
F LEFT	Moves the focus to the closest data input object to the left.
F RIGHT	Moves the focus to the closest data input object to the right.
F NEXT	Moves the focus to the next data input object in ascending order.
F PREV	Moves the focus to the previous data input object in descending order.
S PAGEUP	(For list selection only.) Page-up for scroll bar.
S PAGEDOWN	(For list selection only.) Page-down for scroll bar.
S LINEUP	(For list selection only.) Line-up for scroll bar.
S LINEDOWN	(For list selection only.) Line-down for scroll bar.



**Note**

- ◆ Focus is not moved to input-prohibited objects for focus control codes.
- ◆ If there are two input objects at an equal distance from the current object, the focus will move to the object created first on the CX-Designer.

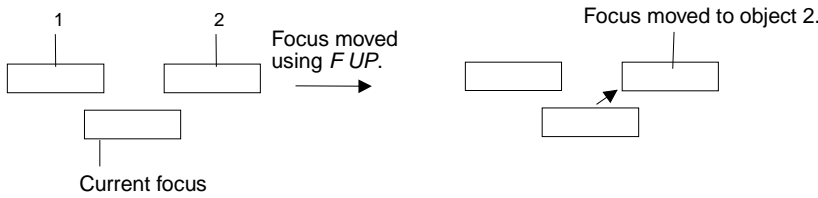

Assuming object 2 is created earlier than object 1 on CX-Designer.

- ◆ Press a functional object other than a Command Button to which *Key Button* is set to remove the focus from numeral display and input objects and string display and input objects.
- ◆ If using *S PAGEUP*, *S PAGEDOWN*, *S LINEUP*, or *S LINEDOWN*, select *Specified Input Field* as the *Transmit to* and specify the ID number for list selection.

**Control Pop-up Screen**

*Control Pop-up screen* controls the pop-up screen specified for display when a button is pressed.

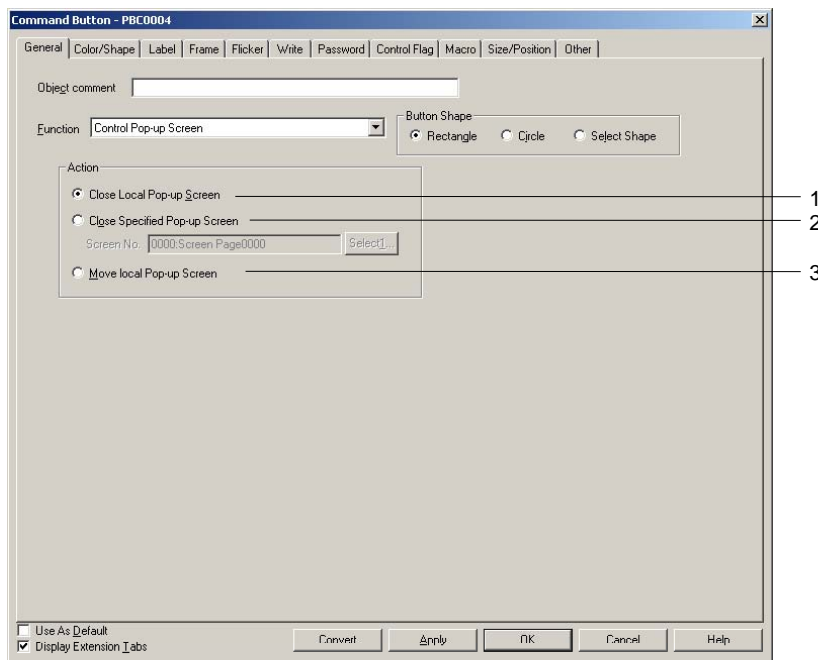

No.	Setting	Details
1	Close Local pop-up screen	Closes the currently displayed pop-up screen using a Command Button in the same screen.
2	Close specified pop-up screen	Closes a specified pop-up screen. Use the <b>Select</b> Button to specify the pop-up screen to be closed. The current screen as well as other pop-up screens can be specified using this option.
3	Move Local pop-up screen	Moves the pop-up screen after the Command Button is pressed to any position pressed on the screen.

**Note**

- ◆ If pop-up screens are controlled (e.g., moved or closed) frequently, the display update may take some time and communications may be delayed.
- ◆ If the screen specified under *Close Local pop-up screen*, *Close specified pop-up screen*, or *Move Local pop-up screen* is a base screen, the Command Button will be disabled while the PT is operating.
- ◆ When moving pop-up screens using *Move Local pop-up screen*, the position touched on the screen after the Command Button is pressed will become the top left corner of the new position for the pop-up screen.

**Display System Menu**

The System Menu Initial Tab, Switch Box, or Display Captured Data will be displayed when the Command Button is pressed.

There are no settings to be made for this option.

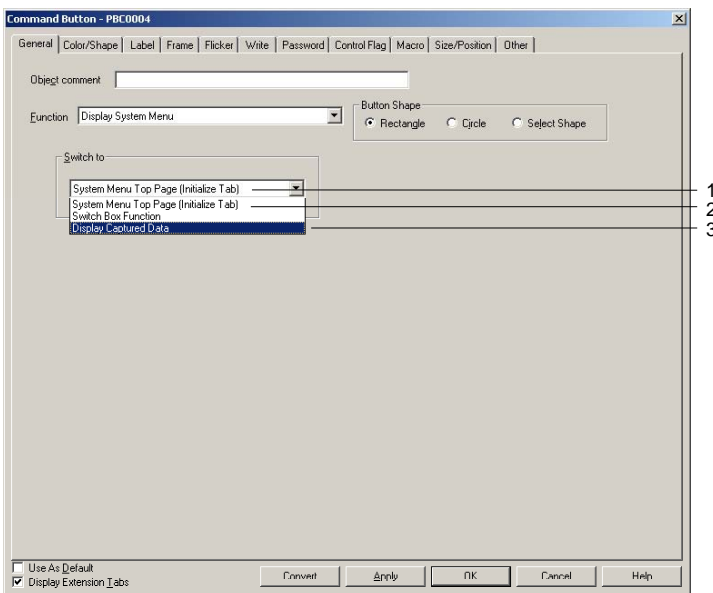

No.	Setting	Details
1	System Menu Top Page (Initialize Tab)	Switches from the user screen to the top page (Initial Tab) of the System Menu.
2	Switch Box Function	Switches directly from the user screen to the Switch Box Screen under Device Monitor.
3	Display Capture Data	Switches directly from the user screen to Display Capture Data under Special Screen.

### Stop Buzzer

The current buzzer will stop when the Command Button is pressed. There are no settings to be made for this option.

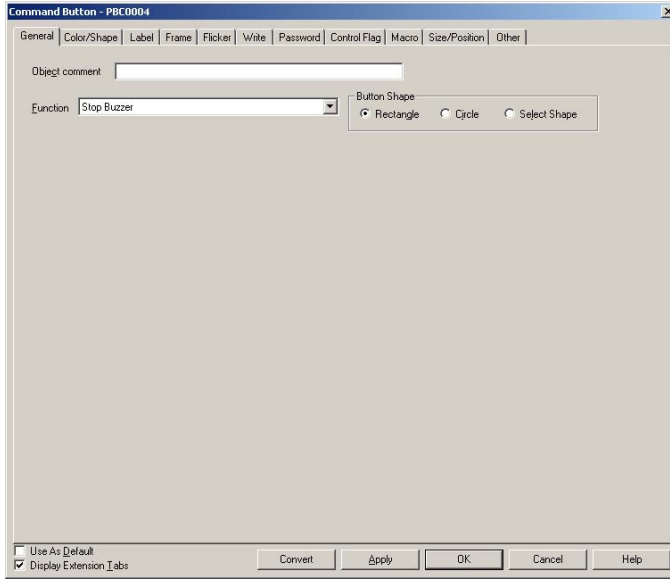

### None

There are no functions for the button itself. This option is used for starting macros. There are no settings to be made for this option.

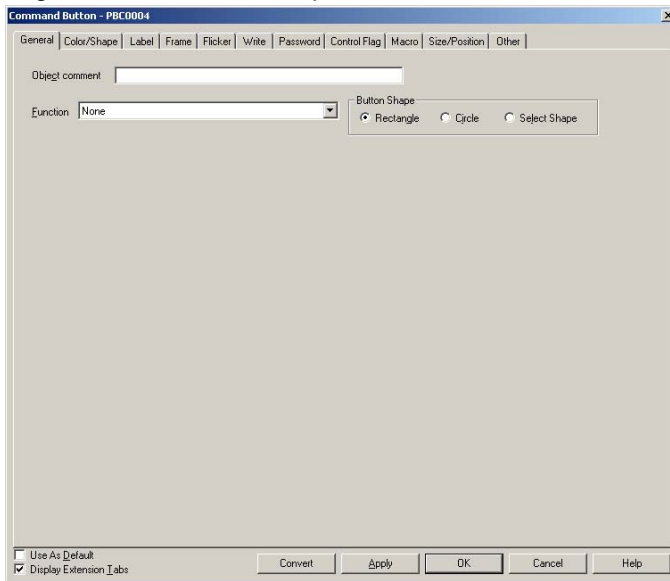

### Video Controls – Video Capture

This function controls the Video Display. When the button is pressed, the specified picture on the screen is captured and saved in bitmap (BMP) format on a Memory Card.

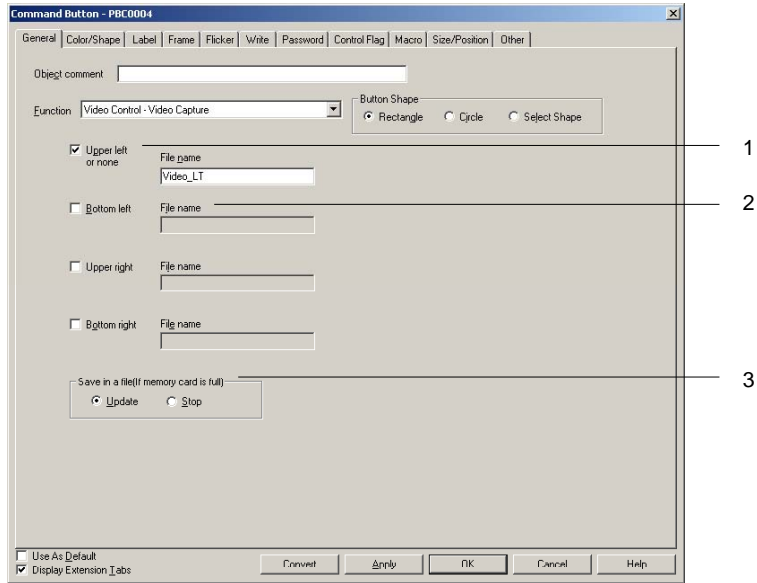

No.	Item	Detail
1	Position of the image	Set the position of the picture to capture. Select <b>Upper left or none</b> when capturing a 640x480 image.
2	File name (See note.)	Specify the file name in which to save the captured picture on the Memory Card in BMP format. (Up to 32 characters) When saving the file, a number from 001 to 999 is automatically added to the end of the file name in order. Example: Video_LT003.bmp
3	Save in a file (If Memory Card is full)	Set the action to perform for video capture if the Memory Card is full. Functions are as follows: Update: If the same file name exists, delete the oldest file and save the newer file with the largest number plus 1. If the same filename does not exist, "Cannot write to the Memory Card" will be displayed. Stop: "Cannot write to Memory Card" will be displayed and the file will not be saved.

Note: When using NS hardware that has been upgraded from Ver. 1 to Ver. 2, keep the file name within 5 characters in length.

### Reference

- ◆ Refer to the NS-series RGB/Video Input Unit User's Manual (V086) for details on the setting method when an NS-CA002 RGB/Video Input Unit is mounted.
- ◆ The following rules will be used for saving captured data:
  - The file name specified in the command button properties will be used.
  - The file names will be automatically numbered in order from 001 to 999 at the end of the file name. After saving the file numbered 999, the next file will be numbered 001.
- ◆ Operation will be as follows if the "If Memory card is full" property is set to "Update" and the file size in the Memory Card and the current file size are not the same:
  1. Assuming the oldest file will be deleted, and PT will check whether enough space can be secured on the Memory Card.
  2. If the space to save can be secured, the smallest-numbered file will be deleted and the new file will be saved. If the current file is bigger than existing file, the existing file will be deleted and the current file will be saved.

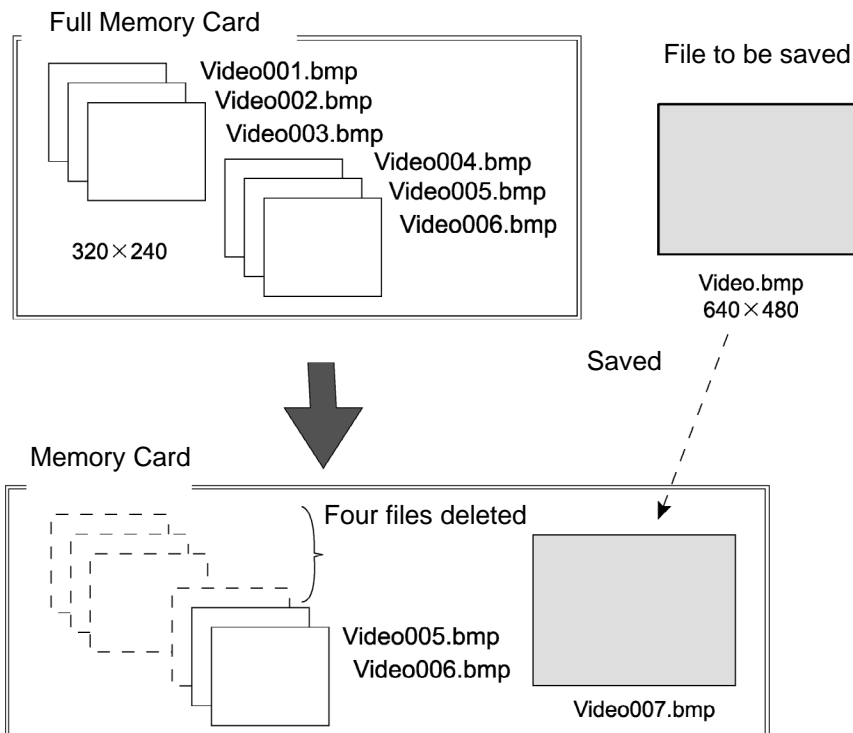

3. If space cannot be secured, the files in the Memory Card will remain unchanged and an error message will be displayed.
- ◆ A 800 x 600 video image cannot be captured.
  - ◆ When a video image is captured, a file with same name as the captured image file and an extension of .mng will be created in the \LOG\CAPTURE folder in the Memory Card directory. These files are used to manage numbers for file names. Do not edit or delete these files.
  - ◆ Video capture may not be performed while transferring the data on the Memory Card Transfer Tool.

**NS Series Programming Manual**

**Video Control – Contrast Adjustment**

Adjusts the contrast, brightness, depth, and tone of the image.

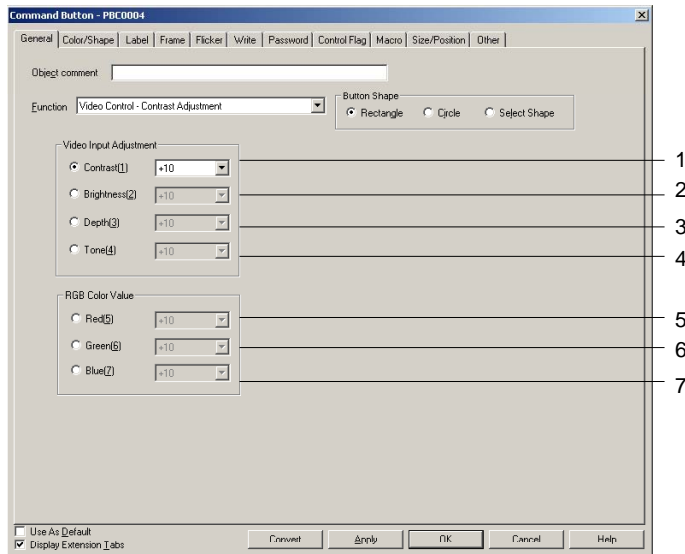

No.	Item	Details
1	Contrast	Setting items: -10, -1, +1, +10 (Adjustable in 64 steps.)
2	Brightness	Setting items: -10, -1, +1, +10 (Adjustable in 128 steps.)
3	Depth	Setting items: -10, -1, +1, +10 (Adjustable in 32 steps.)
4	Tone	Setting items: -10, -1, +1, +10 (Adjustable in 256 steps.)
5	Red	These items can be set only when the NS-CA002 RGB/Video Input Unit is mounted. Refer to the NS-series RGB/Video Input Unit User's Manual (V086) for details on the setting method.
6	Green	
7	Blue	

**Video Control – Vision Sensor Console Output**

Various control signals can be sent to the OMRON Vision Sensor by pressing the button.

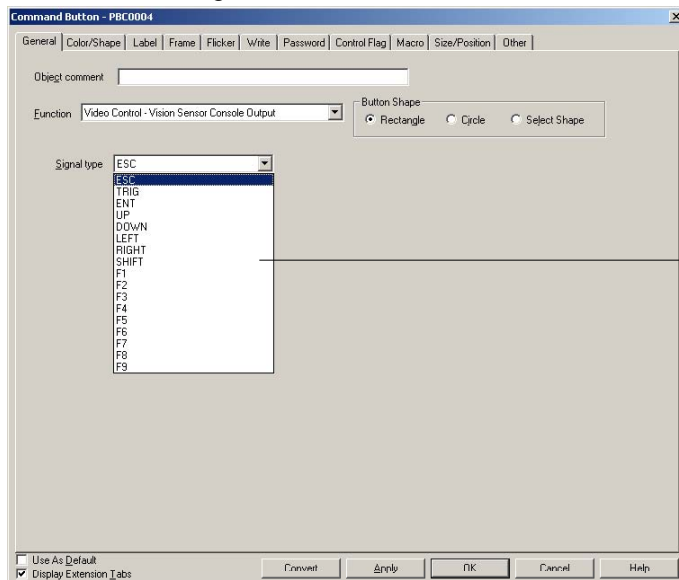

Number	Item	Detail
1	Signal type	Set the signal type to send to the Vision Sensor.

## Signal Types

Name	Description
ESC	Previous screen
TRIG	Execute measurement
ENT	Enter
UP	Move the cursor up or increase the set value by one.
DOWN	Move the cursor down or decrease the set value by one.
LEFT	Move the cursor left.
RIGHT	Move the cursor right.
SHIFT	Add the SHIFT signal. This signal does not function by itself. It changes the function of another signal.
F1 to F9	Refer to the Vision Sensor Console manual for details on the setting method.

**Note**

- ◆ To add the SHIFT signal, press another signal button while holding down the SHIFT button.
- ◆ There is only one SHIFT state held by the system. The last operation for the SHIFT state will be valid when multiple SHIFT buttons are arranged, pressed, or released.

Example: Assume the following operation is performed.

Create button A and button B, both controlling the SHIFT signal.

Then, press button A → press button B → release button A

In this case, the last operation is releasing button A, so the SHIFT state will be cancelled even if the button B is still being pressed.

- ◆ Do not place a Vision Sensor Console Output button on any of the four corners of the PT. When two of four corners of the PT are pressed, the screen switches to the system menu. If the SHIFT button and another button placed on any corner are pressed at the same time or sequentially, the screen may switch to an unintended screen.

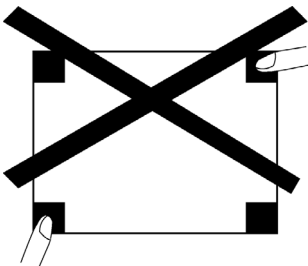

**NS Series Programming Manual**

**Data Block Control – File -- PLC**

This function operates on data blocks. When a button is pressed, CSV file data is transferred to the specified addresses in the PLC or the data from specified addresses in the PLC is transferred to the specified record in the CSV file.

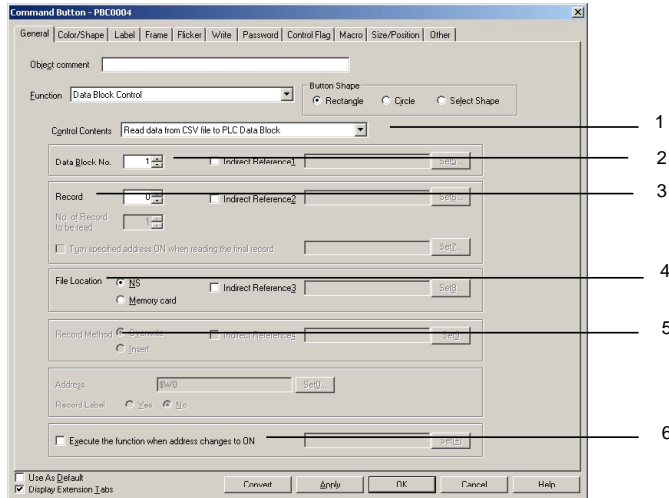

No.	Setting	Details
1	Control content	Specifies the control operation to be performed when the command button is pressed.
	Read data from CSV file to PLC Data Block	Transfers the data from the specified record in the CSV file to the PLC address specified in each field.
	Write data from PLC Data Block to CSV file	Transfers the data from the PLC address specified in each field to the specified record in the CSV file.
	Delete record	Deletes the data from the specified record in the CSV file.
2	Data Block No.	Specifies the data block group number (1 to 100) for the control operation. The group number can be set indirectly through a communications address by selecting the <i>Indirect Reference</i> Option.
3	Record	Specifies the record number in the CSV file (0 to 999) to use in the control operation. The Record number can be set indirectly through a communications address by selecting the <i>Indirect Reference</i> Option.
4	File Location	Specifies either the PT or a Memory Card as the location of the CSV file. The File Location can be set indirectly by selecting the <i>Indirect Reference</i> Option. If the specified address is 0, the PT will be used. If the specified address is 1, the Memory Card will be used.
5	Record Method	If the <i>Control Content</i> Field is set to <i>Write data from PLC Data Block to CSV file</i> , the data at the specified record can be overwritten or it can be inserted at the specified record number. The Record Method can be set indirectly by selecting the <i>Indirect Reference</i> Option. If the specified address is 0, the data will be overwritten. If the specified address is 1, the data will be inserted.
6	Execute the function when address changes to ON	If the option is selected, the specified control operation is performed when the specified address changes from OFF to ON while the command button is being displayed.



**NS Series Programming Manual**

**Data Block Control – File -- NS, NS -- PLC**

This function operates on data blocks. When a button is pressed, data is read/written between the CSV file and the specified PT address or between the specified PT address and the specified PLC address.

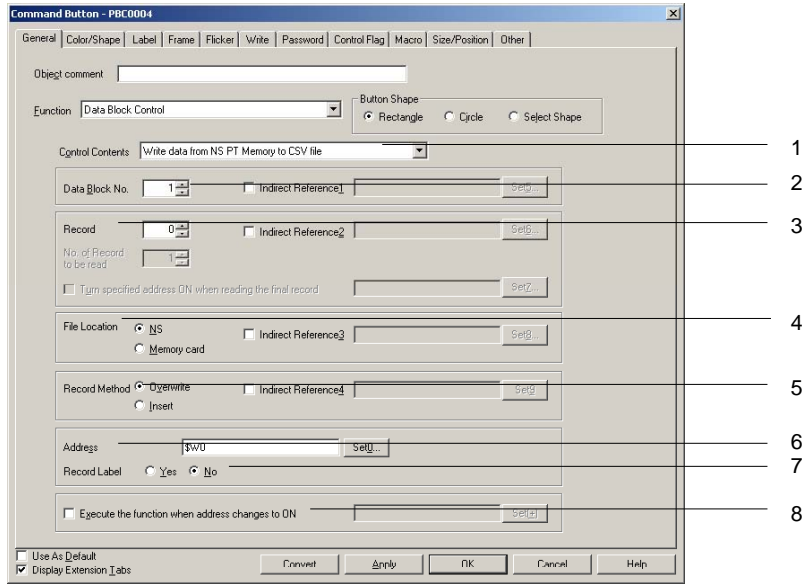

No.	Setting	Details
1	Control content	Specifies the control operation to be performed when the command button is pressed.
	Read data from CSV file to NS PT Memory	Transfers the data from the specified record in the CSV file to the specified address in the PT.
	Write data from NS PT Memory to CSV file	Transfers one record of data from the specified address in the PT to the specified record in the CSV file.
	Read data from NS PT Memory to PLC Data Block	Transfers one record of data from the specified address in the PT to the PLC address specified in each field.
	Write data from PLC Data Block to NS PT Memory	Transfers the data from the PLC address specified in each field to the specified address in the PT.
2	Data Block No.	Specifies the data block group number (1 to 100) for the control operation. The group number can be set indirectly through a communications address by selecting the <i>Indirect Reference</i> Option.
3	Record	Specifies the record number in the CSV file (0 to 999) to use in the control operation. The Record number can be set indirectly through a communications address by selecting the <i>Indirect Reference</i> Option.
4	File Location	Specifies either the PT or a Memory Card as the location of the CSV file. The File Location can be set indirectly by selecting the <i>Indirect Reference</i> Option. If the specified address is 0, the PT will be used. If the specified address is 1, the Memory Card will be used.
5	Record Method	If the <i>Control Content</i> Field is set to <i>Write data from NS PT Memory to CSV file</i> , the data at the specified record can be overwritten or it can be inserted at the specified record number. The Record Method can be set indirectly by selecting the <i>Indirect Reference</i> Option. If the specified address is 0, the data will be overwritten. If the specified address is 1, the data will be inserted.
6	Address	Specifies the PT communications address for reading/writing the PLC address specified in each field or reading/writing data for CSV file.
7	Record Label	Specifies whether to include the record label when reading and writing PT addresses.
8	Execute the function when address changes to ON	If the option is selected, the specified control operation is performed when the specified address changes from OFF to ON while the command button is being displayed.

**NS Series Programming Manual**

**Data Block Control -- Read Record Label**

This function operates on data blocks. When a button is pressed, the record labels for the specified records in the CSV file are transferred to the specified addresses in the PT.

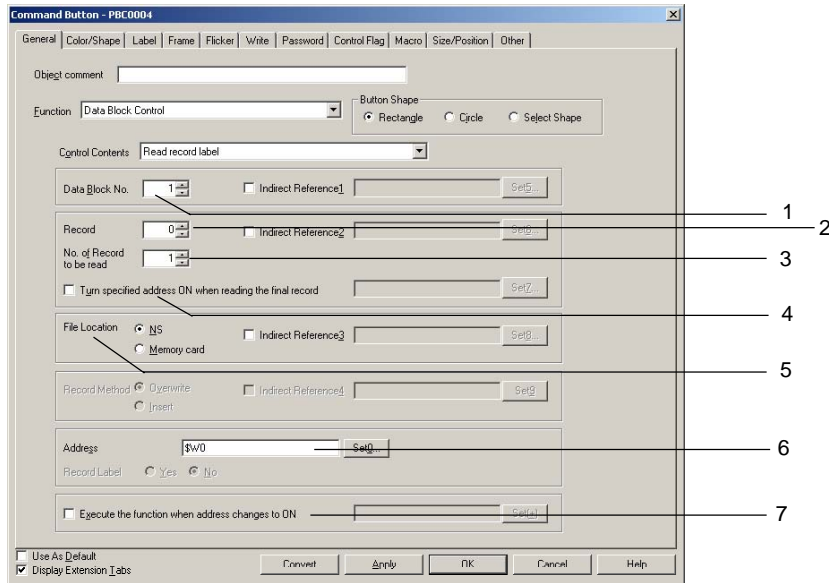

No.	Setting	Details
1	Data Block No.	Specifies the data block group number (1 to 100) to be controlled. The group number can be set indirectly through a communications address by selecting the <i>Indirect Reference</i> Option.
2	Record	Specifies the first record number (0 to 999) in the CSV file for which the record label is to be read. The Record number can be set indirectly through a communications address by selecting the <i>Indirect Reference</i> Option.
3	No. of Record to be read	Specifies the number of record labels to read starting from the top record number.
4	Turn specified address ON when reading the final record	If this option is selected, the specified address will turn ON when the record label has been read for the last record number.
5	File Location	Specifies either the PT or a Memory Card as the location of the CSV file. The File Location can be set indirectly by selecting the <i>Indirect Reference</i> Option. If the specified address is 0, the PT will be used. If the specified address is 1, the Memory Card will be used.
6	Address	Specifies the PT communications address to which to write the record labels.
7	Execute the function when address changes to ON	If the option is selected, the specified control operation is performed when the specified address changes from OFF to ON while the command button is being displayed.

### Authentication Cancellation

The authentication will be cancelled when the Command Button is pressed. There are no settings to be made for this option.

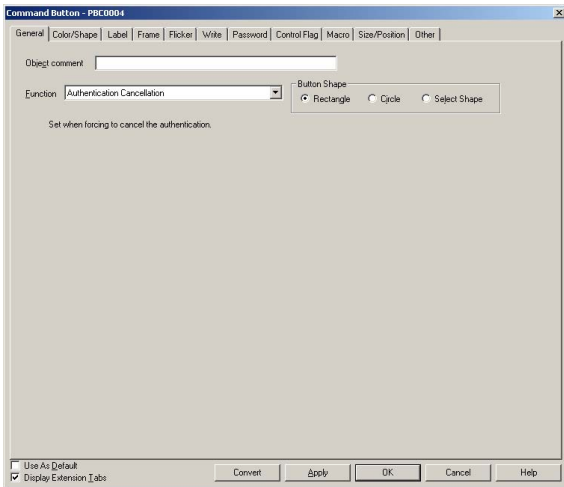

**Note**

- No processing is performed if the button is pressed when the authentication has already cancelled.

### Color/Shape Tab Page

Specifies the button color and shape.

Select the button color from 256 options, when rectangle or circle buttons are selected.

If *Select Shape* is selected under *Button Shape*, select a Display Shape from the Shape Types list.

#### Color

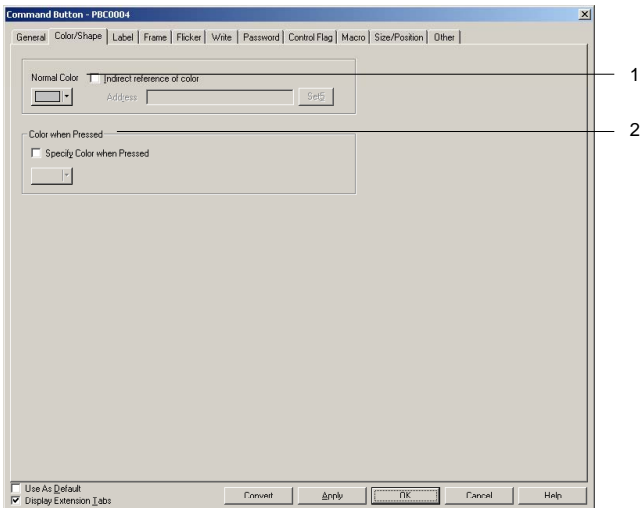

No.	Setting	Details
1	Normal color	Sets the button's color.
2	Color when pressed	Select the <i>Specify Color when Pressed</i> option and set the button's color.

Refer to *Setting Colors* in *2-8 Common Functional Object Functions* for information on how to set colors.

**Specifying Shapes**

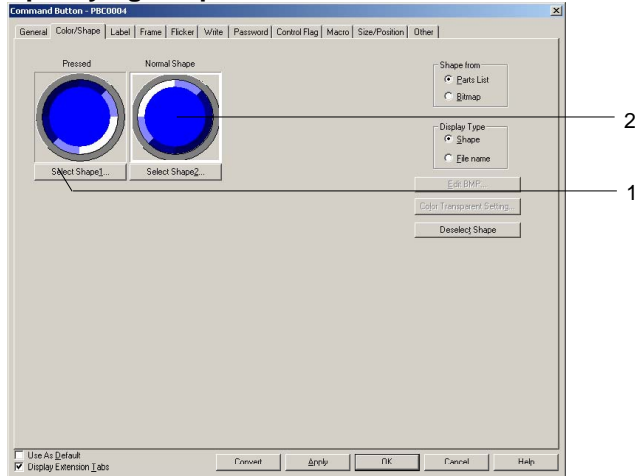

No.	Setting	Details
1	Shape when Pressed	Click the <b>Select Shape</b> Button to set the button's shape when it is pressed.
2	Normal Shape	Click the <b>Select Shape</b> Button to set the button's normal shape.

Refer to *Selecting Shape* in *2-8 Common Functional Object Functions* for information on how to set shapes.

**Label Tab Page**

Set a label for the button. Refer to *Labels* under *2-8 Common Functional Object Functions* for details.

**Frame Tab Page**

Specify the colors and sizes of the button frame to change the shape or color when the button is depressed or raised. Refer to *Frames* under *2-8 Common Functional Object Functions* for details.

**Flicker Tab Page**

Make flicker settings to make the button flicker (flash). Refer to *Flicker* under *2-8 Common Functional Object Functions* for details.

**Write Tab Page**

Use the Write Tab Page to display a confirmation display box before writing values to a write address. The confirmation message can be changed. Refer to *Write Settings* under *2-8 Common Functional Object Functions* for details.

**Password Tab Page**

Set a password for when buttons are pressed. Five passwords of up to 16 characters each can be set. One password can be requested for each object. Refer to *Passwords* under *2-8 Common Functional Object Functions* for details.

**Control Flag Tab Page**

Control flags control the input and display of functional objects. Use control flags to enable display or input when the contents of an address turn ON or OFF. Refer to *Control Flags* under *2-8 Common Functional Object Functions* for details.

### Macro Tab Page

Macros can be specified for Command Buttons.  
Macros executed by the following triggers can be registered.

Trigger	Details
Touch ON	Executes macro when the button is pressed.
Touch OFF	Executes macro when the button is released.

Refer to the CX-Designer's NS-series Macro Reference for information on setting macros.

### Size/Position Tab Page

Displays and sets the functional object size and position. Refer to *Size/Position* under *2-8 Common Functional Object Functions* for details.

### Other (Extension Tab)

The touch switch input sound for ON/OFF buttons can be individually turned OFF. The touch switch input sound will be turned OFF for all objects (regardless of the individual settings) if the touch switch input sound (Key Press Sound) has been set to OFF in the PT's System Menu or in the System Setting Window's PT Tab Page in the CX-Designer.

## 2-10 Lamps

Lamps are functional objects for which the display depends on the contents of the address on the host. There are bit lamps and word lamps.

### 2-10-1 Bit Lamps

The bit lamp display color depends on the ON/OFF status of the specified address.

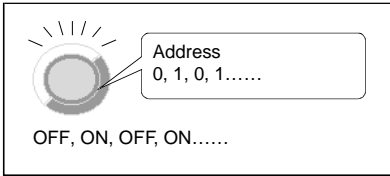

Select **Functional objects - Bit lamp** or the  icon in CX-Designer to create a bit lamp.

#### Note

- ◆ Bit lamps can be changed to Multifunction Objects.  
If changed to a Multifunction Object, the lamp can be changed to a button or multiple functions can be executed at once when the button is pressed.  
Refer to 2-11 Multifunction Objects for information on converting to a Multifunction Object.

### Settings for Functional Object Properties

This section describes the settings in the Functional Object Properties Dialog Box for bit lamps.

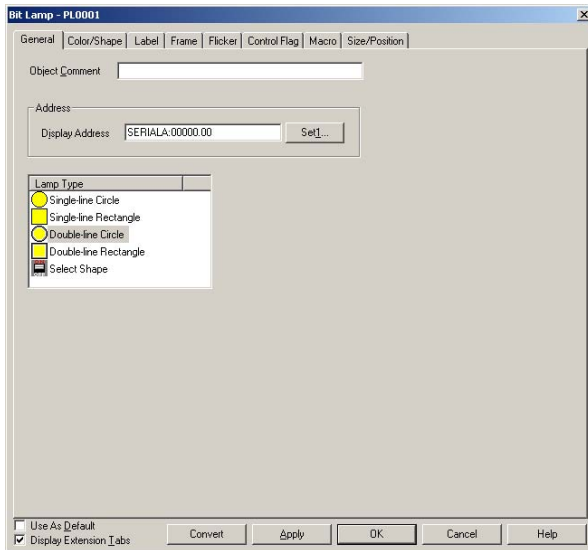

- General: Sets the address and lamp shape.
- Color/Shape: Sets the lamp display color and shape.
- Label: Sets the label display.
- Frame: Sets the lamp frame display.
- Flicker: Sets the flicker display. (See note.)
- Control Flag: Sets display/no display of the functional object. (See note.)
- Macro: Sets macros to be executed. (See note.)
- Size/Position: Sets the object size and position. (See note.)





Note: These tabs are displayed when the *Display Extension Tabs* Option is selected.

**NS Series Programming Manual**

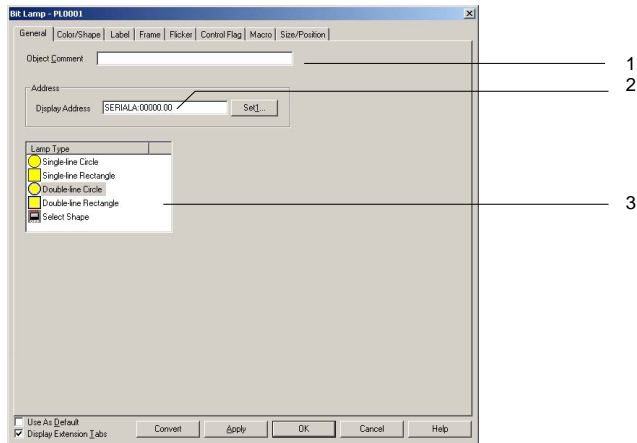
**General Tab Page**

Sets the lamp shape and address.



No.	Setting	Details
1	Object Comment	Sets an explanatory comment for the pasted object. (Up to 32 characters.)
2	Display Address	Sets the address referenced for lamp display directly or by using the <b>Set</b> Button. Only bits can be set.
3	Lamp type	<p>Select from the five lamp shapes shown below.</p> <div style="display: flex; justify-content: space-around; align-items: center;"> <div style="text-align: center;">  <p>Single-lined circle</p> </div> <div style="text-align: center;">  <p>Single-lined rectangle</p> </div> <div style="text-align: center;">  <p>Double-lined circle</p> </div> <div style="text-align: center;">  <p>Double-lined rectangle</p> </div> <div style="text-align: center;">  <p>Select shape</p> </div> </div> <p>Various lamp shapes can be selected from the list and displayed when the shape is specified. The image displayed in the Properties Dialog Box is a sample. The actual display will depend on the settings made on the Color/shape Tab Page.</p>

**Color/Shape Tab Page**

Specifies the shape and color when lamps are ON and OFF.

If a selection other than *Select shape* is made for the lamp type, one of 256 colors can be selected.

If *Select shape* is selected under *Lamp type*, select a display shape from the list.

**NS Series Programming Manual**

**Color**

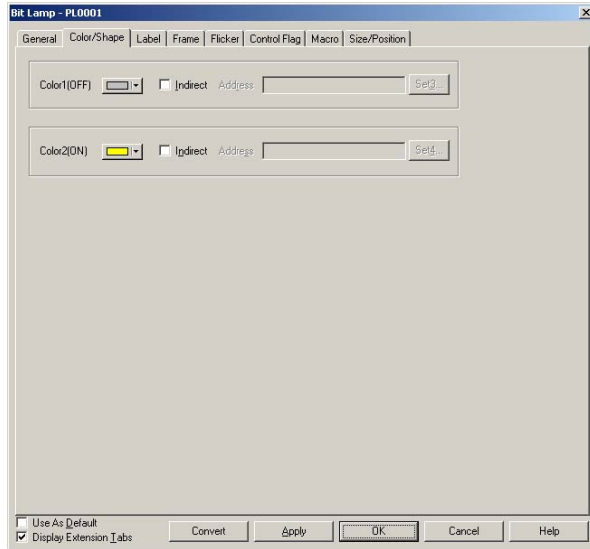

No.	Setting	Details
1	Color 1 and Color 2 (OFF/ON)	Sets the lamp color when the contents of the lamp address is 0 or 1 (OFF/ON). Colors can also be set after referencing the contents of the address.

Refer to *Setting Colors in 2-8 Common Functional Object Functions* for information on how to set colors.

**Select Shape**

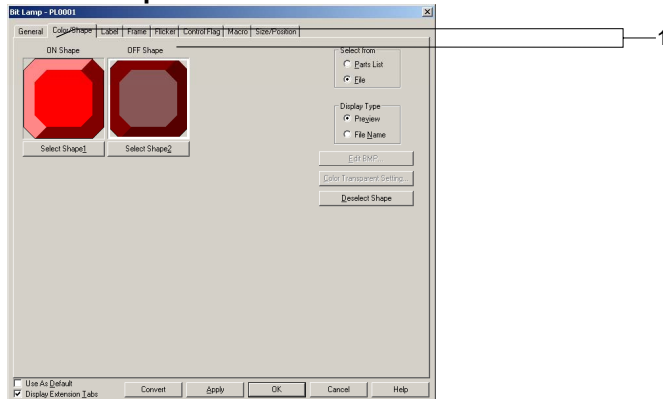

No.	Setting	Details
1	ON/OFF Shapes	Sets the shape when the lamp is turned ON or OFF using the <b>Select Shape</b> Button.

Refer to *Selecting Fixed Objects in 2-8 Common Functional Object Functions* for information on how to set fixed objects.

**Label Tab Page**

Sets labels for lamps. Refer to *Labels in 2-8 Common Functional Object Functions* for basic settings information. This section describes only the settings for bit lamps.

The labels of bit lamps can be switched as the lamp turns ON and OFF.



**NS Series Programming Manual**

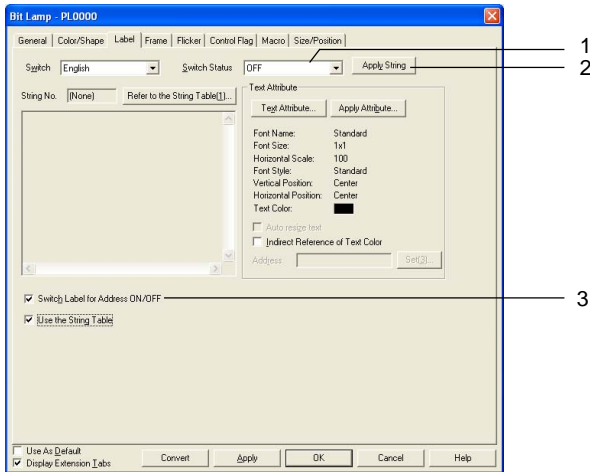

No.	Setting	Details
1	Switch Status	Select ON or OFF from the displayed list. Click the <b>ON/OFF</b> Button to edit the labels for when the specified address is ON and OFF. The label will switch each time the ON/OFF Button is clicked.
2	Apply String	Uses the current character string for all object states. The string is used as the label not only for the selected object, but for all other object states as well. If the Switch Status cannot be set, then the Apply String Button can also not be set.
3	Switch a label with ON/OFF of communications address	Select this option to enable switching the label when the specified address turns ON and OFF. The ON/OFF Button in 1, above, will be enabled when this option is selected.

**Frame Tab Page**

Specify the colors and sizes of the lamp frame to change the shape or color when the button is depressed or raised. Refer to *Frames* under 2-8 Common Functional Object Functions for details.

**Flicker Tab Page**

Make flicker settings to make the lamp flicker (flash). Refer to *Flicker* under 2-8 Common Functional Object Functions for details.

**Control Flag Tab Page**

Control flags control the display of functional objects. Use control flags to enable display when the contents of an address turn ON or OFF. Refer to *Control Flags* under 2-8 Common Functional Object Functions for details.

**Macro Tab Page**

Macros can be specified for bit lamps.  
Macros executed by the following trigger can be registered.

Trigger	Details
When changing value	Executes the macro when the contents of the address changes.
Action timing	Sets the timing for executing the macro.
Execute when ON/OFF	Executes the macro when the specified bit turns ON or OFF.
Execute when ON	Executes the macro when the specified bit turns ON.
Execute when OFF	Executes the macro when the specified bit turns OFF.

Refer to *NS-series Macro Reference* on the CX-Designer for information on setting macros.

### Size/Position Tab Page

Displays and sets the functional object size and position. Refer to *Size/Position* under 2-8 *Common Functional Object Functions* for details.

## 2-10-2 Word Lamps

A word lamp is a functional object where the lamp color depends on the level (0 to 9) of the contents of a specified address (word).

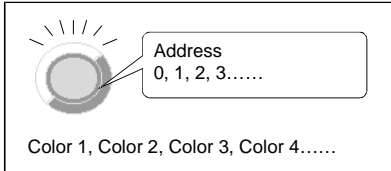

Select **Functional objects - Word lamp** or the  icon in CX-Designer to create a word lamp.

### Note

- ◆ Word lamps can be changed to Multifunction Objects.  
If changed to a Multifunction Object, the lamp can be changed to a button or multiple functions can be executed at once when the button is pressed.  
Refer to 2-11 *Multifunction Objects* for information on converting to a Multifunction Object.

## Settings for Functional Object Properties

This section describes the settings items in the Functional Object Properties Dialog Box for word lamps.

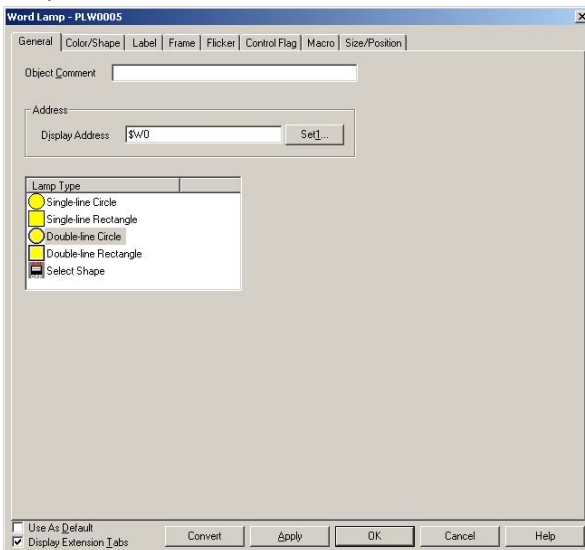

General:	Sets the address and lamp shape.
Color/Shape:	Sets the lamp display color and shape.
Label:	Sets the label display.
Frame:	Sets the lamp frame display.
Flicker:	Sets the flicker display. (See note.)
Control Flag:	Sets display/no display of the functional object. (See note.)
Macro:	Sets macros to be executed. (See note.)
Size/Position:	Sets the object size and position. (See note.)





Note: These tabs are displayed when the *Display Extension Tabs* Option is selected.

**NS Series Programming Manual**

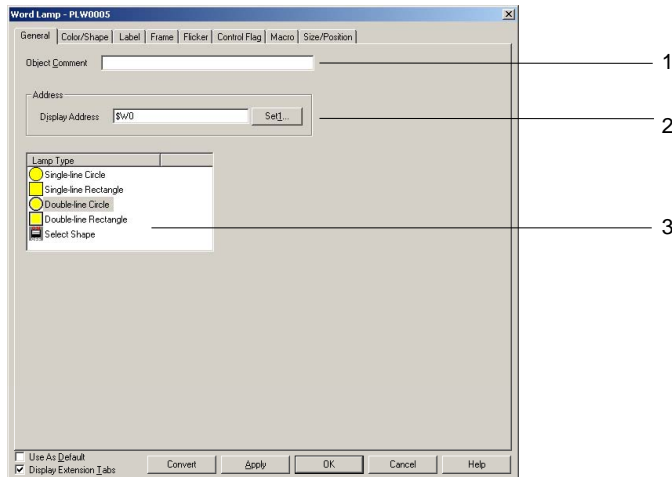
**General Tab Page**

Sets the lamp shape and address.



No.	Setting	Details
1	Object Comment	Sets an explanatory comment for the pasted object. (Up to 32 characters.)
2	Address	Sets the address referenced for lamp display. Only words can be set.
3	Lamp type	Select from the five lamp shapes shown below. <div style="display: flex; justify-content: space-around; align-items: center; margin: 10px 0;"> <div style="text-align: center;">  <p>Single-lined circle</p> </div> <div style="text-align: center;">  <p>Single-lined rectangle</p> </div> <div style="text-align: center;">  <p>Double-lined circle</p> </div> <div style="text-align: center;">  <p>Double-lined rectangle</p> </div> <div style="text-align: center;">  <p>Select shape</p> </div> </div> Various lamp shapes can be selected from the list and displayed when the shape is specified. The image displayed in the Properties Dialog Box is a sample. The actual display will depend on the settings made on the Color/Shape Tab Page.

**Color/Shape Tab Page**

Specify the color and shape of the lamp.

If a selection other than *Select shape* is made for the lamp type, one of 256 colors can be selected.

If *Select shape* is selected under *Lamp type*, select a display shape from the list.

**Color**

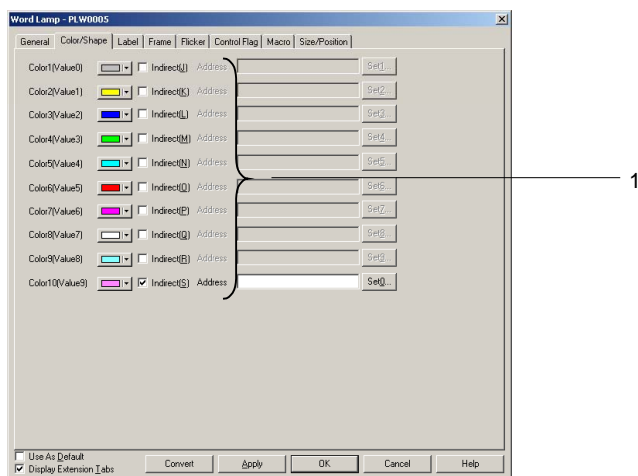

**NS Series Programming Manual**

No.	Setting	Details
1	Colors 1 to 10	Sets the lamp color when the contents of the lamp address is 0 to 9. Colors can also be set after referencing the contents of the address.

Refer to *Setting Colors* in *2-8 Common Functional Object Functions* for information on how to set colors.

**Select Shape**

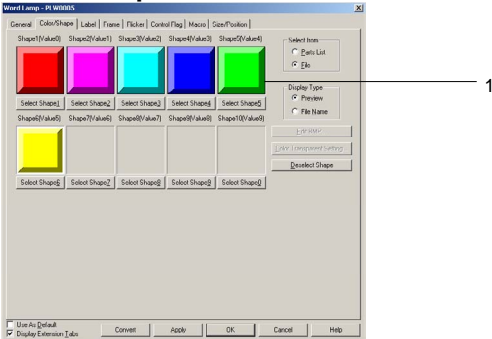

No.	Setting	Details
1	Shapes 1 to 10	Sets the lamp display shape when the contents of the lamp address is 0 to 9. If no shape has been selected, the lamp will be a single-lined rectangle during PT operation.

Refer to *Selecting Fixed Objects* in *2-8 Common Functional Object Functions* for information on how to set fixed objects.

**Label Tab Page**

Sets labels for lamps. Only the settings unique to word lamps are described here. Refer to *Labels* in *2-8 Common Functional Object Functions* for basic settings information.

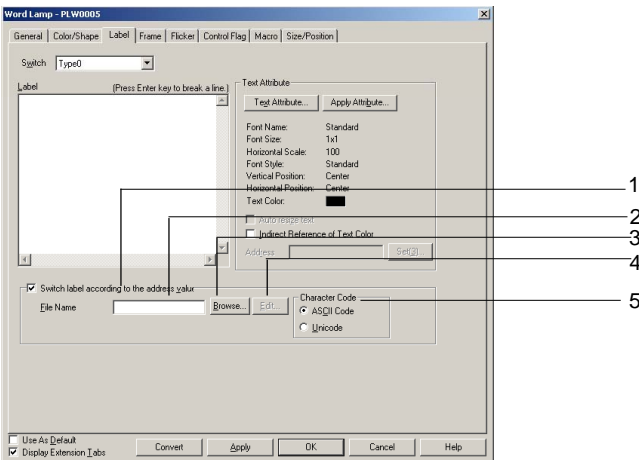

No.	Setting	Details
1	Switch label according to address value	Select to display the label text strings specified in a file according to changes in the value of an address. This setting cannot be used if Windows fonts are selected.
2	File Name	Displays the name of the file containing the text strings to display for changes in the value of the address.
3	Browse	Click this button to display the file selection dialog box and select the file containing text strings.
4	Edit	Starts the text editor so that the text file can be edited. To set the text editor that is started when the <b>Edit</b> Button is pressed, select <b>Tools – Option</b> and open the Editor Tab Page.
5	Character Code	Sets the text code used to store text strings in the file.

**Frame Tab Page**

Specify the colors and sizes of the lamp frame to change the shape or color when the button is depressed or raised. Refer to *Frames* under *2-8 Common Functional Object Functions* for details.

**Flicker Tab Page**

Make flicker settings to make the lamp flicker (flash). Refer to *Flicker* under *2-8 Common Functional Object Functions* for details.

**Control Flag Tab Page**

Control flags control the display of functional objects. Use control flags to enable display when the contents of an address turn ON or OFF. Refer to *Control Flags* under *2-8 Common Functional Object Functions* for details.

**Macro Tab Page**

Macros can be specified for word lamps.

Macros executed by the following trigger can be registered.

Trigger	Details
When changing value	Executes macro when the contents of the address change.

Refer to *NS-series Macro Reference* on the CX-Designer for information on setting macros.

**Size/Position Tab Page**

Displays and sets the functional object size and position. Refer to *Size/Position* under *2-8 Common Functional Object Functions* for details.

## 2-11 Multifunction Objects

Multifunction Objects are functional objects that can be used to execute more than one function at the same time with just one touch.

When the object is touched or the value at a specified address changes, the functions that have been set will be executed consecutively. Up to 32 functions can be set for each execution condition.

Using Multifunction Objects means that operations that were performed using a combination of macros and multiple functional objects can now be performed in one operation.

### Multifunction Object

Executes the set functions in order.



The functions are executed with a single touch.

1. Turn ON \$B100.
- ↓
2. Set DM100 to 10.
- ↓
3. Turn ON CIO 100.0.
- ↓
4. Switch to screen 50.

**NS Series Programming Manual**

With Multifunction Objects, the series of operations for each function can be executed in any order, by making property settings as shown below.

Register each function in order of execution.

Set operations for 1.

Set operations for 2.

Set operations for 3.

Set operations for 4.

Set properties for each function.

## 2-11-1 Functions That Can Be Executed Using Multifunction Objects

The following functions can be executed using Multifunction Objects.

	Function	Details
Write	Write Bit	Turns ON/OFF the specified bit address.
	Write Word	Changes the value at a specified word address.
	Write String	Sets a character string to a specified word address.
Switch Screen	Switch Screen	Switches the displayed screen.
	Control Pop-up Screen	Controls pop-up screens, e.g., closing the specified pop-up screen.
	Display System Menu	Displays the following System Menu displays. <ul style="list-style-type: none"> <li>• Data Initialization Screen</li> <li>• Switch Box Functions</li> <li>• Capture Data</li> <li>• Ladder Monitor</li> <li>• Programming Console (C/CS)</li> <li>• PLC Data Trace</li> <li>• Troubleshooting (NSJ only)</li> <li>• Operation log (sort by occurrence)</li> <li>• Operation log (sort by frequency)</li> </ul>
Object Control	Key Button	Transmits a key code to the object to which an input is being made.
	Data Block Control	Controls data blocks. The following functions are supported. <ul style="list-style-type: none"> <li>• Read data from CSV file to PLC Data Block</li> <li>• Write data from PLC Data Block to CSV file</li> <li>• Read data from CSV file to NS</li> <li>• Write data from NS to CSV file</li> <li>• Read data from NS to PLC Data Block</li> <li>• Write data from PLC Data Block to NS</li> <li>• Read record label</li> <li>• Delete record</li> </ul>
	Contents Control	Switches the displayed contents.
	Alarm/Event Control	Saves and clears alarm/event histories. Also performs operations on Alarm/Event Summary & History.
	Data Log Control	Controls specified data log groups and data log graphs.
	Video Control - Video Capture	Captures a video image at a specified location and saves it in .bmp format to the Memory Card.
	Video Control - Contrast Adjustment	Adjusts the contrast, brightness, depth, and tone of video images.
	Video Control - Vision Sensor Console Output	Sends a variety of control signals to OMRON Vision Sensors.
Scroll Object	Scrolls the following objects in a specified direction. <ul style="list-style-type: none"> <li>List Selection, Alarm/Event Summary/History, Broken-line Graphs, Data Block Tables, Data Log Graphs, and Contents Display</li> </ul>	
Special	Password Setting	A password can be requested for operation of Multifunction Objects.
	Authentication Cancellation	Cancels authentication when an authentication level is set.
	Confirmation Dialog Box	A confirmation dialog box can be displayed when a Multifunction Object is operated.
	Buzzer	Controls starting and stopped the buzzer.
	Macro	Executes macros.
	Operation Log Control	Initializes or saves the operation log.



## 2-11-2 Execution Conditions for Multifunction Objects

The following table outlines the execution conditions, i.e., timing, for functions when an Multifunction Object is used.

Timing	Description
When pressing	<p>The set functions are executed when the Multifunction Object is pressed.</p> <p>The timing for execution can also be specified to either <i>Touch ON timing</i> or <i>Touch OFF timing</i>.</p> <p>Touch ON timing: Executes the functions when the Multifunction Object is pressed.</p> <p>Touch OFF timing: Executes the functions when the Multifunction Object is released.</p>
When value changed	<p>The set functions are executed when the value at a specified address changes.</p> <p>The communications address can set as a bit or word address, and the following execution timings can be set.</p> <p>When a bit address is specified:</p> <p>Execute when ON/OFF: Executes the functions when the communications address turns ON or turns OFF.</p> <p>Execute when ON: Executes the functions when the communications address turns ON.</p> <p>Execute when OFF: Executes the functions when the communications address turns OFF.</p> <p>When a word address is specified:</p> <p>When an address value changed</p> <p>Set Value = Address Value</p> <p>Set Value != Address Value</p> <p>Set Value &lt; Address Value</p> <p>Set Value &lt;= Address Value</p> <p>Set Value &gt; Address Value</p> <p>Set Value &gt;= Address Value</p>

### Note

- ◆ Specify *When pressing* as the execution condition if using the Multifunction Object as a button. Multifunction Objects can be used as lamps if *When pressing* is not specified.
- ◆ The operation for when the object is pressed and when the address value is changed can be set separately. Both can also be used at the same time.

### 2-11-3 Safety Functions

The following functions can be used to prevent malfunctions when using Multifunction Objects.

- Double pressing
- ON delay and OFF delay
- Prohibiting simultaneous pressing

#### Double-pressing

Multifunction Objects can be set so that the touch operation is enabled when the object is pressed twice.

The operation is executed if the Multifunction Object is pressed again within the specified reception time after initially being pressed. If the Multifunction Object is not pressed within the set reception time, the set functions will not be executed.

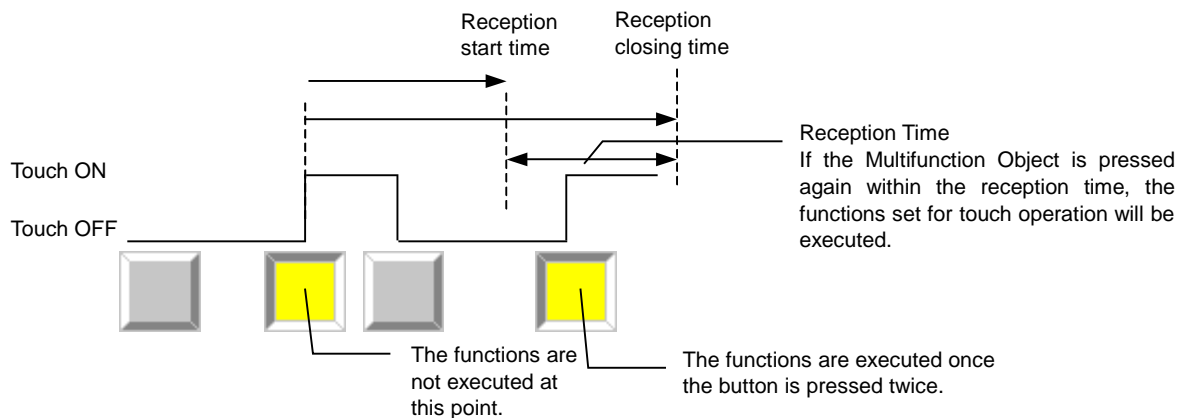

#### Note

- ◆ If the Multifunction Object is pressed before reception start time, that input will be ignored.
- ◆ The entire Multifunction Object will flicker (reverse its display state) in the following cases when the double-pressing operation is performed.  
From the first time the Multifunction Object is touched ON until the second time it is touched ON.  
From the first time the Multifunction Object is touched ON until the reception time expires (when the Multifunction Object is not touched a second time).
- ◆ If a Control Flag disables input while the double-pressing operation is being performed, the second touch will not be accepted and the functions set for the Multifunction Object will not be executed.

### ON Delay

Multifunction Objects can be set so that the touch operation is enabled when the object continues to be pressed for at least as long as the specified delay time. The functions that were set for touch operation will not be executed if the Multifunction Object is released before the delay time has passed.

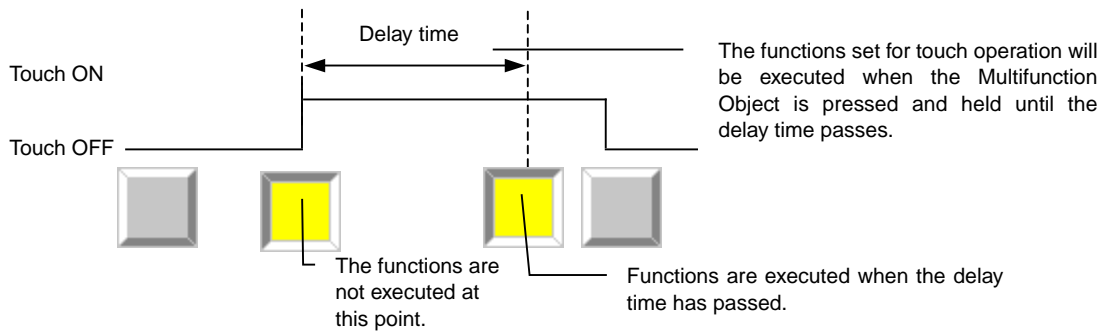

**Note**

- ◆ If both the ON delay and double pressing are set, the ON delay will function the first time the Multifunction Object is pressed, and will not function the second time it is pressed.
- ◆ If a Control Flag disables input before the delay time expires, the functions for which the ON delay was set will not be executed.

### OFF Delay

The functions set for execution at Touch OFF will be executed when the specified delay time has passed after the Multifunction Object is released.

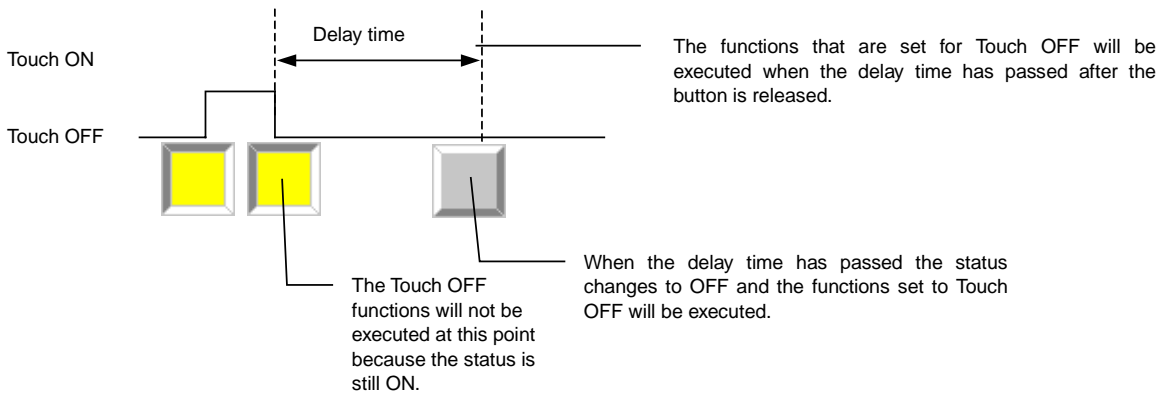

**Note**

- ◆ Functions set for execution *When pressing* or at *Touch ON timing* are executed at when the Multifunction Object is pressed, and are thus not affected by the OFF delay function.
- ◆ If both the OFF delay and double pressing are set, the OFF delay will not function the first time the Multifunction Object is released, and will function the second time it is released.
- ◆ If a Control Flag disables input before the delay time expires, the functions for which the OFF delay was set will not be executed.

### Prohibiting Simultaneous Pressing

This function stops simultaneous operation with other functional objects.

Other functional objects will not operate while a Multifunction Object set to Prohibit simultaneous pressing is being pressed.

And Multifunction Objects set to Prohibit simultaneous pressing will not operate while another functional object is being pressed.

## 2-11-4 Writing and Reading Communications Addresses

### Synchronous and Asynchronous Communications

Multifunction Objects can be set to write to more than one communications address. There are two methods available: synchronous communications and asynchronous communications.

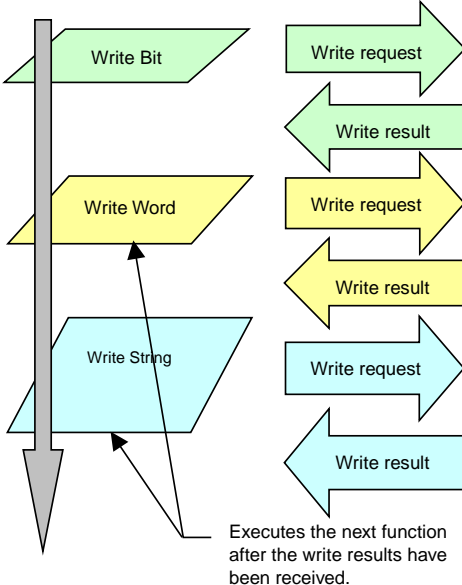
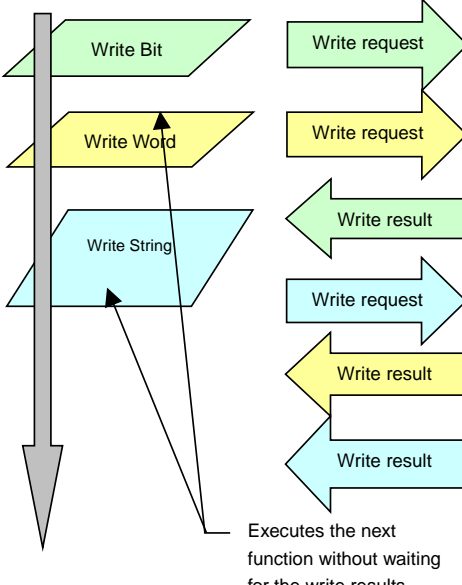
Synchronous communications	Asynchronous communications
<p>When a communications address is read or written, the next function will be executed only after the response for the operation results has been received.</p> <p>Example</p>  <p>Executes the next function after the write results have been received.</p>	<p>When a communications address is read or written, the next function will be executed without waiting for a response for the write operation results.</p> <p>Example</p>  <p>Executes the next function without waiting for the write results.</p>

**Note**

- ◆ The use of synchronous communications is set on the Expansion Settings Tab Page in the Property Settings Dialog Box for Multifunction Objects.
- ◆ Synchronous communications takes longer to complete operations than asynchronous communications but is effective if waiting for the results of one operation execution before performing the next operation.
- ◆ Macro execution will be performed with synchronous communications, regardless of the settings.
- ◆ If functions are executed that do not read or write to a communications address, the next function will be executed without waiting for a response about the results.

### Operations When Communications Errors Occur

A communications error will occur if an attempt is made to read or write to a communications address in an unconnected host. This function is used to set whether or not to continue with subsequent set operations or to interrupt the operations when such a communications error occurs. Interruption of operations can only be selected for synchronous communications. Operations will continue for asynchronous communications.

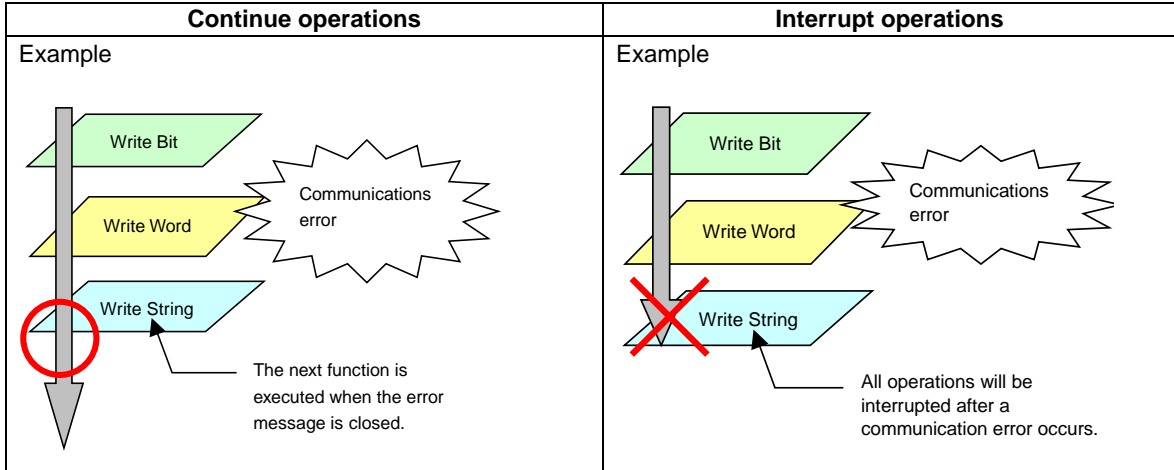

**Note**

- ◆ Whether or not to continue operation after a communications error is set on the Expansion Setting Tab Page in the Property Settings Dialog Box for Multifunction Objects.
- ◆ If a communications error caused by something other than communications with an unconnected host occurs, the error message display will be followed by the System Menu. For this reason, Multifunction Object processing will be canceled.

### 2-11-5 Canceling Multifunction Object Processing

More than one function can be executed using a Multifunction Object, but if an error occurs during execution or if the execution of the operation is cancelled, Multifunction Object processing is stopped.

In such cases, the functions set for execution after the cancelled function will not be executed.

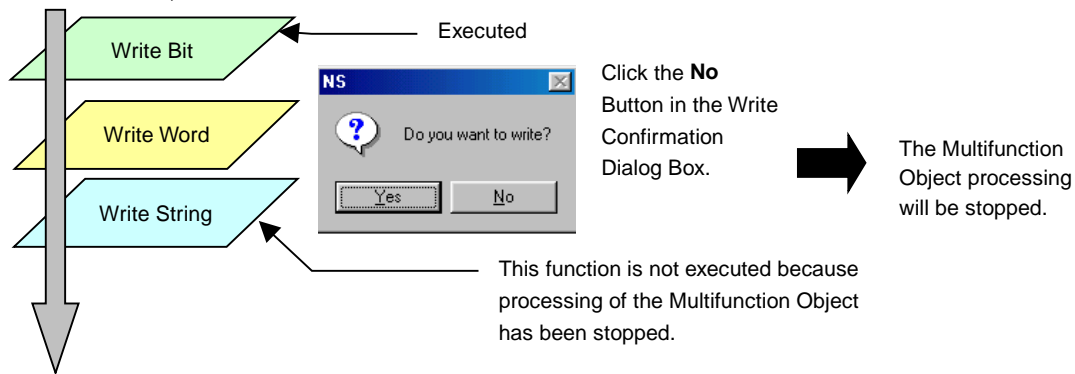

**Note**

- ◆ Refer to the previous section *Operations When Communications Errors Occur* for information on operations when a communications error occurs.
- ◆ Refer to the description of each function if Multifunction Object processing is stopped.

**NS Series Programming Manual**

**2-11-6 Converting from Other Objects to Multifunction Objects**

ON/OFF buttons, word buttons, command buttons, bit lamps, and word lamps can be converted to Multifunction Objects.

Converting objects is useful for applications such as keeping the original object settings and adding operations or converting lamps to buttons, etc.

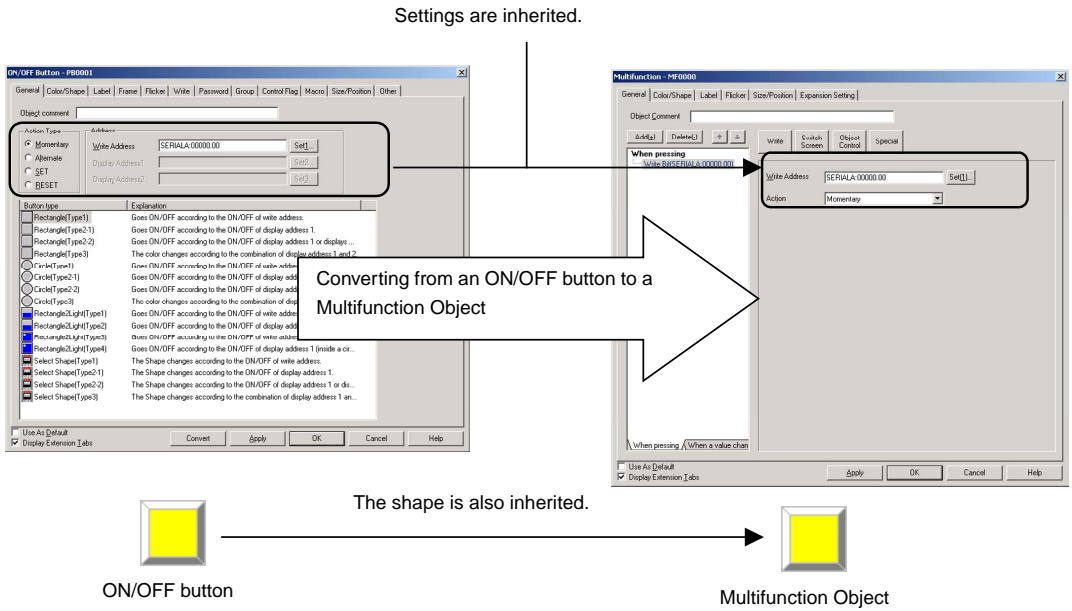

1. Open the Property Settings Dialog Box for the functional object to be converted to a Multifunction Object.
2. Click the **Convert** Button.

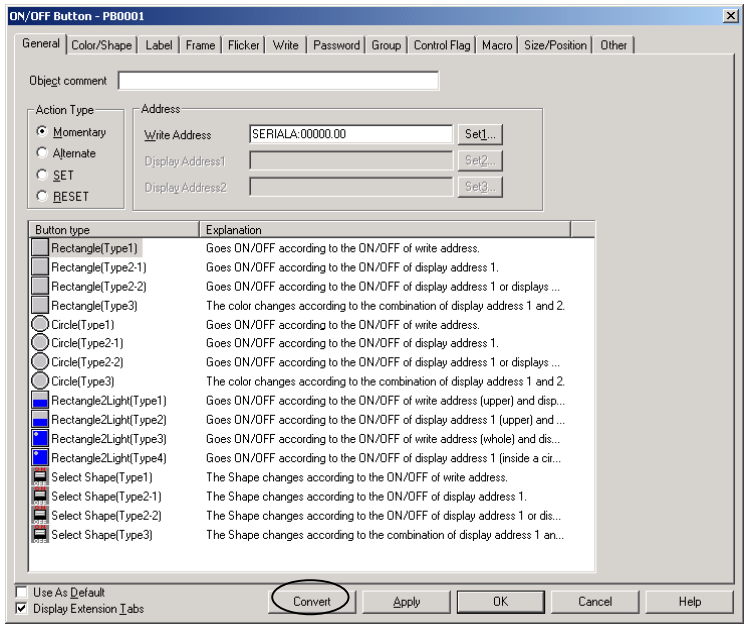

3. A confirmation message asking if it is OK to convert the object will be displayed. Click the **OK** Button to execute the conversion.
4. The functional object will be converted to a Multifunction Object and the Property Settings Dialog Box will be opened.

**Note**

- ◆ The settings for the functional object prior to conversion will be used for the Multifunction Object as is, except in the following cases.
  - Word lamps that fulfill all of the following conditions cannot be converted.
    - Switch label according to address value is selected.
    - A vector font is set.
    - There are two or more labels.
  - ON/OFF buttons and word buttons can be converted to Multifunction Objects with the write address field left blank, but the Write Bit and Write Word operations will not be set.
  - If a command button has None set when it is converted to a Multifunction Object, the None specification will not be set in the Multifunction Object property settings. All other settings will be converted as is for the Multifunction Object.
- ◆ ON/OFF buttons, word buttons, command buttons, bit lamps, and word lamps in tables cannot be converted to Multifunction Objects. Select **Functional Objects – Multifunction** or click the  icon to create a Multifunction Object.
- ◆ Even if the screen display is incomplete, such as when switching screens to a screen with a lot of functional objects, inputting to Multifunction Objects is possible by clicking the Multifunction Object position. In such cases, the functions will be executed once the screen display has been completed, so execution of the functions may take some time.
- ◆ ON/OFF buttons, word buttons, command buttons, bit lamps, and word lamps can be converted to Multifunction Objects.

**2-11-7 Functional Object Property Settings**

This section describes the setting items in the functional object property dialog box for Multifunction Objects.

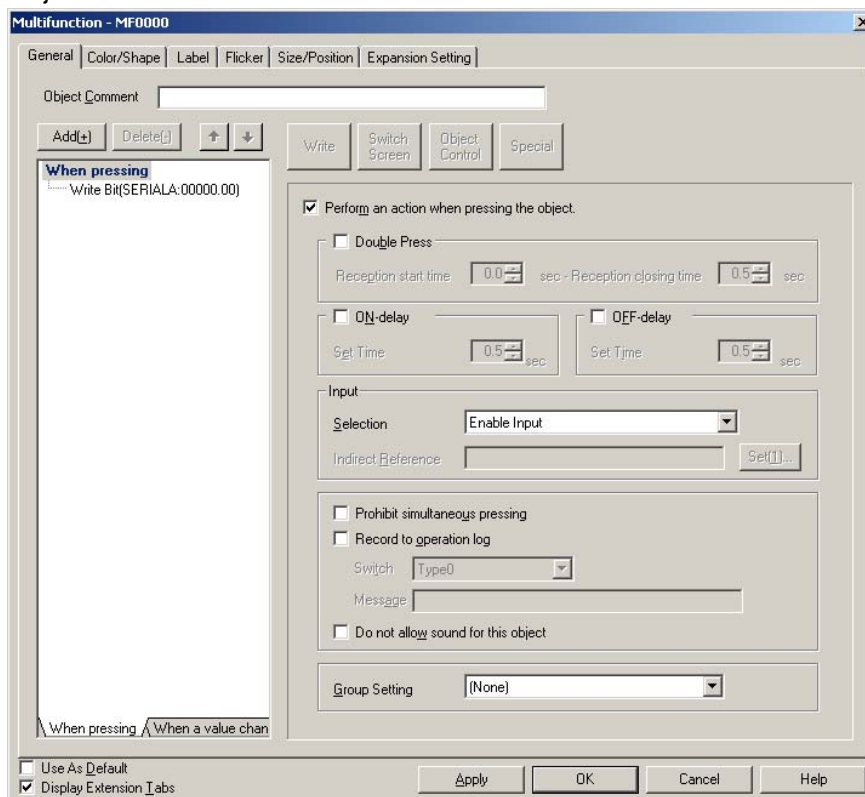

**NS Series Programming Manual**

- General : Sets the functions to be executed and the operation timing.
- Color/Shape : Sets the color and shape of the Multifunction Object.
- Label : Executes the label display contents.
- Flicker : Sets flicker display.  
(See note.)
- Size/Position : Sets the size and position of the object.  
(See note.)
- Expansion : Sets the operation options for function execution.  
Setting  
(See note.)

**Note:** The Flicker, Size/Position, and Expansion Setting Tabs are displayed when the *Display Extension Tabs* Checkbox is selected.

**General**

The General Tab Page is used to set the functions to be executed and the execution conditions for the Multifunction Object.

**Setting Execution Conditions**

The execution condition can be set to *When pressing* or to *When a value changed*.

If *When pressing* is selected, the operation will be executed when the Multifunction Object is pressed (for Touch ON timing). The timing for execution when *When pressing* is selected can be set to either Touch ON timing or Touch OFF timing.

If *When a value changed* is selected, the operation is executed when the value of a specified address changes.

**When Pressing**

1. Open the **When Pressing** Tab Page in the Action Item List.
2. Click *When pressing*.
3. Select the *Perform an action when pressing the object* Checkbox. (This checkbox is selected by default.)

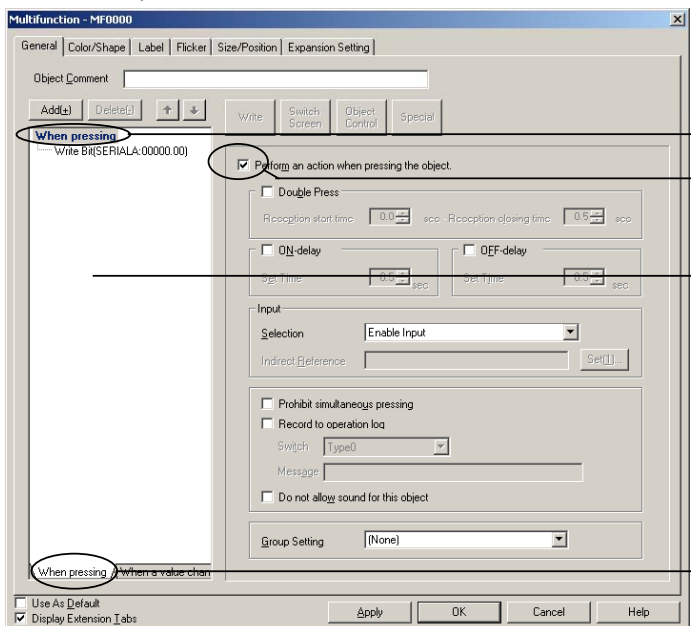

- 2. Select *When pressing*.
- 3. Select *Perform an action when pressing the object*.
- This area is called the Action Item List.
- 1. Select *When pressing*.

Make the following settings to further specify execution conditions to *Touch ON timing* or *Touch OFF timing*.



1. Move the mouse cursor to the Action Item List.
2. Right-click the mouse button and select **Display Touch ON/OFF Condition** from the pop-up menu that is displayed.



3. *Touch ON timing* and *Touch OFF timing* will be added to the action timing conditions.

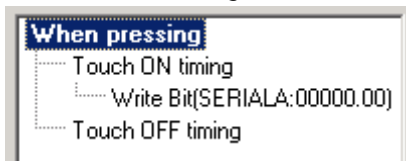

### Note

- ◆ If the execution conditions are changed to Display Touch ON/OFF Condition, the following functions will be set to Touch OFF timing.  
Switch Screen (if not set to Pop-up page selection.)  
Control Pop-up Screen  
Display System Menu  
Authentication Cancellation
- ◆ *Key Button and Video Control – Vision Sensor Console Output* can be set only for touch ON timing.

The settings for *When pressing* operation are outlined below.

NS Series Programming Manual

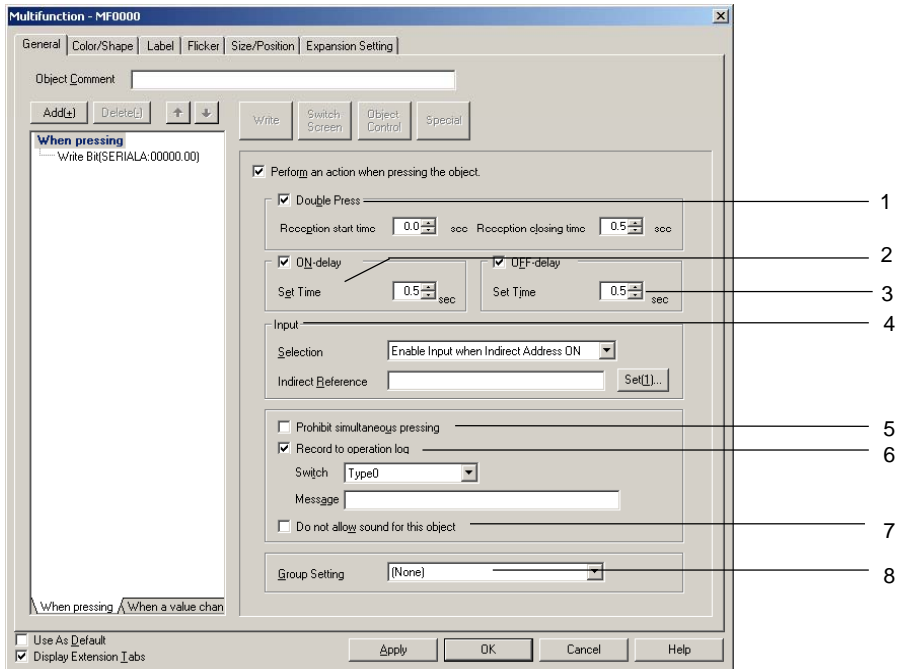

No.	Item	Details
1	Double Press	Executes the set functions when the Multifunction Object is pressed twice in a row. The <i>Reception start time</i> and <i>Reception closing time</i> can be set. The reception start time can be set to 0, 0.5, or between 1 and 15 seconds. The reception closing time can be set to 0.5 or between 1 and 30 seconds. Always set the reception closing time later than the reception start time.
2	ON Delay	The functions set for touch operation will be executed when the Multifunction Object is held down until the delay time passes. The <i>Set time</i> can be set to 0.5 or between 1 and 15 seconds.
3	OFF Delay	The functions set for execution at <i>Touch OFF timing</i> will be executed when the time specified under <i>Set time</i> has passed after the Multifunction Object is released. The <i>Set time</i> can be set to 0.5 or between 1 and 15 seconds.
4	Input	Used to specify whether or not inputs are accepted. This function can be used as an interlock function. The following selections are available. Enable input Disable input Enable Input When Indirect Address ON Enable Input When Indirect Address OFF If you select either <i>Enable Input When Indirect Address ON</i> or <i>Enable Input When Indirect Address OFF</i> , set the address for input control in the <i>Indirect Reference</i> field.
5	Prohibit simultaneous pressing	Select this checkbox to prohibit simultaneous pressing.
6	Record to operation log	Select this checkbox to keep a log of Multifunction Object operations. Set the message character string set in the operation log for each label to 32 characters or less.
7	Do not allow sound for this object	The touch switch input sound can be set separately to OFF so that the Multifunction Object will not produce a sound when operated. All object touch switch sounds will be OFF if the touch switch input sound is set to OFF under the NS System Menu or on the PT Tab Page of the CX Designer System Settings.

**NS Series Programming Manual**

No.	Item	Details
8	Group Setting	This function is enabled for Write Bit operations. This function ensures that there is only one communications address that is ON at a time for Multifunction Objects or ON/OFF buttons set in the same group in the same screen. (The communications address that was ON will be turned OFF.) If more than one Write Bit function is set for a Multifunction Object, all addresses set for those functions will turn ON. (If another object in the same group is pressed, all addresses will turn OFF.) Groups 1 to 16 can be selected. If no groups are to be specified, select <i>None</i> .

**When a Value Changed**

1. Open the When A Value Changed Tab Page in the Action Item List.
2. Click *When a value changed*.
3. Select the *Perform an action when a value changed* Checkbox. (This checkbox is OFF by default.)

1. Select *When a value changed*.

2. Select *When a value changed*.

3. Select *Perform an action when a value changed*.

4 to 7. Select the operation conditions.

4. Set the operation conditions for the following items.

No.	Item	Details
4	Address Type	Set the type of address to be monitored for value changes to either <i>Bit address</i> or <i>Word address</i> .
5	Address	Set the address to be monitored.
6	Execution Condition	Used to set the conditions under which the set functions will be executed, i.e., how the address value needs to change. Bit Addresses: <ul style="list-style-type: none"> <li>• Execute when ON/OFF</li> <li>• Execute when ON</li> <li>• Execute when OFF</li> </ul> Word Addresses: <ul style="list-style-type: none"> <li>• When an address value changed</li> <li>• Set Value = Address Value</li> <li>• Set Value != Address Value</li> <li>• Set Value &lt; Address Value</li> <li>• Set Value &lt;= Address Value</li> <li>• Set Value &gt; Address Value</li> <li>• Set Value &gt;= Address Value</li> </ul> The address value is compared with the numeric value stored in integer format.

**NS Series Programming Manual**

No.	Item	Details
7	Set Value	Set the set value if comparing a word address value with a set value. The set value can be set between -32,678 and 32,767.

**Setting the Functions To Be Executed**

More than one function can be executed at the same time when a Multifunction Object is used. Up to 32 functions can be executed for each of the *When pressing* and *When a value changed* Options.

Use the following procedure to set the functions to be executed. With the NS, the functions are executed in set order.

The following procedure describes the settings for the *When pressing* screen, but the settings are the same for the *When a value changed* screen.

1. Select the items for which functions are to be set from the Action Item List.
2. Select the functions to be set from the Action Item Selection Buttons.
3. Property settings for the selected function will be displayed. Make the required settings.
4. Click the **Add** Button to add functions to be executed.
5. Repeat steps 1 to 4 until all the settings have been made for the functions to be executed.
6. Click the **Delete** Button to remove set functions. Use the Up and Down Buttons to change the execution order.

The screenshot shows the 'Multifunction - MF0000' window with several tabs: General, Color/Shape, Label, Flicker, Size/Position, and Expansion Setting. The 'When pressing' section is active, showing a list of functions: Write B1(SERIALA:00000.00), Write B1(SERIALA:00000.00), Write String(SERIALA:00000), and Switch Screen(0000) Screen Page1. To the right, there are buttons for 'Write', 'Switch Screen', 'Object Control', and 'Special'. Below these are fields for 'Write Address' (SERIALA:00000.00) and 'Action' (Alternate). A list of functions is shown on the left, and a 'Set' button is next to the 'Write Address' field. Numbered callouts 1-6 point to these elements: 1 points to the function list, 2 to the 'Write' button, 3 to the 'Write Address' field, 4 to the 'Add' button, 5 to the 'Set' button, and 6 to the 'Delete' button. A large bracket on the right groups steps 1-5 and points to step 5: 'Repeat until all functions to be executed are set.'

**Note**

- ◆ The *Switch Screens*, *Control Pop-up Screen*, *Display System Menu*, *Authentication Cancellation*, and *Video Control – Video Capture* functions can be set only as the last function to be executed.
- ◆ The *Key Button* function cannot be set when *Touch OFF timing* is selected.
- ◆ When using *Video Control – Vision Sensor Console Output*, execute it as the last function for touch ON timing. It cannot be executed for *Touch OFF timing* or *When a value changed*.

**NS Series Programming Manual**

**Using Multifunction Objects as Buttons**

To use a Multifunction Object as a button, select the *Perform an action when pressing the object* Checkbox on the When Pressing Tab Page in the Action Item List.

The operation when the button is pressed is set in the Action Item List.

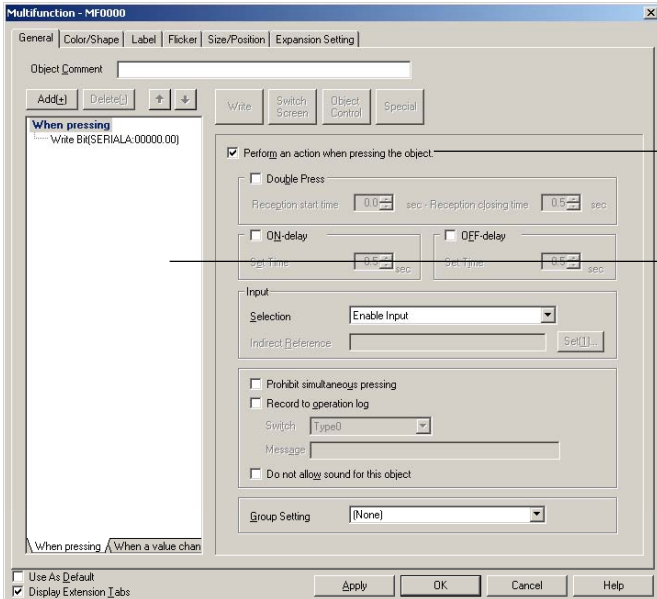

Select *Perform an action when pressing the object*.

Set the actions to be performed when the button is pressed.

**Using Multifunction Objects as Lamps**

To use a Multifunction Object as a lamp, clear the selection of the *Perform an action when pressing the object* Checkbox on the When Pressing Tab Page in the Action Item List.

The address to be monitored is set under *Display Address* on the Color/Shape Tab Page.

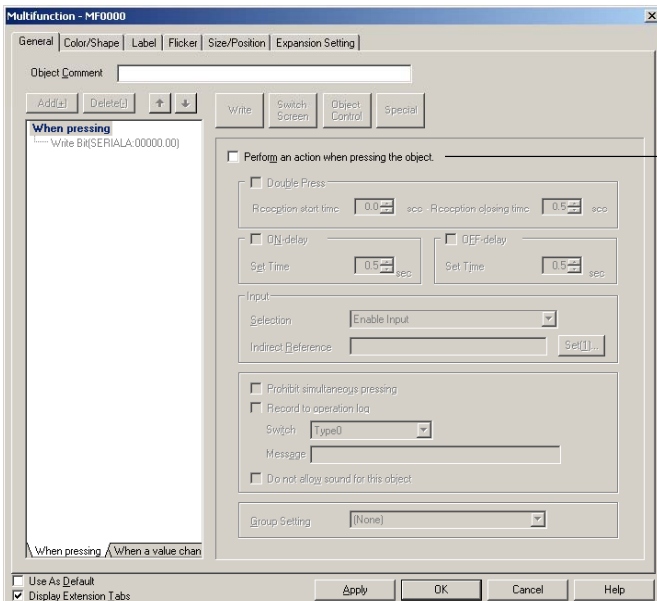

Clear the selection of *Perform an action when the object is pressed* Checkbox.

NS Series Programming Manual

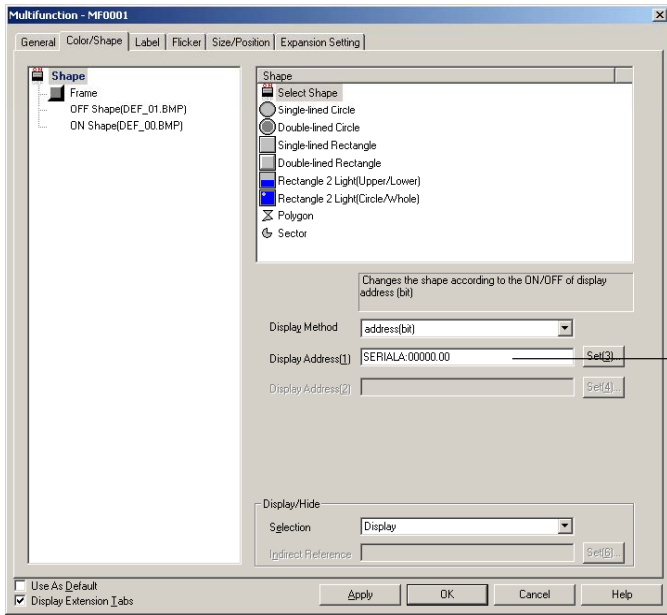

Set the address to be monitored.

Make the settings on the When a Value Changed Tab Page in the Action Item List to execute actions corresponding to bit lamp or word lamp *When a value changed* macros.

### 2-11-8 Detailed Settings for Each Function

#### Write Bit

The Write Bit function turns ON/OFF the specified communications address. Press the **Write** Button and select *Write Bit* from the list that is displayed.

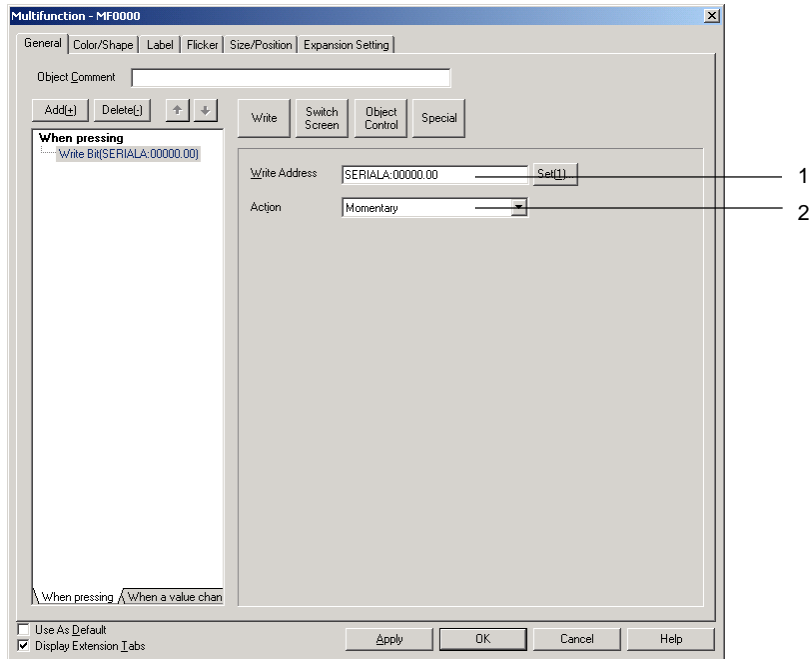

No.	Item	Details
1	Write Address	Used to set the bit address to be written to.
2	Action	Select the action from the following options: Momentary, Alternate, SET, and RESET. Momentary action cannot be set if the operation timing is set to <i>Touch OFF timing</i> or <i>When a Value Changed</i> .

#### Note

- ◆ The actions for the Momentary, Alternate, SET, RESET, and Group Setting are the same as ON/OFF Buttons.
- ◆ Group settings are enabled only when *Momentary*, *Alternate*, or *SET* button action is selected in the property settings. If the action type is set to *RESET*, the button will not operate according to group settings.
- ◆ If the button is set to *Alternate* and is pressed when ON, the button will turn OFF.
- ◆ This function is different from the group function executed by selecting **Edit – Group – Group** from the menu bar or right-clicking and selecting **Group** from the pop-up menu.
- ◆ Set the same host address to buttons with the same group number. The buttons will not operate normally if different host addresses are allocated.

**NS Series Programming Manual**

**Write Word**

The Write Word function changes the value at a specified address. Press the **Write** Button and select *Write Word* from the list that is displayed.

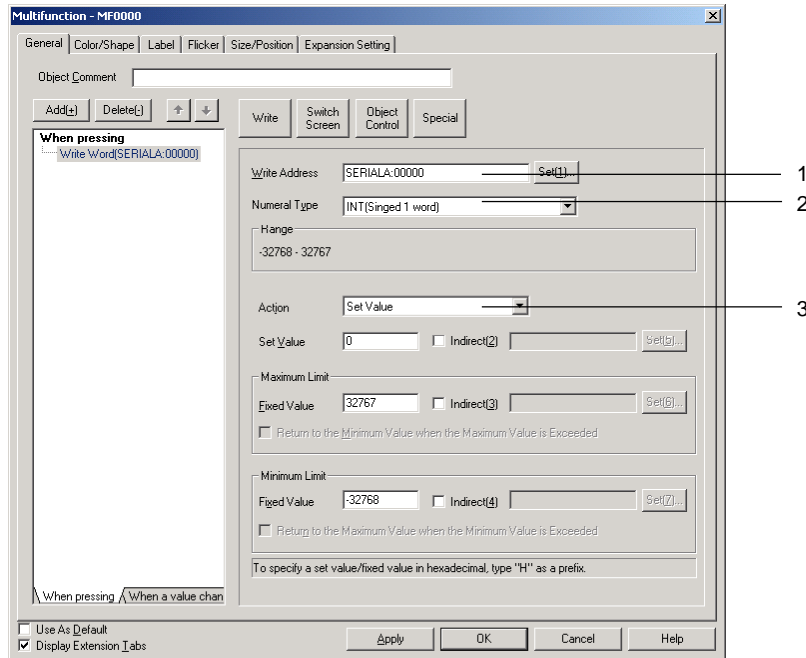

No.	Item	Details
1	Write Address	Used to set the word address to be written to.
2	Numeral Type	Select the write format for the numeral when the Multifunction Object is pressed from the following eleven types. Refer to <i>Numeral Display and Storage Type</i> in 2-8 <i>Common Functional Object Functions</i> for details on numeral storage types. <ul style="list-style-type: none"> <li>• INT (signed, 1 word)</li> <li>• UINT (unsigned, 1 word)</li> <li>• DINT (signed, 2 words)</li> <li>• UDINT (unsigned, 2 words)</li> <li>• REAL (real number)</li> <li>• BCD2 (unsigned, 1 word)</li> <li>• BCD2 (unsigned, 2 words)</li> <li>• BCD1 (signed (leftmost digit: F), 1 word)</li> <li>• BCD1 (signed (leftmost digit: F), 2 words)</li> <li>• BCD2 (signed (leftmost bit: 1), 1 word)</li> <li>• BCD2 (signed (leftmost bit: 1), 2 words)</li> </ul>
3	Action	Set one of the following types of action. <ul style="list-style-type: none"> <li>• Set Value</li> <li>• Increment/decrement</li> <li>• Display Pop-up Menu</li> <li>• AND</li> <li>• OR</li> <li>• XOR</li> </ul> The setting items depend on the selected action.



NS Series Programming Manual

### Set Value

The Set Value action sets the write address to a set value.

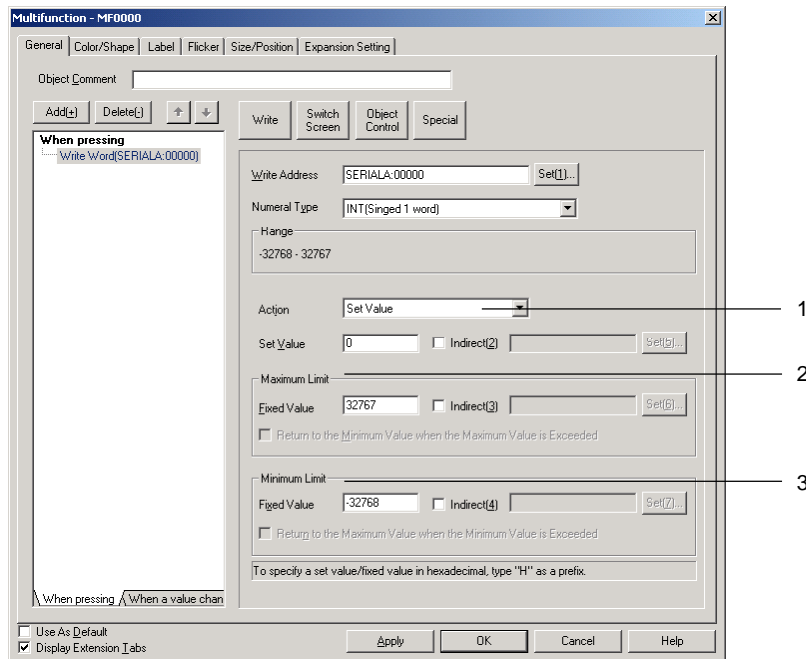

No.	Item	Details
1	Set Value	Sets a set value to be written to the write address. When indirect specification is selected, the contents of the set address are written.
2	Maximum Limit	Sets the maximum limit. Either a fixed value or indirect specification can be selected.
3	Minimum Limit	Sets the minimum limit. Either a fixed value or indirect specification can be selected.

### Increment/Decrement

When the button is pressed, the contents of the address are incremented or decremented and set.

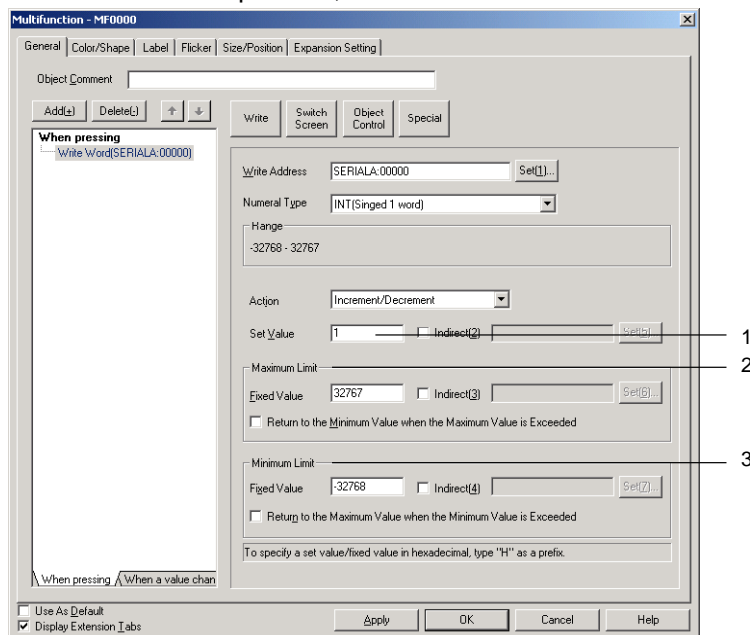

**NS Series Programming Manual**

No.	Item	Details
1	Set Value	<p>Sets the value by which the contents of the address are to be incremented or decremented.</p> <p>Example: If <i>Increment/decrement</i> is set to "10," the contents of the address will increase by 10 each time the button is pressed. If <i>Increment/decrement</i> is set to "-10," the contents of the address will decrease by 10 each time the button is pressed.</p> <p>When indirect specification is selected, the contents of the set address becomes the increment/decrement value.</p>
2	Maximum Limit	<p>Sets the maximum limit. Either a fixed value or indirect specification can be selected. If <i>Return to the Minimum Value when the Maximum Value is Exceeded</i> is selected, the value will return to and be set to the minimum value when the maximum value is exceeded.</p> <p>Example for a Maximum Limit of 1,000, Minimum Limit of 0, and Increment/Decrement of 5:</p> <p>If the present value is 998 and <i>Increment/decrement</i> is executed, the present value will remain unchanged at 998 if the <i>Return to Minimum Value when the Maximum Value is Exceeded</i> Checkbox is not selected.</p> <p>If, however, the <i>Return to Minimum Value when the Maximum Value is Exceeded</i> Checkbox is selected, 0 will be written to the address.</p>
3	Minimum Limit	<p>Sets the minimum limit. Either a fixed value or indirect specification can be selected. If <i>Return to the Maximum Value when the Minimum Value is Exceeded</i> is selected, the value will return to and be set as the maximum value when the minimum value is exceeded.</p> <p>Example for a Maximum Limit of 1,000, Minimum Limit of 0, and Increment/Decrement of -5:</p> <p>If the present value is 3 and <i>Increment/decrement</i> is executed, the present value will remain unchanged at 3 if the <i>Return to Maximum Value when the Minimum Value is Exceeded</i> Checkbox is not selected.</p> <p>If, however, the <i>Return to Maximum Value when the Minimum Value is Exceeded</i> Checkbox is selected, 1000 will be written to the address.</p>

**Display Pop-up Menu**

When the button is pressed, a pop-up menu will be displayed and the write value can be selected from the menu. As many pop-up menus as there are label switches can be set. If labels are switched during NS operations, the displayed pop-up menu will also change. Up to 32 items can be set on pop-up menus.

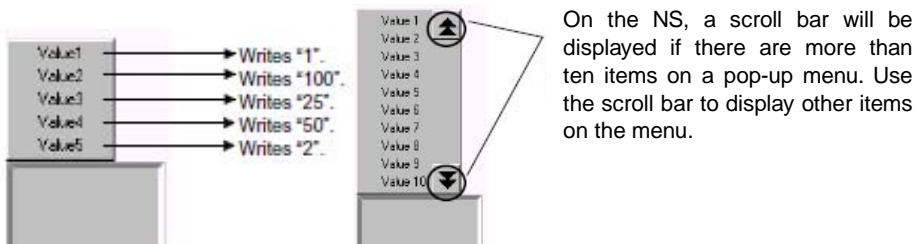

**NS Series Programming Manual**

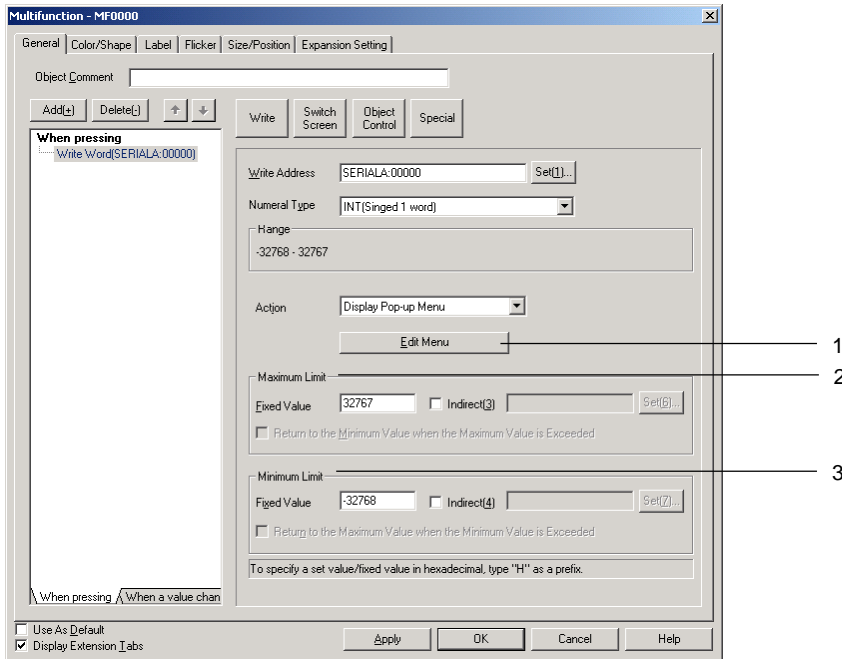

No.	Item	Details
1	Edit Menu	Displays the Pop-up Setting Dialog Box.
2	Maximum Limit	Sets the maximum limit. Either a fixed value or indirect specification can be selected.
3	Minimum Limit	Sets the minimum limit. Either a fixed value or indirect specification can be selected.

**Editing Pop-up Menus**

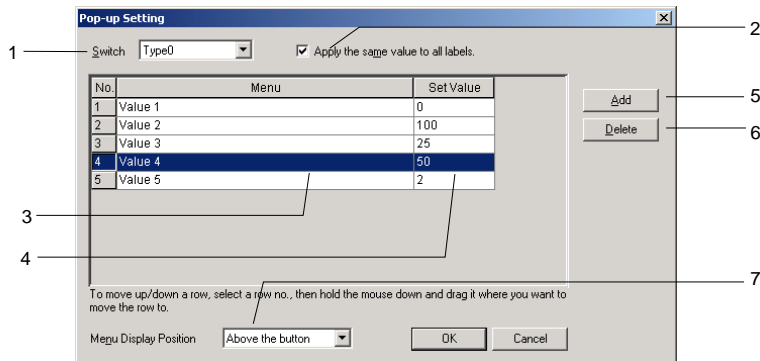

No.	Item	Details
1	Switch	Switches labels.
2	Apply the same value to all labels	Applies the same set value to all labels.
3	Menu list	Sets the heading name displayed in a pop-up menu. The name can be up to 64 characters long.
4	Set Value	Specifies the value that will be written to the communications address when the corresponding menu item is selected.
5	Add	Adds a menu item below the currently selected row. If there is no row selected, a new row is added to the bottom of the list.
6	Delete	Deletes the currently selected menu item.

**NS Series Programming Manual**

No.	Item	Details
7	Menu display position	Sets one of the following display positions for the pop-up menu. Above the button Below the button

**Note**

- ◆ When a row has been selected by clicking the row number, the row can be dragged and dropped in another location to change its order in the list.

**AND/OR/XOR**

When the button is pressed, AND, OR, or XOR calculations are applied to the Set Value and the write address value and the write address is set to the result.

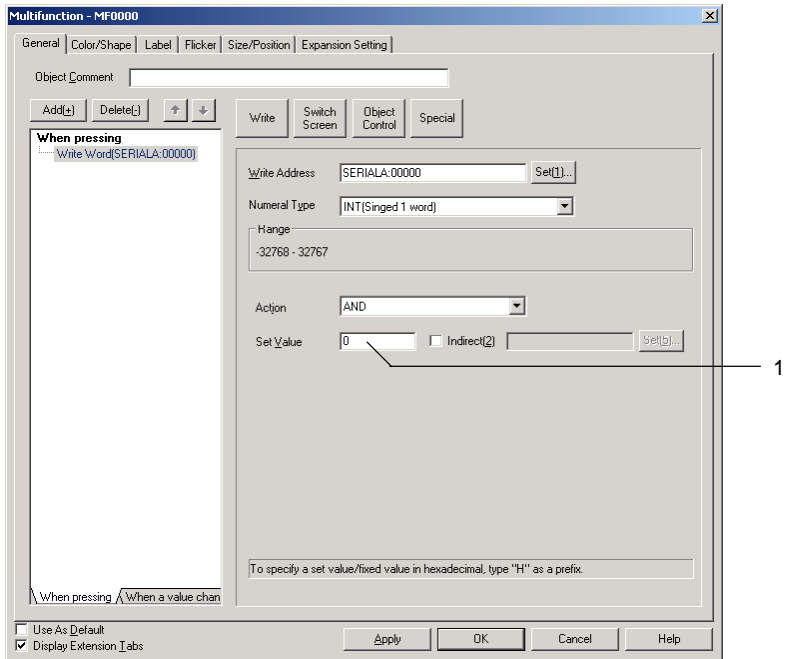

No.	Item	Details
1	Set Value	Sets the value to be used in the equation. When indirect specification is selected, the contents of the set address becomes the set value.

### Write String

Sets a character string in a specified communications address. The string can be up to 256 characters long.

Press the Write Button and select *Write String* from the list that is displayed.

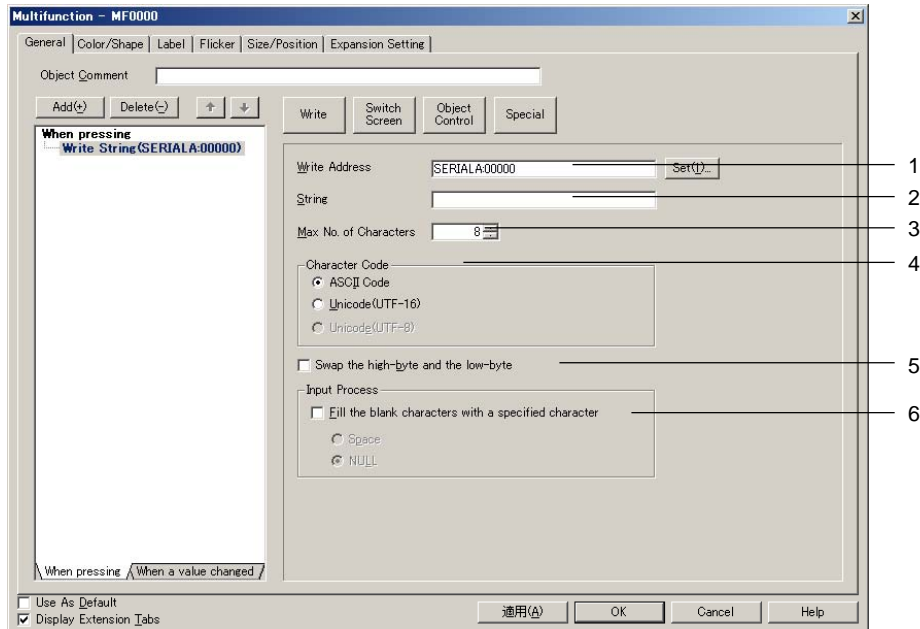

No.	Item	Details
1	Write Address	Sets the communications address to be written to. The character string is written to consecutive addresses starting with the set communications address, according to the number of characters and the character code.
2	String	Specifies the character string to be written. The string can be up to 256 characters long.
3	Max. No. of Characters	Sets the number of characters to be written (1 to 256).
4	Character Code	Select either ASCII or Unicode (UTF-16) for the character code.
5	Swap the high-byte and the low-byte	Swaps the higher bytes and lower bytes in the string and writes the result to the communications address.
6	Fill the blank characters with a specified character	If this option is selected, spaces or null characters are automatically added to the end of strings to fill the space if the number of input characters is less than the set number of characters. For example, if the number of characters has been set to 8 and only the 5 characters ABCDE are input, then 3 spaces will be added: ABCDE□□□□ (□ indicates a space.)  If this option is not selected, all characters up to the null character at the end of the string will be written to the specified address. For example, if the string already set to the address is ABCDEFG, when A is written to the address, 0 will be written in the place of B, and C and the other characters will not be written. The data is written in word format, so when the string AB is written in ASCII, CD will be 0.

**Note**

- ◆ If the number of characters or the address is set too high, the maximum address for the specified area may be exceeded, e.g., when the number of words is 256 and the write address is \$W32767. If the maximum address in an area is exceeded, a communications error will occur when the screen to which the string display and input object is set is opened on the NS. Make sure the maximum address is not exceeded.
- ◆ If ASCII characters are set in string displays, the following character codes will be used by the NS depending on the system language that has been set.

System language	Character display	Example (character code B5)
Japanese	Shift-JIS code	↑
Chinese (traditional or simplified)	GB2312 code	Nothing is displayed because there are no corresponding characters.
Other	Latin 1 code	μ

**Switch Screen**

Switches to the specified screen when the button is pressed. Press the Switch Screen Button and select Switch Screen from the list that is displayed.

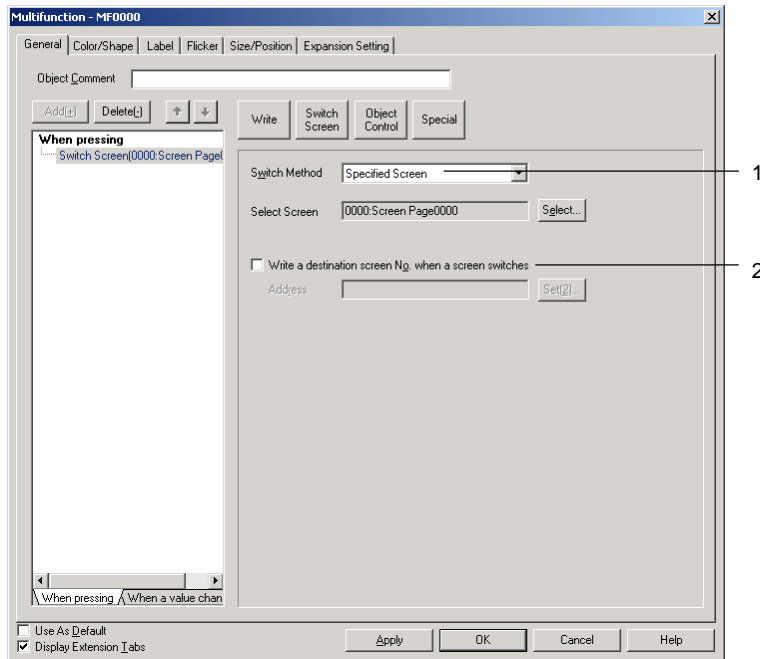

NS Series Programming Manual

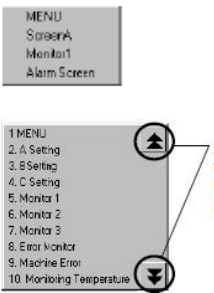
No.	Item	Details
1	Switch Method	Selects the method for switching screens. The setting items depend on the selected method.
	Specified Screen	Switches to a specified screen. Press the <b>Select</b> Button and select the destination screen from the Screen List Dialog Box that is displayed.
	Indirect Specification of Screen No.	Reads the contents of a specified address as the page number and switches to that specified screen page number. The data format for the value set for the communications address can be selected as either BCD or binary. Select the data format under <b>PT – Project Properties</b> .
	Selection by Pop-up Menu	<p>Displays a pop-up menu for screen selection. (Up to 32 items of up to 64 characters each). The display position of the pop-up menu can be specified to be above or below the button.</p>  <p>At the PT, a scroll bar will be displayed if there are more than ten items on a pop-up menu, as shown on the left. Use the scroll bar to display other items on the menu.</p> <p>Pop-up menu settings are made in the Pop-up Setting Dialog Box displayed when the Register Button is pressed.</p>
	Backward	The last 32 page switching operations are recorded and the pages can be returned based on this record. Switches to pop-up screens cannot be recorded.
	Forward	If the <i>Backward</i> function has been used to go back to previous pages, the <i>Forward</i> function can be used to move ahead to later pages.
	Next Page	Displays the screen with the next page number.
	Previous Page	Displays the screen with the previous page number.
2	Write a destination screen No. when a screen switches	The destination screen number can be written to a specified address when screens are switched.

### Specified Screen

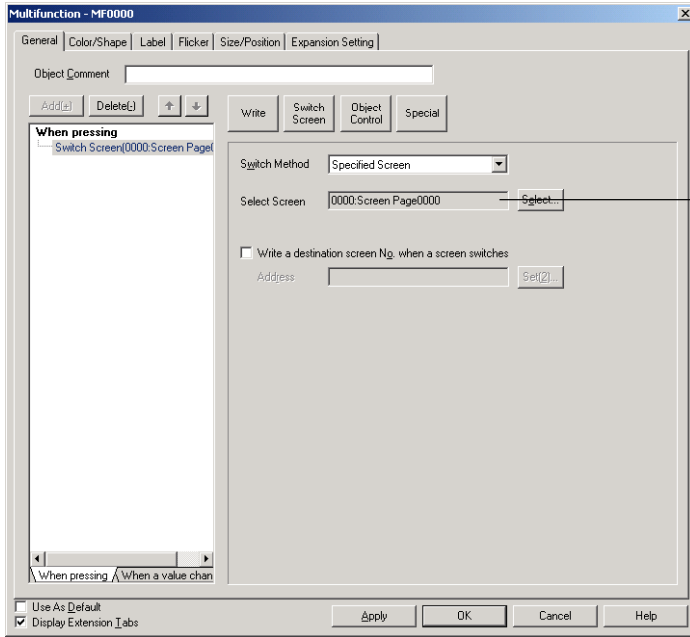

Specifies the destination screen.

### Indirect Specification of Screen Numbers

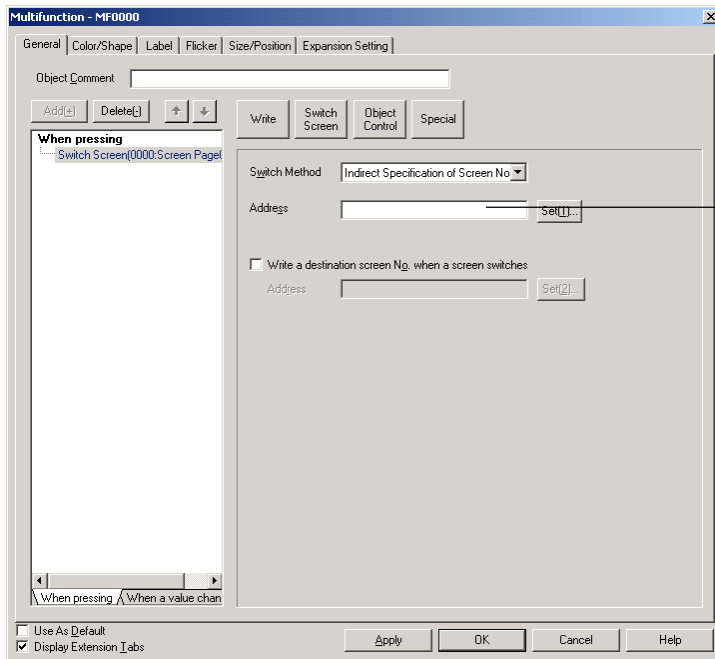

Sets the communications address that specifies the destination screen number.



### Selection by Pop-up Menu

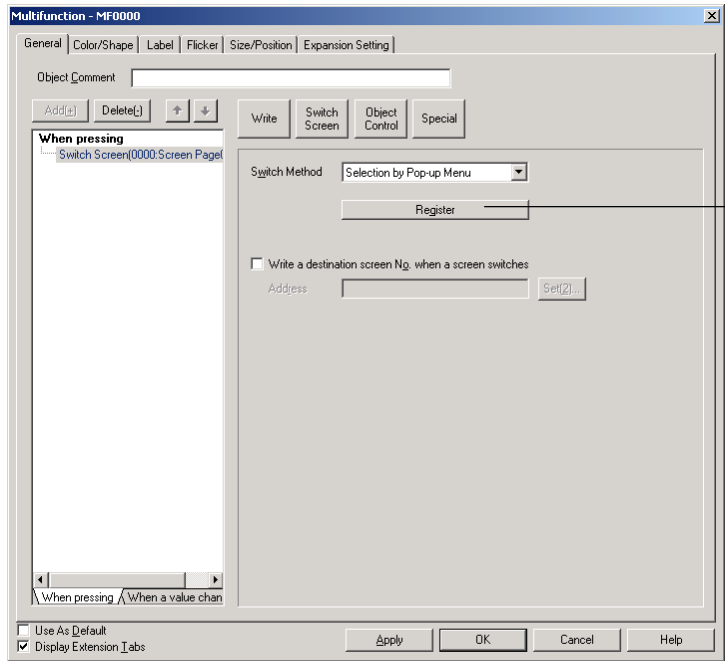

Registers pop-up menus.

There are no settings to be made for *Backward*, *Forward*, *Next Page*, or *Previous Page*.

### Control Pop-up Screen

*Control Pop-up Screen* controls the pop-up screen specified for display when a button is pressed.

Click the **Switch Screen** Button and select *Control Pop-up Screen* from the list that is displayed.

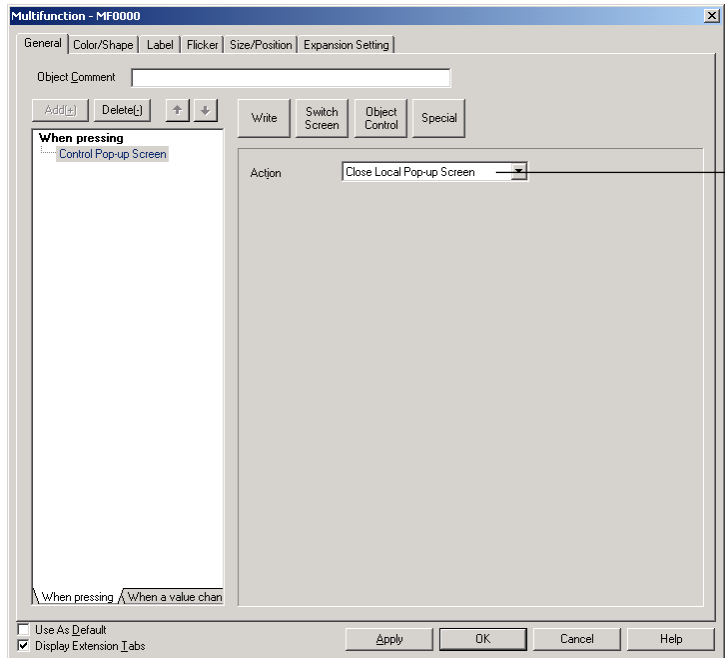

1

No.	Item	Details
1	Action	Set one of the following types of action. The setting items depend on the selected method.
	Close Local Pop-up Screen	Closes the currently displayed pop-up screen using a Multifunction Object in the same screen.
	Close Specified Pop-up Screen	Closes a specified pop-up screen. Use the <b>Select</b> Button to specify the pop-up screen to be closed. The current screen as well as other pop-up screens can be specified using this option.
	Move Local Pop-up Screen	Moves the pop-up screen after the Multifunction Object functions have been executed to any position pressed on the screen.

**Close Specified Pop-up Screen**

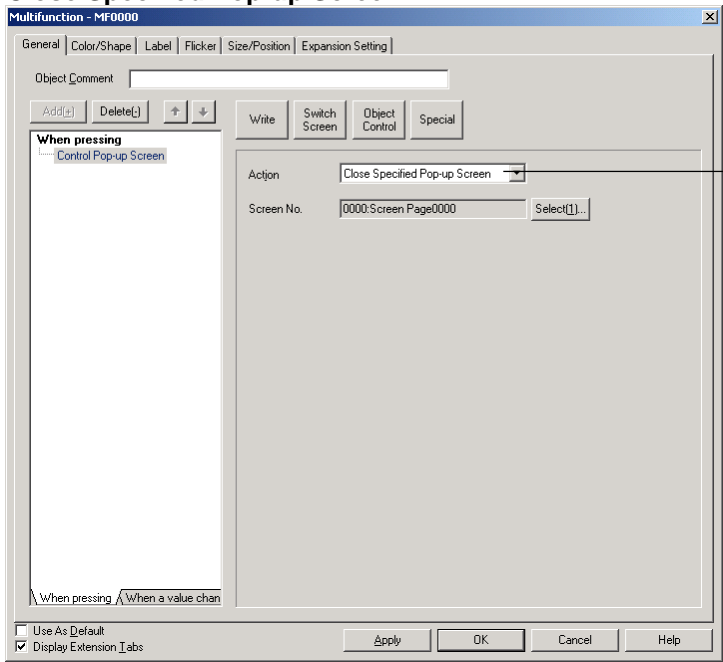

Select Close Specified Pop-up Screen.

There are no settings to be made for Close Local Pop-up Screen or Move Local Pop-up Screen.

**Note**

- ◆ If pop-up screens are controlled (e.g., moved or closed) frequently, the display update may take some time and communications may be delayed.
- ◆ If the screen specified under *Close Local Pop-up Screen*, *Close Specified Pop-up Screen*, or *Move Local Pop-up Screen* is a base screen, the Multifunction Object will be disabled while the NS is operating.
- ◆ When moving pop-up screens using *Move Local Pop-up Screen*, the position touched on the screen after the Multifunction Object is executed will become the top left corner of the new position for the pop-up screen.

**Display System Menu**

The Display System Menu function is used to display the System Menu and start external applications. Click the **Switch Screen** Button and select *Display System Menu* from the list that is displayed.

**NS Series Programming Manual**

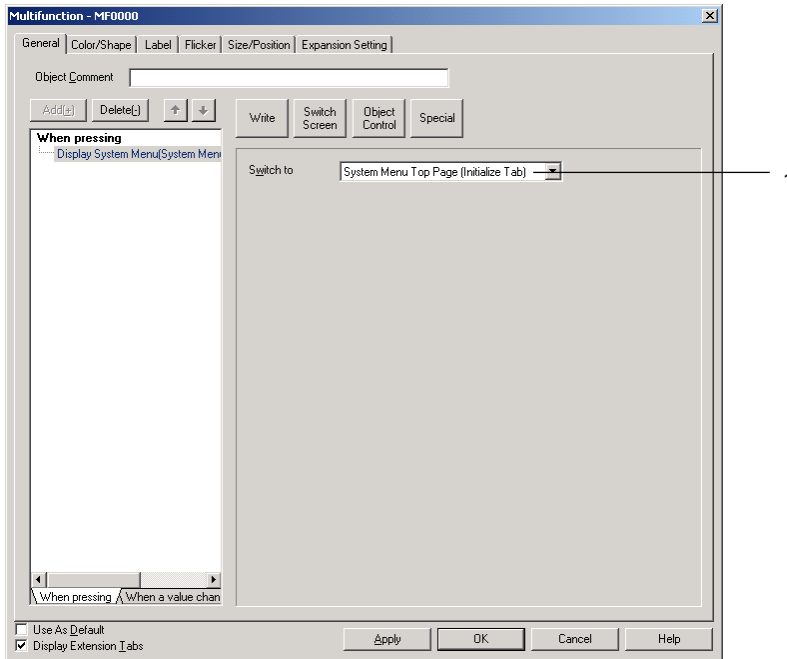

No.	Item	Details
1	Switch to	<p>Selects the switch destination.</p> <ul style="list-style-type: none"> <li>• System Menu Top Page (Initialize Tab)</li> <li>• Switch Box Functions</li> <li>• Display Capture Data</li> <li>• Ladder Monitor</li> <li>• Programming Console (CS Series)</li> <li>• Programming Console (C Series)</li> <li>• PLC Data Trace</li> <li>• Troubleshooting (Only if the NSJ Series is selected as the model.)</li> <li>• Operation log (sort by occurrence)</li> <li>• Operation log (sort by frequency)</li> </ul>

**Note**

- ◆ If the model is NS5, the System Menu top page will be displayed if a Multifunction Object set to *System Menu Top Page (initialize Tab)* is executed.
- ◆ When the Ladder Monitor starts, communications addresses set for alarms and events can be automatically searched for. Refer to 2-14-4 *Searching for Alarms and Events with Ladder Monitor*.

**NS Series Programming Manual**

**Key Buttons**

A Key Button is an object that transmits a specified character code to the functional object in focus. Press the **Object Control** Button and select *Key Button* from the list that is displayed.

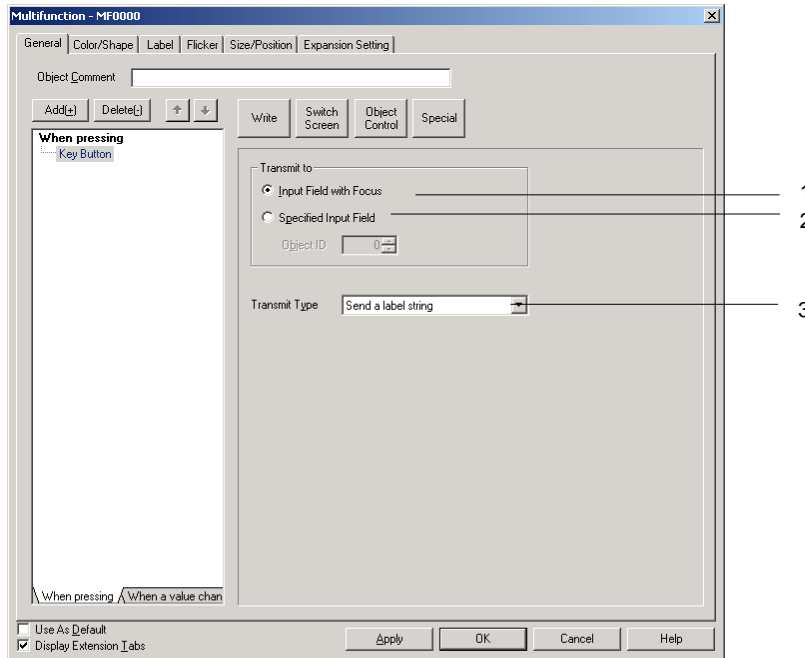

No.	Item	Details
1	Input Field with Focus	Transmits the character string to the input field ( <i>Numeral display and input or String display and input</i> ) that is in focus.
2	Specified Input Field	Sets functional object ID numbers when transmitting to a specific functional object. (See note 1.)
3	Transmit Type	Select one of the following transmission character codes. <ul style="list-style-type: none"> <li>• Send a label string.</li> <li>• Send a control code.</li> <li>• Send a special character string.</li> <li>• Indirectly specify and send a special character string.</li> </ul> The setting items depend on the selected transmission type.

**Note:** A functional object on the base screen or pop-up screen must be set as the destination. The destination cannot be a functional object on a different screen, e.g., a functional object on the base screen cannot be used as the destination from a pop-up screen. Functional objects on sheets also cannot be used as the destination. When creating a Multifunction Object on a sheet, the destination must be a functional object with a specified ID number on a base screen or pop-up screen using that sheet.

**Note**

- ◆ Multifunction Object processing will be canceled in the following cases.
  - When a Multifunction Object set to transmit to the *Input Field with Focus* is executed but there is no object with the focus.
  - When a Multifunction Object set to transmit to the *Specified Input Field* is executed but no object ID has been specified.

**Send a Label String**

Sends the character codes for the characters set for the Multifunction Object label. A string of up to 256 characters long can be sent. There are no settings required for this function.

**NS Series Programming Manual**

**Send a Control Code**

Sends the specified control code.

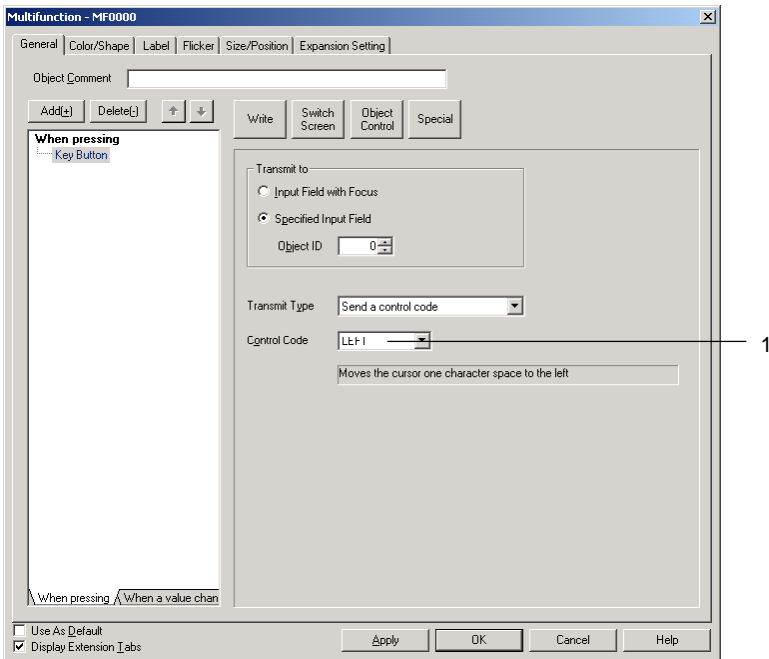

No.	Item	Details
1	Control Code	Select the control code to be sent. Refer to 2-9-3 <i>Command Buttons</i> for information on control codes.

**Send a Specified String**

Sends the character codes for a specified string (up to 256 characters).

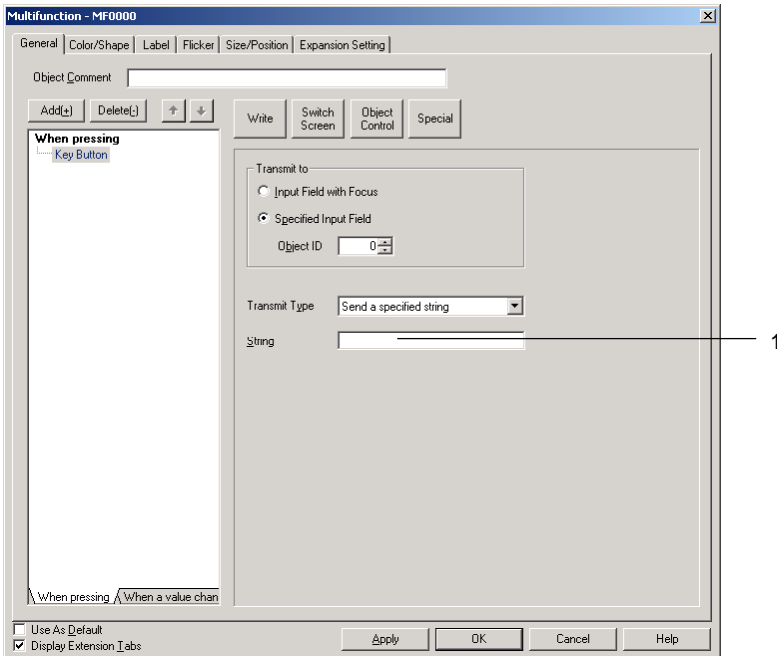

No.	Item	Details
1	String	Specifies the character string to be sent (up to 256 characters).

**NS Series Programming Manual**

**Indirect Specification of String**

Sends the string data stored at a specified communications address.

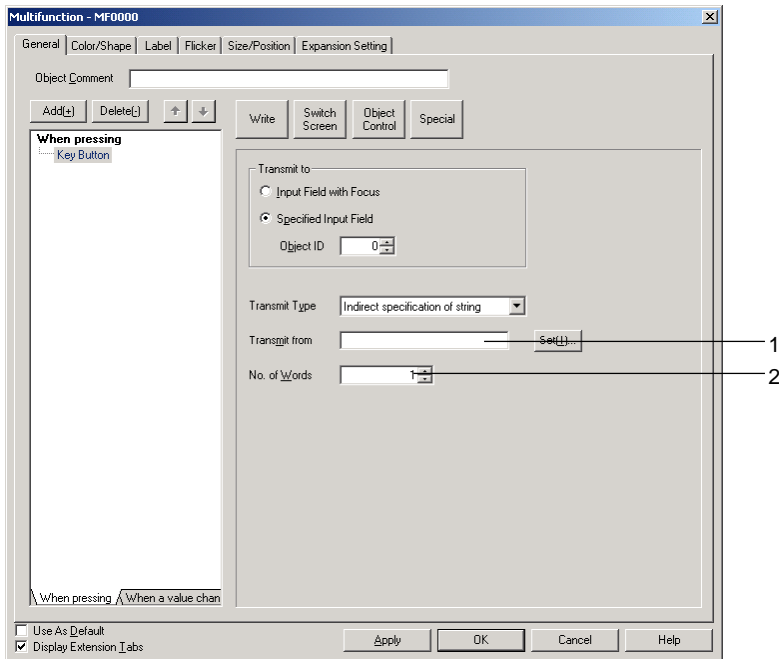

No.	Item	Details
1	Transmit from	Specifies the communications address at which the send string is stored.
2	No. of Words	Transmits the specified number of words as the data.

**Note**

- ◆ Functional object ID numbers can be checked by selecting **View – Show ID** (click on *Show ID*) or opening the Functional Object Properties Dialog Box.



Specify the 4-digit number displayed here if using *Specified Input Field* to specify the ID number. (In the above example, “7” is specified.)

Refer to *Create Screens* in the *CX-Designer Online Help* for information on ID displays.

- ◆ Set *Input Field with Focus* to transmit to other screens. Data cannot be transmitted even if the ID number is set under *Specified Input Field*.
- ◆ A backslash will be sent if a yen symbol is specified as one of the characters to be sent.
- ◆ Focus is not moved to input-prohibited objects for focus control codes.
- ◆ If there are two input objects at an equal distance from the current object, the focus will move to the object created first on the CX-Designer.

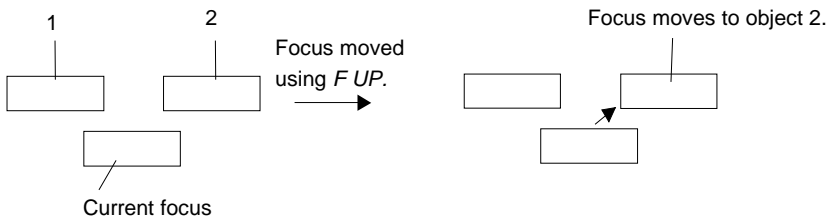

In this example, it is assumed that object 2 is created earlier than object 1 on CX- Designer.

- ◆ Press a functional object other than a Command Button to which *Key Button* is set to remove focus from numeral display and input objects and string display and input objects.
- ◆ To use *S PAGEUP*, *S PAGEDOWN*, *S LINEUP* or *S LINEDOWN*, select *Specified Input Field* as the *Transmit to* Option and specify the ID number for list selection.

**NS Series Programming Manual**

**Data Block Control**

This function operates on data blocks. When a button is pressed, CSV file data is transferred to the specified addresses in the PLC or the data from specified addresses in the PLC is transferred to the specified record in the CSV file.

Click the **Object Control** Button and select *Data Block Control* from the list that is displayed.

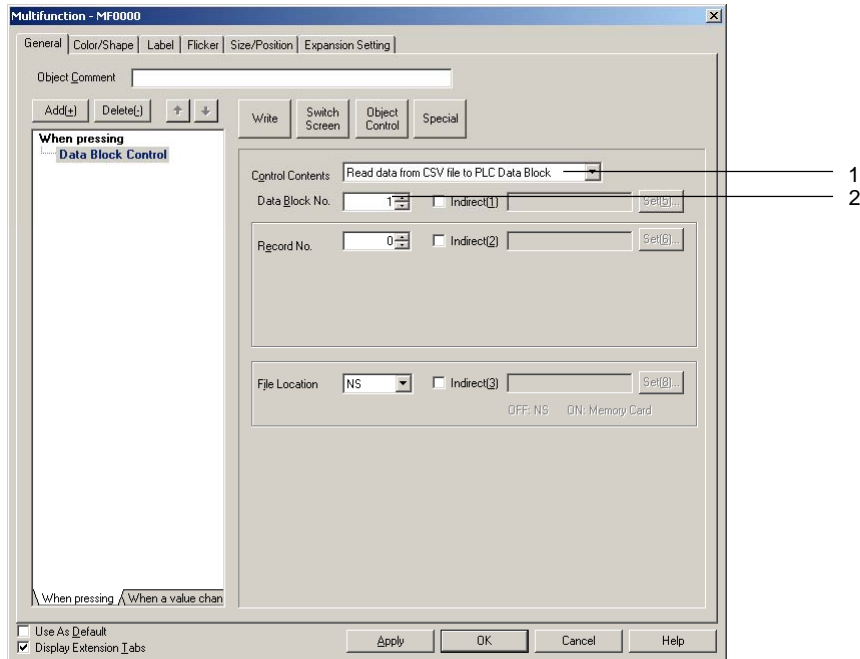

No.	Item	Details
1	Control Content	Select one of the following control operations. <ul style="list-style-type: none"> <li>• Read data from CSV file to PLC Data Block</li> <li>• Write data from PLC Data Block to CSV file</li> <li>• Read data from CSV file to NS</li> <li>• Write data from NS to CSV file</li> <li>• Read data from NS to PLC Data Block</li> <li>• Write data from PLC Data Block to NS</li> <li>• Read record label</li> <li>• Delete record</li> </ul> The setting items depend on the selected control operation.
2	Data Block No.	Specifies the data block group number (1 to 100) for the control operation. The group number can be set indirectly through a communications address by selecting the <i>Indirect</i> Option.

**Note**

- ◆ Multifunction Object processing will be canceled in the following cases.
  - If the specified data block group does not exist.
  - If the specified record does not exist.



**NS Series Programming Manual**

**Read Data from CSV File to PLC Data Block**

Reads the data from the specified record in the CSV file to the specified address set in each field.

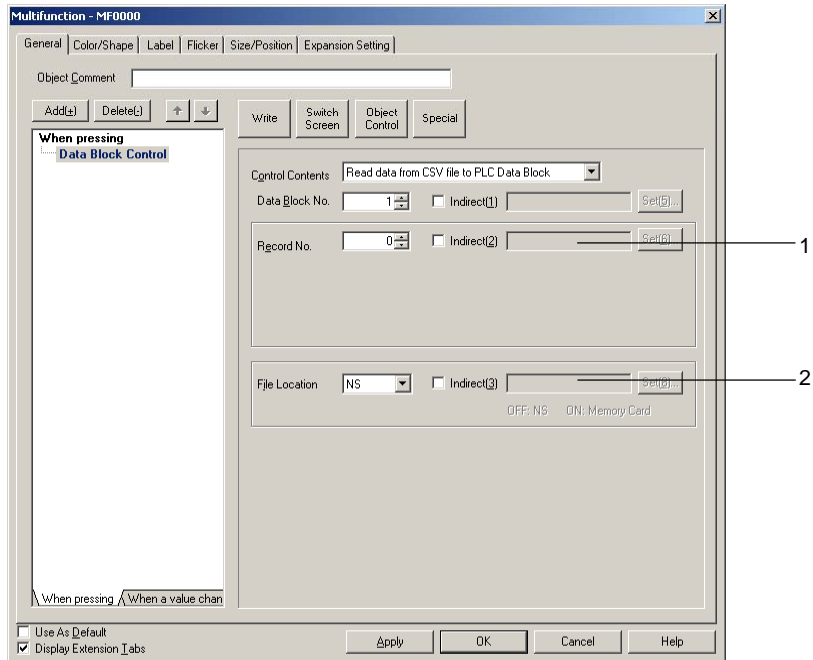

No.	Item	Details
1	Record No.	Specifies the record number in the CSV file (0 to 999) to use in the control operation. The record number can be set indirectly through a communications address by selecting the <i>Indirect</i> Option.
2	File Location	Specifies either the NS or the Memory Card as the location of the CSV file. The file location can be set indirectly by selecting the <i>Indirect</i> Option. If the specified address is 0, the NS will be used. If the specified address is 1, the Memory Card will be used.

**NS Series Programming Manual**

**Write Data from PLC Data Block to CSV File**

Transfers the data from the specified addresses in the PLC Data Block set in each field to the specified record in the CSV file.

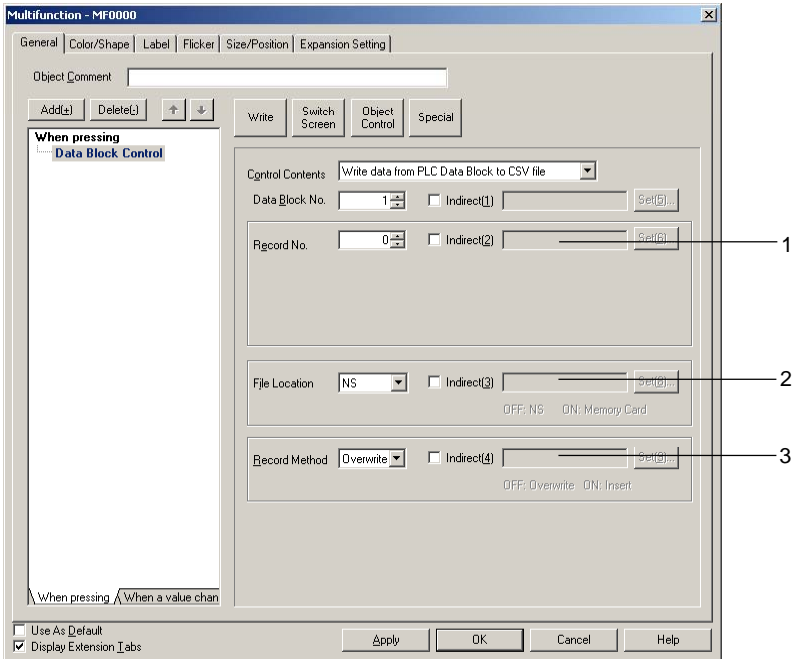

No.	Item	Details
1	Record No.	Specifies the record number in the CSV file (0 to 999) to use in the control operation. The record number can be set indirectly through a communications address by selecting the <i>Indirect</i> Option.
2	File Location	Specifies either the NS or the Memory Card as the location of the CSV file. The file location can be set indirectly by selecting the <i>Indirect</i> Option. If the specified address is 0, the NS will be used. If the specified address is 1, the Memory Card will be used.
3	Record Method	The data at the specified record can be overwritten or it can be inserted at the specified record number. The record method can be set indirectly by selecting the <i>Indirect</i> Option. If the specified address is 0, the data will be overwritten. If the specified address is 1, the data will be inserted.

**NS Series Programming Manual**

**Read Data from CSV File to NS**

Reads the data from the specified record in the CSV file to the specified NS address.

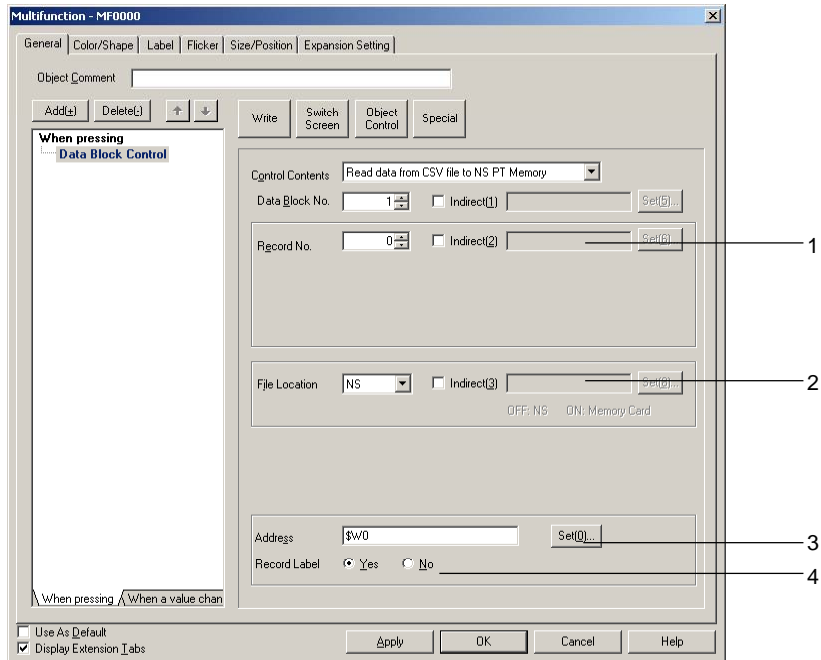

No.	Item	Details
1	Record No.	Specifies the record number in the CSV file (0 to 999) to use in the control operation. The record number can be set indirectly through a communications address by selecting the <i>Indirect</i> Option.
2	File Location	Specifies either the NS or the Memory Card as the location of the CSV file. The file location can be set indirectly by selecting the <i>Indirect</i> Option. If the specified address is 0, the NS will be used. If the specified address is 1, the Memory Card will be used.
3	Address	Specifies the communications address for storing the CSV file data.
4	Record Label	Specifies whether to include the record label when reading.

**NS Series Programming Manual**

**Write Data from NS to CSV File**

Transfers one record of data from the specified addresses in the NS to the specified record in the CSV file.

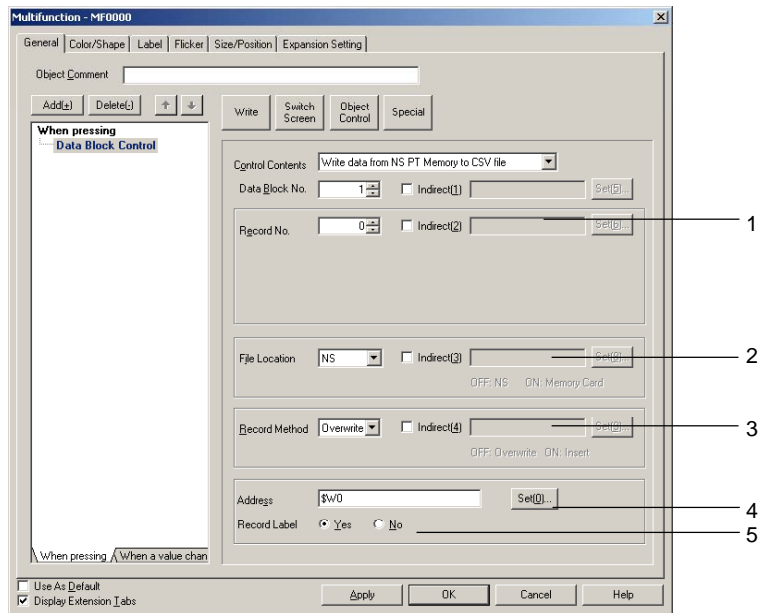

No.	Item	Details
1	Record No.	Specifies the record number in the CSV file (0 to 999) to use in the control operation. The record number can be set indirectly through a communications address by selecting the <i>Indirect</i> Option.
2	File Location	Specifies either the NS or the Memory Card as the location of the CSV file. The file location can be set indirectly by selecting the <i>Indirect</i> Option. If the specified address is 0, the NS will be used. If the specified address is 1, the Memory Card will be used.
3	Record Method	The data at the specified record can be overwritten or it can be inserted at the specified record number. The record method can be set indirectly by selecting the <i>Indirect</i> Option. If the specified address is 0, the data will be overwritten. If the specified address is 1, the data will be inserted.
4	Address	Specifies the PT memory address where the one record of data to be written to the CSV file is stored.
5	Record Label	Specifies whether to include the record label when reading.

**NS Series Programming Manual**

**Read Data from NS to PLC Data Block**

Transfers one record of data from the specified addresses in the NS to the PLC Data Block address set in each field.

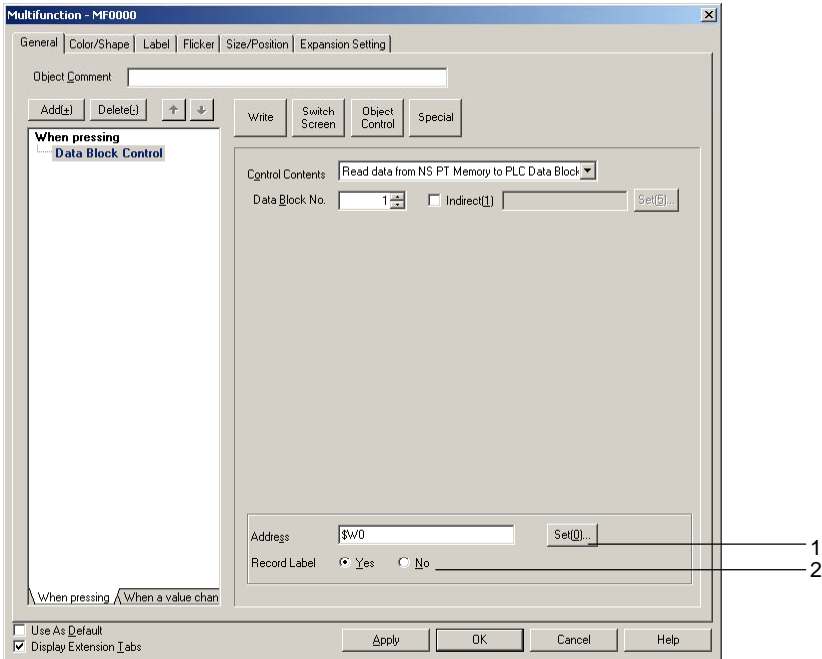

No.	Item	Details
1	Address	Specifies the PT memory address where the one record of data is stored.
2	Record Label	Selects whether or not the record label is included in the data stored at a specified communications address.

**Write Data from PLC Data Block to NS**

Reads the data from the PLC Data Block address set in each field to the specified NS address.

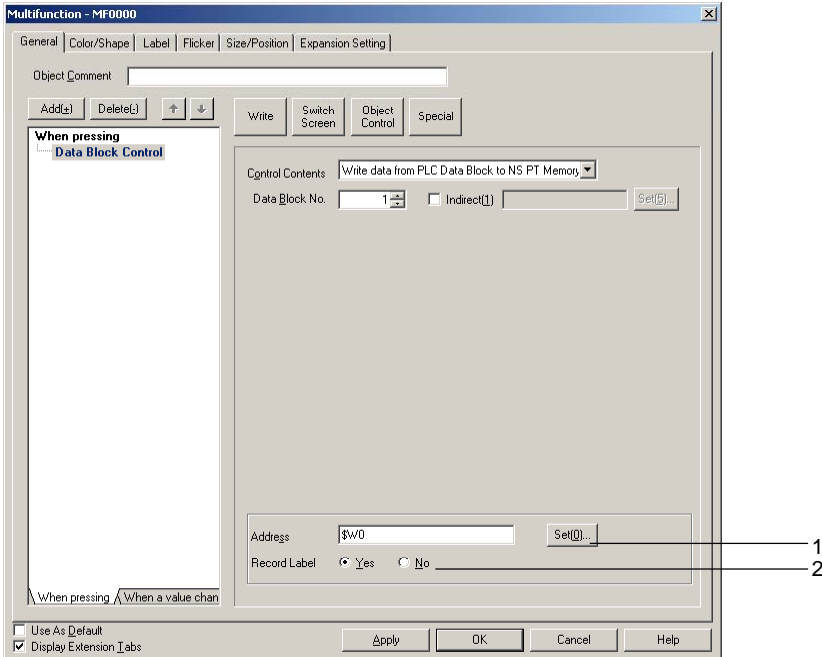

**NS Series Programming Manual**

No.	Item	Details
1	Address	Specifies the PT memory address where the one record of data will be stored.
2	Record Label	Specifies whether to include the record label when reading.

**Read Record Label**

Reads the record labels for the specified number of records in the CSV file to the specified NS address.

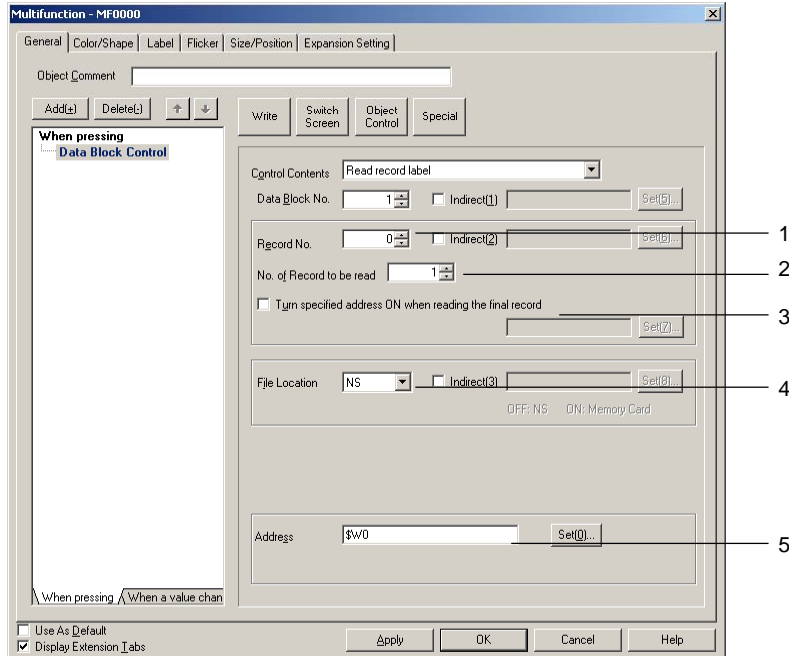

No.	Item	Details
1	Record No.	Specifies the record number in the CSV file (0 to 999) to use in the control operation. The record number can be set indirectly through a communications address by selecting the <i>Indirect</i> Option.
2	No. of Records to be read	Specifies the number of record labels to be read at a time from the specified starting record number.
3	Turn specified address ON when reading the final record	Can be selected to turn ON a specified address when the final record has been read.
4	File Location	Specifies either the NS or the Memory Card as the location of the CSV file. The file location can be set indirectly by selecting the <i>Indirect</i> Option. If the specified address is 0, the NS will be used. If the specified address is 1, the Memory Card will be used.
5	Address	Specifies the PT memory address where the record label data will be stored.

**NS Series Programming Manual**

**Delete Record**

Deletes the data for the specified CSV file record.

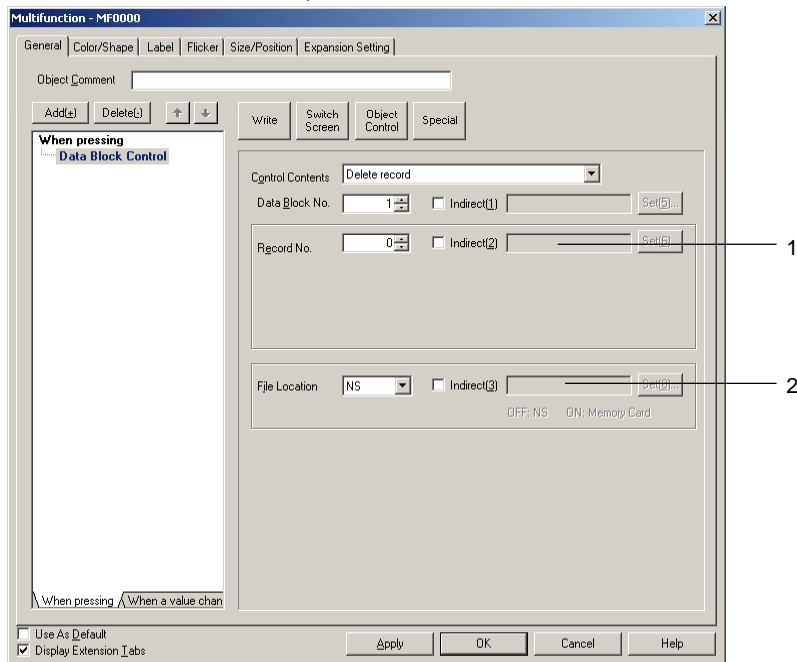

No.	Item	Details
1	Record No.	Specifies the record number in the CSV file (0 to 999) to use in the control operation. The record number can be set indirectly through a communications address by selecting the <i>Indirect</i> Option.
2	File Location	Specifies either the NS or the Memory Card as the location of the CSV file. The file location can be set indirectly by selecting the <i>Indirect</i> Option. If the specified address is 0, the NS will be used. If the specified address is 1, the Memory Card will be used.

### Contents Control

Switches the displayed contents. Press the **Object Control** Button and select *Contents Control* from the list that is displayed.

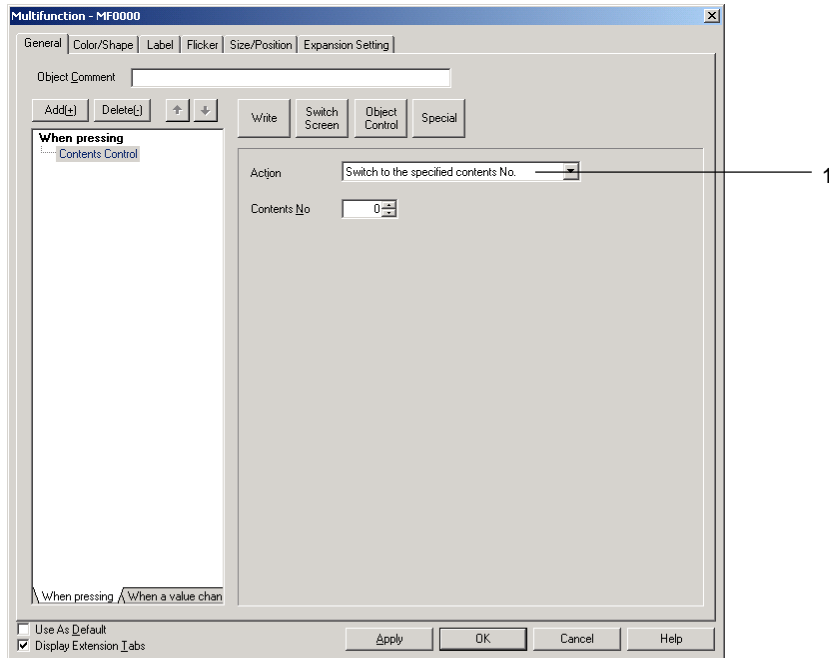

No.	Item	Details
1	Action	Selects the method for switching contents. The setting items depend on the selected method.
	Switch to the specified contents No.	Switches to the specified contents number when the button is pressed.
	Switch to the indirect reference contents No.	Reads the contents of a specified address as the contents number and switches to that contents number. Sets the contents of the communications address as a binary value.
	Switch to the next contents No.	Displays the data for the next contents number.
	Switch to the previous contents No.	Displays the data for the previous contents number.

**Note**

- ◆ Multifunction Object processing will be canceled in the following cases.
  - If the specified contents number does not exist.
  - If contents control is executed in a screen where contents switching has not been set, the operation will be canceled and the next function will be executed.



**Switch to Specified Contents No.**

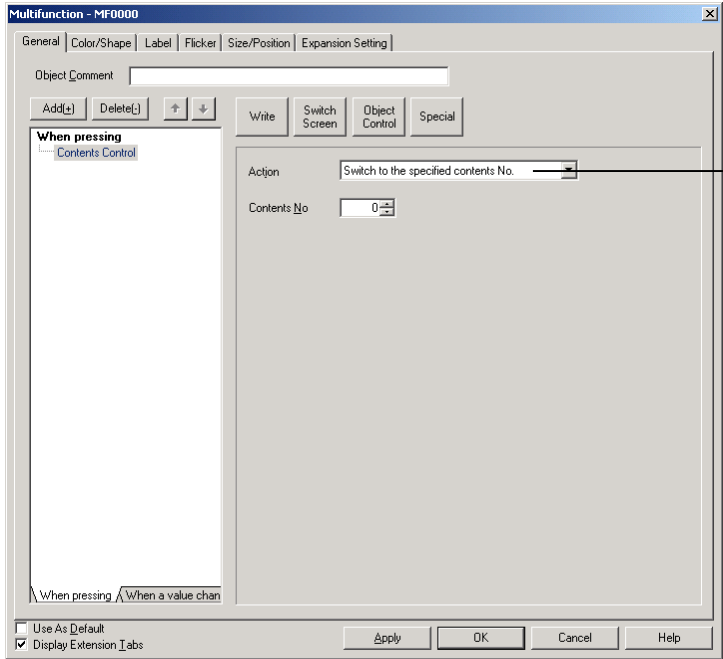

Specifies the contents number to switch to.

**Switch to the Indirect Reference Contents No.**

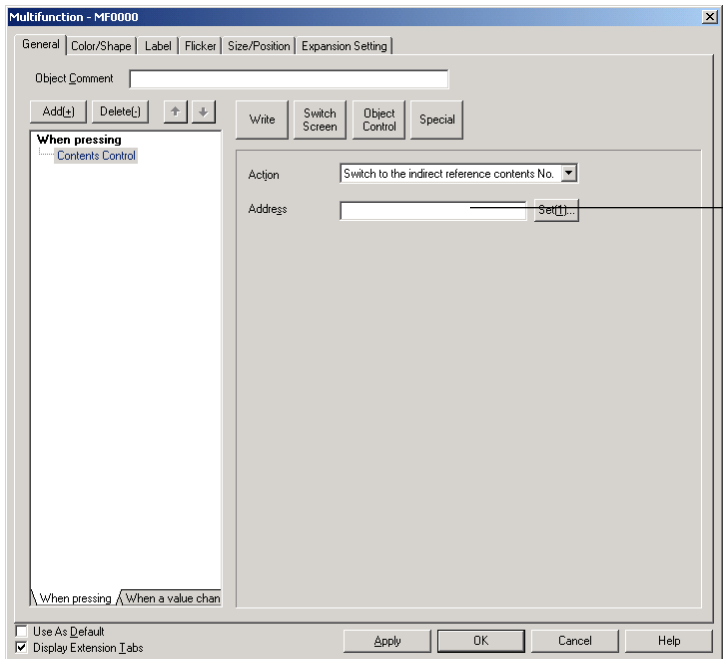

Sets the communications address that specifies the contents number to be switched to.

There are no settings to be made for *Switch to the next contents No.* and *Switch to the previous contents No.*

**NS Series Programming Manual**

**Alarm/Event Control**

This function operates on alarm/event functions. It saves and clears alarm/event histories. It can also be used to manipulate Alarm/Event Summary & History. Press the **Object Control** Button and select **Alarm/Event Control** from the list that is displayed.

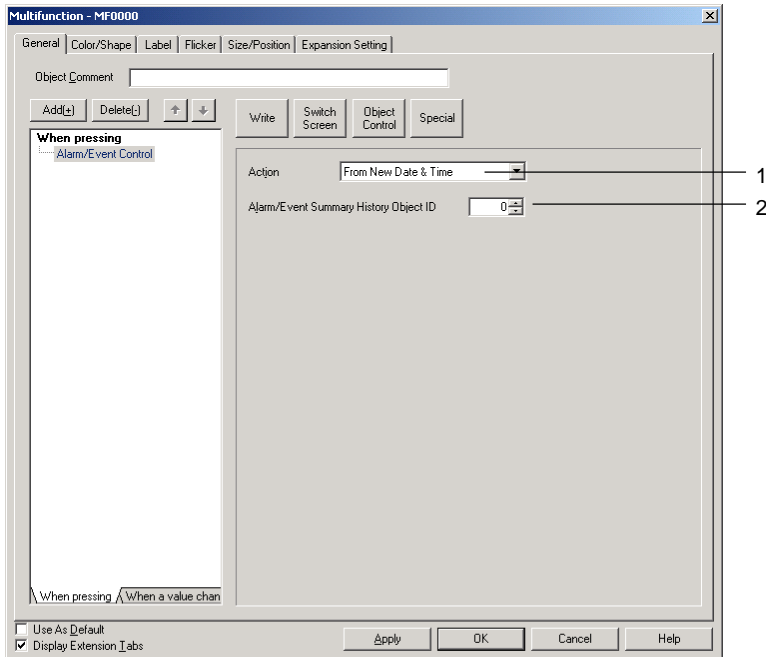

No.	Item	Details
1	Action	Selects the control operation for the alarm/event function. The setting items depend on the selected method.
	Clear	Clears alarm/event histories.
	Save	Saves alarm/event histories to a CSV file.
	Home	Selects the first row in the specified Alarm/Event Summary & History. (See note.)
	End	Selects the last row in the specified Alarm/Event Summary & History. (See note.)
	Next	Selects the next row after the currently selected row in the specified Alarm/Event Summary & History. (See note.)
	Previous	Selects the row before the currently selected row in the specified Alarm/Event Summary & History. (See note.)
	From New Date & Time	Displays the specified Alarm/Event Summary & History in order from newest to oldest. (See note.)
	From Old Date & Time	Displays the specified Alarm/Event Summary & History in order from oldest to newest. (See note.)
	From High Priority	Displays the specified Alarm/Event Summary & History in order from highest priority. (See note.)
	From Low Priority	Displays the specified Alarm/Event Summary & History in order from lowest priority. (See note.)
From High Frequency	Displays the specified Alarm/Event Summary & History in order from highest frequency. (See note.)	

NS Series Programming Manual

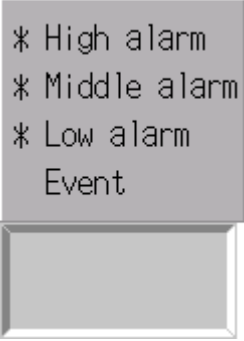
No.	Item	Details
1	Action From Low Frequency Check Selected Alarm Delete Selected Alarm Check All Alarms Cancel All Alarms' Checks Change Display Type	Selects the control operation for the alarm/event function. The setting items depend on the selected method. Displays the specified Alarm/Event Summary & History in order from lowest frequency. (See note.) Checks the selected alarm or event using the Alarm/Event Summary & History. (See note.) Deletes the selected alarm/event in the specified Alarm/Event Summary & History. (See note.) Checks all alarms/events in the specified Alarm/Event Summary & History. (See note.) Cancels the check of all alarms/events in the specified Alarm/Event Summary & History. (See note.) Changes the display type for the specified Alarm/Event Summary & History. When the function is executed, a menu for selecting the display type will be displayed. 
2	Alarm/Event Summary & History Object ID	Specifies the Alarm/Event Summary & History ID number for the control operation if <i>Clear</i> and <i>Save</i> are not selected.

**Note:** An Alarm/Event Summary & History on the base screen or pop-up screen must be set for the control operation. An Alarm/Event Summary & History on a different screen cannot be controlled, e.g., an Alarm/Event Summary & History on the base screen cannot be controlled from a pop-up screen. An Alarm/Event Summary & History on a sheet also cannot be controlled. When creating a Multifunction Object on a sheet, an Alarm/Event Summary & History with a specified ID number on the base screen or pop-up screen using that sheet must be controlled.

**Note**

- ◆ The *Clear* and *Save* functions perform the same operations as \$SB32 (Initialize Alarm/Event History) and \$SB33 (Save Alarm/Event History), respectively. However, when the Multifunction Object is executed, the \$SB32 and \$SB33 bits will not turn ON/OFF.
- ◆ Multifunction Object processing will be canceled in the following cases.
  - If an object ID other than an Alarm/Event Summary & History is specified.
  - If menu selection is canceled when *Change Display Type* is selected.

**NS Series Programming Manual**

**Data Log Control**

This function operates on data log functions.

It starts and stops data logging and saves logs. Data log graphs can also be manipulated using this function.

Click the **Object Control** Button and select *Data Log Control* from the list that is displayed.

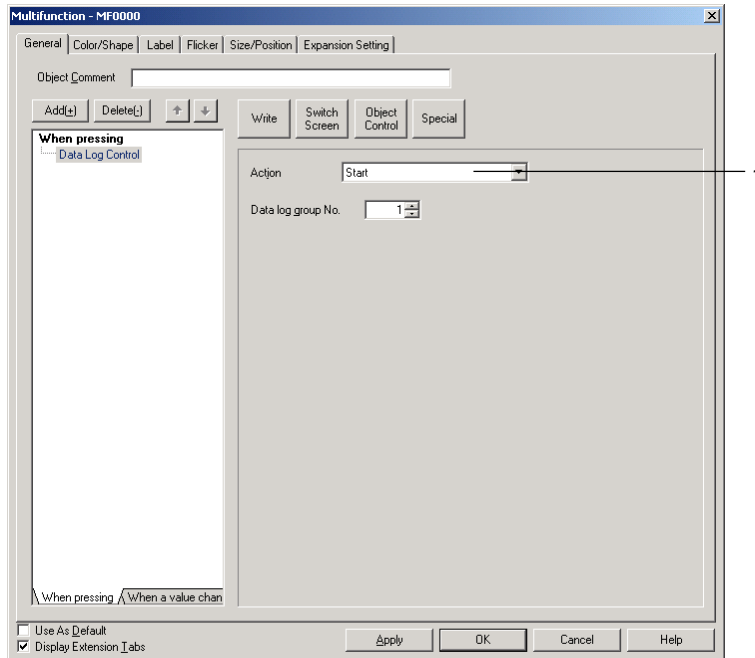

No.	Item	Details
1	Action	Selects the control operation for the data log function. The setting items depend on the selected method.
	Start	Starts logging of the specified data log group. If <i>Control start/stop data log by the specified address</i> is selected under the data log group settings, the set address will turn ON.
	Stop	Stops logging of the specified data log group. If <i>Control start/stop data log by the specified address</i> is selected under the data log group settings, the set address will turn OFF.
	Log Clear	Clears the log data for the specified data log group.
	Save to File	Writes the logging data to a file to the group folder displayed in the \LOG\Trend Memory Card directory, using the output file name set for the specified data log group.
	Read File	Used to select the file saved in the group folder displayed in the \LOG\Trend Memory Card directory from a pop-up menu. The selected file is displayed as a graph. (See note.)
	Pause	Pauses and cancels pause of data log graph display. (See note.)
	Move the cursor forward	Moves the time axis cursor forward one position along the time axis. (See note.)
	Move the cursor backward	Moves the time axis cursor back one position along the time axis. (See note.)

**Note:** A Data Log Graph on the base screen or pop-up screen must be set for the control operation. A Data Log Graph on a different screen cannot be controlled, e.g., a Data Log Graph on the base screen cannot be controlled from a pop-up screen. A Data Log Graph on a sheet also cannot be controlled. When creating a Multifunction Object on a sheet, a Data Log Graph with a specified ID number on the base screen or pop-up screen using that sheet must be controlled.

**Note**

- ◆ Even if display update is stopped because the *Pause* function is being used, data logging will continue when *Start* is selected. The latest log will be displayed when the screen is updated.
- ◆ Graph displays of files read from the Memory Card will be cleared when screens are switched.
- ◆ Multifunction Object processing will be canceled in the following cases.
  - If the specified data log group does not exist.
  - If an object ID other than a data log graph is specified.
  - If the file save or file read operation fails.
  - If menu selection is canceled when *Read File* is selected.

**Start, Stop, Delete Data Log, and Write File**

Specify the data log group for the control operation.

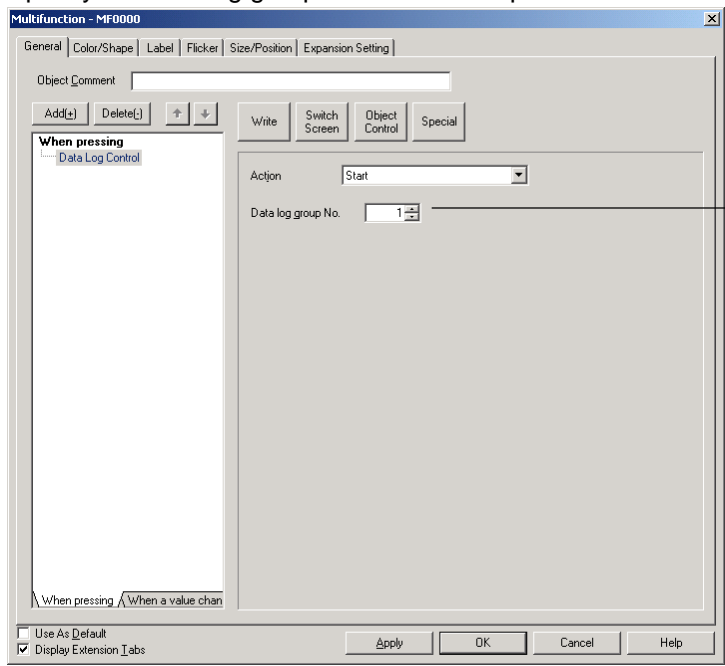

Specifies the data log group number.

### Read File

Specify the data log graph for the control operation and the display method for the graph that is read.

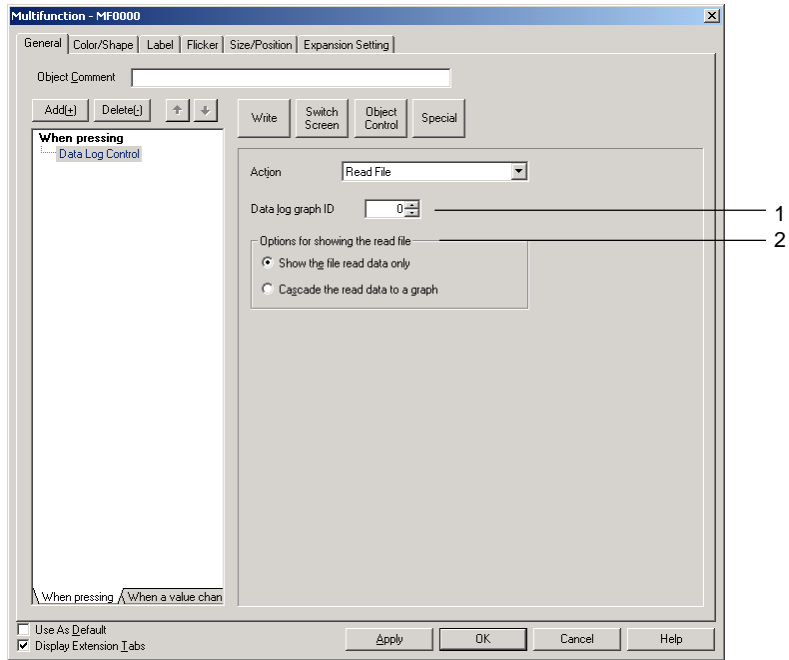

No.	Item	Details
1	Data log graph ID	Specifies the ID number of the data log graph for the control operation.
2	Options for showing the read file	The graph display method for the read file can be selected from one of the following two options. <ul style="list-style-type: none"> <li>• Show the file read data only.</li> <li>• Cascade the graph on the file read data.</li> </ul>

**Note**

- ◆ Data log graphs also have an *Options for showing the read file* Setting but the Multifunction Object settings are enabled when executing data log graph file read from a Multifunction Object.

**Pause, Move the Cursor Forward, and Move the Cursor Backward**

Specify the data log graph for the control operation.

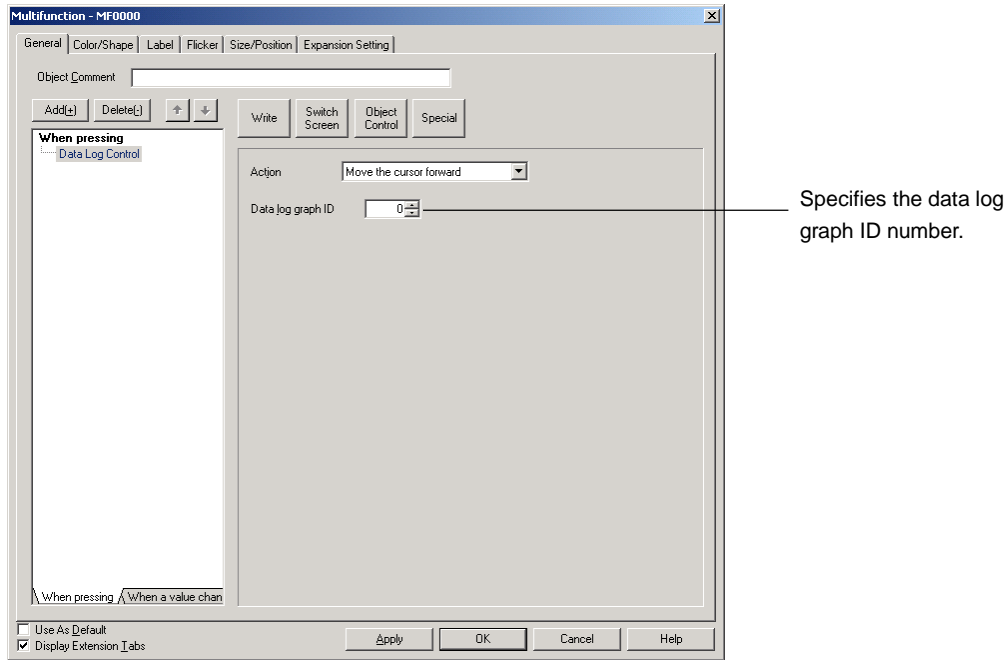

**Video Control – Video Capture**

Captures a video image at a specified location and saves it in .bmp format to the Memory Card.

Click the **Object Control** Button and select *Video Control – Video Capture* from the list that is displayed. The setting items depend on the Video Board selected in the System Settings Dialog Box. (Select **PT – System Settings** to display the System Settings Dialog Box.)

**Note**

- ◆ The Multifunction Object processing will be canceled if there is no Video Board mounted on the NS.
- ◆ *Video control – Video Capture* can be used only once in any one Multifunction Object.

**NS Series Programming Manual**

**Four-channel Video Input Units (NS-CA001)**

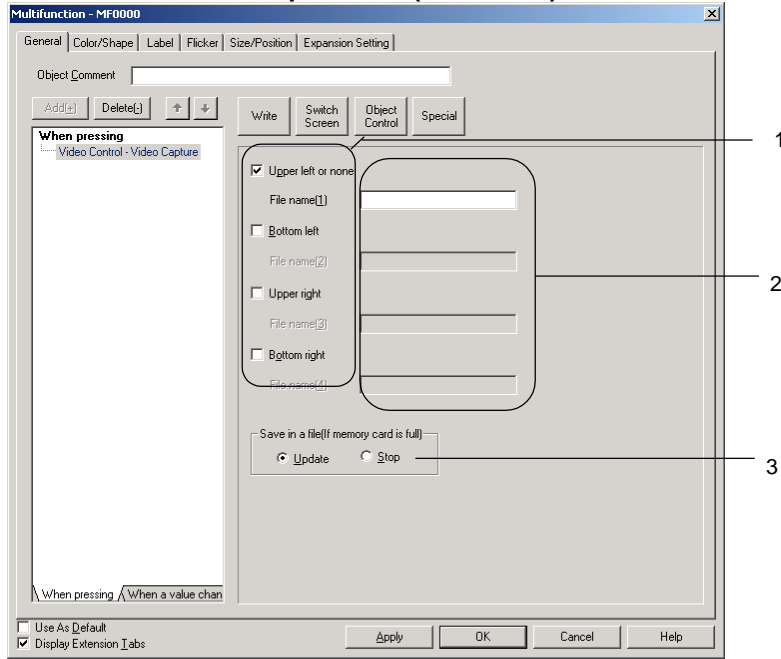

No.	Item	Details
1	Capture position	Sets the video display position for capture. Select <i>Upper left or none</i> for video display objects with a 640 x 480 display size. Video images with a display size of 800 x 600 cannot be captured.
2	File name	Sets the file name for saving the captured data (up to 32 characters). Each time the save operation is executed, the numbers 001 to 999 will be automatically appended to the file name, in order. Capture data will be saved to the Memory Card in bitmap format. Example: If the file name is set to <i>Video_LT</i> , the files <i>Video_LT001.bmp</i> to <i>Video_LT999.bmp</i> will be saved to the Memory Card. Refer to 2-9-3 <i>Command Buttons</i> for information on captured data.
3	Save in a file (if Memory Card is full)	Sets the action for when video capture is executed when the Memory Card is full. <ul style="list-style-type: none"> <li>Update: Deletes the oldest file with the same file name and saves the data as the newest file name +1.</li> <li>Stop: Does not save the data.</li> </ul>



**Two-channel RGB/Video Input Units (NS-CA002)**

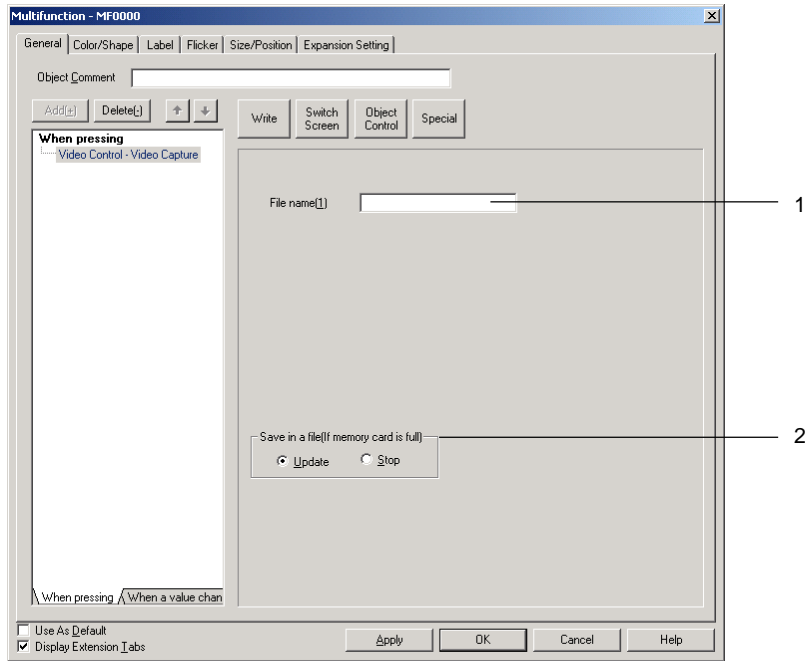

No.	Item	Details
1	File name	<p>Sets the file name for saving the captured data (up to 32 characters). Each time the save operation is executed, the numbers 001 to 999 will be automatically appended to the file name, in order.</p> <p>Capture data will be saved to the Memory Card in bitmap format.</p> <p>Example: If the file name is set to <i>Video_LT</i>, the files <i>Video_LT001.bmp</i> to <i>Video_LT999.bmp</i> will be saved to the Memory Card.</p> <p>Refer to 2-9-3 <i>Command Buttons</i> for information on captured data.</p>
2	Save in a file (if Memory Card is full)	<p>Sets the action for when video capture is executed when the Memory Card is full.</p> <ul style="list-style-type: none"> <li>• Update: Deletes the oldest file with the same file name and saves the data as the newest file name +1.</li> <li>• Stop: Does not save the data.</li> </ul>

**Video Control – Contrast Adjustment**

The contrast, brightness, depth, and tone of video images can be adjusted using this function.

Click the **Object Control** Button and select *Video Control – Contrast Adjustment* from the list that is displayed.

**Note**

- ◆ The Multifunction Object processing will be canceled if there is no Video Board mounted on the NS.
- ◆ *Video Control – Contrast Adjustment* can be used only once for each Multifunction Object.

The setting items depend on the Video Board selected in the System Settings Dialog Box. (Select **PT – System Settings** to display the System Settings Dialog Box.)

**NS Series Programming Manual**

**Four-channel Video Input Units (NS-CA001)**

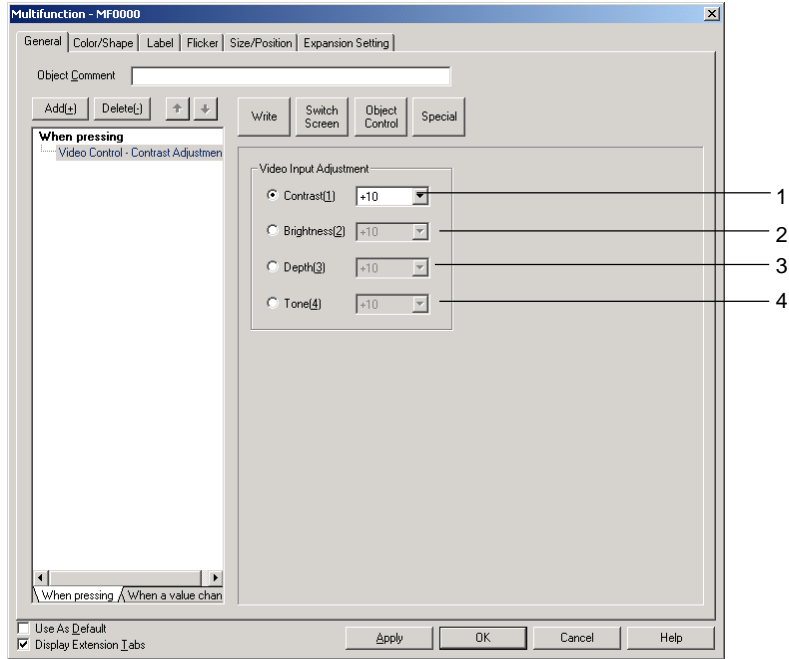

No.	Item	Details
1	Contrast	Select to adjust contrast. Select -10, -1, +1, or +10. Contrast can be set in 64 levels.
2	Brightness	Select to adjust brightness. Select -10, -1, +1, or +10. Brightness can be set in 128 levels.
3	Depth	Select to adjust depth. Select -10, -1, +1, or +10. Depth can be set in 32 levels.
4	Tone	Select to adjust tone. Select -10, -1, +1, or +10. Depth can be set in 256 levels.

**Two-channel RGB/Video Input Units (NS-CA002)**

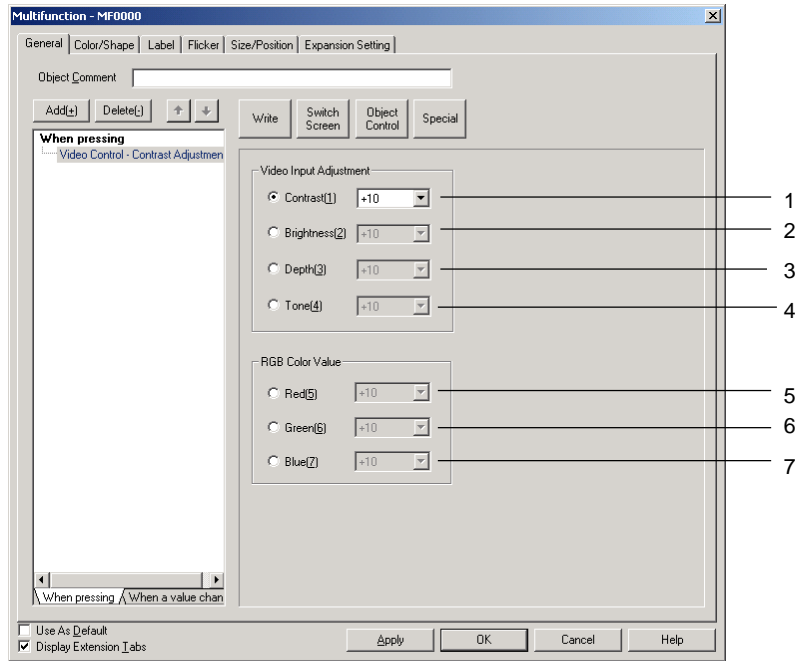

No.	Item	Details
1	Contrast	Select to adjust contrast. Select -10, -1, +1, or +10. Contrast can be set in 64 levels.
2	Brightness	Select to adjust brightness. Select -10, -1, +1, or +10. Brightness can be set in 128 levels.
3	Depth	Select to adjust depth. Select -10, -1, +1, or +10. Depth can be set in 32 levels.
4	Tone	Select to adjust tone. Select -10, -1, +1, or +10. Tone can be set in 256 levels.
5	Red	Select to adjust the gain of the R (red) signal. Select -10, -1, +1, or +10.
6	Green	Select to adjust the gain of the G (green) signal. Select -10, -1, +1, or +10.
7	Blue	Select to adjust the gain of the B (blue) signal. Select -10, -1, +1, or +10.

**Video Control – Vision Sensor Console Output**

Sends a one of various control signals to an OMRON Vision Sensor.

Click the **Object Control** Button and select *Video Control – Vision Sensor Console* from the list that is displayed.

**Note**

- ◆ The Multifunction Object processing will be canceled if there is no Video Board mounted on the NS.
- ◆ Execute *Video Control – Vision Sensor Console Output* as the last function for touch ON timing.
- ◆ *Video Control – Vision Sensor Console Output* can be used only once for each Multifunction Object.

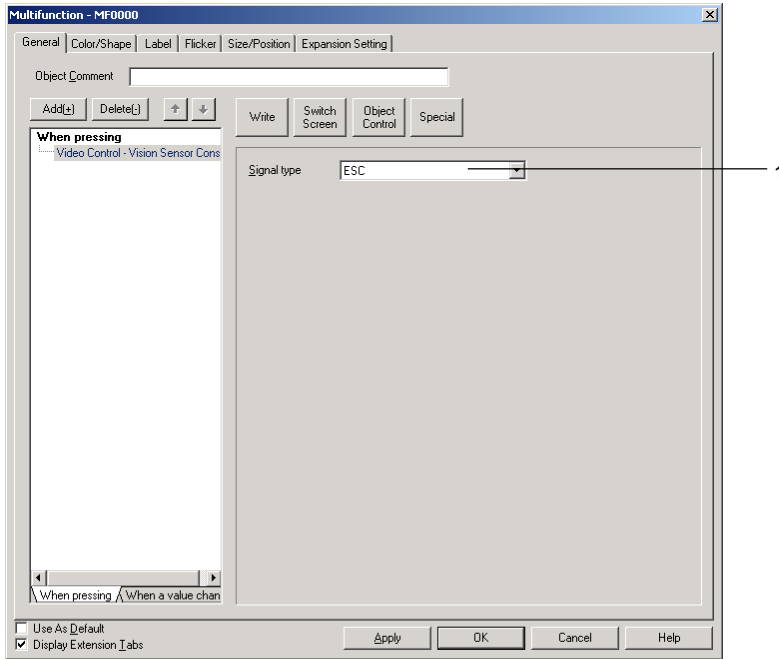

No.	Item	Details
1	Signal type	Sets the type of signal to be sent to the Vision Sensor.

**Scroll Object**

Scroll bars on functional objects can be operated from Multifunction Objects. The functional object is scrolled in the specified direction for the specified amount.

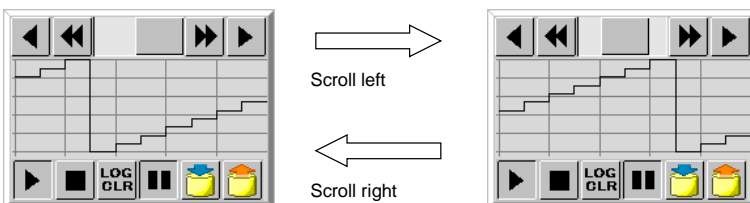
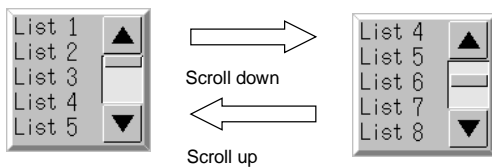
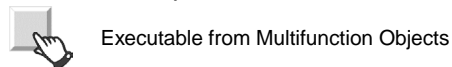

**NS Series Programming Manual**

The following tables show the functional objects that can be scrolled using the object scroll function and the scrolling unit for that functional object.

Functional object	Scrolling unit
List Selection	Row
Broken-line Graph	Dot
Alarm/Event Summary/History	Row (scroll up/down)
	Item (scroll right/left)
Data Log Graph	Gradation
Data Block Table	Row (scroll up/down)
	Item (scroll right/left)
Contents Display (for string display)	Row (scroll up/down)
	Dot (scroll right/left)
Contents Display (for image display)	Dot

**Note:** A functional object on the base screen or pop-up screen must be set for scrolling. A functional object on a different screen cannot be set, e.g., a functional object on the base screen cannot be scrolled from a pop-up screen. Functional objects on sheets also cannot be scrolled. When creating a Multifunction Object on a sheet, a functional object with a specified ID number on the base screen or pop-up screen using that sheet must be scrolled.

**Note**

- ◆ The operation for the object scroll function is the same as when the scroll button on the functional object itself is pressed.
- ◆ Functional objects that do not display the scroll button can still be scrolled from a Multifunction Object.
- ◆ The object scroll function will be disabled in the following cases.
  - If scrolling is attempted in a direction for which scrolling is not possible.
- ◆ Multifunction Object processing will be canceled in the following cases.
  - If an object with the specified ID does not exist.
  - If the object scroll function has been executed for a functional object that does not have a scroll bar.

Press the **Object Control** Button and select *Scroll Object* from the list that is displayed.

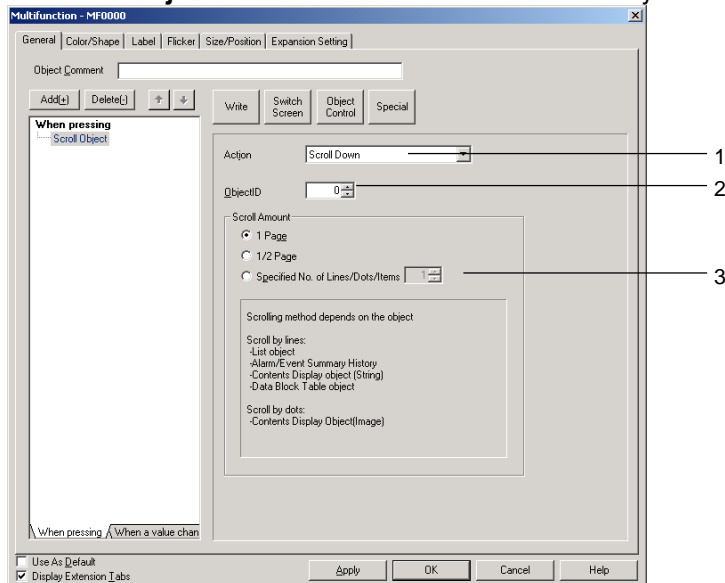

**NS Series Programming Manual**

No.	Item	Details
1	Action	Select one of the following scroll directions. <ul style="list-style-type: none"> <li>• Scroll Down</li> <li>• Scroll Up</li> <li>• Scroll Right</li> <li>• Scroll Left</li> </ul>
2	Object ID	Specify the ID number for the functional object to be scrolled.
3	Scroll Amount	Specify the scroll amount. <ul style="list-style-type: none"> <li>• 1 Page</li> <li>• 1/2 Page</li> <li>• Specified No. of Lines/Dots/Items</li> </ul> If <i>Specified No. of Lines/Dots/Items</i> is selected, specify a scroll amount from 1 to 9,999.

**Password Setting**

The password setting function requests a password before executing a functional object.

The functions set for execution after Password Setting are executed only after the password matching the set level has been entered.

The next functions will not be executed if an incorrect password has been entered three times or password input has been canceled.

For example, if the following settings are made, the Password Dialog Box will be displayed after Write Bit and Write Word are executed. If the correct password is entered, the Write String and Switch Screen functions will be executed.

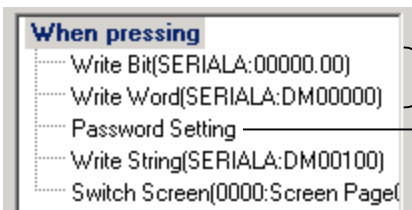

1. *Write Bit* and *Write Word* are executed. (Always executed before the Password Dialog Box displayed.)
2. The Password Dialog Box is displayed.
3. If the correct password is entered, *Write String* and *Switch Screen* will be executed. If an incorrect password is entered three times or password input canceled, *Write String* and *Switch Screen* will not be executed.

**Note**

- ◆ Refer to 2-8-15 *Passwords (Extension Tabs)* for details on password functions.
- ◆ If the *Switch Screen* is set after *Password Setting* when the execution condition is set to *When pressing*, the screen will be switched even if the password is entered incorrectly three times or password entry is canceled. To use passwords to prevent the screen from being changed, set *Display Touch ON/OFF Condition* for the execution condition, and then set *Password Setting* and *Switch Screen* for *Touch OFF timing*.

Press the **Special** Button and select *Password Setting* from the list that is displayed.

**NS Series Programming Manual**

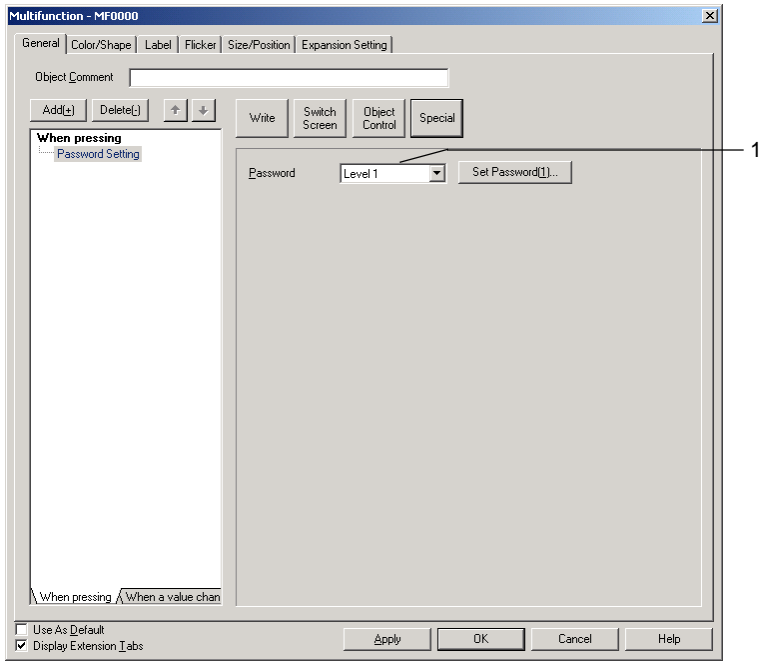

No.	Item	Details
1	Password	Select the password level (1 to 5). If no password is to be specified, select <i>None</i> .

### Authentication Cancellation

Cancels authentication when an authentication level has been set.

Press the Special Button and select *Authentication Cancellation* from the list that is displayed.

There are no settings required for the authentication cancellation function.

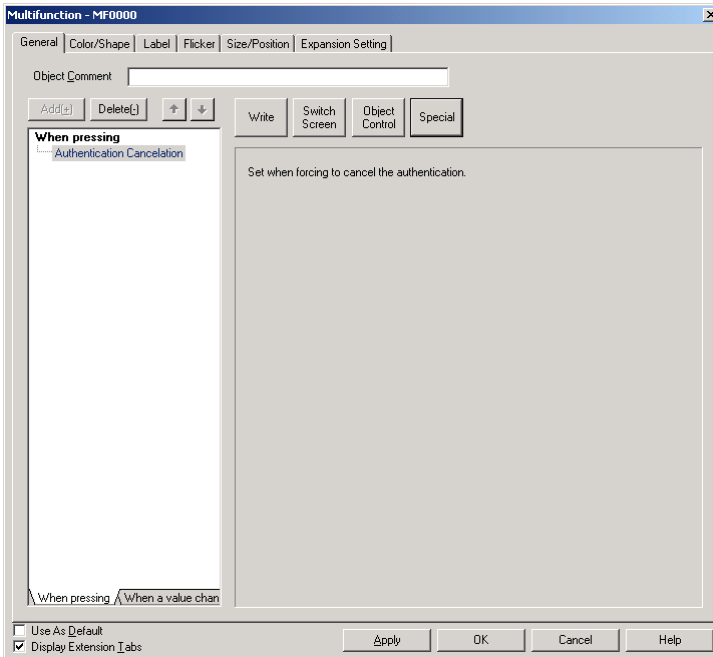

### Confirmation Dialog Box

A confirmation message can be set to be displayed before execution of functions.

The functions set for execution after the confirmation dialog are executed only after the Yes Button has been pressed in the confirmation dialog box. The functions set for execution after the confirmation dialog will not be executed if the No Button has been pressed in the confirmation dialog box.

For example, if the following settings are made, a confirmation message will be displayed after Write Bit and Write Word are executed. If the **Yes** Button is pressed, the Write String and Switch Screen functions will be executed. If the **No** Button is pressed, the Write String and Switch Screen functions will not be executed.

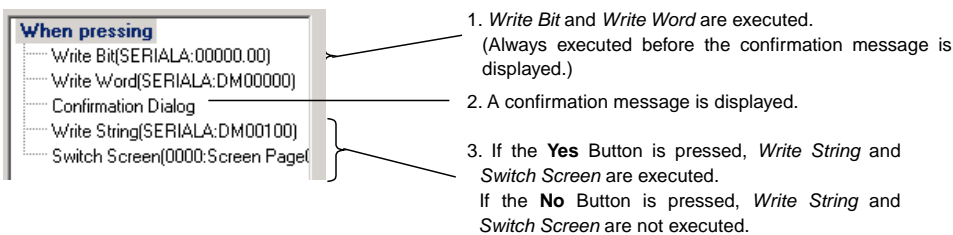

**Note**

◆ Refer to 2-8-14 Write Settings (Extension Tabs) for details on confirmation dialog boxes.

Press the **Special** Button and select *Confirmation Dialog* from the list that is displayed.



**NS Series Programming Manual**

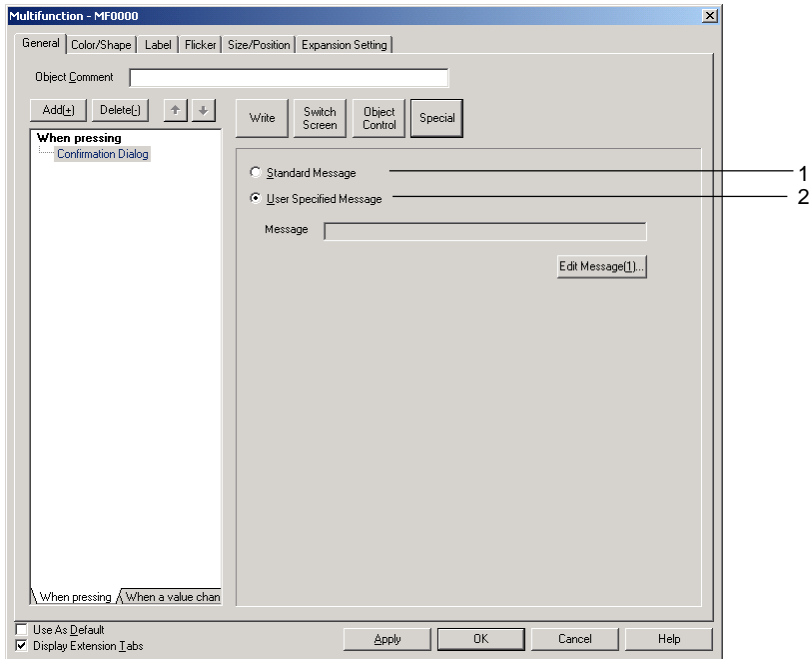

No.	Item	Details
1	Standard Message	Displays a standard message for confirming the write operation.
2	User Specified Message	Displays a unique confirmation message created by the user. Press the <b>Edit Message</b> Button to display the Dialog Settings Dialog Box to create a message. Refer to 2-8-14 Write Settings (Extension Tabs) for details.

### Buzzer

The Buzzer function is used to sound and stop the buzzer. Press the **Special** Button and select *Buzzer* from the list that is displayed.

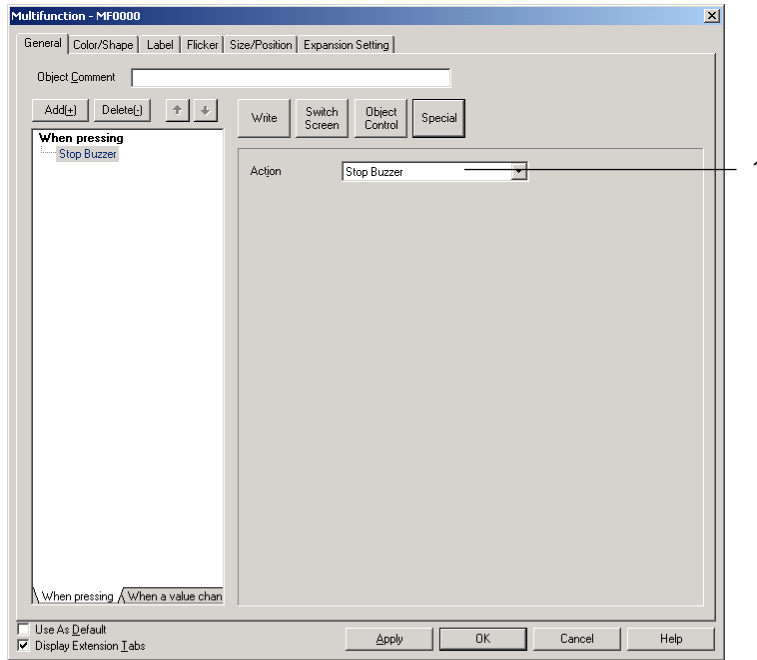

No.	Item	Details
1	Action	Sets the control operation for the buzzer function.
	Stop Buzzer	Stops the buzzer that is currently sounding. Any ON bit at \$SB12 (continuous buzzer), \$SB13 (short intermittent), or \$SB14 (long intermittent) will turn OFF.
	Continuous Buzzer	Sounds a continuous buzzer. \$SB12 will turn ON.
	Short Intermittent Buzzer	Sounds a short intermittent buzzer. \$SB13 will turn ON.
	Long Intermittent Buzzer	Sounds a long intermittent buzzer. \$SB14 will turn ON.

### Macro

The macro function can be used to set macros. Refer to *NS Series Macro Reference* for details on macros.

Press the **Special** Button and select *Macro* from the list that is displayed.

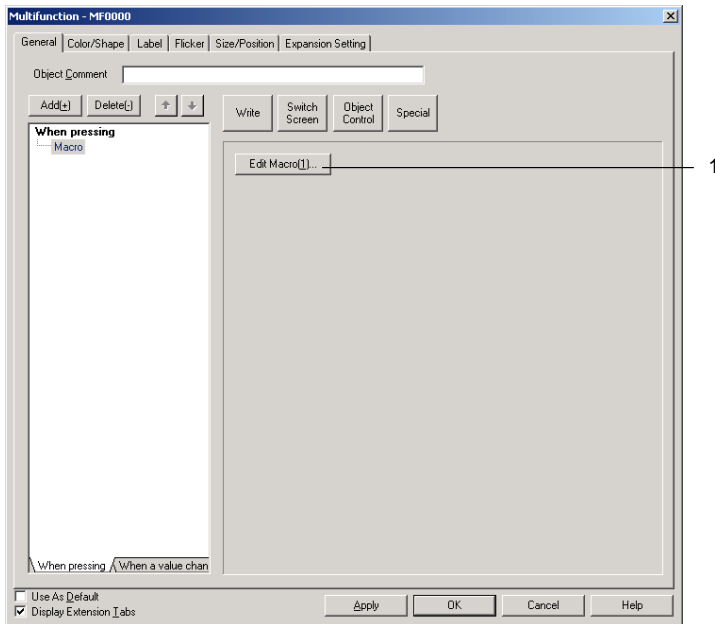

No.	Item	Details
1	Edit Macro	Displays the Edit Macro Dialog Box to create new macros or edit macros.

### Operation Log Control

The operation log control function can be used to initialize or save the operation log.

Press the **Special** Button and select *Initialize Operation Log* from the list that is displayed.

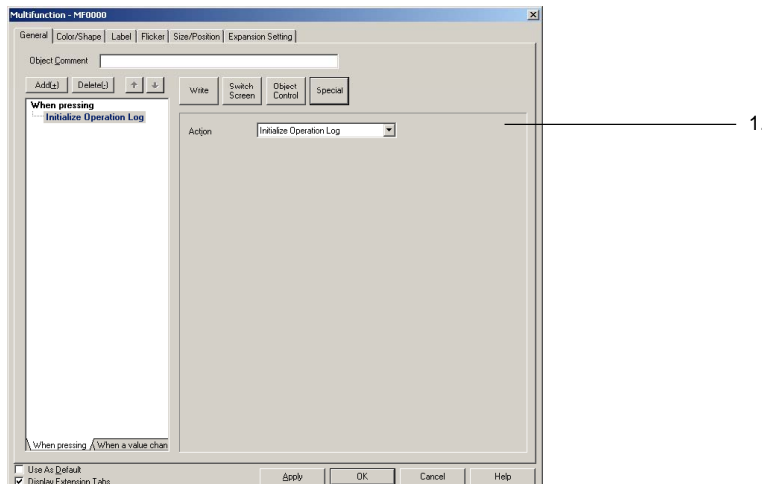

No.	Item	Details
1	Action	Sets the control action for the operation log from the following options. <ul style="list-style-type: none"> <li>• Initialize operation log.</li> <li>• Save operation log.</li> </ul>

**NS Series Programming Manual**

**Color/Shape**

Sets the color and shape of the Multifunction Object.

Use the following procedure to make the settings.

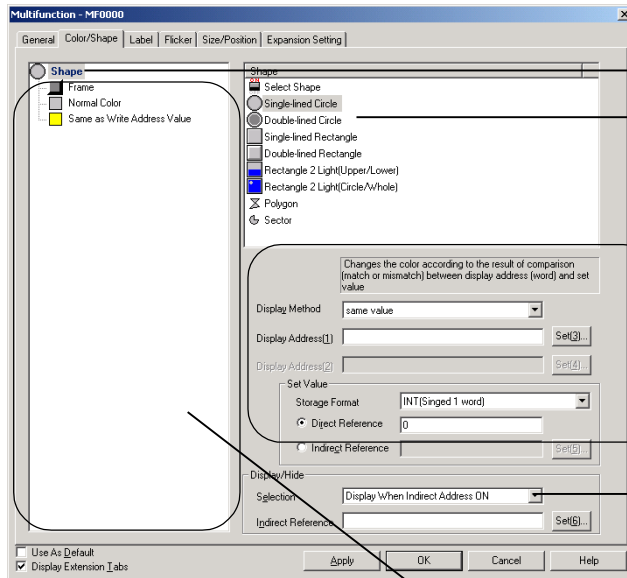

1. Select **Shape** from the Color/Shape List at the left of the Dialog Box. (**Shape** will be selected by default when the Color/Shape Tab is opened.)
2. Select the Multifunction Object shape.
3. Select the display method. Make the communications address and other settings according to the selected display method.
4. Make the display/hide control settings.
5. Make the frame, color, and shape settings.





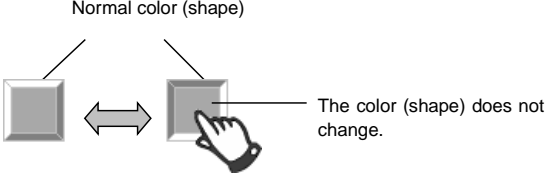
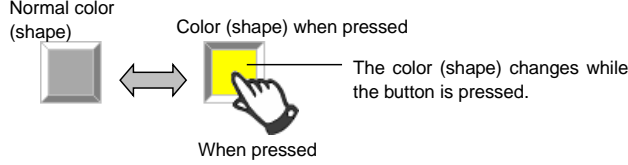
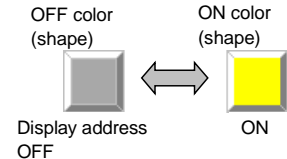
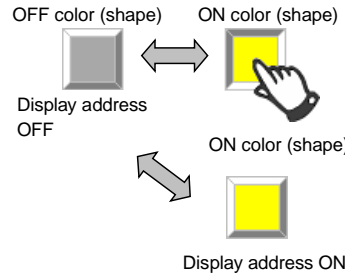

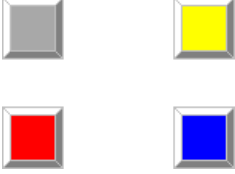
1. Select **Shape**.
2. Select the display shape.
3. Select the display method.  
Make the communications and other settings according to the display method. (The setting items will depend on the selected display method.)
4. Make the display/hide settings.
5. Make the color, shape, and frame display shape settings. (The setting items depend on the selected shape and display method.)

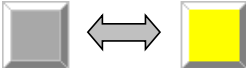
No.	Item	Details
1	Shape	Select to make shape settings for the Multifunction Object.
2	Shape	Select one of the following Multifunction Object shapes.
	Select Shape	Displays the specified shape file when the Multifunction Object is pressed or according to the specified communications address value.
	Single-lined Circle	Displays the specified color when the Multifunction Object is pressed or according to the specified communications address value.
	Double-lined Circle	Displays the specified color when the Multifunction Object is pressed or according to the specified communications address value.
	Single-lined Rectangle	Displays the specified color when the Multifunction Object is pressed or according to the specified communications address value.
	Double-lined Rectangle	Displays the specified color when the Multifunction Object is pressed or according to the specified communications address value.
	Rectangle 2 Light (Upper/Lower)	Displays the specified color according to the values for two specified communications addresses.
	Rectangle 2 Light (Circle/Whole)	Displays the specified color according to the values for two specified communications addresses.
	Polygon	Displays the specified color when the Multifunction Object is pressed or according to the specified communications address value.
Sector	Displays the specified color when the Multifunction Object is pressed or according to the specified communications address value.	

No.	Item	Details
3	Display Method	Selects the method for color/shape changes for the specified shape. Refer to <i>Display Method Settings</i> later in this section for details.
	Normal Color Normal Shape	Always displays the same shape/color, whether or not the Multifunction Object is pressed. 
	When Pressed	Switches between the normal color (shape) and the pressed color (shape) when the Multifunction Object is pressed. 
	Bit Address	Switches between the ON color (shape) and OFF color (shape) depending on the ON/OFF status of the specified display address. 
	Bit Address/When Pressed	Switches between the ON color (shape) and OFF color (shape) depending on the ON/OFF status of the specified display address. Or displays the ON color (shape) while the Multifunction Object is pressed. 

No.	Item	Details
3	Display Method	Selects the method for color/shape changes for the specified shape. Refer to <i>Display Method Settings</i> later in this section for details.
	Bit Address 1, 2 (4 Colors)  Bit Address 1, 2 (4 Shapes)	Switches color (shape) depending on the ON/OFF status of two specified display addresses. Display Address (1): OFF    Display Address (1): OFF Display Address (2): OFF    Display Address (2): OFF  Display Address (1): OFF    Display Address (1): ON Display Address (2): ON     Display Address (2): ON
	Bit Address 1, 2 (Upper/Lower)	This option can be selected only when <i>Rectangle 2 Light (Upper/Lower)</i> has been specified. Switches the upper and lower display colors depending on the ON/OFF status of two specified display addresses.   Displays the upper ON or upper OFF color depending on the ON/OFF status of Display Address (1). Displays the lower ON or lower OFF color depending on the ON/OFF status of Display Address (2).
	Bit Address 1, 2 (Circle/Whole)	This option can be selected only when <i>Rectangle 2 Light (Circle/Whole)</i> has been specified. Switches the whole display color and the circle section display color depending on the ON/OFF status of two specified display addresses.   Displays the ON/OFF color for inside the circle depending on the ON/OFF status of Display Address (1). Displays the ON/OFF color for the whole button depending on the ON/OFF status of Display Address (2).
Same Value	Displays the set value match color (shape) if the contents of the specified address and the set value match. Displays the normal color (shape) if the values do not match.  Normal color (shape)    Set value matched color (shape)  Display address contents and set value do not match.    Display address contents and set value match.	

**NS Series Programming Manual**

No.	Item	Details
3	Display Method	Selects the method for color/shape changes for the specified shape. Refer to <i>Display Method Settings</i> later in this section for details.
	Word Address (16 Colors) Word Address (16 Shapes)	Displays the set color (shape) according to the value at the specified communications address (0 to 15).  <div style="display: flex; justify-content: space-around; align-items: flex-end;"> <div style="text-align: center;"> <p>Color (shape) 1</p>  <p>Display address value</p> </div> <div style="text-align: center;"> <p>Color (shape) 2</p>  <p>Value=1</p> </div> <div style="text-align: center;"> <p>Color (shape) 15</p>  <p>Value=14</p> </div> <div style="text-align: center;"> <p>Color (shape) 16</p>  <p>Value=15</p> </div> </div>
4	Display/Hide	Sets whether to display or hide the Multifunction Object. If <i>Indirect Reference</i> is selected, switches between display/hide depending on the ON/OFF status of the set communications address. Only bit addresses can be specified under <i>Indirect Reference</i> .
5	Color/Shape List	Sets the color, shape file, frame and other settings according to the selected shape and display method. Refer to <i>Setting Color/Shape</i> later in this section for details.

**Display Method Settings**

The action and setting items depend on the selected display method.

**Normal Color (Normal Shape) and When Pressed**

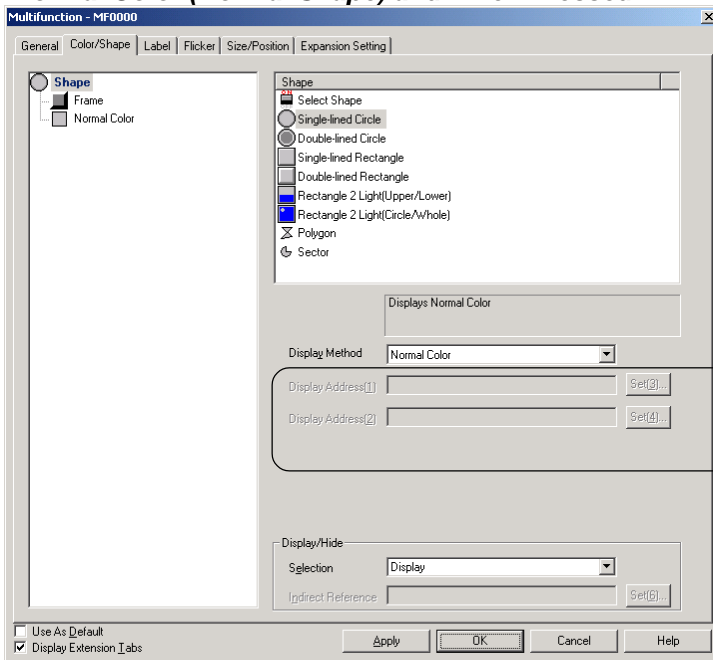

— No settings required.

NS Series Programming Manual

Bit Address, Bit Address/When Pressed, and Word Address (16 Colors)

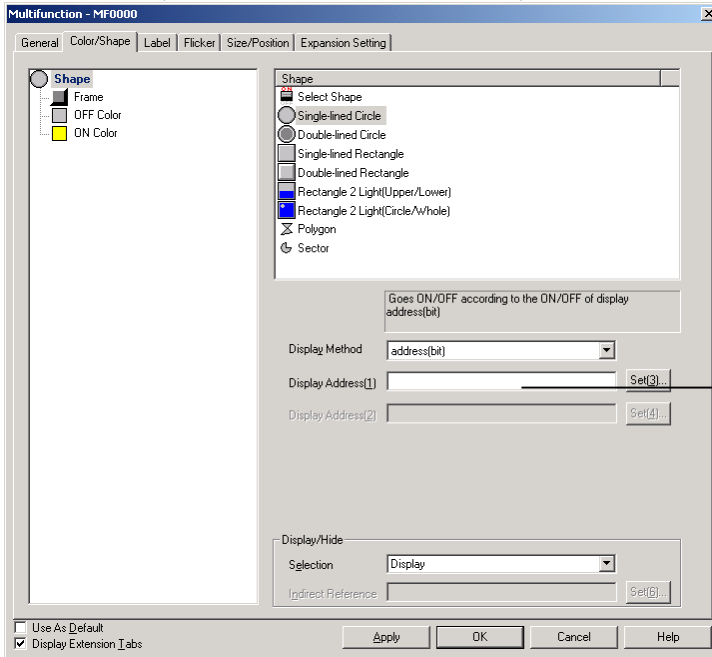

Sets display address 1.

Bit Address 1, 2 (4 Colors), Bit Address 1, 2 (Upper/Lower), and Bit Address 1, 2 (Circle/Whole)

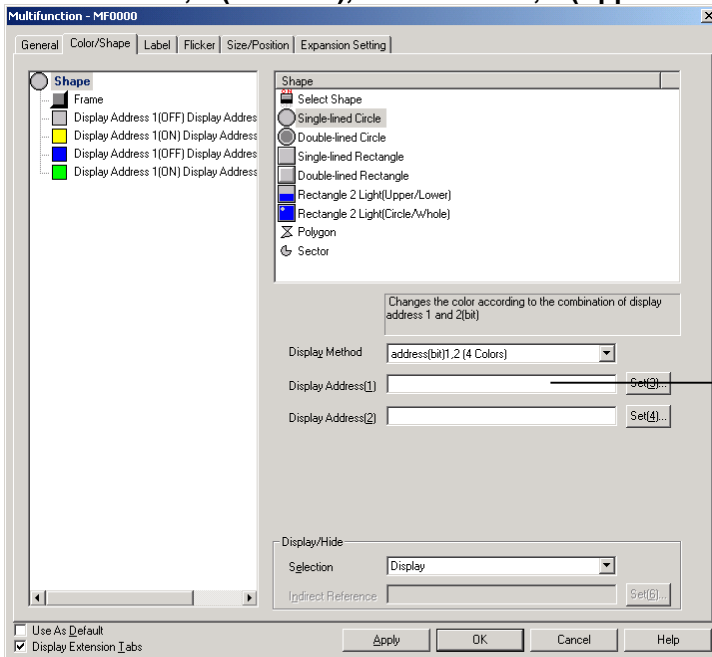

Sets display addresses 1 and 2.



**NS Series Programming Manual**

**Same Value**

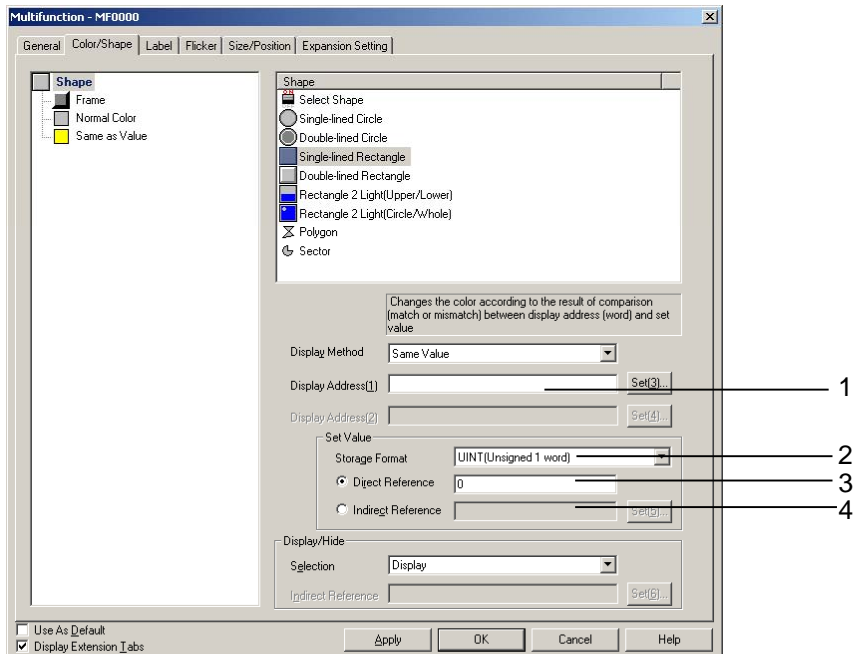

No.	Item	Details
1	Display Address (1)	Sets the communications address for comparison with the <i>Set Value</i> .
2	Storage Format	Select the storage format for the numeric value stored at the communications address from the following. <ul style="list-style-type: none"> <li>• INT (signed, 1 word)</li> <li>• UINT (unsigned, 1 word)</li> <li>• DINT (signed, 2 words)</li> <li>• UDINT (unsigned, 2 words)</li> <li>• REAL (real number)</li> <li>• BCD2 (unsigned, 1 words)</li> <li>• BCD2 (unsigned, 2 words)</li> <li>• BCD1 (signed (leftmost digit: F), 1 words)</li> <li>• BCD1 (signed (leftmost digit: F), 2 words)</li> <li>• BCD2 (signed (leftmost bit: 1), 1 words)</li> <li>• BCD2 (signed (leftmost bit: 1), 2 words)</li> </ul>
3	Direct Reference	Sets the value (set value) for comparison with the display address.
4	Indirect Reference	Sets a communications address for comparison with the display address.

**NS Series Programming Manual**

**Setting Color/Shape**

**Method for Setting Color/Shape List**

1. Displays the setting items in the Color/Shape List corresponding to the selected *Shape* and *Display Method*.
2. Click the items to be set.

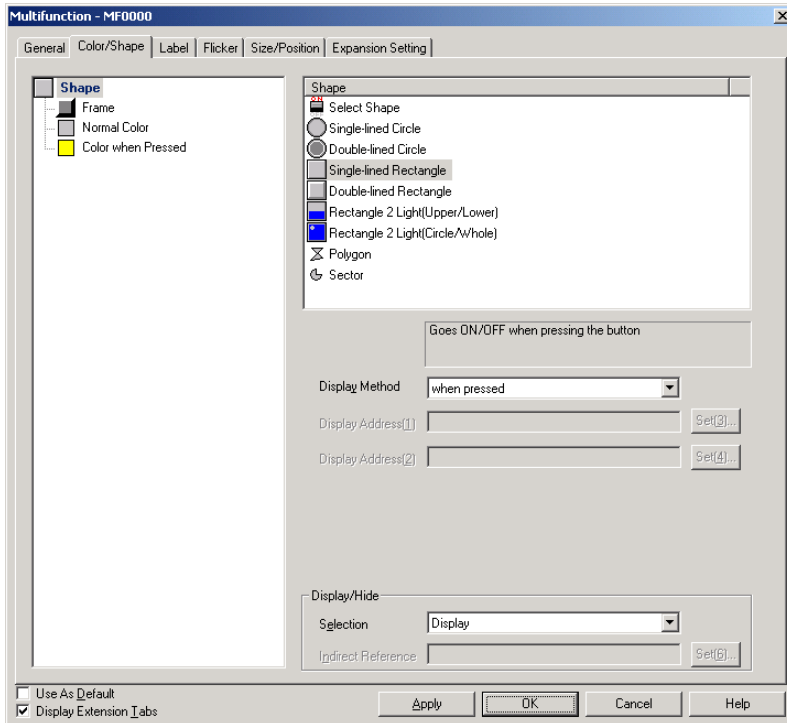

3. The detailed setting items are displayed. Make the required settings.

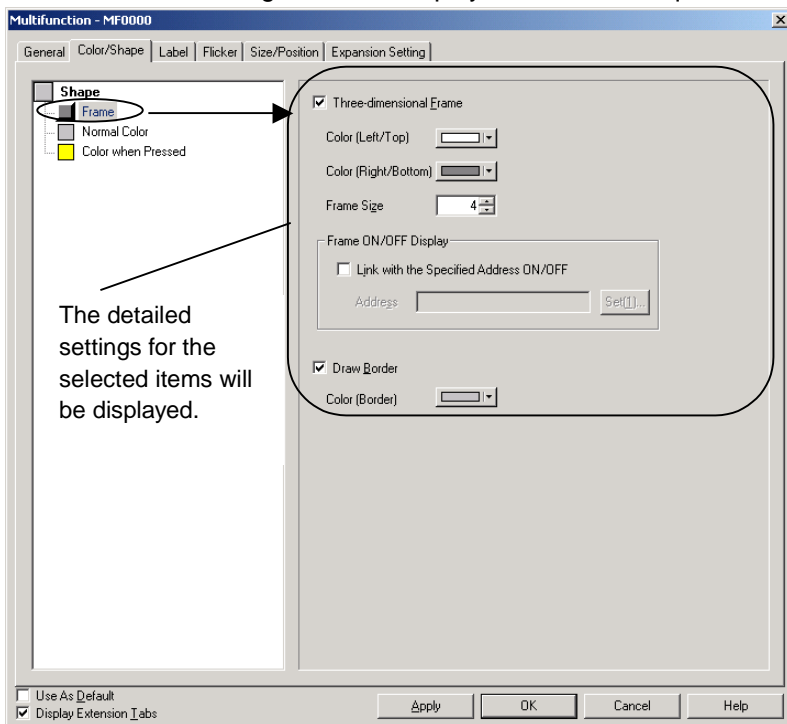

4. Repeat steps 2 to 3 until all the settings have been made.

**NS Series Programming Manual**

The following items are displayed in the Color/Shape List. (The item names depend on the selected combination of *Shape* and *Display Method*.)

Item	Details
Frame	Selected to make the frame settings. The frame settings are made when shapes other than <i>Polygon</i> and <i>Sector</i> are selected.
Shape	Selected to specify the shape file to be displayed. The shape settings are made when <i>Select Shape</i> has been selected under <i>Shape</i> .
Color	Selected to make the color settings. The color settings are made when a selection other than <i>Select Shape</i> has been made under <i>Shape</i> .
Line	Selected to make the displayed line settings. The line settings are made when <i>Polygon</i> and <i>Sector</i> are selected under <i>Shape</i> .
Shade	Selected to make shade settings. The line settings are made when <i>Polygon</i> and <i>Sector</i> are selected under <i>Shape</i> .
Angle	Selected to make the start angle and end angle settings for sectors. The angle settings are made when <i>Sector</i> has been selected under <i>Shape</i> .

**Frame**

Specifies the frame color and size and changes the shape and color of the button. Refer to *Frames in 2-8 Common Functional Object Functions* for details.

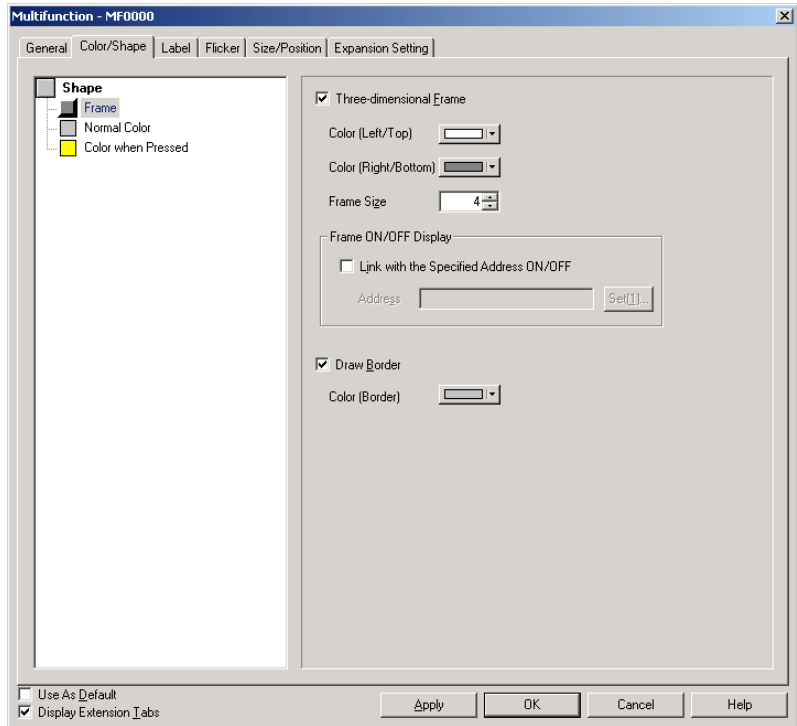

**Shape**

Sets the displayed shape file. Refer to *Selection Shape* in 2-8 Common Functional Object Functions for details.

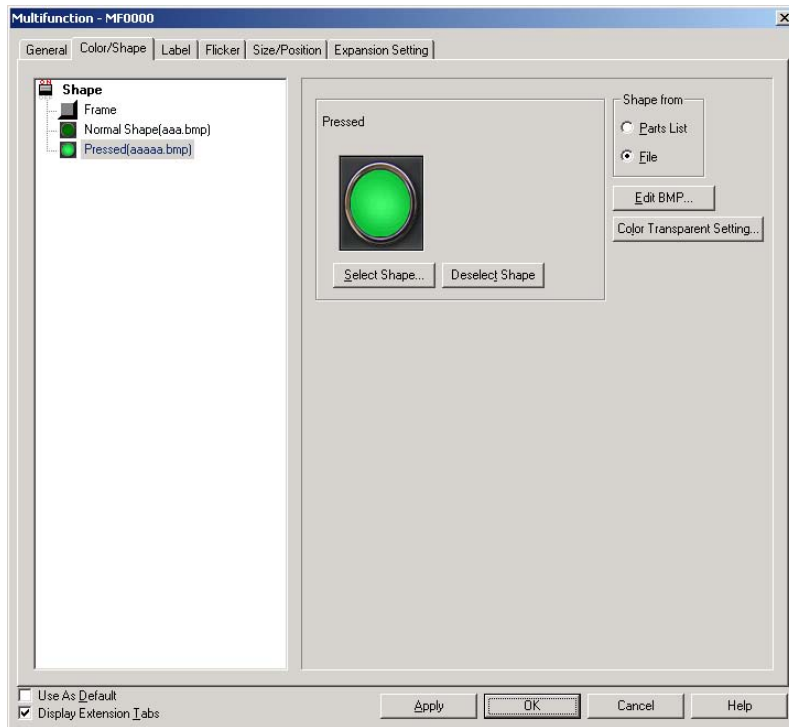

**Color**

Sets the display color. Refer to *Setting Colors* in 2-8 Common Functional Object Functions for details.

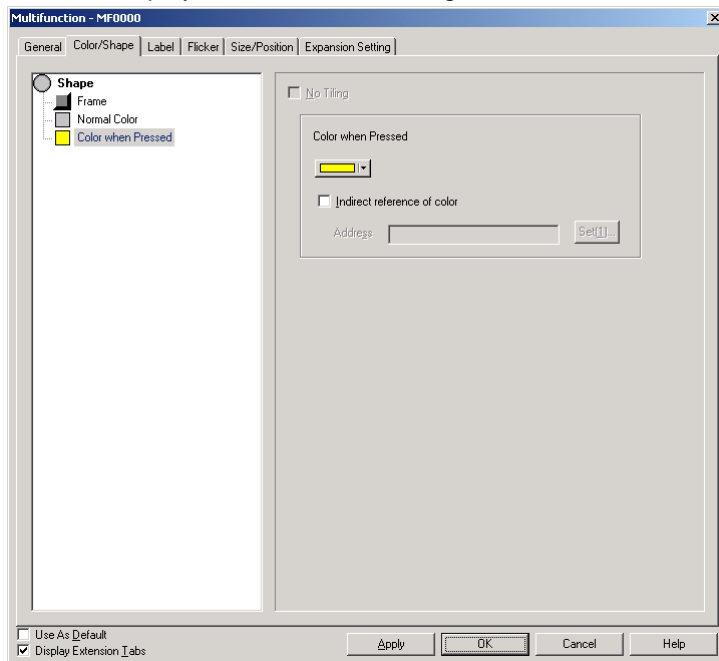

### Line

Sets the line type for polygons and sectors. Refer to *Line* in 2-6 Fixed Objects for details.

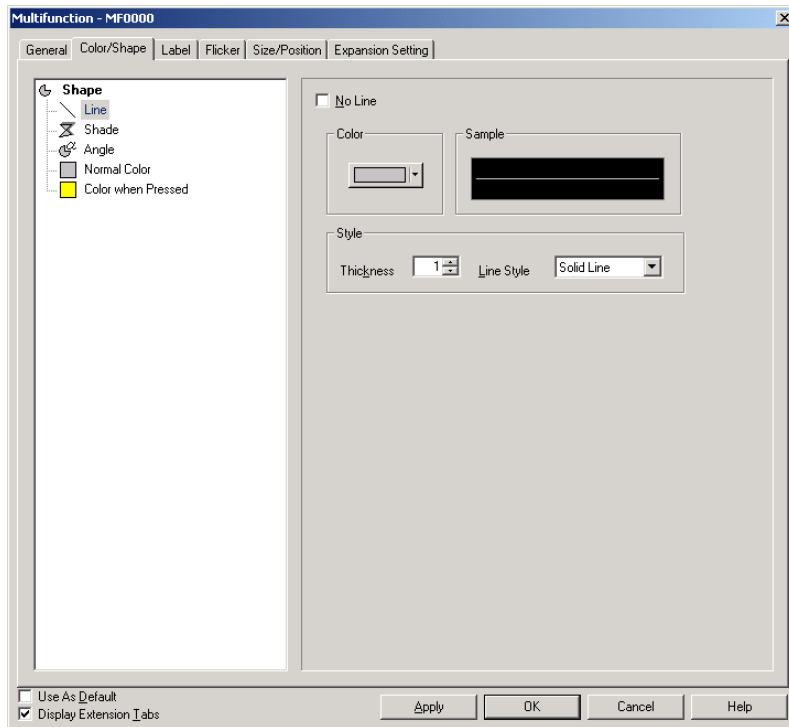

### Shade

Sets the shading for polygons and sectors. Refer to *Frame, Shade, and Beveling* in 2-6 Fixed Objects for details.

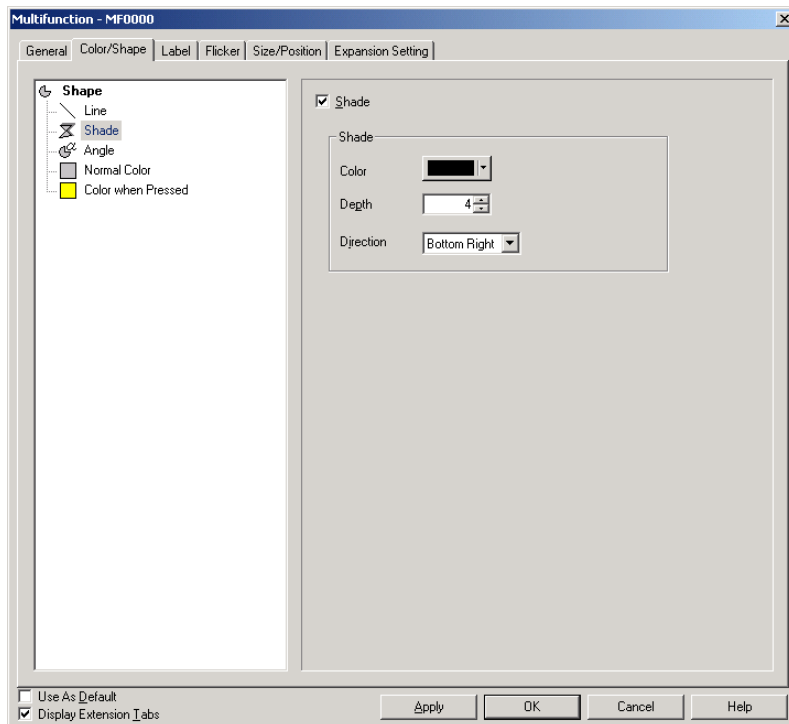

**NS Series Programming Manual**

**Angle**

Sets the start and end angles for polygons and sectors.

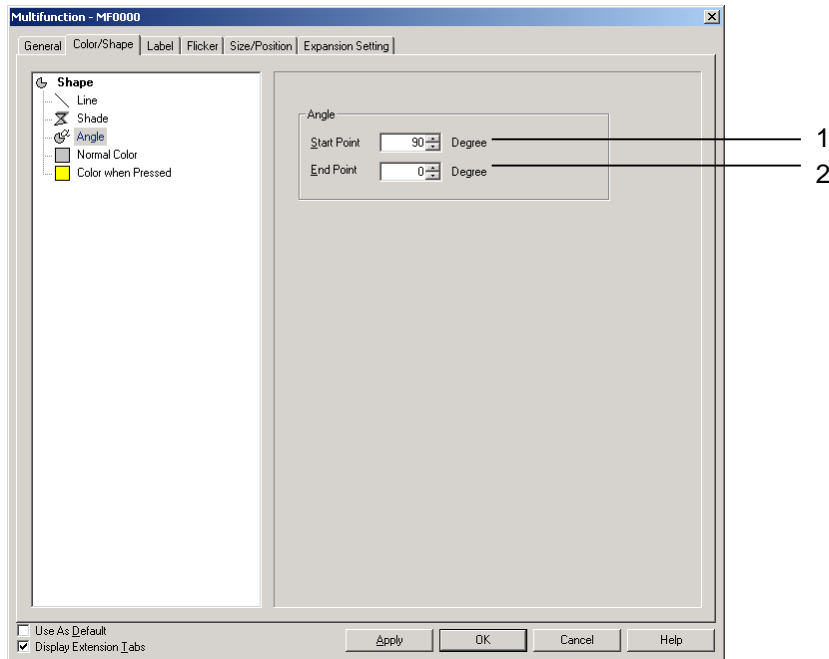

No.	Item	Details
1	Start Point	Sets the start angle between 0 and 359 (°).
2	End Point	Sets the end angle between 0 and 359 (°).

When *Polygon* or *Sector* is selected, the shape can be changed using the following method.

1. Select the Multifunction Object for changing the shape.
2. Select **Edit –Edit Node**.
3. Squares (■) will be displayed at the nodes.
4. Place the node on a corner and, when the cursor shape changes to , drag the node to the desired position.

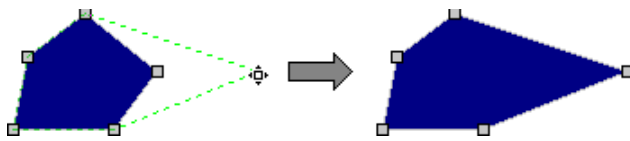

Nodes can be added or deleted for polygons.

5. Press and hold the **Ctrl** Key and bring the cursor close to the outline. When the cursor shape changes to , click on the position on the outline where a node is to be added.

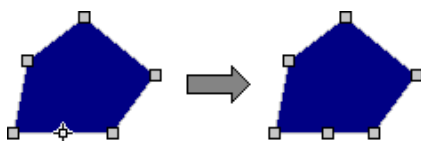

*NS Series Programming Manual*

- Press and hold the **Ctrl** Key and bring the cursor close to the node to be deleted. When the cursor shape changes to **X**, click on the node to be deleted.

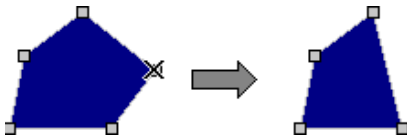

- Right-click to exit the node edit mode.

**Label**

This function sets labels. Refer to *Labels in 2-8 Common Functional Object Functions* for information on basic settings. This section describes the settings for Multifunction Objects only.

The following methods can be used to switch labels using Multifunction Objects.

- Switch labels by pressing the Multifunction Object.
- Switch labels when the specified bit address turns ON/OFF.
- Switch labels by turning ON/OFF a bit address or by pressing the Multifunction Object.
- Switch labels according to the contents of the specified word address.
- Read and display a label string from a specified file.

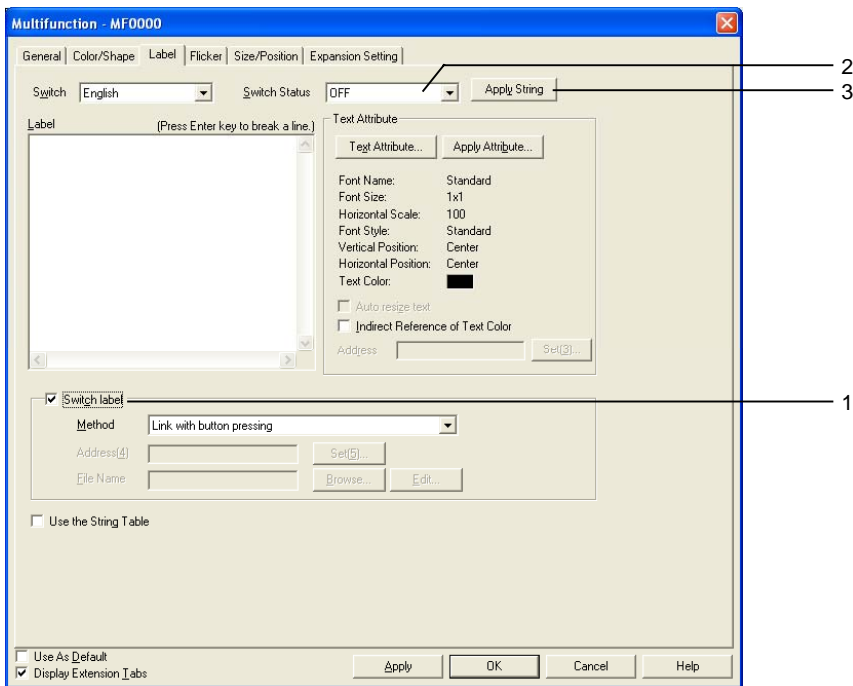

NS Series Programming Manual

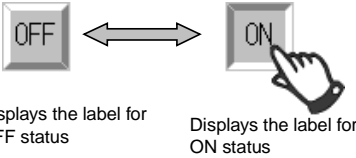
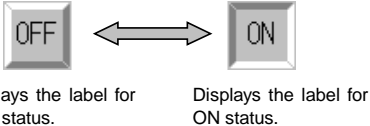
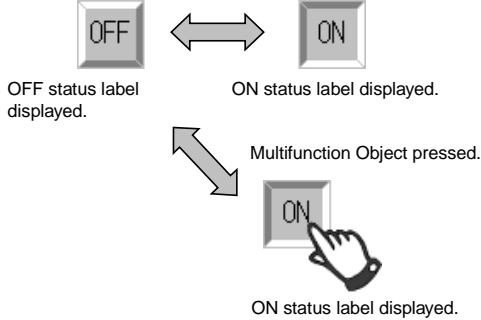
No.	Item	Details
1	Switch labels	<p>Select this checkbox to switch label display and select the method for label switching under <i>Method</i>.</p> <p>Link with button pressing</p> <p>Switches labels when a Multifunction Object is pressed.                      Select <i>OFF</i> under <i>Switch Status</i> and set the label for before the Multifunction Object is pressed.                      Select <i>ON</i> under <i>Switch Status</i> and set the label for when the Multifunction Object is pressed.</p> <p style="text-align: center;">Multifunction Object pressed</p> 
	Link with bit address ON/OFF	<p>Switches the label according to the ON/OFF status of the bit address set under <i>Address</i>.                      Select <i>OFF</i> under <i>Switch Status</i> and set the label for when the bit address is OFF.                      Select <i>ON</i> under <i>Switch Status</i> and set the label for when the bit address is ON.</p> <p style="text-align: center;">Bit address OFF                      Bit address ON</p> 
	Link with bit address ON/OFF/ button pressing	<p>Switches the labels when the bit address set under <i>Address</i> turns ON or OFF or when the Multifunction Object is pressed.                      Select <i>OFF</i> under <i>Switch Status</i>, set the label for when the bit address and button are OFF, and set the label for when the bit address and button are ON.</p> <p style="text-align: center;">Bit address OFF                      Bit address ON</p>  <p>If the bit address is turned OFF while the Multifunction Object is being pressed, an ON status label will be displayed.</p>

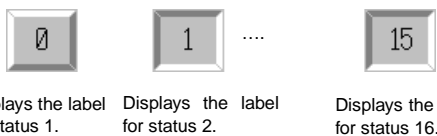
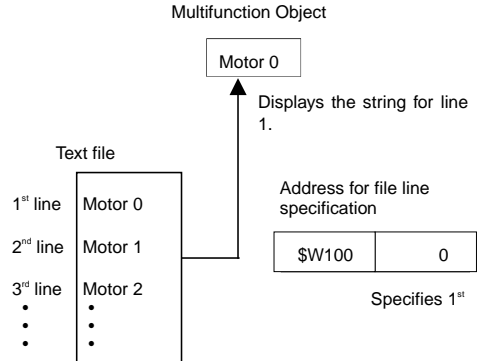

NS Series Programming Manual

No.	Item	Details
1	Link with word address value	<p>Switches the label according to the value (0 to 15) of the word address set under <i>Address</i>.</p> <p>Select <i>Status 1 (Value 0)</i> to <i>Status 16 (Value 15)</i> under <i>Switch Status</i> and set the label to be displayed according to the word address value (0 to 15).</p> <p>Word address value 0      Value 1      Value 15</p>  <p>Sets the contents of the word address as a binary value.</p> <p>Labels will not be displayed when the word address is set to values other than 0 to 15.</p>
	Refer to the file	<p>Reads and displays the string at the line in the text file set under <i>File Name</i>. The line is specified by the value at the word address specified under <i>Address</i>.</p> <p>The first line is specified as 0.</p>  <p>Labels will not be displayed when the word address is set to a value outside the range.</p>
2	Switch Label	Switches the status for setting labels.
3	Apply String	<p>Uses the current character string for all object states. The string is used as the label not only for the selected object, but for all other object states as well.</p> <p>If the Switch Status cannot be set, then the Apply String Button can also not be set.</p>

**Note**

- ◆ The file name specifications for the text file set under *File Name* when *Refer to the file* is selected are as follows:  
 File name: 8 characters + extension (txt)  
 The following characters can be used in the file name. Double-byte characters cannot be used.  
 English alphanumeric, underscore (\_), dollar sign (\$), and period (.)

### Flicker (Extension Tab)

Make settings on the Flicker Tab Page to make functional objects flicker (flash). Refer to *Flicker* in 2-8 *Common Functional Object Functions* for information on basic settings. This section describes the settings for Multifunction Objects only.

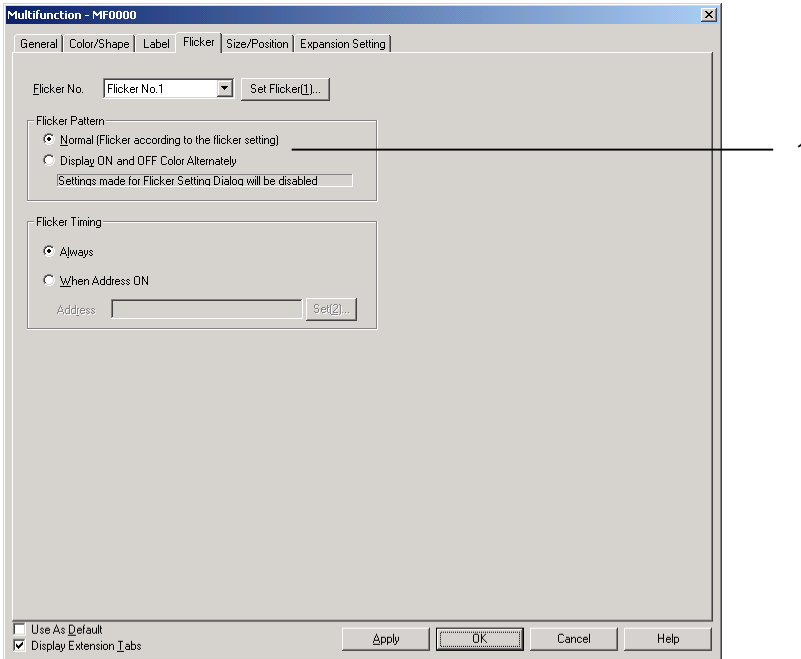

No.	Item	Details
1	Flicker Pattern	Used to set either flicker according to the flicker colors selected under <i>PT – Flicker – Flicker settings</i> or flicker using the ON/OFF colors set on the Color/Shape Tab Page. The <i>Display ON and OFF Color Alternately</i> Option can be selected only when the following options are set under <i>Flicker Pattern</i> on the Color/Shape Tab Page. Color when pressed Bit address Bit Address/Color when pressed

### Size/Position (Extension Tab)

Displays and sets the size and position of functional objects. Refer to *Size/Position* in 2-8 *Common Functional Object Functions* for details.

### Expansion Settings (Extension Tab)

Used to set the operations when writing to or reading from communications addresses.

Refer to the previous section 2-11-4 *Writing and Reading Communications Addresses* for details of operations.

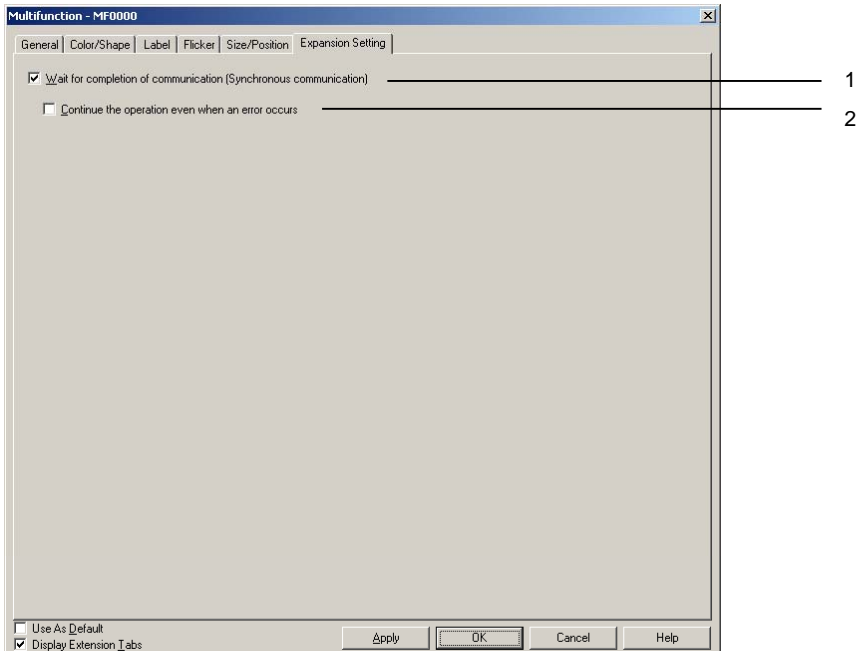

No.	Item	Details
1	Wait for completion of communication (Synchronous communication)	When this checkbox is selected, the next operation will be started only after the read/write results response has been received. When this checkbox is not selected, the next operation will be started without waiting for the read/write results response.
2	Continue the operation even when an error occurs	Sets whether or not to execute the next operation after an error has occurred when reading or writing to a communications address. When this option is not selected, the Multifunction Object execution stops when a communications error occurs. When this option is selected, the next operation is executed even if a communications error occurs. This option is enabled only when the Wait for completion of communication (Synchronous communication).

## 2-12 Display and Input Objects

Display and input functional objects set and display the contents of a specified address on the allocated host. Numeral display and input, string display and input, thumbwheel switch, and list selection are available.

### 2-12-1 Numeral Display and Input

Numeral display and input objects display the numeric contents of a specified address and enable the contents to be changed by numeric input from the tenkey pad.

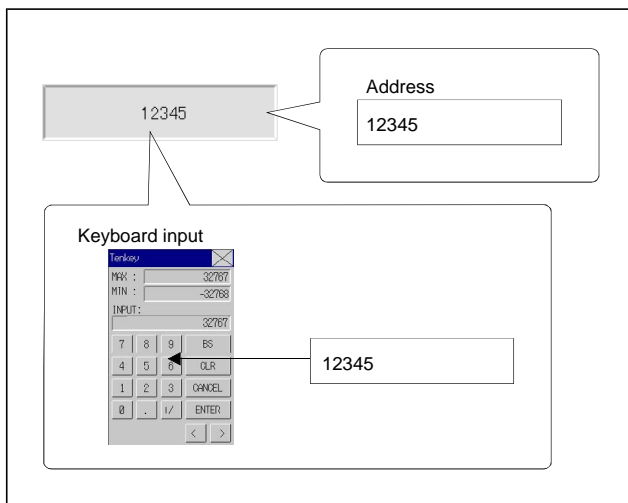

Select **Functional objects - Numeral display & input** or the  icon in CX-Designer to create a numeral display and input object.

#### Note

- ◆ The numeral display and input object can be used for numeral display only (i.e., no input) by changing the control flag settings.

Input is enabled under the default control flag settings. The following procedure must be performed to use the display-only function.

1. Display the Numeral Display and Input Functional Object Properties Dialog Box.
2. Click *Display Extension Tabs* and select the displayed Control Flag Tab Page.
3. Select either *Enable* or *Disable under the Input*.

## Settings for Functional Object Properties

This section describes the settings in the Functional Object Properties Dialog Box for numeral display and input.

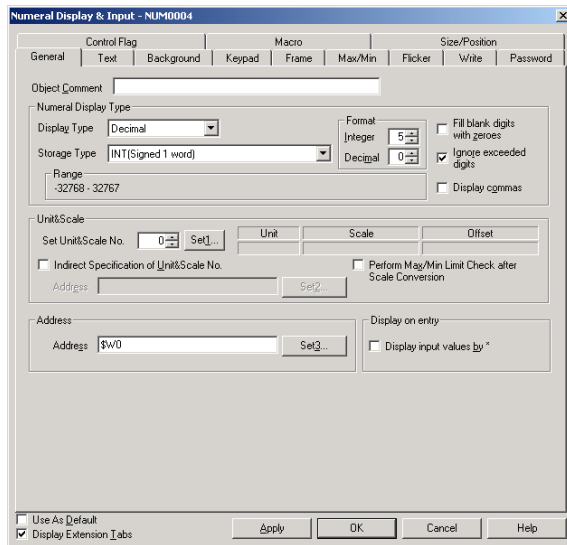

General	Sets the address and numeral display type and units.
Text:	Sets the text attributes for the displayed numerals.
Background:	Sets the background color for numeral display.
Keypad:	Sets the input method and display position and size of the keypad.
Frame:	Sets the frame display for numeral display.
Max/Min:	Sets the maximum and minimum limits for input. This Tab Page also sets the watch minimum limit and watch maximum limit, as well as the colors displayed when the input exceeds the watch minimum or watch maximum limit value. (See note.)
Flicker:	Sets the flicker display. (See note.)
Write:	Sets whether or not a confirmation message is displayed when values are written to addresses. (See note.)
Password:	Sets whether or not a password input field is displayed when values are written to addresses. (See note.)
Control Flag:	Sets enable/disable input and display/no display for objects. (See note.)
Macro:	Sets macros that operate when values are input or address contents change. (See note.)
Size/Position:	Sets the object size and position. (See note.)

Note: These tabs are displayed when the *Display Extension Tabs* Option is selected.

**NS Series Programming Manual**

**General Tab Page**

Sets the address and numeral display type and units.

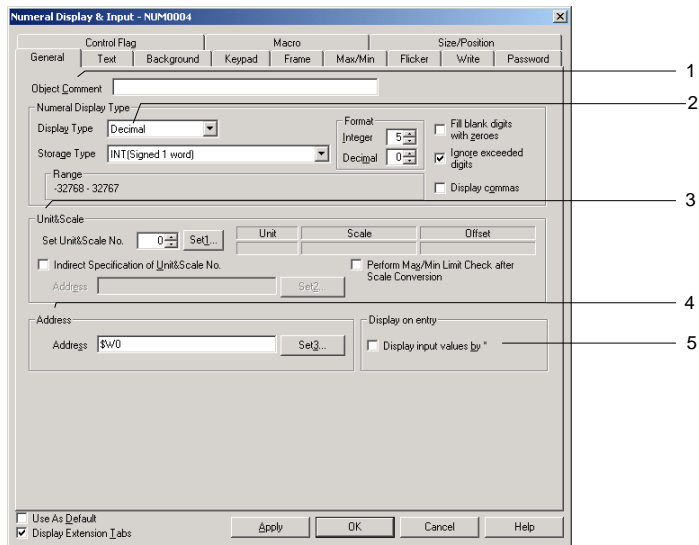

No.	Setting	Details							
1	Object Comment	Sets an explanatory comment for the pasted object. (Up to 32 characters.)							
2	Numeral display type	Various numeral displays can be set through a combination of display and storage types. Refer to <i>Numeral Display and Storage Type (General Tab)</i> in 2-8 Common Functional Object Functions for details on numeral display and storage types.							
	Display type	Select from the following 4 display formats. Decimal Hexadecimal Binary Octal							
	Storage type	Select from the following 11 storage formats. INT (See note 1.) signed, 1 word UINT unsigned, 1 word DINT (See note 1.) signed, 2 words UDINT unsigned, 2 words REAL (real number) (See note 1.) BCD2 (See note 1.) unsigned, 1 word BCD2 (See note 1.) unsigned, 2 words BCD1 signed (leftmost digit: F), 1 word (See note 1.) BCD1 signed (leftmost digit: F), 2 words (See note 1.) BCD2 signed (leftmost bit: 1), 1 word (See note 1.) BCD2 signed (leftmost bit: 1), 2 words (See note 1.)							
	Integer Decimal	Specifies the number of display digits for integers and decimals. The numeral display can be changed to any format. Fractions can only be set when <i>Decimal</i> is selected as the display format. Example: When set to 2 integer digits, 1 decimal place, and to not ignore extra digits: <table border="1" style="margin-left: auto; margin-right: auto;"> <thead> <tr> <th>Actual value</th> <th>Numeral display</th> </tr> </thead> <tbody> <tr> <td>9.51</td> <td>9.5</td> </tr> <tr> <td>99.51</td> <td>99.5</td> </tr> <tr> <td>999.51</td> <td>999.5</td> </tr> </tbody> </table> As shown in the above table, only the decimal fraction is rounded off to the specified number of digits.	Actual value	Numeral display	9.51	9.5	99.51	99.5	999.51
Actual value	Numeral display								
9.51	9.5								
99.51	99.5								
999.51	999.5								
	Fill blank digits with zeros	Inserts zeros to fill the specified number of display digits. For example, if the number of display digits is set to 4 and the value is 1, the display will be 0001.							

No.	Setting	Details
	Ignore exceeded digits	Ignores digits over specified number of display digits. For example, if the number of display digits is set to 2 and the value is 123, the display will be 23.
2	Display commas	Inserts a comma every 3 digits.
3	Unit and scale	Converts the contents of the address to the set scale and displays the value with units. Tick <i>Perform Max/Min Limit Check after Scale Conversion</i> to execute the check of maximum and minimum limits after the contents have been converted to the set scale. Refer to <i>Unit and Scale</i> in 2-8 <i>Common Functional Object Functions</i> for information on units and scales.
4	Address	Sets the destination address accessed and written to by numeral display and input functional objects. Only a word address can be set.
5	Display on entry	If <i>Display input characters by *</i> is selected, characters input using the virtual keyboard or the Key Buttons or characters being monitored are indicated by *.

Note 1. Can be selected only when display format is set to *Decimal*.

2. When set to *Fill blank digits with zeros*, 9.51 in the example in the table will be displayed as 09.51. Tick *Display commas* to insert commas after every 3 digits in an integer, e.g., 999,999.

The number of digits that can be input is as follows:

1. For signed values with no decimal places = No. of integer digits + 1 (for sign)
2. For signed values with decimal places = No. of integer digits + No. of decimal places + 1 (for sign) + 1 (for decimal point)
3. For unsigned values with no decimal places = No. of integer digits
4. For unsigned values with decimal places = No. of integer digits + No. of decimal places + 1 (for decimal point)

### Note

◆ When pasting CX-Designer functional objects, use the numeral 9 and create a number such as 9,999.99 to set the number of display digits by default.

◆ If the unit and scale are set and values input using a numeral display and input functional object, the value converted using the magnification (scale) and offset is stored in the specified address.

For example, if *Decimal* and *INT* are selected under *Numeral display type*, a scale of 10 and offset of 0 are selected under *Unit and scale*, and 30 is input from the tenkey pad for the object, the value stored to the address will be the input value (30) divided by the scale (10), i.e., 3.

The decimal places will be rounded off.

For example, if the input value is 37, the result of the division by the scale of 10 will be 3.7. However, with the rounding off of the decimal points, the value stored to the address will be 4.

◆ If a decimal with many digits is set as the scale, the test and PT display values may differ. The contents of the address, however, will be the same.

**NS Series Programming Manual**

**Text Tab Page**

Sets the text attributes, such as font and color, for the display string. Refer to *Text Attributes* under 2-8 *Common Functional Object Functions* for details.

**Background Tab Page**

Set the fill color for the background of functional objects. Refer to *Setting Colors* under 2-8 *Common Functional Object Functions* for details.

**Keypad Tab Page**

Sets the display position and size of the keypad.

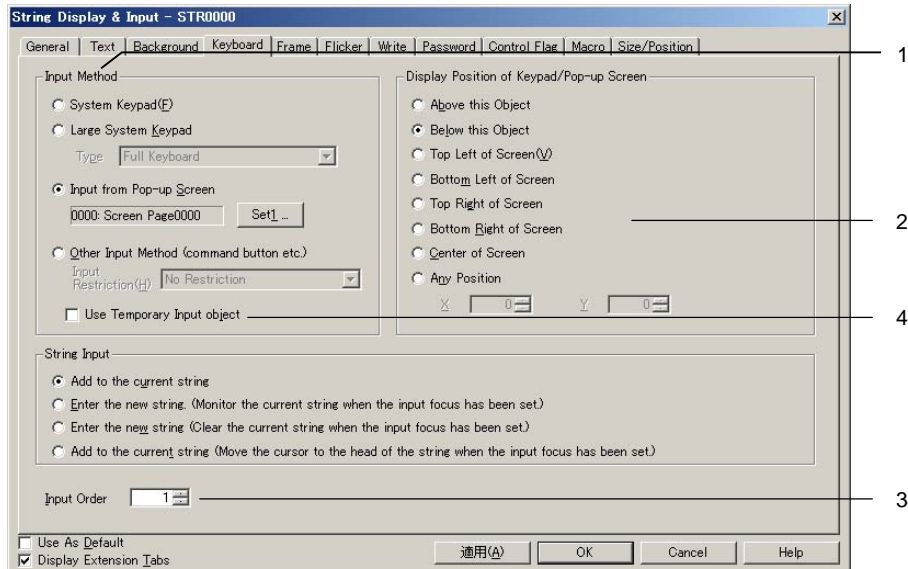

No.	Setting	Details
1	Input method	Select one of the following input methods for numerals. System keypad. Large system keypad. Input from a pop-up screen Other input method (e.g., using Command Buttons) The input method can be restricted to use only functional objects or barcodes.
2	Display Position of Keypad/Pop-up Screen	Select one of the following display positions for keypad and pop-up screen display for numeric input. Below This Object Above This Object Top left, bottom left, top right, bottom right, or center of screen Any Position (The top left position of the keypad or pop-up screen is specified.)
3	Input Order	Set the order for moving the input focus. Refer to 2-8 <i>Common Functional Object Functions</i> .
4	Use Temporary Input object	Select to use a temporary input object when inputting a value. Selection is possible only when <i>Input from Pop-up Screen</i> or <i>Other Input Method (command button etc.)</i> is set under Input method.

Command Buttons are used for input when *Input from Pop-up Screen* or *Other Input Method* are set. For these options, Command Buttons to which Key Buttons are set must be created on the pop-up screen or the main screen.

Numerals can be input if a numeral display and input object is pressed during PT operation. The specified pop-up screen will be displayed if *Input from a pop-up screen* is set.

Numerals can be input from Command Buttons created on the pop-up screen.



**Note**

- ◆ If the keypad or pop-up screen protrudes outside the main screen, the display position of the keypad or pop-up screen will be automatically adjusted so that it does not protrude.
- ◆ If the keypad or pop-up screen overlaps another functional object, the keypad or pop-up screen will be displayed on top.
- ◆ If *Input from a pop-up screen* or *Other input method* are selected, the focus will shift if an object other than a Command Button to which Key Buttons are set is selected.
- ◆ If *Input from a pop-up screen* is selected as the input method and the pop-up screen is closed during input, the numeral display and input object will continue waiting for input. In such cases, cancel or confirm the input by pressing a Command Button set to send a control code such as CAN or RET. Refer to 2-9-3 *Command Buttons* for information.)
- ◆ There are two types of system keypad: keypads with temporary input and keypads without temporary input. Both types of keypad are displayed as shown below. Switching the keypad type is performed using system bit memory \$SB18.

**\$SB18: ON**

Keypad with Temporary Input

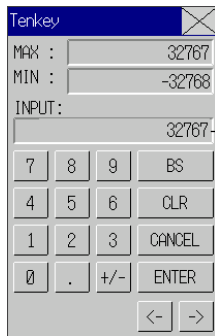

Temporary Input  
Input value will be displayed.

**\$SB18: OFF**

Keypad without Temporary Input

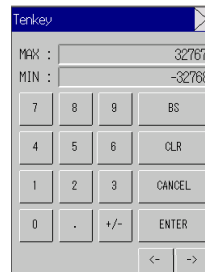

- ◆ If displaying the unit name is specified, it will be displayed in the temporary input field as well.

**Frame Tab Page**

Specify the colors and sizes of the object frame to change the shape or color when the button is depressed or raised. Refer to *Frames* under 2-8 *Common Functional Object Functions* for details.

**NS Series Programming Manual**

**Maximum and Minimum Input Limits Tab Page**

Sets the maximum and minimum limits for input values. A message is displayed and input prevented if a value that exceeds the maximum or minimum limits is entered.

The values set as the maximum and minimum limits are before scale conversion. If a value is set under *Value* that exceeds the input range for the storage type and the OK Button is pressed, a message will be displayed and the setting will not be made.

The same message will be displayed and the setting will not be made if a value is set that exceeds the input range for the storage format, even if unit and a scale are set.

This tab page is also used to set the watch maximum and watch minimum limits for input values, as well as the text color and background color displayed when the watch maximum or watch minimum limit is exceeded.

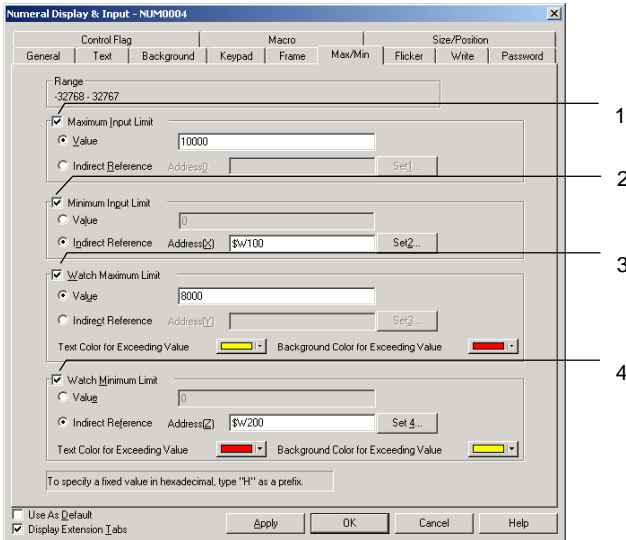

No.	Setting	Details
1	Maximum Input Limit	Sets the maximum limit under the Value or Indirect Reference.
2	Minimum Input Limit	Sets the minimum limit under the Value or Indirect Reference.
3	Watch Maximum Limit	The Watch Maximum Limit can be set as a fixed value or set indirectly through an address. It is also possible to set the text color and background color that will be displayed if this upper limit is exceeded.
4	Watch Minimum Limit	The Watch Minimum Limit can be set as a fixed value or set indirectly through an address. It is also possible to set the text color and background color that will be displayed if this lower limit is exceeded.

Set maximum/minimum limits and watch maximum/minimum limits that suitable for the storage type set on the General Tab Page. If, however, the hexadecimal, binary, or octal display types have been selected, enter a value converted to decimal (UINT or UDINT) or hexadecimal. When inputting data in hexadecimal, input an "H" before the hexadecimal digits.

Refer to *Numeral Display and Storage Type (General Tab)* in *2-8 Common Functional Object Functions* for details on storage types.

**Note**

- ◆ If indirect reference is specified under *Watch Maximum/Minimum Limits* settings, use the same type for the values as set on the General Tab Page for the storage type. For example, if *REAL* (real number) is specified on the General Tab Page, set the maximum and minimum limits as real numbers to the address for indirect reference.
- ◆ Set the maximum and minimum limits before input if they are to be indirectly specified. If the maximum and minimum limits are set using the *Before inputting numeral* macro for the numeral display and input object, those values will not be reflected in the maximum and minimum limit display on the keypad.

**Flicker Tab Page**

Make flicker settings to make the object flicker (flash). Refer to *Flicker* under *2-8 Common Functional Object Functions* for details.

**Write Settings Tab Page**

Use the write settings to display a confirmation dialog box before writing values to a write address. The confirmation message can be changed. Refer to *Write Settings* under *2-8 Common Functional Object Functions* for details.

**Note**

- ◆ The write confirmation dialog box will not be displayed if no value is entered and the ENTER Button on the tenkey pad is pressed or *ENT* or *RET* is sent using a Command Button (Key Button). The contents of the address set under *Turn ON the specified address when the value is confirmed* will not turn ON either.

**Password Tab Page**

A password can be set for when the object area is pressed. Five passwords of up to 16 characters each can be set. One password can be requested for each object. Refer to *Passwords* under *2-8 Common Functional Object Functions* for details.

**Control Flag Tab Page**

Control flags control the input and display of functional objects. Use control flags to enable display or input when the contents of an address turn ON or OFF. Refer to *Control Flags* under *2-8 Common Functional Object Functions* for details.

To display but not input numerals, change the control flag settings to *Disable input*.

**Macro Tab Page**

Macros can be specified for display and input objects.

Macros executed by the following triggers can be registered.

Trigger	Details
Before Inputting Numeral	Executes macro before numeral input starts.
Before Writing Numeral	Executes macro immediately before the numeric value is written.
When Changing Numeral	Executes macro when the numerals change.

A value comparison macro can be registered only for a Numeral Display & Input object.

Trigger	Details
Value = Set value	Executes macro when the value stored at the communications address equals the set value.
Value > Set value	Executes macro when the value stored at the communications address is greater than the set value.
Value < Set value	Executes macro when the value stored at the communications address is less than the set value.

**Note**

- ◆ If the conditions are met at the same time for the *When Changing Numeral* macro and a value-comparison macro (*Value = Set Value*, *Value > Set Value*, or *Value < Set Value*), the *When Changing Numeral* macro will be given priority over the value-comparison macro.

Refer to *NS-series Macro Reference* in the CX-Designer for information on setting methods.

**Size/Position Tab Page**

Displays and sets the functional object size and position. Refer to *Size/Position* under *2-8 Common Functional Object Functions* for details.

**2-12-2 String Display and Input**

String display and input objects are functional objects that convert the contents of a specified address to character string data and display that data. String display and input objects also convert data through character string input from a barcode reader or virtual keyboard.

The string display and input object can be used for string display only (i.e., no input) by changing the control flag settings.

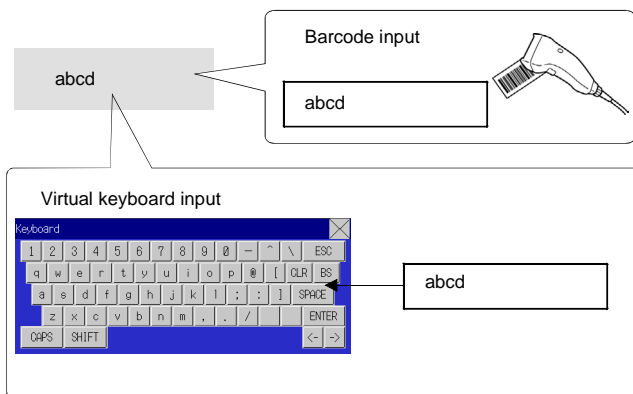

Select **Functional objects – String display & input** or the  icon in CX-Designer to create a string display and input object.

**Note**

- ◆ The string display and input object can be used for string display only (i.e., no input) by changing the control flag settings.

Input is enabled under the default control flag settings. The following procedure must be performed to use the display-only function.

1. Display the String Display and Input Functional Object Properties Dialog Box.
2. Click *Display Extension Tabs* and select the displayed Control Flag Tab Page.
3. Select *Disable* under the *Input*.

**NS Series Programming Manual**

**Settings for Functional Object Properties**

This section describes the settings items in the Functional Object Properties Dialog Box for string display and input.

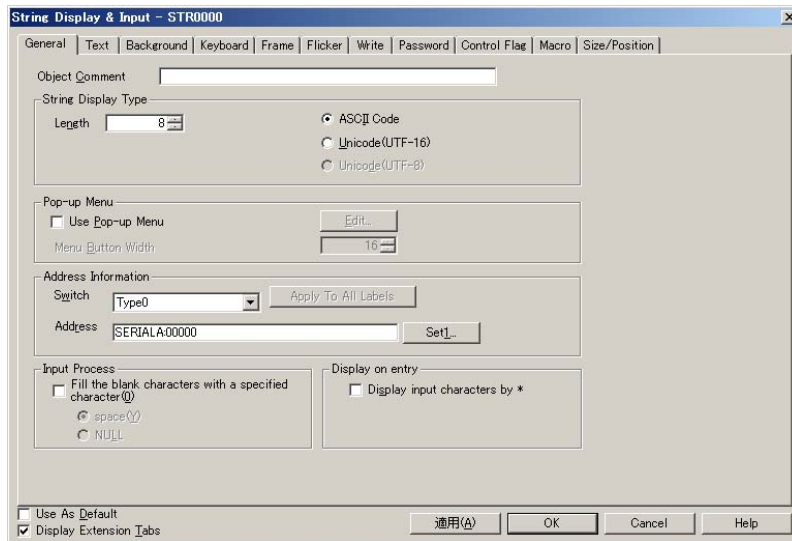

- General:** Sets the address and string display type.
- Text:** Sets the text attributes for the displayed characters.
- Background:** Sets the background color for character string display.
- Keyboard:** Sets the input method and display position and size of the keyboard.
- Frame:** Sets the character string frame display.
- Flicker:** Sets the flicker display. (See note.)
- Write:** Sets whether or not a confirmation message is displayed when character strings are written to addresses. (See note.)
- Password:** Sets whether or not a password input field is displayed when character strings are written to addresses. (See note.)
- Control Flag:** Sets enable/disable input and display/no display for objects. (See note.)
- Macro:** Sets macros that operate when characters are input or character strings change. (See note.)
- Size/Position:** Sets the object size and position. (See note.)

Note: These tabs are displayed when the *Display Extension Tabs* Option is selected.

**General Tab Page**

Sets the address and string display type.

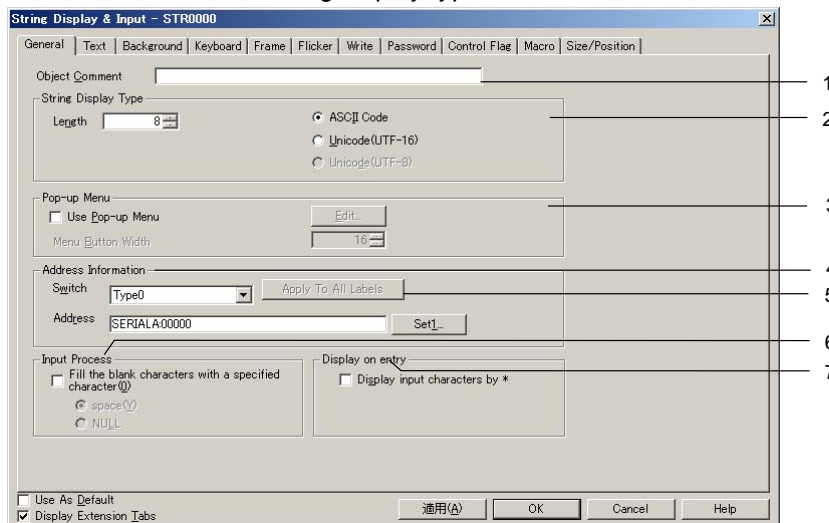

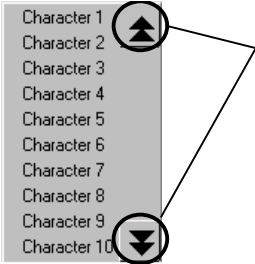
No.	Setting	Details
1	Object Comment	Sets an explanatory comment for the pasted object. (Up to 32 characters.) The set comment can be printed or edited together.
2	String Display Type	Specifies the number of characters and the string display type. ASCII or Unicode (UTF-16) can be specified for the display type. ASCII express half-size characters as 1 byte and full-size characters as 2 bytes. Unicode (UTF-16) expresses all characters as 2 bytes. For example, if "ab" was stored in the start address \$W0, the string would be stored as \$W0=0x6162 in ASCII. In Unicode the string would be stored as \$W0=0x61 and \$W1=0x62.
3	Pop-up menu	Makes settings to enable display strings to be selected from pop-up menus.  At the PT, a scroll bar will be displayed if there are more than ten items on a pop-up menu, as shown on the left. Use the scroll bar to display other items on the menu.
4	Address information	Sets the address to be accessed and written by string display and input object.
5	Apply to All Labels	Uses the address of the selected label for all labels. This setting cannot be made in the following cases. <ul style="list-style-type: none"> <li>• When the <i>Address of String Display &amp; Input object</i> Check Box is selected on the Edit/Display Tab Page of the Option Dialog Box accessed by selecting <b>Tools - Option</b>.</li> <li>• When there is only one label.</li> </ul>
6	Input Process	If the <i>Fill the blank characters with a specified character</i> Option is selected, spaces or nulls are automatically added to the end of strings to fill the space if the number of input characters is less than the set number of characters. For example, if the number of characters has been set to 8 and only the 5 characters ABCDE are input, then 3 spaces will be added: ABCDE@@@ (@ indicates a space). If the <i>Fill the blank characters with a specified character</i> Option is not selected, all characters up to null at the end of the string will be written to the specified address. For example, if the set string is ABCDEFG, when A is written to the address, 0 will be written in place of B, and C and the other characters will not be written. The data is written in word format, so when the string AB is written, CD will be 0.
7	Display on entry	If the <i>Display input characters by *</i> Option is selected, characters input using the virtual keyboard or the Key Buttons or characters being monitored are indicated by *.

### Note

- ◆ To make settings easier to understand when CX-Designer objects are pasted, the number of characters is indicated by using Xs (e.g., XXXXX).
- ◆ If the number of characters or the address is set too high, the maximum address for the specified area may be exceeded, e.g., when the number of words is 256 and the start address is \$W32767. If the maximum address in the area is exceeded, a communications error will occur when the screen to which the string display and input object is set is opened on the PT. Make sure the maximum address is not exceeded.

**NS Series Programming Manual**

- ◆ If ASCII codes are set in string displays, the following character codes will be used by the PT depending on the system language that has been set.

System language	Character display	Example (character code B5)
Japanese	Shift-JIS code	↑
Chinese (traditional or simplified)	GB2312 code	Nothing is displayed because there are no corresponding characters.
Other	Latin 1code	μ

**Text Tab Page**

Sets the text attributes, such as font and color, for the display string. Refer to *Text Attributes* under 2-8 *Common Functional Object Functions* for details.

**Background Tab Page**

Sets the background color for character string display from a selection of 256 colors. Refer to *Background* and *Setting Colors* in 2-8 *Common Functional Object Functions* for details.

**Keyboard Tab Page**

Specifies the display position and size of the keyboard.

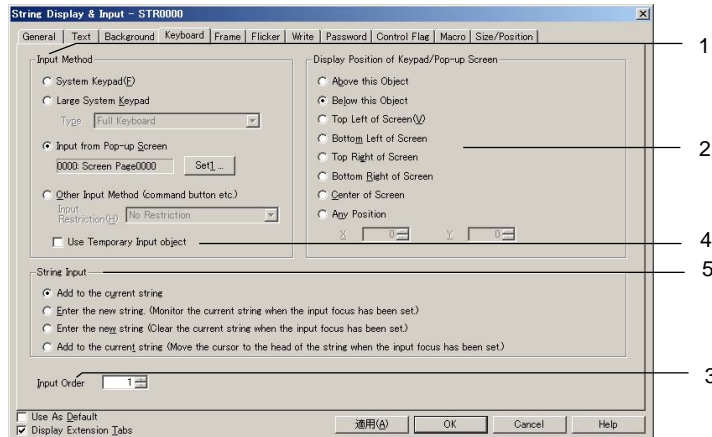

No.	Setting	Details
1	Input Method	Select one of the following input methods for character strings. System keypad. Large system keypad. Select keyboard: Full keyboard, decimal keys, hexadecimal keys, decimal keys (+,-), hexadecimal (+,-), decimal keys (+, -, *, /), or hexadecimal keys (+,-, *, /). Input from a pop-up screen Other input method (e.g., using Command Buttons) The input method can be restricted to use only functional objects or barcodes. Refer to 3-6 <i>Inputting Numerals and Character Strings</i> for information on how to operate these keypads.
2	Display Position of Keypad/Pop-up Screen	Select one of the following display positions for keypad and pop-up screen display for character string input. - Below This Object - Above This Object - Top left, bottom left, top right, bottom right, or center of screen. - Any position



No.	Setting	Details
3	Input Order	Set the order for moving the input focus. Refer to <i>2-8 Common Functional Object Functions</i> .
4	Use Temporary Input object	Select to use a Temporary Input Object when inputting a character string. Selection is possible only when <i>Input from Pop-up Screen</i> or <i>Other Input Method (command button etc.)</i> is set under Input method.
5	String Input	Select one of the following options for the input display field status when inputting character strings. - Add to the current string. - Enter the new string. (Monitor the current string when the input focus has been set.) - Enter the new string. (Clear the current string when the input focus has been set.) - Add to the current string. (Move the cursor to front of string when setting the input focus been set.)

Command Buttons are used for input when *Input from pop-up screen* or *Other input method* are set.

For these options, Command Buttons to which Key Buttons are set must be created on the pop-up screen or the main screen.

Characters can be input if a string display and input object is pressed during PT operation. The specified pop-up screen will be displayed if *Input from a pop-up screen* is set.

Character strings can be input from Command Buttons created on the pop-up screen.

### Reference

- ◆ If the keypad or pop-up screen protrudes outside the main screen, the display position of the keypad or pop-up screen will be automatically adjusted so that it does not protrude.
- ◆ If the keypad or pop-up screen overlaps another functional object, the keypad or pop-up screen will be displayed on top.
- ◆ If *Input from pop-up screen* or *Other input method* are selected, the focus will shift if an object other than a Command Button to which Key Buttons are set is selected.
- ◆ If *Input from pop-up screen* is selected as the input method and the pop-up screen is closed during input, the string display and input object will continue waiting for input. In such cases, cancel or confirm the input by pressing a Command Button set to send a control code such as CAN or RET. Refer to *2-9-3 Command Buttons* for information.
- ◆ The *Add to the current string (Move the cursor to front of string when setting the input focus been set.)* option can be set only for PT system version 8.2 or higher.

### Frame Tab Page

Specify the colors and sizes of the object frame to change the shape or color when the button is depressed or raised.

Refer to *Frames* under *2-8 Common Functional Object Functions* for details.

### Flicker Tab Page

Make flicker settings to make the object flicker (flash). Refer to *Flicker* under *2-8 Common Functional Object Functions* for details.

### Write Tab Page

Use the write settings to display a confirmation dialog box before writing strings to a write address. The confirmation message can be changed. Refer to *Write Settings* under *2-8 Common Functional Object Functions* for details.

### Password Tab Page

A password can be set for when the object area is pressed. Five passwords of up to 16 characters each can be set. One password can be requested for each object. Refer to *Passwords* under *2-8 Common Functional Object Functions* for details.



**Control Flag Tab Page**

Control flags control the input and display of functional objects. Use control flags to enable display or input when the contents of an address turn ON or OFF. Refer to *Control Flags* under *2-8 Common Functional Object Functions* for details.

To display but not input characters strings, change the control flag settings to *Disable input*.

**Macro Tab Page**

Macros can be specified for string display and input objects.

Macros executed by the following triggers can be registered.

Trigger	Details
Before inputting string	Executes macro before string input starts.
Before writing string	Executes macro immediately before the string is written.
When changing string	Executes macro when the string changes.

Refer to *NS-series Macro Reference* in the CX-Designer for information on setting methods.

**Size/Position Tab Page**

Displays and sets the functional object size and position. Refer to *Size/Position* under *2-8 Common Functional Object Functions* for details.

**2-12-3 Thumbwheel Switches**

Thumbwheel switches are objects that increase or decrease numeric data when + or – (increase or decrease) Buttons are pressed and display and set the data. The values of single digits are increased or decreased and the contents of the allocated address is updated each time the value changes.

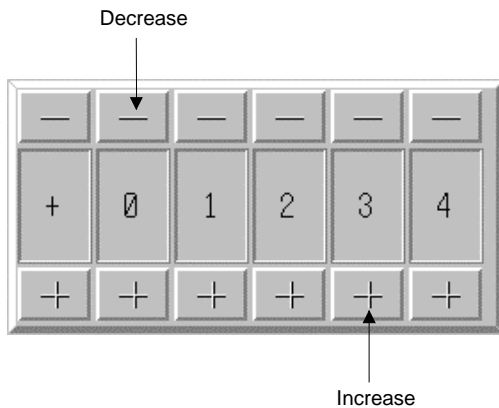

Select **Functional objects - Thumbwheel switch** or the  icon in CX-Designer to create a thumbwheel switch.

**Settings for Functional Object Properties**

This section describes the settings items in the Functional Object Properties Dialog Box for thumbwheel switches.

**NS Series Programming Manual**

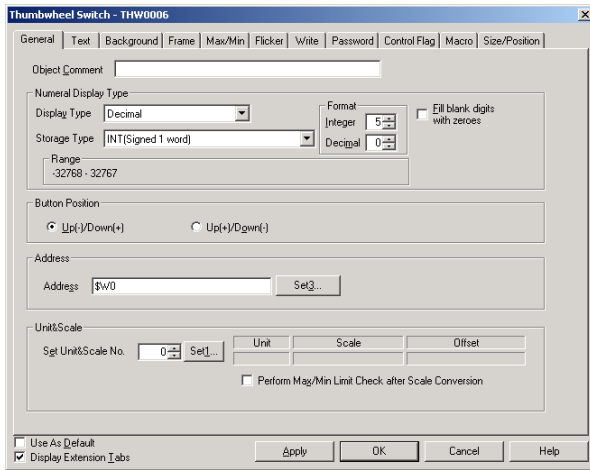

- General: Sets the address and numeral display type.
- Text: Sets the text attributes for the displayed numerals.
- Background: Sets the background color for numeral display.
- Frame: Sets the frame display for numeral display.
- Max/Min: Sets the maximum and minimum limits for input. (See note.)
- Flicker: Sets the flicker display. (See note.)
- Write: Sets whether or not a confirmation message is displayed when values are written to addresses. (See note.)
- Password: Sets whether or not a password input field is displayed when values are written to addresses. (See note.)
- Control Flag: Sets display/no display for objects and enable/disable for input. (See note.)
- Macro: Sets macros that operate when values are input or address contents change. (See note.)
- Size/Position: Sets the object size and position. (See note.)

Note: These tabs are displayed when the *Display Extension Tabs* Option is selected.

**General Tab Page**

Sets the address and numeral display format and units.

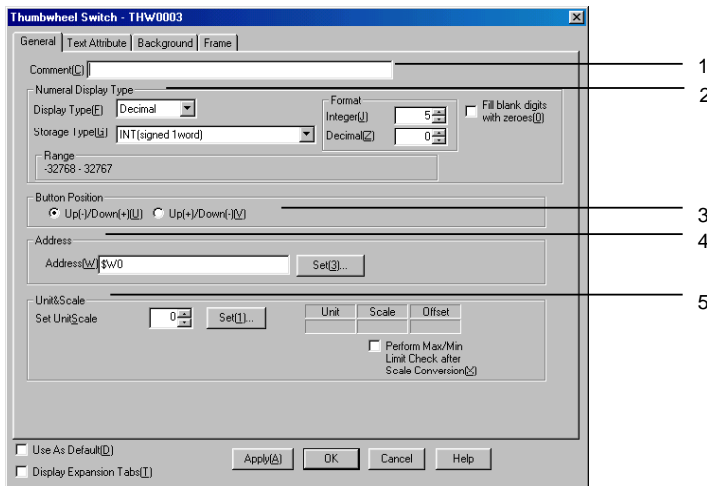

**NS Series Programming Manual**

No.	Setting	Details							
1	Object Comment	Sets an explanatory comment for the pasted object. (Up to 32 characters.)							
2	Numeral display type	Sets the numeral display type.							
	Display type	Select from the following 4 display formats. Decimal Hexadecimal Binary Octal							
2	Storage type	Select from the following 11 storage types. INT signed, 1 word UINT unsigned, 1 word DINT signed, 2 words UDINT unsigned, 2 words REAL (real number) (See note 1.) BCD2 (See note 1.) unsigned, 1 word BCD2 (See note 1.) unsigned, 2 words BCD1 signed (leftmost digit: F), 1 word (See note 1.) BCD1 signed (leftmost digit: F), 2 words (See note 1.) BCD2 signed (leftmost bit: 1), 1 word (See note 1.) BCD2 signed (leftmost bit: 1), 2 words (See note 1.)							
	Integer Decimal	Specifies the number of display digits for the integer and decimals. The numeral display can be changed to any format. Example: When set to 2 integers and 1 decimal place: <table border="1" data-bbox="518 913 917 1025"> <thead> <tr> <th>Actual value</th> <th>Numeral display</th> </tr> </thead> <tbody> <tr> <td>9.51</td> <td>9.5</td> </tr> <tr> <td>99.51</td> <td>99.5</td> </tr> <tr> <td>999.51</td> <td>99.5</td> </tr> </tbody> </table> <p>As shown above, digits after the specified number of integers are ignored. The decimal is rounded to the specified number of digits.</p>	Actual value	Numeral display	9.51	9.5	99.51	99.5	999.51
Actual value	Numeral display								
9.51	9.5								
99.51	99.5								
999.51	99.5								
	Fill blank digits with zeros (See note 2.)	Inserts zeros to fill the specified number of display digits. For example, if the number of display digits is set to 4 and the value is 1, the display will be 0001.							
3	Button position	Sets the position for the + and – Buttons.							
4	Address	Sets the destination address accessed and written by thumbwheel switches.							
5	Units and scales	Scales the contents of the communications address using the set scale value. Click <i>Limit check after scale conversion</i> to check the upper and lower limits after the contents have been converted using the set scale. Refer to <i>Unit and Scale</i> in 2-8 <i>Common Functional Object Functions</i> for information on units and scales.							

- Note 1. Can be selected only when display type set to *Decimal*.  
 2. When set to *Fill blank digits with zeros*, 9.51 in the example in the table will be displayed as 09.51.

**Note**

- ◆ When pasting CX-Designer functional objects, use the numeral 9 and create a number such as 9,999.99 to set the number of display digits by default.
- ◆ For real numbers, 7 digits are valid. If the number of display digits is set higher than 7, error will occur when numbers are input and the values may change for digits that are not input.
- ◆ If a value that cannot be displayed at the address is stored, e.g., 10 (a binary value) has been stored when the display type is BCD, # will be displayed for every digit. When this happens, the + and – Buttons cannot be used to change the value. Use the PLC or another functional object to reset the value.
- ◆ Units cannot be displayed for thumbwheel switches.
- ◆ The scale for a thumbwheel switch must be set to a power of 10, and the offset must be set to 0. If any other values are set, the thumbwheel switch may not operate properly.

**Text Tab Page**

Sets the text attributes, such as font and color, for the display string. Refer to *Text Attributes* under 2-8 *Common Functional Object Functions* for details.

**Background Tab Page**

Sets the background color for thumbwheel switches from a selection of 256 colors. Refer to *Setting Colors* under 2-8 *Common Functional Object Functions* for details.

**Frame Tab Page**

Specify the colors and sizes of the object frame to change the shape or color when the button is depressed or raised. Refer to *Frames* under 2-8 *Common Functional Object Functions* for details.

**Max/Min Tab Page**

Set the maximum and minimum limits for the contents of the write address. The setting range for maximum and minimum limits depends on the numeral display type.

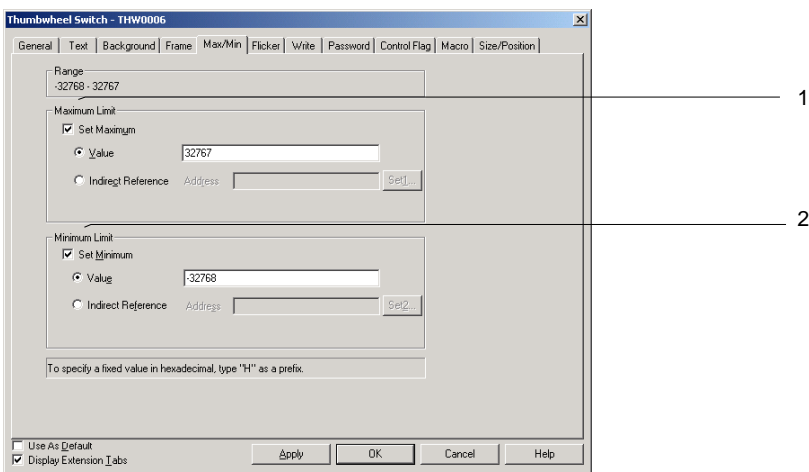

No.	Setting	Details
1	Maximum limit	Sets the maximum limit. Select either value or indirect reference.
2	Minimum limit	Sets the minimum limit. Select either value or indirect reference.

Set maximum and minimum limits suitable for the storage type set on the General Tab Page. If, however, the hexadecimal, binary, or octal display types have been selected, enter a value converted to decimal (UINT or UDINT). Refer to *Numeral Display and Storage Type (General Tab)* in 2-8 *Common Functional Object Functions* for details on storage types.

**Note**

- ◆ If indirect reference is specified under the maximum and minimum limits, use the same type for the values as set on the General Tab Page for the storage type. For example, if *REAL* (real number) is specified on the General Tab Page, set the maximum and minimum limits as real numbers.
- ◆ If a value is written from the PLC or another functional object that exceeds the set maximum or minimum limits, the + and – Buttons can no longer be used to change the value. Use the PLC or another functional object to reset the value.

**Flicker Tab Page**

Make flicker settings to make the object flicker (flash). Refer to *Flicker* under 2-8 *Common Functional Object Functions* for details.

**Write Tab Page**

Use the write settings to display a confirmation dialog box before writing values to a write address. The confirmation message can be changed. Refer to *Write Settings* under *2-8 Common Functional Object Functions* for details.

**Password Tab Page**

A password can be set for when the object area is pressed. Five passwords of up to 16 characters each can be set. One password can be requested for each object. Refer to *Passwords* under *2-8 Common Functional Object Functions* for details.

**Control Flag Tab Page**

Control flags control the input and display of functional objects. Use control flags to enable display or input when the contents of an address turn ON or OFF. Refer to *Control Flags* under *2-8 Common Functional Object Functions* for details.

To display but not input numerals, change the control flag settings to *Disable input*.

**Macro Tab Page**

Macros can be specified for string display and input objects. Macros executed by the following triggers can be registered.

Trigger	Details
Before writing numeral	Executes macro immediately before the numeric value is written.
When Changing numeral	Executes macro when the numerals change.

Refer to *NS-series Macro Reference* in the CX-Designer for information on setting methods.

**Size/Position Tab Page**

Displays and sets the functional object size and position. Refer to *Size/Position* under *2-8 Common Functional Object Functions* for details.

### 2-12-4 List Selection

List selection objects display and select character string data. Character strings to be displayed in lists can be selected from specified addresses or text files.

List selection objects can write the selected line or string information to a specified address, allowing the string information to be received and used by the host. List strings to be displayed from the host can also be specified.

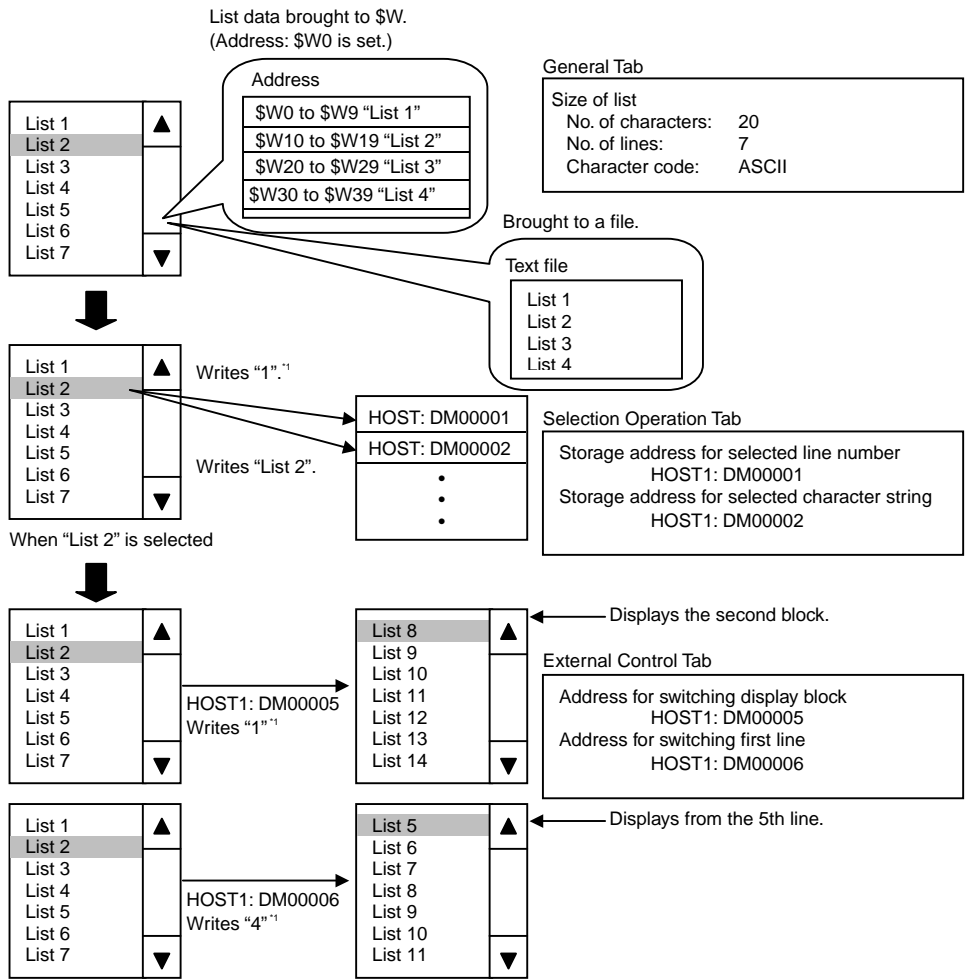

\*1: The counting for block numbers starts with "0."

ASCII or Unicode can be selected as the character code for list text strings to be assigned to addresses.

Note: ASCII characters use one byte per half-size character and two bytes per full-size character. Unicode characters use two bytes for any character.

Select **Functional objects - List selection** or the  icon in CX-Designer to create a list selection object.

## Settings for Functional Object Properties

This section describes the settings items in the Functional Object Properties Dialog Box for list selection.

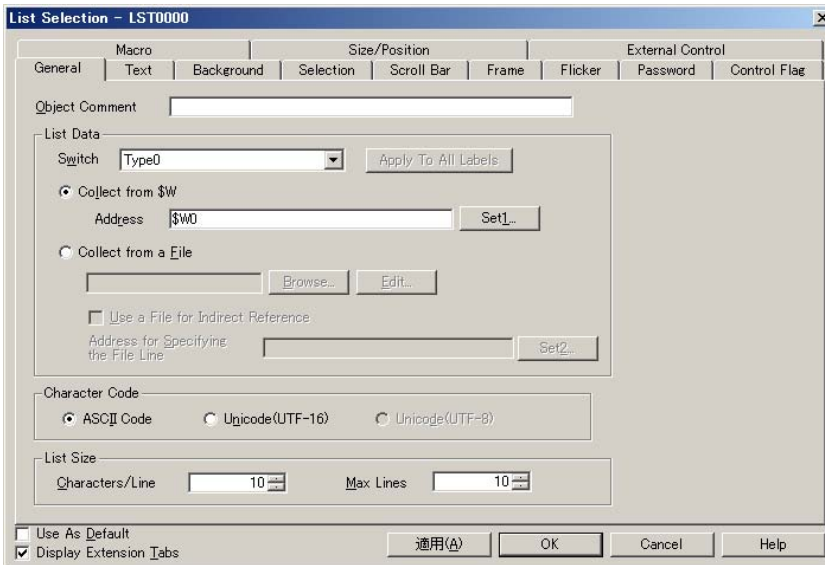

General:	Sets the reference destination for list data, list size, and object comment.
Text:	Sets the text attributes for the displayed string.
Background:	Sets the background color for the list selection object.
Selection:	Sets the selection bar color, selected line number, and string destination.
Scroll bar:	Sets the scroll bar size and scroll width.
Frame:	Sets the list selection frame display.
Flicker:	Sets the flicker display. (See note.)
Password:	Sets the password to be entered when a button is pressed. (See note.)
Control Flag:	Sets enable/disable input and display/no display for objects. (See note.)
Macro:	Sets macros that operate when lists are selected. (See note.)
Size/Position:	Sets the object size and position. (See note.)
External Control:	Sets switching of displayed block position from an external device. (See note.)

Note: These tabs are displayed when the *Display Extension Tabs* Option is selected.

**NS Series Programming Manual**

**General Tab Page**

Sets the list data, number of characters, and number of lines to be displayed.

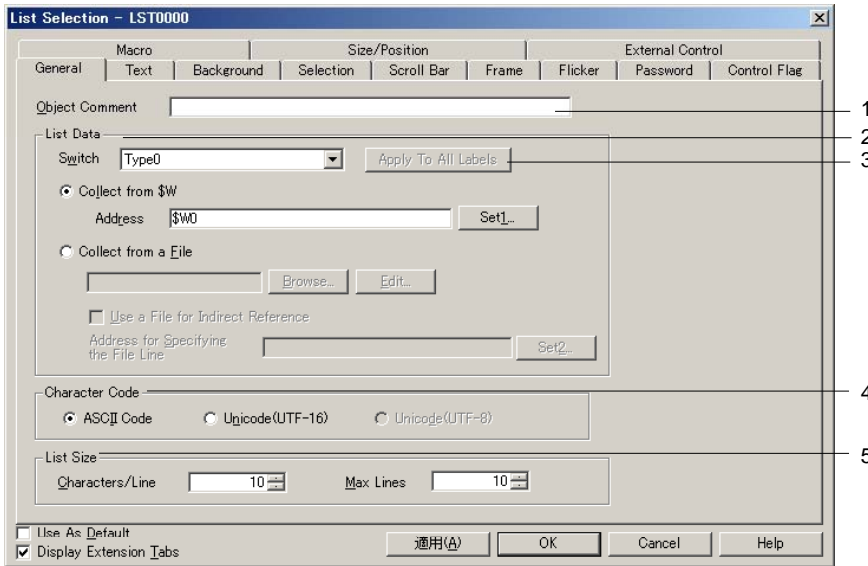

No.	Setting	Details
1	Comment	Sets an explanatory comment for the pasted object. (Up to 32 characters.)
2	List data	Browses for a specified address or text file for strings to be displayed in the list. If <i>Store in \$W</i> is selected, the string data stored after a specified address will be displayed. If <i>Store in a file</i> is selected, the string in a specified text file will be displayed. If storing strings in text files for display using a list selection object, make the text file extension .LST. The file name can be up to 12 characters, including the .LST extension. Click the <b>Edit</b> Button to open the text editor specified under CX-Designer <i>Options</i> (Notepad is the default text editor) and edit the currently selected text file. The file to be read can also be specified indirectly. Select <i>Use a file for indirect reference</i> and specify <i>Store in a file</i> for the LST file that created the list of file names to be read. The list file that will be read will switch based on the contents of the address specified under <i>Address for Specifying the File Line</i> .
3	Apply to All Labels	Applies the following items to all of the selected labels: <ul style="list-style-type: none"> <li>• Store in &amp;W: Address set value</li> <li>• Store in file: File name</li> </ul> Apply to All Labels cannot be set in the following cases. <ul style="list-style-type: none"> <li>• When the <i>List data of List Selection object</i> Check Box is selected on the Edit/Display Tab Page of the Option Dialog Box accessed by selecting <b>Tools - Option</b>.</li> <li>• When there is only one label.</li> </ul>
4	Character code	Select whether the string in the address or text file will be in ASCII or Unicode (UTF-16).
5	List size	Specifies the number of characters per line and the number of lines in a list. Specifies the number of half-size characters when ASCII has been set. Full-size characters are counted as two characters. For Unicode characters, all characters are counted as one character.  1 to 256 characters per line  1 to 1,024 lines max.



**NS Series Programming Manual**

If list strings are held in internal memory at \$W, the settings will be as shown below because \$W is one word (two bytes) in length.

When list size in the list selection settings is set to 64 characters per line with a maximum of 4 lines and the address is set to \$W0:

**ASCII (Half-size Characters: 1 byte; Full-size characters: 2 bytes)**

\$W0 to \$W31	1 <sup>st</sup> line string
\$W32 to \$W63	2 <sup>nd</sup> line string
\$W64 to \$W95	3 <sup>rd</sup> line string
\$W96 to \$W127	4 <sup>th</sup> line string

**Unicode Characters (1 character: 2 bytes)**

\$W0 to \$W63	1 <sup>st</sup> line string
\$W64 to \$W127	2 <sup>nd</sup> line string
\$W128 to \$W191	3 <sup>rd</sup> line string
\$W192 to \$W255	4 <sup>th</sup> line string

If the character string contains a zero (0), the display string for the line will stop at the zero.

Example	\$W0	61 62	All character up to here will be displayed as the list string and subsequent characters will be ignored.
	\$W1	63 64	
	\$W2	65 66	
	\$W3	67 00	
	\$W4	6A 6B	
		.....	

The list selection data is treated as shown below when *Store in a file* is specified.

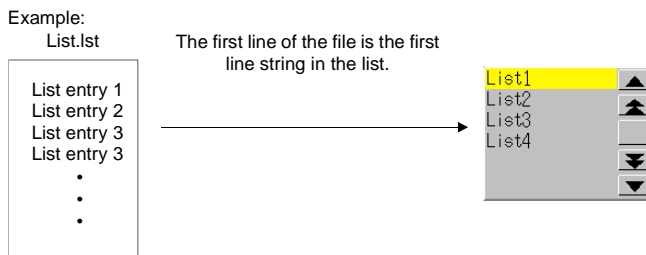

The list selection data is treated as shown below when *Use a file for indirect Reference file* is selected.

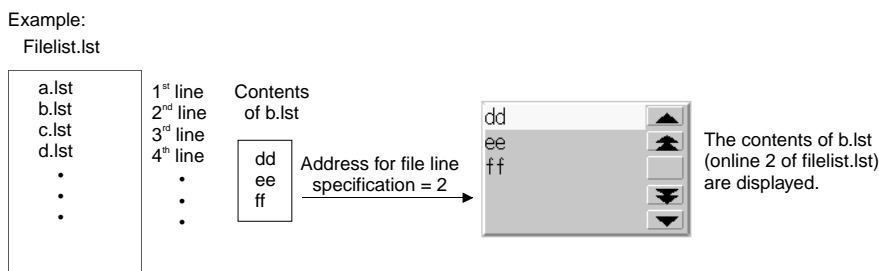

A file name (including the extension) is input as the text file (.lst file) for indirect file specification (file size: 65,535 max.). Create the lst file to be specified here in the same folder as where all of the screen files are stored. When the file is accessed from another directory, it is automatically copied to the directory where the screen files are stored. However, the lst file written inside the text file for indirect specification is not copied. Copy this lst file manually to the folder where the screen data is stored. Refer to the following note for information on restrictions on file names. If these restrictions are not followed, an error will be generated when the data is transferred to the PT.

**Note**

- ◆ Specify a file name of up to 12 characters (8 file name characters and 3 file extension characters). The following characters can be used in file names. Full-size characters cannot be used.  
Alphanumeric characters, underscore (\_), dollar sign (\$), and periods (.).  
An error message will be displayed if illegal characters are used in a file name. If an error message appears, re-enter the file name using permissible characters.
- ◆ There are no restrictions on the number of characters or lines that can be set to a LST file, but the number of characters and lines that are set should match the settings under *List size*. Any characters or lines over the settings under *List size* will be ignored.  
Example: 10 characters per line  
When ABCDEFGHIJKLMN (14 characters) is set to the first line in the LST file, the display will be ABCDEFGHIJ when the first line is displayed. The 11<sup>th</sup> and subsequent characters will be ignored.
- ◆ Click the **Edit** Button to open the text editor and, if creating a new LST file, save the file with LST as the extension. Refer to the manual for the text editor you are using for information on methods for saving files.  
Some text editors automatically set TXT as the file extension. In such cases, use Explorer to change the extension to LST.
- ◆ If ASCII is set in string displays, the following character codes will be used by the PT depending on the system language that has been set.

System language	Character display	Example (character code B5)
Japanese	Shift-JIS code	↑
Chinese (traditional or simplified)	GB2312 code	Nothing is displayed because there are no corresponding characters.
Other	Latin 1code	μ

If the list data is specified to be held in a file, the language of the file and the system language must be the same (e.g., Japanese or English).

- ◆ The address storing the text string for the selected list will be cleared if screens are switched with *Switching screens with Store the Selected Line No. in the Specified Address* or *Store the String of the Selected Line in the Specified Address* while either *Switch Display Block* or *Support Display Start Line Switching* is set for external control will clear.  
If the text string for a selected list will be used again after the screens are switched, use the ladder program or other host program to store text string data before switching the screens.
- ◆ The data format (BCD or binary) for the *Address for Specifying the File Line* on the General Tab Page, *Store the Selected Line No. in Specified Address* on the Selection Tab Page, and *Address for Switching the Display Block* and *Address for Switching the Display Start Line* on the External Control Tab Page is set by selecting **Project Properties** from the PT Menu and using the Data Format Tab Page.

**Text Tab Page**

Sets the text attributes, such as font and color, for the display string. Refer to *Text Attributes* under 2-8 *Common Functional Object Functions* for details.

**Background Tab Page**

Sets the background color for the functional object from a selection of 256 colors. Refer to *Background* and *Setting Colors* under 2-8 *Common Functional Object Functions* for details.

**NS Series Programming Manual**

**Selection Tab Page**

Sets the selection bar color that is reversed during list selection and the address where the selected line number and selected character string are stored.

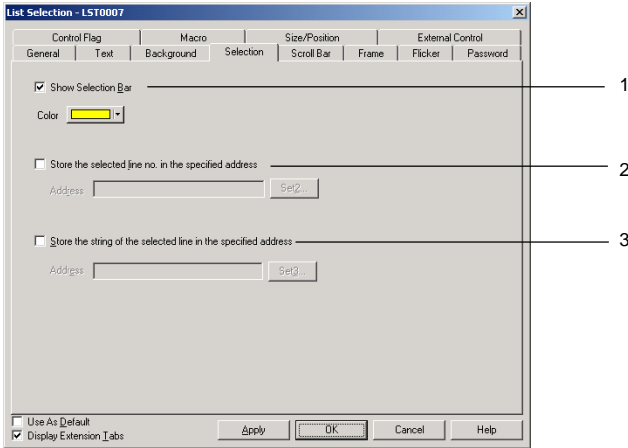

No.	Setting	Details
1	Show selection bar	Sets the selection bar color.
2	Store the Selected Line No. in Specified Address	Stores the selected list line number to the specified address. The first line is counted as 0.
3	Store the String of the Selected Line in the Specified Address	Stores the selected list character string to the specified address.

**Note**

- ◆ With the NS12, NS10, NS8, or NS5, if the font size for the displayed character string is small, as shown below, some character strings may not be able to be selected from the list.

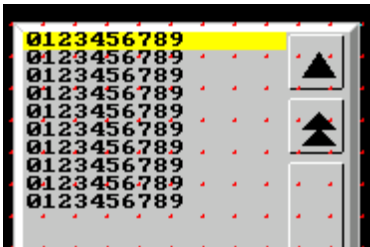

If the font size is too small for the strings to be selected, set a larger font size so that only 1 character string is displayed for each element touch switch.

Select *View – Show Touch Points* to display the size and position of PT touch switches. Use this function to compare the size of the touch switches and the list character strings.

**Scroll Bar Tab Page**

Sets display/no display, scroll width, and button size for the list scroll bar displayed to the right of the list. The Scroll Up Button is displayed to the top right of the scroll bar and the Scroll Down Button is displayed to the bottom right.

Refer to *Scroll Bars* under *2-8 Common Functional Object Functions* for details.

**Frame Tab Page**

Specify the colors and sizes of the object frame to change the shape or color when the list selection frame is depressed or raised. Refer to *Frames* under *2-8 Common Functional Object Functions* for details.

**Flicker Tab Page**

Make flicker settings to make the object flicker (flash). Refer to *Flicker* under 2-8 Common Functional Object Functions for details.

**Password Tab Page**

Set a password for when objects are pressed. Five passwords of up to 16 characters each can be set. One password can be requested for each object. Refer to *Passwords* under 2-8 Common Functional Object Functions for details.

**Control Flag Tab Page**

Control flags control the input and display of functional objects. Use control flags to enable display or input when the contents of an address turn ON or OFF. Refer to *Control Flags* under 2-8 Common Functional Object Functions for details.

**Macro Tab Page**

Macros can be specified for string display and input objects.

Macros executed by the following trigger can be registered.

Trigger	Details
When selecting a list	Executes macro when a list item is selected.

Refer to *NS-series Macro Reference* in the CX-Designer for information on setting methods.

**Size/Position Tab Page**

Displays and sets the functional object size and position. Refer to *Size/Position* under 2-8 Common Functional Object Functions for details.

**External Control Tab Page**

Display blocks and the start line can be switched when designated by the host.

Any refreshes required when list data has been changed can also be specified.

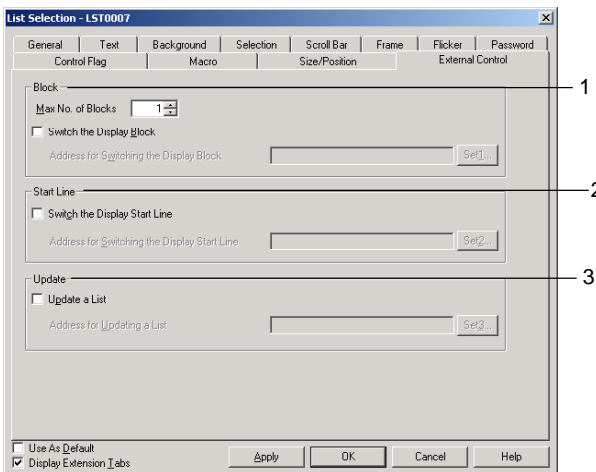

No.	Setting	Details
1	Block	Sets the maximum number of blocks (1 to 32) and the address for specifying block switches.
2	Start line	Sets the address for switching the display start line. The start line is specified as a offset from the beginning of the block (i.e., the beginning of the block is 0).
3	Update	Sets the address for updating a list.

**Switching Blocks**

When blocks are specified, internal memory or the contents of text files are split into a maximum of 32 blocks and the blocks are switched based on the contents (0 to 31) of the allocated address.

Example: If the maximum number of lines set on the General Tab Page is 10, the number of blocks set on the External Control Tab Page is 3, and the address for switching the display block is \$W0.

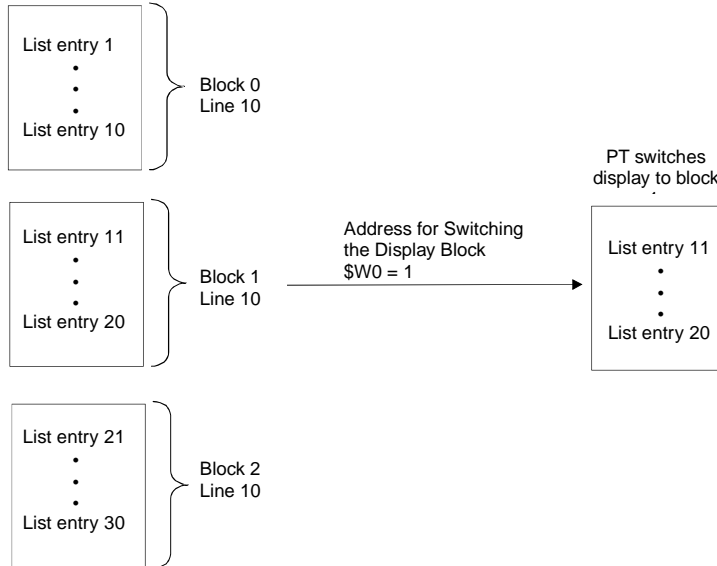

The number of lines for each block will be the number set under *Maximum No. of lines*.

**Switching Start Line**

The first line currently displayed in a list can be switched based on the contents of the allocated address. The first line in a list is counted as line 0.

Example: When the address for switching the display start line is set in \$W0.

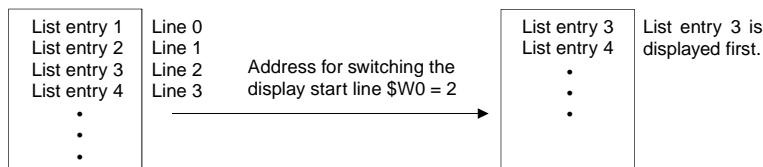

**Update a List**

The list display will be updated when the contents of the allocated address are changed.

Update a List is required in the following circumstances.

- When the string data of an address being referenced changes.
- When the string in a list file being referenced changes.
- When labels have been switched.

## 2-12-5 Temporary Input Objects

The Temporary Input Object displays a temporary input display field when keypads and keyboards have been created for Numeral Display and Input Objects or String Display and Input Objects using Command Keys. Temporary input objects can also be displayed for the maximum and minimum values set for Numeral Display and Input Objects.

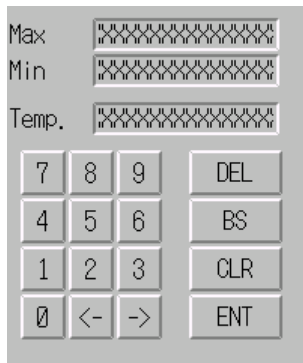

To create a temporary input, select CX-Designer **Functional Object – Temporary Input** or use the



icon.

### Functional Object Property Settings

This section describes the settings in the Functional Object Properties Dialog Box for temporary inputs.

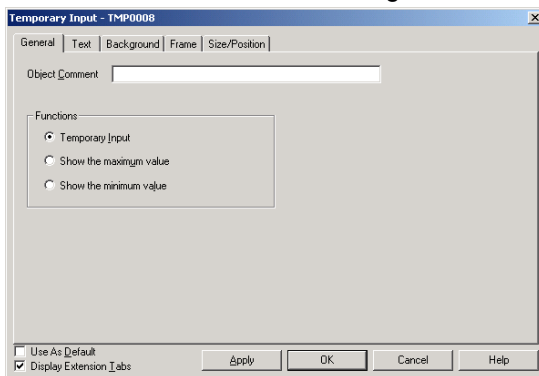

- General: Sets the object comment and temporary input object functions.
- Text: Sets the text attributes for the displayed numeral/character string.
- Background: Sets the background color for the object.
- Frame: Sets the frame display for the temporary input object.
- Size/Position: Sets the object size and position. (See note.)

Note: This tab is displayed when the *Display Extension Tabs* Option is selected.

**General Tab Page**

Set the functions for the temporary input object.

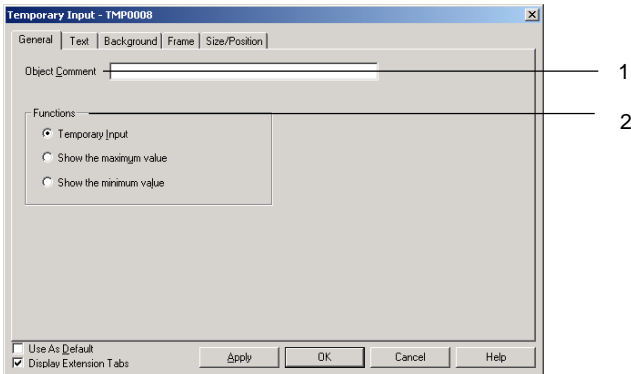

No.	Setting	Details
1	Object Comment	Sets an explanatory comment for the pasted object. (Up to 32 characters.)
2	Functions	Sets the functions for the temporary input object.
	Temporary input	Displays the numeric value or character string input by the user when input focus is on the numeral display and input object or string display and input object.
	Show the maximum value	Displays the set upper limit for input when input focus is on numeral display and input object or string display and input object.
	Show the minimum value	Displays the set lower limit for input when input focus is on numeral display and input object or string display and input object.

**Text Attribute Tab Page**

Sets the text attributes, such as font and color, for the display numerals or string. Refer to *Text Attributes* under 2-8 Common Functional Object Functions for details.

**Background Tab Page**

Sets the background color for functional objects. Refer to *Setting Colors* under 2-8 Common Functional Object Functions for details.

**Frame Tab Page**

Specify the colors and sizes of the object frame to change the shape or color when the button is depressed or raised. Refer to *Frames* under 2-8 Common Functional Object Functions for details.

**Size/Position Tab Page**

Displays and sets the functional object size and position. Refer to *Size/Position* under 2-8 Common Functional Object Functions for details.

**NS Series Programming Manual**

**Creating Temporary Input Keypads in Numeral Display and Input Objects**

Use the following procedure to create a keypad using a temporary input object.

1. Position a numeral display and input object on the screen.

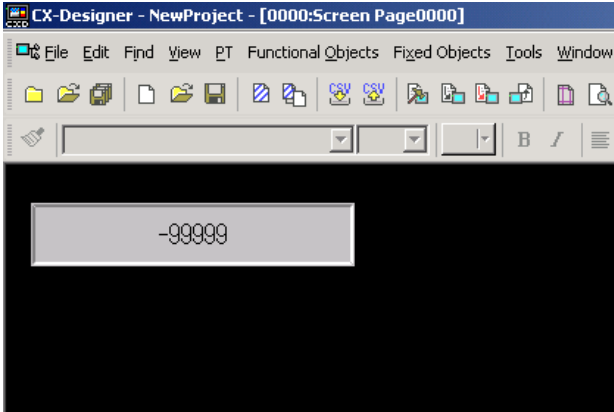

2. Double-click the object to display the Properties Dialog Box.
3. Display the **Keypad** Tab Page. Select *Input from Pop-up Screen* or *Other Input Method (command button etc.)* under Input Method. Select the *Use temporary input* option under Input Method.

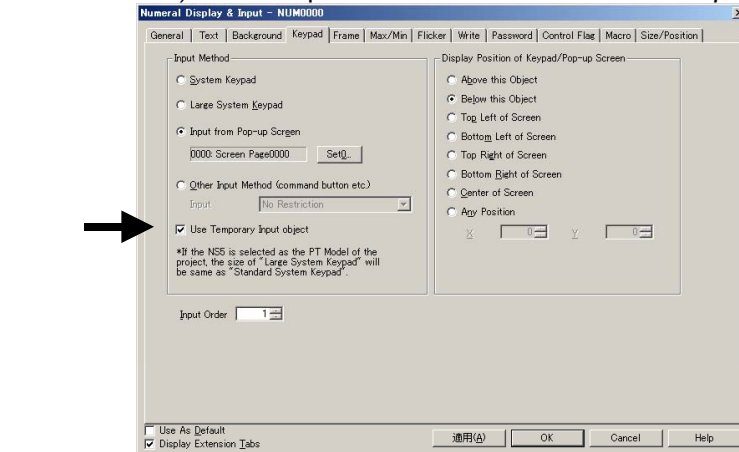

4. Select the *Display Extension Tabs* Option to display the Max/Min Tab Page. Select both the *Check Maximum Input Limit* and the *Check Minimum Input Limit*, and select the *Value* option. The maximum and minimum values are set as shown in the following diagram.

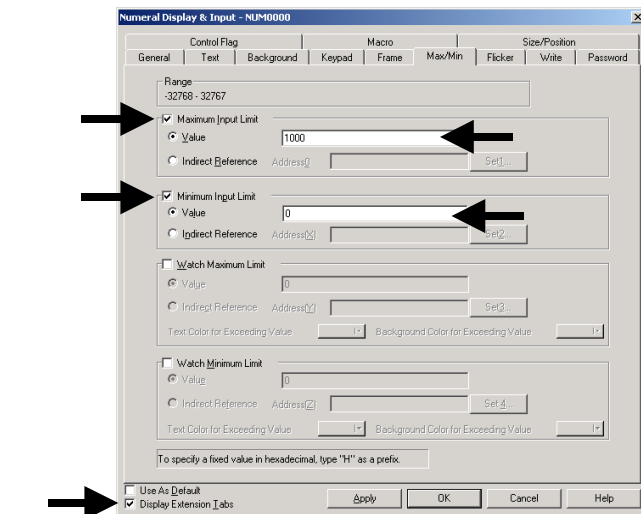



### Creating Temporary Input Keypads

The following example shows creating a keypad using a temporary input object.

1. Position the temporary input object, which will be the temporary input display field, on the screen.



2. Double-click the object to display the Properties Dialog Box. Select the *Temporary input* option under *Function* on the General Tab Page.

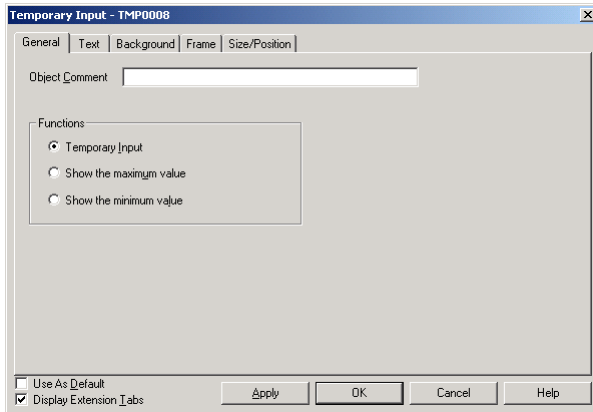

3. Position the temporary input objects on the screen for displaying the maximum and minimum values.

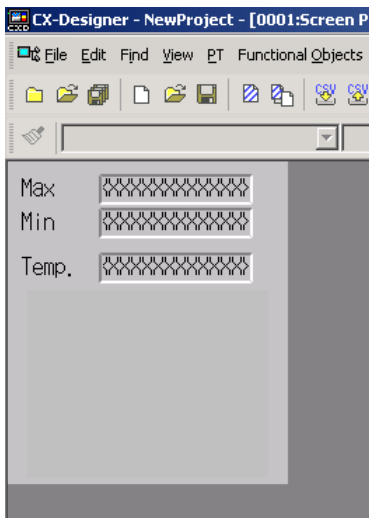

**NS Series Programming Manual**

4. Double-click the objects to display the Properties Dialog Box. Select *Show the maximum value* and *Show the minimum value* under *Function* on the General Tab Page.

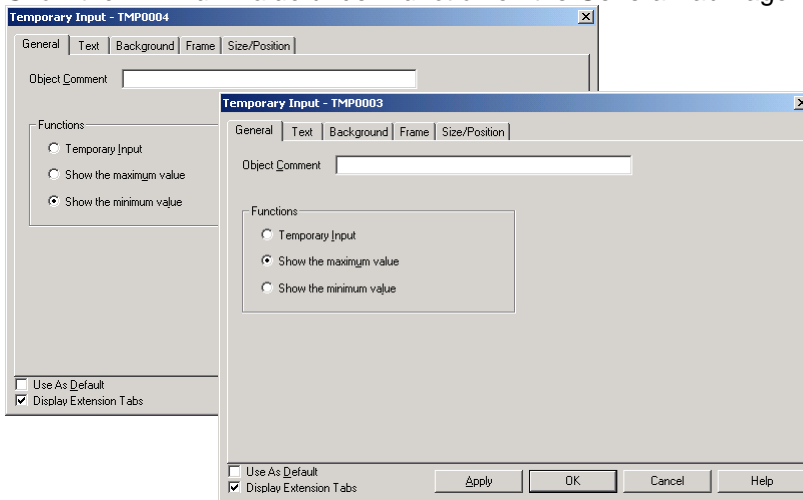

5. Use a Command Button to create a keypad. Refer to *Key Buttons* under 2-9-3 *Command Buttons* for details on how to create keypad command buttons. Set the destination to the *Input Field with Focus* option under the properties settings for each **Command Button**.
6. Check the keypad operation using the test function.

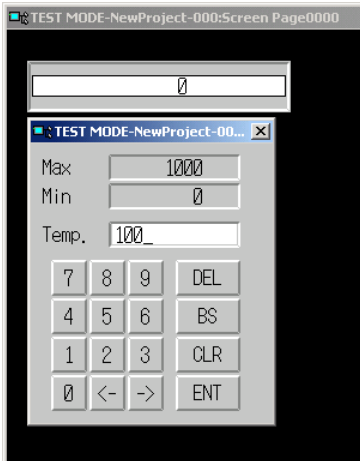

When the focus is on the numeral display and input object, the input value is displayed in the temporary input object. Click the **Command Button** to overwrite the present values with the new input value.

## 2-13 Display

This section describes objects with display functions only. This includes text, bitmaps, level meters, analogue meters, video displays, and consecutive line drawings.

### 2-13-1 Text

Text objects are functional objects used to display fixed character strings. Use text objects for screen titles, item names, and other character string displays that do not require any other particular function.

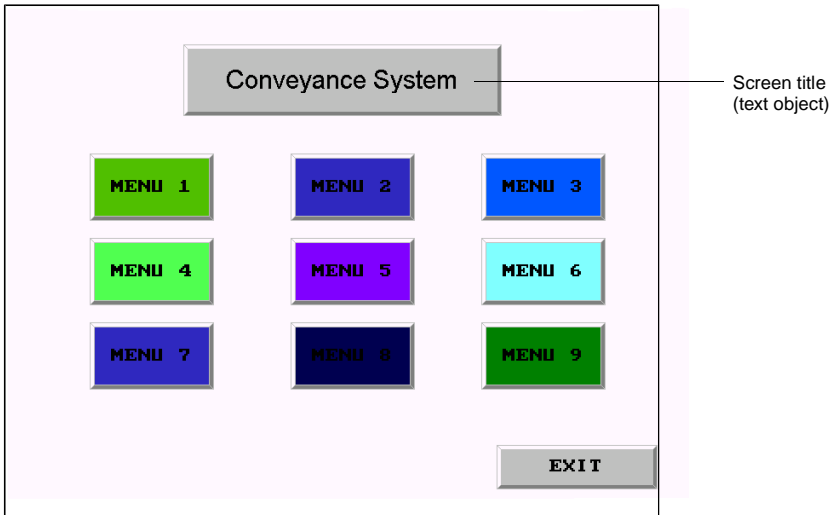

Display characters can also be changed. The following three methods can be used to change display characters.

#### Indirect Specification from a Text File

A list of display strings can be stored in a text file and any string can be specified for display from that list.

#### Indirect Specification from a String Table

Any string can be specified for display from the strings registered in the string table.

#### Message Display Function

This function registers a display string and background color for each status number set for the label. Any set status can be specified for display.

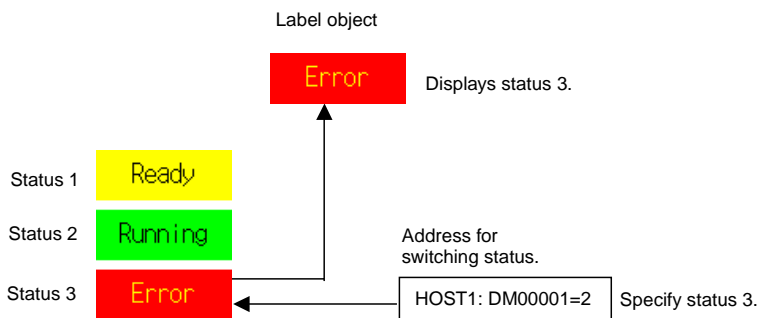

## Settings for Functional Object Properties

This section describes the settings in the Functional Object Properties Dialog Box for text objects.

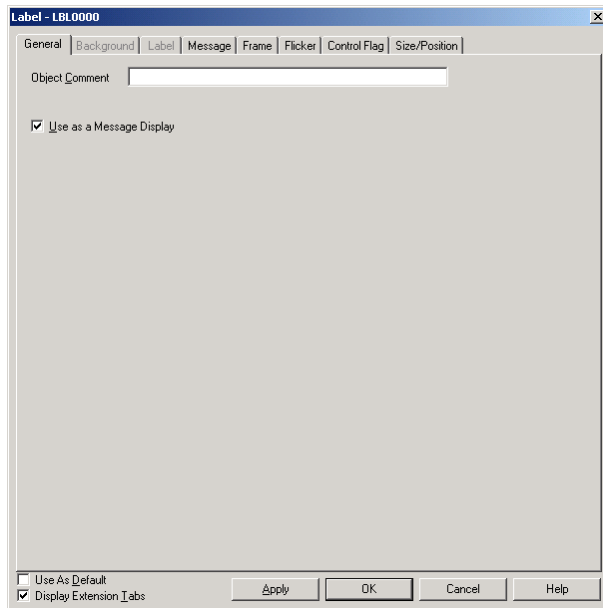

- General: Sets object comments.
- Background: Sets the background color for the text object.
- Label: Sets the label display.
- Message: Sets the label display data and background color for when the message display function is used.
- Frame: Sets the object frame display.
- Flicker: Sets the flicker display. (See note.)
- Control Flag: Sets display/no display of the object. (See note.)
- Size/Position: Sets the object size and position. (See note.)

Note: These tabs are displayed when the *Display Extension Tabs* Option is selected.

**NS Series Programming Manual**

**General Tab Page**

Sets object comments.

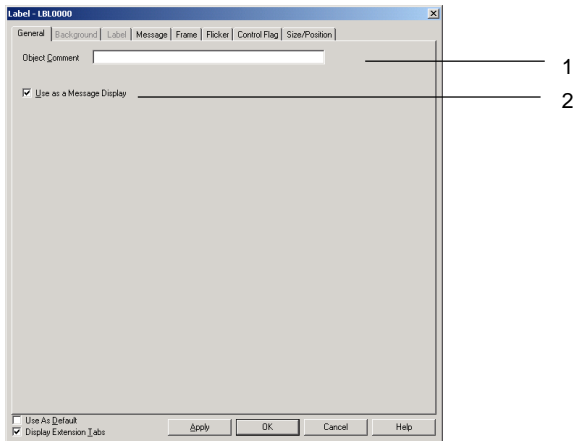

No.	Setting	Details
1	Object Comment	Sets an explanatory comment for the pasted object. (Up to 32 characters.)
2	Use as a Message Display	Select this checkbox to use the message display function.

**Background Tab Page**

Sets the background color for text objects from a selection of 256 colors. Refer to *Setting Colors* under 2-8 *Common Functional Object Functions* for details.

**Note**

- ◆ The *Indirect reference of color* option is enabled only when raster font is specified for label character strings.
- ◆ Vector fonts cannot be used however for labels set to text objects if the PT is version 1.0. Use a version 1.1 PT or later if a vector font is to be used.

**Label Tab Page**

Labels can be set for text objects. Alternatively, label strings can be read and displayed from a specified file or the string table. Refer to *Labels* in 2-8 *Common Functional Object Functions* for basic settings information.

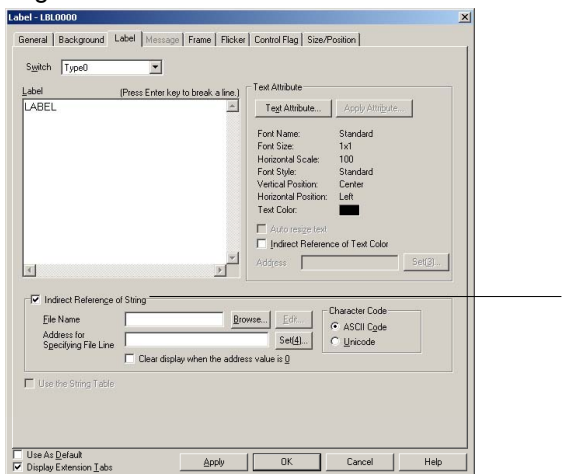

**NS Series Programming Manual**

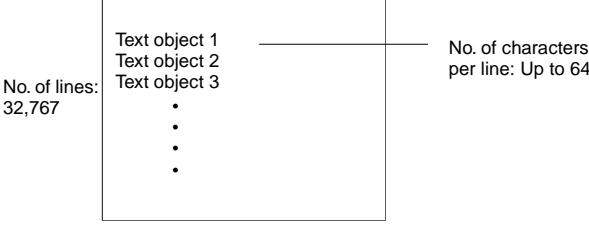
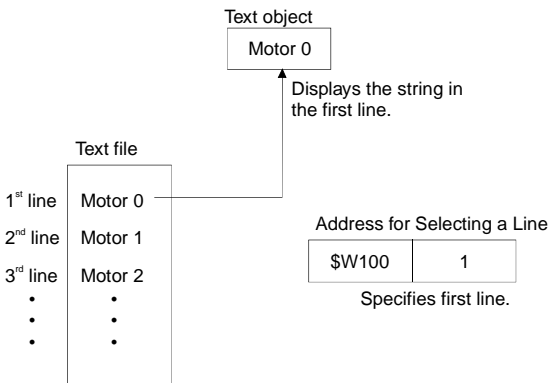
No.	Setting	Details
1	Indirect Reference of String	Normally displays the string as fixed characters. When specifying a raster font, it is also possible to select <i>Indirect reference of string</i> and browse for the file containing the string to display.
	File Name	<p>Specifies the file where the string to be displayed is stored. Only files with the extension .txt can be specified.</p> <p>The file must be stored in the folder where the projects are stored. Click the <b>Browse</b> Button to specify a string file in any directory. The specified string file will be automatically copied to the folder where the screen files are stored. Use this copied file for any subsequent editing. The file specifications are given below.</p> <p>File name: 8 file name characters + .txt (extension)                      Alphanumeric characters, underscore (_), dollar signs (\$), and periods (.).                      Editing software: Text editor</p> 
	Address for Specifying File Line	 <p>The previously displayed string will remain if the file line specification address contents change to 0. The display will be cleared when the contents change to 0 if the <i>Clear display when address value is 0</i> checkbox is selected.</p>
Character code	Specify the character code as multibyte or Unicode. Multibyte code uses one byte for half-width characters and two bytes for full-width characters. Unicode uses two bytes for all characters.	
2	Refer to the Character String Table	Select this checkbox to select a label string from the strings registered in the character string table.

**Note**

- ◆ If vector fonts are specified for label strings, the string and character color cannot be specified indirectly.
- ◆ Up to 32,767 lines can be set but this may depend on the text editor being used.
- ◆ If ASCII is set in text, the following character codes will be used by the PT depending on the system language that has been set.

System language	Character display	Example (character code B5)
Japanese	Shift-JIS code	†
Chinese (traditional or simplified)	GB2312 code	Nothing is displayed because there are no corresponding characters.
Other	Latin 1 code	μ

- ◆ Character codes for indirectly specified text strings are used to handle other languages. Refer to *Multi-Language Display* in the *CX-Designer Online Help* for details on using other languages.
- ◆ To set the data type (BCD or binary) for the address for specifying the File Line, select **Project Properties** from the PT Menu and set the data type on the Data Type Tab Page.

**Referencing Strings from String Table**

If referencing the string table for strings, the display string can be switched depending on the value at a specified communications address.

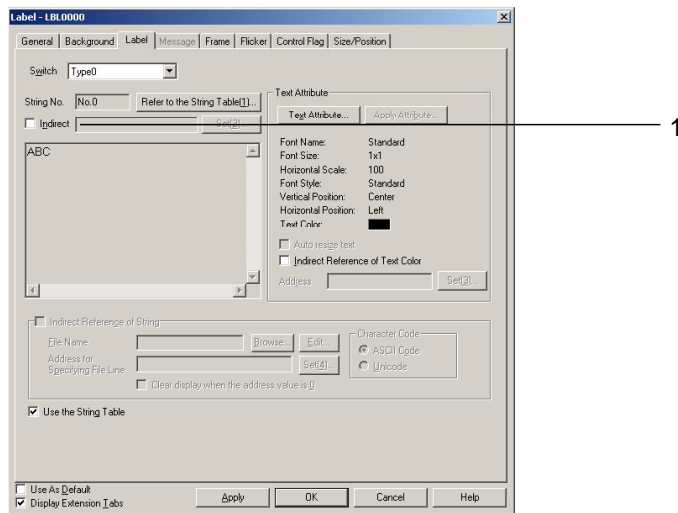

No.	Item	Details
1	Indirect	Select this checkbox to indirectly specify the display string number. The value at the set communications address will be used as the string number for displaying the label string. The contents of the communications address is set as a binary value.

**Note**

- ◆ The vector font cannot be used when referencing the string table for label strings.

**Message**

Sets the display data for when the message display function is used.

The display string can be directly input or selected from the string table.

**Direct Input of Strings**

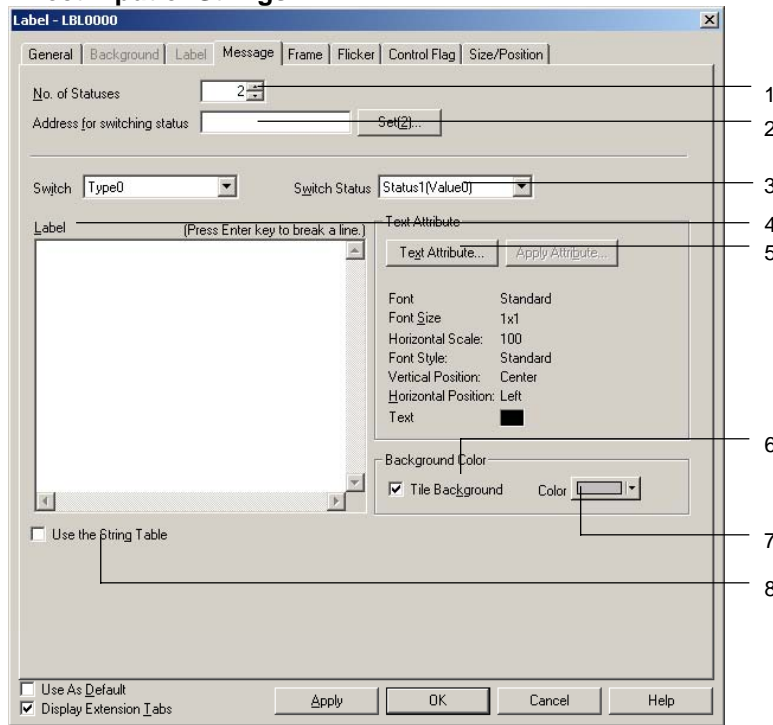

No.	Item	Details
1	No. of Statuses	Sets the number of statuses (2 to 10000).
2	Address for switching status	Displays the status for the number corresponding to the value at the set communications address. The contents of the communications address is set as a binary value.
3	Switch Status	Selects the status for setting the string background.
4	Label	Sets the string for each status (up to 256 characters).
5	Text Attribute	Specifies the text attributes for each status. Refer to 2-8-6 <i>Text Attributes</i> for details on settings.
6	Tile Background	Select this checkbox to fill the background. Deselect this option to leave the background clear. If this checkbox is deselected, the background will be clear for all statuses.
7	Color	Sets the background color for each status if the <i>Fill background</i> checkbox is selected.
8	Use the String Table	Select this checkbox to select a label string from the strings registered in the string table.



**NS Series Programming Manual**

**Note**

- ◆ Up to a maximum of 10,000 statuses can be registered. The maximum setting file size that can be registered for one screen, however, is 5 MB. Do not set any value larger than this. The setting file name is CNTxxx.cfg, where “xxx” is the screen number in hexadecimal. You can check the size of the current setting file by selecting **Tools – Resource Report** from the CX-Designer menus. Registered strings can be changed as a group by importing/exporting CSV files. The string table can be exported as a CSV file, edited or translated, and then imported. All of the data in the edited CSV file can then be registered together in the string table.
- ◆ The size of the settings file depends on the number of registered characters and labels. Use the following table as a guide.

File size	No. of labels	Number of registered statuses	No. of characters in each string
5.0 MB	1	10,000	256
4.9 MB	1	2,500	1,024
4.8 MB	2	10,000	120
4.7 MB	2	1,200	1,024
4.9 MB	16	10,000	10
4.7 MB	16	150	1,024

**Referencing Label from the String Table**

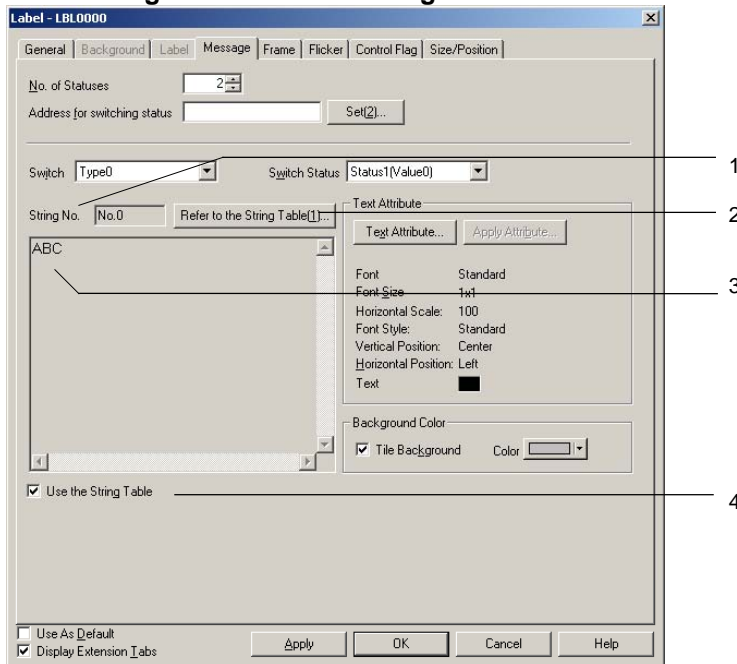

No.	Item	Details
1	String No.	Displays the string number selected from the string table for each status.
2	Refer to the String Table	Selects the string to be displayed as a label from the string table displayed when the Refer to the String Table Button is clicked.
3	Label	Displays the string selected from the string table. Up to 1,024 characters can be displayed.
4	Use the String Table	Deselect this option to directly input the label string.

**Note**

- ◆ The vector font cannot be used when referencing the string table for label strings.

**Frame Tab Page (Extension Tab)**

Specifies the colors and sizes of the object frame to change the shape or color when the button is depressed or raised. Refer to *Frames* under *2-8 Common Functional Object Functions* for details.

**Flicker Tab Page (Extension Tab)**

Makes flicker settings to make the object flicker (flash). Refer to *Flicker* under *2-8 Common Functional Object Functions* for details.

**Control Flag Tab Page (Extension Tab)**

Control flags control the display of functional objects. Use control flags to enable display when the contents of an address turn ON or OFF. Refer to *Control Flags* under *2-8 Common Functional Object Functions* for details.

**Size/Position Tab Page (Extension Tab)**

Displays and sets the functional object size and position. Refer to *Size/Position* under *2-8 Common Functional Object Functions* for details.

**2-13-2 Bitmaps**

Bitmaps are objects that display images made up of dots. Bitmaps are used to display complex pictures or photographic images that cannot be drawn. BMP (.bmp) and JPEG (.jpg) files can be displayed using bitmap objects.

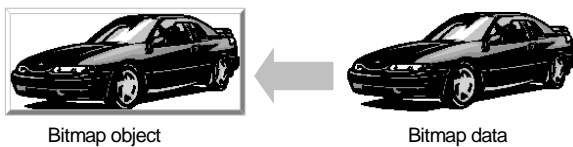
**Settings for Functional Object Properties**

This section describes the settings items in the Functional Object Properties Dialog Box for bitmaps.

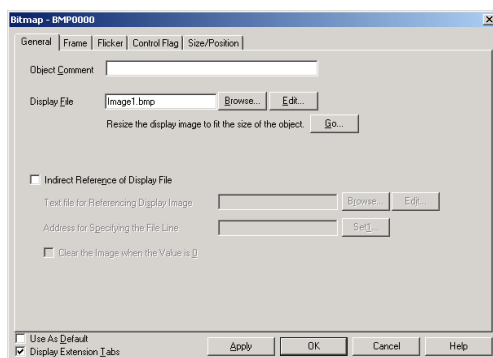

- General: Sets the image file and object comment to be displayed.  
 Frame: Sets the bitmap object frame display.  
 Flicker: Sets the flicker display. (See note.)  
 Control Flag: Sets display/no display of the object. (See note.)  
 Size/Position: Sets the object size and position. (See note.)

Note: These tabs are displayed when the *Display Extension Tabs* Option is selected.

**NS Series Programming Manual**

**General Tab Page**

Sets the bitmap file and comment to be displayed.

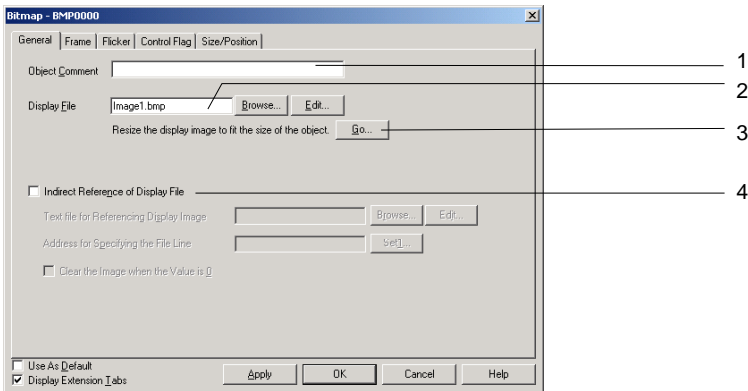

No.	Setting	Details
1	Comment	Sets an explanatory comment for the pasted object. (Up to 32 characters.)
2	Display file	Selects the image file to be displayed. Files with the extension .bmp or .jpg can be selected. Click the <b>Browse</b> Button to select image files. The specified image file is copied to the folder where the project files are stored. Specify a file name of up to 12 characters (8 file name characters and 3 file extension characters). The following characters can be used in file names. Alphanumeric characters, underscore (_), dollar signs (\$), and periods (.).

**Note**

- ◆ RLE bitmap files and progressive format jpg files are not supported.
- ◆ If a corrupted jpg file is set, the CX-Designer will not operate correctly. Check that the file can be displayed correctly before specifying an image file for the bitmap.

NS Series Programming Manual

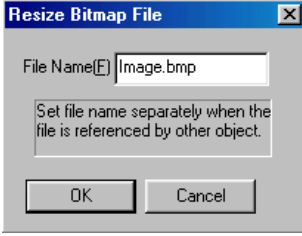
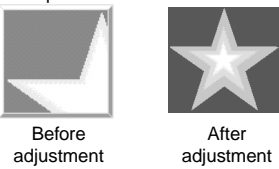
No.	Setting	Details												
3	Resize the display image to fit the size of the object.	<p>Use this function to enlarge or reduce the image file specified under <i>Display file</i> to match the size of the current bitmap object.</p> <p>Use the following procedure to enlarge or reduce the image file.</p> <ol style="list-style-type: none"> <li>1. Click the <b>Go</b> Button.</li> <li>2. The dialog box shown below will be displayed. Set a separate file name to access this file from other objects.</li> </ol>  <ol style="list-style-type: none"> <li>3. Click the <b>OK</b> Button. A message saying that the processing has been completed will be displayed.</li> <li>4. Click the <b>Apply</b> or <b>OK</b> Button in the Bitmap Object Properties Dialog Box to reflect the settings.</li> </ol> <p>Example:</p> 												
4	Indirect Reference of Display File	<p>Normally, images are displayed when fixed files are read and displayed. Text files can be browsed, however, for the display file name and a selected file displayed if the <i>Indirect Reference of Display File</i> option is selected.</p> <p>Click the <b>Browse</b> Button to specify a text file in any directory. This text file is then automatically copied to the folder where the project files are stored. Use this copied file for any subsequent editing.</p> <p>Lines where the display file name appear can be specified. For example, if the contents of the memory set to Address for Specifying the File Line changes to 1, the first and subsequent lines of the specified text file will be loaded. If the contents of the memory changes to 2, the second and subsequent lines will be loaded.</p> <p>If the contents of Address for Specifying the File Line is changed to 0, the bitmap file will not change from the one displayed immediately prior to the change. Select <i>Clear the Image when the Value is 0</i> to clear the display if the contents of Address for Specifying the File Line changes to 0.</p> <p>The procedure for indirectly specifying the display file is described below.</p> <ol style="list-style-type: none"> <li>1. Create a text file that will be used for indirect reference. Text files are created from the following elements using a text editor. (Create the file in any directory. Refer to <i>Text File Specifications</i> for restrictions on text files.)</li> </ol> <p>Example</p> <table border="0" data-bbox="494 1523 1133 1747"> <tr> <td>Image file name + .bmp when content of address specifying 1<sup>st</sup> line is 1. →</td> <td>IMAGE1.BMP</td> </tr> <tr> <td>Image file name + .bmp when content of address specifying 2<sup>nd</sup> line is 2. →</td> <td>IMAGE2.BMP</td> </tr> <tr> <td>Image file name + .bmp when content of address specifying 3<sup>rd</sup> line is 3. →</td> <td>IMAGE3.BMP</td> </tr> <tr> <td>·</td> <td>·</td> </tr> <tr> <td>·</td> <td>·</td> </tr> <tr> <td>·</td> <td>·</td> </tr> </table> <p>(Files with bmp extensions can be used for JPEG files.)</p> <ol style="list-style-type: none"> <li>2. Click the <b>Browse</b> Button under <i>Display file</i> and select the image file. If necessary, select <i>Resize the specified display file to fit the size of the object</i>.</li> <li>3. Repeat the previous step and select all the required image files. (The selected image files will be copied automatically to the directory where the project files are stored.)</li> <li>4. Select Indirect Reference of Display File.</li> </ol>	Image file name + .bmp when content of address specifying 1 <sup>st</sup> line is 1. →	IMAGE1.BMP	Image file name + .bmp when content of address specifying 2 <sup>nd</sup> line is 2. →	IMAGE2.BMP	Image file name + .bmp when content of address specifying 3 <sup>rd</sup> line is 3. →	IMAGE3.BMP	·	·	·	·	·	·
Image file name + .bmp when content of address specifying 1 <sup>st</sup> line is 1. →	IMAGE1.BMP													
Image file name + .bmp when content of address specifying 2 <sup>nd</sup> line is 2. →	IMAGE2.BMP													
Image file name + .bmp when content of address specifying 3 <sup>rd</sup> line is 3. →	IMAGE3.BMP													
·	·													
·	·													
·	·													

NS Series Programming Manual

No.	Setting	Details		
4	Indirect Reference of Display File	<p>5. Click the <b>Browse</b> Button next to <i>Text File for Referencing Display Image</i> and specify the text file created in step 1.</p> <p>6. Specify the address for specifying the file lines. If necessary, select <i>Clear the Image when the Value is 0</i>.</p> <p>7. A separate program must be created if you want to switch bitmap displays like animation. Create a program that increases the contents of the specified address by 1 each time.</p> <p>Text File Specifications                      The file specifications are given below.                      File name: 8 file name characters + .txt (extension)                      The characters that can be used in file names are listed below.                      Alphanumeric characters, underscore (_), dollar signs (\$), and periods (.).                      Editing software: Text editor                      Check that the text file has been created according to the above specifications and then specify Text File for Referencing Display Image. If a different text file has been specified by mistake, the PT may not operate correctly.</p> <div style="display: flex; align-items: center;"> <div style="margin-right: 10px;">There is no limit on the number of digits</div> <div style="border: 1px solid black; padding: 5px; text-align: center;">                         IMAGE1.BMP                          IMAGE2.BMP                          IMAGE3.BMP                          ⋮                          ⋮                     </div> </div> <p>Note: There is no limit to the number of bitmaps that can be switched for the display. However, make sure that the total size of the BMP/JPEG files is within the transfer capacity of the PT.</p> <div style="display: flex; justify-content: space-around; align-items: center;"> <div style="text-align: center;"> <p>Bitmap object</p> <div style="border: 1px solid black; padding: 2px;">Gazou1.BMP</div> </div> <div style="text-align: center;"> <p>Displays the bitmap file for line 1.</p> </div> </div> <div style="display: flex; justify-content: space-around; align-items: center; margin-top: 20px;"> <div style="text-align: center;"> <p>Text file</p> <div style="border: 1px solid black; padding: 2px;">                         1<sup>st</sup> line Gazou1.BMP                          2<sup>nd</sup> line Gazou2.BMP                          3<sup>rd</sup> line Gazou3.BMP                     </div> </div> <div style="text-align: center;"> <p>Address for Specifying the File Line</p> <table border="1" style="border-collapse: collapse;"> <tr> <td style="padding: 2px;">\$W100</td> <td style="padding: 2px;">1</td> </tr> </table> </div> </div>	\$W100	1
\$W100	1			

**Note**

- ◆ If there are more than 32,000 colors in a True Color image file set under *Display file*, the number of colors will be automatically reduced to 32,000.
- ◆ Always use the Browse Button to select the display file. Always use the Browse Button for indirectly referenced files as well. If the Browse Button is not used and the image file is copied manually directly to the directory where the project files are stored, image files with more than 256 colors will not be displayed correctly. The number of colors will not be automatically reduced to 256.
- ◆ Always use BMP or JPEG files with an image size given in the following table. If image files larger than the sizes given below are used, there may be insufficient memory available when the PT is operating.

	Image size
Not NS5	800 x 600 dots max.
NS5	320 x 240 dots max.

- ◆ When bitmap objects are deleted, the BMP or JPEG files are not deleted from the folder where image data is stored. The BMP or JPEG files are also not deleted from the image data folder when deleting from an indirectly referenced file. If a BMP or JPEG file is no longer needed, check that it is not used in any other screens and then delete it manually.
- ◆ To set the data type (BCD or binary) for the address for specifying the File Line, select **Project Properties** from the PT Menu and set the data type on the Data Type Tab Page.

**Flicker Tab Page (Extension Tab)**

Make flicker settings to make the bitmap object flicker (flash). Refer to *Flicker* under *2-8 Common Functional Object Functions* for details.

**Frame Tab Page (Extension Tab)**

Specify the colors and sizes of the bitmap object frame to change the shape or color when the button is depressed or raised. Refer to *Frames* under *2-8 Common Functional Object Functions* for details.

**Control Flag Tab Page (Extension Tab)**

Control flags control the display of functional objects. Use control flags to enable display when the contents of an address turn ON or OFF. Refer to *Control Flags* under *2-8 Common Functional Object Functions* for details.

**Size/Position Tab Page (Extension Tab)**

Displays and sets the functional object size and position. Refer to *Size/Position* under *2-8 Common Functional Object Functions* for details.

### 2-13-3 Level Meters

Level Meter objects are functional objects that fill rectangular regions based on the contents of a specified address. Ranges can be specified for color differentiation.

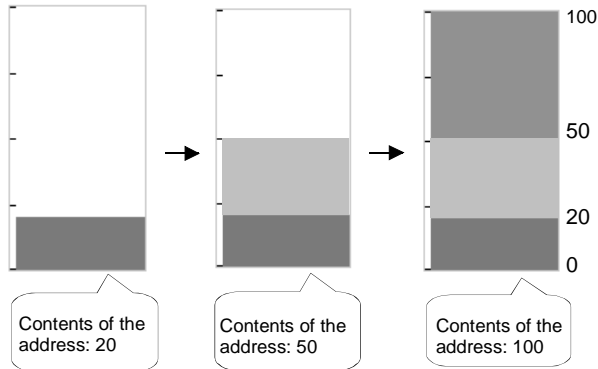

### Settings for Functional Object Properties

This section describes the settings items in the Functional Object Properties Dialog Box for level display objects.

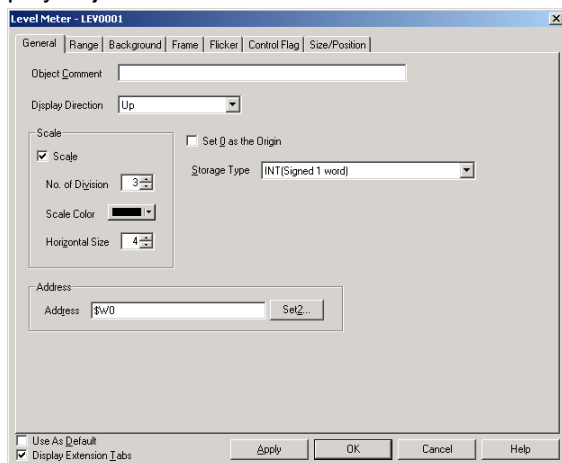

- General: Sets the object comment, display direction, and scale.
- Range: Sets the border (boundary value) and color for each range.
- Background: Sets the object background color.
- Frame: Sets the object frame display.
- Flicker: Sets the flicker display. (See note.)
- Control Flag: Sets display/no display of the object. (See note.)
- Size/Position: Sets the object size and position. (See note.)

Note: These tabs are displayed when the *Display Extension Tabs* Option is selected.

**NS Series Programming Manual**

**General Tab Page**

Sets the values referenced for scale shape and level display and the comment.

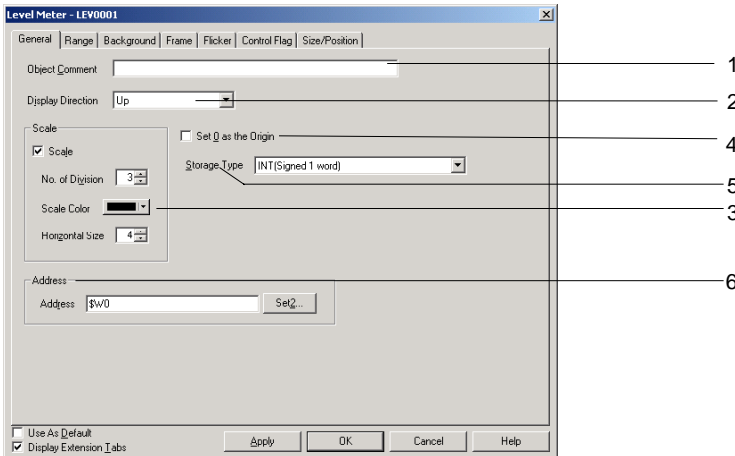

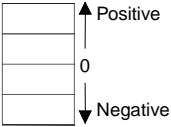
No.	Setting	Details
1	Object Comment	Sets an explanatory comment for the pasted object. (Up to 32 characters.)
2	Display direction	Select a display direction of <i>Up</i> , <i>Down</i> , <i>Left</i> , or <i>Right</i> .
3	Scale	Set whether to use a scale. If a scale is used, set the number of divisions (1 to 99), the scale color, and the horizontal size (4 to 32).
4	Set 0 as origin	If <i>Set 0 as origin</i> is selected, the border will be 0 and the level will be displayed in the specified display for positive values and in the opposite direction for negative values. Example: For <i>Up</i> display direction 
5	Storage type	Select and set the storage type from the pull-down list.
6	Address	Sets the address to access the data. Only a word address can be set.

**Note**

- Sometimes the gaps between divisions will not be even, depending on the number of divisions and the size of the object.



**NS Series Programming Manual**

**Range Tab Page**

Sets the maximum, minimum, borders, and colors for ranges 1 to 3.

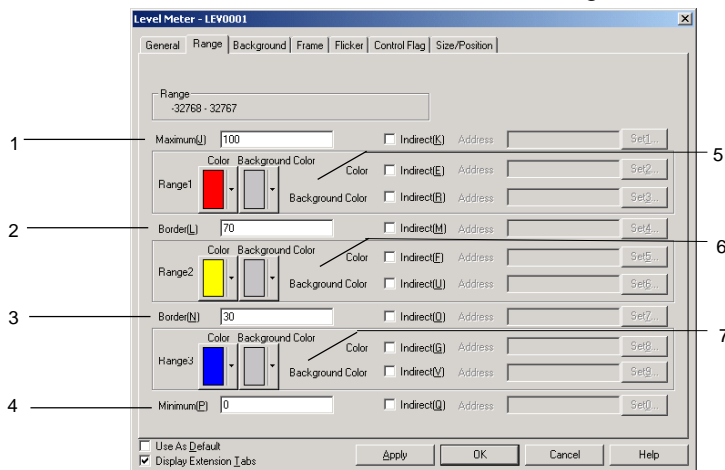

No.	Setting	Details
1	Maximum	Maximum range value or indirect word address.
2	Border	Delimiter for range 1/range 2 or indirect word address.
3	Border	Delimiter for range 2/range 3 or indirect word address.
4	Minimum	Minimum range value or indirect word address.
5	Range1	Sets the fill color and background color for range 1. These colors can also be set indirectly through a communications address.
6	Range2	Sets the fill color and background color for range 2. These colors can also be set indirectly through a communications address.
7	Range3	Sets the fill color and background color for range 3. These colors can also be set indirectly through a communications address.

**Note**

- ◆ The ranges that can be set for each item depend on the selected storage type. Refer to *Numerical Display and Storage Type (General Tab)* in 2-8 *Common Functions of Functional Objects*.
- ◆ When referencing the border indirectly, specify a value in the same type as the storage type set on the General Tab Page.  
For example, if *REAL* (real number) is specified on the General Tab Page, set the border as a real number.
- ◆ When indirectly referencing the border, make sure the size relationships between the maximum, minimum, and borders are correct. If the size relationships are incorrect, the level display object will not be displayed correctly.

### Background Tab Page

Sets the background color for the functional object from a selection of 256 colors. Refer to *Setting Colors* under *2-8 Common Functional Object Functions* for details.

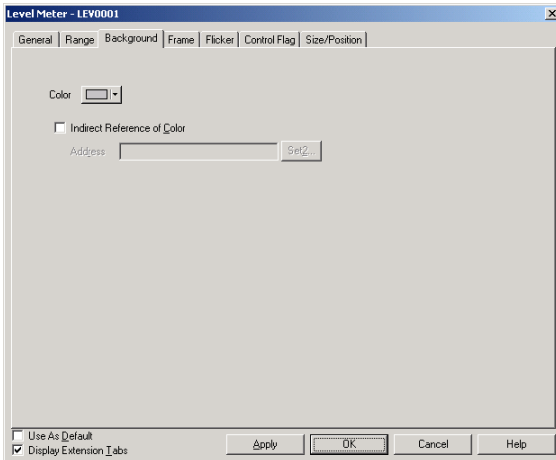

Colors can also be set by referencing the contents of the address.

### Frame Tab Page (Extension Tab)

Specifies the colors and sizes of the object frame to change the shape or color when the button is depressed or raised. Refer to *Frames* under *2-8 Common Functional Object Functions* for details.

### Flicker Tab Page (Extension Tab)

Makes flicker settings to make the object flicker (flash). Refer to *Flicker* under *2-8 Common Functional Object Functions* for details.

### Control Flag Tab Page (Extension Tab)

Control flags control the display of functional objects. Use control flags to enable display when the contents of an address turn ON or OFF. Refer to *Control Flags* under *2-8 Common Functional Object Functions* for details.

### Size/Position Tab Page (Extension Tab)

Displays and sets the functional object size and position. Refer to *Size/Position* under *2-8 Common Functional Object Functions* for details.

## 2-13-4 Analogue Meter

Analogue meters are objects that are displayed as quarter-circle, semi-circle, or circle graphs. The display direction (up, down, left, or right) and incremental direction for the meter (clockwise or anti-clockwise) can be set.

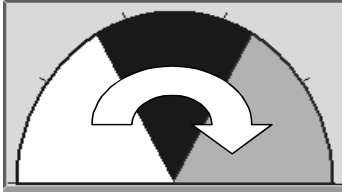

### Settings for Functional Object Properties

This section describes the settings in the Functional Object Properties Dialog Box for analogue meters.

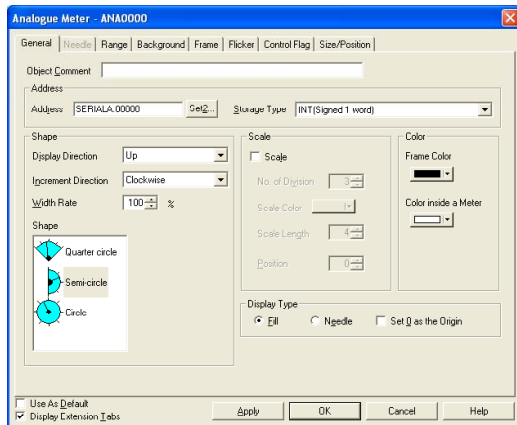

- General: Sets the address and display type.
- Needle: Sets the needle type and style. (See note 1.)
- Range: Sets the border (boundary value) and color for each range.
- Background: Sets the object background color.
- Frame: Sets the analogue meter frame display.
- Flicker: Sets the flicker display. (See note 2.)
- Control Flag: Sets display/no display for the analogue meter. (See note 2.)
- Size/Position: Sets the object size and position. (See note 2.)

Note 1: Can be set only when *Needle* is selected as the display method on the General Tab Page.



Note 2: These tabs are displayed when the *Display Extension Tabs* Option is selected.

**NS Series Programming Manual**

**General Tab Page**

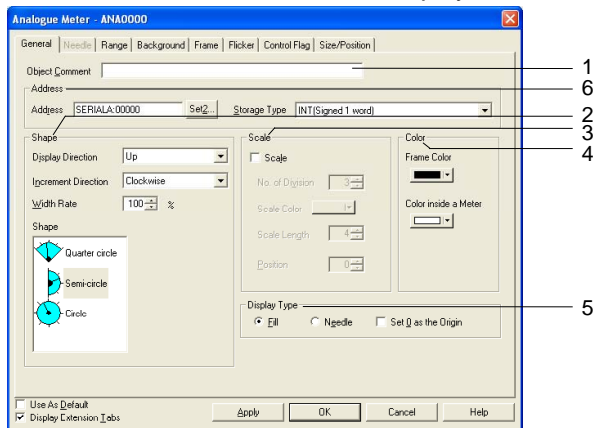
Sets the address and character display format for analogue meters.

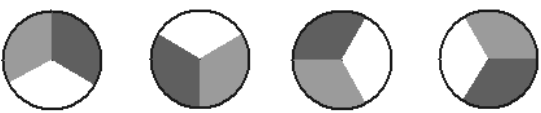
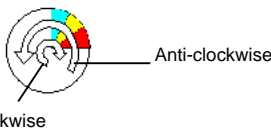
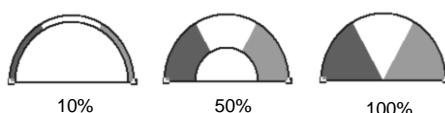

No.	Setting	Details
1	Object Comment	Sets an explanatory comment for the pasted object (up to 32 characters).
2	Shape	<p>Sets the analog meter shape. Select the meter shape from the list: Quarter circle, semi-circle, or circle.</p> <p><b>Display direction</b></p> <p>Set the display direction as <i>Up</i>, <i>Down</i>, <i>Left</i>, or <i>Right</i> for quarter-circle and semi-circle meters. For circle meters, the starting point for the meter is set by the display direction.</p> <p><b>Quarter-circle Analogue Meters</b></p> <p>Up    Down    Left    Right</p>  <p><b>Semi-circle Analogue Meters</b></p> <p>Up    Down    Left    Right</p>  <p><b>Circle Analogue Meters</b></p> <p>Up    Down    Left    Right</p> 
	Increment direction	<p>Sets the incremental direction for the meter.</p> 
	Width Rate	<p>Specifies the meter width as a percentage of the radius (10% to 100%).</p> <p>Example: When meter widths for semi-circle meters set to <i>Up</i></p>  <p>10%                  50%                  100%</p>
	Shape	Selects the shape from a quarter circle, semi-circle, and circle.

**NS Series Programming Manual**

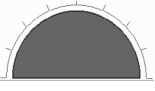
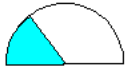
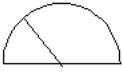
No.	Setting	Details
3	Scale	Sets whether or not the meter will have a scale. The number of scale lines and their color, length, and position can be set.  <div style="border: 1px solid black; padding: 5px; display: inline-block;">                     Example:                      Divisions: 8                      Length of scale lines: 10                      Position: 10                 </div>
	No. of divisions	Separates the edge of the specified object into 1 to 99 gradations.
	Scale Color	Selects the scale color from 256 colors.
	Scale length	The scale lines can be set between -32 to 32 dots.
	Position	Sets the scale position between 0 and 999 dots (within the radius width). "0" is on the meter line and + is toward the outside.
4	Color	Sets the frame, inside meter, and needle colors.
5	Display type	Sets the display type for the meter. Selects whether up to the current value will be filled or whether it will be indicated by the needle. If the origin is 0, select <i>Set 0 as the Origin</i> (i.e., fill). If the origin is 0, 0 becomes the border and the meter is filled in the incremental direction if the value is position and in the opposite direction if the value is negative. The meter is filled from the starting point if the origin is not 0.   Fill                      Needle
6	Address	Specifies the address and the storage type.
	Address	Specifies the address for obtaining the current value for the meter. Only word addresses can be set.
	Storage type	Select and set the storage type from the pull-down list.

**Needle**

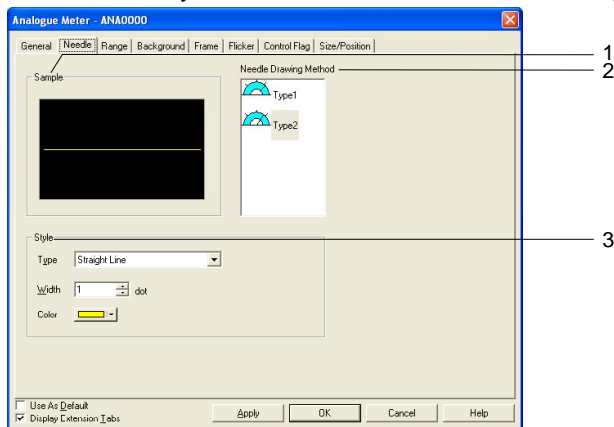

Sets the needle type and style.

Can be set only when Needle is selected as the display method on the General Tab Page.



No.	Setting	Details
1	Sample	Displays a sample of the currently set needle shape.

**NS Series Programming Manual**

No.	Setting	Details
2	Needle Type	Selects the type of needle for the meter. Type 1  Type 2 
3	Style	Sets the needle style.
	Shape (See note.)	Selects straight line, arrow, or triangular arrow as the needle shape.
	Width (See note.)	Selects the width from 1 to 3 (dots). This setting can be made when the shape is set to either straight line or arrow.
	Color	Selects the color for the arrow.

Note: Can be set only for PT system version 8.2 or higher.

**Range Tab Page**

Sets the maximum, minimum, and borders for ranges 1 to 3.

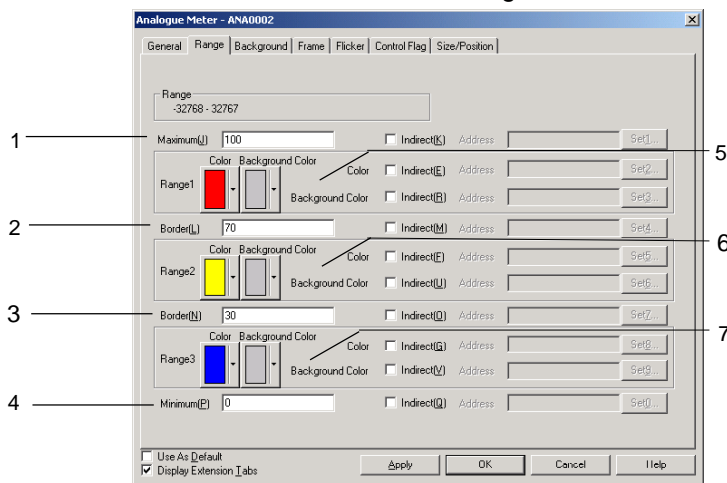

No.	Setting	Details
1	Maximum	Maximum range value or indirect word address
2	Border	Border for range 1/range 2 or indirect word address
3	Border	Border for range 2/range 3 or indirect word address
4	Minimum	Minimum range value or indirect word address
5	Range1	Sets the fill color and background color for range 1. These colors can also be set indirectly through a communications address.
6	Range2	Sets the fill color and background color for range 2. These colors can also be set indirectly through a communications address.
7	Range3	Sets the fill color and background color for range 3. These colors can also be set indirectly through a communications address.

**Reference**

- ◆ The ranges that can be set for each item depend on the selected storage type. Refer to *Numerical Display and Storage Type (General Tab)* in 2-8 Common Functions of Functional Objects.
- ◆ When referencing the border indirectly, specify a value in the same type as the storage type set on the General Tab Page.  
For example, if *REAL* (real number) is specified on the General Tab Page, set the border as a real number.
- ◆ When indirectly referencing the border, make sure the size relationships between the maximum, minimum, and borders are correct. If the size relationships are incorrect, the level display object will not be displayed correctly.

### Background Tab Page

Sets the fill color for the background of functional objects. Refer to *Background* and *Setting Colors* under *2-8 Common Functional Object Functions* for details.

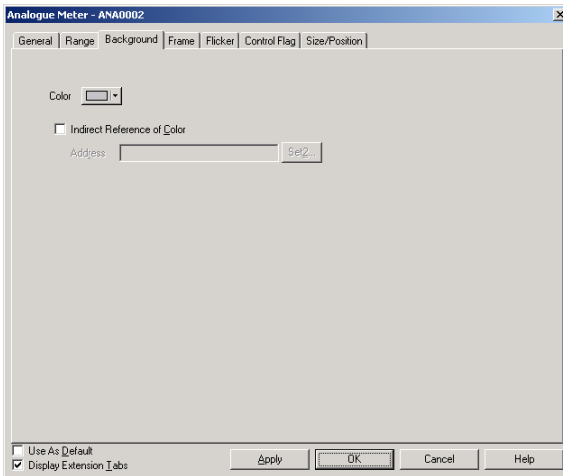

### Flicker Tab Page (Extension Tab)

Makes flicker settings to make the analogue meter flicker (flash). Refer to *Flicker* under *2-8 Common Functional Object Functions* for details.

### Frame Tab Page (Extension Tab)

Specifies the colors and sizes of the functional object frame to change the shape or color when the button is depressed or raised. Refer to *Frames* under *2-8 Common Functional Object Functions* for details.

Analogue meters themselves are based on circles but the frame is drawn as a rectangle.



### Control Flag Tab Page (Extension Tab)

Control flags can control the display of functional objects. Use control flags to enable display when the contents of an address turn ON or OFF. Refer to *Control Flags* under *2-8 Common Functional Object Functions* for details.

### Size/Position Tab Page (Extension Tab)

Displays and sets the functional object size and position. Refer to *Size/Position* under *2-8 Common Functional Object Functions* for details.

## 2-13-5 Video Display

An NS-CA001 Video Input Unit or NS-CA002 RGB/Video Input Unit can be installed to display images from video cameras or Vision Sensors on the PT.

An NS-CA001 Video Input Unit can be installed on an NS12, NS10, or NS8 PT to connect up to four video cameras or Vision Sensors. The NS-CA001 Video Input Unit cannot be mounted to the NS15 or NS5.

A NS-CA002 RGB/Video Input Unit can be installed on an NS15, NS12, NS10, or NS8 PT. With an NS15 PT, however, only an RGB inputs can be used. Refer to the *NS-series Programmable Terminals RGB and Video Input Unit Operation Manual* (Cat. No. V086) for the setting methods of the NS-CA002 RGB/Video Input Unit.

### Reference

- ◆ There are two choices for the video input method with either the NS-CA001 or NS-CA002: NTSC and PAL. To select the video input method, select **PT – System Setting** and click the **Video** Tab.
- ◆ When connecting more than one camera, the NTSC/PAL setting for those cameras are performed at once. The input method cannot be set for each camera individually.

## Creating Video Displays

The method of creating video displays and precautions in doing so are described here for the NS-CA001 Video Input Unit. Refer to the *NS-series Programmable Terminals RGB and Video Input Unit Operation Manual* (Cat. No. V086) for information on the NS-CA002 RGB/Video Input Unit.

### Creating Video Displays

To create a video display, select **Functional objects - Video Display** or click the  icon on the CX-Designer.

### Precautions in Creating Video Displays

#### 1. Display Size

Unlike other functional objects, the user must choose the size for the video display from three choices listed below. The selected size cannot be changed using the mouse on the screen. The sizes that can be selected depend on the PT model.

- Object size 320 x 240
- Object size 640 x 480
- Object size 800 x 600 (NS12 only)

#### 2. Using a 800x600 Display as the Default

If the NS12 is set for the PT model and the 800x600 size is set as the default for video displays and then the model is changed from NS12 to NS10 or NS8 and a video display is created on the screen, the size of the object will be 800x600. This object will be larger than the screen. Change the object size to 320x240 or 640x480.

#### 3. Changing the PT Model

If you select the NS12 for the PT model, create a 800x600 video display object, and change the PT model, the screen size will become smaller but the object size will remain at a 800 x 600 size. In this case, make sure to change object size to 320 x 240 or 640 x 480, or the object will extend off the screen.

#### 4. Screens Not Permitting Video Displays

Video displays can be created only on normal screen. Video displays cannot be created on the following screens.

- Pop-up screens
- Sheets



- Frames

### 5. Overlapping Video Display Objects

If an error or message dialog is displayed on the screen for a macro instruction, the video display will be temporarily stopped. Press **OK** Button in the dialog box to redisplay the video display.

- 
- Note**
- Video displays cannot be performed on the NS5-SQ□/NS5-TQ□/NS5-MQ□. The user can create a video display CX-Designer with the NS5-SQ□/NS5-TQ□/NS5-MQ□ selected as the PT model, but do not transfer the screen data to the PT.
  - Do not place other objects on a video display object. Video displays will always be on top on the PT and objects placed under the video display will be invisible.
  - Pop-up screens and keypads created on a video display also will not be displayed. Create object so that they do not overlap with video display objects.
- 

## Displaying Images

The Video Input Unit has four Input channels so that up to 4 video devices can be connected. If the size is set to 800 x 600 or 640 x 480, 1 channel will be specified in the properties and displayed even if all channels have devices connected to the PT. When choosing a 320 x 240 size, the number of display channels (1 to 4) and display positions can be selected in the properties.

## Setting Properties

The items set in the Video Display Dialog Box are explained here.

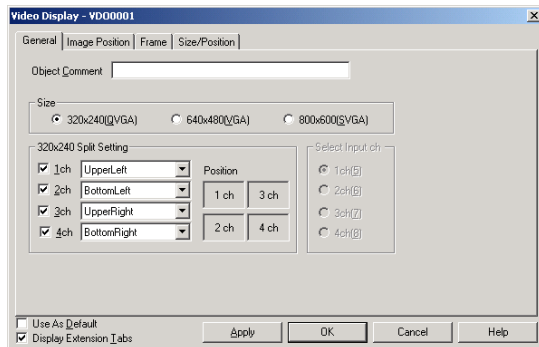

**General:** Select the display size and input channel.

**Frame:** Set the frame color for the video display.

**Image Position:** Select the image location where you want to start getting the data from the video device and set the space line.

**Position:** Set the display position on the screen. (See note.)

**Note:** This tab will be displayed when the *Display Extension Tabs* Option is selected.

### General Tab Page

Select the display size and input channels.

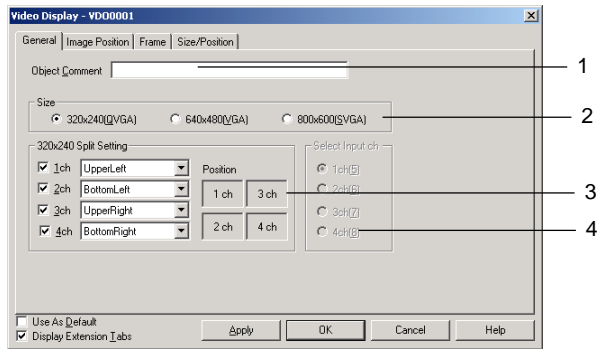

No.	Item	Details
1.	Object Comment	Enter the comment as an explanation of created object (up to 32 characters).
2.	Size	Select the display size. A 800x600 size can be specified only when the NS12-TS0□-V□ is selected for the PT model.
3.	320x240 Split Setting	<p>When 320x240 size is selected, a screen is split into 4 areas and pictures of all four channels can be displayed on the screen. Select display position of the pictures for each input channel.</p> <p>Example: Choosing channel 1 for the upper left, and channel 2 for the bottom left.</p> <p>Images are displayed as shown below.</p>
4.	Select Input CH	When choosing 640x480 or 800x600, set the input channel that you want to display.

**NS Series Programming Manual**

**Image Position Tab Page**

Select the part of the image that is to be displayed on the screen. This function is designed to modify non-display areas contained in the data so that only necessary parts are displayed.

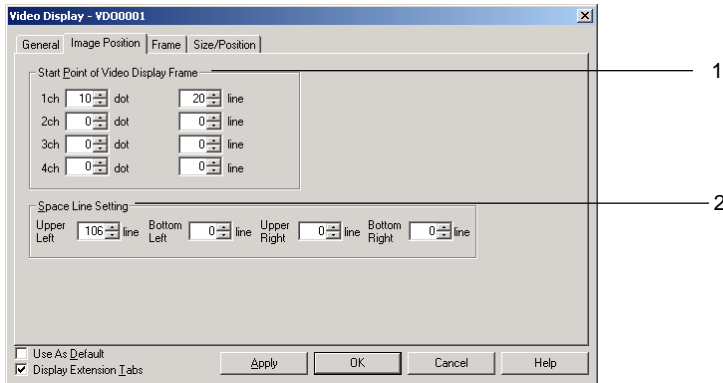

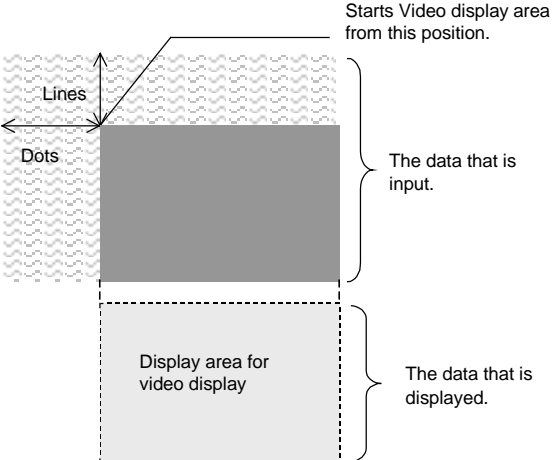
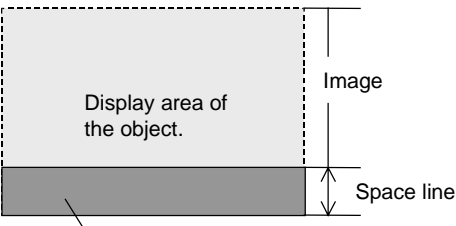
No.	Item	Details
1.	Start Point of Video Display Frame	<p>Set the start position to get the data from the channel.</p>  <p>The data that is input.</p> <p>The data that is displayed.</p> <p>Set the range as shown below.                  Dot position: -64 to 127                  Line position: -5 to 31</p> <p>The image will be irregular if the dot position or line position cause the input image data to exceed the valid range.</p>
2.	Space Line Setting	<p>If image size is smaller than display area, spare part will be filled with black and displayed. Set the size of fill area.</p>  <p>The area set as space line is filled with the black on display area.</p> <p>Set within the ranges shown below.                  320x240: 0 to 239                  640x480: 0 to 479                  800x600: 0 to 599</p>

### Frame Tab Page

Select a frame color.

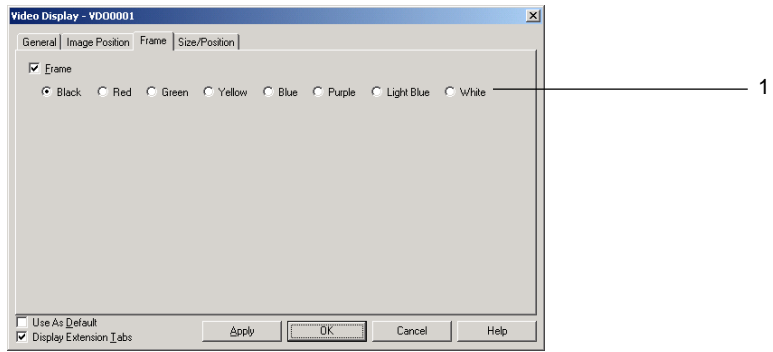

No.	Item	Contents
1	Frame	If you specify a frame, then select a frame color.

**Note**

- ◆ A frame cannot be set when using a 800x600 size.

### Size/Position Tab Page (Extension Tab)

Specify the display position for the video display by entering the horizontal position (X) and the vertical position (Y) from the upper left corner of the screen. The setting ranges for X and Y are 0 to 160 and 0 to 120. Specify vertical and horizontal position in dot units.

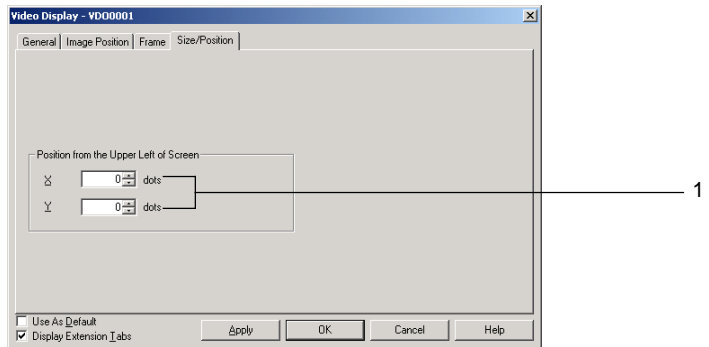

No.	Item	Details
1.	Position from the upper left of the screen	Specify the display position from the upper left corner of the screen. Setting ranges are as follows: X:0 to 160 Y:0 to 120

**Note**

- ◆ The video display cannot be moved outside of the screen.
- ◆ The position can be set only when choosing 640x480 or 320x240 size on the NS12.

**NS Series Programming Manual**

### 2-13-6 Consecutive Line Drawings

A consecutive line drawing is an object drawn within the object area using communications address values as coordinates of the vertex points. Unlike regular polylines, these shapes can be changed dynamically. The top left vertex of the created object is the origin. If a vertex is outside of the object area, that vertex will not be drawn.

The communications address values specify each vertex's X and Y coordinates.

The top-left point of the object is (0, 0).

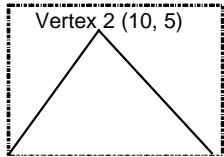

The vertices change as the values of the communications addresses change.

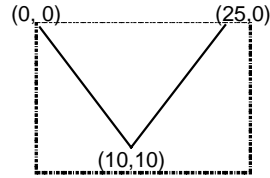
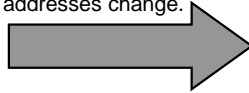

Vertex 1 (0, 0)      Vertex 3 (20, 10)

The Start address of X-Y coordinate is set to \$W100.

- \$W100=0      } Coordinates of vertex 1
- \$W101=10    }
- \$W102=10    } Coordinates of vertex 2
- \$W103=5     }
- \$W104=20    } Coordinates of vertex 3
- \$W105=10    }

- \$W100=0
- \$W101=0
- \$W102=10
- \$W103=10
- \$W104=25
- \$W105=0

The Start address of X-Y coordinate is set to \$W100.

- \$W100=10
- \$W101=10
- \$W102=20
- \$W103=20
- \$W104=80
- \$W105=10
- \$W106=30
- \$W107=30

Created object area

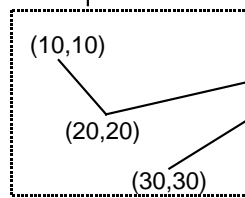

(80,10)

Parts of the object outside of the area are not drawn.

### Functional Object Property Settings

This section describes the functional object property settings in the Consecutive Line Drawing Window.

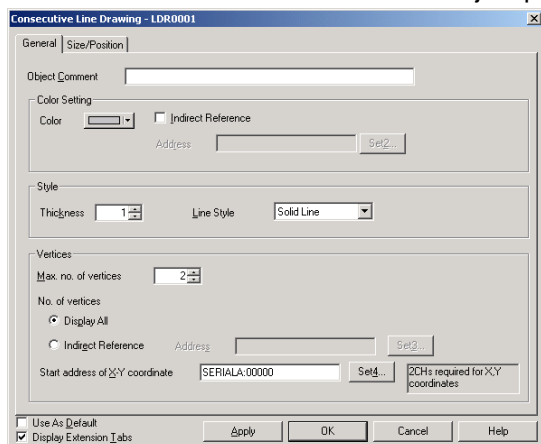

**NS Series Programming Manual**

General: Sets basic properties such as the maximum number of vertices and the starting address of the X-Y coordinates.

Size/Position: Sets the object's size and position. (See note.)

Note: This tab is displayed when the *Display Extension Tabs* Option is selected.

**General Tab Page**

Use the General Tab Page to set basic properties such as the maximum number of vertices and the starting address of the X-Y coordinates.

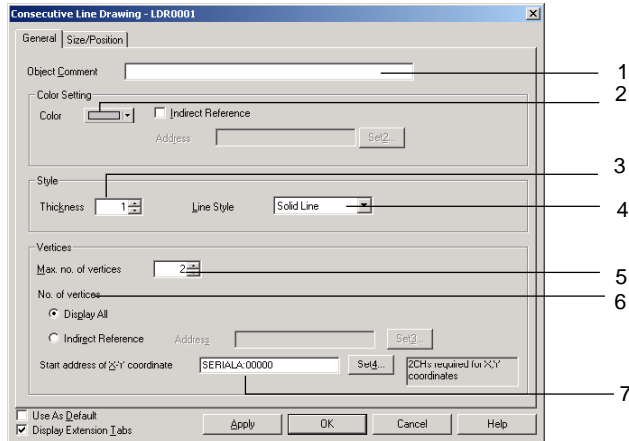

No.	Item	Details
1	Object Comment	Sets an explanatory comment for the pasted object. (Up to 32 characters.)
2	Color	Sets the line color. The color can also be set indirectly through an address.
3	Thickness	Sets the line thickness. If the <i>Line Style</i> is set to <i>Solid Line</i> , the thickness can be set between 1 and 8. For other line styles, the thickness can be set to either 1 or 2.
4	Line Style	Sets the line style to one of the following 5 styles. <ul style="list-style-type: none"> <li>• Solid line</li> <li>• Broken line</li> <li>• Dotted line</li> <li>• 1-dot chain lines</li> <li>• 2-dot chain lines</li> </ul> A line thickness of 3 or higher can be set for a solid line only.
5	Max. no. of vertices	Sets the maximum number of vertices between 2 and 128.
6	No. of vertices	When the <i>Display All</i> Option is selected, all of the vertices set in the <i>Max. no. of vertices</i> setting will be displayed. When the <i>Indirect Reference</i> Option is selected, the number of vertices indicated in the specified address will be displayed. If the specified address's value is 0 or 1, the object will not be drawn.
7	Start address of X-Y coordinate	Sets the starting address of the communications addresses containing the X-Y coordinates. Set the addresses so that the start address contains the X coordinate of vertex 1, the next address contains the Y coordinate of vertex 1, and each subsequent pair of words contains the X and Y coordinates for one vertex.

**Note**

- ◆ To set the data format (BCD or binary) for an indirectly referenced *Color*, an indirectly referenced *No. of vertices*, and the X-Y coordinate data starting at the *Start address of X-Y coordinate*, select **Project Properties** from the PT Menu and set the data format on the Data Format Tab Page.

**Size/Position Tab Page (Extension Tab)**

Displays and sets the functional object size and position. Refer to *Size/Position* under 2-8 Common Functional Object Functions for details.

## 2-14 Alarms and Events

### 2-14-1 Outline

Alarms and events are functions that enable addresses registered for alarm monitoring to provide notification for alarms from those addresses. Alarms and events can also be used as functions that execute display when a bit to which start operation or a similar event has been specified is turned ON.

Up to 5,000 alarms and events can be registered and monitored for one project with NS-series PTs.

Related functional objects can display current alarms/events (alarm/event display) or a historical list (alarm/event summary and history). Also, the display can be switched automatically to a specified screen while an alarm or event is generated.

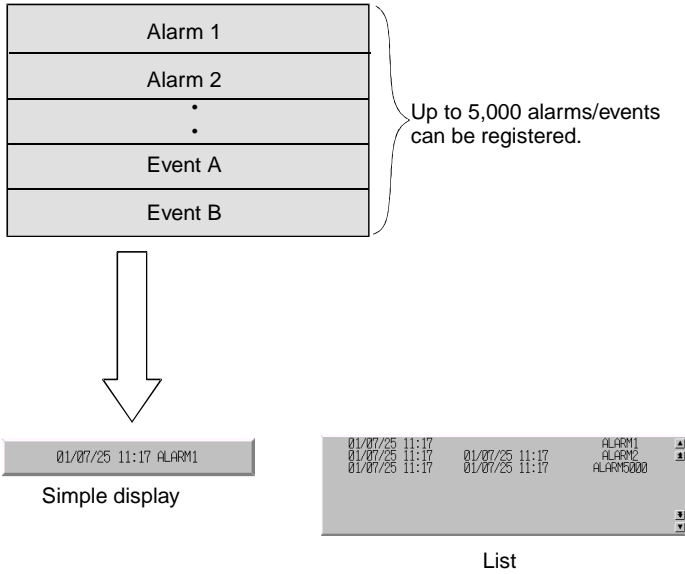

### Registering Alarms/Events

Alarms/events must be registered before related functional objects are used. Either select **PT - Alarm/Event** or click the **Register alarm/event** Button in the Properties Dialog Box for the related functional object.

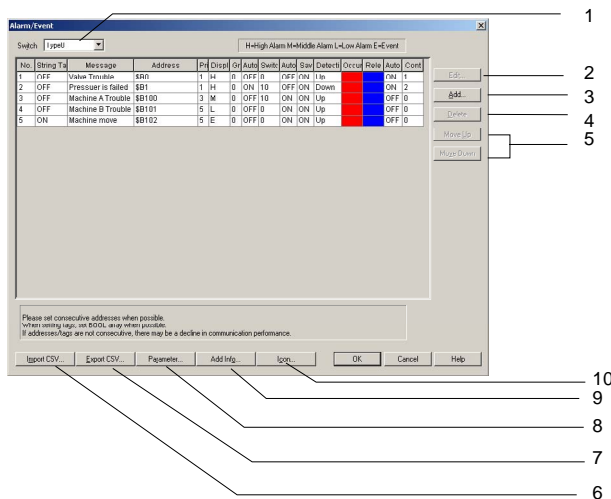

No.	Setting	Details
1	Switch	Switches the message display for each label.
2	Edit	Changes settings for the selected item in an alarm/event list. Click the <b>Edit</b> Button to display the Alarm/Event Details Dialog Box.
3	Add	Creates a new alarm/event. Click the <b>Add</b> Button to display the Alarm/Event Details Dialog Box.
4	Delete	Deletes the selected item in an alarm/event list. Click the <b>Delete</b> Button to display a confirmation box and click the <b>Yes</b> Button to delete the item.
5	Move up/Move down	Moves up or down the number for the item selected in the alarm/event list.
6	Import CSV	Alarm/event settings edited in CSV format can be imported from a file. Click the <b>Import CSV</b> Button to display the Select alarm CSV Import Dialog Box. Select either <b>Add to Current Alarm</b> or the <b>Delete Current Alarm</b> and click the OK button.
7	Export CSV	Alarm/event settings can be exported to CSV files. Click the <b>Export CSV</b> Button to display the Export CSV Dialog Box. Specify the file name and click the <b>Save</b> Button.
8	Parameter	Sets the screen switching when alarms or events are generated and the conditions for saving alarm/event history. Click the <b>Parameters</b> Button to display the Alarm/Event Parameters Settings Dialog Box.
9	Add Info.	Allocates the address to refer when an alarm or event occurs. Click the <b>Add Info.</b> Button to display the Add Alarm/Event Info. Dialog Box.
10	Icon	Specifies a bitmap or JPEG file for the icon. Click the <b>Icon</b> Button to display the Details Dialog Box.

### Reference

- ◆ Messages can be set for each label for registered alarms or events.
- ◆ Registered alarms/events can be output in CSV format and edited as a group. Refer to *Importing and Exporting CSV Files* on page 2-303 for details.
- ◆ The communications speed may be reduced if consecutive addresses are not set in the Alarm/event Setting Items Dialog Box under *Alarm/event setting*. Set consecutive addresses if the communications speed is slow.



**NS Series Programming Manual**

**Adding and Editing Alarms/Events**

Alarms and events can be added or edited.

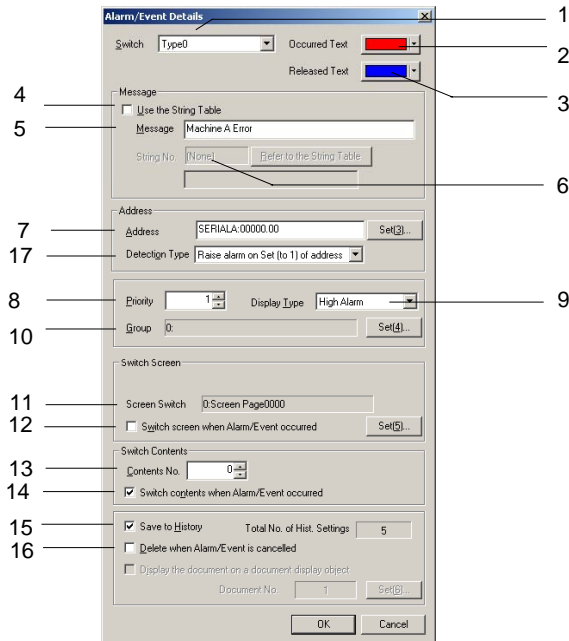

No.	Setting	Details
1	Switch	Sets messages for each label.
2	Occurred Text	Sets the character color displayed when alarms or events occur.
3	Released Text	Sets the character color displayed when alarms or events are cleared.
4	Use the String Table	Select to use a character string registered in the character string table as messages to display functional objects related to alarms and events.
5	Message	Sets the message (up to 80 characters) to be displayed on related functional objects.
6	String No.	Selects the character string to be displayed as a message from the character string table displayed when the <b>Refer to the String Table</b> Button is clicked if the <i>Use the String Table</i> Option is selected. The selected character string number is displayed in the <i>String No.</i> Field.
7	Address	Sets the address to monitor alarms/events.
8	Priority	Sets the alarm/event priority order (1 to 9,999). The display order on related functional objects can be changed based on the priority order.
9	Display Type	Select one of the following four types of display. High alarm Middle alarm Low alarm Event Restrictions can be applied based on the display type when displaying alarms using related functional objects.
10	Group	Specifies the group that belongs to the set alarm/event data. Click the <b>Set</b> Button to display the Alarm/Event Group Settings Dialog Box. Select the group, add it, and click the <b>OK</b> Button. Refer to <i>Specifying Alarm/Event Groups</i> for details. Only information for specified groups can be displayed when displaying on related functional objects.
11	Screen Switch	Sets the screen that will be automatically switched to when an alarm or event is generated.

**NS Series Programming Manual**

No.	Setting	Details
12	Switch screen when Alarm/Event occurred	Automatically switches screens when alarms/events are generated, i.e., when the contents of the specified address turn ON.
13	Contents No.	Sets the contents number for contents display when an alarm/event occurs.
14	Switch contents when Alarm/Event occurred	Automatically switches to the contents display to the contents set under <i>Contents No.</i> if this checkbox is selected and an alarm/event occurs.
15	Save to History	Records when alarms/events are generated and cleared. The number of alarms and events and the messages are also saved to the history file.
16	Delete when Alarm/Event is cancelled	Automatically clears messages from related functional objects when alarms/events are cleared, i.e., when the contents of the specified address turn OFF. The messages are displayed again if the address turns ON again. This option is available only when <i>Save to history file</i> is not selected.
17	Detection Type	Sets the method for detecting alarms and events. Raise alarm on Set (to 1) of address: An alarm has occurred when the address set for the alarm/event goes from OFF to ON and is cleared when the address goes from ON to OFF. Raise alarm on Reset (to 0) of address: An alarm has occurred when the address set for the alarm/event goes from ON to OFF and is cleared when the address goes from OFF to ON.

**Note**

- ◆ The following restrictions apply when referencing the character string table.
  - If the character string has more than 80 characters, it will be treated as a message with 80 characters max.
  - If there are multiple lines set for the character string, the first line of the character string will be treated as the message.

**Specifying Alarm/Event Groups**

Specifies the group that belongs to the set alarm/event data.

Select the group in the CX-Designer Dialog Box and click the **OK** Button.

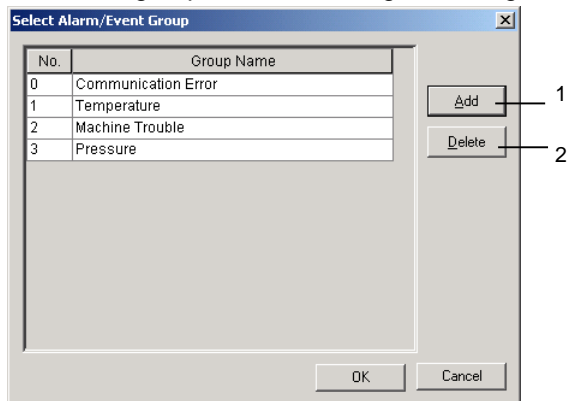

No.	Setting	Details
1	Add	Creates a new group. Click the <b>Add</b> Button and set a group name of up to 32 characters.
2	Delete	Deletes the group selected from the list.

**Automatically Setting a Variable Name or I/O Comment in a Message**

When an address has been set in the *Address* Field of the Alarm/Event Details Dialog Box, the communications address' symbol name or I/O comment can be automatically set as the alarm message.

- 1 Select Options from the Tools Menu.

**NS Series Programming Manual**

Open the Edit/Disp Tab Window in the Option Dialog Box.

- 2 Select Reflect symbols in labels when setting addresses, and select either Symbol Name or I/O Comment for the label character string.

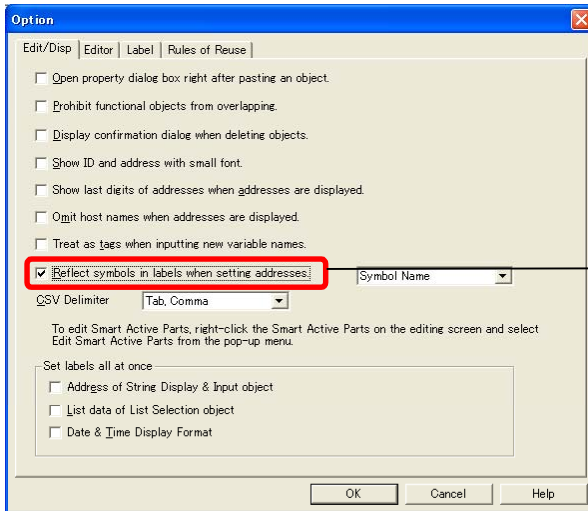

Check the box as shown, and select either *Symbol Name* or *I/O Comment* for the label character string.

- 3 Set the communications address in the *Address* Field of the Alarm/Event Details Dialog Box.
- 4 The symbol name or I/O comment for the communications address that was set for the message will be set automatically.

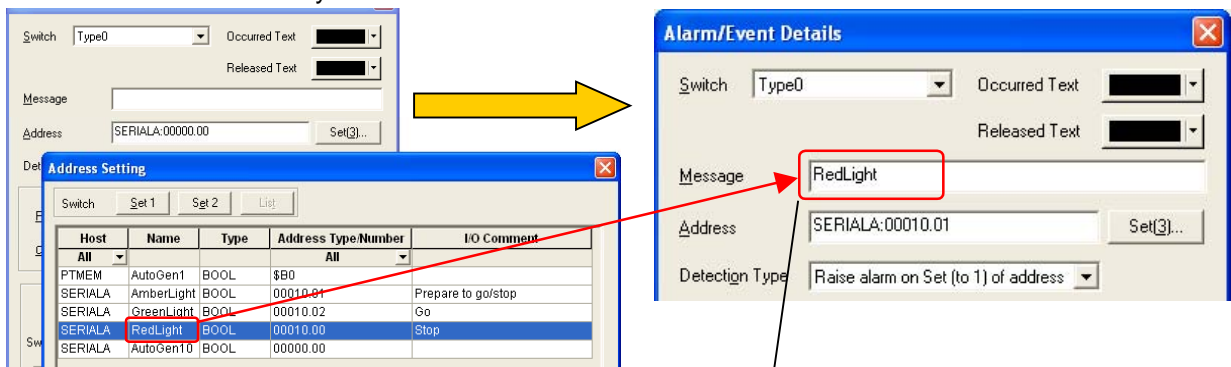

The variable name or I/O comment for the communications address will be set automatically.

**Note**

- ◆ If there are two or more labels, the symbol names and I/O comments will be set for the character strings for all of the labels.
- ◆ Symbol names and I/O comments will not be set automatically in the following cases:
  - When the communications address is replaced by another one.
  - When a symbol name or I/O comment is changed from a symbol table after the label character string has been set.
  - When an alarm/event was added from a CSV import.
  - When the *Use the String Table* Option is selected.
- ◆ If the *Reflect to label when an address is set* Option is selected in the Option Dialog Box, the symbol name or I/O comment will be reflected in the label of an ON/OFF Button, Word Button, Bit Lamp, or Word Lamp when the communications address is set.

**NS Series Programming Manual**

**Importing and Exporting CSV Files**

The CSV import and export functions are useful when there are numerous alarms or events registered and they need to be edited efficiently.

Click the **Import CSV** or **Export CSV** Button in the Alarm/Event Settings Dialog Box.

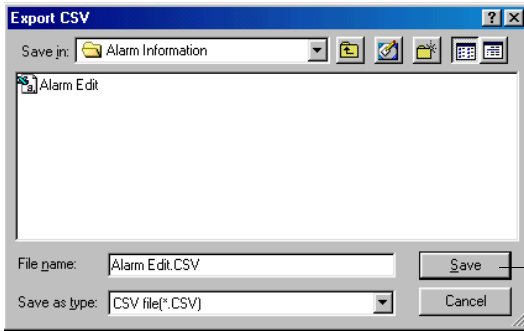

Changes to **Open** when importing CSV files.

A File Selection Dialog Box will be displayed. If exporting to a CSV file, enter the name of the file in the *File name* input field and click the **Save** Button. If importing from a CSV file, select the name of the file to be imported and press the **Open** Button. The output CSV file will be displayed in the following format. Display for Microsoft Excel

	A	B	C	D	E	F	G	H	I	J	K	L
1	CXDNVER3											
2	Address	Priority	Display Type	Group No.	Group Name	Auto Switch Screen	Screen No.	Auto Deletion	Save History	Occurred Text	Released Text	Detection Type
3	\$B0	1	highalarm	1	Group1	OFF	50	OFF	ON	12	9	passedire
4	\$B1		1 event		2 Group2	ON		10 OFF	OFF		53	11 neeedge
	1	2	3	4	5	6	7	8	9	10	11	12

	M	N	O	P	Q	R
	Auto switch contents	Contents No.	Refer to the String Table	String No.	Label(Type0)Alarm Message	Label(Type1)Alarm Message
	ON	10	OFF		Alarm1	ALARM1
	OFF	0	ON	20		
	13	14	15	16	17	18

No.	Setting	Details
1	Address	Sets the communications address. Only bit addresses can be set.
2	Priority	Sets the priority order (1 to 9,999).
3	Display Type	Sets the display type. highalarm: High alarm middlealarm: Middle alarm lowalarm: Low alarm Event: event
4	Group No.	Set the group number (0 to 99).
5	Group Name	Sets the group name (up to 32 characters long).
6	Auto switch screen	Select whether or not to switch screens automatically. ON: Automatic screen switch OFF: No automatic screen switch
7	Screen No.	Select the destination for automatic screen switching (0 to 3999).
8	Auto deletion	Sets whether or not to automatically delete alarms/events. ON: Automatic delete OFF: No automatic delete
9	Save history	Sets whether or not to save alarm/event history. ON: Save OFF: No save
10	Occurred Text	Sets the character color displayed when alarms or events occur (0 to 255).

No.	Setting	Details
11	Released Text	Sets the character color displayed when alarms or events are cleared (0 to 255).
12	Detection Type	Sets the method for detecting alarms and events. Raise alarm on Set (to 1) of address: posedge Raise alarm on Reset (to 0) of address: negedge
13	Auto switch contents	Sets whether or not automatic contents switching is enabled. Automatically switch contents switching: ON Do not automatic switch contents: OFF
14	Contents No.	Sets the contents number that is displayed when an alarm/event occurs (0 to 9999).
15	Refer to the String Table	Sets whether to reference a message character string from the character string table. Reference the character string table: ON Do not reference the character string table: OFF
16	String No.	Sets the character string number of the referenced character string when a message character string is referenced in a character string table. Leave blank if the message character string will not be referenced in the character string table.
17	Alarm message	Sets the display message (up to 80 characters). Leave blank if the message character string will be referenced in the character string table.
18	Title	The CX-Designer version information and the title for each item will be displayed in lines one and two of the CSV file. Do not change or delete this information.

*NS Series Programming Manual*

The set numerals and character strings can be all edited together because the efficient editing functions of the commercially available software can be used. Once editing has been completed, import the file again to enable the settings.

Alarm/event settings can be changed and added by using the import function.

The contents of the CSV file will change if an address is set in the file that is registered as an existing alarm/event. Alternatively, if an address that has not been registered yet is set to the CSV file, it will be added as a new alarm/event.

If the imported CSV file contains any errors (e.g., insufficient columns or number of columns increased), an error message will be displayed.



Click the **OK** Button to edit the CSV file.

**Note**

- ◆ CSV files can be edited using spreadsheet software or a text editor. If an exported CSV file is opened using a text editor, items with alarm messages or other character strings will be delimited by inverted commas (“ ”). Up to 1,110 characters can be set per line when using a text editor. This is the maximum number of characters that can be set for each item.  
Example: “Item 1,” “Item 2.”
- ◆ Up to 5,000 alarms or events can be set for each CSV file. If there are more than 5,000 alarms or events in a file, only 5,000 will be imported. The rest of the settings will be ignored.
- ◆ Use the **Move up/Move down** Button to change the alarm/event number after importing a CSV file.
- ◆ CSV files exported from the CX-Designer can be imported.

**Parameters**

Sets the screen switching for when alarms or events are generated and the conditions for saving alarm/event history.

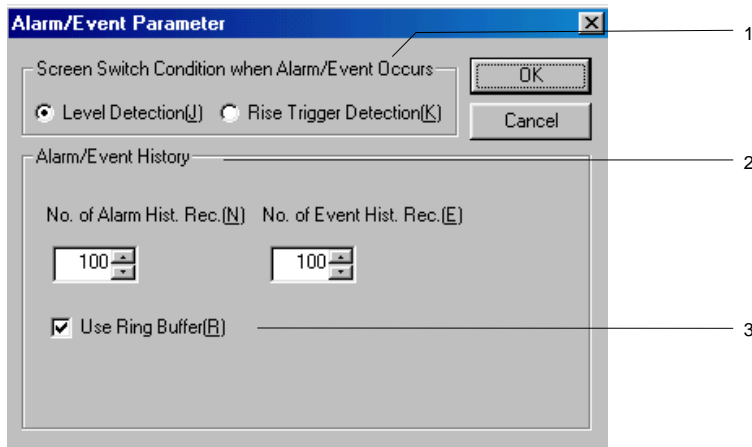

No.	Setting	Details
1	Screen Switch Condition when Alarm/Event Occurs	Select either <i>Level Detection</i> or <i>Rise Trigger Detection</i> for the screen switch condition when an alarm/event occurs. Refer to the following pages for details.
2	Alarm/Event history	Sets the maximum number of alarm and the maximum number of events to be recorded. Up to 1,024 can be set for each.
3	Use Ring Buffer	If <i>use ring buffer</i> is selected, the oldest alarm/event record will be deleted when the set record number is exceeded and an alarm/event is generated, and the new alarm/event will be saved. If <i>use ring buffer</i> is not selected, new alarms or events will not be recorded once the set record number has been reached.

**Reference**

- ◆ Alarm and event histories are kept separately.

**Level Detection**

Level detection is used to take a level when an alarm or event is generated and switch screens to the specified screen for the alarm/event with the highest priority. If multiple alarms or events occur at the same time, the display is automatically switched to the screen for the alarm/event with the highest priority.

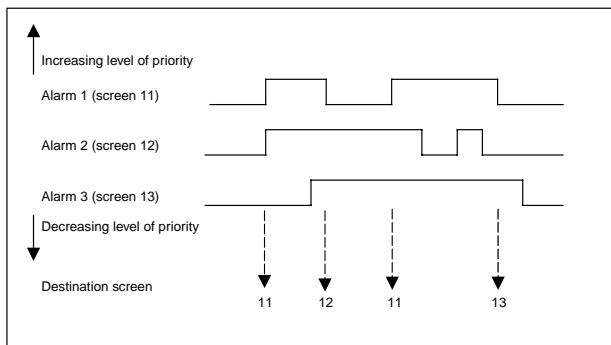

**Rise Trigger Detection**

Rising trigger detection is used to detect the start of the alarm/event and switches screens. If multiple alarms or events occur at the same time, the display is automatically switched to the screen for the alarm or event with the highest priority. If an alarm or event with lower priority than an existing alarm or event occurs, the screen will not be switched.

If alarms or events with the same priority level occur at the same time, the screen switching will start from the alarm or event with the lower number set under the alarm event setting (*PT - alarm/event setting*).

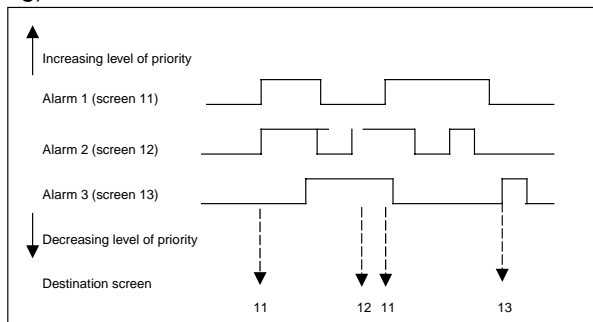

**NS Series Programming Manual**

**Add Alarm and Event Information**

Sets as attributes the addresses whose contents is to be displayed for alarm/event summaries or and history object or the addresses whose contents is to be stored in the alarm/event summary.

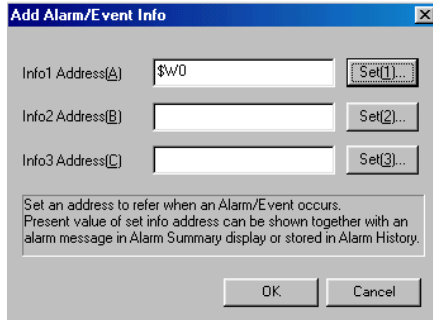

The specified address is referenced and displayed on the alarm/event summary and history object or saved.

The address can either be input directly or set in the Address Setting Dialog Box, which is displayed when the corresponding **Set** Button is clicked.

**Reference**

- ◆ To set the data type (BCD or binary) for the specified addresses, select **Project properties** from the **PT** Menu and set the data type on the Data Format Tab Page.

**Specifying Icons**

Sets bitmap files for the alarm/event summary and history object icon.

1. Select **PT – Alarm/event setting** to display the Alarm/event Settings Dialog Box. Click the **Icon** Button at the bottom of the screen to display the Details Dialog Box.

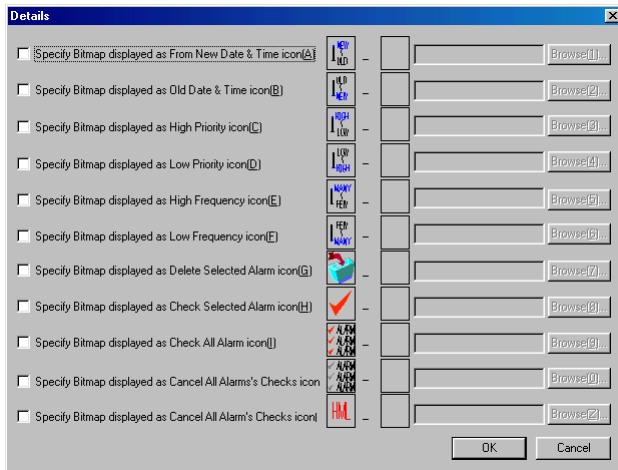

2. Select the check box for the icon for which the bitmap will be specified and click the **Browse** Button. The File Selection Dialog Box will be displayed. Specify the file to be displayed as the icon.



*NS Series Programming Manual*

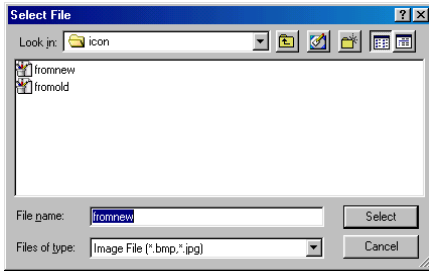

3. Click the **Select** Button to close the dialog box. An image of the selected bitmap file will be displayed to the right of the existing icon in the Details Dialog Box.
4. Click the **OK** Button to close the Details Dialog Box.
5. Click the **OK** Button to close the Alarm/event Settings Dialog Box.
6. Set the icon to be displayed on the Icon Tab of the Alarm/event Summary and History Object Properties Dialog Box.
7. Click the **OK** Button to close the Properties Dialog Box. The icons to which bitmap files have been specified will be displayed on the alarm/event summary and history object, as shown in the following diagram.

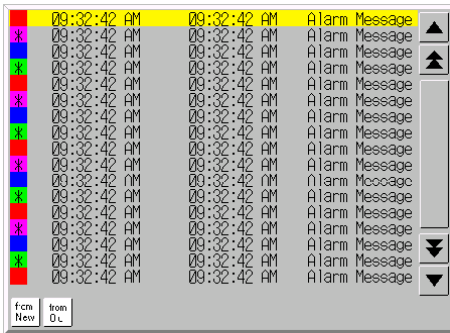

**Reference**

- ◆ When the number of colors in the designated image file is a True Color number, it is automatically reduced to 32,000.
- ◆ Specify a file name of up to 12 characters (8 file name characters and 3 file extension characters). The following characters can be used in filenames.  
Alphanumeric characters, underscore(\_), dollar signs (\$), and periods(.

### 2-14-2 Alarm/Event Display Objects

Alarm/event display objects are functional objects that display the current recorded alarm or event in one line. The highest priority alarm or event will normally be displayed, but multiple alarms or events can be displayed in order of highest priority if flowing text is specified.

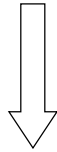
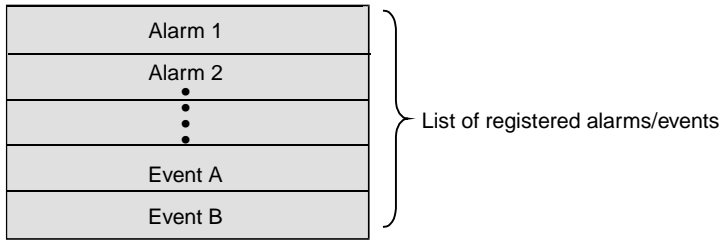

### Settings for Functional Object Properties

This section describes the settings in the Functional Object Properties Dialog Box for alarm/event display objects.

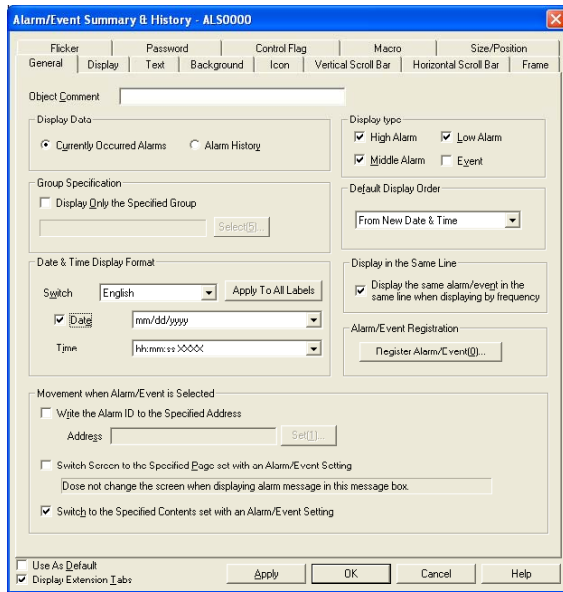

- General:** Sets the alarm/event display format.
- Flowing string:** Sets flowing string for the display character string.
- Text:** Sets the font and size for alarm/event display characters.
- Background:** Sets the background color for alarm/event display.
- Frame:** Sets the object frame display.
- Flicker:** Sets the flicker display. (See note.)
- Password:** Sets the password to be entered when the object is pressed. (See note.)
- Control Flag:** Sets enable/disable input and display/no display for objects. (See note.)
- Macro:** Sets the macros that will operate when the alarm/event display area is pressed. (See note.)
- Size/Position:** Sets the object size and position. (See note.)

**Note:** These tabs are displayed when *Display Extension Tabs* Option is selected.

### General Tab Page

Sets the alarm/event display format and display conditions.

The information in the Alarm/Event Registration Dialog Box can also be read from the General Tab Page.

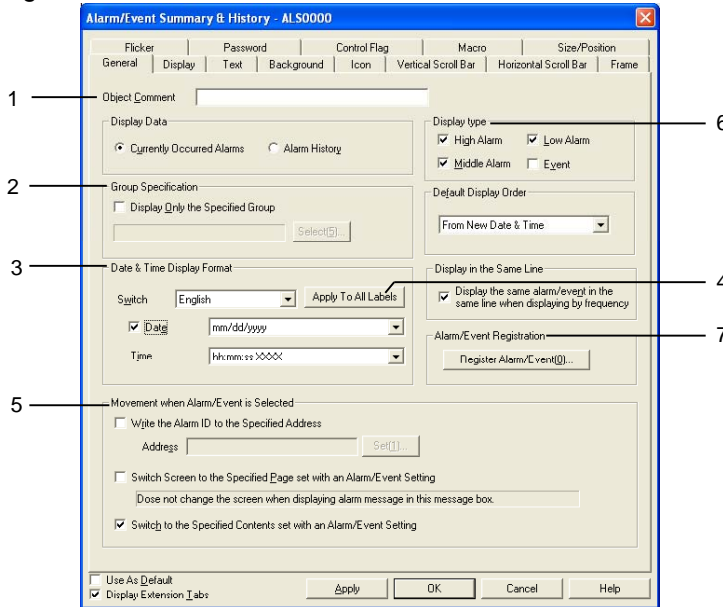

No.	Setting	Details
1	Object Comment	Sets an explanatory comment for the pasted object. (Up to 32 characters.)
2	Group specification	The display can be set to include only information from groups specified when alarms/events are registered. Select <i>Display only the specified group</i> and click the <b>Select</b> Button to display Select Alarm/Event Group Dialog Box.
3	Time and date display format	Displays the date and time of the alarm or event. Select both <i>Date</i> and <i>Time</i> and select the display format from the list. Refer to <i>Date and Time Format</i> in 2-8 <i>Common Functional Object Functions</i> for information.
	Switch	Sets the date and time display format for each label.
	Date display	Selects the date display format from the list.
	Time display	Selects the time display format from the list.
4	Apply to All Labels	Uses the date display method for the selected label for all labels. This setting is used only for labels for which a date display and time display are selected. <i>Apply to All Labels</i> cannot be set in the following cases. <ul style="list-style-type: none"> <li>When the <i>Date &amp; Time Display Format</i> Check Box is selected on the Edit/Display Tab Page of the Option Dialog Box accessed by selecting <b>Tools - Option</b>.</li> <li>When there is only one label.</li> <li>When a date display and time display are not selected.</li> </ul>
5	Movement when Display Area is Pressed	One of the following three operations can be selected for when the object area where the alarm/event is displayed is pressed.
	Switch Screen to the Specified Page Set with an Alarm/Event Setting	Jumps to the page registered to the display alarm/event when the display area is pressed.
	Switch to the Specified Contents set with an Alarm/Event Setting	Switches the contents display to the contents set to the alarm/event displayed when the display area is pressed.

**NS Series Programming Manual**

No.	Setting	Details
	Erase Displayed Message	Clears the displayed alarm/event message when the display area is pressed.
6	Display type	Select the alarm/event type to be displayed from the following 4 options. <ul style="list-style-type: none"> <li>• High alarm</li> <li>• Medium alarm</li> <li>• Low alarm</li> <li>• Event</li> </ul>
7	Alarm/event registration	Click the <b>Register Alarm/Event</b> Button to display the Alarm/Event Setting Dialog Box and register or edit alarms or events.

**Note**

◆ If nothing is selected under *Display type*, there will be no alarm/event to display and nothing will be displayed during PT operation.

**Flowing String Tab Page**

Displayed character strings can be set to flowing string.

When flowing string is set, the message information for the generated alarm/event will flow from right to left in the display area.

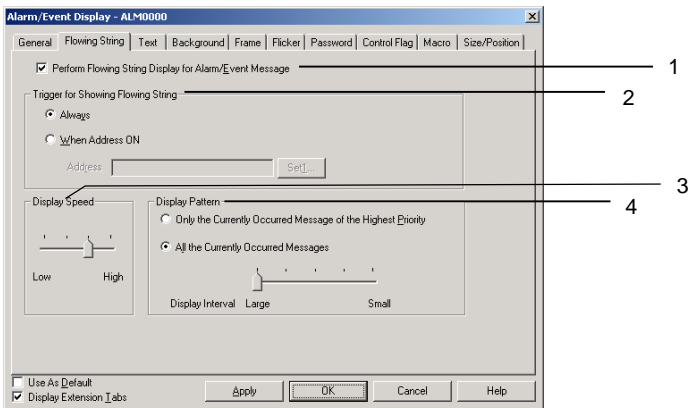

No.	Setting	Details
1	Perform Flowing String Display for Alarm/Event Message	When clicking the check box, the display conditions for flowing string for alarm/event messages can be set.
2	Trigger for Showing Flowing String	The timing for starting flowing string display can be selected from the following two options. <ul style="list-style-type: none"> <li>• Always.</li> <li>• When Address ON.</li> </ul>
3	Display speed	There are four speed options for flowing string. From fastest to slowest, the options are 100 ms, 500 ms, 1,000 ms, and 1,500 ms. The characters move to the left by one at a time at the specified speed.

**NS Series Programming Manual**

No.	Setting	Details						
4	Display pattern	<p>Select one of the following two display patterns.</p> <ul style="list-style-type: none"> <li>• Display Currently Occurred Message of the Highest Priority If there are multiple alarms/events with the same level of priority generated, the message for the latest alarm/event will be displayed.</li> <li>• All the Currently Occurred Messages If this option is selected, the display interval for each message can be specified.</li> <li>• Small (right edge): Messages flow with no interval. Example  <table border="1" style="margin-left: 20px;"> <tr> <td style="padding: 2px;">Alarm 1</td> <td style="padding: 2px;">Alarm 1</td> <td style="padding: 2px;">Alarm 1</td> </tr> </table> </li> <li>• Large (left aligned): Displays the next message once the previous message has moved completely across the screen. Example  <table border="1" style="margin-left: 20px;"> <tr> <td style="padding: 2px;">Alarm 1</td> <td style="width: 100px;"></td> <td style="padding: 2px;">Alarm 1</td> </tr> </table> </li> </ul>	Alarm 1	Alarm 1	Alarm 1	Alarm 1		Alarm 1
Alarm 1	Alarm 1	Alarm 1						
Alarm 1		Alarm 1						

**Note**

- ◆ The actual display speed may be slower than the specified speed, depending on the amount of screen data.

**Text Tab Page**

Sets the text attributes, such as font and color, for the display string. The text attribute settings will be reflected (appear) differently in CX-Designer, on the PT, and in test mode.

	Font	Character size	Character color
CX-Designer	○	○	○
PT	○	○	●
Test mode	○	○	●

- : Reflects alarm/event display property settings.
- : Reflects alarm/event settings made under the PT menu.

Refer to *Text Attributes* in 2-8 Common Functional Object Functions and *Outline* in 2-14 Alarms and Events.

**Background Tab Page**

Sets the background color for alarm/event display from 256 color options. Refer to *Background* under 2-8 Common Functional Object Functions for details.

**Frame Tab Page**

Specify the colors and sizes of the functional object frame to change the shape or color when the alarm/event display object is depressed or raised. Refer to *Frames* under 2-8 Common Functional Object Functions for details.

**Flicker Tab Page (Extension Tab)**

Makes flicker settings to make the object flicker (flash). Refer to *Flicker* under 2-8 Common Functional Object Functions for details.

**Password Tab Page (Extension Tab)**

A password can be set for when the alarm object area is pressed. Five passwords of up to 16 characters each can be set. One password can be requested for each object. Refer to *Passwords* under 2-8 Common Functional Object Functions for details.

**Control Flag Tab Page (Extension Tab)**

Control flags control the input and display of functional objects. Use control flags to enable display or input when the contents of an address turn ON or OFF. Refer to *Control Flags* under *2-8 Common Functional Object Functions* for details.

**Macro Tab Page (Extension Tab)**

Macros can be specified for alarm/event display objects.  
Refer to the CX-Designer's *NS-series Macro Reference* for information on setting macros.

**Size/Position Tab Page (Extension Tab)**

Displays and sets the functional object size and position. Refer to *Size/Position* under *2-8 Common Functional Object Functions* for details.

### 2-14-3 Alarm/Event Summary and History

Alarm/event summary/history objects are functional objects that display the current recorded alarm or event messages as a list. The display order can be specified, e.g., by date, by priority level, and by frequency.

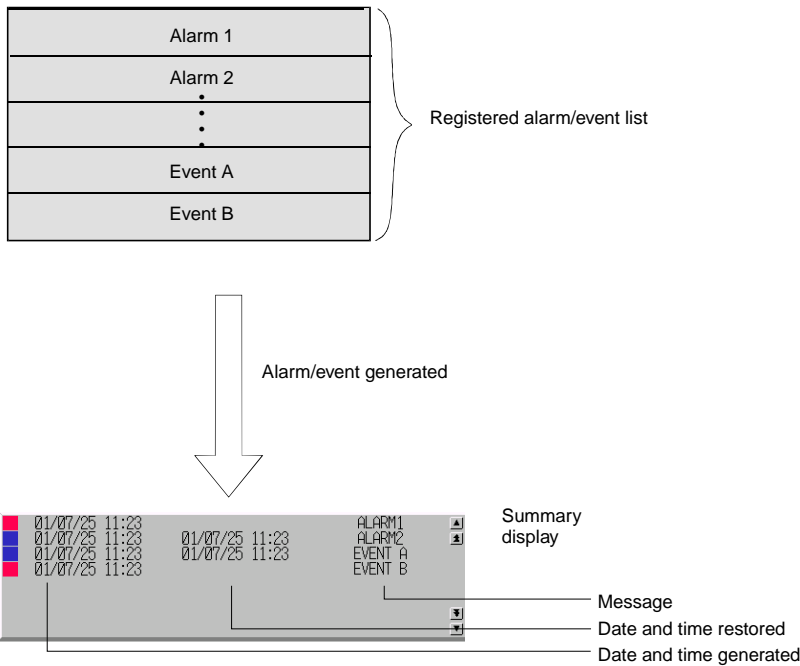

The display is refreshed every time an alarm or event specified for display is generated or reset. The refreshed display will be in the set display order.

**Note**

- Sometimes not all information can be displayed on the screen, depending on the set number of message characters or display items.

When a displayed alarm or event is selected with the NS15, NS12, NS10, or NS8, the Ladder Monitor will start, and the communications address set for the selected alarm or event can be searched for. The Ladder Monitor will automatically find the program section from which the alarm or event is output.

NS Series Programming Manual

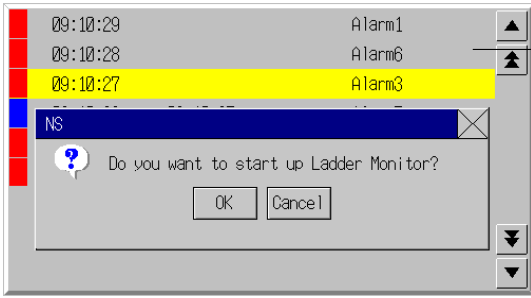

Select an alarm or event and start the Ladder Monitor.

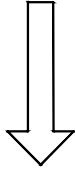

The Ladder Monitor starts.

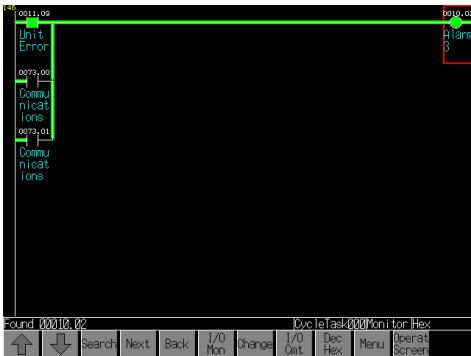

The communications address for the selected alarm or event will be searched for automatically.

For details, refer to 2-14-4 Searching for Alarms and Events Using the Ladder Monitor.

For information on the Ladder Monitor, refer to the NS-series Ladder Monitor Operation Manual (Cat. No. V082).

**Note**

- ◆ This function can be used if the NS system is version 8.0 or higher and the Ladder Monitor is version 3.0 or higher.



## Settings for Functional Object Properties

This section describes the settings in the Functional Object Properties Dialog Box for alarm/event summary and history objects.

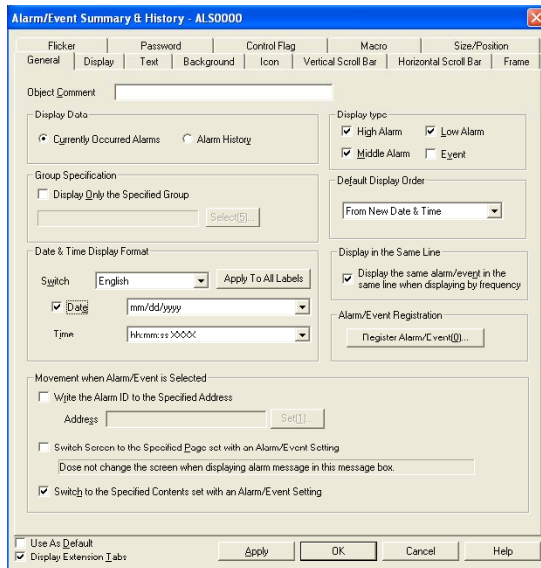

General:	Sets the alarm/event display format and display order.
Display:	Sets the selection bar color, line height, and alarm/event summary display items.
Text:	Sets the font and size for alarm display characters.
Background:	Sets the background color for character display.
Icon:	Selects the icon to operate alarm/event summaries.
Vertical Scroll Bar:	Sets the bar size and scroll width for the vertical scroll bar.
Horizontal Scroll Bar:	Sets the scroll width for the horizontal scroll bar.
Frame:	Sets the object frame display.
Flicker:	Sets the flicker display. (See note.)
Password:	Sets the password to be entered when the object is pressed. (See note.)
Control Flag:	Sets enable/disable input and display/no display for objects. (See note.)
Macro:	Sets the macros for alarm/event summary and history objects. (See note.)
Size/Position:	Sets the object size and position. (See note.)

Note: These tabs are displayed when *Display Extension Tabs* Option is selected.

**NS Series Programming Manual**

**General Tab Page**

Sets the alarm/event summary/history display format and display order.

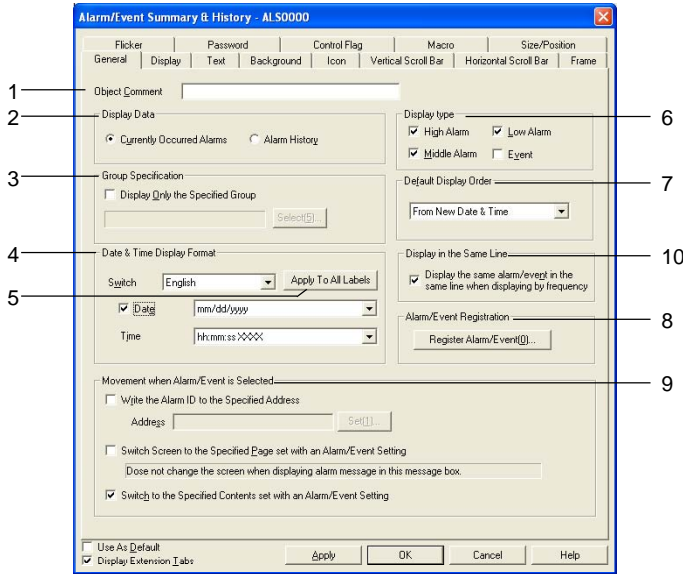

No.	Setting	Details
1	Object Comment	Sets an explanatory comment for the pasted object. (Up to 32 characters.)
2	Display data	Select one of the following 2 display data types. Current Occurred alarms (Displays the current alarm). Alarm history (Displays all alarms, including past alarms.)
3	Group Specification	The display can be set to include only information from groups specified when alarms/events are registered. Click the <b>Select</b> Button to display Select Alarm/Event Group Dialog Box.
4	Date and Time display Format	Displays the date and time of the alarm or event. Select the date and time display format from the list.
		Switch Sets the date and time display format for each label.
		Date Selects the date display format from the list.
Time Selects the time display format from the list.		
5	Apply to All Labels	Uses the date display method for the selected label for all labels. This setting is applied only to labels for which a date display is selected. <i>Apply to All Labels</i> cannot be set in the following cases. <ul style="list-style-type: none"> <li>When the <i>Date &amp; Time Display Format</i> Check Box is selected on the Edit/Display Tab Page of the Option Dialog Box accessed by selecting <b>Tools - Option</b>.</li> <li>When there is only one label.</li> </ul>
6	Display type	Select the alarm/event type to be displayed from the following 4 options. High alarm Middle alarm Low alarm Event
7	Default display order	The default display order for alarm/event summary/history display can be selected from the following 6 options. From New Date & Time From Old Date & Time From High priority From Low priority From High Frequency From Low Frequency
8	Alarm/event registration	Click the <b>Register Alarm/Event</b> Button to display the Alarm/Event Setting Dialog Box and register or edit alarms.

**NS Series Programming Manual**

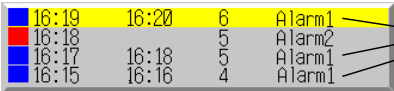
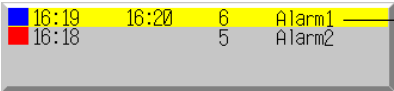
No.	Setting	Details
9	Movement when Alarm/Event is Selected	<p>Select the operation when alarms/events are selected from the following three options.</p> <p>Write the alarm ID to the specified address.</p> <p>Writes the alarm ID number for the selected alarm/event to the specified address.</p> <p>Switch Screen to the Specified Page set with an Alarm/Event Setting.</p> <p>Switches the display to the <b>Switch Screen No.</b> set to the alarm event.</p> <p>Switch to the Specified Contents set with an Alarm/Event Setting.</p> <p>Switches the contents display to the contents for the contents number set to the alarm/event.</p>
10	Display in the same line	<p>Sets whether to display the same alarm/event by date/time of occurrence or only the display the latest alarm/event time, when the display order is set to <i>From High Frequency/From Low Frequency</i> is selected and the display data is set to <i>Alarm History</i>.</p> <p>If this checkbox is deselected, the same alarm/event will be displayed by date and time.</p> <p>Example</p>  <p>The same alarm/event is displayed by date of occurrence.</p> <p>If this checkbox is selected, only the most recent occurrence of each alarm/event will be displayed.</p> <p>Example</p>  <p>Only the most recent occurrence of each alarm/event is displayed.</p>

**Note**

- ◆ If nothing is selected under *Display type*, there will be no alarm/event to display and nothing will be displayed during PT operation.
- ◆ If the alarms/events during PT operation have the same level set under *Default display order*, they will be displayed in the order they occurred.
- ◆ Alarm ID refers to the number set under *PT - alarm/event setting - No.* To set the data type (BCD or binary) for the specified address, select **PT – Project Properties** and set the data type on the Data Format Tab Page.
- ◆ Sometimes not all information can be displayed on the screen, depending on the set number of message characters or display items.

NS Series Programming Manual

### Display Tab Page

Sets the selection bar color that will be reversed and the display items when alarm/event summaries or histories are selected.

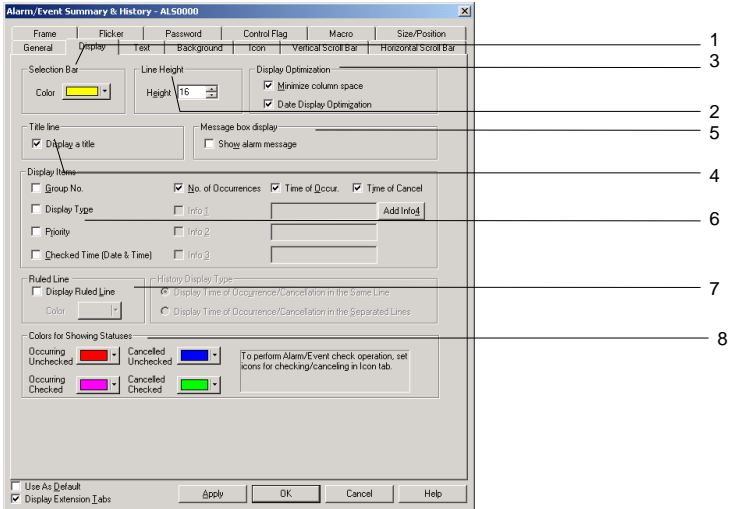

No.	Setting	Details
1	Selection bar	Sets the color to one of the 256 colors available in the selection bar.
2	Line height	Sets the height of the lines in dot units. (8 to 64 dots)
3	Display optimization	If the <i>Minimize column space</i> Option is selected, the space between items on the display will be minimized. If the <i>Date Display Optimization</i> Option is selected, the date will be displayed for the leftmost item only and omitted for the other items.
4	Title line	If the <i>Display a title</i> option is selected, the title of each item will be displayed at the top.
5	Message box display	If the <i>Show alarm message</i> option is selected, the entire alarm message will be displayed in a message box when the alarm message area is clicked.
6	Display items	Select one of the following eight types of display items. (Multiple items can be selected.) <ul style="list-style-type: none"> <li>• Group number, Display type</li> <li>• Priority, Checked Time (date and time)</li> <li>• No. of Occurrences</li> <li>• Time: Date of occurrence</li> <li>• Time: Date of recovery</li> <li>• Info 1</li> <li>• Info 2</li> <li>• Info 3</li> </ul> (The Info is set in the Alarm/Event Registration Dialog Box. The Info options will not be displayed if additional information has not been set.)
7	Ruled line	Select <i>Display Ruled lines</i> to display ruled lines and use the <b>Set</b> Button to set the color for the lines.
8	Colors for Showing Status	Sets the color that indicates the status of the displayed alarm/event. The following four types of status are used. These cannot be set when <i>Use Text Color/Font of Alarm/Event Setting</i> is selected on the Text Attributes Tab Page. <ul style="list-style-type: none"> <li>• Occurring Unchecked</li> <li>• Occurring Checked</li> <li>• Canceled Unchecked</li> <li>• Canceled Checked</li> </ul>

### Text Tab Page

Sets the text attributes, such as font and color, for the display string.

When *Use Text Color/Font of Alarm/Event Setting* is selected, the display will be in the color and font set under *PT - alarm/event setting*. Refer to *Text Attribute* in 2-8 *Common Functional Object Functions* and *Outline* in 2-13 *Alarms and Events*.

### Background Tab Page

Sets the background color for alarm/event summary or history display from 256 color options. Refer to *Background* and *Setting Color* under 2-8 *Common Functional Object Functions* for details.

### Icon Tab Page

Selects the icon to operate alarm/event summaries and histories.

**NS Series Programming Manual**

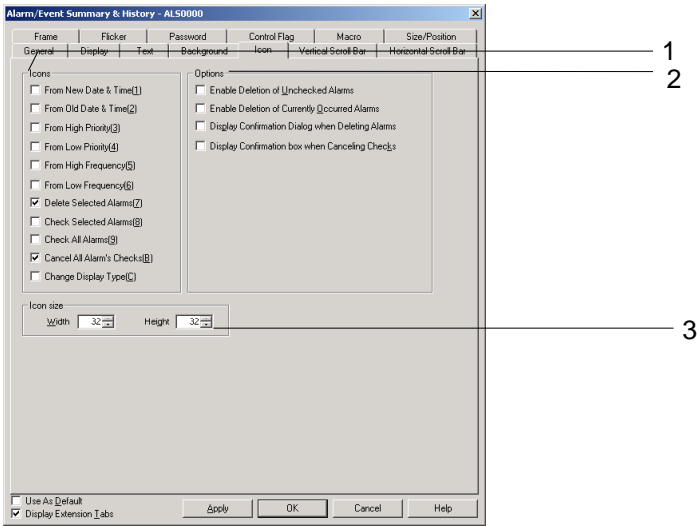

No.	Setting	Details
1	Icon	Icon buttons that perform specific operations can be set to be displayed at the bottom of the alarm/event summary/history object. The following icon buttons can be displayed.
	From New Date & Time	Sorts the display from latest to oldest. If multiple alarms/events have the same date, the display will be in the order those alarms/events were generated.
	From Old Date & Time	Sorts the display from oldest to latest. If multiple alarms/events have the same date, the display will be in the order those alarms/events were generated.
	From High priority	Sorts the display from highest to lowest priority. If multiple alarms/events have the same priority, the display will be in the order those alarms/events were generated.
	From Low priority	Sorts the display from lowest to highest priority. If multiple alarms/events have the same priority, the display will be in the order those alarms/events were generated.
	From High frequency	Sorts the display from highest to lowest frequency. If multiple alarms/events have the same frequency, the display will be in the order those alarms/events were generated.
	From Low frequency	Sorts the display from lowest to highest frequency. If multiple alarms/events have the same frequency, the display will be in the order those alarms/events were generated.
	Delete selected alarms	Deletes the selected alarms/events from the list. Select <i>Display confirmation dialog box when Deleting Alarm</i> under the options to display a confirmation message before deleting alarms/events. Click the <b>Yes</b> Button in the dialog box to clear the alarms/events.
	Check selected alarm	A mark (*) will appear beside the selected alarms/events when this option is selected.
	Check all alarms	A mark (*) will appear beside all alarms/events when this option is selected.
	Cancel All Alarms' Check	Clears all marks (*) from beside alarms/events.
	Change Display Type	The following four types of menus can be selected for display when icons are pressed. An asterisk (*) will appear in the menu for the current alarm/event. A question mark (?) will appear when in test mode. <ul style="list-style-type: none"> <li>• High alarm</li> <li>• Middle alarm</li> <li>• Low alarm</li> <li>• Event</li> </ul>

No.	Setting	Details
2	Options	Select one of the following four operation options. <ul style="list-style-type: none"> <li>• Enable Deletion of Unchecked Alarms.</li> <li>• Enable Deletion of Currently Occurred Alarms.</li> <li>• Display confirmation dialog box when Deleting Alarms.</li> <li>• Display confirmation dialog box when Canceling Checks.</li> </ul>
3	Icon size	Sets the horizontal and vertical dimensions of the icon (16 to 64).

### Vertical Scroll Bar Tab Page

Sets display/no display, scroll width, and button size for the list vertical scroll bar displayed to the right of the alarm/event summary/history object.

Refer to *Scroll Bars* under *2-8 Common Functional Object Functions* for details.

### Horizontal Scroll Bar Tab Page

Sets display/no display, scroll width, and button size for the list horizontal scroll bar displayed to the right of the alarm/event summary/history object.

Refer to *Scroll Bars* in *2-8 Common Functional Object Functions* for details.

### Frame Tab Page

Specifies the colors and sizes of the object frame to change the shape or color when the button is depressed or raised. Refer to *Frames* under *2-8 Common Functional Object Functions* for details.

### Flicker Tab Page (Extension Tab)

Makes flicker settings to make the object flicker (flash). Refer to *Flicker* under *2-8 Common Functional Object Functions* for details.

### Password Tab Page (Extension Tab)

A password can be set for when the alarm object area is pressed. Five passwords of up to 16 characters each can be set. One password can be requested for each object. Refer to *Passwords* under *2-8 Common Functional Object Functions* for details.

### Control Flag Tab Page (Extension Tab)

Control flags control the input and display of functional objects. Use control flags to enable display or input when the contents of an address turn ON or OFF. Refer to *Control Flags* under *2-8 Common Functional Object Functions* for details.

### Macro Tab Page (Extension Tab)

Macros can be specified for alarm/event summary/history objects.

Refer to *NS-series Macro Reference* in the CX-Designer for information on setting macros.

### Size/Position Tab Page (Extension Tab)

Displays and sets the functional object size and position. Refer to *Size/Position* under *2-8 Common Functional Object Functions* for details.

## 2-14-4 Searching for Alarms and Events Using the Ladder Monitor

With the NS15, NS12, NS10, or NS8, alarms and events selected in alarm/event summary and history can be searched for. The Ladder Monitor automatically searches for program sections used for the outputs of alarms and events.

**NS Series Programming Manual**

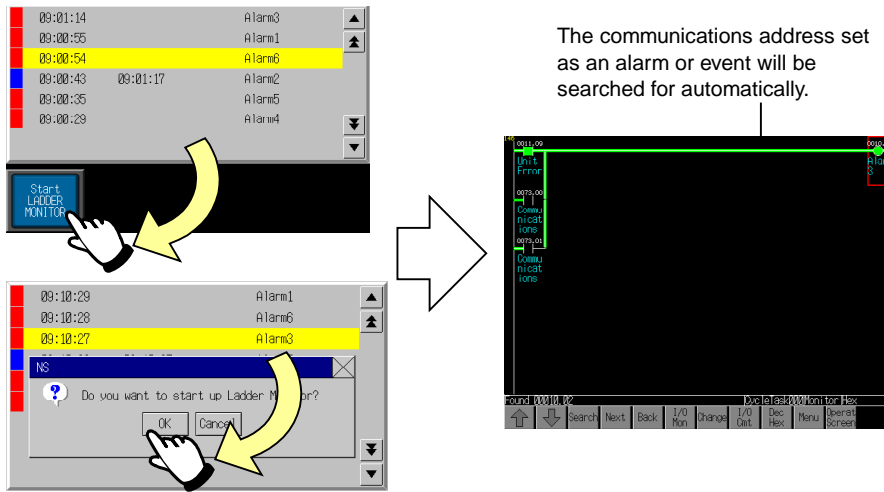

Select the alarm or event from the alarm/event summary or history and start the Ladder Monitor.

Use one of the following ways to start the Ladder Monitor.

1. Click a multifunction button set to start the Ladder Monitor.
2. Start the Ladder Monitor from the alarm/event summary or history.

**Note**

- ◆ This function can be used if the NS system is version 8.0 or higher and the Ladder Monitor is version 3.0 or higher.
- ◆ With the Ladder Monitor, you can search backwards to find the causes of alarms or events that have occurred. For information on the Ladder Monitor, refer to the *NS-series Ladder Monitor Operation Manual* (Cat. No. V082).

**Using a Multifunction Button to Start the Ladder Monitor**

**Setting Procedure**

Create a Multifunction Object as a Start LADDER MONITOR Button in the screen where the alarm/event summary and history are found.

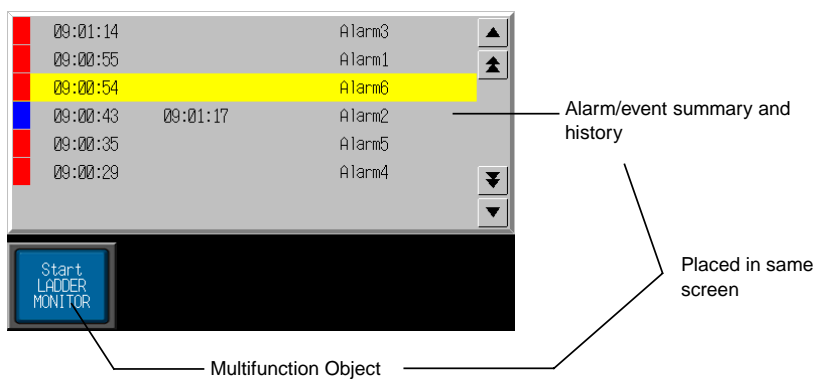

1. Place a Multifunction Object on the same screen where the alarm/event summary and history is found.
2. Set **Switch Screen – Display System Menu – Ladder Monitor** as the operation for the Multifunction Object. (For information on Multifunction Objects, refer to 2-11 Multifunction Objects.)



### Operation on the NS-series PT

1. Select an alarm or event from the alarm/event summary and history when an alarm or history is generated.
2. Click the Multifunction Button with that alarm or event selected.
3. The Ladder Monitor will start and automatically search for the program section with the output for the communications address of the selected alarm or event. The Ladder Monitor starts searching from the first line and displays the first program section found.

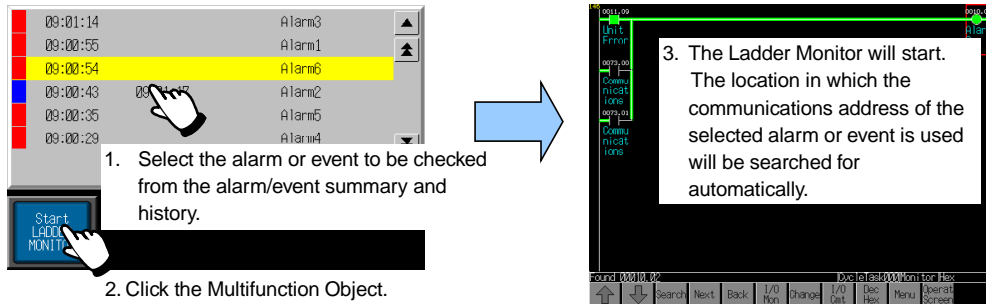

#### Note

- ◆ A search will not be performed automatically when the Ladder Monitor starts if the alarm/event summary and history and the Multifunction Object are not found on the same screen.
- ◆ The Ladder Monitor can also be started by storing 4036 (BCD) or FC4 (binary) in \$SW0.
- ◆ If switching to a specified page is set the registering an alarm or event in the Alarm/Event Summary and History, the screen will be switched when the alarm or event is selected. The Alarm/Event Control function can be used for the Multifunction Object to prevent the screen from switching and move the selection bar.

### Starting the Ladder Monitor from an Alarm/Event Summary and History

If an alarm or event is selected in the alarm/event summary or history, a message will be displayed to confirm whether to start the Ladder Monitor.

#### Setting Procedure

Settings for starting the Ladder Monitor from the alarm/event summary or history are made in the System Menu of the NS-series PT.

1. Simultaneously press two of the four corners of the NS screen to display the System Menu. (For the NS15, press any corner twice.)
2. Display page 3 of the **PT** Tab Page.
3. Set the *Startup Ladder Monitor from Alarm/Event Summary & History* Field to **ON**.
4. Press the **Write** Button.

**NS Series Programming Manual**

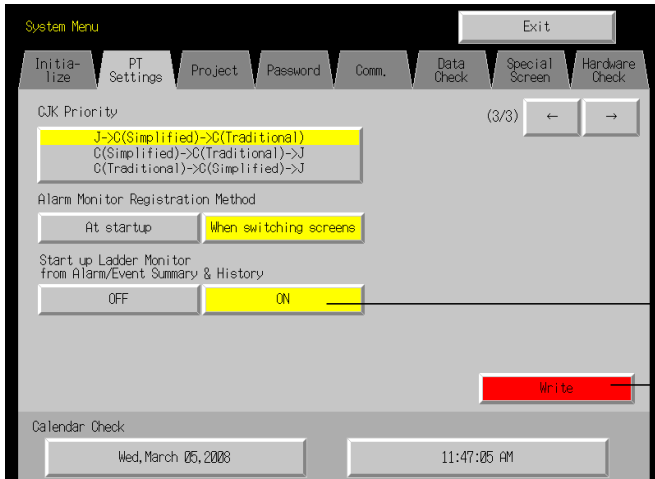

Select ON.

Click the **Write** Button.

5. Click the **EXIT** Button to close the System Menu.

**Operation on the NS-series PT**

1. Select an alarm or event from the alarm/event and history when an alarm or event is generated.

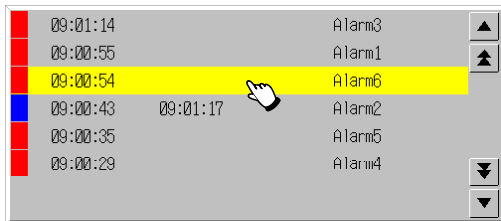

2. The following confirmation message will be displayed. The message depends on the settings in the alarm/event summary and history.

- The following dialog box will be displayed if switching to a specified page was set when registering the alarm/event.

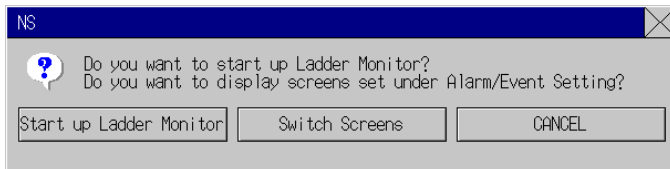

- The following dialog box will be displayed if switching to a specified page was not set when registering the alarm/event.

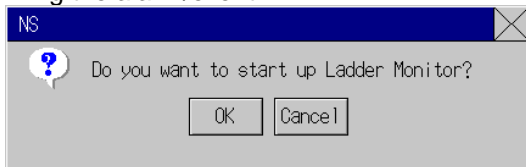

Click either the **Start up Ladder Monitor** Button or **OK** Button in the relevant message dialog box.

3. The Ladder Monitor will start and automatically search for the program section used to output the communications address of the selected alarm or event. The Ladder Monitor starts searching from the first line and displays the first program section found.

NS Series Programming Manual

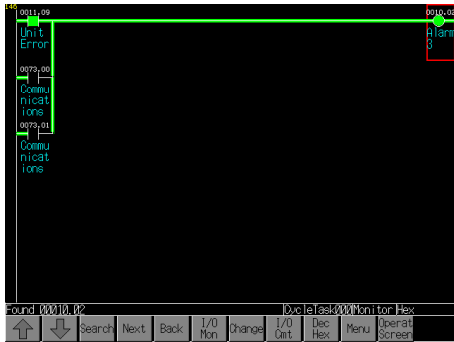

3. The Ladder Monitor will start. The location in which the communications address of the selected alarm or event is used will be searched for automatically.

**Note**

- ◆ The display will switch to the display set to the alarm or event if the Switch Screen Button is clicked with the message displayed while alarm/event is selected.

## 2-15 Data Logs

### 2-15-1 Outline

The data log function saves changes over time in the contents of the allocated address. The saved data can be displayed as a data log graph object for each set data logging group. In Version 6 and later versions, the following two applications can be executed by using data log objects. Refer to 2-15-3 *Example Setting Procedure* for information on how to make settings for each application.

- Saving log data automatically and periodically to a Memory Card and continuing logging.
- Overlapping a data log graph (standard data) in the Memory Card with the graph being logged.

Data log group

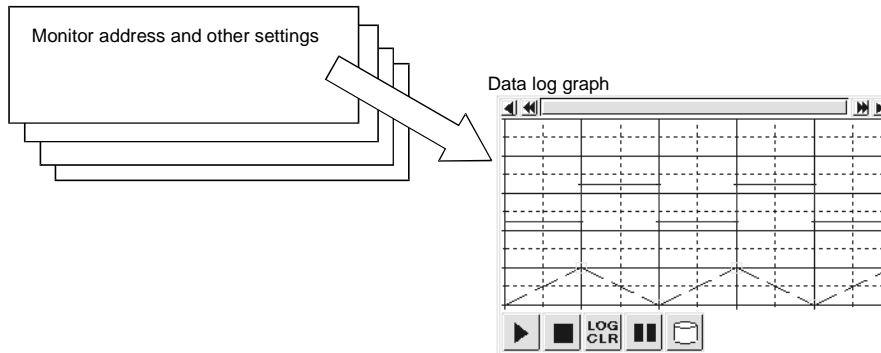

### Registering Data Logging Groups

Data logging groups must be registered before data logs can be displayed as graphs. Select **PT - Data Log Settings**.

The screenshot shows the 'Data Log Setting' dialog box. It features a table with columns for 'No.', 'Group Name', 'Log Timing', 'Entries', 'Log Points', and 'Log Period'. Below the table are several buttons: 'Edit', 'Add', 'Delete', and 'Icon'. At the bottom, there are fields for 'Logging Points Total', 'Always Log Address Total', and 'Always Logging Points', along with an 'Advanced Setting' button. Numbered callouts (1-6) point to these various elements. Callout 1 points to the 'Edit' button, 2 to 'Add', 3 to 'Delete', 4 to 'Icon', 5 to the table area, and 6 to the 'Advanced Setting' button. A separate callout line points to the table area with the text: 'Data log groups from 1 to 100 can be registered.'

The Data Log Setting Dialog Box will be displayed. New data logging groups are created and settings are edited, deleted, and confirmed in this dialog box.

No.	Setting	Details
1	Edit	To change a set data logging group, select the display line for the group to be changed and press the <b>Edit</b> Button to display the Data Log Group Setting Dialog Box. Refer to <i>Data Log Group Setting</i> for information on how to change data logging groups.
2	Add	To add data logging groups, click the <b>Add</b> Button to display the Data Log Group Setting Dialog Box. Refer to <i>Data Log Group Setting</i> for information on how to add data logging groups. Up to 100 groups can be registered for each project. The <b>Add</b> Button will be disabled when 100 groups have been registered.

**NS Series Programming Manual**

No.	Setting	Details
3	Delete	To delete a set data logging group, select the display line for that group and click the <b>Delete</b> Button. A confirmation message will be displayed. Click the <b>Yes</b> Button to delete the selected group.
4	Icon	Click the <b>Icon</b> Button to display the Details Dialog Box. BMP/JPEG files can be specified to the icon for the data log object.
5	Logging Points Total	The total number of logging points is displayed. Logging is possible for up to 160,000 points. (NS5: 120,000 points). Refer to <i>Calculating Logging Points</i> on page 2-334 for details.
	“Always” Log Address Total	Displays the total number of addresses that are always logged. Up to 128 addresses can be constantly logged.
	Always Logging Points	The number of points for constant logging is displayed. Constant logging is possible for up to 50,000 points. Refer to <i>Calculating Logging Points</i> on page 2-334 for details.
6	Advanced Setting	Click the <b>Advanced Setting</b> Button to set display settings for data log graphs. For details, refer to <i>Display Settings for Data Log Graphs</i> .

**Note**

- ◆ The available number of “Always logging points” differs depending on the sampling cycle for the data log group and the log address storage type.
- ◆ The following option must be set in advance before using the “always logging” function.
  1. Select **PT – System Setting** and open the History Tab Page.
  2. Select the *Hold data of always logging (Data Log)* Option and click the **OK** Button.

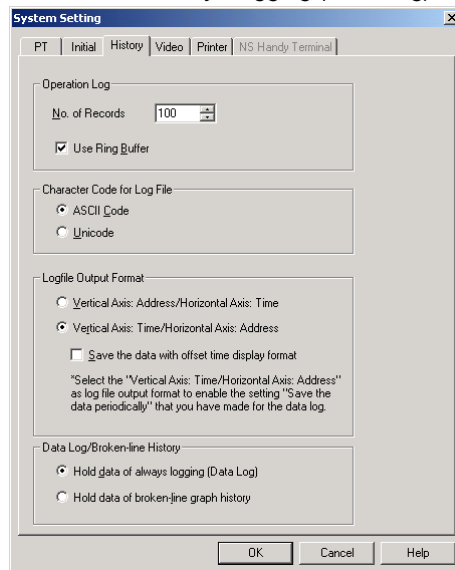

- ◆ When the “always logging” function is being used, the “broken-line graph history” function cannot be used.

**NS Series Programming Manual**

**Data Log Group Settings**

Sets data logging groups. New groups can be added and registered groups can be edited.

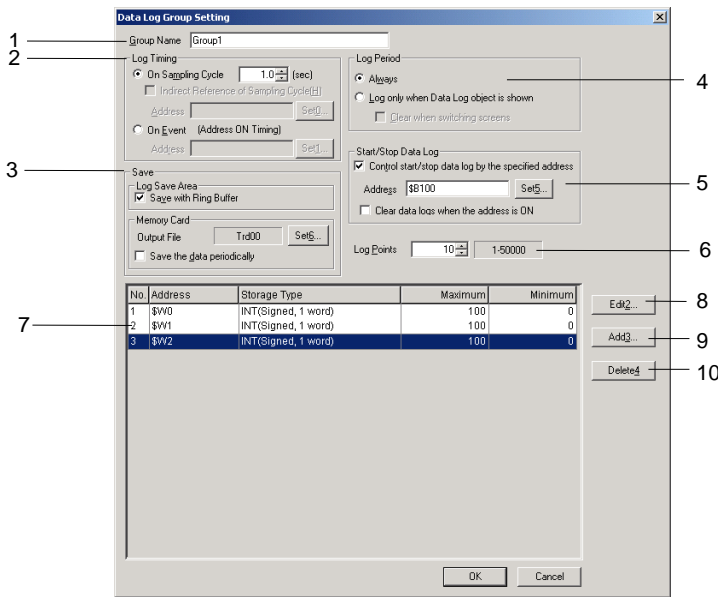

Settings that will affect the whole group, such as group names, are made under group setting. New settings can be made and settings can be edited and confirmed for lines displayed on data log graphs. Up to 100 groups can be registered for each project.

No.	Setting	Details
1	Group Name	Sets the group name. For new groups, the input field will be Group @. Enter the group name (up to 32 characters).
2	Log Timing	Specifies the timing for obtaining data from the following 2 options.
	On Sampling Cycle	Obtains data each specified sampling cycle. The shortest possible sampling cycle is 0.5 s. The setting range is 0.5, or 1 to 86,400 (seconds).
	Indirect reference of sampling cycle	If data logging is performed only when a Data Log object is displayed, the sampling cycle can be indirectly specified by selecting this option.
	On Event	Obtains data each time a specified address status changes from OFF to ON.
3	Data Log Save	Sets the following two log save methods.
	Save with Ring Buffer	Select to continue logging after the number of logging points has been reached. If this option is selected, the oldest logging data is overwritten with the most recent data when the total number of logging points has been reached.
	Output File	Sets the file name for logging data output as a file to the Memory Card/Log/ directory after creating a folder for each group. The file name can be up to 36 characters. Alphanumeric characters (0 to 9, A to Z, and a to z), the dollar sign (\$), and underscores (_) can be used in the file name. File name: File name□□□.csv □□□: ID number from 001 to 999 The ID number for files saved for each group is added after the file name. Beginning with 001, the number is automatically incremented by 1 each time the operation is executed.
	Save the data periodically	Select this option for automatic, periodical saving of the data log. When choosing this option, set <i>Logfile Output Format</i> on the <b>Settings - System settings – History Tab Page</b> to Vertical Axis: Time/Horizontal Axis: Address. Also, when outputting log data to a CSV file, select the <i>Save the data with offset time display format</i> option for offset time display.
4	Log Period	Selects and sets one of the following two log periods.
	Always	Select this option for always logging.
	Log only when Data Log object is shown	Select this option to perform logging only while the data log graph is displayed. Select <i>Clear data logs when the address is ON</i> to clear the saved information when the screen is switched.

No.	Setting	Details
5	Start/Stop Data Log	Set to log while a specified address is ON.
	Control start/stop data log by the specified address	Select this option to log while a specified address is ON. Select the <i>Clear data logs when the address is ON</i> option to clear the data logged at the last start/stop data log.
6	Log Points	Sets the number of log bits or words (1 to 50,000).
7	Data log address list	Displays a list of addresses set for the group that obtain the data logs.
8	Edit	To change the registered data log address settings, select the display line for the setting to be changed and press the <b>Edit</b> Button to display the Data Log Address Setting Dialog Box. Refer to <i>Data Log Address Setting</i> for information on how to change data log settings.
9	Add	To add data log addresses, click the <b>Add</b> Button to display the Data Log Address Setting Dialog Box. Refer to <i>Data Log Address Setting</i> for information on how to add data log settings. Up to 16 lines can be set for each group. The <b>Add</b> Button will be disabled when 16 lines have been registered.
10	Delete	To delete a registered data log address setting, select the display line for that setting and click the <b>Delete</b> Button. A confirmation message will be displayed. Click the <b>Yes</b> Button to delete the selected setting.

**Note**

- The file size of the CSV files output for each data log group can be calculated using the following formula as a guideline. This varies depending on the log timing, the number of digits in the value stored in the log address, the number of log addresses, and the number of logs.

$$\text{CSV file size (bytes)} = (A + B * C) * D$$

A: Timing data size

		Size (bytes)
Log timing	Sampling cycle: 1 to 86,400s, or each event	22
	Sampling cycle: 0.5 s	26

B: Number of digits in value stored in log address +1 (for a value of 1,000 to 9,999: 4 + 1 = 5)

C: Number of log addresses

D: Number of logs

Example 1

Log timing: Sampling cycle 1 s	A=22
Digits of value stored in log address: 5	B=5+1=6
Number of log addresses: 5	C=5
Number of logs: 10,000	D=10,000

The CSV file size for the above data log group is calculated as follows.

$$\text{CSV file size} = (22 + 6 * 5) * 10,000 = 520,000 \text{ (bytes)} \approx 508 \text{ (KB)}$$

Example 2

Log timing: Sampling cycle 0.5 s	A=26
Digits of value stored in log address: 10	B=10+1=11
Number of log addresses: 2	C=2
Number of logs: 15,000	D=15,000

The CSV file size for the above data log group is calculated as follows.

$$\text{CSV file size} = (26 + 11 * 2) * 15,000 = 720,000 \text{ (bytes)} \approx 704 \text{ (KB)}$$

- Memory Cards can be rewritten up to 100,000 times. If you were to repeatedly rewrite the Card in 10-minute intervals, 100,000 rewriting cycles would be completed within 2 years.

**NS Series Programming Manual**

**Data Log Address Settings**

Sets the address for the data to be saved and the graph line information to be displayed on the data log graph.

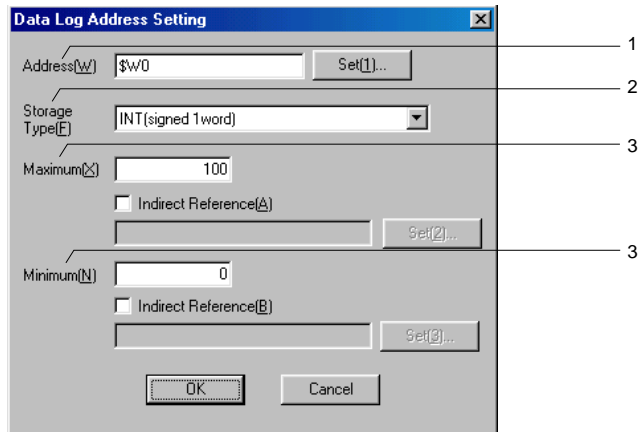

The settings for each line shown in the data log graph are made under the data log address setting. Up to 16 items of data can be set for each group.

No.	Setting	Details
1	Address	Sets the address where the data is stored.
2	Storage type	Select the storage type for numerals from the list. Refer to <i>Numeral Display and Storage Type</i> under 2-8 Common Functional Object Functions for details.
3	Maximum/minimum	Sets the maximum and minimum values for graph display.
	Maximum	The maximum that can be set depends on the storage type for each line.
	Minimum	The minimum that can be set depends on the storage type for each line.
	Indirect Reference	If <i>Indirect reference</i> is set, the maximum and minimum values can be specified by the contents of an address.

**Specifying Icons**

Bitmap files can be specified for data log object icons. The setting method is described below.

1. Select **PT – Data log** to display the Data Log Setting Dialog Box.
2. Click the **Icon** Button to display the Details Dialog Box.

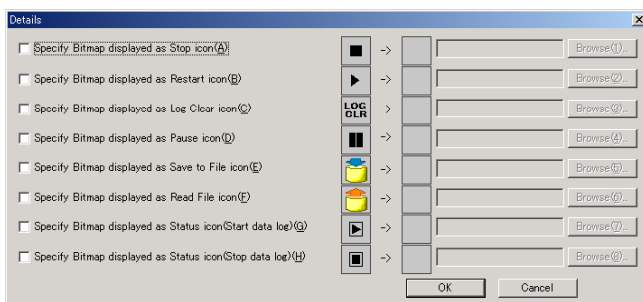

3. Select the icon for the specified Bitmap and click the **Browse** Button. The Select File Dialog Box will be displayed. Specify the file to be displayed as an icon.

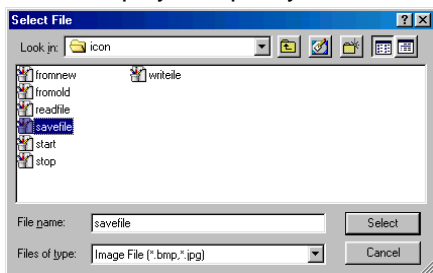



4. Click the **Select** Button to close the dialog box. The selected bitmap file image will be displayed to the right of the existing icons in the Details Dialog Box.  
Click the **OK** Button to close the Details Dialog Box.  
Click the **OK** Button to close the Data Log Setting Dialog Box.
5. Set the icon to be displayed on the Icon Tab Page of the data log object Property Dialog Box.
6. Click the **OK** Button to close the Property Dialog Box. The icon for which a Bitmap was specified will be displayed on the data log object.

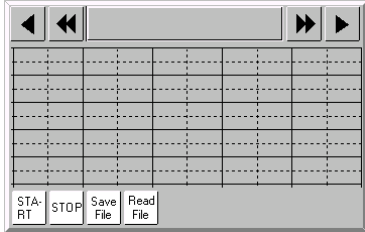

**Note**

- ◆ When the number of colors in the designated image file is a True Color number, it is automatically reduced to 32,000.
- ◆ Specify a file name of up to 12 characters (8 file name characters and 3 file extension characters). The following characters can be used in file names: alphanumeric characters, underscore (\_), dollar signs (\$), and periods (.).

**Display Settings for Data Log Graphs**

The display method for data long graphs can be changed. Press the **Advanced Setting** Button on the Data Log Setting Dialog Box to display the Advanced Setting Dialog Box.

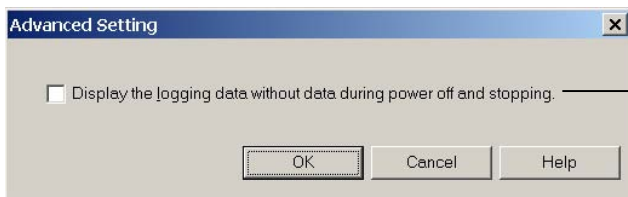

No.	Setting	Description
1	Display the logging data without data during power off and stopping	If this option is selected, no blanks will occur in the data log graph during the following periods: <ul style="list-style-type: none"> <li>• While data logging is stopped</li> <li>• While the power to the PT is turned OFF</li> <li>• While the System Menu is displayed</li> </ul>

**Note**

- ◆ This setting is supported for project data version 8.1 or higher.

**Displaying Logged Data without Data When Power Is OFF or Logging is Stop**

If the *Display the logging data without data during power off and stopping* Option is selected, no blanks will be left in the graph when power is turned OFF or logging is stopped. If this option is not selected or if the project data version is lower than 8.1, the graph line will not be displayed in a data log graph whenever logging was not performed.

**NS Series Programming Manual**

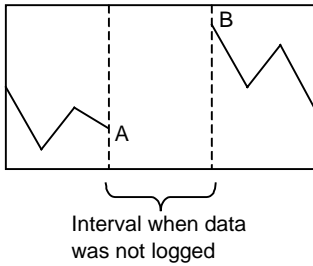

If the *Display the logging data without data during power off and stopping* Option is selected, there will be no blanks in the graph from when data was not logged, i.e., the graph line will be continuous.

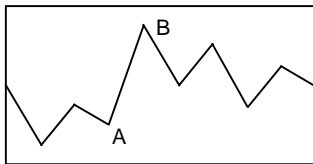

The graph is displayed with no blanks from when data was not logged.

If the *Display the logging data without data during power off and stopping* Option is selected, the display settings will be changed or restricted as described in the following table.

Setting	Description
Time display position	The time will be displayed where logged data is displayed.
Data log graph settings that are disabled	The following settings cannot be made. <ul style="list-style-type: none"> <li>• The sampling cycle cannot be set to 0.5 s.</li> <li>• The sampling cycle cannot be set to <i>Indirect reference of sampling cycle</i></li> <li>• The log timing cannot be set to <i>On event</i>.</li> </ul>
Data log graph property settings that cannot be set	The following setting cannot be made on the Time Axis Tab Page of the Property Setting Dialog Box for the data log graph. <ul style="list-style-type: none"> <li>• The scale cannot be set to <i>Indirect Reference</i>.</li> <li>• The graph display position cannot be set to <i>Position end of scrolling at the center of data log graph</i>.</li> <li>• The graph display position cannot be set to <i>Setting Address for Updating Display</i>.</li> </ul>

Note: If the *Display the logging data without data during power off and stopping* Option is selected for a data log graph for which any of the above settings has already been made, the settings will automatically be canceled. The scale of the data log graph will be set to *Time*.

### Calculating Logging Points

This section describes how the number of logging points displayed in the **Data Log Setting** Dialog Box are calculated.

The screenshot shows the 'Data Log Setting' dialog box. It contains a table with the following data:

No.	Group Name	Log Timing	Entries	Log Points	Log Period
1	Group1	1.0sec	2	10	Always
2	Group2	1.0sec	4	1000	Always
3	Group3	1.0sec	3	100	Log only when Data Log object is shown
4	Group4	\$B100	4	10	Always

Below the table, there are summary statistics:

- Logging Points Total = 4360 [available#] 155640
- Always Log Address Total = 10 [available#] 40
- Always Logging Points = 4060 [available#] 34455 sampling cycle: 0.5sec. storage format: 1 word
- [available#] 27564 sampling cycle: 0.5sec. storage format: 2words
- [available#] 45940 sampling cycle: more than 1 sec./event. storage format: 1 word
- [available#] 34455 sampling cycle: more than 1 sec./event. storage format: 2 words

At the bottom right, there are three buttons: 'Advanced Setting', 'OK', and 'Cancel'.

**NS Series Programming Manual**

**Always Logging Points**

The number of "Always logging points" is the sum of the products of the number of points registered and the number of logging points for each group for which the log period is set to "always."

$$(Number\ registered \times Number\ of\ log\ points) + (Number\ registered \times Number\ of\ log\ points) + \dots + (Number\ registered \times Number\ of\ log\ points)$$

For the above example, calculations would be as follows:

$$\{2 \times 10(\text{Group 1})\} + \{4 \times 1000(\text{Group 2})\} + \{4 \times 10(\text{Group 4})\} = 4060$$

The available number of "Always logging points" differs depending on the sampling cycle for the data log group and the log address storage type.

Example: The following table shows the maximum number of "Always logging points" that can be registered for one group with one log address.

		Log address storage type	
		1 word	2 words (including REAL)
Log timing	Sampling cycle 1 to 86,400 s or on event	50,000	37,500
	Sampling cycle 0.5 s	37,500	30,000

When registering multiple log addresses, the maximum number of "Always logging points" will be the number shown on the table divided by the number of log addresses.

Maximum number of "Always logging points" for one group and 10 log addresses:

		Log address storage type	
		1 word	2 words (including REAL)
Log timing	Sampling cycle 1 to 86,400 s or on event	5,000	3,750
	Sampling cycle 0.5 s	3,750	3,000

**Logging Points Total**

The "Always' Log Address Total" is the sum of the products of the number of points registered and the number of logging points for each group.

$$(Number\ registered \times Number\ of\ log\ points) + (Number\ registered \times Number\ of\ log\ points) + \dots + (Number\ registered \times Number\ of\ log\ points)$$

For the above example, calculations would be as follows:

$$(2 \times 10) + (4 \times 1000) + (3 \times 100) + (4 \times 10) = 4360$$

## 2-15-2 Data Log Graphs

Data log graphs are objects that display in graph format the registered data contained at registered data group addresses.

The general position of the current graph in relation to the overall data can be checked using the scroll bar to the top of the graph.

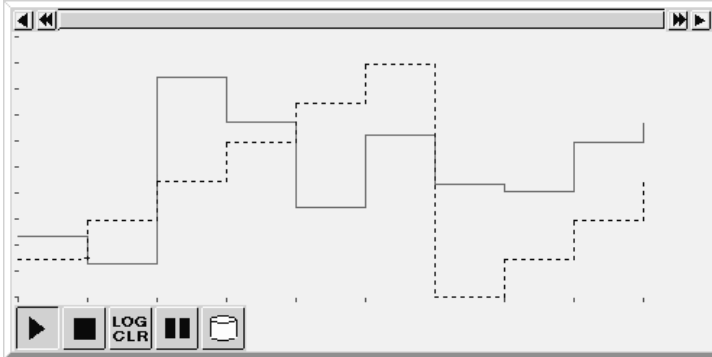

### Settings for Functional Object Properties

This section describes the settings in the Functional Object Properties Dialog Box for data log graphs.

**Data Log Graph - DLOG0000**

General | Time Axis | Numeral Value Axis | Background | Icon | Scroll Bar | Frame | Flicker | Control Flag | Size/Position

Object Comment: \_\_\_\_\_

Group Name:

Log Timing:

Direction:   Draw Value Outside of the Range

Display	No.	Address	Upper Limit	Lower Limit	Color	Line Style	Marker	Marker Color	Display Offset	Step Display
<input checked="" type="checkbox"/>	1	\$W0	100	0		Solid Line	None	-	0	ON
<input checked="" type="checkbox"/>	2	\$W1	100	0		Solid Line	None	-	0	ON
<input checked="" type="checkbox"/>	3	\$W2	100	0		Solid Line	None	-	0	ON
<input checked="" type="checkbox"/>	4	\$W4	100	0		Solid Line	None	-	0	ON

Set color and line style for settings (address, storage type) registered in each Group Setting dialog. Settings link with the number of Data Log Setting, so that they do not link with the address.

Use As Default  
 Display Extension Tabs

- General:** Sets the data log group and line parameters to be displayed.
- Time Axis:** Makes settings related to the data log graph's time axis.
- Numeral Value Axis:** Makes settings related to the data log graph's numeral value axis.
- Background:** Sets the base color for data log graphs.
- Icon:** Selects the displayed icon used to manipulate data log graphs.
- Scroll bar:** Sets the scroll bar size and scroll width.
- Frame:** Sets the frame display for data log graphs.
- Flicker:** Sets the flicker display. (See note.)
- Control flag:** Sets display/no display and input enabled/disabled for data log graphs. (See note.)
- Size/position:** Sets the object size and position. (See note.)

Note: These tabs are displayed when *Display Extension Tabs* Option is selected.

**NS Series Programming Manual**

**General Tab Page**

Sets the data log group and address to be displayed.

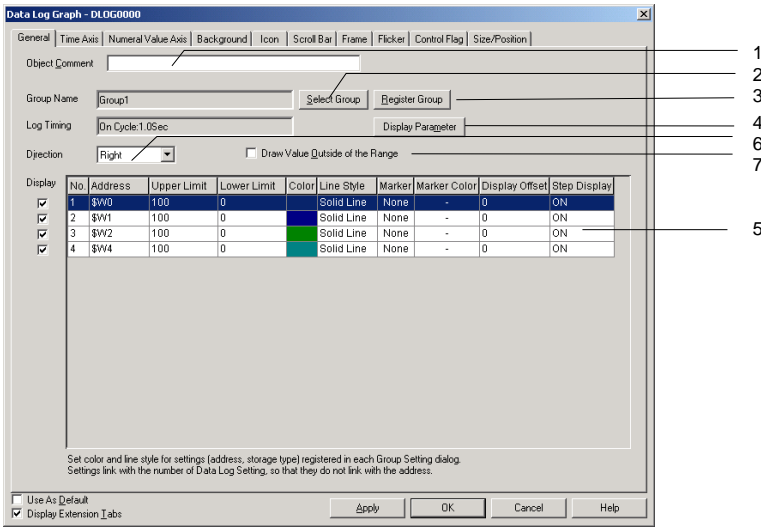

No.	Setting	Details
1	Object Comment	Sets an explanatory comment for the pasted object (up to 32 characters).
2	Select Group	Click the <b>Select Group</b> Button to display the Select Group Dialog Box. Selects the group for group display.
3	Register Group	Click the <b>Register Group</b> Button to display the Data Log Setting Dialog Box. Use this button to add, edit, or delete data log groups.
4	Display parameter	Select the data log address from the list of addresses and click the <b>Display Parameter</b> Button to display the Display Parameter Setting Dialog Box. Sets the line type and markers.
5	Data log address list	Displays the registered addresses for the selected data log groups. Deselect addresses that are not to be displayed on the graph. Remove the tick to the left of the address to deselect it.
6	Direction	<p>Select one of the following four display directions.</p> <p>From Up, Down, Right, or Left</p> <p>The time and numeric value axes will depend on the display direction, as shown in the following diagram.</p> <div style="display: flex; justify-content: space-around;"> <div style="text-align: center;"> <p>Up or Down</p> </div> <div style="text-align: center;"> <p>Right or Left</p> </div> </div>
7	Draw Value Outside of the Range	<p>If the <i>Draw Value Outside of the Range</i> Option is selected, the positions of the maximum and minimum values outside of the range will be displayed.</p> <p>If the <i>Draw Value Outside of the Range</i> Option is not selected, the values outside of the range will not be displayed.</p>

**NS Series Programming Manual**

**Display Parameter Settings**

Sets the lines to be shown on the data log graph.

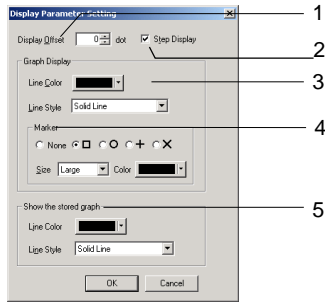

No.	Setting	Details
1	Display offset	Displays the data log graph in an offset position, where a specified offset (number of dots) have been added to the position for the present value. Fine adjustment can be made to the display position.
2	Step display	When step display is selected, the logged points are connected by vertical and horizontal lines. Refer to the diagram outside the table for details.
3	Graph display	Select the line parameters for the graph being logged.
	Line Color	Sets the line color (from 256 available colors).
	Line Style	Select from the five line types listed below. Solid line, dotted line, broken line, 1-dot chain line, or 2-dot chain line
4	Marker	Selects one of the following five markers to be displayed at the logged points. None, □, ○, +, or ×
	Size	Selects large, middle, or small for marker size. The sizes are shown below. Large    Medium    Small  □    □    □
	Color	Sets the marker color (from 256 available colors).
5	Show the stored graph	Select the line parameters for a file retrieved using <i>Read File</i> .
	Line Color	Sets the line color (from 256 available colors).
	Line Style	Select from the five line types listed below. Solid line, dotted line, broken line, 1-dot chain line, or 2-dot chain line

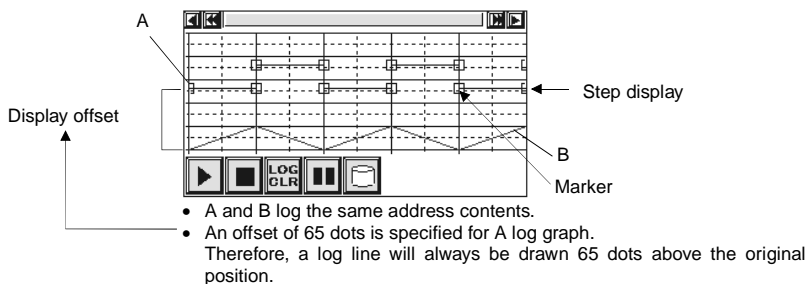

### Time Axis Tab Page

Contains the settings for the data log graph's time axis.

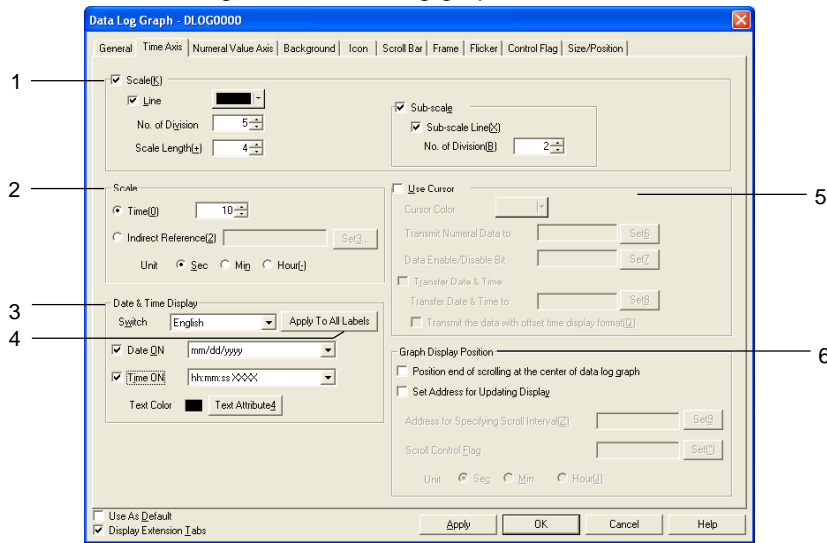



No.	Setting	Details
1	Scale	Makes the settings for the time axis. 
	Scale	Select <i>Scale</i> to display scale.
	Line	Select <i>Line</i> to display scale lines.
	No. of division	Sets the number of divisions between 1 and 99.
	Scale color	Sets the scale color (from 256 available colors).
	Scale length	Sets the scale length between 4 and 32. (Units: Dots)
	Sub-scale	Sets whether or not there will be sub-scale. Select <i>Sub-scale</i> to display sub-scale.
	Sub-scale Line	Select <i>Sub-scale Line</i> to display the auxiliary gradation (sub-scale) lines.
	No. of division	Sets the number of divisions between 1 and 99.

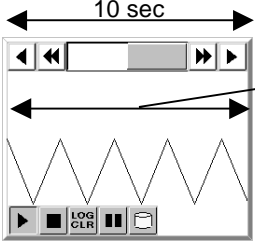
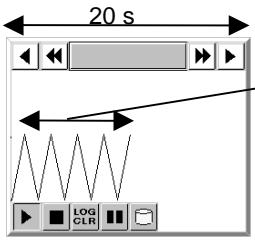
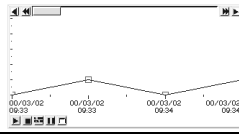

**NS Series Programming Manual**

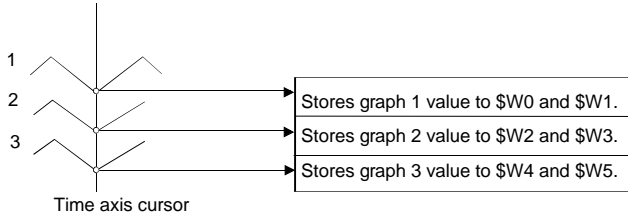
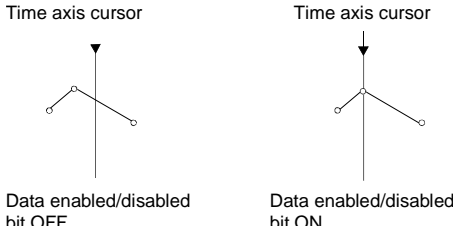
No.	Setting	Details
2	Scale	<p>Sets the scale for the time axis between 1 and 32,767. The time scale can be input directly or, when the <b>Set</b> Button is pressed, an address can be specified indirectly.</p> <p>Examples</p> <p>When the sampling cycle is 1 s, the number of logged points is 20, and the time axis scale is set to 10:</p>  <p>When the sampling cycle is 1 s, the number of logged points is 10, and the time axis scale is set to 20:</p> 
3	Date and time display	<p>Sets whether or not the date and time will be displayed on the time axis.</p> <p><b>Switch</b> Sets the date and time display format for each label. The date and time are displayed on the time axis scales as shown in the following diagram.</p>  <p><b>Date</b> Select <i>Date</i> to display the date. Selects the date display format from the pull-down list. Refer to <i>Date and Time Format</i> under 2-8 Common Functional Object Functions for details.</p> <p><b>Time</b> Select <i>Time</i> to display the time. Selects the time display format from the pull-down list. Refer to <i>Date and Time Format</i> under 2-8 Common Functional Object Functions for details.</p> <p><b>Text color</b> Sets the character color and font under the <b>Text Attribute</b> Button. Refer to <i>Labels</i> and <i>Setting Colors</i> under 2-8 Common Functional Object Functions for details.</p>
4	Apply to All Labels	<p>Uses the date display method for the selected label for all labels. This setting is used only for labels for which a date display and time display are selected. It is not used for all labels for items set in the character attributes. <i>Apply to All Labels</i> cannot be set in the following cases.</p> <ul style="list-style-type: none"> <li>• When the <i>Date &amp; Time Display Format</i> Check Box is selected on the Edit/Display Tab Page of the Option Dialog Box accessed by selecting <b>Tools - Option</b>.</li> <li>• When there is only one label.</li> <li>• When a date display and time display are not selected (OFF).</li> </ul>
5	Use Cursor	<p>Sets whether or not there will be a cursor on the time axis. Select <i>Use cursor</i> to use a cursor. A vertical line will be displayed on the time axis if <i>Use cursor</i> is selected. The value for the position where the time axis cursor and the log graph cross is sent to a specified address.</p> <p>Touch any position on the object, except the scroll bar, to move the cursor to that position. Alternatively, touch the Scroll Button for the time axis cursor.</p> <p><b>Cursor Color</b> Sets the cursor color (from 256 available colors).</p>

No.	Setting	Details
5	Transmit Numerical Data to	<p>Sets the destination address for the data under the <b>Set</b> Button. The data length is set in each data log, and depends on the storage format.</p> <p>Example (two words per data) Transfer destination: \$W0</p>  <p>1 Stores graph 1 value to \$W0 and \$W1. 2 Stores graph 2 value to \$W2 and \$W3. 3 Stores graph 3 value to \$W4 and \$W5.</p> <p>Time axis cursor</p>
	Data enable/disable bit	<p>Sets the address for the data under the <b>Set</b> Button. The specified bit turns ON when the time axis cursor is on the logged point. The specified bit remains ON until it is turned OFF from another functional object or the cursor is moved to a data disabled position.</p>  <p>Time axis cursor                      Time axis cursor</p> <p>Data enabled/disabled bit OFF                      Data enabled/disabled bit ON</p> <p>For example, the display can be linked to control flags for numeral display and input objects, as shown in the following diagram.</p> <p>Setting Example Data enable/disable bit: \$B0 Numeral display and input object control flag (display/no display (numeral display): indirect): \$B0</p>  <p>z                       </p> <p>\$B0:OFF                      \$B0:ON</p> <p>Numeric value not displayed                      Numeric value displayed</p>
	Transfer Date & Time	<p>Select the <i>Transmit Time Data</i> option to transfer the date and time for the position where the time axis cursor and the time axis cross to a specified address. The date and time will be output in the format specified for the Date and Time Display for Time Axis.</p>
	Transfer Date & Time to	<p>Set the destination address under the <b>Set</b> Button. One word of data each is stored for the year, month, day, day of the week, hour, minute, second, and millisecond.</p> <p>Example: Transmit Time Data To: \$W100 This is stored from \$W100 to \$W107.</p>
	Transmit the Data with Offset Time Display Format	<p>Select to display data with offset (the time elapsed since data logging was started) when transmitting time data.</p>

**NS Series Programming Manual**

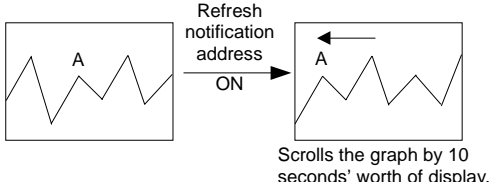
No.	Setting	Details
6	Graph display position	Makes the settings for display refresh.
	Position end of scrolling at the center of data log graph	Select to scroll when a log graph has reached the center of the time axis.
	Setting Address for Updating Display	When setting the address for display refresh, check Setting Address for Updating Display, then press the <b>Set</b> Button.
	Scroll Control Flag	Sets the address for updating display under the <b>Set</b> Button. If the bit specified here turns from OFF to ON, the graph display is scrolled for the amount of time specified by the contents of the address specified under <i>Address for specifying Scroll interval</i> . Once the display has been scrolled, the address for updating display will automatically turn OFF. Turn ON the address to update the graph at any time.
	Address for Specifying Scroll interval	<p>Sets the address for specifying scroll interval under the <b>Set</b> Button.</p> <p>When the Refresh notification address turns ON, the graph display is scrolled for the amount of time specified here. The amount of time is specified in binary format. The graph will not be scrolled if 0 is specified.</p> <p>Seconds, minutes, or hours can be selected as the unit of time.</p> <p>Example: When No. of scroll seconds set to 10</p>  <p>Scrolls the graph by 10 seconds' worth of display.</p>

**Note**

- ◆ If the clock is changed during PT operation, the time will no longer match the time that has been displayed up to that point so graphs will not be displayed correctly. In such cases, clear the log by using the Log Clear icon on the data log graph or initializing the data under the System Menu.
- ◆ If *Save with Ring Buffer* is selected for the data log save format, data will be deleted in order from the oldest data when the number of logged data items reaches the set number of log points. Sometimes this means that the oldest graph data will have already been deleted when the graph is scrolled when the address for updating display turns ON. For example, if the display direction has been set to *Left*, the data displayed at the left of the graph may have already been deleted. In this situation, the graph display is also refreshed when the address for updating display turns OFF and the data registered at that time is displayed on the graph.
- ◆ If frames are switched frequently, the display update may take some time and communications may be delayed. This means that sometimes data is not logged.
- ◆ The data format (BCD or binary) for *Transmit Time Data To* is set by selecting **PT – Project Properties** and using the Data Format Tab Page.

**NS Series Programming Manual**

### Numeral Value Axis Settings

Click the **Scale Settings** Button to display the following Details of Numeral Value Axis screen.

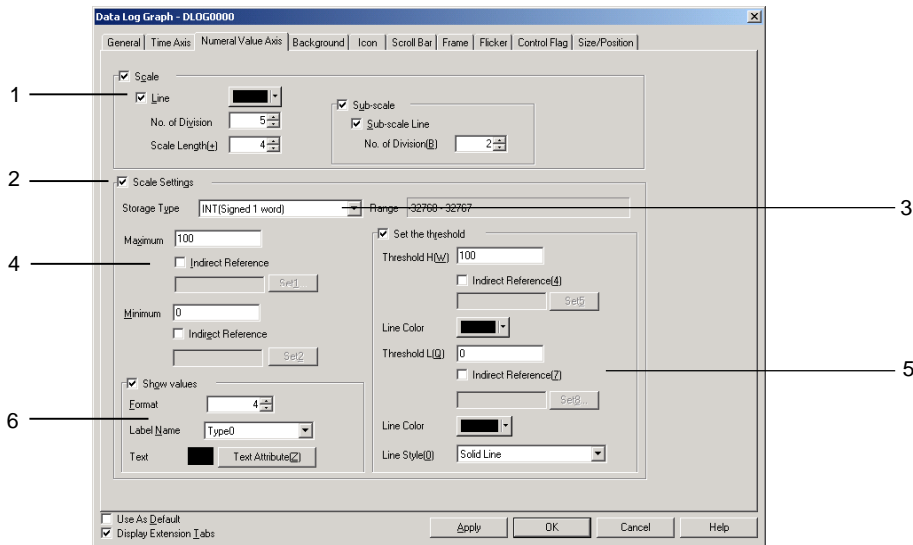

No.	Setting	Details
1	Scale	Makes the settings related to the numeral value axis' scale.
	Scale	Select <i>Scale</i> to display scale.
	Line	Select <i>Line</i> to display scale lines.
	No. of division	Sets the number of divisions between 1 and 99.
	Scale color	Sets the scale color (from 256 available colors).
	Scale length	Sets the scale length between 4 and 32.
	Sub-scale	Sets whether or not there will be sub-scale. Select <i>Sub-scale</i> to display auxiliary gradations.
	Sub-scale Line	Select <i>Sub-scale lines</i> to display sub-scale lines.
	No. of division	Sets the number of gradations between 1 and 99.
	Scale settings	Makes the settings for maximum, minimum, and threshold values, and show values. Refer to <i>Numeral Value Axis Settings</i> to be described later in this section for information on how to make settings.
2	Scale Settings	Select to make settings under "Scaling range of numeral value axis," "Threshold," and "Show values."
3	Storage type	Select the format for storing the scaling range of the numeral axis value from the four types below. INT (signed 1 word), UINT (unsigned 1 word), DINT (signed 2 words), UDINT (unsigned 2 words)
4	Scaling range of numeral value axis	Sets the minimum and maximum values on the numeral value axis.
	Maximum	The maximum that can be set depends on the storage type.
	Minimum	The minimum that can be set depends on the storage type.
	Indirect Reference	Select to set the minimum and maximum values at a communications address.
5	Threshold	Sets the threshold values for graph display.
	Set the threshold	Select to make threshold settings.
	Threshold H	The threshold H that can be set depends on the storage type.
	Line Color	Sets the line color (from 256 available colors) for threshold H.
	Threshold L	The threshold L that can be set depends on the storage type.
	Line Color	Sets the line color (from 256 available colors) for threshold L.
	Line Style	Sets the line style from one of the following 5 styles: Solid line, dotted line, broken line, single chain line, double chain line

**NS Series Programming Manual**

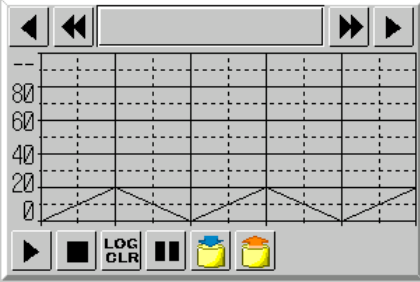
No.	Setting	Details
6	Show values	Sets values.
	Show values on the numeral value axis	Selects to show values on the numeral value axis.
	Format	<p>“-“ will be displayed for values that exceed the number of digits set under <i>Format</i>. Example: When <i>Format</i> is set to 2 (digits), and the maximum value is 100:</p> 
Text	Click the <b>Text Attribute</b> Button to set text attributes such as the text color and font. For details, refer to 2-8-6 <i>Text Attributes</i> .	







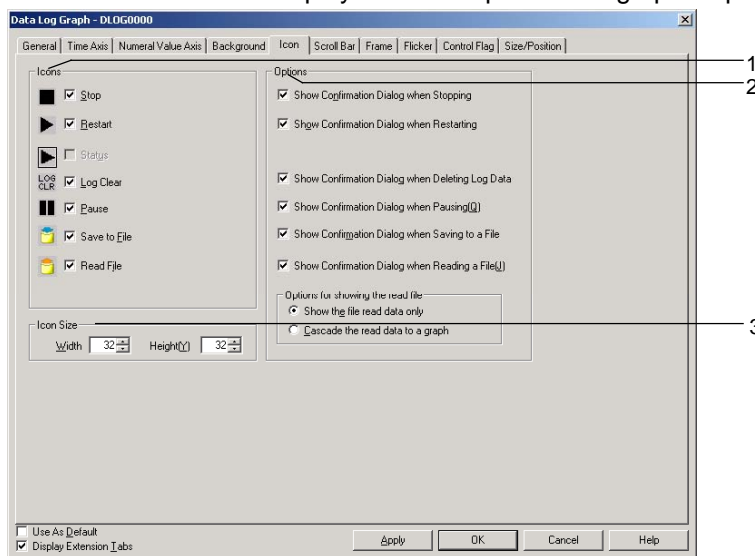

**Background Tab Page**

Sets whether or not the background is tiled. If the background is to be tiled, the background color for the graph can be selected from 256 colors. Click **Indirect reference of color** to reference the color code stored at a specified address for the background color. Refer to *Background* under 2-8 *Common Functional Object Functions* for details.

**Icon Tab Page**

Selects the icon to be displayed for manipulation of graph display.



No.	Setting	Details
1	Icons	Sets whether or not an icon will be used for manipulating graph display.
	 Stop	<p>Press to stop data logging.</p> <p>Stops data logging when pressed, if the <i>Control start/stop data log by the specified address</i> option was not selected when data log group settings were made.</p> <p>Select to allocate the set address to the icon, if the <i>Control start/stop data log by the specified address</i> option was selected when data log group settings were made. This option cannot be selected if the Status icon is selected.</p>
	 Restart	<p>Press to start data logging that has been stopped.</p> <p>Press to restart data logging that has been stopped, if <i>Control start/stop data log by the specified address</i> was not selected when data log group settings were made.</p>
	 Start	<p>Select to allocate the set address to the icon, if the <i>Control start/stop data log by the specified address</i> option was selected when data log group settings were made. This option cannot be selected if the Status icon is selected.</p>
	 Status	<p>Can be selected only when <i>Control start/stop data log by the specified address</i> was selected when data log group settings were made.</p> <p>Displays the status of the specified address, when an externally-controlled address is specified to start/stop data logging.</p> <p>Select when the specified address is allocated to an externally-controlled address.</p>
	 Log Clear	<p>Clears the graph display and log.</p>
	 Pause	<p>Pauses display of the data log graph. Press the icon again to cancel pause.</p>
	 Save to File	<p>Writes a file of logging data to the Memory Card/Log/Trend directory for the data log group being displayed, in the output file name set for the data log group being displayed.</p>
 Read File	<p>Selects the file saved to the Memory Card/Log/Trend directory from a popup menu for the data log group being displayed. The selected file is displayed on the graph.</p>	
2	Options	<p>A confirmation dialog box can set to be displayed when any of the icons are pressed.</p> <p>Show Confirmation Dialog when Stopping.</p> <p>Show Confirmation Dialog when Restarting.</p> <p>Show Confirmation Dialog when Deleting Log Data.</p> <p>Show Confirmation Dialog when Pausing.</p> <p>Show Confirmation Dialog when Saving to a File.</p> <p>Show Confirmation Dialog when Reading a CSV File.</p>
	Options for showing the read file	<p>Select the graph display format when reading a file, from the following two options.</p> <p>Show the read data only.</p> <p>Cascade the read data to a graph.</p>
3	Icon size	Set the size of the icon. (16 to 64)

**Reference**

- ◆ Even if display update is stopped because the Pause icon has been pressed, data logging will continue when the Restart icon is selected. The latest log is then displayed if the screen is updated.
- ◆ The Clear icon usually displays the characters *LOG CLR*, but if the icon size is smaller than 32 dots × 32 dots, only *C* will appear on the icon.
- ◆ Files can be written by using the system memory (\$SB and \$SW). Log data for a specified group can be saved as a CSV file by storing the group number in \$SW37 and turning ON \$SB36.  
Output file name: Output file name set for each group  
All log data can be saved as a CSV file if "0" is stored in \$SW37 and \$SB36 is turned ON.  
Output file name:  
Trend□.CSV  
□ = 001 to 999, the number is automatically incremented beginning with 001 each time the output operation is executed. After 999, the number reverts to 001.  
Similarly, if the group number or "0" is stored in \$SW37 and \$SB35 is turned ON, the specified group data or all log data is initialized.
- ◆ Graph displays of files read from the Memory Card will be cleared when screens are switched.

**Note**

- ◆ Memory Cards can be rewritten up to 100,000 times. If you were to repeatedly rewrite the Card in 10-minute intervals, 100,000 rewriting cycles would be completed within 2 years.

**Scroll Bar Tab Page**

Sets display/no display, scroll width, and button size for the graph scroll bar displayed at the top of the data log graph. The scroll bar will appear at the top of the graph when the display direction is set to *Left* or *Right*. It will appear to the right of the object if the display direction is set to *Up* or *Down*. Refer to *Scroll Bars* under *2-8 Common Functional Object Functions* for details.

**Frame Tab Page (Extension Tab)**

Specifies the colors and sizes of the functional object frame to change the shape or color when the graph frame is depressed or raised. Refer to *Frames* under *2-8 Common Functional Object Functions* for details.

**Flicker Tab Page (Extension Tab)**

Make flicker settings to make the functional object flicker (flash). Refer to *Flicker* under *2-8 Common Functional Object Functions* for details.

**Control Flag Tab Page (Extension Tab)**

Control flags can control the display of and input to functional objects. Use control flags to enable display and input when the contents of an address turn ON or OFF. Refer to *Control Flags* under *2-8 Common Functional Object Functions* for details.

**Size/Position Tab Page (Extension Tab)**

Displays and sets the functional object size and position. Refer to *Size/Position* under *2-8 Common Functional Object Functions* for details.

### 2-15-3 Example Setting Procedure

In Ver. 6 and later versions, the following two applications can be executed by using data log objects.  
Automatic periodical saving of log data to a Memory Card and continued logging.

Overlapping a data log graph (standard data) in the Memory Card with the graph being logged.

This section provides an example of the CX-Designer setting procedures required to use these two functions. The values provided are only examples and should be changed to actual values as required.

#### Automatic Periodical Saving of Log Data to a Memory Card and Continued Logging

##### Setting Flowchart

The following flowchart shows the settings required to automatically and periodically save log data to a Memory Card and continue logging.

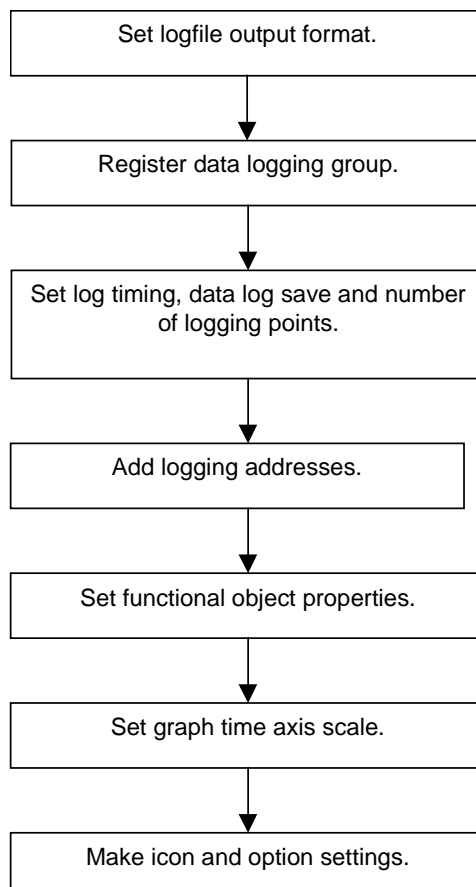

The procedure for saving data log files to the Memory Card and continuing logging is provided below.  
Example: To automatically save every 5 hours a data log file with 5 log addresses and a sampling cycle of 2 seconds.



**NS Series Programming Manual**

**Setting Logfile Output Format**

The method for setting the Logfile Output Format is shown below.

1. Select **PT – System setting** to display the System Setting Dialog Box.
2. Click the History Tab Page.
3. Set **Logfile Output Format** to “Vertical axis: Time/ Horizontal axis: Address.”
4. Set the **Data Log/Broken-line History** to “Hold data of always logging (Data Log).”

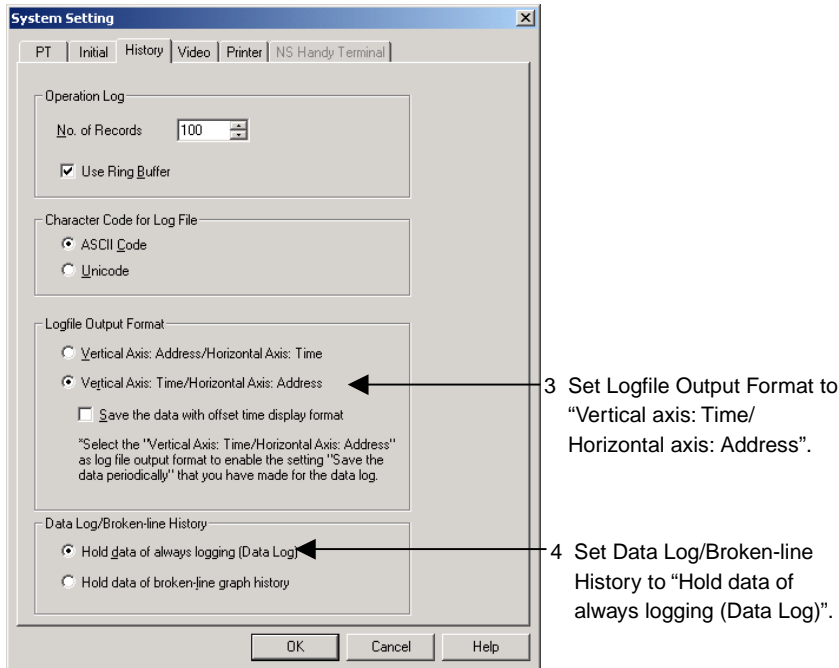

5. Click the **OK** Button.

**Settings for Data Logging Group Registration**

1. Select **PT – Data log**, or click the **Register Group** Button on the General Tab Page in the data log Functional Object Properties Dialog Box, to display the Data Log Setting Dialog Box.

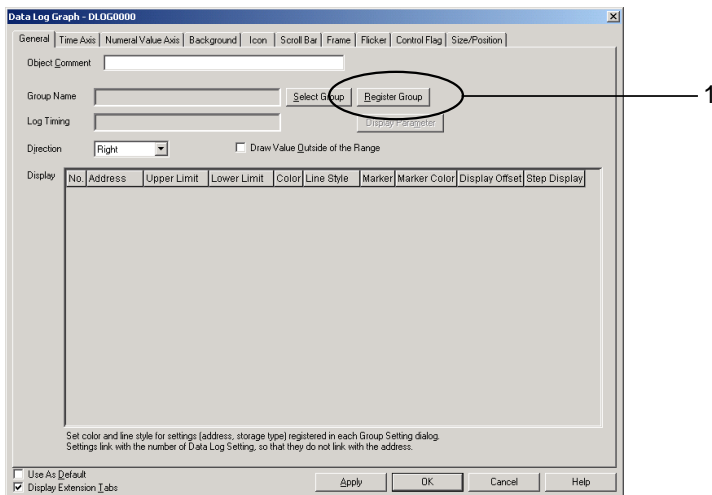

**NS Series Programming Manual**

- Click the **Add** Button in the Data Log Setting Dialog Box to display the Data Log Group Setting Dialog Box.

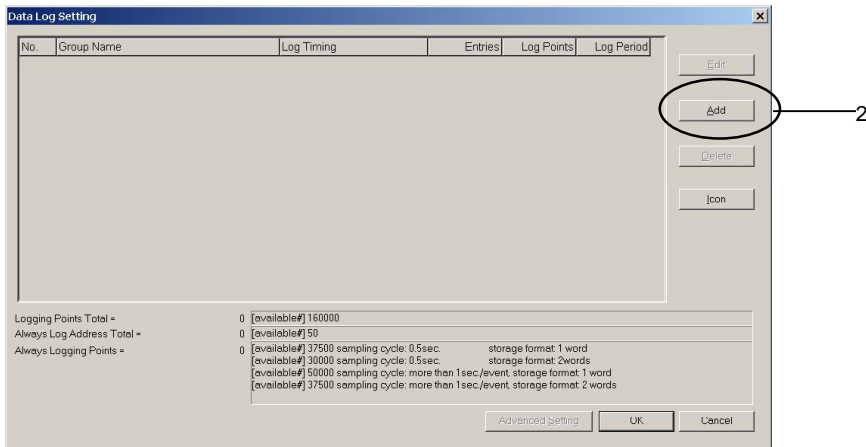

- Set the sampling cycle.
- Select both *Save the data periodically* and *Save with Ring Buffer*.
- Set the number of logging points to be saved in one CSV file. In this example, the logging period is 5 hours (18,000 s) and the sampling cycle is 2 s, so the number of logging points is  $18,000 \div 2$ , i.e., 9,000, so 9000 is set.

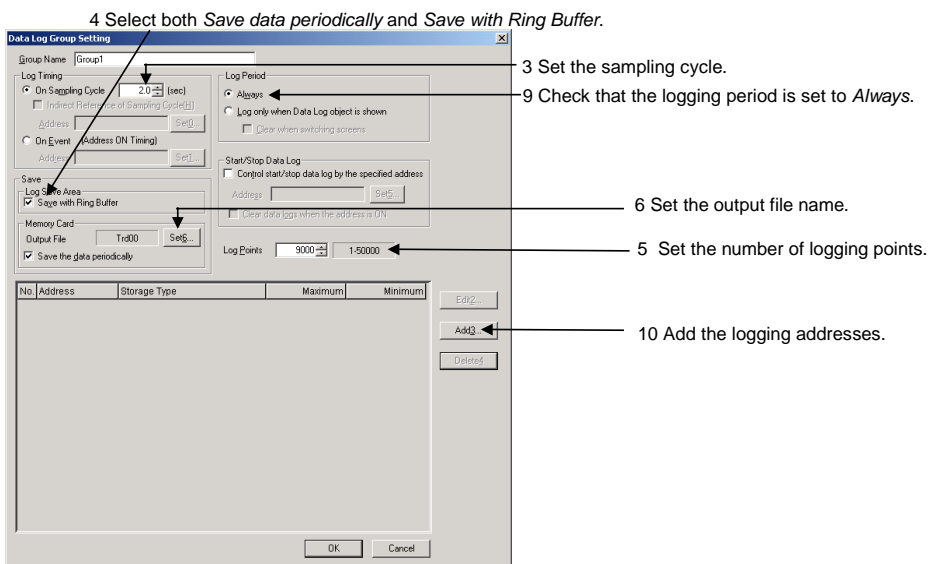

- Click the **Set** Button next to *Output file* at the upper right of the screen to display the Data Log Output File Dialog Box.

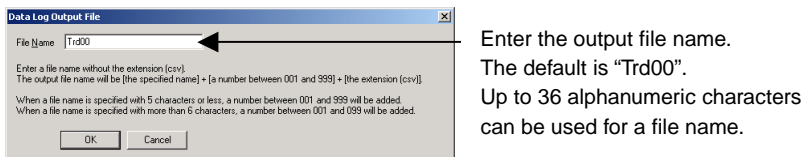

- Enter the output file name.
- Click the **OK** Button to return to the Data Log Group Setting Dialog Box.
- Check that the logging period is set to *Always*.
- Click the **Add** Button to display the Data Log Address Setting Dialog Box.
- Set the logging address and the address storage type.

**NS Series Programming Manual**

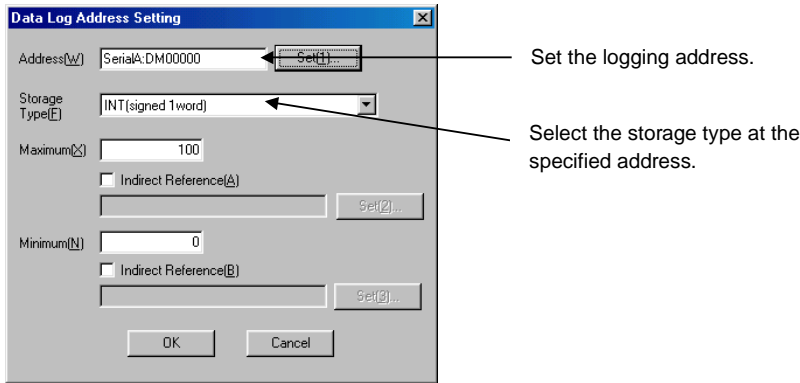

Set the logging address.

Select the storage type at the specified address.

12. Click the **OK** Button to return to the Data Log Group Setting Dialog Box.
13. Repeat steps 10 to 12 to register 5 addresses.
14. Click the **OK** Button in the Data Log Group Setting Dialog Box.
15. Click the **OK** Button in the Data Log Setting Dialog Box.

**Settings for Functional Object Properties**

1. Place a data log object on the screen if there isn't one there already.
2. Double-click the data log object to display the Functional Object Properties Dialog Box.
3. Display the Time Axis Tab Page and set the scale for the time axis. In this example, "10" minutes' worth of log data is set for display.

3. Set the amount of the logging period to be displayed at one time.

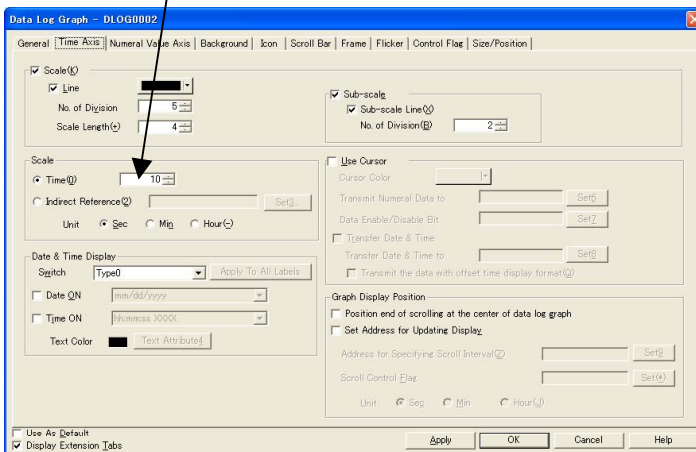

4. Display the Icon Tab Page and de-select *Log clear* and *Save to file* under Icon Display. These icons are not required because the log is set to be automatically saved.
5. Select *Show the read data only* under *Options for showing the read file* in the Options section.

**NS Series Programming Manual**

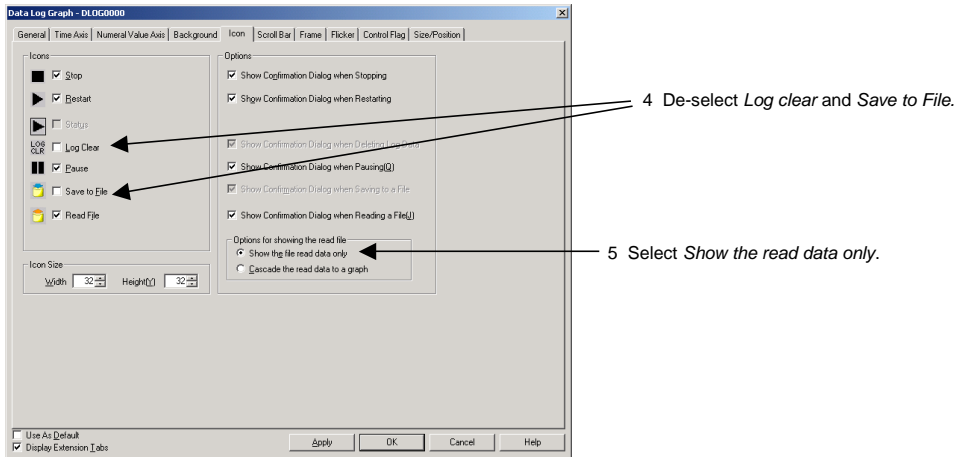

6. Click the **OK** Button to transfer the project to the NS hardware.

**Operations on the NS hardware**

1. Insert the Memory Card into the NS hardware.
2. Start the NS hardware, which now has the project created using the procedures described in the last section.

The NS hardware logs 5 addresses every 2 seconds and periodically saves the logging data to the Memory Card.

To read the saved data from the Memory Card, click the *Read File* Icon on the Object while logging is stopped to display the list of data file names, in descending order, in a pop-up menu. Select the desired file from the pop-up menu.



To display a graph that is currently being logged, click the *Read File* Icon on the Object and select *Show the current logging graph*, in the first line of the pop-up menu.

**Note**

- ◆ Memory Cards can be rewritten up to 100,000 times. If you were to repeatedly rewrite the Card in 10-minute intervals, 100,000 rewriting cycles would be completed within 2 years.

## Overlapping a Standard Data Log Graph from the Memory Card and a Graph Currently Being Logged

### Setting Flowchart

The settings required to overlap the standard data and the data currently being logged on the same graph are shown in the following flowchart.

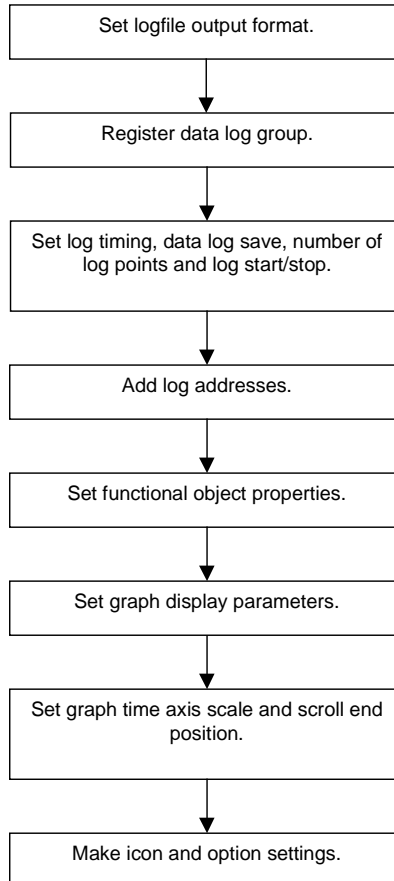

The procedure for overlapping the data log graph on the Memory Card (standard data) and the graph of data currently being logged (measured data) is shown below.

When setting the logging address cycle time to, for example, 100 s, to log data for one address at a sampling cycle of 1 s for a period of 100 s after the specified address changes from OFF to ON.

Example 1: Allocation of specified address (PT memory: \$B100) to an icon and manual control of log start/stop

Example 2: Allocation of an externally controlled address (SerialA: CIO00100.00) to the specified address

**NS Series Programming Manual**

**Example 1: Allocation of Specified Address (PT Memory: \$B100) to an Icon and Manual Control of Log Start/Stop**

Display direction: Right

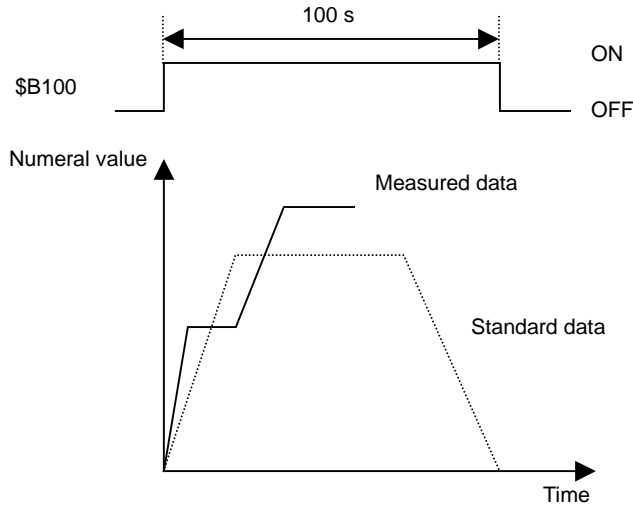

**Setting Data Log File Output Format**

The method for setting the data log file output format is described below.

1. Select **PT – System setting** to display the System Settings Dialog Box.
2. Select the History Tab Page.
3. Set **Logfile Output Format** to “Vertical Axis: Time/ Horizontal Axis: Address.”
4. Set the **Data Log/Broken-line History** to “Hold data of always logging (Data Log).”

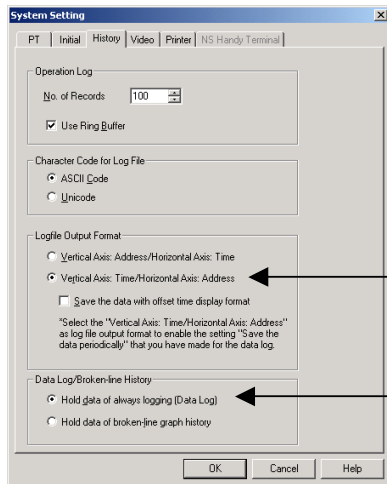

3 Set logfile output format to “Vertical Axis: Time/ Horizontal Axis: Address”.

4 Set Data Log/Broken-line History to “Hold data of always logging (Data Log)”.

4. Click the **OK** Button.

### Settings for Data Logging Group Registration

1. Select **PT – Data log**, or click the **Register Group** Button on the General Tab Page in the data log Functional Object Properties Dialog Box, to display the Data Log Setting Dialog Box.

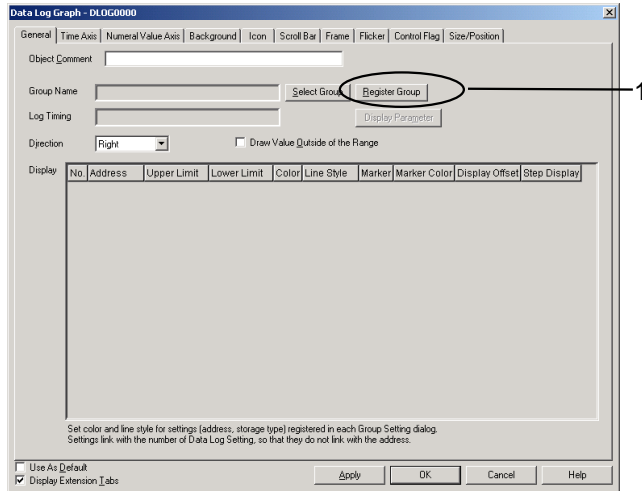

2. Click the **Add** Button in the Data Log Setting Dialog Box to display the Data Log Group Setting Dialog Box.

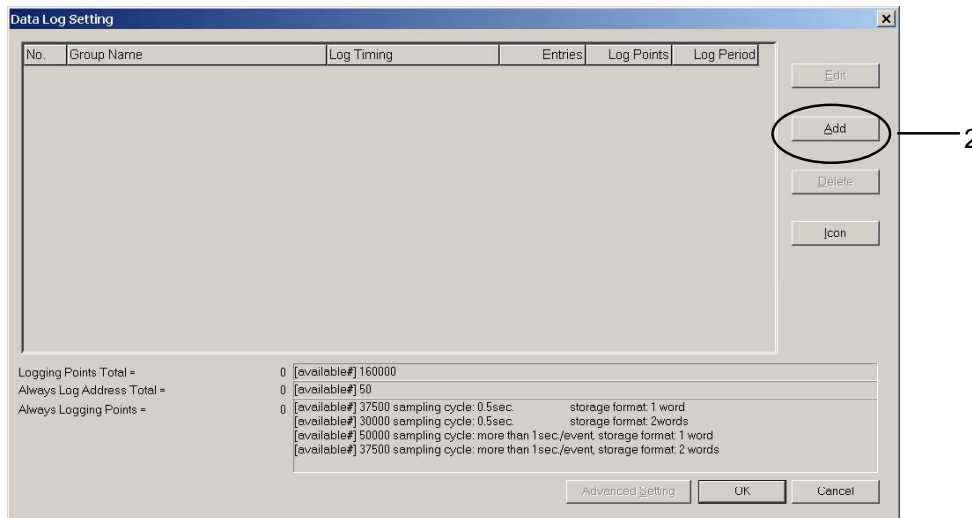

3. Set the log timing. In this example, the sampling cycle is “1” (s).
4. De-select both *Save the data periodically* and *Save with Ring Buffer*.
5. Set the number of logging points. In this example, the logging period is 100 s and the sampling cycle is 1 s, so the number of logging points to be set is “100” (100 ÷ 1 = 100).

**NS Series Programming Manual**

4. De-select both *Save data periodically* and *Save with Ring Buffer*.

The screenshot shows the 'Data Log Group Setting' dialog box. Annotations point to various fields:
 

- 3. Set the sampling cycle. (Points to the 'On Sampling Cycle' field set to 1.0 sec)
- 5. Set the number of logging points. (Points to the 'Log Points' field set to 100)
- 6. Set the output file name. (Points to the 'Output File' field set to Trd00)
- 9. Set the Control start/stop data log by the specified address. (Points to the 'Control start/stop data log by the specified address' checkbox and the 'Address' field set to \$B100)
- 10. Add the logging addresses. (Points to the 'Add3' button in the table below)

No.	Address	Storage Type	Maximum	Minimum

6. Click the **Set** Button next to *Output file name* at the upper right of the screen to display the Data Log Output File Name Setting Dialog Box.

The screenshot shows the 'Data Log Output File' dialog box. Annotation 7 points to the 'File Name' field containing 'Trd00'.
 

Enter the output file name.  
The default is "Trd00". A file name of up to 36 alphanumeric characters can be used.

7. Enter the output file name.

8. Click the **OK** Button to return to the Data Log Group Setting Dialog Box.

9. Select *Control start/stop data log by the specified address ON/OFF* and click the **Set** Button to set the address. The address is set to "PT memory: \$B100" in this example. Select *Clear data logs when the address is ON* to clear the previous data log graph when the specified address changes from OFF to ON.

10. Click the **Add** Button to display the Data Log Address Setting Dialog Box.

11. Set the logging address and the address storage type.

The screenshot shows the 'Data Log Address Setting' dialog box. Annotations point to:
 

- 12. The 'Address' field set to 'SerialA:DM00000'.
- 13. The 'Storage Type' dropdown menu set to 'INT(signed 1 word)'.

12. Click the **OK** Button to return to the Data Log Group Setting Dialog Box.

13. Click the **OK** Button in the Data Log Group Setting Dialog Box.

14. Click the **OK** Button in the Data Log Settings Dialog Box.



**NS Series Programming Manual**

**Settings for Functional Object Properties**

1. Place a data log object on the screen if there isn't one there already.
2. Double-click the data log object to display the General Tab Page for the functional object properties.

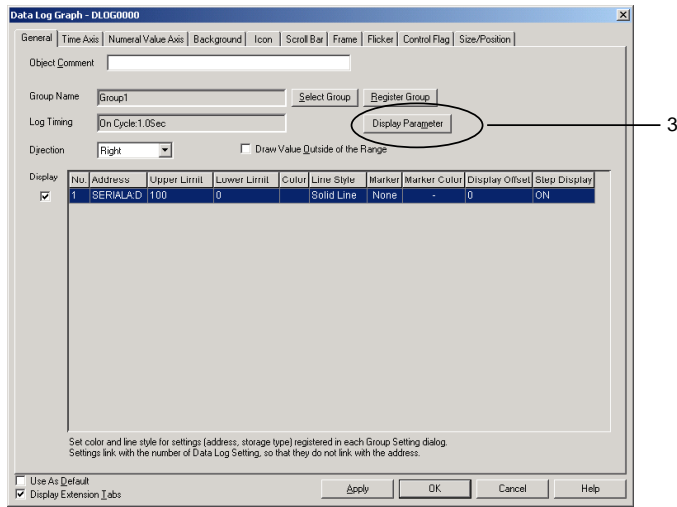

3. Select the address from the data log address list, and double-click it, or click the **Display Parameter** Button at the top right of the screen to display the Display Parameter Settings Dialog Box.
4. Click the Line Color Box to set the line color for the stored graph, to distinguish the stored graph read from the Memory Card from the graph of data currently being logged. In this example, No. 012 (red) is selected for the stored graph.

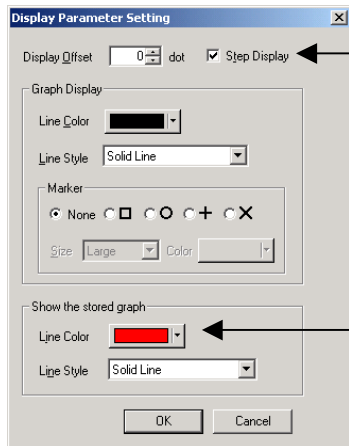

If *Step display* is selected, the logged points will be connected by vertical and horizontal lines. De-select *Step display* to join logging points by the shortest possible straight line.

Sets the line color when logging data is read from the Memory Card and displayed. In this example, No. 012 (red) has been selected.

5. Click the **OK** Button to return to the Functional Object Properties Dialog Box.
6. Display the Display Tab Page and set the graph time axis scale. In this example, "50" seconds' worth of logging data will be displayed.
7. Select *Position end of scrolling at the center of data log graph* when all of the standard data cannot fit on to the graph.

**NS Series Programming Manual**

6. Set the amount of the logging period to be displayed at one time.

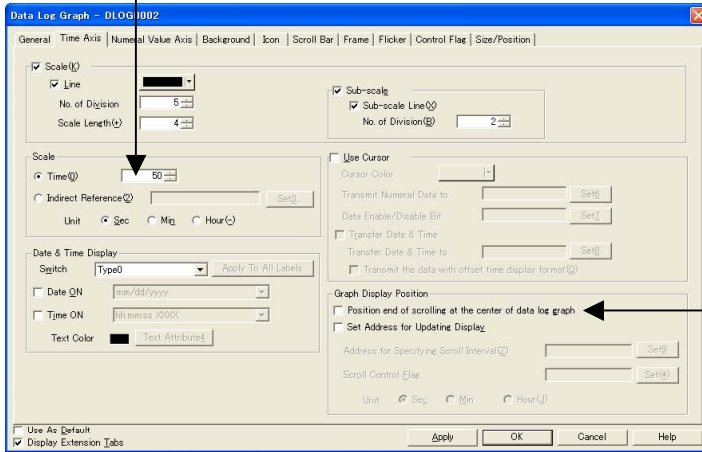

7. Select *Position end of scrolling at the center of data log graph.*

8. Display the Icon Tab Page and select *Cascade the read data to a graph* under Options.

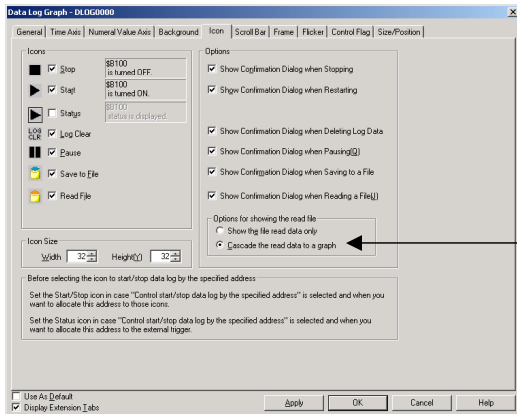

Select *Cascade the read data to a graph.*

9. Click the **OK** Button and transfer the project to the NS hardware.

**NS Series Programming Manual**

**Operations on the NS Hardware**

1. Insert the Memory Card into the NS hardware.
2. Start the NS hardware, which now has the project created using the procedures described in the last section.

When address \$B100 changes from OFF to ON, data is logged for 100 s (1 min 40 s).

When the *Start* icon is pressed, \$B100 changes to ON and logging starts.

When the *Stop* icon is pressed, \$B100 changes to OFF and logging stops.

To read saved data, press the *Read File* icon on the object while logging is stopped and select the desired file from the pop-up menu.

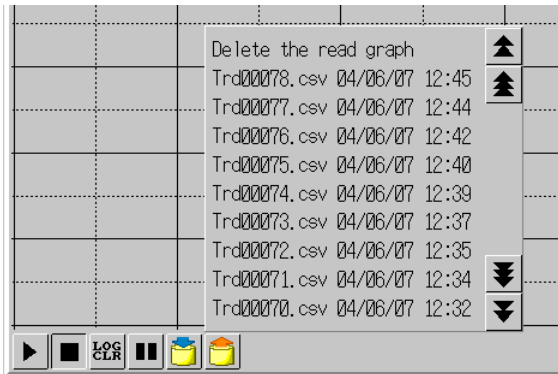

**Example 2: Allocation of an Externally Controlled Address (Serial A: CIO00100.00) to the Specified Address**

Display direction: Right

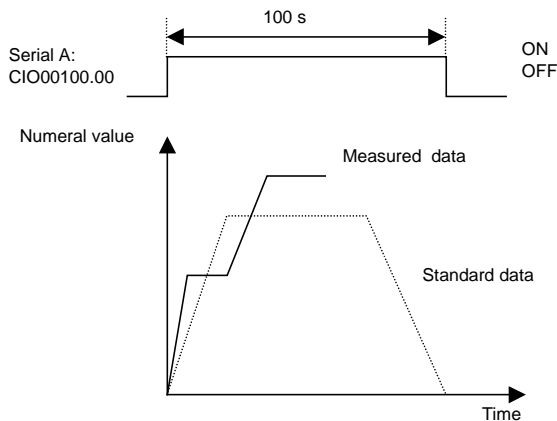

**Setting Data Log File Output Formats**

The method for setting data log file output formats is shown below.

1. Select **PT – System setting** to display the System Settings Dialog Box.
2. Click the **History** Tab.
3. Set *Logfile Output Format* to “Vertical Axis: Time/ Horizontal Axis: Address.”
4. Set the *Data Log/Broken-line History* to “Hold data of always logging (Data Log).”

**NS Series Programming Manual**

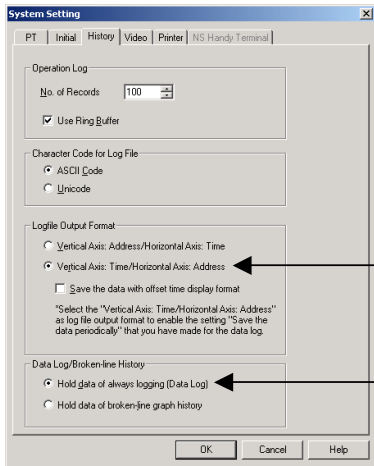

3. Set Logfile Output Format to "Vertical Axis: Time/ Horizontal Axis: Address".

4. Set Data Log/Broken-line History to "Hold data of always logging (Data Log)".

5. Click the **OK** Button.

**Settings for Data Logging Group Registration**

1. Select **PT – Data Log Setting**, or click the **Register Group** Button on the General Tab Page in the data log Functional Object Properties Dialog Box, to display the Data Log Settings Dialog Box.

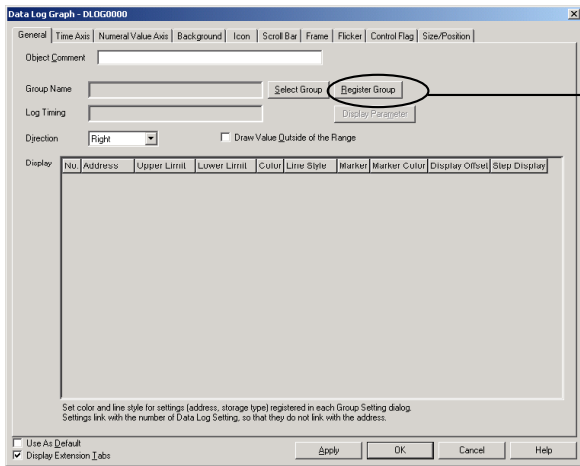

2. Click the **Add** Button to display the Data Log Group Setting Dialog Box.

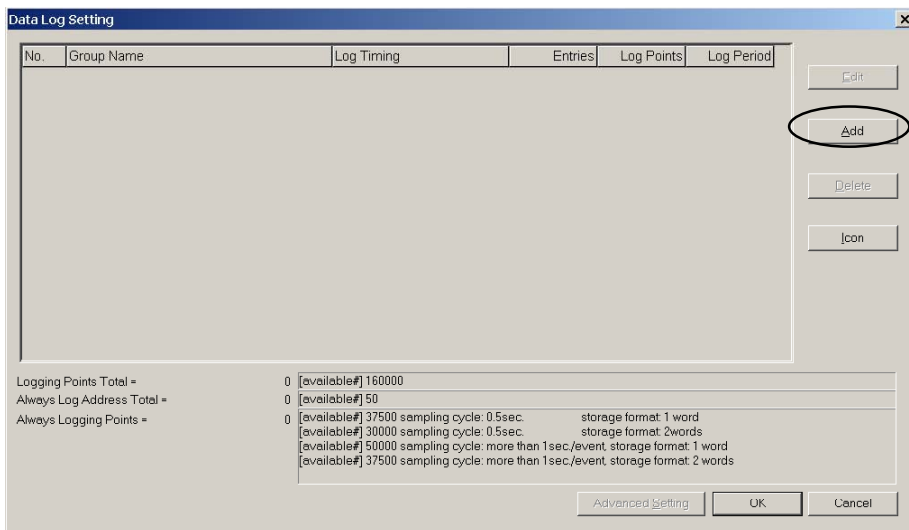

3. Set the log timing. In this example, the sampling cycle is "1" (s).

4. De-select both *Save the data periodically* and *Save with Ring Buffer*.

5. Set the number of logging points. In this example, the logging period is 100 s and the sampling cy-

**NS Series Programming Manual**

cle is 1 s, so the number of logging points to be set is “100” ( $100 \div 1 = 100$ ).

4. De-select both *Save the data periodically* and *Save with Ring Buffer*.

The screenshot shows the 'Data Log Group Setting' dialog box. It has several sections: 'Log Timing' with 'On Sampling Cycle' selected and 'Sampling Cycle' set to 1.0; 'Log Period' with 'Always' selected; 'Save' section with 'Log Save Area' and 'Save with Ring Buffer' deselected, and 'Memory Card' section with 'Output File' set to 'Trd00'; 'Start/Stop Data Log' section with 'Control start/stop data log by the specified address' checked and 'Address' set to 'SERIALA:CI000100.00'; and 'Log Points' set to 100. At the bottom is a table with columns 'No.', 'Address', 'Storage Type', 'Maximum', and 'Minimum'. Callouts 3-10 point to: 3. Sampling cycle (1.0), 6. Output file name (Trd00), 9. Control start/stop data log by the specified address (SERIALA:CI000100.00), 5. Number of logging points (100), and 10. Add logging addresses button.

6. Click the **Set** Button next to *Output file* at the upper right of the screen to display the Data Log Output File Dialog Box.

The screenshot shows the 'Data Log Output File' dialog box. It has a 'File Name' field containing 'Trd00'. Below the field is explanatory text: 'Enter a file name without the extension (.csv). The output file name will be [the specified name] + [a number between 001 and 999] + [the extension (.csv)]. When a file name is specified with 5 characters or less, a number between 001 and 999 will be added. When a file name is specified with more than 6 characters, a number between 001 and 099 will be added.' There are 'OK' and 'Cancel' buttons at the bottom. A callout points to the 'File Name' field with the text: 'Enter the output file name. The default is “Trd00”. A file name of up to 36 alphanumeric characters can be used.'

7. Enter the output file name.

8. Click the **OK** Button to return to the Data Log Group Setting Dialog Box.

9. Select *Control start/stop data log by the specified address ON/OFF* and click the **Set** Button to set the address. The address is set to “SerialA: CI000100.00” in this example. Select *Clear data logs when he address is ON* to clear the previous data log graph when the specified address changes from OFF to ON.

10. Click the **Add** Button to display the Data Log Address Setting Dialog Box.

11. Set the logging address and the address storage type.

The screenshot shows the 'Data Log Address Setting' dialog box. It has an 'Address' field with 'SERIALA:DM00100' and a 'Set1...' button. Below it is a 'Storage Type' dropdown menu set to 'INT(Signed 1 word)'. There are 'Range' and 'Maximum' fields. Callouts point to: 'Set the logging address.' (pointing to the 'Set1...' button) and 'Select the storage type at the specified address.' (pointing to the 'Storage Type' dropdown menu).

12. Click the **OK** Button to return to the Data Log Group Setting Dialog Box.

13. Click the **OK** Button in the Data Log Group Setting Dialog Box.

14. Click the **OK** Button in the Data Log Settings Dialog Box.

**NS Series Programming Manual**

**Settings for Functional Object Properties**

1. Place a data log object on the screen if there isn't one there already.
2. Double-click the data log object to display the General Tab Page for the functional object properties.

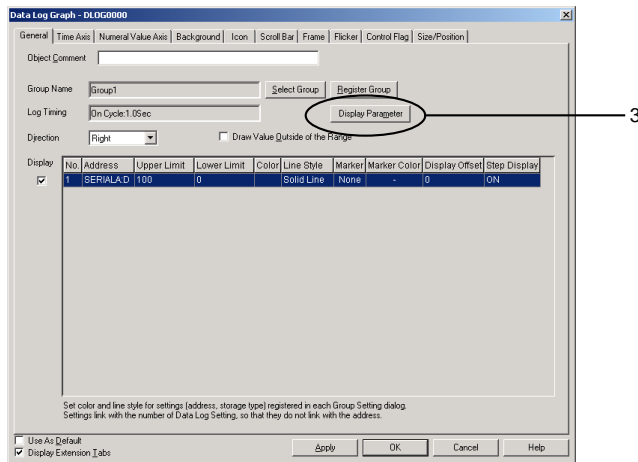

3. Select the address from the data log address list, and double-click it, or click the **Display Parameter** Button at the top right of the screen to display the Display Parameter Settings Dialog Box.
4. Click the **Set** Button next to *Line color* to set the line color for the stored graph, to distinguish the stored graph read from the Memory Card from the graph of data currently being logged. In this example, No. 012 (red) is selected for the stored graph.

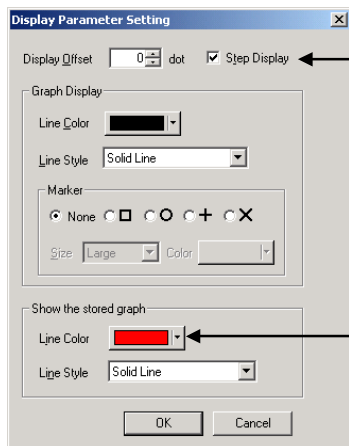

If *Step display* is selected, the logged points will be connected by vertical and horizontal lines. De-select *Step display* to join logging points by the shortest possible straight line.

Sets the line color when logging data is read from the Memory Card and displayed. In this example, No. 012 (red) has been selected.

5. Click the **OK** Button to return to the Functional Object Properties Dialog Box.
6. Display the Time Axis Tab Page and set the graph time axis scale. In this example, "50" seconds' worth of logging data will be displayed.
7. Select *Position end of scrolling at the center of data log graph* when all of the standard data cannot fit on to the graph.

**NS Series Programming Manual**

6. Set the amount of the logging period to be displayed at one time.

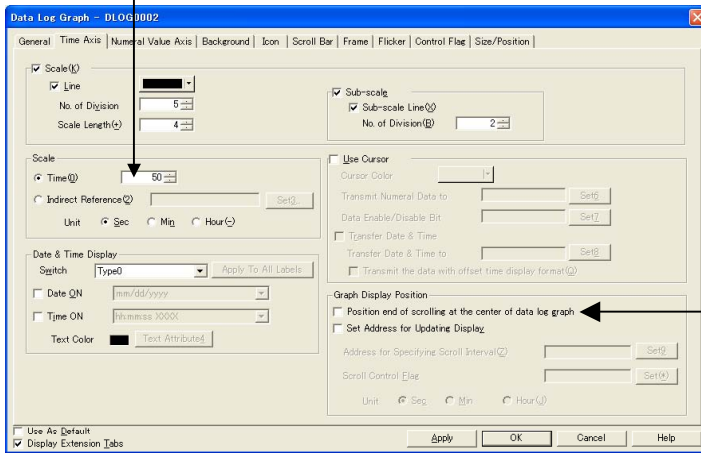

7. Select *Position end of scrolling at the center of data log graph.*

8. Display the Icon Tab Page.

9. Select *Status* under Icon.

10. Select *Cascade the read data to a graph* under Options.

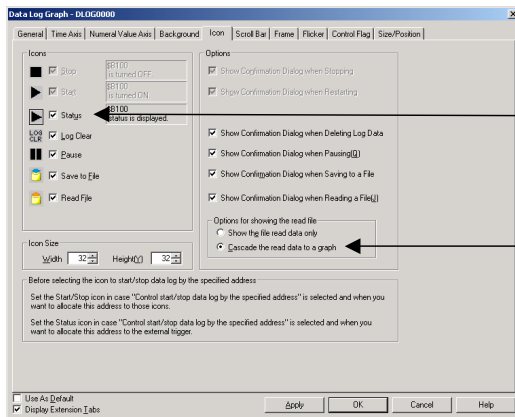

9. Select *Status*.

10. Select *Cascade the read data to a graph*.

11. Click the **OK** Button and transfer the project to the NS hardware.

### Operations on the NS Hardware

1. Insert the Memory Card into the NS hardware.
2. Start the NS hardware, which now has the project created using the procedures described in the last section.

When SerialA: CIO00100.00 changes from OFF to ON, data is logged for 100 s (1 min 40 s).

When SerialA: CIO00100.00 changes to ON, logging starts.

When SerialA: CIO00100.00 changes to OFF, logging stops.

To read saved data, press the *Read File* icon on the object while logging is stopped and select the desired file from the pop-up menu.

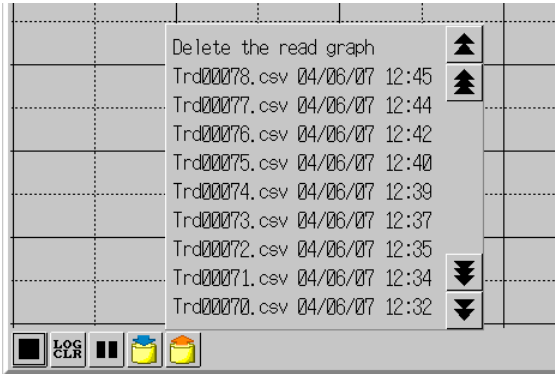

### Saving Logging Data to Memory Card and Using as Standard Data

The procedure for setting logged data as standard data is shown below.

1. While logging is stopped, make sure the data to be saved is displayed on the data log object, and press the *Save to file* icon.

When the Save to file icon is pressed, the data is saved as a CSV file to the Memory Card/Log/Trend directory after folders for the displayed graphs are created. The output file name set for each group is used as the name of the folder.

The saved data can be displayed directly as the standard data, but the file name can also be changed to make it easy to recognize as the standard data.

2. Turn OFF the power to the NS hardware, or display the System Menu, then click the Remove Memory Card Button in the Initialize Tab Page.
3. Remove the Memory Card from the NS hardware.
4. Use Explorer or a similar program on a personal computer to change the file name in the Memory Card/Log/Trend directory.

Example: When the output file name for group 1 is the default

Before changing	After changing
-----------------	----------------

Trd00□□□.CSV	Stddata□.CSV
--------------	--------------

(□□□: 001 to 999)	(□: 0 to 9)
-------------------	-------------

### Creating a CSV File of Standard Data

There are two methods for creating CSV files, depending on the data log file output format set on the History Tab Page under *PT – System settings*.

1. When the data log file output format is set to *Vertical axis: address, Horizontal axis: time*
2. When the data log file output format is set to *Vertical axis: time, Horizontal axis: address*.

Here we will create a CSV file for the data log graph shown in the following diagram. In this example, the data log file output format is set to *Vertical axis: time, Horizontal axis: address* (No. 2 above.) Simply swap the horizontal and vertical axis information in the following procedure if the data log file output format is *Vertical axis: address, Horizontal axis: time* (No. 1 above).



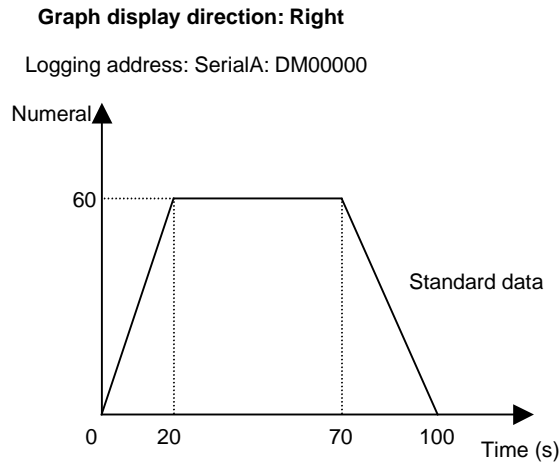

**Procedure for Creating a CSV File**

Use the following format to create the CSV file with the standard values.

```
#Comment
Group name, log address A name, log address B name...
OFFSET, logging start time
Time 1, address A data 1, address B data 1, ...
Time 2, address A data 2, address B data 2, ...
```

**Note**

- ◆ A comment can be inserted in the first line of the file. When inserting a comment, put a hash mark (#) directly in front of it.
- ◆ When the logging start time is omitted, it will appear on the graph as January 1, 1970 0 (h) 0 (m) 0 (s).
- ◆ When editing in Excel, set the cell format for the time to "Text."

1. Start the spreadsheet software (commercially available).
2. Enter the time on the vertical axis, the address on the horizontal axis, and the standard data, as shown in the diagram.
  1. For a sampling cycle of 0.5 s.

```
#Group 1 standard data
Group 1, Serial A: DM00000
OFFSET, 2004/06/21 10:00:00.000
00:00:00.000,0
00:00:20.000,60
00:01:10.000,60
00:01:40.000,0
```

2. For a sampling cycle other than 0.5 s.

```
#Group 1 standard data
Group 1, Serial A: DM00000
OFFSET, 2004/06/21 10:00:00
00:00:00,0
00:00:20,60
00:01:10,60
00:01:40,0
```

3. Once the editing has been completed, set the file name to Stddata@ (@: 0 to 9), make sure the extension is "CSV," then save.

## 2-16 Broken-line Graphs

Broken-line graphs are objects that display in graphs current values for multiple consecutive addresses. Up to 256 line graphs can be displayed in one broken-line graph display region.

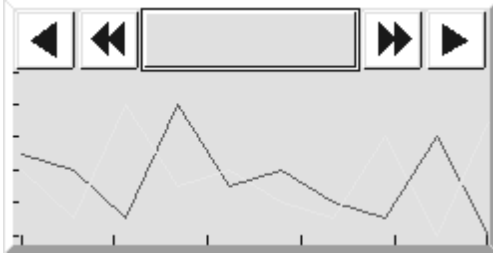

The Batch Read and the History functions can be used when a broken-line graph group is registered.

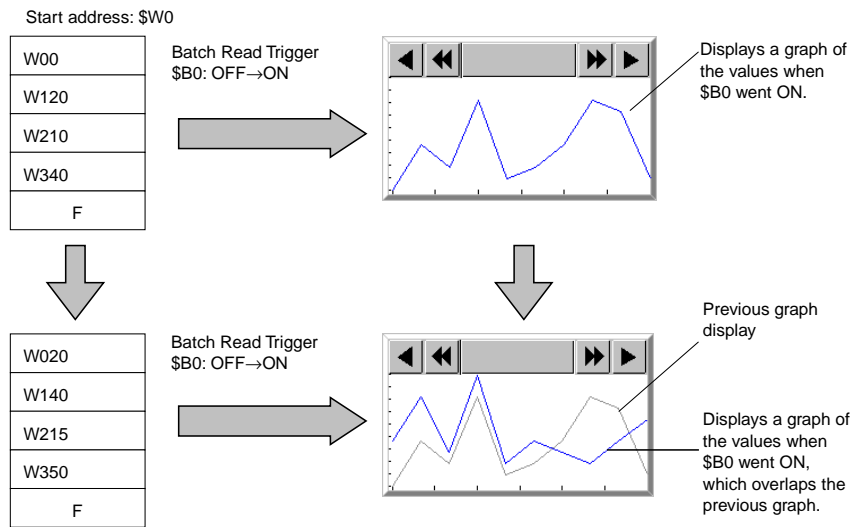

**Note**

- ◆ The following option must be set in advance before using the History function.
  1. Select **PT – System Setting** and open the History Tab Page.
  2. Select the **Hold data of broken-line graph history** Option and click the **OK** Button.

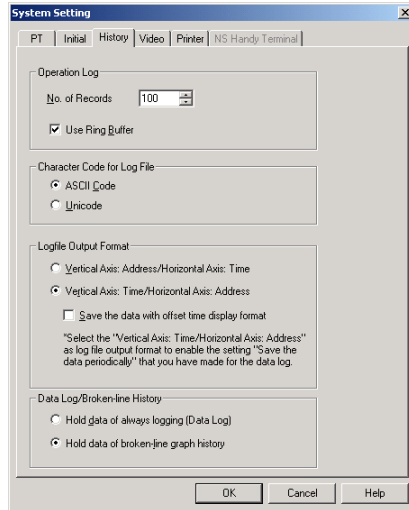

- ◆ When the “broken-line graph history” function is being used, the “always logging” Data Log function cannot be used.
- ◆ Data will not be read if the Batch Read trigger address goes ON when the displayed screen does not contain a broken-line graph.

**Registering Broken-line Graph Groups**

A broken-line graph group must be registered when using the Batch Read and History functions. Select **PT – Broken-line Graph Group Setting** to display the Broken-line Graph Group List Window. This window can be used to add a new broken-line graph group, edit a group’s settings, delete a group, and verify group settings.

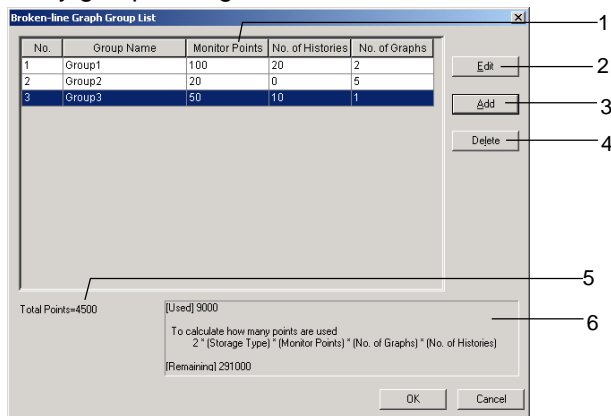

**NS Series Programming Manual**

No.	Item	Details
1	Group List	Lists the registered broken-line graph groups.
2	Edit	To edit a registered broken-line graph group, select the row containing the desired group and click the <b>Edit</b> Button. The Broken-line Graph Group Setting Dialog Box will be displayed. For details on editing the settings, refer to <i>Making Broken-line Graph Group Settings</i> .
3	Add	To add a broken-line graph group, click the <b>Add</b> Button. The Broken-line Graph Group Setting Dialog Box will be displayed. For details on adding settings, refer to <i>Setting a Broken-line Graph Group</i> . Up to 16 groups can be registered in a project.
4	Delete	To delete a registered broken-line graph group, select the row containing that group and click the <b>Delete</b> Button.
5	Total Points	Displays the total number of points set in the broken-line graph history.
6	Used/Remaining Memory	Displays the number of used bytes and remaining bytes. For details, refer to <i>Calculating the Amount of Broken-line Graph History Being Used</i> below.

**Setting a Broken-line Graph Group**

The following Broken-line Graph Group Setting Window will be displayed when the Add or Edit Button is clicked in the Broken-line Graph Group List Window.

This window can be used to add a new group or edit a registered group.

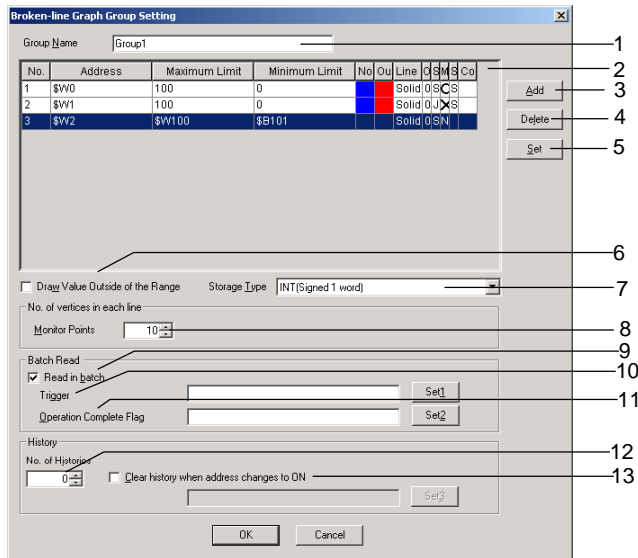

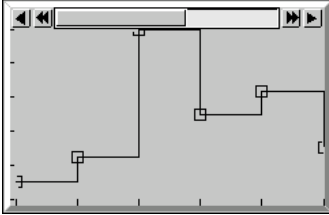
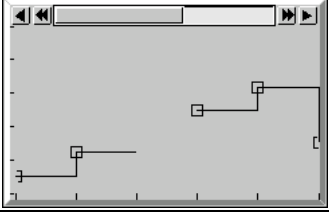
No.	Item	Details
1	Group name	Sets the name of the broken-line graph group (up to 32 characters long; both one-byte and two-byte are counted as one character).
2	Graph line list	Lists the graph lines registered in the broken-line graph group.
3	Add	To add a graph line, click the <b>Add</b> Button. The Line Setting (Broken-line Graph Group) Dialog Box will be displayed. For details on adding a line, refer to <i>Line Setting (Broken-line Graph)</i> . Up to 256 lines can be set in a group.
4	Delete	To delete a graph line, select the row containing that line and click the <b>Delete</b> Button.
5	Set	To change a registered graph line's settings, select the row containing the desired line and click the <b>Set</b> Button. The Line Setting (Broken-line Graph Group) Dialog Box will be displayed. For details on editing a line, refer to <i>Line Setting (Broken-line Graph)</i> .
6	Draw Value Outside of the Range	<p>The following diagrams show the display when <i>Draw the value outside of range</i> is selected.</p> <p><i>Draw the value outside of range</i> selected: Values outside the range will be displayed at the top of the graph.</p>  <p><i>Draw the values outside of range</i> not selected: Values outside the range will not be displayed.</p> 
7	Storage Type	Select the storage format from the pull-down list on the right. For details, refer to 2-8-4 <i>Numeral Display and Storage Type (General Tab)</i> .
8	Monitor Points	Sets the number of points to monitor in the broken-line graph.
9	Read in batch	Select this option when performing batch reads. If this option is not selected the broken-line graph will always display the present value.
10	Trigger	A batch read is performed when the specified communications address goes from OFF to ON.
11	Operation Complete Flag	Sets the address that will be turned ON by the system when the batch read is completed.
12	No. of Histories	Sets the number of graphs to be retained in the broken-line graph history. When this value is set to 0, history data is not retained. When the number of saved graphs exceeds this set value, the oldest history data will be deleted.
13	Clear history when address changes to ON	The history data will be cleared when the specified communications address goes from OFF to ON.

**Note**

- ◆ If the displayed screen does not contain a broken-line graph, data will not be read when the batch read *Trigger* address goes ON and data will not be cleared when the *Clear history when address changes to ON* address goes ON.
- ◆ The *Operation Complete Flag* is not turned OFF automatically. This flag must be turned OFF from a user screen or the PLC.
- ◆ When the *No. of Histories* is set to 1 or higher, the most recent graph and the specified number of previous graphs are displayed in the broken-line graph. When the *No. of Histories* is set to 0, only the most recent graph is displayed in the broken-line graph.

Example:

No. of Histories	Displayed graphs	Graph data retained in history
2	Most recent graph and the last graph	The most recent graph's data and the last graph's data are retained. (Data for two graphs is retained.)
1	Only the most recent graph	The most recent graph data is retained.
0	Only the most recent graph	No graphs are retained.

**Line Setting (Broken-line Graph)**

The Line Setting (Broken-line Graph Group) Window will be displayed when the Add or Set Button is clicked in the Broken-line Graph Group Setting Window.

Use this window to make the settings for the broken-line graph's lines.

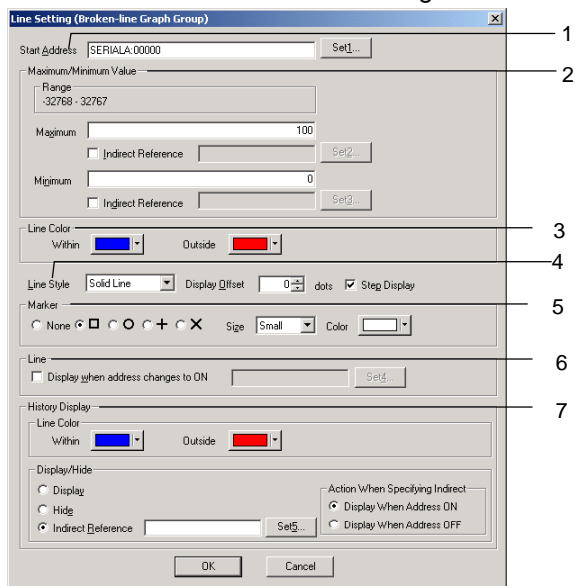

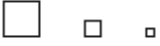
No.	Setting	Details
1	Start address	Sets the start address referenced for the data.
2	Maximum and minimum values	Sets the maximum and minimum values for graph display. If maximum and minimum values are set, the color of the graph lines can be set to change when these values are exceeded. If Indirect reference is set, the maximum and minimum values can be specified by the contents of an address.
	Maximum	Sets the upper limit.
	Minimum	Sets the lower limit.
3	Line color	Select the line color (from a choice of 256 colors) under the Set Button. The color can be changed depending on whether or not the set upper and lower limits have been exceeded.
4	Line style	Select from the five line types listed below. Solid line, dotted line, broken line, 1-dot chain line, or 2-dot chain line
	Display offset	Displays the broken-line graph in an offset position, where a specified offset (number of dots) have been added to the position for the present value.
	Step display	If step display is used, the origin is shown connected by vertical and horizontal lines.
5	Marker	Selects one of the following five markers to be displayed at the peaks. None, □, ○, +, or ×
	Size	Selects large, middle, or small for marker size. The sizes are shown below. Large Medium Small 
	Color	Set the marker's color (from 256 available colors).
6	Display when address changes to ON	When this option is selected, the graph line will be displayed while the specified communications address is ON.
7	History Display	Makes settings related to the history lines.
	Line Color	Sets the color of the history lines (from 256 available colors). Different colors can be displayed for lines within the maximum and minimum values and lines outside of the range.
	Display/Hide	Sets whether to display or hide the history lines. The Display/Hide setting can be specified indirectly by specifying an address in the <i>Indirect Reference</i> Field and turning that address ON/OFF.

### Calculating the Amount of Broken-line Graph History Being Used

The amount of the broken-line graph history being used can be calculated for each group with the following equations.

Bytes used by 1 group = 2 × Storage type (see note) × Monitor points × No. of graphs × No. of Histories

Note: Use a multiplier of 1 for 1-word storage formats and a multiplier of 2 for 2-word storage formats.

Example: Broken-line graph group with the following settings

	Storage format	Monitor points	No. of graphs	No. of histories
Group 1	INT	10	2	10
Group 2	DINT	20	5	5

Bytes used =  $(2 \times 1 \times 10 \times 2 \times 10) + (2 \times 2 \times 20 \times 5 \times 5) = 400 + 4,000 = 4,400$  bytes

Use the following equation to calculate the number of bytes remaining:

Remaining bytes = 300,000 – bytes used

From the equation above:

Remaining bytes = 300,000 – 4,400 = 296,000 bytes

## Settings for Functional Object Properties

This section describes the settings in the Functional Object Properties Dialog Box for broken-line graphs.

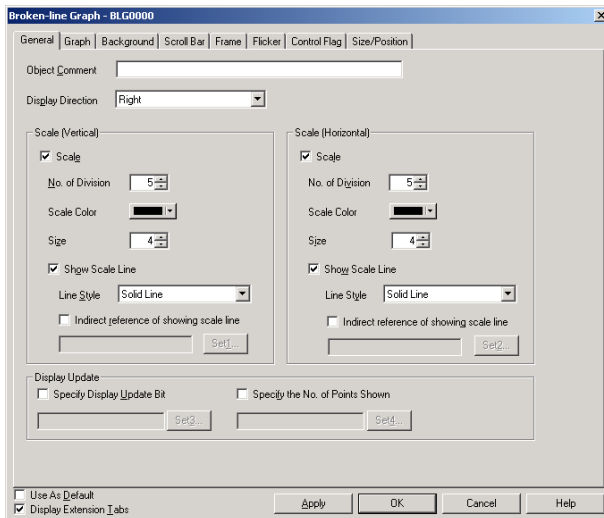

- General: Sets the display direction and gradation lines for broken-line graphs.
- Graph: Registers the start address for monitoring, the number of points, and the type of lines.
- Background: Sets the base color for broken-line graphs.
- Scroll bar: Sets the scroll bar size and scroll width.
- Frame: Sets the frame display for broken-line graphs.
- Flicker: Sets the flicker display. (See note.)
- Control flag: Sets display/no display and input enabled/disabled for broken-line graphs. (See note.)
- Size/position: Sets the object size and position. (See note.)

Note: These tabs are displayed when *Display Extension Tabs* Option is selected.



**NS Series Programming Manual**

**General Tab Page**

Sets the display direction and gradations for broken-line graphs.

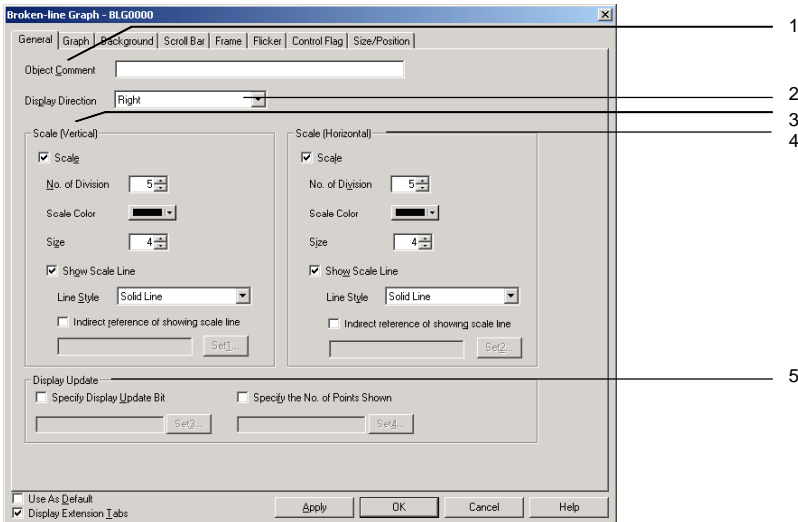

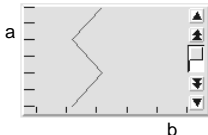
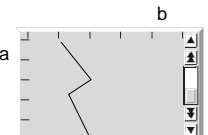
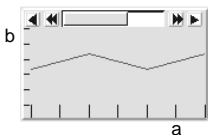
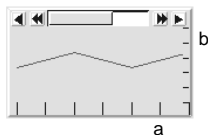
No.	Setting	Details												
1	Object Comment	Sets an explanatory comment for the pasted object (up to 32 characters).												
2	Display direction	<p>Select a display direction of <i>Up</i>, <i>Down</i>, <i>Left</i>, or <i>Right</i>. The axis for showing the number of graph points monitored (indicated by <i>a</i> in the diagram) and the axis for showing the values for each graph point (indicated by <i>b</i> in the diagram) depends on the set display direction.</p> <ul style="list-style-type: none"> <li>• Up                      </li> <li>• Down                      </li> <li>• Left                      </li> <li>• Right                      </li> </ul>												
3	Scale (Vertical)	<p>Sets whether or not scales will be used on axes showing the number of graph points being monitored.</p> <table border="1"> <tr> <td>No. of division</td> <td>Sets the number of division between 1 and 99.</td> </tr> <tr> <td>Scale color</td> <td>Sets the scale color (from 256 available colors).</td> </tr> <tr> <td>Size</td> <td>Sets the length of the scale between 4 and 32 (dots).</td> </tr> <tr> <td>Show Scale Line</td> <td>Sets whether or not to display the scale.</td> </tr> <tr> <td>Line style</td> <td>Select from the five line types listed below. Solid line, dotted line, broken line, 1-dot chain line, or 2-dot chain line</td> </tr> <tr> <td>Indirect reference of showing scale line</td> <td>If this option is selected the scale is displayed when the specified address is ON.</td> </tr> </table>	No. of division	Sets the number of division between 1 and 99.	Scale color	Sets the scale color (from 256 available colors).	Size	Sets the length of the scale between 4 and 32 (dots).	Show Scale Line	Sets whether or not to display the scale.	Line style	Select from the five line types listed below. Solid line, dotted line, broken line, 1-dot chain line, or 2-dot chain line	Indirect reference of showing scale line	If this option is selected the scale is displayed when the specified address is ON.
No. of division	Sets the number of division between 1 and 99.													
Scale color	Sets the scale color (from 256 available colors).													
Size	Sets the length of the scale between 4 and 32 (dots).													
Show Scale Line	Sets whether or not to display the scale.													
Line style	Select from the five line types listed below. Solid line, dotted line, broken line, 1-dot chain line, or 2-dot chain line													
Indirect reference of showing scale line	If this option is selected the scale is displayed when the specified address is ON.													
4	Scale (Horizontal)	<p>Sets whether or not scales will be used on axes showing the number of graph points.</p> <table border="1"> <tr> <td>No. of division</td> <td>Sets the number of division between 1 and 99.</td> </tr> <tr> <td>Scale color</td> <td>Sets the scale color (from 256 available colors).</td> </tr> <tr> <td>Size</td> <td>Sets the length of the scale between 4 and 32 (dots).</td> </tr> <tr> <td>Show Scale Line</td> <td>Sets whether or not to display the scale.</td> </tr> <tr> <td>Line style</td> <td>Select from the five line types listed below. Solid line, dotted line, broken line, 1-dot chain line, or 2-dot chain line</td> </tr> <tr> <td>Indirect reference of showing scale line</td> <td>If this option is selected the scale is displayed when the specified address is ON.</td> </tr> </table>	No. of division	Sets the number of division between 1 and 99.	Scale color	Sets the scale color (from 256 available colors).	Size	Sets the length of the scale between 4 and 32 (dots).	Show Scale Line	Sets whether or not to display the scale.	Line style	Select from the five line types listed below. Solid line, dotted line, broken line, 1-dot chain line, or 2-dot chain line	Indirect reference of showing scale line	If this option is selected the scale is displayed when the specified address is ON.
No. of division	Sets the number of division between 1 and 99.													
Scale color	Sets the scale color (from 256 available colors).													
Size	Sets the length of the scale between 4 and 32 (dots).													
Show Scale Line	Sets whether or not to display the scale.													
Line style	Select from the five line types listed below. Solid line, dotted line, broken line, 1-dot chain line, or 2-dot chain line													
Indirect reference of showing scale line	If this option is selected the scale is displayed when the specified address is ON.													
5	Display update	<p>The broken-line graph display can be updated (refreshed).</p> <table border="1"> <tr> <td>Specify display Update bit</td> <td>Normally, the display is updated whenever a value changes. If <i>Specify display update bit</i> is selected, the display will be updated only when the specified address turns ON.</td> </tr> <tr> <td>Specify the No. of points shown</td> <td>The number of bits from the beginning that will be displayed can be specified.</td> </tr> </table>	Specify display Update bit	Normally, the display is updated whenever a value changes. If <i>Specify display update bit</i> is selected, the display will be updated only when the specified address turns ON.	Specify the No. of points shown	The number of bits from the beginning that will be displayed can be specified.								
Specify display Update bit	Normally, the display is updated whenever a value changes. If <i>Specify display update bit</i> is selected, the display will be updated only when the specified address turns ON.													
Specify the No. of points shown	The number of bits from the beginning that will be displayed can be specified.													

**NS Series Programming Manual**

**Note**

- ◆ Refer to the following diagram for information on scales and scale lines.

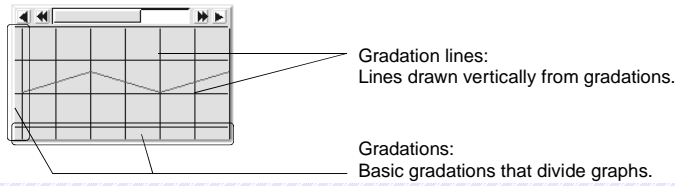

**Graph Tab Page**

Displays a list of information about lines displayed on broken-line graphs. Graph lines can be added, deleted, or set on the Graph Tab Page.

**Displaying Graph Lines Registered in an Individual Graph**

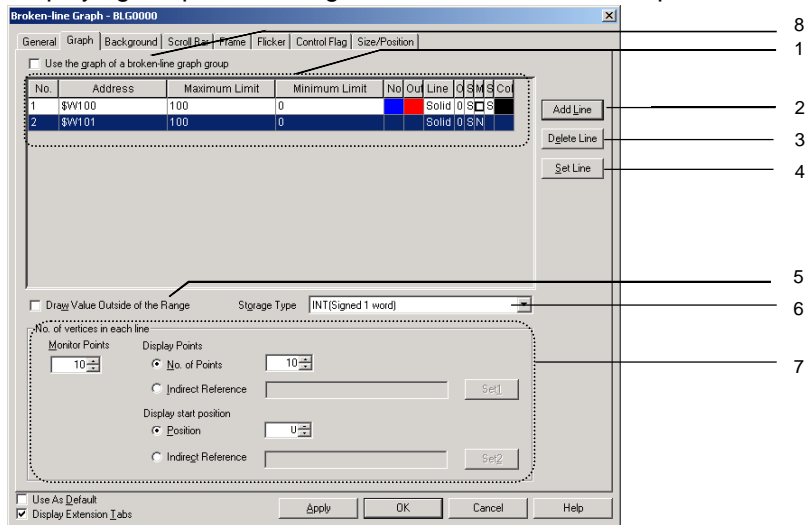

No.	Setting	Details
1	Graph list	Displays a list of the lines that are displayed on currently set graphs. Lines are added, deleted, and set by pressing the <b>Add Line</b> , <b>Delete Line</b> , and <b>Set Line</b> Buttons.
2	Add Line	Adds and registers lines for display on graphs. Press the <b>Add Line</b> Button to display the Line Setting Dialog Box. Refer to <i>Line Setting Dialog Box</i> for further information.
3	Delete Line	Deletes the selected line or lines on the graph list, including the settings information for those lines.
4	Set Line	Sets the line attributes. Select a line on the graph list and press the <b>Set Line</b> Button to display the Line Setting Dialog Box. Refer to <i>Line Setting Dialog Box</i> for further information.

NS Series Programming Manual

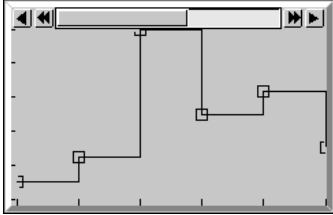
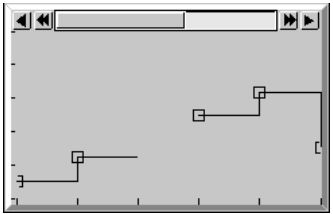
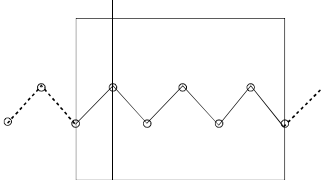
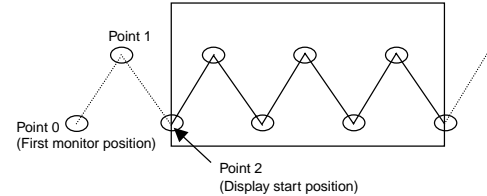
No.	Setting	Details
5	Draw the value outside of range	<p>The following diagrams show the display when <i>Draw the value outside of range</i> is selected.</p> <p><i>Draw the value outside of range</i> selected: Values outside the range will be displayed at the top of the graph.</p>  <p><i>Draw the values outside of range</i> not selected: Values outside the range will not be displayed.</p> 
6	Storage type	<p>Select the storage type from the pull-down list to the right. Refer to <i>Numerical Display and Storage Type</i> under 2-8 <i>Common Functional Object Functions</i> for details.</p>
7	No. of points for each graph line	<p>Sets the number of points monitored on the broken-line graph under <i>Monitor points</i>. Sets the number of points displayed on the broken-line graph object under <i>Display points</i>. (Set a <i>Display points</i> value smaller than the value set to <i>Monitor points</i>.)</p>  <p>No. of display points: 7 No. of monitor points: 9 The two points not displayed can be viewed by scrolling the display down with the Scroll Button.</p> <p>The <i>Display start position</i> sets the broken-line graph's a starting display position. The start position is treated as point 0.</p> <p>Set a display start position that is smaller than the difference of the Monitor Points – Display Points. When the Indirect reference is specified, the value of the specified address is used for the display start position.</p>  <p>Point 1 Point 0 (First monitor position) Point 2 (Display start position) Display start position [2]</p>
8	Use the graph of a broken-line graph group	<p>Leave this option unselected when registering graph lines that will be displayed in an individual broken-line graph. (Select this option when displaying a graph belonging to a broken-line graph group.)</p>

**NS Series Programming Manual**

**Line Setting (Broken-line Graph) Dialog Box**

Sets the line attributes. Press the **Add Line** and **Set Line** Buttons on the Graph Tab Page to display the following dialog box.

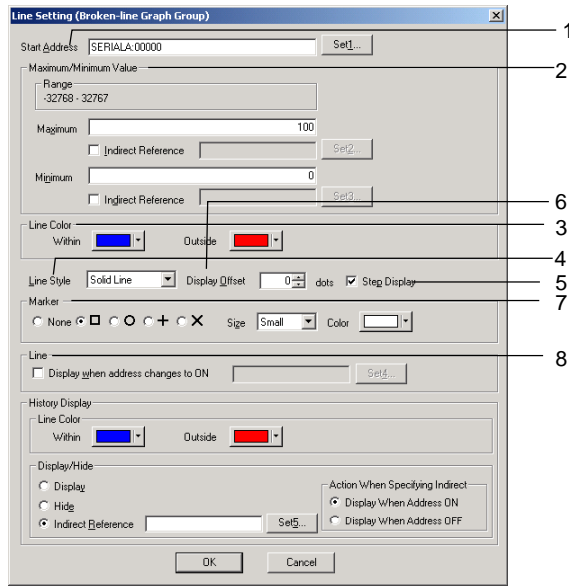

No.	Setting	Details
1	Start address	Sets the start address referenced for the data.
2	Maximum and minimum values	Sets the maximum and minimum values for graph display. If maximum and minimum values are set, the color of the graph lines can be set to change when these values are exceeded. If <i>Indirect reference</i> is set, the maximum and minimum values can be specified by the contents of an address.
	Maximum	Sets the upper limit.
	Minimum	Sets the lower limit.
3	Line color	Sets the line color (from 256 available colors). The color can be changed depending on whether or not the set upper and lower limits have been exceeded.
4	Line style	Select from the five line types listed below. Solid line, dotted line, broken line, 1-dot chain line, or 2-dot chain line
5	Step display	If step display is used, the origin is shown connected by vertical and horizontal lines.
6	Display offset	Displays the broken-line graph in an offset position, where a specified offset (number of dots) have been added to the position for the present value
7	Marker	Selects one of the following five markers to be displayed at the peaks. None, □, ○, +, or ×
	Size	Selects large, middle, or small for marker size. The sizes are shown below. Large Medium Small 
	Color	Select the marker color (from a choice of 256 colors) under the <b>Set</b> Button.
8	Display when address changes to ON	When this option is selected, the graph line will be displayed while the specified communications address is ON.

**NS Series Programming Manual**

**Displaying the Graph of a Broken-line Graph Group**

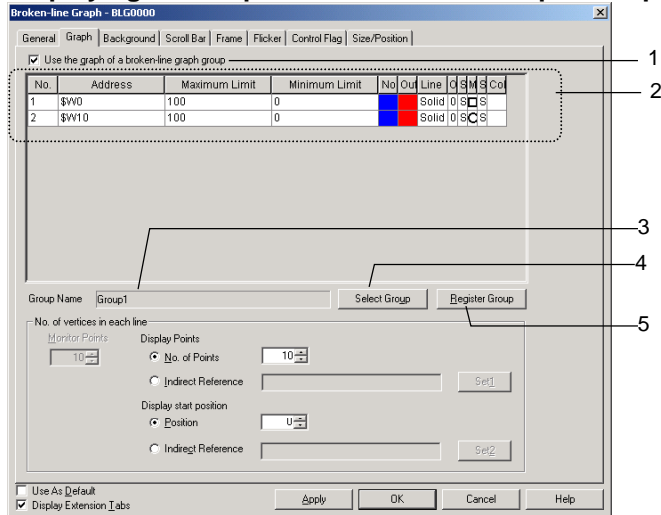

No.	Setting	Details
1	Use the graph of a broken-line graph group	Select this option to display the graph of a broken-line graph group.
2	Graph list	Displays the information about graph lines registered in the displayed broken-line graph group.
3	Group Name	Displays the name of the displayed broken-line graph group.
4	Select Group	Click the <b>Select Group</b> Button to display the Graph Group Selection Window and select the group that will be displayed.
5	Register Group	Click the <b>Register Group</b> Button to display the Broken-line Graph Group List Window. Use this window to add a new broken-line graph group, edit a group's settings, or delete a group.

### Background Tab Page

Sets whether or not the background is tiled. If the background is to be tiled, the background color for broken-line graphs can be selected from 256 colors. Click **Indirect reference of color** to reference the color code stored at a specified address for the background color.

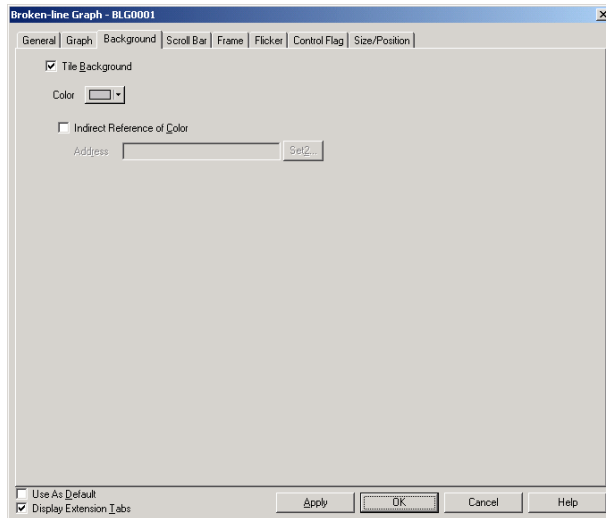

### Scroll Bar Tab Page

Sets display/no display, scroll width, and button size for the graph scroll bar displayed with broken-line graphs.

Refer to *Scroll Bars* under *2-8 Common Functional Object Functions* for details.

### Frame Tab Page (Extension Tab)

Specifies the colors and sizes of the functional object frame to change the shape or color when the broken-line graph is depressed or raised. Refer to *Frames* under *2-8 Common Functional Object Functions* for details.

### Flicker Tab Page (Extension Tab)

Make flicker settings to make the functional object flicker (flash). Refer to *Flicker* under *2-8 Common Functional Object Functions* for details.

### Control Flag Tab Page (Extension Tab)

Control flags can control the display of and input to functional objects. Use control flags to enable display or control input when the contents of an address turn ON or OFF. Refer to *Control Flags* under *2-8 Common Functional Object Functions* for details.

### Size/Position Tab Page (Extension Tab)

Displays and sets the functional object size and position. Refer to *Size/Position* under *2-8 Common Functional Object Functions* for details.

## 2-17 Data Blocks

### 2-17-1 What Is a Data Block?

Data blocks (recipes) enable reading/writing values and character strings from/to memory areas, such as those in a PLC. Data blocks can be used to easily change the setup of the system. Create the data in a CSV file and store it in the PT beforehand. This data can be changed while operating the PT.

Example: Setting width (numeric value), height (numeric value), and color (character string) in the PLC. (Refer to the figure shown below.)

Set width: 150, height: 54, and color: blue for product B. Just select product B to set these three items in the PLC. If product A is selected, a width of 100, a height of 52, and a color of red are set in the PLC.

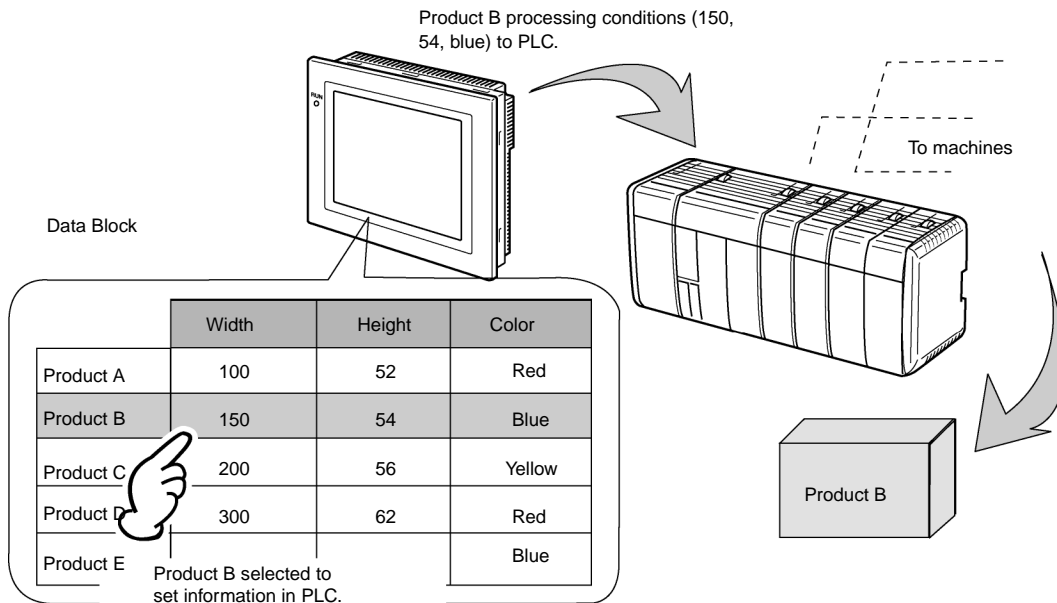

Using data blocks, users do not need to save data in the PLC beforehand, so that the memory of the PLC can be saved and the ladder program can be reduced. Data blocks also have the following features.

- Data in CSV format can be edited and managed on a computer.
- Data can be edited on the PT.
- Data can be written to a Memory Card.
- Data from read from a Memory Card.
- Processes values and character strings can be handled.
- Maximum number of rows: 1,000. Maximum number of columns: 500. Data blocks with both 1,000 rows and 500 columns, however, cannot be set.

Refer to *Restrictions on Data Blocks* on page 2-387 for details.

**NS Series Programming Manual**

A data block consists of records and fields. The address and data format are set for each field. A record is a group of fields.

	Field A Communications address Data type	Field B Communications address Data type	Field C Communications address Data type
Record 1			
Record 2			
Record 3			
Record 4			

Conditions, such as the widths and heights shown below, are called fields, and the group of data for product B is called a record.

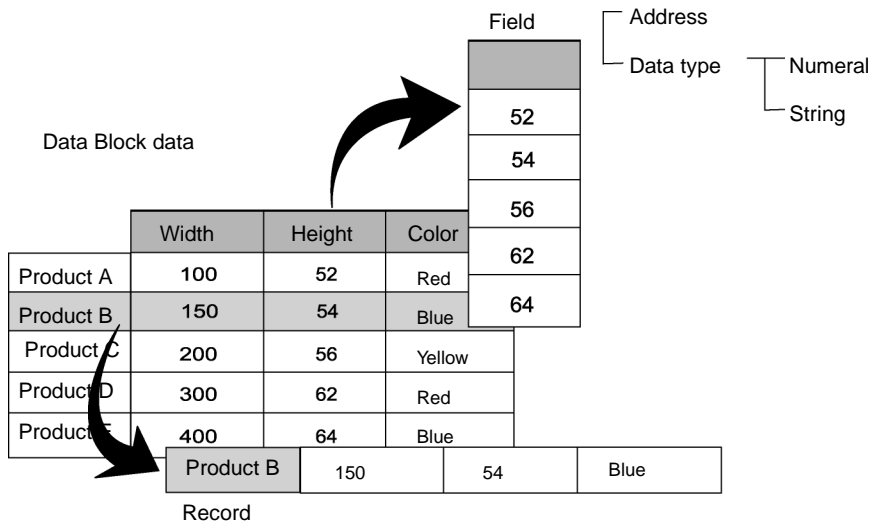

To set data from a data block in the PT to the PLC, select the record from the data block and write it to PLC. When writing to the PLC, fields are written in order one at a time from the beginning of the record. Therefore, it takes time to write the values for all fields.

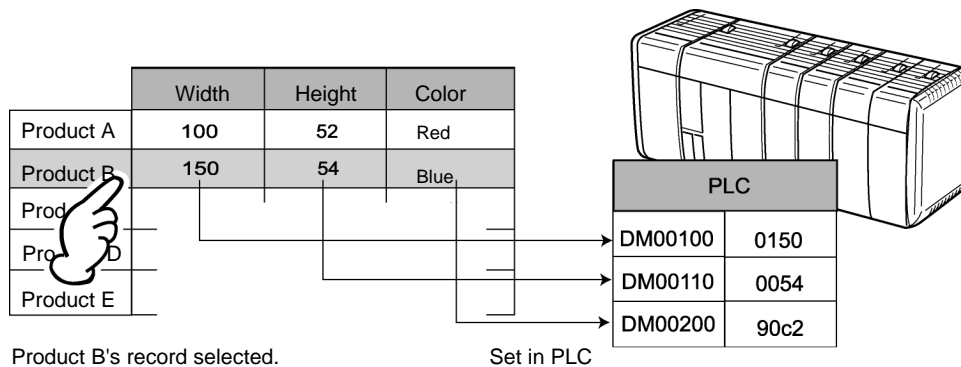



**NS Series Programming Manual**

**Procedures for Data Blocks**

There are two methods that can be used to transfer, display, and edit recipe data: manipulate the data in the data block or combine functional objects, such as command buttons and Numeral Display & Input objects.

**Manipulating Data Block Data**

Use the following procedure to transfer, display, and edit recipe data by manipulating the data in the data block.

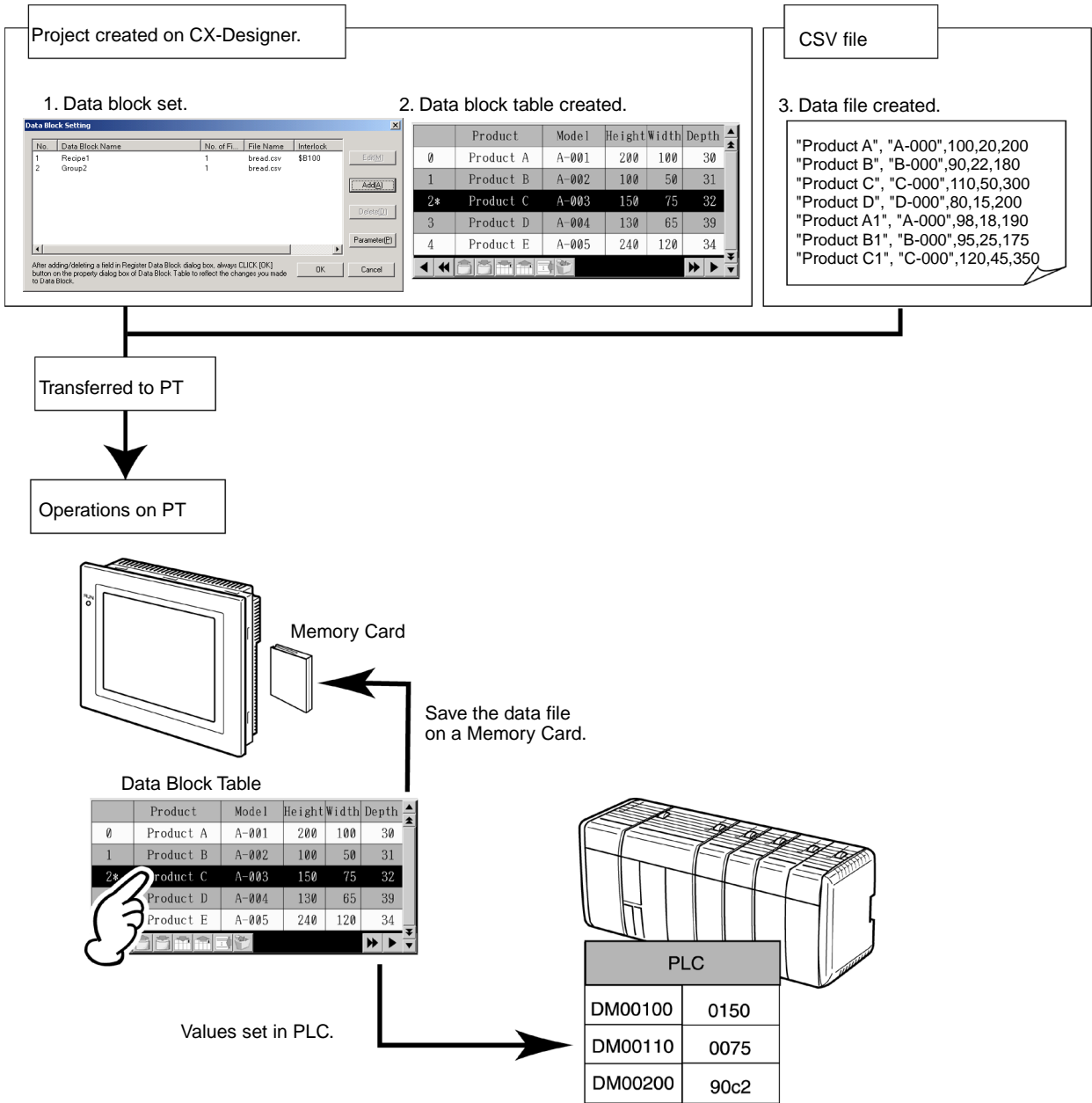

No.	Item	Contents	See
1	Data Block Setting	Sets the data format and address for the field, and the number of records.	Setting Data Blocks
2	Data Block Table	Shows the data block, and sets the selected data for each address.	Data Block Table
3	Data File	Shows the data in the data block.	Creating Data Files

**NS Series Programming Manual**

**Combining Functional Objects**

Use the following procedure to transfer, display, and edit recipe data by combining functional objects, such as command buttons and Numeral Display & Input objects.

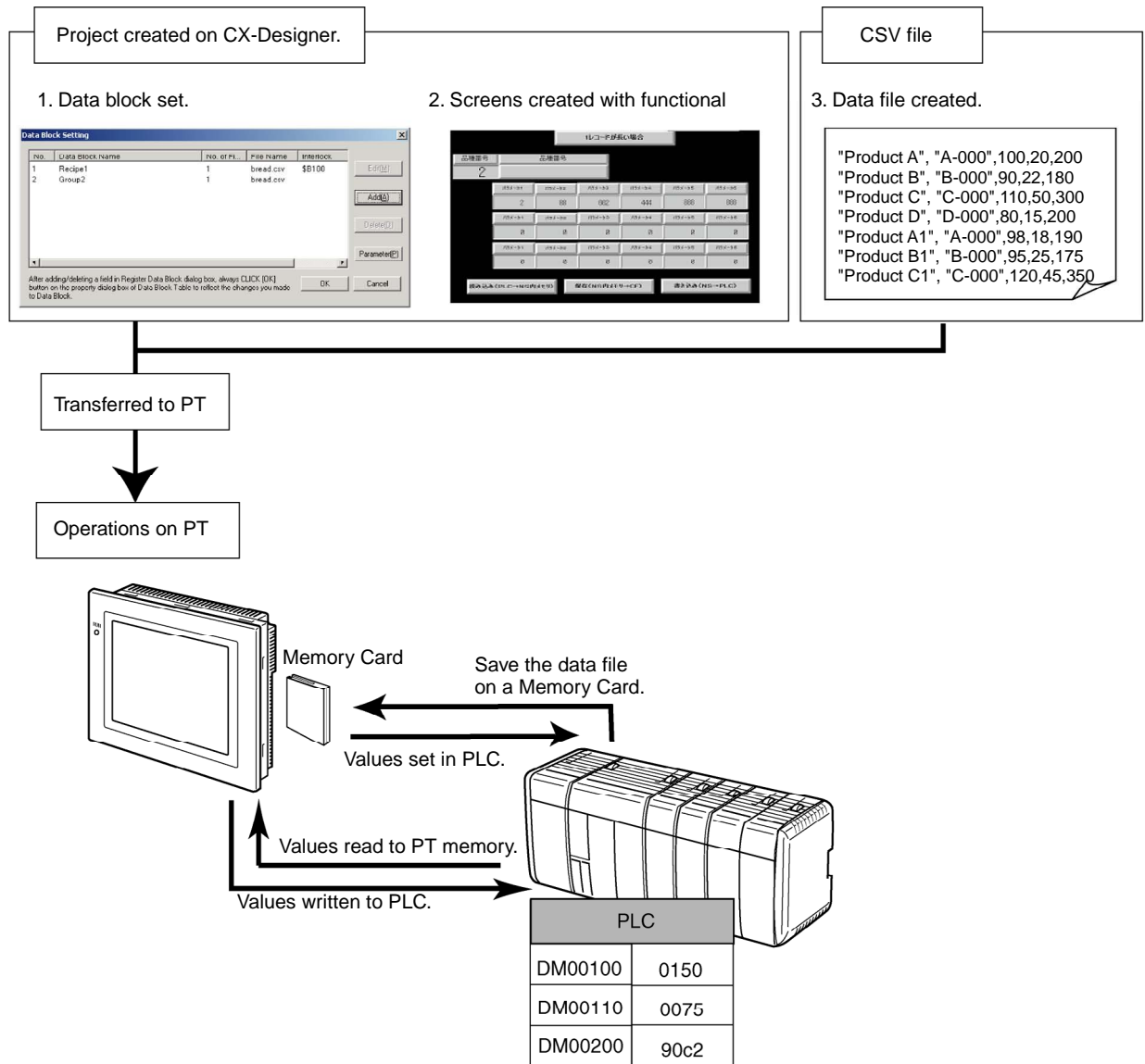

No.	Item	Contents	See
1	Data Block Setting	Sets the data format and address for the field, and the number of records.	Setting Data Blocks
2	Creating Screen with Functional Objects, such as Command Buttons	Sets communications addresses for specified data and creates screens to edit data file.	Using Data Blocks
3	Data File	Shows the data in the data block.	Creating Data Files

**Reference**

◆ Either the data block settings and the data block table can be created on the CX-Designer first, or the data file can be created first. The following items, however, must correspond.

- Number of fields • Data format • Number of records

Refer to the relating parts of this manual for items set on the CX-Designer and the data file setting first, and then make the settings.

## Setting Data Blocks

This section explains the settings required for data blocks. Set the number of fields, the field labels, and the data format for each field.

### Setting Data Blocks

Select **PT - Data Block Setting**.

The Data Block Setting Dialog Box will be displayed. Data blocks can be added, edited, and deleted using this dialog box.

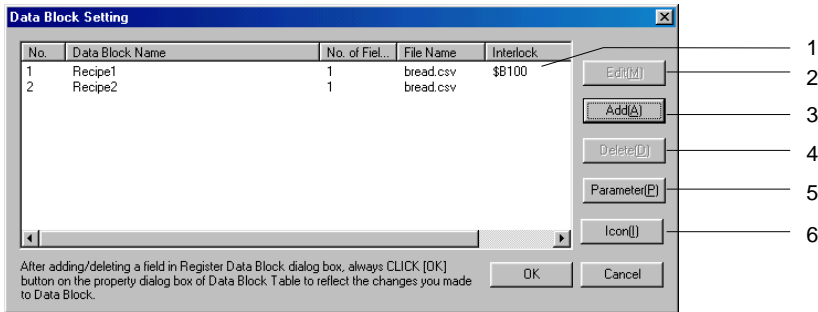

No.	Item	Details
1	Data block list	Lists the registered data blocks. Select the data block from the list to edit or delete it.
2	Edit Button	Edits the data block selected from the list. Click the <b>Edit</b> Button to display the Register Data Block Dialog Box.
3	Add Button	Creates a new the data block. Click the <b>Add</b> Button to display the Register Data Block Dialog Box. Up to 100 data blocks can be created.
4	Delete Button	Deletes the selected data block from the list. A confirmation dialog box will be displayed when the Delete Button is clicked. Click the <b>Yes</b> Button to delete.
5	Parameter Button	Selects the character code to use in the data file. A data block parameter setting dialog box will be displayed when the <b>Parameter</b> Button is selected, enabling selection of the character code between multibyte and Unicode.
6	Icon Button	Specifies a bitmap or JPEG file for the icon. The Details Dialog Box is displayed.

**NS Series Programming Manual**

### Registering Data Blocks

The items set in the Data Block Registration Dialog Box are described in the following table.

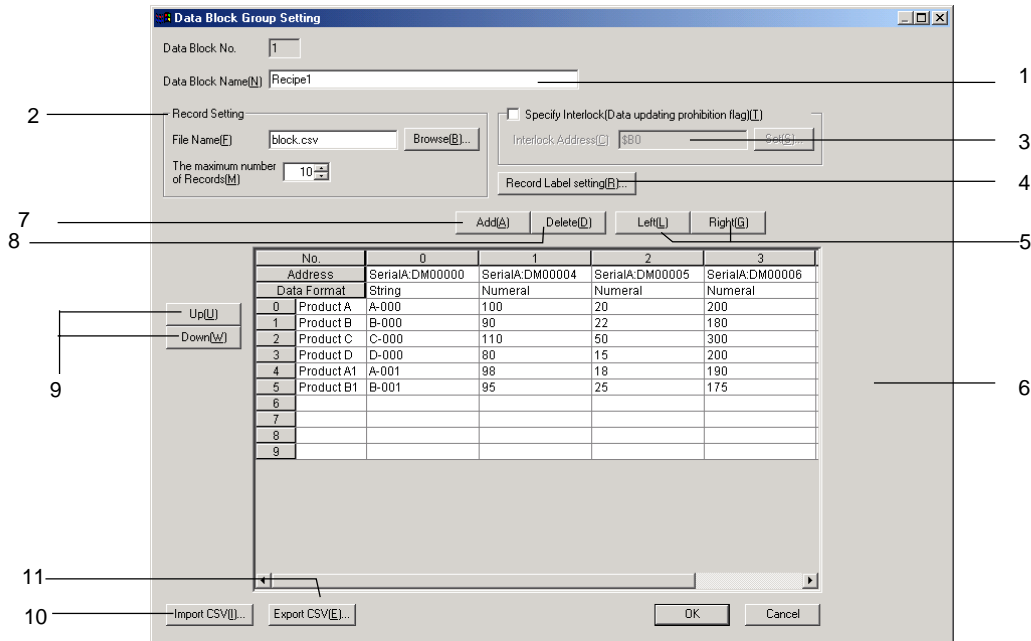

No.	Item	Details
1	Data block name	Sets the name of the data block. (32 characters max.). The name set here will be displayed in the data block list in the Data Block Setting Dialog Box.
2	Record setting	Specifies the CSV-format data file related to the data block.
	File name	File name (8 characters max. plus file name extension .csv) Alphanumeric characters, underscores (_), dollar signs (\$), and periods (.) can be used in the file name.
	The maximum number of Records	Sets the maximum number of records in the data block. Up to 1,000 records can be created. Refer to <i>Restrictions on Data Blocks</i> on page 2-387 for details.
3	Specify Interlock (Data updating prohibition flag)	Writing to the CSV file from the data block can be enabled and disabled. If this option is selected, writing to the CSV file will be disabled when the communications address set for the interlock address is ON.
4	Record label setting	Specifies the number of characters and the stored character format for record labels. Refer to <i>Setting Record Labels</i> for details.
5	Left/Right	Moves the selected field left or right.
6	Recipe data list	Lists the file name, data type, communications address, and recipe data. The data can also be edited. Double-click a field to display the Field Setting Dialog Box and change the field settings.
7	Add Button	Adds a field to the right of the currently selected field. Up to 500 fields can be created. Refer to <i>Restrictions on Data Blocks</i> on page 2-387 for details.
8	Delete Button	Deletes the currently selected field.
9	Up/Down	Moves the selected record up or down.
10	Import CSV	Reads recipe data from the specified CSV file.
11	Export CSV	Exports the edited recipe data to a specified CSV file.

**Note**

- ◆ The **Delete** Button deletes the selected field only. Multiple fields cannot be deleted at the same time.
- ◆ You cannot add more records than the maximum number of records on the PT.
- ◆ Always specify the data file. The PT automatically reads data file when displaying data blocks. If data file set in the data block setting does not exist, the following message will be displayed.  
*Although the data block table exists on the screen, failed to read CSV file to display in the data block table.*  
*[Data Block (X) CSV File] The object will not be displayed correctly.*

**Field Settings**

This section explains the properties in the Field Setting Dialog.

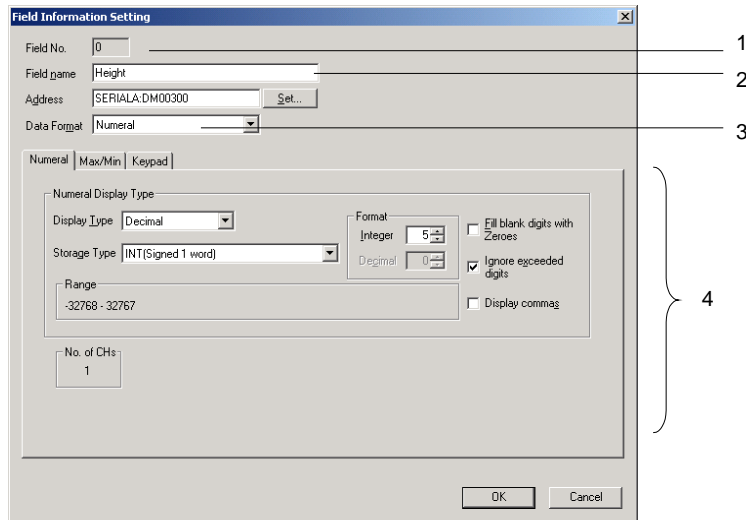

No.	Item	Details
1	Field Name	Sets the field name (up to 32 characters).
2	Address	Sets the destination address to read and write for the field.
3	Data Format	Sets the data format for the field. The following types can be set. <ul style="list-style-type: none"> <li>• Numeral</li> <li>• String</li> </ul>
4	Detailed Setting	Displays items for each data format. Refer to the next page for details.

## Detailed Settings by Data Format

This section explains items set for each data format.

### Numeral Data

When selecting numeral data for the data format, set the following items.

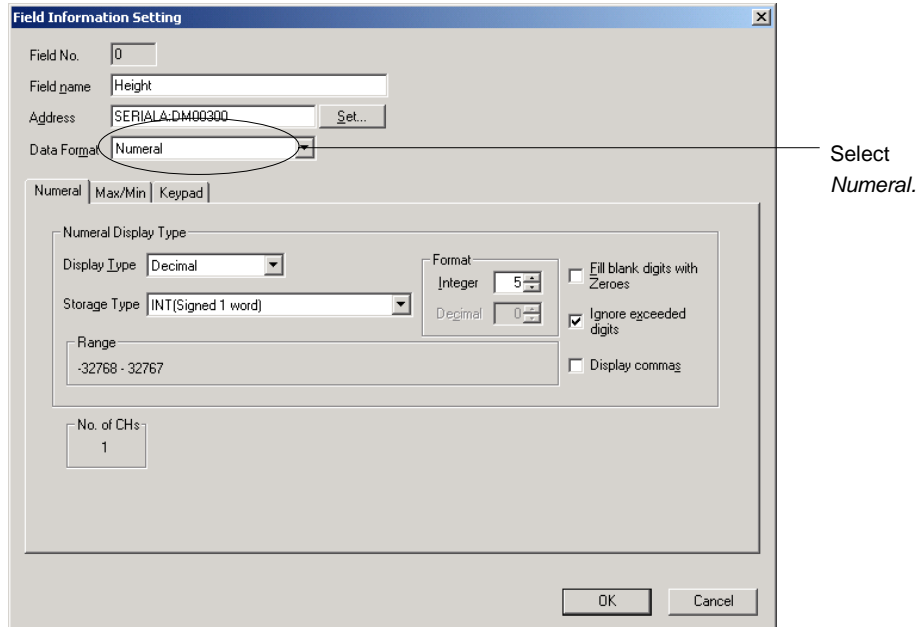

**Numeral:** Sets the storage type.

**Max/Min:** Sets the maximum and minimum limits for inputting.

**Keypad:** Sets the input method, and the display position and size of the keypad.

The detailed settings for each tab page are the same as for Numeral Display & Input objects. Refer to *2-12 Display and Input Objects* for details.

#### Note

- ◆ The item *Other Input Method (command button etc.)* does not appear on the Keypad Tab Page of the Field Setting Dialog Box for Data Block Tables.

### String Data

When selecting string data for the data format, set the following items.

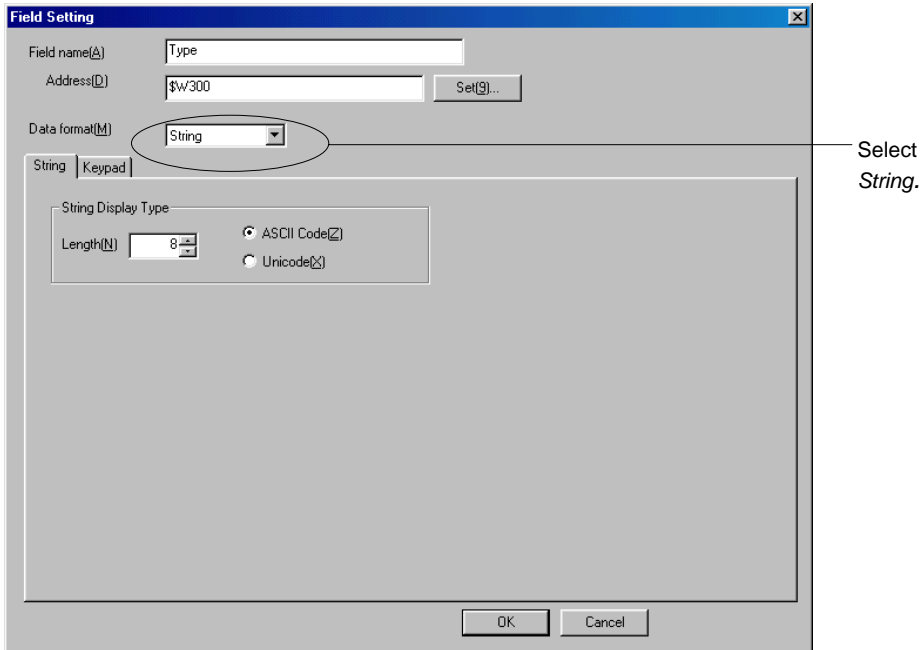

String: Sets the display format.

Keypad: Sets the input method, and the display position and size of the keypad.

The detailed settings for each tab page are the same as for Numeral Display & Input objects. Refer to 2-12 *Display and Input Objects* for details.

#### Note

- ◆ The item *Other Input Method (command button etc.)* does not appear on the Keypad Tab Page of the Field Setting Dialog Box for Data Block Tables.

### Record Label Setting

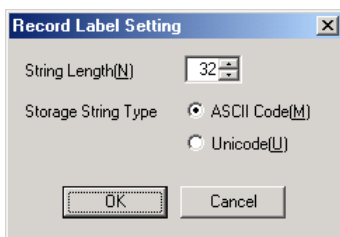

No.	Item	Details
1	String Length	Sets the number of valid characters for record labels (1 to 32).
2	Storage String Type	Selects one of the following as the storage type for record labels in PT memory. ASCII code Unicode

## Restrictions on Data Blocks

There are restrictions for setting data blocks. Make settings within the following restrictions.

No.	Item	Restriction	Reference page No.
1	Number of data blocks per project	100 max.	2-382
2	Number of fields per data block.	500 max.	2-383
3	Number of records per data block.	1,000 max.	2-383
4	Data quantity per data block	512 KB max. (for PT system version 8.2 or higher)	2-388

### 1. Number of Data Blocks per Project

Up to 100 data blocks can be set for one project. To add or delete data blocks, display the Data Block Setting Dialog Box, and click the **Add** or **Delete** Button.

Refer to *Setting Data Blocks* on page 2-382 for details.

### 2. Maximum Number of Fields per Data Block

Up to 500 fields can be set per data block. Set the field while confirming the number of fields displayed in the Register Data Block Dialog Box.

Refer to *Setting Data Blocks* on page 2-382 for details.

### 3. Number of Records per Data Block

Up to 1,000 records can be set for one data block. The maximum number of records is set in the Register Data Block Dialog Box.

Refer to *Setting Data Blocks* on page 2-382 for details.

### 4. Data Quantity per Data Block

The maximum data quantity per data block is 512 KB (for PT system version 8.2 or higher).

The maximum data quantity per data block depends on the PT system version.

PT system version	Maximum data quantity per data block
Before version 7.0	100 Kbytes
Version 7.0 to 8.1	500 Kbytes
Version 8.2 or higher	512 Kbytes

Each field requires the following data.

Field		Data quantity
Numeral	Except REAL	4 bytes
	REAL	8 bytes
String	(Each character)	2 bytes



**NS Series Programming Manual**

**Calculating Data Bytes for Data Blocks**

This section explains how to calculate the data quantity for data blocks.

Example:

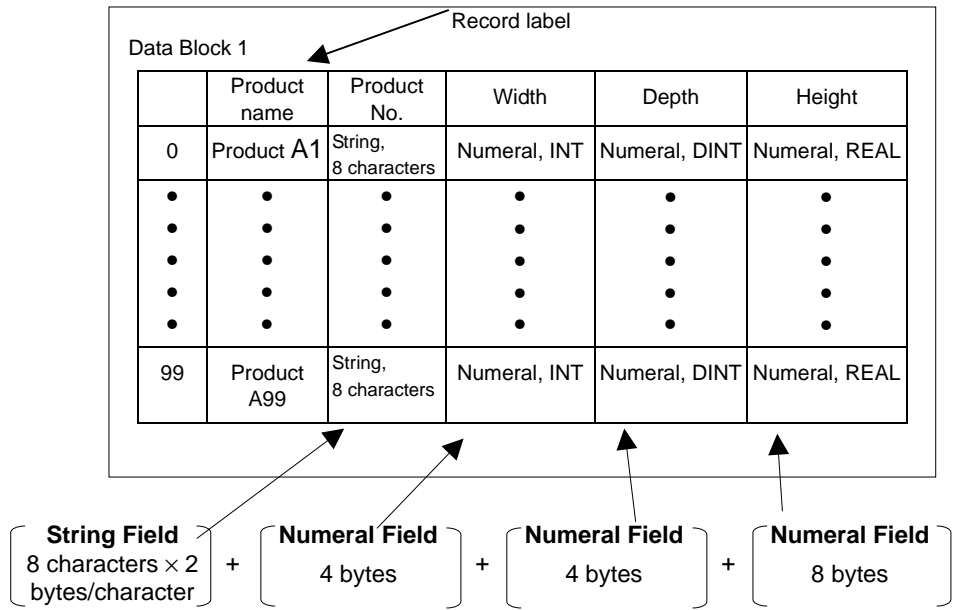

1 record = [8 characters × 2 bytes/character]+[4 bytes]+[4 bytes]+[8 bytes]= 32 bytes

100 records = 32 bytes/record × 100 records = 3,200 bytes

**Reference**

- ◆ The record labels are not calculated in the data quantity. Refer to *Creating Data Files* on page 2-397 for record labels.

### 2-17-2 Data Block Tables

A data block table is a functional object that displays a preset data file as a table and sets the specified data in the PLC.

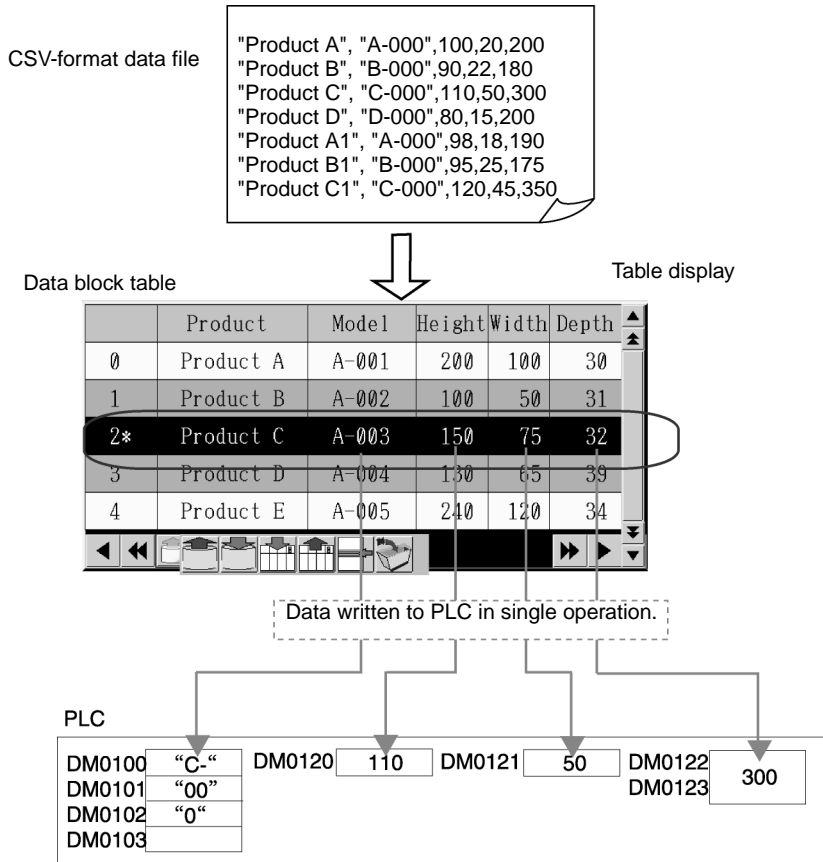

To create the data block table, select **Data Block Table** from the **Functional Objects** Menu or click the  icon.

**Note**

- ◆ Only one data block object can be set for each screen. Data blocks cannot be set for pop-up screens, sheets or inside of frames.

## Setting Data Block Tables

This section explains the properties set for data block tables in the Data Block Table Dialog Box.

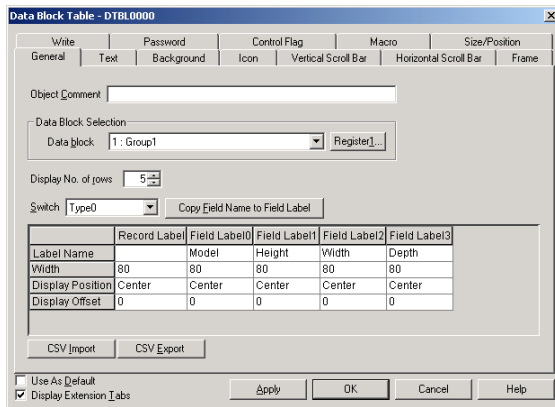

- General:** Sets the data block and display format.
- Text:** Sets the text attribute for displaying numeral and string data.
- Background:** Sets the background color of the data block and the record color.
- Icon:** Sets whether an icon button is displayed at the bottom of the object.
- Vertical Scroll Bar:** Sets the button size and scroll range for the vertical scroll bar.
- Horizontal Scroll Bar:** Sets scroll range for the horizontal scroll bar.
- Frame:** Sets the frame color and size of the data block.
- Write:** Sets the write confirmation message to be displayed when changing field data on the data block. (See note.)
- Password:** Sets the password to be entered when changing field data on the data block. (See note.)
- Control Flag:** Enables and disables input and display. (See note.)
- Macro:** Sets the macro to be executed when setting the field value. (See note.)
- Size/Position:** Sets the size and position of the object. (See note.)
- Note:** These tabs are displayed only when *Display Extension Tabs* is selected.

**NS Series Programming Manual**

**General Tab Page**

Sets the data block and display format.

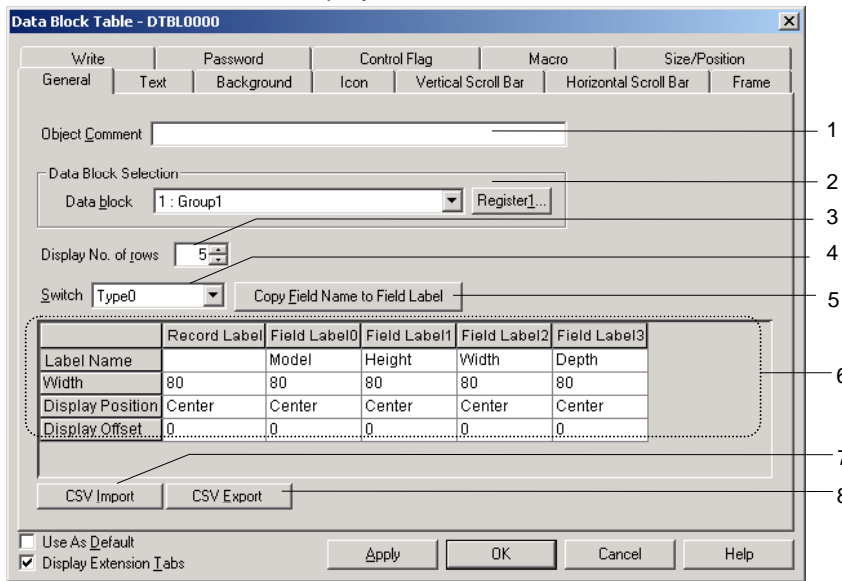

No.	Item	Contents
1	Object Comment	Set an explanatory comment for the pasted object (up to 32 characters).
2	Data Block Selection	Select the data block to be displayed. The Data Block Setting Dialog Box can be displayed by clicking the <b>Register</b> Button. Use this dialog box to create, change, or delete Data Block groups.
3	Display No. of rows	Set the number of columns to display.
4	Switch	Switches the field label.
5	Copy Field Name to Field Label	Copies the field name, which was set in the Data Block Group Setting Dialog Box, to the field label.
6	Field settings	Sets the codes and each field.
	Label Name	Sets a label name of up to 32 characters for the record label and each field label.
	Width	Sets the width for record and field label display to 0 or to between 16 and 800 (dots). If the width is set to 0, the labels will not be displayed.
	Display Position	Sets the horizontal alignment of the text in record or field labels to one of the following. <ul style="list-style-type: none"> <li>• Left</li> <li>• Center</li> <li>• Right</li> </ul> Text attributes other than the horizontal alignment (font, vertical alignment, font color, etc.) are set in the Text Tab Page.
	Display Offset	Sets the offset for the display position of the field label name in dots (0 to 128). The offset is calculated from the leftmost edge of the field label name display area.
7	CSV Import	Reads the label name from the specified CSV file.
8	CSV Export	Exports the current label name to a specified CSV file. Select the character code when exporting data.

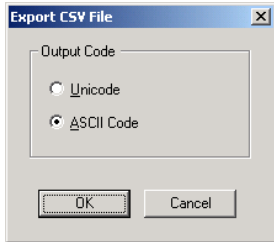

**Note**

- ◆ The number of fields displayed in the data block table is determined by widths of the object and fields. If all fields will not fit in the data block table, they can be displayed by using the horizontal scroll bar.

**Text Tab Page**

Sets the text attributes (font, color, etc for the numeral values and character strings. Refer to 2-8 *Common Functional Object Functions – Text Attributes* for details.

**Note**

- ◆ The offset and display position set in the Field Label Setting Dialog Box will be reflected in numeral field and string field. The horizontal position set on the Text Attribute Tab Page will not be reflected.

**Background Tab Page**

Sets the background color of the object and the record color. To fill the record, click the **Set** Button to display the Color Setting Dialog Box and select the color for the record.

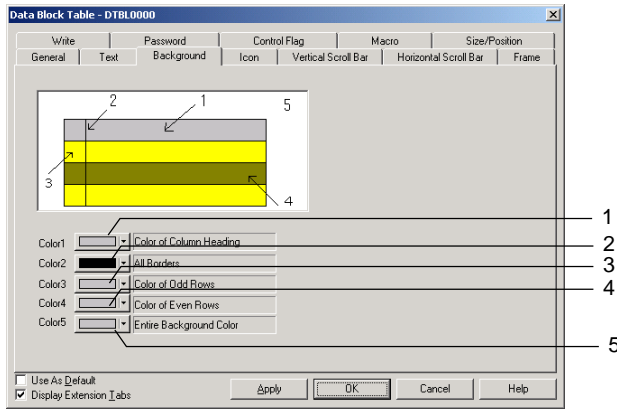

**Example:**

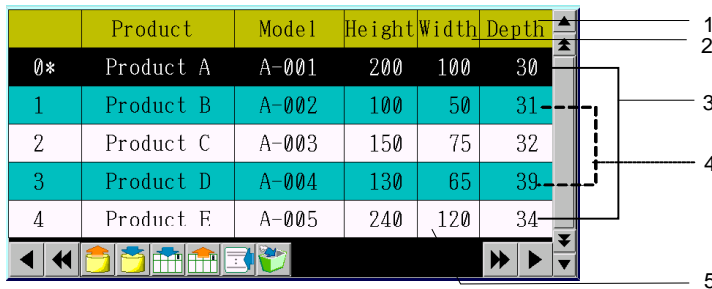

The selected line is displayed in reverse video.

No.	Item	Details
1	Color of Top Column	Sets background color of the column header.
2	All borders	Sets entire border color.
3	Color of Odd Columns	Sets background color of odd columns.
4	Color of Even Columns	Sets background color of even columns.
5	Entire background Color	Sets background color except for field label name and record data display areas.





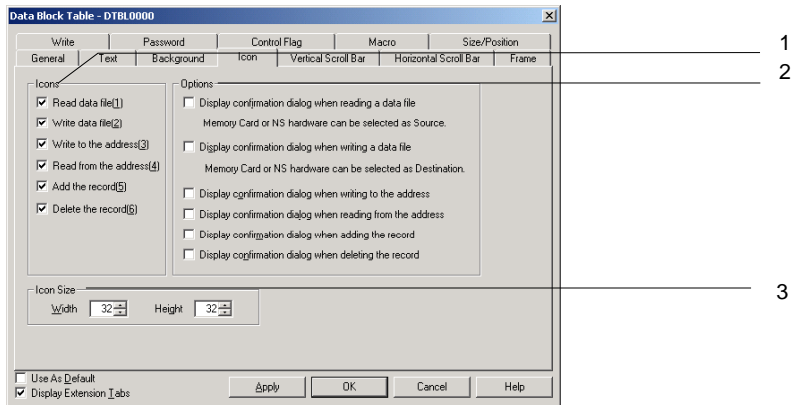

Refer to 2-8-7 *Setting Colors (Color/Shape Tab)* for details on operating Color Setting Dialog Box.

**NS Series Programming Manual**

### Icon Tab Page

Sets whether an icon button is displayed at the bottom of object.



No.	Item	Details
1	Icon	Icon buttons that perform operations can be displayed at the bottom of the data block object.
	Read Data File	 Reads data from the specified CSV data file, and displays it in the data block table.
	Write Data File	 Overwrites data displaying from the data block table to the specified CSV data file.
	Read from the address	 Retrieves data from the addresses set in Field Setting Dialog Box to the records selected on the data block.
	Write to the address	 Writes data selecting in the data block to the addresses set in the Field Setting Dialog Box.
	Add the record	 Adds a new record below the selected record.
Delete the record	 Deletes the selected record.	

**NS Series Programming Manual**

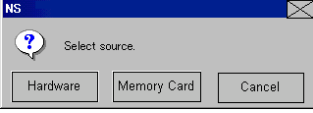
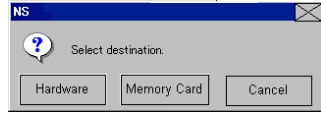
No.	Item	Contents
2	Options	<p>Check the items for which to display confirmation messages when a process is performed by pressing one of the icon buttons as described for number 1, above.</p> <p>Display confirmation dialog box when reading data file.</p>  <p>When this option is not set, data file will always be retrieved from the PT ("Hardware").</p> <p>Display confirmation dialog box when writing data file.</p>  <p>When this option is not set, data will always be written to the PT ("Hardware").</p> <p>Display confirmation dialog box when reading from the address.</p> <p>Display confirmation dialog box when writing to the address.</p> <p>Display confirmation dialog box when adding to the record.</p> <p>Display confirmation dialog box when deleting from the record.</p>
3	Icon Size	Sets the horizontal and vertical dimensions of the icon. (16 to 48)

**Note**

- ◆ The icon size and button size of the horizontal scroll bar are the same. When changing the icon size, the button size of the horizontal scroll bar will be changed simultaneously.
- ◆ The confirmation dialog boxes (for reading/writing CSV data file) displayed in test mode and on the PT are different. A Source/Destination Dialog Box is displayed on the PT, and a confirmation dialog box is displayed in test mode.

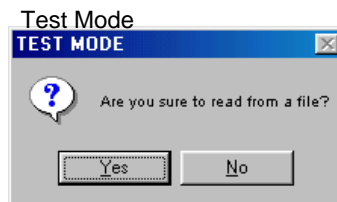
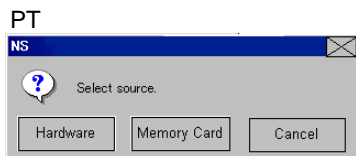

### Specifying Icons

Bitmap files or JPEG files can be set for data block object icons. Use the following method to set these files for icons.

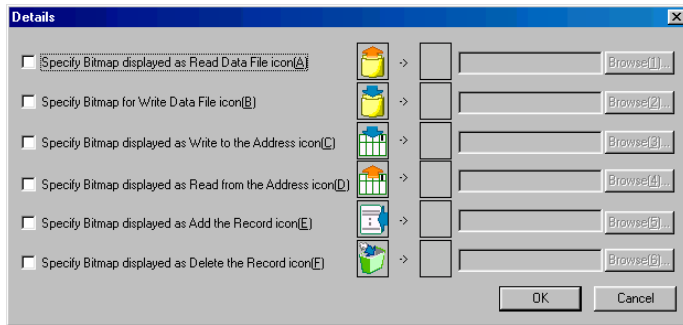

1. Select **PT – Data block Setting**. The Data Block Setting Dialog Box will be displayed.
2. Click the **Icon** Button at the bottom right of the screen to display the Details Dialog Box.
3. Select the check box for the icon to which a bitmap is to be specified and click the **Browse** Button. The File Selection Dialog Box will be displayed. Specify the file to be displayed as the icon.

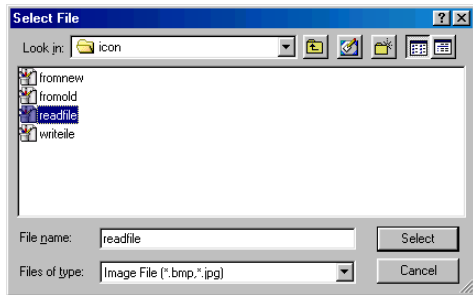

4. Click the **Select** Button to close the dialog box. An image of the selected bitmap file will be displayed to the right of the existing icon in the Details Dialog Box. Click the **OK** Button to close the Details Dialog Box. Click the **OK** Button to close the Data Block Setting Dialog Box.
5. Set the icons to be displayed on the Icon Tab Page of the data block object Properties Dialog Box.
6. Click the **OK** Button to close the Properties Dialog Box. The specified bitmap file icon will be displayed on the data block object, as shown below.

	Product	Model	Height	Width	
0	Label	XXXXXXXX	-99999	-99999	▲
1	Label	XXXXXXXX	-99999	-99999	▲
2	Label	XXXXXXXX	-99999	-99999	
3	Label	XXXXXXXX	-99999	-99999	▼
4	Label	XXXXXXXX	-99999	-99999	▼

◀ Read File Write File ▶▶

**Note**

- ◆ When the number of colors in the designated image file is a True Color number, it is automatically reduced to 32,000.
- ◆ Specify a file name of up to 12 characters (8 file name characters and 3 file extension characters). The following characters can be used in file names: alphanumeric characters, underscore (\_), dollar signs (\$), and periods (.).

### Vertical Scroll Bar Tab Page

Enables/disables the display and sets the scroll width and button size. Refer to 2-8-11 *Scroll Bars* for the vertical scroll bar.





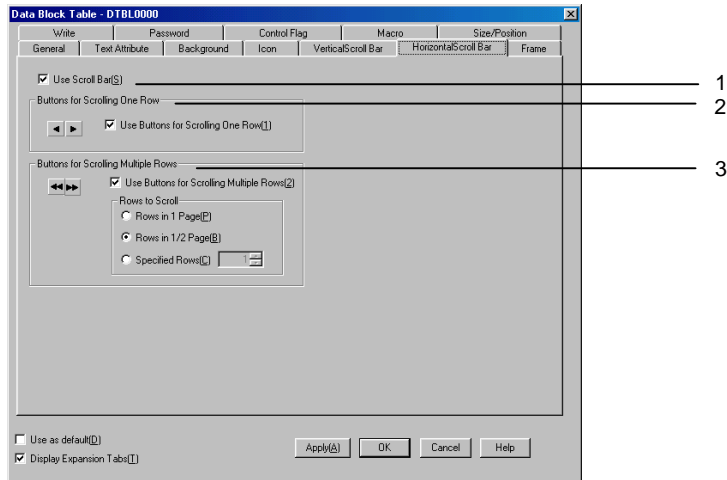

**NS Series Programming Manual**

### Horizontal Scroll Bar Tab Page

Enables/disables the display and sets the scroll width.



No.	Item	Details								
1	Use Scroll Bar	Select <i>Use Scroll Bar</i> if a scroll bar is to be used.								
2	Use Buttons for Scrolling One Row	 Scrolls to the right by one row until only the rightmost field is displayed.								
		 Scrolls to the left by one row until the leftmost row is displayed.								
3	Use Buttons for Scrolling Multiple Rows	Select <i>Buttons for Scrolling Multiple Rows</i> to enable to a scroll button that moves to the right or left by the specified number of rows each time it is pressed. Select the number of rows to be scrolled from the options listed below.								
		<table border="1"> <tr> <th>Rows to Scroll</th> <th>Details</th> </tr> <tr> <td></td> <td>Rows in 1 Page Scrolls to the right or left the displayed number of rows. Suppose that two of seven rows are displayed on the screen. Click the Button, and the button will be scrolled two rows. If the end of the row is displayed, the scroll button will not move any farther.</td> </tr> <tr> <td></td> <td>Rows in 2/1 Page Scrolls to the right or left the half the number displayed number of rows. Suppose that three of seven rows are displayed on the screen. Click the Button, and the button scrolls two rows. If the end of the row is displayed, the scroll button will not move any farther.</td> </tr> <tr> <td></td> <td>Specified Rows Scrolls to the right or left the specified number of rows. If the end of the row is displayed, the scroll button will not move any farther.</td> </tr> </table>	Rows to Scroll	Details		Rows in 1 Page Scrolls to the right or left the displayed number of rows. Suppose that two of seven rows are displayed on the screen. Click the Button, and the button will be scrolled two rows. If the end of the row is displayed, the scroll button will not move any farther.		Rows in 2/1 Page Scrolls to the right or left the half the number displayed number of rows. Suppose that three of seven rows are displayed on the screen. Click the Button, and the button scrolls two rows. If the end of the row is displayed, the scroll button will not move any farther.		Specified Rows Scrolls to the right or left the specified number of rows. If the end of the row is displayed, the scroll button will not move any farther.
		Rows to Scroll	Details							
			Rows in 1 Page Scrolls to the right or left the displayed number of rows. Suppose that two of seven rows are displayed on the screen. Click the Button, and the button will be scrolled two rows. If the end of the row is displayed, the scroll button will not move any farther.							
	Rows in 2/1 Page Scrolls to the right or left the half the number displayed number of rows. Suppose that three of seven rows are displayed on the screen. Click the Button, and the button scrolls two rows. If the end of the row is displayed, the scroll button will not move any farther.									
	Specified Rows Scrolls to the right or left the specified number of rows. If the end of the row is displayed, the scroll button will not move any farther.									

**Note**

- ◆ The icon size and button size of the horizontal scroll bar are the same.

### Frame Tab Page

Specifies the color and size of the object frame. Refer to 2-8-12 *Frames* for details.

### Write Setting Tab Page (Extension Tab)

Sets whether a confirmation message is displayed when writing a value to each field in the data block table. Any confirmation message can be set. Refer to 2-8-14 *Write Settings (Extension Tab)* for details.

**Note**

- ◆ A confirmation dialog box is not displayed if the **Enter** Key of the tenkey pad is pressed without inputting a value, or [ENT] or [RET] is sent from a command button. The address set for *Turn ON the specified address When the value is written* is also not turned ON.

**Password Tab Page (Extension Tab)**

Passwords can be set when field in the data block table is pressed. Five passwords of up to 16 characters each can be set. One password can be requested for each object. Refer to 2-8-15 *Passwords (Extension Tab)* for details.

**Control Flag Tab Page (Extension Tab)**

Control flags control the input and display of the data block table. Use control flags to enable display or input when the status of an address turns ON or OFF. Refer to 2-8-16 *Control Flags (Extension Tab)* for details.

**Macro Tab Page (Extension Tab)**

A macro can be specified for execution when setting a value for a field of the data block.

Trigger	Details
Before Inputting Numeral/String	Execute immediately after touching the field.
Before Writing Numeral/String	Execute immediately after touching field or pressing <b>Enter</b> Key of the tenkey pad or keyboard. This macro is not executed when closing tenkey pad or keyboard using the Cancel Key, Esc Key or Close Button. When a value exceeding the limit is set and an input error occurs for the numeral field, the macro is not executed.

Refer to the *NS Series Macro Reference* in the *CX-Designer* for details.

**Size/Position Tab Page (Extension Tab)**

Displays and sets the size of the data block object and the position from the upper left of the screen. Refer to 2-8-18 *Size/Position (Extension Tab)* for details.

**Creating Data Files**

A data file is created as a group of records. The data block table retrieves the data from the file and displays it as record data. The data file is created in a CSV-format file. Use the following procedure.

**Procedure for Creating CSV Files**

The CSV file for a data block is created in the following format.

```
Record label A, Field data A1, Field data A2, ...
Record label B, Field data B2, Field data B2, ...
.
```

Set the record label on the left of each line. Any character string can be set for record label as the record name. Up to 32 characters can be displayed in the data block table.

There are two types of fields; numeral fields and string fields. Select the data format for each field and set the field data as shown below.

Field name	Description
Numeral Field	Input numeral value using decimal numbers.
String Field	Input any character string.

**NS Series Programming Manual**

**Restrictions on Creating Data Files**

1. The CSV format must be used when creating data files. If a file is created using another format, data will not be read when using the data block on the PT, and data will not be displayed normally.
2. Set the same as the number of fields as that set in the data block settings on the CX-Designer. If the number of fields set in the data file is larger than that set for the data block settings on the CX-Designer, the PT will not read overflow data.

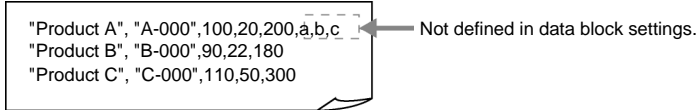

As the figure above shows, if more than 5 fields are set for the first record, which consists of 4 fields, "a,b,c" set for the fifth field on will not be read.

"a,b,c," registered in the data file will be deleted when writing to the data file.

3. If the number of fields set in the data file is less than that set in the data block, the following error message will be displayed when displaying the data block, and PT will not display the data block. Set the same number of fields in the field data as for the data block setting.

Although the Data Block Table exists on the screen, it failed to read the csv file to display on the Data Block Table.

[Data Block (x) csv file]

The object will not be displayed correctly.

4. If ASCII is set for the string display type, the following codes will be used on the PT according to the language.

Language	Code	Example (character code B5)
Japanese	SHIFT-JIS Code	†
Chinese (traditional or simplified)	GB2312 code	Nothing is displayed because there are no corresponding characters.
Other	Latin 1 Code	•

**Reference**

- ◆ To output other languages in the CSV file output for the data block, the output format must be set to Unicode in the data block setting dialog box. Refer to *Multi-language Display* in the *CX-Designer Online Help* for details on using other languages.

5. If the user sets more than the preset number of records, the data exceeded that number will be ignored. Also, the data will be deleted when writing to the data file.

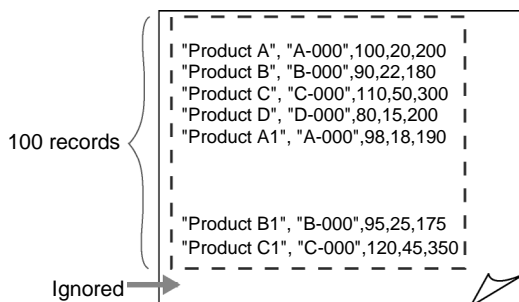

As the figure above shows, the last record data will be ignored.

When writing data to data file, the last record data will be deleted.

6. To write data to the data file, the record label and character string of the field are automatically enclosed in double quotation marks. Therefore, character strings will be enclosed in double quotation marks in the CSV file after writing. When creating data file, it is not necessary to enclose record label and character string with double quotation marks.

**NS Series Programming Manual**

- When putting double quotation marks in the middle of a string for the record label or a character string, follow the rules given in the following table. Create data for the record label and string field according to the character string to be displayed or set in the data block.

Rule	Example for setting in data file	Display in the data block table
To display double quotation marks ("), set two double quotation marks [""]. When two double quotation marks are set, one double quotation mark will be displayed.	AB""CD	AB"CD
To display a comma (,) in the string, enclose the entire string with double quotation marks.	"AB,CD"	AB,CD

If invalid double quotation marks are input, an error message will be displayed when displaying the data block.

Invalid	Remark
ABCD"	Setting double quotation marks at the right end or middle of the string causes an error. Set two double quotation marks, such as in [ABCD""] to display a double quotation mark.
AB"CD	

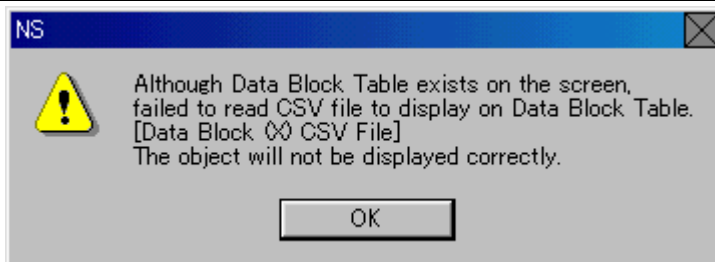

- If numeral data is set for a string field, the input numeral data will be processed as a string.
- If data includes characters other than numeral values for a numeral field, the field will be processed as 0.
- If the value set for a numeral field is out of range, 0 will be displayed.
- If data including a decimal fraction is set for a numeral field, the following processes will be performed.

Storage format	Procedure	Example		
		Setting	Display	Write value
Except REAL	Decimal position is not displayed. When writing to data file or address, only integer part is written.	1.5	1	1
REAL	The number will be rounded off. When writing to the data file or address, the number before rounding up will be used.	1.5	2	1.5

- Lines at the beginning of the CSV file that start with #COMMENT will not be read as part of the data log.

### 2-17-3 Using Data Blocks

This section explains how to use a data block table.

#### Using Data Block Tables

##### Selecting a Record on a Data Block Table

Click the record number to select record from the data block table. The record numbers are automatically displayed in the data block table.

The selected record is displayed in reverse video and "\*" is added to the record number.

	Name	Flour	Oil	Egg	Sugar	Flavor
0	A Setting	200	80	2	65	100
1	B Setting	200	80	2	65	100
	C Setting	200	80	2	65	100
3	D Setting	200	80	2	65	100
4	E Setting	200	80	2	65	100

Record numbers are automatically displayed.

##### Inputting Value in a Data Block Table

The user can change the value of a field in the data block table.

	Product	Model	Height	Width	Depth
0	Product A	A-001	200	100	30
1	Product B	A-002	100	50	31
2*	Product C	A-003	170	75	32
3	Product D	A-004	130	65	39
4	Product E	A-005	240	120	34



Touch field for which you want to change the value. The keyboard or keypad will be displayed. Then, change the value.

**NS Series Programming Manual**

**Adding/Deleting Records for a Data Block Table**

Records can be added or deleted in the data block table.

	Product	Model	Height	Width	Depth
0	Product A	A-001	200	100	30
1	Product B	A-002	100	50	31
2*	Product C	A-003	150	75	32
3	Product D	A-004	130	65	39
4	Product E	A-005	240	120	34

**•Adding a Record**



Click the icon to add a new record  
The record numbers are automatically renumbered.

**•Delete a Record**



Click the icon to delete the selected record.  
The record numbers are automatically renumbered.

**Editing Record Labels in a Data Block Table**

Up to 32 characters can be displayed for a record label. Record labels are set in data file beforehand, but they can be also edited from the data block table.

Click the record label in the data block table to display a keyboard and input a character string.

### Reading/Writing Data Files

The CSV-format data file and the data block table correspond as shown below.

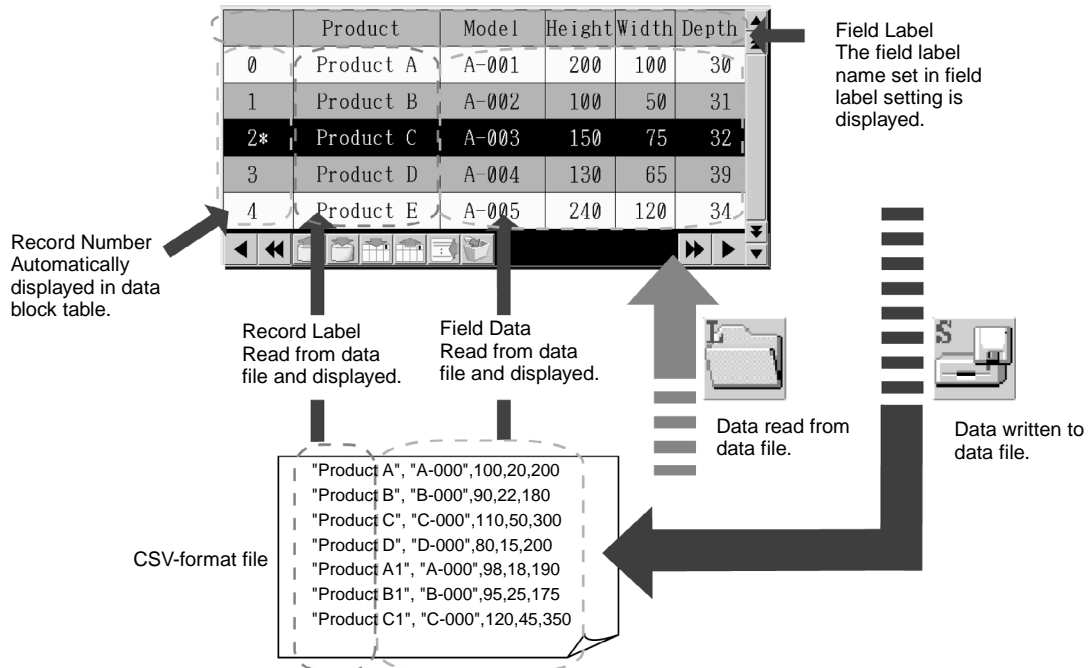



1. To display the data block table on the PT, data is read from the data file. (When transferring screen data to the PT, the data file is also transferred.)
2. Using the and icons, data files can be written and read to/from a Memory Card or the PT. Select the source/destination in confirmation dialog box for reading/writing. When writing to a Memory Card, data will be written to the file under the folder "DBLK" automatically created on the Memory Card. When reading from a Memory Card, create the folder "DBLK" in the Memory Card beforehand and store the data file in the folder.

**Note**

- ◆ Be sure to write the data file to save any changes made in the data block table. If the screen is switched before writing to the data file, the changed values will not be saved. Writing to the data file is required to save the changes in test mode. However, if the screen is switched in the test mode before writing to data file, the changed values before screen was switched will remain.
- ◆ When writing data to the data file in test mode, data will be written directly to the CSV file set in the Register Data Block Dialog Box. Before writing data to the data file, make a backup of CSV file to transfer to the PT.

### Reading/Writing from/to Addresses

Press the  icon to write data to an address. When this icon is pressed, the record data selected in the data block table will be written to the address set for each field.

Press the  icon to retrieve data from the address to the data block table. Retrieved data will be set for the record selected in the data block table.

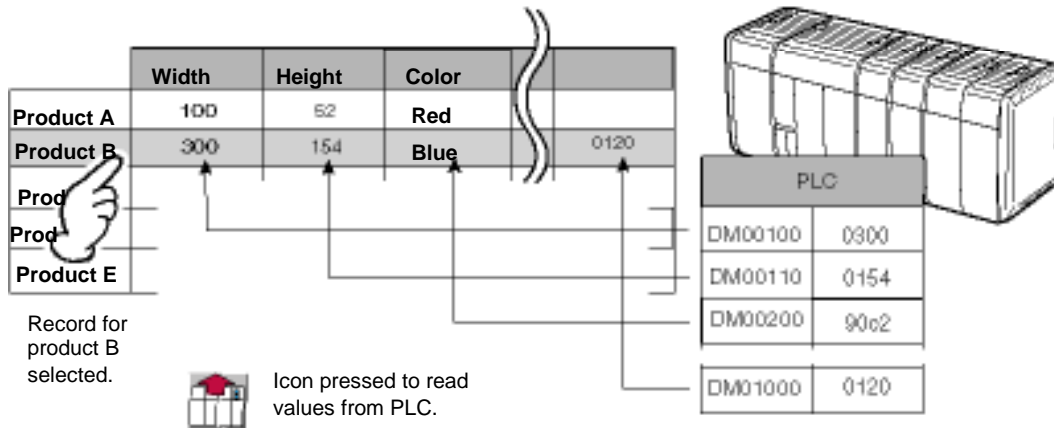
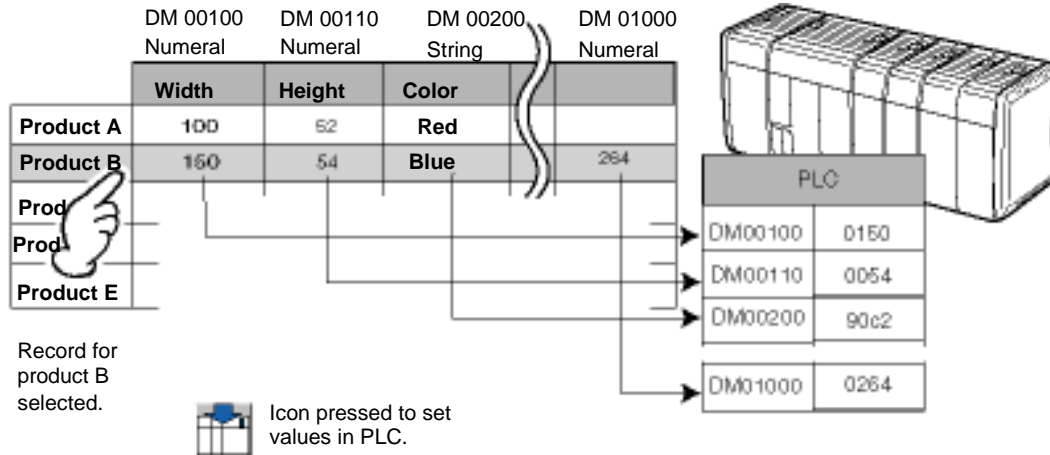

### Combining Functional Objects

Use the following procedure to combine functional objects, such as command buttons and Numeral Display & Input objects. Refer to 2-9-3 *Command Buttons* for command button settings to control data blocks.

### Reading/Writing Communications Addresses and Adding/Deleting Records

Command button data block control functions are used to read and write data between a CSV file and communications addresses and to add and delete records from CSV files.



**NS Series Programming Manual**

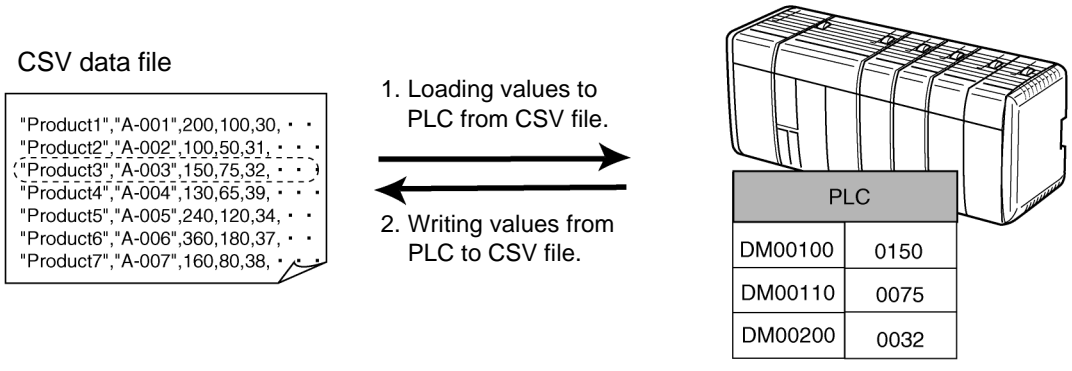

No.	Setting	Details
1	Read data from CSV file to PLC Data Block	Loads the specified record data from the CSV file to the communications addresses set in the fields.
2	Write data from PLC Data Block to CSV file	Writes the data at the communications addresses set in the fields to the specified records in the CSV file. Either overwriting the data at the specified record number or inserting the data at the specified record number is selected.
3	Delete Record	Deletes the data from the specified record number in the CSV file.

**Loading/Writing between CSV Files and PT Memory**

The command button data block control functions can be combined with Numeral Display & Input objects, Character Display & Input objects, and other functional objects to edit CSV files or to display only the desired files on the screen.

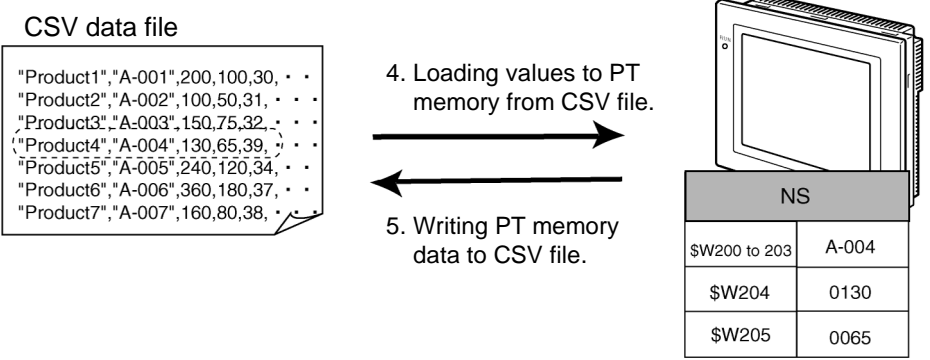

No.	Setting	Details
4	Read data from CSV file to NS PT Memory	Loads the specified record data from the CSV file to the specified address in the PT.
5	Write data from NS PT Memory to CSV file	Writes one record of data stored at the specified address in the PT to the specified record in the CSV file. Either overwriting the data at the specified record number or inserting the data in the specified record number is selected.

**Writing/Loading PT Memory Data to/from Communications Addresses**

Command button data block control functions can be used to write and load data between PT memory and PLC memory areas.

**NS Series Programming Manual**

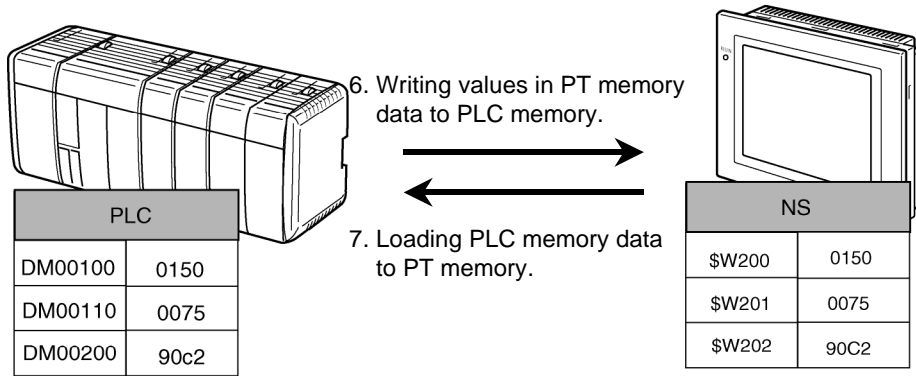

No.	Setting	Details
6	Read data from NS PT Memory to PLC Data Block	Writes one record of data stored at the specified address in the PT to communications address specified in each field.
7	Write data from PLC Data Block to NS PT Memory	Loads the data from the communications address specified in each field to the specified address in the PT.

**Reading CSV File Record Labels**

Command button data block control functions can be combined with list display objects to display lists of record labels.

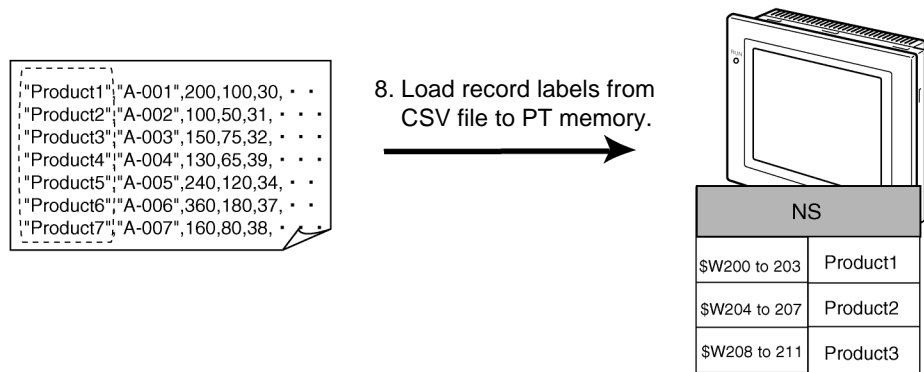

No.	Setting	Details
8	Read Record Labels	Loads the specified number of records from the first read record number to the specified addresses in the PT.

**Restrictions on Writing to Addresses**

- When writing data to an address, the data will be written one at a time and in order starting from the leftmost field. Time is required until the last field data is written.  
To switch the control using a data block, set the interlock for the PLC that confirms the last field data (rightmost field) is written and starts the control action.
- While writing data to an address, other processes will stop. If a screen switch is specified while writing data, the screen will be switched after writing has been complete.

## 2-18 System Clock

NS-series PTs have a built-in clock function that allows the date and time to be displayed or changed on the PT using date or time objects.

### 2-18-1 Date Object

Date objects are functional objects used to display or change the date of the system clock. The display section is a touch switch. A Settings Dialog Box (keypad) for changing the system time is displayed when this touch switch is pressed.

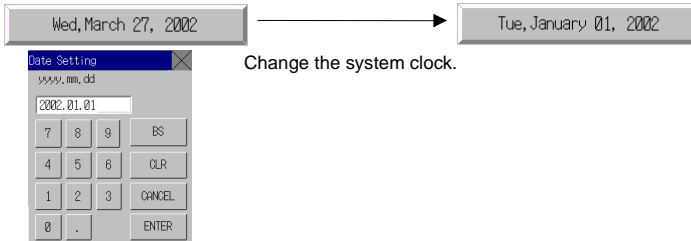

### Changing Dates during PT Operation

1. Press the date object.
2. A dialog box for entering the date such as shown in the above diagram will be displayed.
3. Enter the new date.  
Regardless of the date display format, enter the date in yyyy.mm.dd format. There is no need to add zeros.)
4. Press the **ENTER** Button.
5. The date will be set.

#### Note

- ◆ The maximum monthly clock error margin will be  $-39$  to  $+65$  seconds at room temperature ( $25^{\circ}\text{C}$ ). Adjust the clock regularly.
- ◆ If the date object extends off the screen, the setting dialog box (i.e., the keypad) will also extend off the screen. Always be sure that date objects are completely within the screen.

### Settings for Functional Object Properties

This section describes the settings in the Functional Object Properties Dialog Box for date objects.

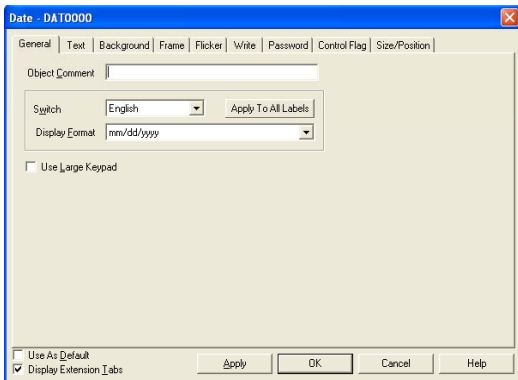

- General: Sets the date display format.
- Text: Sets the font and size for date display characters.
- Background: Sets the background color for date display.
- Frame: Sets the object frame display.
- Flicker: Sets the flicker display. (See note.)
- Write: Sets the contents of the write confirmation message when the date object is pressed. (See note.)
- Password: Sets the password to be entered when the object is pressed. (See note.)
- Control Flag: Sets enable/disable input and display/no display for objects. (See note.)
- Size/Position: Sets the object size and position. (See note.)

Note: These tabs are displayed when *Display Extension Tabs* Option is selected.

### General Tab Page

Sets the date display format.

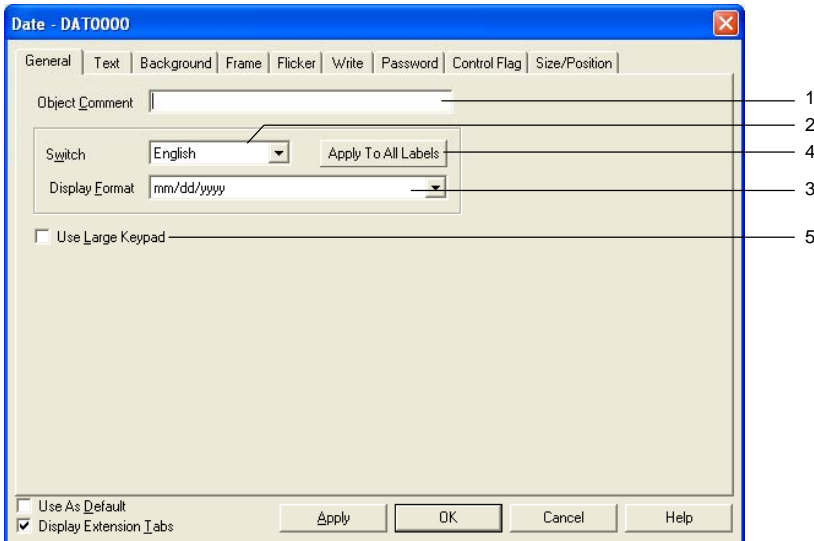

No.	Setting	Details
1	Object Comment	Sets an explanatory comment for the pasted object. (Up to 32 characters.)
2	Switch	Sets the date display format for each label.
3	Display format	Refer to <i>Date and Time Format</i> in 2-8 Common Functional Object Functions for information.

No.	Setting	Details
4	Apply to All Labels	Uses the date display method of the selected label for all labels. <i>Apply to All Labels</i> cannot be set in the following cases. <ul style="list-style-type: none"> <li>When the <i>Date &amp; Time Display Format</i> Check Box is selected on the Edit/Display Tab Page of the Option Dialog Box accessed by selecting <b>Tools - Option</b>.</li> <li>When there is only one label.</li> </ul>
5	Use Large keypad	Select <i>Use Large keypad</i> to use a large Setting Dialog Box (keypad). A 252 × 268 dot (V × H) keypad will be displayed during PT operation.

### Text Tab Page

Sets the text attributes, such as font and color, for the date display. Refer to *Text Attributes* under 2-8 *Common Functional Object Functions* for details.

### Background Tab Page

Sets the background color for date display from a selection of 256 colors. Refer to *Background* and *Setting Colors* under 2-8 *Common Functional Object Functions* for details.

De-select (i.e., remove the tick from) *Tile background* to have a transparent background.

### Frame Tab Page

Specifies the colors and sizes of the object frame to change the shape or color when the button is depressed or raised. Refer to *Frames* under 2-8 *Common Functional Object Functions* for details.

### Flicker Tab Page (Extension Tab)

Makes flicker settings to make the object flicker (flash). Refer to *Flicker* under 2-8 *Common Functional Object Functions* for details.

### Write (Extension Tab)

Confirms the write operation using a dialog box before the date is set. The confirmation message can be changed. Refer to *Write Settings* under 2-8 *Common Functional Object Functions* for details.

### Password Tab Page (Extension Tab)

A password can be set for when the object area is pressed. Five passwords of up to 16 characters each can be set. One password can be requested for each object. Refer to *Passwords* under 2-8 *Common Functional Object Functions* for details.

### Control Flag Tab Page (Extension Tab)

Control flags control the input and display of functional objects. Use control flags to enable display or input when the contents of an address turn ON or OFF. Refer to *Control Flags* under 2-8 *Common Functional Object Functions* for details.

### Size/Position Tab Page (Extension Tab)

Sets the object size and position. Refer to *Size/Position* under 2-8 *Common Functional Object Functions* for details.

*NS Series Programming Manual*

### 2-18-2 Time Objects

Time objects are functional objects used to display or set the time for the system clock. The display section is a touch switch. A Setting Dialog Box (keypad) for changing the system time is displayed when this touch switch is pressed.

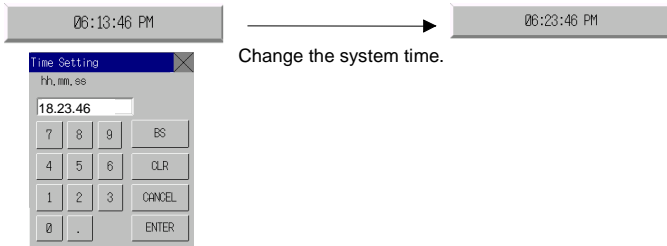

#### Changing Times During PT Operation

1. Press the time object.
2. A dialog box for entering the time such as shown in the above diagram will be displayed.
3. Enter the new time.

Regardless of the time display format, enter the time in hh (24-hour clock).mm.ss format. There is no need to add zeros.)

4. Press the **ENTER** Button.
5. The time will be set.

Example: When setting the time to 4:36:4 PM, input 16.36.04.

When changing the time during PT operation, refer to the following table and set the time.

	AM	PM
Time	0 1 2 3 4 5 6 7 8 9 10 11	0 1 2 3 4 5 6 7 8 9 10 11
Input to the PT	0 1 2 3 4 5 6 7 8 9 10 11	12 13 14 15 16 17 18 19 20 21 22 23

### Settings for Functional Object Properties

This section describes the settings in the Functional Object Properties Dialog Box for time objects.

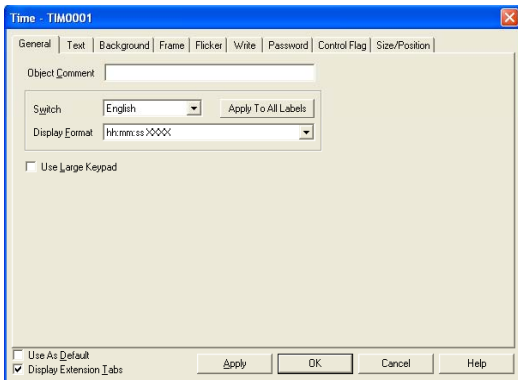

- General: Sets the time display format.
- Text: Sets the font and size for time display characters.
- Background: Sets the background color for time display.
- Frame: Sets the object frame display.
- Flicker: Sets the flicker display. (See note.)
- Write: Sets the contents of the write confirmation message when the time object is pressed. (See note.)
- Password: Sets the password to be entered when the object is pressed. (See note.)
- Control Flag: Sets enable/disable input and display/no display for objects. (See note.)
- Size/Position: Sets the object size and position. (See note.)

Note: These tabs are displayed when *Display Extension Tabs* Option is selected.

#### General Tab Page

Sets the time display format.

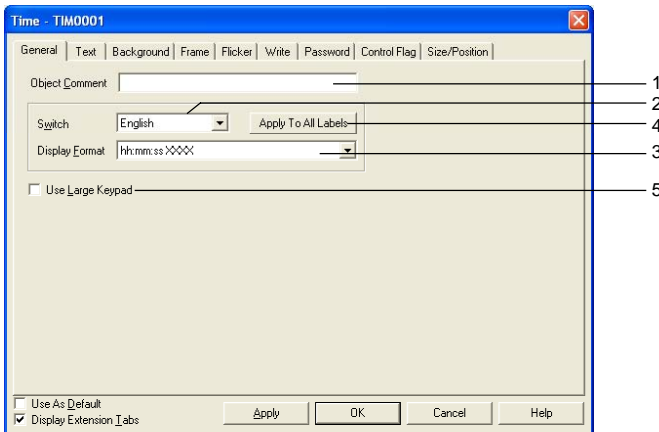

No.	Setting	Details
1	Object Comment	Sets an explanatory comment for the pasted object. (Up to 32 characters.)
2	Switch	Sets the time display format for each label.
3	Display format	Select the time display format from the list. Refer to <i>Date and Time Format</i> in <i>2-8 Common Functional Object Functions</i> for information on the time display format.
4	Apply to All Labels	Uses the date display method of the selected label for all labels. <i>Apply to All Labels</i> cannot be set in the following cases. <ul style="list-style-type: none"> <li>• When the <i>Date &amp; Time Display Format</i> Check Box is selected on the Edit/Display Tab Page of the Option Dialog Box accessed by selecting <b>Tools - Option</b>.</li> <li>• When there is only one label.</li> </ul>

No.	Setting	Details
5	Use Large keypad	Select <i>Use Large keypad</i> to use a large Settings Dialog Box (keypad). A 252 × 268 dot (V × H) keypad will be displayed during PT operation.

### Text Attributes Tab Page

Sets the text attributes, such as font and color, for the time display. Refer to *Text Attribute* under 2-8 *Common Functional Object Functions* for details.

### Frame Tab Page

Specifies the colors and sizes of the object frame to change the shape or color when the button is depressed or raised. Refer to *Frames* under 2-8 *Common Functional Object Functions* for details.

### Background Tab Page

Sets the background color for time display from a selection of 256 colors. Refer to *Background* under 2-8 *Common Functional Object Functions* for details.

### Flicker Tab Page (Extension Tab)

Makes flicker settings to make the object flicker (flash). Refer to *Flicker* under 2-8 *Common Functional Object Functions* for details.

### Write (Extension Tab)

The write operation can be confirmed using the dialog box before the time is set. The confirmation message can be changed. Refer to *Write Settings* under 2-8 *Common Functional Object Functions* for details.

### Password Tab Page (Extension Tab)

A password can be set for when the object area is pressed. Five passwords of up to 16 characters each can be set. One password can be requested for each object. Refer to *Passwords* under 2-8 *Common Functional Object Functions* for details.

### Control Flag Tab Page (Extension Tab)

Control flags control the input and display of functional objects. Use control flags to enable display or input when the contents of an address turn ON or OFF. Refer to *Control Flags* under 2-8 *Common Functional Object Functions* for details.

### Size/Position Tab Page (Extension Tab)

Sets the functional object size and position. Refer to *Size/Position* under 2-8 *Common Functional Object Functions* for details.



## 2-19 Machine Navigator Function

### 2-19-1 Machine Navigator

The Machine Navigator function switches the display of strings and image files registered to screens based on the value at a specified address or on the occurrence or clearing of an alarm/event. The general term “contents” is used here for strings and image files. Contents are displayed using contents display objects.

This function makes it easy to create operating procedure displays or troubleshooting screens for when errors occur. When using the Machine Navigator function, contents can be switched using the following three methods.

#### Switching Contents by Specified Address (Address for switching contents)

The settings shown in the following table are made.

Contents switching address: DM100		
Contents No.	Contents	
0	The battery ...	Battery.bmp
1	The backlight ...	BackL.bmp
...	...	...

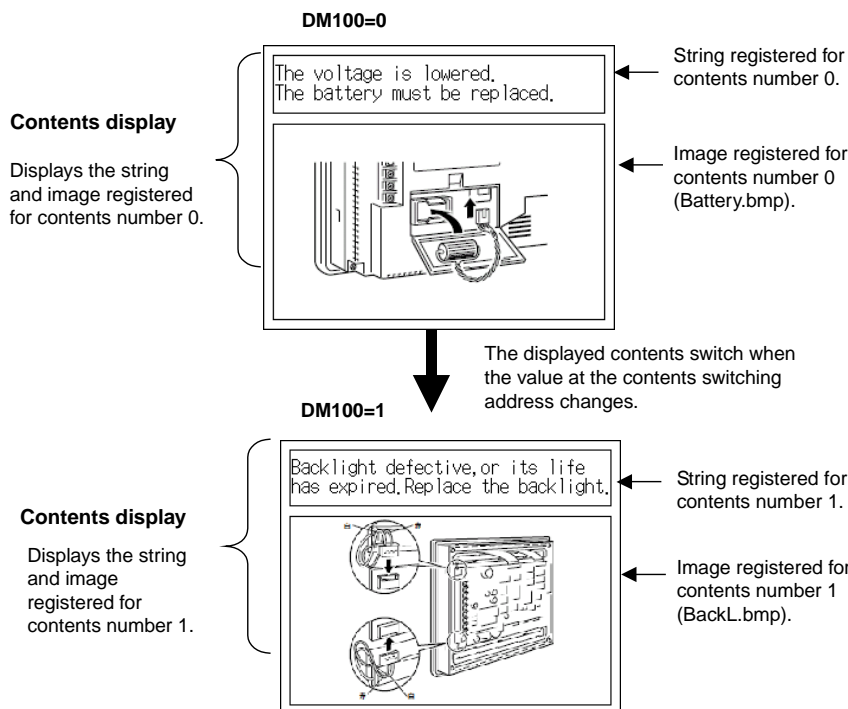

### Automatically Switching Contents When Alarm Occurs

The settings shown in the following table are made.

Settings for switching contents			Alarm/event settings		
Link with alarm: ON			No.	Displayed contents number	Automatic contents switching when alarm occurs
Contents number for no alarm: 0					
Contents No.	Contents		1	1	ON
0	(Not set.)	(Not set.)	2	2	ON
1	The battery ...	Battery.bmp	...	...	...
2	The back-light ...	BackL.bmp			
...	...	...			

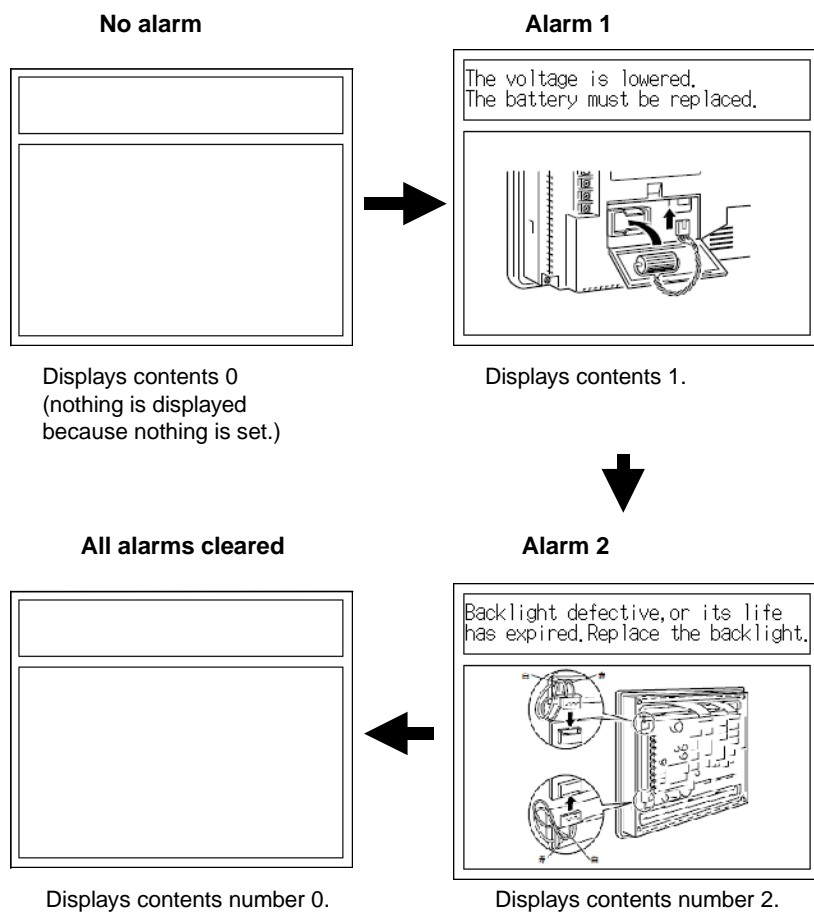

### Switching Contents from Alarm/Event Objects

The settings shown in the following table are made.

Settings for switching contents		
Link with alarm: ON		
Contents number for no alarm: 0		
Contents No.	Contents	
0	(Not set.)	(Not set.)
1	The battery ...	Battery.bmp
2	The backlight ...	BackL.bmp
...	...	...

Alarm/event settings		
No.	Displayed contents number	Automatically switch contents when alarm occurs
1	1	OFF
2	2	OFF
...	...	...

Alarm/Event Display Settings
Switching to the specified contents set with an Alarm/Event Setting: ON

Alarm/Event Summary/History Settings
Switching to the specified contents set with an Alarm/Event Setting: ON

#### Reference

- ◆ If the alarm/event summary/history object settings are made to turn ON switching to the specified contents in the alarm/event registrations and to turn OFF automatically switching the contents when an alarm or event occurs, the contents will not automatically switch when an alarm or event occurs, but the contents will be displayed according to the selection bar in the alarm/event summary/history object.
- ◆ For NS system versions lower than 8.25, the above operation is performed when the alarm/event summary/history object selection bar is touched. For NS system version 8.25 or higher, the above operation occurs not only when the object is touched, but when the contents selected with the selection bar changes as the result of an alarm occurring or being cleared.
- ◆ When switching the contents from an alarm/event object, as a rule, the alarm/event objects and contents display objects on the same screen are used. Place the objects on the same screen.

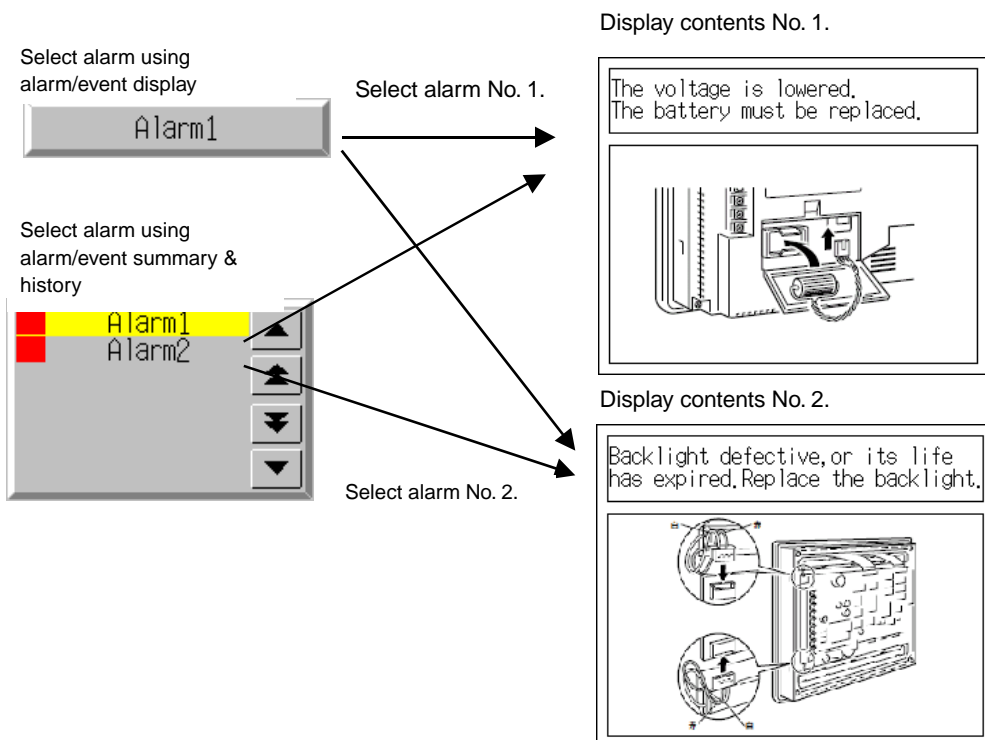

**Note**

- ◆ The switch contents settings are made for each screen or sheet. Up to 10,000 contents items can be set for each screen/sheet.
- ◆ Screens set using the contents switching function are called contents display screens.
- ◆ Either string display or image display is set for each contents display. Refer to 2-19-2 Contents Display for details on contents display settings.
- ◆ Refer to 2-14 Alarms and Events for information on alarm/event settings.
- ◆ If more than one alarm/event occurs at the same time, the contents for the alarm/event with the highest priority will be displayed. If the priority level is the same, the contents for the last alarm/event that occurred will be displayed.
- ◆ If switching contents when an alarm/event occurs or is cleared, the currently displayed contents number will be stored at the address for switching contents. The contents display will switch if the value at the address for switching contents changes, even if contents display is switched using alarms/events.

**Creating Contents Display Screens**

The following procedure is used to create contents display screens.

- 1 Create the contents required for the screen.
- 2 Set whether to display a string or an image on the General Tab Page of the Contents Display Property Settings Dialog Box.

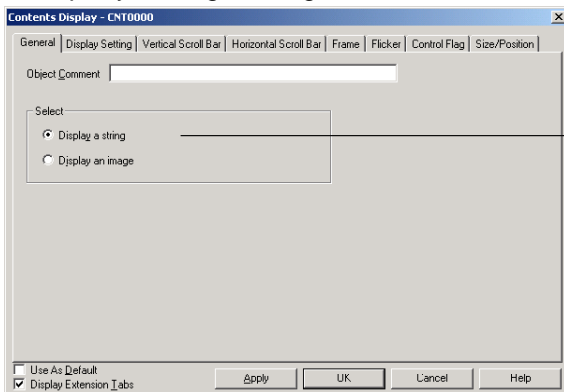

Set whether to display a string or an image.

- 3 Set the number of contents on the Edit Contents toolbar. Set the total number of strings and images to be displayed. Set the address for switching contents in the input field at *Address for switching contents*.

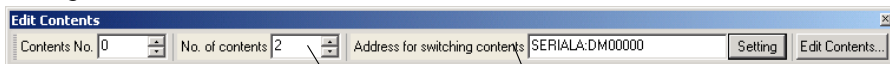

Set the communications address for specifying contents switching.  
Set the total number of contents to be displayed.

- 4 Enter the contents number to be edited in the input field for *Contents No.* on the Edit Contents toolbar.

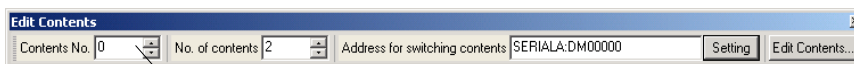

Set the contents number to be edited.

- 5 Select the contents display and press the Space Key. Enter the display string for contents display that will display a string. A file selection dialog box will be displayed for contents display that displays images. Select the image file to be displayed.

**NS Series Programming Manual**

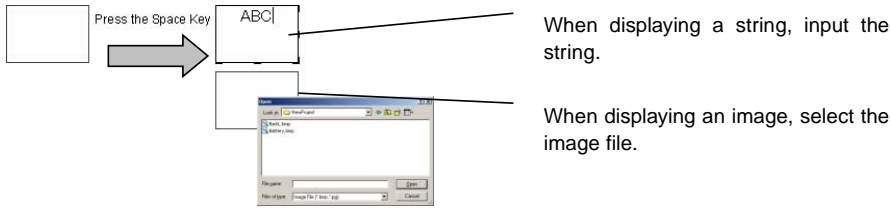

- 6 Repeat steps 4 and 5 for the number of contents to be created.  
Detailed settings for the set contents are made in the Edit Contents Dialog Box.

- 1 Click the **Edit Contents** Button on the tool bar or **select PT – Edit Contents**.

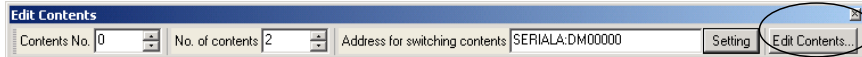

- 2 The Edit Contents Dialog Box will be displayed. Click the screen number at the top left of the dialog box (1 in the following graphic.) Make the contents switching settings.

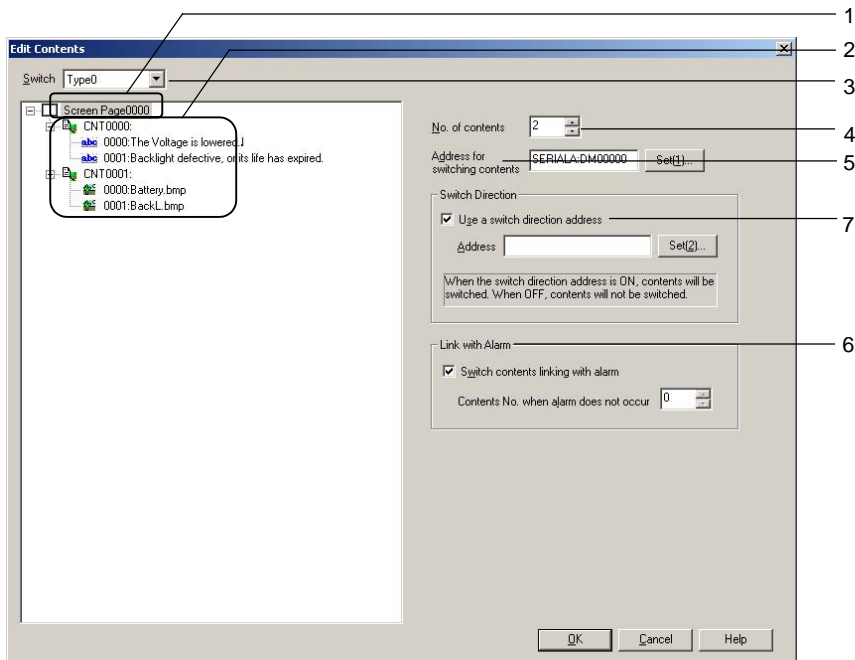

No.	Item	Details
1	Screen No.	Displays the screen number and title of the screen currently being edited. The Contents Switching Setting screen will be displayed when the screen number is clicked.
2	Contents	A list of the contents display ID numbers created for the screen and the registered contents will be displayed. The registered strings will be displayed for strings. File names will be displayed for image files. The edit setting screen will be displayed when each contents is clicked.
3	Switch	Switches the label being edited.
4	No. of contents	Sets the number of contents to between 2 and 10,000.
5	Address for switching contents	Sets the address for switching contents (the communications address for specifying contents switching).
6	Link with alarm	Select this checkbox to switch contents when an alarm/event occurs or is cleared. When an alarm event occurs, the contents with the number set in the Alarm/Event Settings Dialog Box will be displayed. When an alarm/event is cleared, the contents for the number set under <i>Contents No. when alarm does not occur</i> will be displayed.
7	Use a switch direction address	If this checkbox is selected, the contents will be displayed and refreshed while the set communications address is ON. For details, refer to <i>Switching Specification</i> later in this section. If this checkbox is deselected, the contents will switch when the contents of the address for switching contents changes.

**NS Series Programming Manual**

**Switching Specification**

If *Use an address for switching* is selected, the contents display will be displayed and refreshed while the specified address is ON. The contents for contents display are displayed/refreshed as shown below, depending on whether the switch direction address is ON or OFF.

**Operation example**

Multi-contents screen displayed.

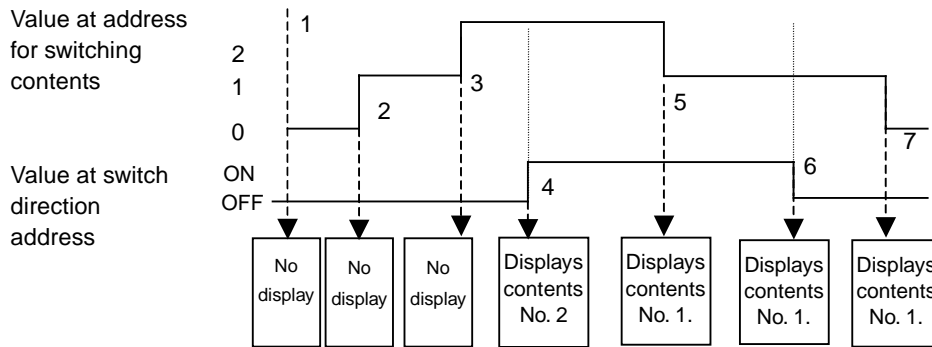

- 1 Nothing is displayed for contents display when switching to the contents display screen because the switch direction address is OFF.
- 2, 3 The value at the address for switching contents changed, but the switch direction address is OFF so there is no contents display. (The display remains blank.)
- 4 The switch direction address has turned ON, so the contents for contents number 2 are displayed in the contents display because the value at the switch direction address contents is 2.
- 5 The switch direction address is ON so the contents for contents number 1 is displayed, according to the change in the value at the address for switching contents.
- 6 There is no change to the contents display because the switch direction address is OFF.
- 7 The value at the address for switching contents has changed but the switch direction address is OFF so the contents display does not change.

**Note**

◆ Up to a maximum of 10,000 contents can be registered. The maximum setting file size that can be registered for one screen (including the label settings (message display), however, is 5 MB. Do not set any value larger than this. The setting file name is CNTxxx.cfg, where “xxx” is the screen number in hexadecimal. You can check the size of the current setting file by selecting **Tools – Resource Report** from the CX-Designer menus.

Registered strings can be changed as a group by importing/exporting CSV files. The string table can be exported as a CSV file, edited or translated, and then imported. All of the data in the edited CSV file can then be registered together in the string table.

The size of the settings file depends on the number of registered characters and labels. Use the following table as a guide. This table shows sizes for when only one contest display (string display) is created.

File size	No. of labels	Registered contents	No. of characters in each content
5.0 MB	1	10,000	256
4.9 MB	1	2,500	1,024
4.8 MB	2	10,000	120
4.7 MB	2	1,200	1,024
4.9 MB	16	10,000	10
4.7 MB	16	150	1,024

◆ You can click the contents display section to input or export the data for each contents display to or from a CSV file.

**NS Series Programming Manual**

**Editing Contents**

Each contents can be edited in the Edit Contents Dialog Box.

**Editing Strings**

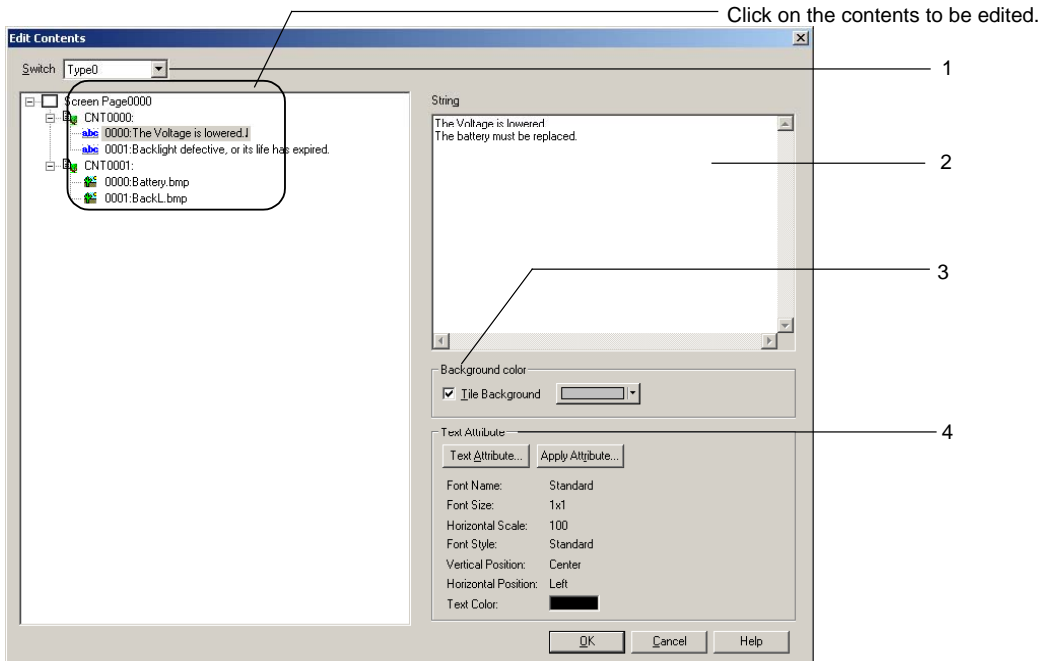

No.	Item	Details
1	Switch	Switches the label to be edited.
2	String	Sets the display string. Strings can be up to 1,024 characters long. (Single- and double-byte characters are counted as one character. Carriage returns are counted as two characters.)
3	Background color	Sets the background color. Refer to <i>Background</i> in 2-8 <i>Common Functional Object Functions</i> for details.
4	Text Attribute	Sets the text attributes. Refer to <i>Text Attributes</i> in 2-8 <i>Common Functional Object Functions</i> for details.

**Note**

- ◆ The background color and text attributes can be set for each contents number.



NS Series Programming Manual

Image Files

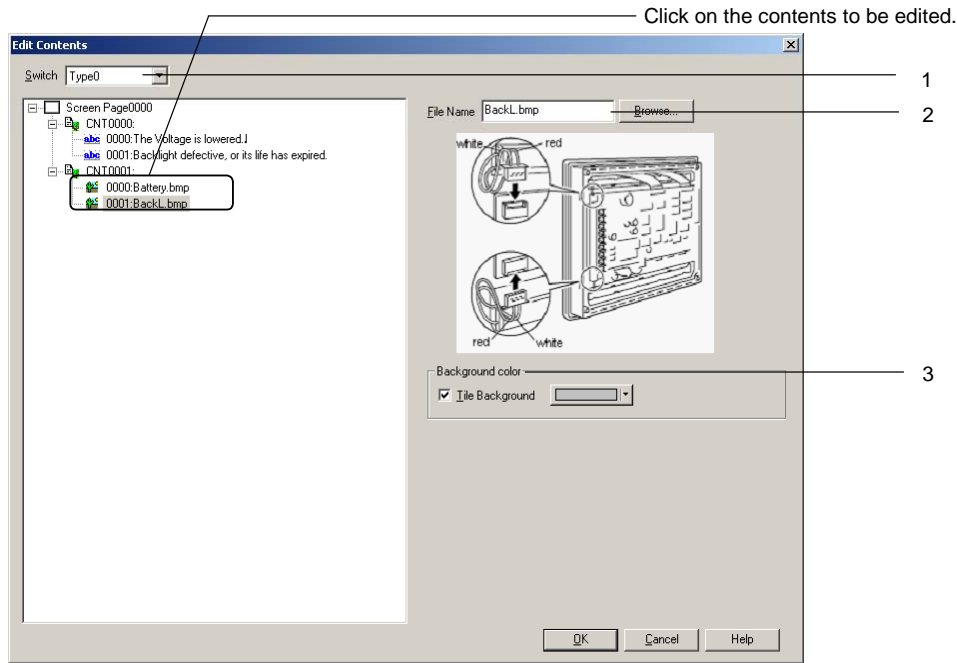

No.	Item	Details
1	Switch	Switches the label to be edited.
2	File name	<p>Sets the image file to be displayed. Files with .bmp and jpg. extensions can be set. Click the <b>Browse</b> Button to select an image file.</p> <p>The specified image file will be copied to the folder where the project file is stored.</p> <p>Specify a string of up to 12 characters (8 characters for the file name + 3 characters for the extension) as the file name. The following characters can be used. Double-byte characters cannot be used.</p> <p>English numerals, underscore (_), dollar sign (\$), and period (.)</p>
3	Background color	<p>Sets the background color. The background is displayed when the size of the displayed image is smaller than the contents display size.</p> <div style="display: flex; align-items: center;">  <div style="margin-left: 10px;"> <p>Image file</p> <p>Background color</p> </div> </div> <p>Refer to <i>Background</i> in 2-8 Common Functional Object Functions for details.</p>

Note

- ◆ The background color can be set for each contents number.

## 2-19-2 Contents Display

Contents display is a functional object for displaying contents (strings and image files) according to the contents switching settings.

Select *Functional Objects – Contents Display* from the CX-Designer or select the  icon to create a contents display object.

### Setting Items for Functional Object Properties

This section describes the functional object property settings for contents display objects.

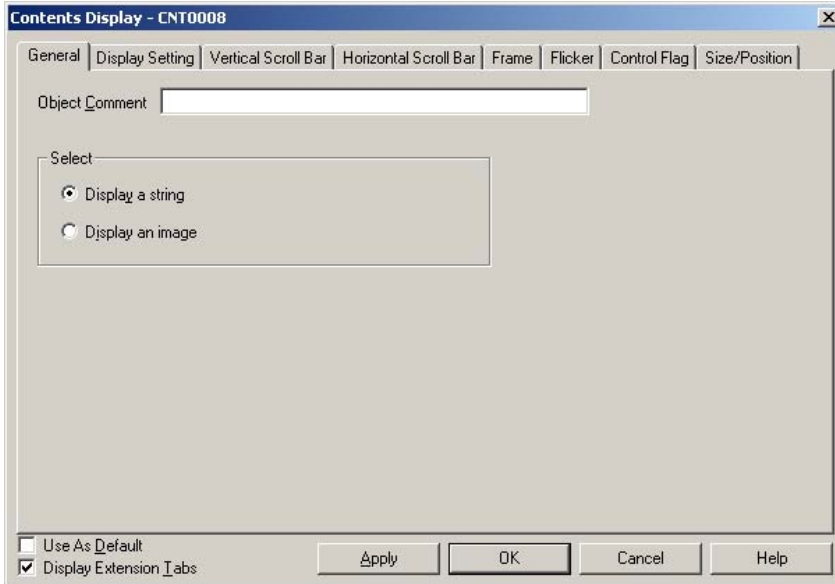

General:	Selects the contents (string or image) to be displayed in the object.
Display Setting:	Sets the display method for strings and images.
Vertical Scroll Bar:	Sets size, scroll width, and other vertical scroll button settings.
Horizontal Scroll Bar:	Sets size, scroll width, and other horizontal scroll button settings.
Frame:	Sets the object frame display details.
Flicker (See note.):	Sets flicker display.
Control Flag (See note.):	Sets object display/hide.
Size/Position (See note.):	Sets the object size and position.

Note: The Flicker, Control Flag, and Size/Position Tab Pages are displayed when the *Display Extension Tabs* checkbox is selected.

**General**

The General Tab page is used to select whether to display character strings or images.

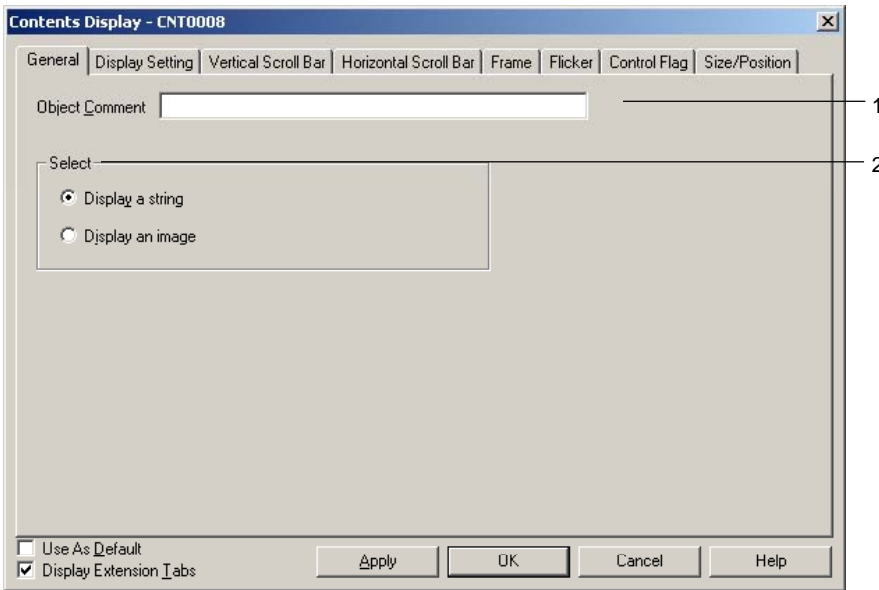

No.	Item	Details
1	Object Comment	Sets a comment to describe the pasted object. (Up to 32 characters. Single- and double-byte characters are counted as one character.)
2	Select	Selects whether to display a string or image file.

**Display Setting**

Sets the display method for strings and images.

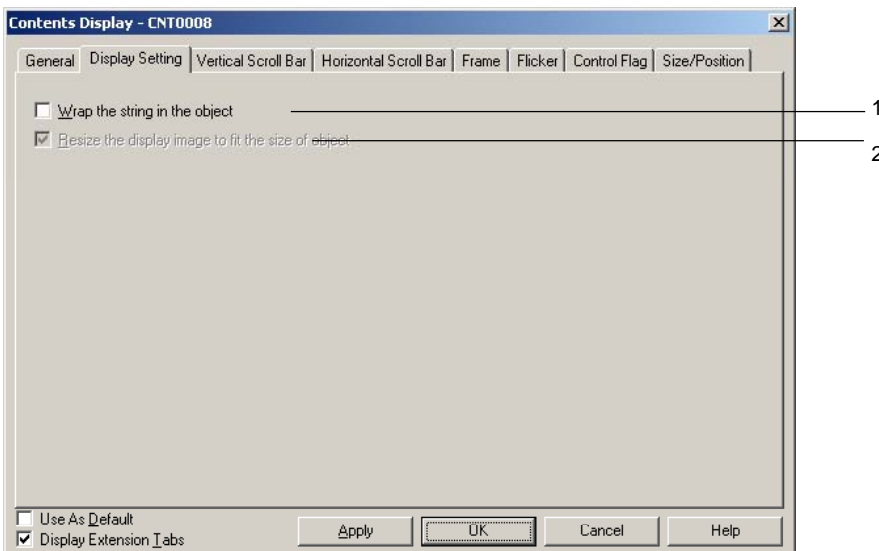

**NS Series Programming Manual**

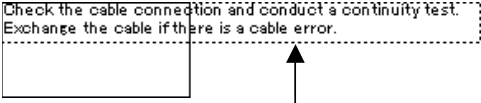
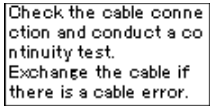
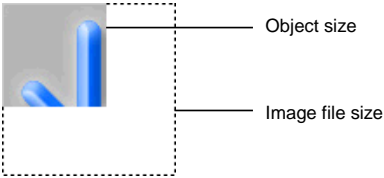
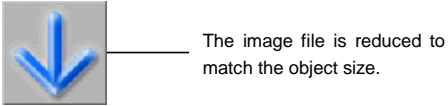
No.	Item	Details
1	Wrap the string in the object	<p>If this checkbox is selected, the string is wrapped at the end of the line to fit the width of the object.</p> <p>Example When the Wrap Function Is Not Used (i.e., When the Checkbox Is Deselected)</p>  <p>A string longer than the width of the object is set.</p> <p>Example When the Wrap Function Is Used (i.e., When the Checkbox Is Selected)</p>  <p>The text is wrapped at the right edge of the object and all characters are displayed on each line.</p> <p>This function is enabled when displaying strings.</p>
2	Resize the display image to fit the size of object	<p>When this checkbox is selected, the image is expanded or reduced to fit the size of the object.</p> <p>Example When the Image Is Displayed in Its Original Size (i.e., When the Checkbox Is Deselected)</p>  <p>Example When the Image Is Displayed To Match the Object Size (i.e., When the Checkbox Is Selected)</p>  <p>This function is enabled when images are displayed.</p>

**NS Series Programming Manual**

**Vertical Scroll Bar Tab Page**

The Vertical Scroll Bar Tab Page is used to display/hide the scroll bar and to set the scroll width and the button size for the vertical scroll bar. Strings are scrolled by line and images are scrolled by dot.

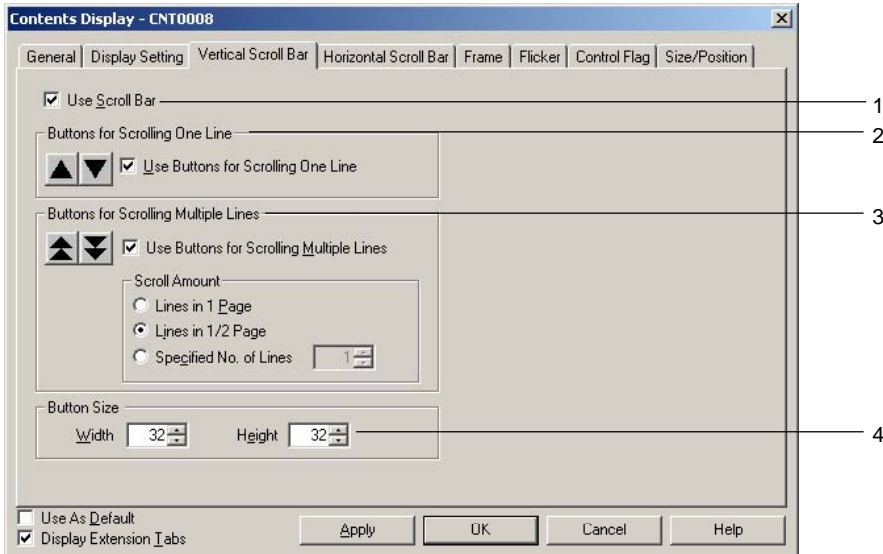

No.	Item	Details		
1	Use Scroll Bar	Select to use a scroll bar.		
2	Buttons for Scrolling One Line/ Buttons for Scrolling One Dot	Select this checkbox to use a one-line (one-dot) scroll button. Each time the scroll button is pressed the display will move up one line (for string display) or one dot (for image display).		
3	Buttons for Scrolling Multiple Lines/ Buttons for Scrolling Multiple Dots	Select this checkbox to use a scroll button that scrolls the specified number of lines (or dots). Select one of the following scroll amounts.		
		Scroll Amount	Lines in One Page/ Dots in One Page	Scrolls the number of lines displayed at one time, for string display. For image display, scrolls the number of dots displayed at one time.
			Lines 1/2 Page/ Dots 1/2 Page	Scrolls half the number of lines displayed at one time, for string display. For image display, scrolls half the number of dots displayed at one time.
			Specified No. of Lines/ Specified No. of Dots	Scrolls the specified number of lines for string display. Scrolls the specified number of dots for image display. (1 to 1,920).
4	Button Size	Sets the scroll button size dots (16 to 48).		

**NS Series Programming Manual**

**Horizontal Scroll Bar Tab Page**

The Horizontal Scroll Bar Tab Page is used to display/hide the scroll bar, and to set the scroll width and the button size for the horizontal scroll bar. Horizontal scroll is by dot for both string and image display.

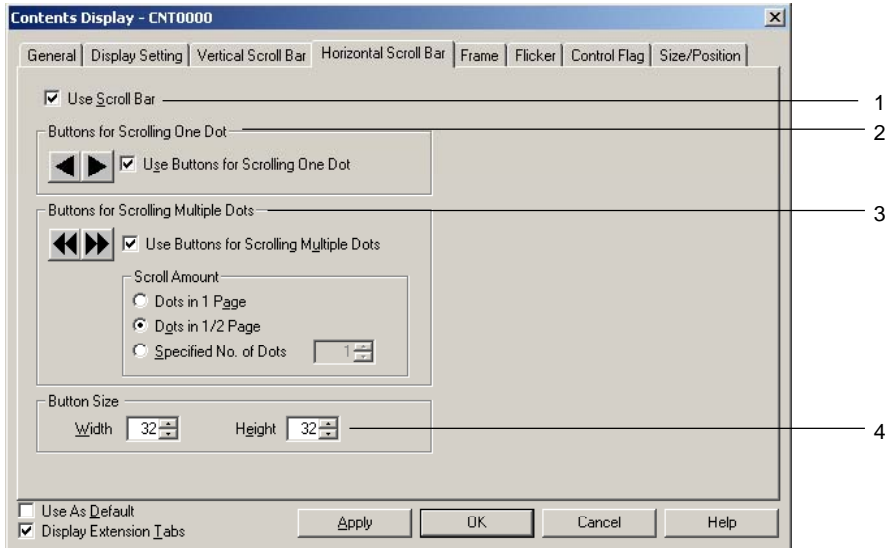

No.	Item	Details		
1	Use Scroll Bar	Select to use a scroll bar.		
2	Buttons for Scrolling One Dot	Select this checkbox to use one-line scroll buttons. The display moves one dot to the right or left each time a scroll button is pressed.		
3	Use Buttons for Scrolling Multiple Dots	Select this checkbox to use scroll buttons for a specified number of dots. Select one of the following scroll amounts.		
		Scroll Amount	Dots in One Page	Scrolls the display for the number of dots displayed at one time.
			Dots in 1/2 Page	Scrolls the display for half the number of dots displayed at one time.
			Specified No. of Dots	Scrolls the specified number of dots (1 to 2,560).
4	Button Size	Sets the scroll button size in line units (16 to 48).		

**Frame**

The Frame Tab Page is used to specify the frame color and size and to change the button shape and color. Refer to *Frames* in 2-8 Common Functional Object Functions for details.

**Flicker (Extension Tab)**

The Flicker Tab Page is used for settings to make objects flicker (flash). Refer to *Flicker* in 2-8 Common Functional Object Functions for details.

**NS Series Programming Manual**

**Control Flag (Extension Tab)**

The Control Flag Tab Page is used to control whether or not to display objects. These settings are used, for example, to enable display according to the ON/OFF status of a communications address. Refer to *Control Flags* in 2-8 *Common Functional Object Functions* for details.

**Size/Position (Extension Tab)**

The Size/Position Tab Page is used to display and set the size and position of functional objects. Refer to *Size/Position* in 2-8 *Common Functional Object Functions* for details.

**2-19-3 Usage Examples for Machine Navigator Function**

This section describes the settings for automatically displaying a pop-up screen showing countermeasures when an alarm occurs, as an example of the use of the Machine Navigator function.

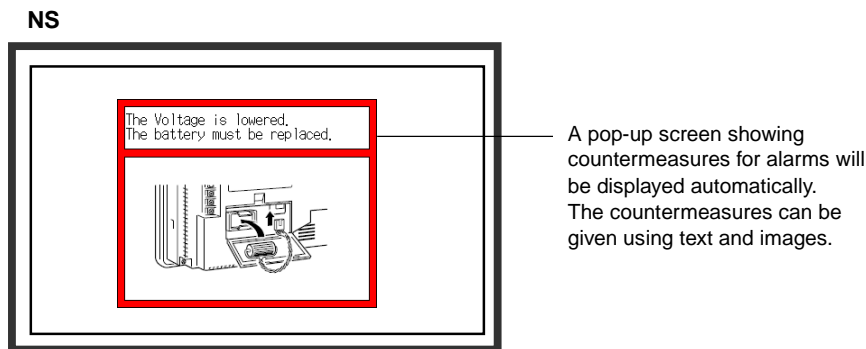

This section describes the method for creating the following screen data.

- Registering HOST1:100.00 and HOST1:100.01 as alarms.
- Displaying pop-up screen 100 when an alarm occurs.
- Displaying alarm countermeasures in pop-up screen 100. Nothing is displayed when no alarm has occurred.

**Creating Pop-up Screens**

1. Create pop-up screen 100.
2. Place two contents display objects in the created pop-up screen 100. One will be for string display and the other for image display. Set each one to *Display a String* or *Display an Image* in the Contents Property Settings Dialog Box.

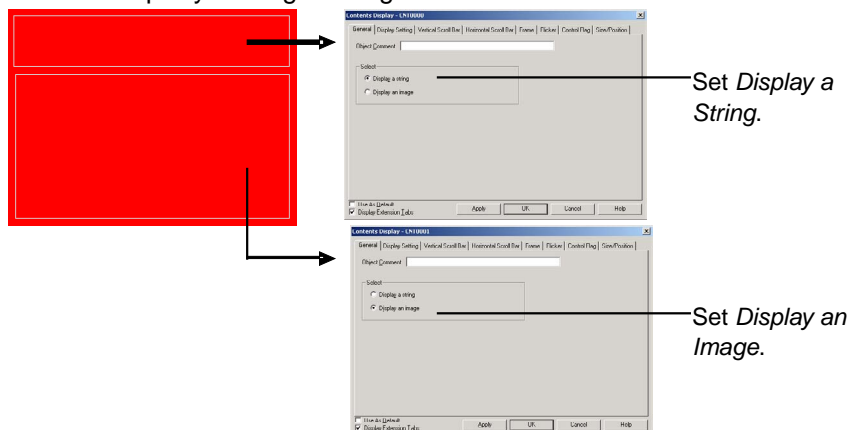

3. Click the **Edit Contents** Button on the Edit Content Toolbar.

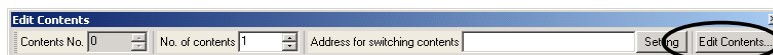

4. The Edit Contents Dialog Box will be displayed. Make the settings for switching contents.
  - Set "3" in the *No. of Contents* input field. (The setting "3" indicates the three statuses: the two

**NS Series Programming Manual**

when an alarm is generated and one when there is no alarm.)

- Select the *Link with Alarm* checkbox. (This checkbox is selected by default.)
- Set "0" in the *Contents No.* field.
- Set \$W100 as the *Address for switching contents.*

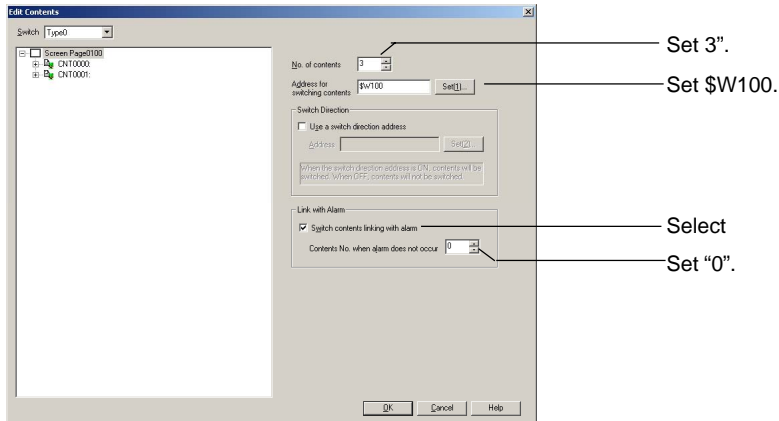

If the contents numbers are not displayed, click **+** after the settings have been input.

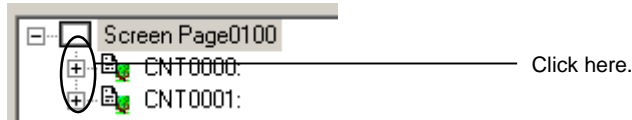

- 5 Set the contents. *Contents No. when alarm does not occur* has been set to Contents No. 0, so no settings are required.

- Click the string for Contents No. 1 and enter the string describing the countermeasure.
- Set the background color to white.

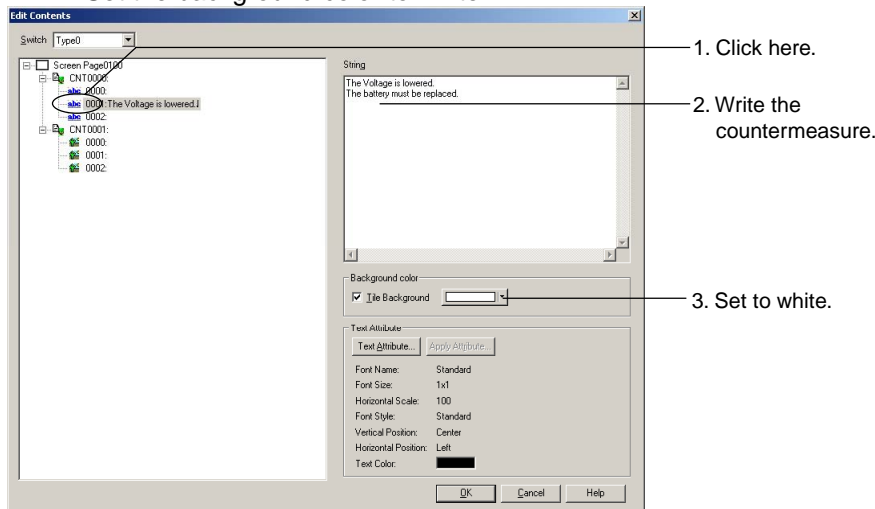

- Click the image for Contents No. 1 to set the image file showing the countermeasure.
- Set the background color to white.



**NS Series Programming Manual**

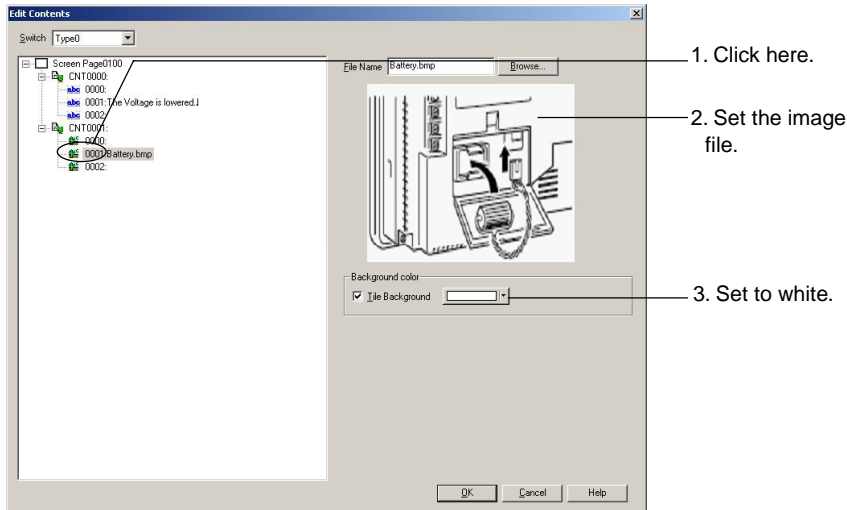

Make the settings the same way for contents number 2.

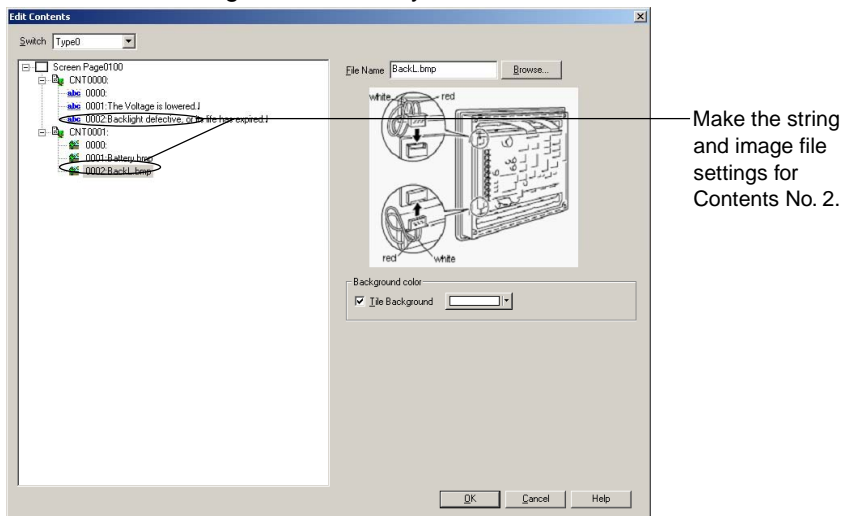

Click the **OK** Button to close the Edit Contents Dialog Box.

6 Make the alarm settings.

Select *PT – Alarm/Event Settings* to display the Alarm/Event Settings Dialog Box. Click the **Add** Button.

Make the settings for HOST1:100.00 in the Alarm/Event Details Dialog Box.

Use the following procedure to make the settings.

**NS Series Programming Manual**

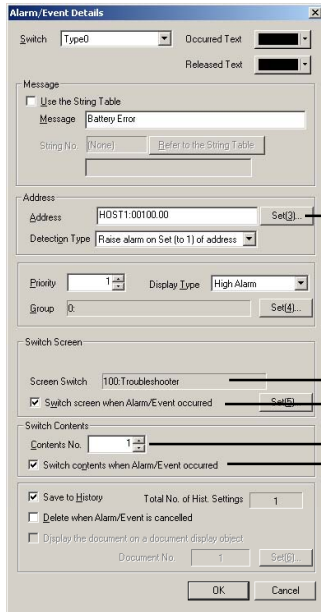

Set HOST1:100.00.

Set screen 100.  
 Select this checkbox.  
 Set to "1".  
 Select this checkbox.

Click the **OK** Button to close the Alarm/Event Details Dialog Box.

Make the settings for HOST1:100.01 in the same way. In this example, "2" will be set as the contents number.

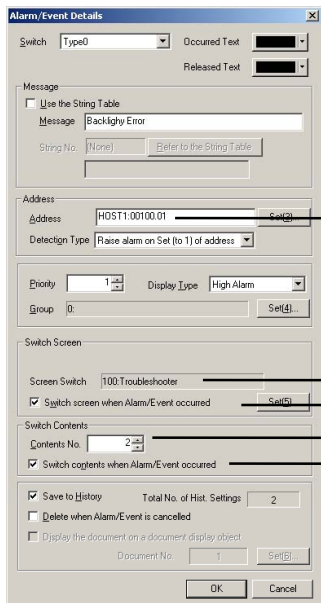

Set HOST1:100.01.

Set screen 100.  
 Select this checkbox.  
 Set "2".  
 Select this checkbox.

Click the **OK** Button to close the Alarm/Event Details Dialog Box.

Click the **OK** Button to close the Alarm/Event Dialog Box.

7 The settings have now been completed. Transfer the project data to the NS.

When HOST1:100.00 turns ON in the NS, pop-up screen 100 will be displayed and the contents for contents number 1 will be displayed.

When HOST1:100.01 turns ON in the NS, pop-up screen 100 will be displayed and the contents for contents number 2 will be displayed.

*NS Series Programming Manual*

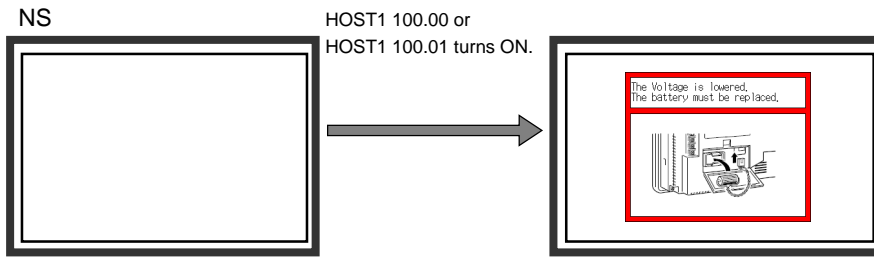

Pop-up screen 100 will be automatically displayed and the contents corresponding to the alarm will be shown in the contents display.

## 2-20 Special Functions

In addition to the various functional and fixed objects, NS-series PTs have functions that hold a variety of historical data and display or change host data. These functions are called special functions.

- Operation log function
- Alarm/event history function
- Data log function
- Error log function
- Screen saver function
- Buzzer function
- Time function
- Device monitor function
- Video Configuration

This section describes these functions.

### 2-20-1 Operation Log Function

The operation log function records the order and number of user operations.

The following touch panel usage and operations are recorded and saved in CSV format.

- Functional object operation history
- Screen display history
- Macro execution history
- Communications address bit change history

The records can be edited on a personal computer because they are saved as CSV files.

#### Operation Log Setting Procedure

Use the CX-Designer to make settings for the operation log of functional components and changes in communications addresses. There are no settings in the CX-Designer for the screen display history and macro execution history.

#### Functional Object Operation History

The operation log can be registered for seven types of functional objects: ON/OFF buttons, word buttons, numeral display & input, string display & input, thumbwheel switches, data block tables, and Multifunction Objects.

The following ways can be used to set the functional object for the operation log.

- Make the setting in the Property Setting Dialog Box for the functional object.
- Make the setting in the pop-up menu.

#### Making the Setting in the Property Dialog Box for the Functional Object

Select the *Record to Operation Log* Check Box on the Property Setting Write Tab Page (Extension Tab Page) of the functional object. Doing this will make the object recorded. Also, a message of up to 32 characters can be set for each label.

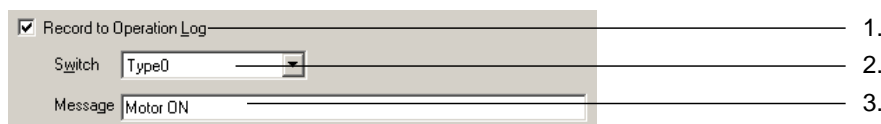

No.	Setting	Details
1	Record to Operation Log	Select to maintain an operation log for functional objects.
2	Switch	Sets the labels to be set.
3	Message	Sets a message string of up to 32 characters.

#### Making the Setting in the Pop-up Menu

1. Select the functional object to set for the operation log.

**NS Series Programming Manual**

2. Right-click to display the menu, and then select *Operation to Log Setting*.
3. The Operation Log Setting Dialog Box will be displayed.



No.	Setting	Details
1	Record to Operation Log	Select to maintain an operation log for the functional object.
2	Switch	Sets the label to be set.
3	Message	Sets a message string of up to 32 characters.

4. Click the **OK** Button.

**Note**

- ◆ Messages can be set if the project version is 8.0 or higher.

**Communications Address Value Change History**

Changes in bit-type communications address status can be recorded. Up to 16 communications addresses can be set.

Operation for items other than NS-series screens can be recorded by assigning control panel switches to PLC addresses.

1. Select the communications address (bit) for which to set the operation log from the symbol table.
2. Right-click to display a menu, and then select *Operation Log Setting*.
3. The Operation Log Setting Dialog Box will be displayed.

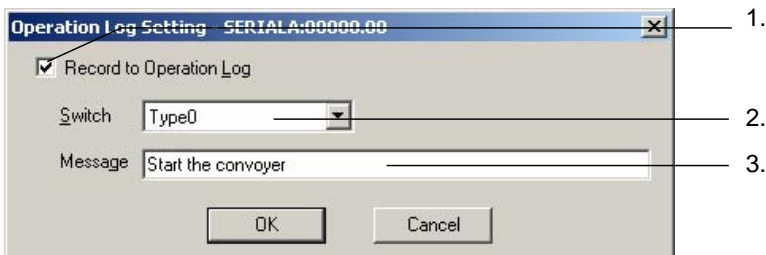

No.	Setting	Details
1	Record to Operation Log	Select to maintain an operation log for the functional object.
2	Switch	Sets the label to be set.
3	Message	Sets a message string of up to 32 characters.

4. Click the **OK** Button.

**Note**

- ◆ The project data version must be version 8.0 or higher to record changes in communications addresses in the operation log.

## Procedure for Using Operation Logs

Perform the following procedure to use operation logs.

1. Initialize operation log.  
If necessary, initialize the operation log from the PT System Menu and clear old records before starting recording.
2. Execute operation log.  
Whether or not records will be kept for functional object operations, screen displays, or macro execution will be determined by the contents of system memory for each object.
  - 1) Functional object operation history and communications address value change history →  
\$SB39 ON: Execute OFF: Not execute
  - 2) Screen display history →  
\$SB40 ON: Execute OFF: Not execute
  - 3) Macro execution history →  
\$SB41 ON: Execute OFF: Not execute
3. Confirm operation log records.  
Operation log records can be displayed and confirmed using the System Menu.  
The records can be displayed in the order the operations were performed (sort by occurrence) or in the order of frequency.

Time of Occurrence	History Type	Message	Item1	Item2	Item3
2008/04/26 09:42:25	Switch		From P:0000	To P: :0010	
2008/04/26 09:42:35	Ope	Setting1	Page:000	Obj ID:0000	Touch ON
2008/04/26 09:42:35	Switch		From P:0010	To P: :0031	
2008/04/26 09:42:37	Ope	Setting2	Page:000	Obj ID:0001	Touch ON
2008/04/26 09:42:40	Ope	Setting3	Page:000	Obj ID:0002	Touch ON
2008/04/26 09:42:42	Switch		From P:0010	To P: :0030	
2008/04/26 09:42:44	Ope	Save	Page:000	Obj ID:0014	Touch ON
2008/04/26 09:42:44	Macro		Page:000	Obj ID:0014	Touch ON
2008/04/26 09:42:45	Ope	Save	Page:000	Obj ID:0014	Touch OFF
2008/04/26 09:42:54	address	Manual Switch	SERIALA	00100_04	Address ON
2008/04/26 09:42:57	Switch		From P:0010	To P: :0011	
2008/04/26 09:43:02	Ope	Setting4	Page:001	Obj ID:0003	Touch ON
2008/04/26 09:43:05	Ope	Setting5	Page:001	Obj ID:0004	Touch ON
2008/04/26 09:43:08	Ope	Update	Page:001	Obj ID:0023	Touch ON
2008/04/26 09:43:10	Ope	Update	Page:001	Obj ID:0023	Touch OFF
2008/04/26 09:43:12	Ope	Save	Page:001	Obj ID:0013	Touch ON
2008/04/26 09:43:12	Macro		Page:001	Obj ID:0013	Touch ON
2008/04/26 09:43:12	Ope	Save	Page:001	Obj ID:0013	Touch OFF
2008/04/26 09:43:16	address	Manual Switch	SERIALA	00100_04	Address OFF
2008/04/26 09:43:17	address	Automatic Switch	SERIALA	00100_05	Address ON
2008/04/26 09:43:22	Ope	Run	Page:001	Obj ID:0021	Touch ON
2008/04/26 09:43:23	Ope	Run	Page:001	Obj ID:0021	Touch OFF

### Note

- ◆ When screens with sheets have been displayed, the normal screen display records will remain but there will be no record of the sheet display.
- ◆ The following methods can also be used to initialize the operation log data.
  - Turn ON system memory \$SB37 from the host.
  - Execute a Multifunction Object for which Operation Log Initialization is set.
- ◆ You can set whether to automatically initialize log data when screen data is downloaded by selecting **PT – Transfer** in the Transfer Settings Menu.  
In the following cases, however, be sure to initialize the log data.
  - When alarm/event settings, data log settings, the operation log, or other settings related to logs are changed.
  - When a project different from the project stored in the NS-series PT is downloaded.

## Operation Log Record Format

The data listed below is recorded as the operation log.

This data can be saved as a CSV file to a Memory Card by using any of the following methods.

- Turning ON system memory bit \$SB38.
- Execute a Multifunction Object for which Operation Log Save is set.
- Click the Save Button for the operation log in the Data Initialization Screen of the System Menu.
- Click the Save Log Button in the Operation Log (Sort by Occurrence) Screen or Operation Log (Sort by Frequency) Screen.

The name of the CSV file is Operat\_yymmdd\_hhmmss.CSV.

**NS Series Programming Manual**

Operat\_yymmdd\_hhmmss.CSV

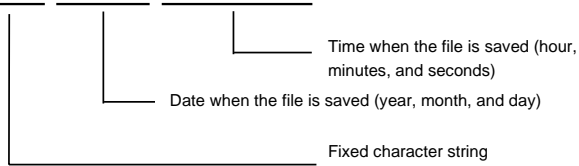

1. Functional object operation history

- Date and time of operation
- History type ("O")
- Message
- Screen number
- Functional object ID number
- Event type (20: Touch switch ON 21: Touch switch OFF)

Example: How to read functional log operation histories saved as CSV files.

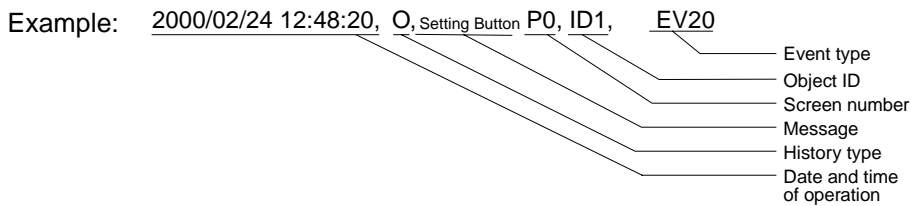

Meaning: A functional object with ID number 1 was touched on screen 0 on 2000/02/24 at 12:48:20.

2. Screen display history

- Date and time of screen display
- History type ("P")
- Original screen number
- Destination screen number

Example: How to read screen display histories saved as CSV files.

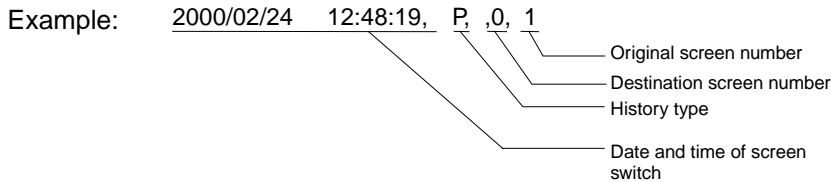

Meaning: Switched from screen 0 to screen 1 on 2000/02/24 at 12:48:19.

3. Macro execution history

- Time and date of macro execution
- History type ("M")
- Screen number (-1 for project macros.)
- Functional object ID (-1 for project macros and screen macros.)
- Macro execution type
  - 0: When loading a project
  - 4: Alarm/Event ON
  - 5: Alarm/Event OFF
  - 10: When loading a screen
  - 11: When unloading a screen
  - 20: Touch ON
  - 21: Touch OFF
  - 22: Before inputting numeral and string
  - 23: Before writing numeral and string
  - 25: When changing numeral or string
  - 26: When selecting a list
  - 30: When pressing a Display Area

**NS Series Programming Manual**

31: When selecting an Alarm/Event

Example: How to read macro execution histories saved as CSV files.



Meaning: Macro executed when the touch switch for functional object with ID 2 turned ON in screen 0 on 2000/02/24 at 12:48:25.

4. Communications address value change history

- Time and date of occurrence
- History type
- Message
- Event type (40: Address ON, 41: Address OFF)

Interpreting CSV Files Containing Communications Address Value Change Histories

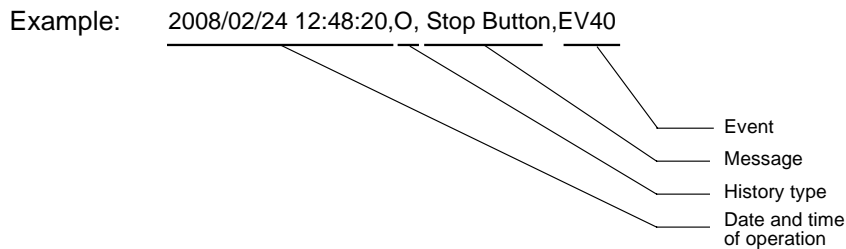

Meaning: The stop button was turned ON at 12:48:20 on 2008/02/24.

**Note**

- ◆ CSV files are saved to directory \LOG\OPERAT on the Memory Card.
- ◆ The CSV file name is fixed to Operat.csv, so any previously output Operat.csv file will be overwritten.
- ◆ For project versions lower than version 8.0, operation log data is output to a file called Operat.SCV file in /log/ direction on the Memory Card. The file name is always the same, so any previously output data will be overwritten.



### Maximum Number of Records

Up to 1,024 operations can be recorded.

Set the maximum number to be recorded under the History Tab Page under *PT - System Setting* on the CX-Designer.

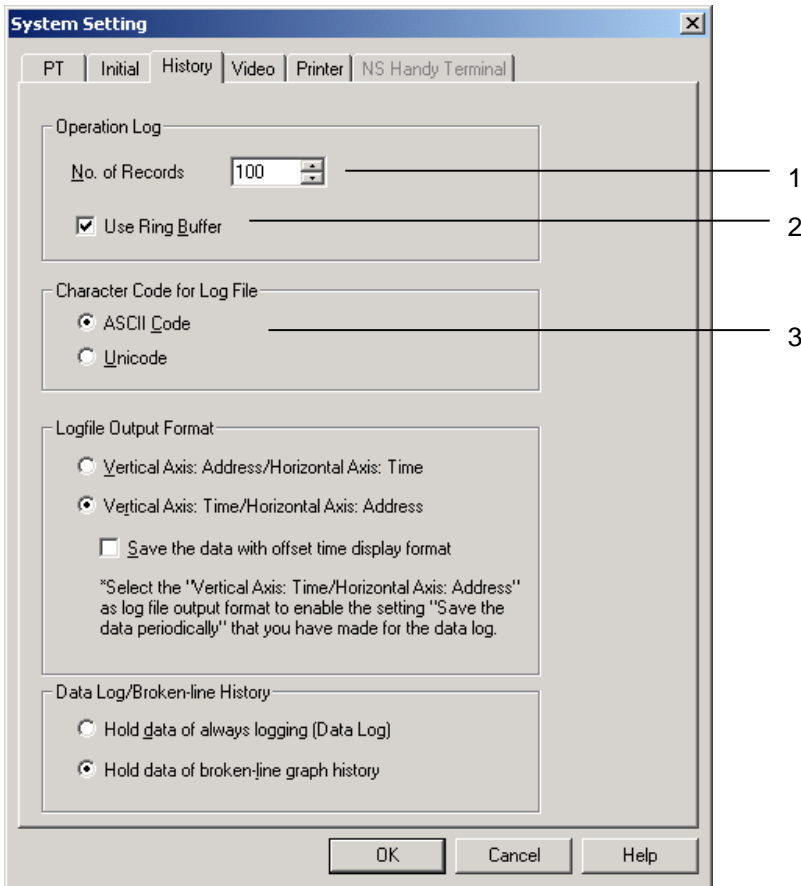

No.	Setting	Details
1	No. of records	Sets the number of operations to be recorded.
2	Use Ring Buffer	Select this option to save in ring buffer format.
3	Character Code for Log file	Select the character format to output the log file from multibyte or Unicode. "Log file" includes the alarm/event summary and history, data log, operation log, and error log.

If *Use Ring Buffer* is selected, the oldest records will be deleted in order when the set maximum has been exceeded and new data will be saved. If *Use Ring Buffer* is not selected, no more records will be kept when the set maximum is reached. The set record format can be checked under the System Menu.

## Checking the Log

The operation log can be checked on the Operation Log (Sort by Occurrence) Screen or Operation Log (Sort by Frequency) Screen of the System Menu.

The following methods can be used to display the Operation Log (Sort by Occurrence) Screen or Operation Log (Sort by Frequency) Screen during operation.

- Switch screens in the System Menu.
- Execute a Multifunction Object for which displaying the operation log is set (display from user screen).

### Switching Screens in the System Menu

1. Select *Operation Log (Sort by Occurrence)* or *Operation Log (Sort by Frequency)* from the Special Screen Tab Page of the System Menu.

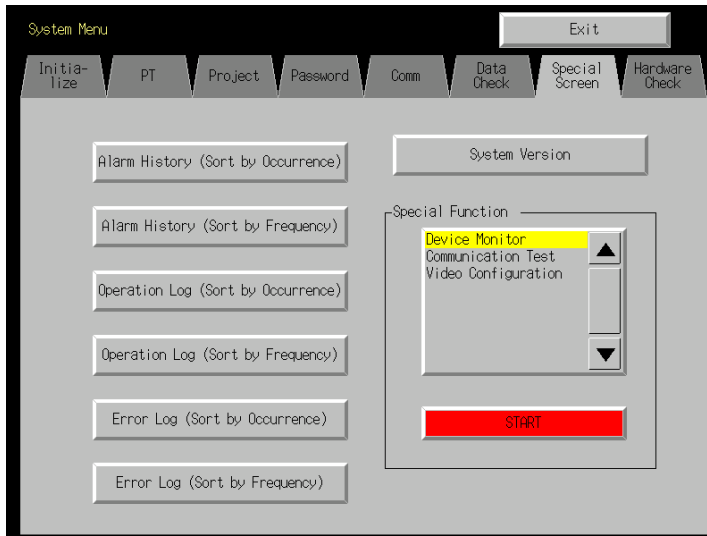

2. The operation log can be checked.

Time of Occurrence	History Type	Message	Item1	Item2	Item3
2008/04/26 09:42:25	Switch		From P:0000	To P:0010	
2008/04/26 09:42:30	Opn.	Setting1	Page:0010	Obj:ID:0000	Touch ON t
2008/04/26 09:42:35	Switch		From P:0010	To P:0001	
2008/04/26 09:42:37	Opn.	Setting2	Page:0010	Obj:ID:0001	Touch ON t
2008/04/26 09:42:40	Opn.	Setting3	Page:0010	Obj:ID:0002	Touch ON t
2008/04/26 09:42:42	Switch		From P:0010	To P:0000	
2008/04/26 09:42:44	Opn.	Save	Page:0010	Obj:ID:0014	Touch ON t
2008/04/26 09:42:44	Macro		Page:0010	Obj:ID:0014	Touch ON t
2008/04/26 09:42:45	Opn.	Save	Page:0010	Obj:ID:0014	Touch OFF
2008/04/26 09:42:54	Address	Manual Switch	SERIALA	00100.04	Address ON
2008/04/26 09:42:57	Switch		From P:0010	To P:0011	
2008/04/26 09:43:02	Opn.	Setting4	Page:0011	Obj:ID:0003	Touch ON t
2008/04/26 09:43:05	Opn.	Setting6	Page:0011	Obj:ID:0004	Touch ON t
2008/04/26 09:43:09	Opn.	Update	Page:0011	Obj:ID:0023	Touch ON t
2008/04/26 09:43:10	Opn.	Update	Page:0011	Obj:ID:0023	Touch OFF
2008/04/26 09:43:12	Opn.	Save	Page:0011	Obj:ID:0013	Touch ON t
2008/04/26 09:43:12	Macro		Page:0011	Obj:ID:0013	Touch ON t
2008/04/26 09:43:12	Opn.	Save	Page:0011	Obj:ID:0013	Touch OFF
2008/04/26 09:43:16	Address	Manual Switch	SERIALA	00100.04	Address OF
2008/04/26 09:43:17	Address	Automatic Switch	SERIALA	00100.05	Address ON
2008/04/26 09:43:22	Opn.	Run	Page:0011	Obj:ID:0021	Touch ON t
2008/04/26 09:43:23	Opn.	Run	Page:0011	Obj:ID:0021	Touch OFF

### Executing a Multifunction Object Set to Display the Operation Log

1. Create a Multifunction Object on a user screen.
2. Select **Switch Screen – Display System Menu – Operation Log (Sort by Occurr.)** or **Operation Log (Sort by Freq.)** in the property settings of the Multifunction Object.

**NS Series Programming Manual**

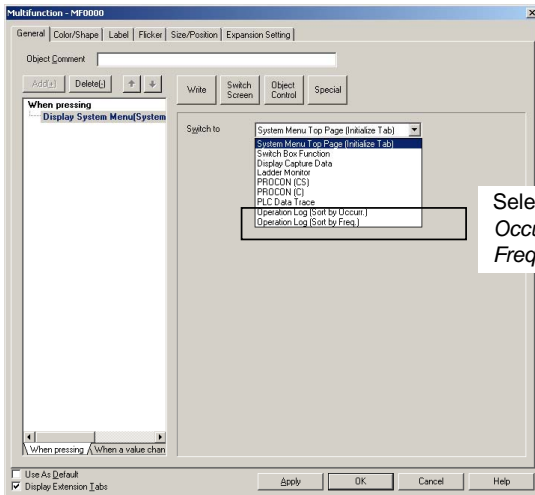

3. Execute the Multifunction Object in step 2 while the NS-series PT is operating.
4. The Operation Log (Sort by Occurrence) Screen or Operation Log (Sort by Frequency) Screen will be displayed.

**Recording Operation for Control Panel Switches and Others Items Other Than an NS-series PT**

The operation log can record changes in bit address values if the project version is 8.0 or higher.

This function can be used to record operation of items other than an NS-series PT, such as control panel switches.

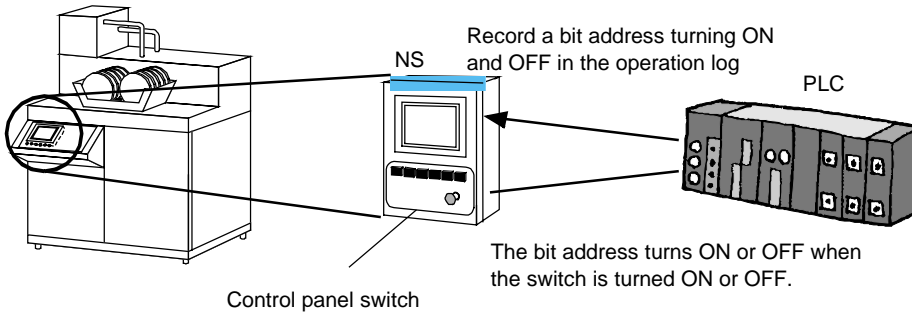

**CX-Designer Settings**

The following example shows the settings to record the operation of the *manual* switch and *automatic* switch on a control panel as shown in the following figure.

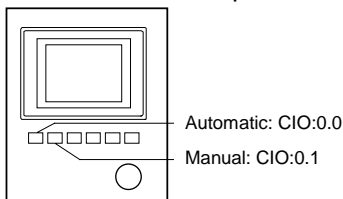

1. Register CIO 0.0 and CIO 0.1 in the CX-Designer's symbol table.
2. Select CIO0.0 in the symbol table.
3. Right-click to display the menu, and then select *Operation Log Setting*.

**NS Series Programming Manual**

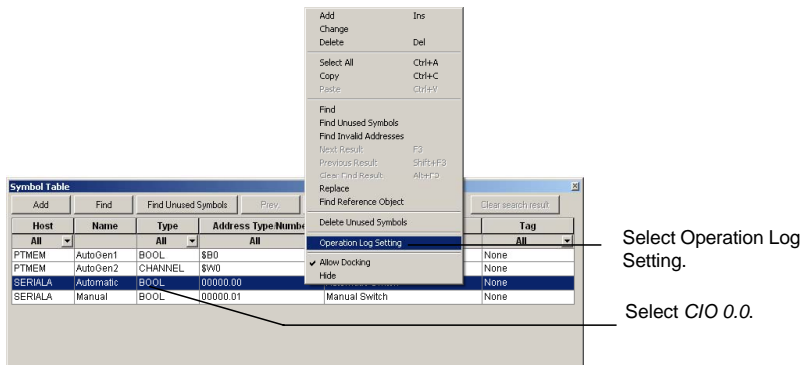

- Setting Dialog Box will be displayed.  
Select the *Record to Operation Log* Check Box.  
Input Automatic Switch into the *Message* Field, and then click the OK Button.

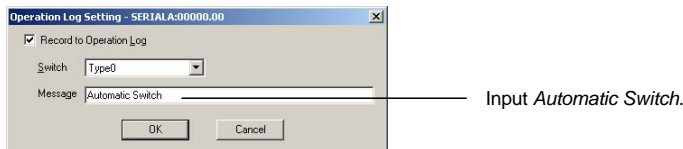
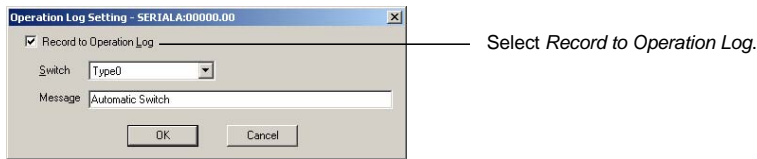

- Use the same procedure to set the operation log for CIO0.1.

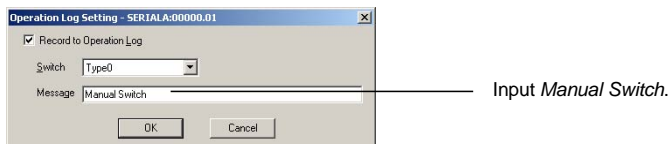
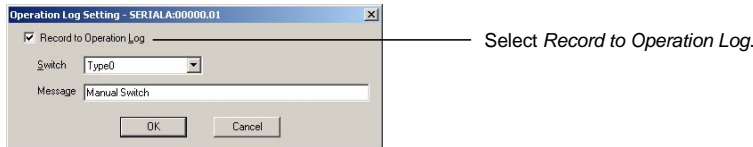

- Create a Multifunction Object on any screen and make the following settings.

Execution timing	Function	Label
When pressing	<b>Switch Screen – System Menu Display – Operation Log (Sort by Occurrence)</b>	Operation Log Display

- In the same way, create a Multifunction Object and make the following setting

Execution timing	Function	Label
When pressing	<b>Special – Operation Log Control – Operation Log Save.</b>	Operation Log Save

- Transfer this project to the NS-series PT.

**Operation with the NS-series PT**

- Start the NS-series PT that includes the project created above.
- Turn ON \$SB39.
- The status of CIO 0.0 and CIO 0.1 (ON and OFF for the automatic switch and manual switch) will be registered in the operation log.

**NS Series Programming Manual**

- Click the **Operation Log Display Button**. The Operation Log (Sort by Occurrence) Screen in the System Menu will be displayed. The operation log can be checked for the *automatic* switch and *manual* switch.

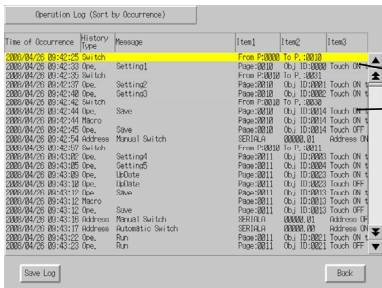

The operation log can be checked for the *automatic* switch and *manual* switch.

- Click the **Operation Log Save Button**.

Date&Time	O	Message	Page	ID	Event
Date&Time	P	Message	Page	Host	NewPower
Date&Time	M	Message	Page	Host	Event
Date&Time	A	Message	Host	Address	Event
2008/4/26 9:42 P			0	10	
2008/4/26 9:42 P		Setting1	P10	100	EV00
2008/4/26 9:42 O		Setting2	P10	101	EV00
2008/4/26 9:42 O		Setting2	P10	102	EV00
2008/4/26 9:42 P			10	30	
2008/4/26 9:42 O		Save	P10	1014	EV00
2008/4/26 9:42 M			P10	1014	EV00
2008/4/26 9:42 O		Save	P10	1014	EV21
2008/4/26 9:42 A		Manual Switch	SERIALA	0001	EV40
2008/4/26 9:42 P			10	11	
2008/4/26 9:43 O		Setting4	P11	100	EV00

The automatic switch and manual switch will be registered in the operation log.

## 2-20-2 Alarm/Event History Function

The alarm/event history function continually checks the status of bits registered as alarms or events and records the date, time, and frequency during operation when the bit turns ON. The records can be edited on a personal computer because they are saved as CSV files.

### Procedure for Using Alarm/event Histories

Perform the following procedure to use the alarm/event history function.

1. Make alarm/event history settings.  
When a screen is created using CX-Designer, register the bit memory as an alarm or event under *PT - Alarm/Event setting*. Make related information and other settings as required. Refer to *Outline in 2-14 Alarms and Events* for details on alarm/event settings.
2. Initialize alarm/event history.  
If necessary, initialize the alarm/event history from the PT System Menu and clear old records before starting recording.
3. Execute alarm/event history.  
When bits registered as alarms/events turn ON or OFF during PT operation, a record will be kept that alarms/events occurred or were cleared.
4. Confirm alarm/event history records.  
There are two methods for checking the alarm/event history records.
  - Check using System Menu. Alarm histories can be checked under the System Menu. The records can be displayed in the order the alarms/events occurred (sort by occurrence) or in the order of frequency.
  - Check using functional objects. The records can be checked using alarm/event summary and histories created on screens. The records can be displayed in order of occurrence, order of frequency, or order of priority.

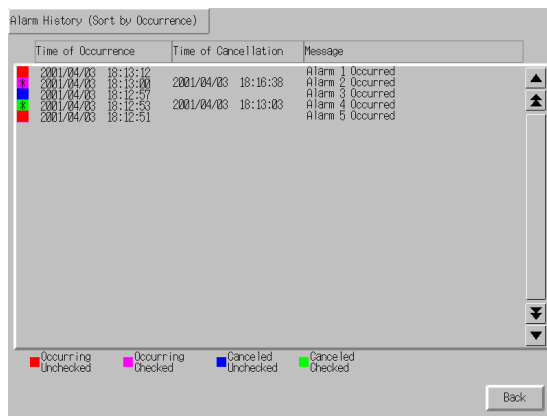

### Note

- ◆ Alarm/event histories can be initialized using system memory bit \$SB32.
- ◆ You can set whether to automatically initialize log data when screen data is downloaded by selecting *PT – Transfer* in the Transfer Settings Menu.

In the following cases, however, be sure to initialize the log data.

- Alarm/event settings, data log settings, or other settings related to logs are changed.
- A project different from the project stored in the NS-series PT is downloaded.

## Alarm/Event History Record Format

The following data is stored to memory for alarm/event histories.

- Alarm number (ID)
- Time and date of alarm/event (On-date & time)
- Time and date alarm/event cleared (Off-date & time)
- Time and date checked (Confirm-date & time)
- Number of occurrences (On-count)
- Related information value 1 (Val 1)
- Related information value 2 (Val 2)
- Related information value 3 (Val 3)
- Message

The related information values are the contents of the addresses set under *Alarm/Event setting*.

This data can be saved as a CSV file to a Memory Card by turning ON system memory bit \$SB33. Alarm histories are saved in a file called Alarm.csv and event histories in a file called Event.csv.

Example: How to read alarm/event histories saved as CSV files.

Example:

Alarm number	Date and time of alarm/event	Date and time cleared
1, 2000/02/24 14:55:13,	2000/02/24 14:58:21,	
2000/02/24 14:57:34,	12, 34, 67, 89,	"Alarm 1"
Date and time checked	Number of occurrences	Message
	Related information values 1, 2, and 3	

Meaning: Alarm 1 occurred on 2000/02/24 at 14:55:13, was cleared on 2000/02/24 at 14:58:21, and checked on 2000/02/24 at 14:57:34.

This alarm has occurred 12 times.

The contents of the addresses set to related information values 1 to 3 are 34, 67, and 89, respectively.

The message for alarm 1 is "Alarm 1".

Event histories are saved in the same format as alarm histories, i.e., as CSV files.

### Note

- ◆ CSV files are saved to directory \LOG on the Memory Card.
- ◆ The CSV file names are fixed to Alarm.csv and Event.csv, so any previously output Alarm.csv or Event.csv files will be overwritten.

## Maximum Number of Records

Up to 1,024 alarm records and 1,024 event records can be kept.

Set the number of alarm and event records under *PT/Alarm/Event setting/Alarm/Event Parameter* on the CX-Designer. If *Use Ring Buffer* is selected, the oldest data will be deleted and new data saved in its place when the maximum number of records is exceeded. The set record format can be checked under the System Menu.

## Checking Records

Displays the alarm history from the System Menu during operation.



1. Select *Special screen/Alarm history (sort by occurrence)* or *Alarm history (sort by frequency)* from the System Menu.
2. Check the alarm history. (The event history cannot be checked.)

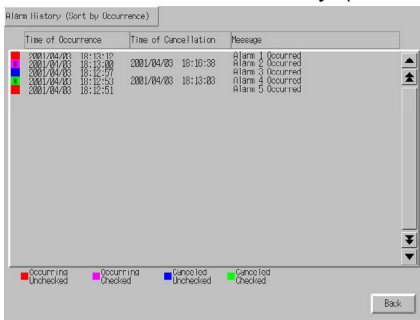

The alarm history can also be checked during operation by using an alarm/event summary and history functional object.

### 2-20-3 Data Log Function

The data log function is used to register changes over time to the contents of a registered address. The data can be edited on a personal computer because it is saved as a CSV file.

#### Procedure for Using Data Logs

Perform the following procedure to use the data log function.

1. Make the data log settings.  
Register addresses under *PT – Data Log setting* when creating a screen with CX-Designer.  
Refer to *Outline* in 2-15 *Data Logs* for information on data log setting.
2. Initialize data log.  
If necessary, initialize the data log from the PT System Menu and clear old records before starting recording.
3. Execute the data log.  
Records address contents during PT operation at a specified timing.  
The data logging timing is set under *Settings/Data log setting*.
4. Check data log records.  
The data log records are displayed on a data log graph functional object.



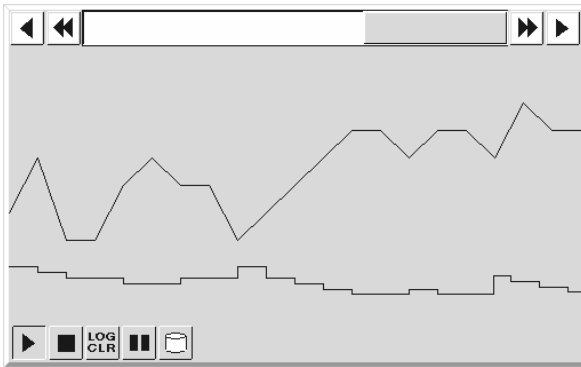

**Note**

- ◆ Data logs can be initialized using system memory bit \$SB35.
- ◆ You can set whether to automatically initialize log data when screen data is downloaded by selecting **PT - Transfer** in the Transfer Settings Menu.

In the following cases, however, be sure to initialize the log data.

- Alarm/event settings, data log settings, the operation log, or other settings related to logs are changed.
- A project different from the project stored in the NS-series PT is downloaded.

**Data Log Record Format**

The data listed below is recorded as the data log.

- Group number
  - Date and time data 1<sup>st</sup> saved
  - Date and time data saved 2<sup>nd</sup> time
  - ...
- } Date and time of data sampling
- 
- Data 1 address
  - Data 1 contents (1<sup>st</sup> log)
  - Data 1 contents (2<sup>nd</sup> log)
  - ...
  - Data 2 address
  - Data 2 contents (1<sup>st</sup> log)
  - Data 2 contents (2<sup>nd</sup> log)
  - ...
- } Sampled data (by address)

Data 1 and data 2 indicate addresses registered under the data log settings. This data is saved in CSV file format to a Memory Card when system memory bit \$SB36 turns ON or the save icon for data log graphs is pressed.

When the data is saved as a result of \$SB36 turning ON, it is saved to a Trend@.csv file. (See note 1.) The data for all registered data log groups will be saved to file if 0 is stored in \$SW37. If a value other than 0 is stored in \$SW37, only the log data for that group number will be saved to file. (See note 2.)

If the data is saved as a result of the data log graph save icon being pressed, the data will be saved to a Trd□□.csv file. (See note 2.) When the data is saved using the save icon, only the data for data log groups registered to the data log graph will be saved to the file. The CSV file name can be changed.

Note 1: When "0" is stored in \$SW37

**NS Series Programming Manual**

Trend□.csv  
 001 to 999  
 Beginning with 001, the number is automatically incremented by 1 each time the save operation is executed. After 999, the number reverts to 001.

Note 2: Data is saved either when a value other than "0" is stored in \$SW37, or using the save icon.

Trd□□.csv  
 001 to 999 (001 to 099 if the output file names are 6 characters or longer)  
 The ID number for files saved for each group. Beginning with 001, the number is automatically incremented by 1 each time the output operation is executed. After 999, the number reverts to 001.  
 00 to 99  
 Indicates one less than the group number (1 to 100).

**Example: How to read data logs saved as CSV files**

**Vertical axis: Addresses, Horizontal axis: Times**

Example:

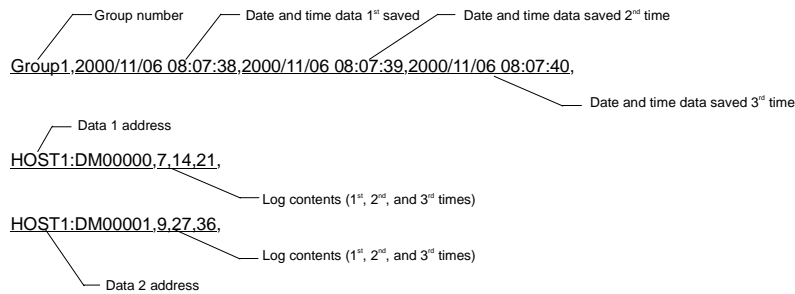

**Vertical axis: Times, Horizontal axis: Addresses**

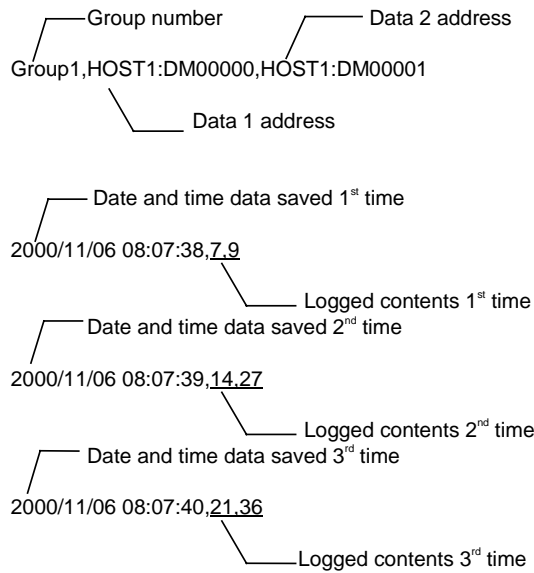

**Note**

- ◆ The order that data is saved in a CSV file can be changed by setting the data log file output format on the History Tab Page under *Settings*.
- ◆ HOST1 is the host name set in the Comm. Setting Dialog Box, which is opened by selecting **PT – Communication Setting**.
- ◆ Up to 999 CSV files can be saved each for Trend□.csv and Trd□□.csv. When this number is exceeded, the saved files will be overwritten in order beginning with 001.
- ◆ If a Trd□□.csv file is saved, a folder is created for each group below the \LOG\Trend folder in the Memory Card directory. The name of the folder will be the name of the output file. Up to 999 CSV files will be saved in each folder if the output file names are less than five characters long. If more than 999 files are saved, the saved files will be overwritten in order beginning from 001. Only up to 099 CSV files will be saved in each folder if the output file names are six characters or more. If more than 099 files are saved, the saved files will be overwritten in order beginning from 001.
- ◆ If the Memory Card is full when a data log save is executed, the file with the oldest file number will be overwritten. (Before project version 5.0)
- ◆ Saving will be stopped when the Memory Card has no more available space. When the file number reaches the upper limit, the oldest number will be overwritten as new files are saved. (This applies to project version 6.0 or higher.)

**Maximum Number of Records**

Up to 50,000 records can be kept for each group.

The number of records is set under *PT – Data Log setting* on the CX-Designer.

The set ring buffer format is fixed for records. With the ring buffer format, the oldest data is deleted when the maximum number of records is exceeded and new data is then recorded.

**Checking Records**

Records can be checked during operation by using data log graph functional objects.

Open the screen on which the data log graph was created.

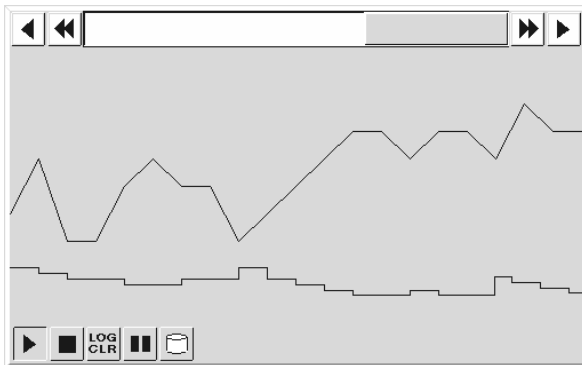

## 2-20-4 Error Log Function

The error log function keeps a record of macro execution errors.

### Procedure for Using Error Logs

Perform the following procedure to use the error log function.

1. Make the error log settings.  
There are no settings required on the CX-Designer for error logs.
2. Initialize error log.  
If necessary, initialize the error log from the PT System Menu and clear old records before starting recording.
3. Execute the error log function.  
Errors that occur when macros are executed during PT operation will be recorded.
4. Check error log records.  
Error log records are displayed from the System Menu.  
The records can be displayed in the order the errors occurred (sort by occurrence) or in the order of frequency.

Time of Occurrence	Page No.	Object ID	Macro ID	Error Type
2001/04/19 19:28:30	0014	0015	0020	0 Division Error
2001/04/19 19:28:23	0014	0126	0021	Macro Execution Error
2001/04/19 17:53:27	0014	0011	0020	BOD Error
2001/04/19 16:18:25	0014	0015	0020	0 Division Error
2001/04/19 13:23:33	0014	0015	0023	Argument Error
2001/04/19 12:23:17	0014	0025	0020	Macro Execution Error
2001/04/19 10:15:01	0014	0005	0020	Macro Execution Error

### Note

- ◆ The error log can be initialized using system memory bit \$SB42.
- ◆ You can set whether to automatically initialize log data when screen data is downloaded by selecting **PT – Transfer** in the Transfer Settings Menu.  
In the following cases, however, be sure to initialize the log data.
  - Alarm/event settings, data log settings, the operation log, or other settings related to logs are changed.
  - A project different from the project stored in the NS-series PT is downloaded.

### Error Log Record Format

The following data is stored to memory for error logs.

- Time and date of error
- Screen number (–1 for project macros.)
- Functional object ID (–1 for project macros and screen macros.)
- Macro execution type
  - 0: When loading a project
  - 4: Alarm/Event ON
  - 5: Alarm/Event OFF
  - 10: When loading a screen
  - 11: When unloading a screen
  - 20: Touch ON
  - 21: Touch OFF
  - 22: Before inputting numeral and string

**NS Series Programming Manual**

- 23: Before writing numeral and string
- 25: When changing numeral or string
- 26: When selecting a list
- 30: When Pressing a Display Area
- 31: When selecting an Alarm/Event

- Error number (1: Program error; 2: 0 allocation error; 3: BCD error; 4: argument error)

This data can be saved as a CSV file to a Memory Card by turning ON system memory bit \$SB43.

Example: How to read error logs saved as CSV files.

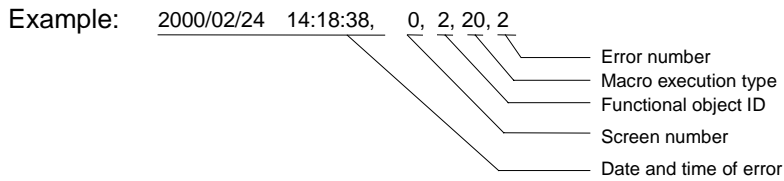

Meaning: Macro executed when the touch switch for functional object with ID 2 turned ON in screen 0 on 2000/02/24 at 14:18:38 PM.  
The error occurred because of a macro zero division.

**Maximum Number of Records**

Up to 100 records can be kept. The set ring buffer format is fixed for records. With the ring buffer format, the oldest data is deleted when the maximum number of records is exceeded and new data is then recorded.

**Checking Records**

Displays the error log from the System Menu during operation.

1. Select *Special screen/Error log (Sort by Occurrence)* or *Error log (Sort by Frequency)* from the System Menu.

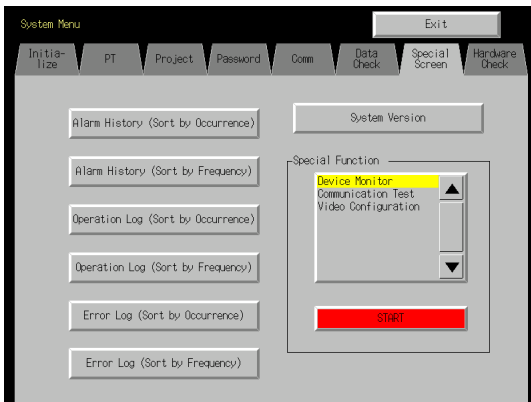

2. Check the error log.

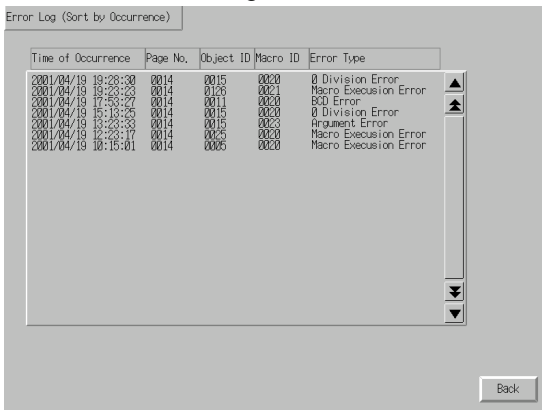

## 2-20-5 Screen Saver Function

NS-series PTs have a screen saver function to help preserve the life of the backlight. This function turns off the backlight and clears the screen if there has been no operation of the PT for a set period.

If the screen saver *Display Erased* function is used, the backlight turns OFF at the same time as the displayed screen is cleared. Use the *Display Erased* function to help preserve the life of the backlight.

The screen saver works only during PT operation. It will not operate during System Menu display.

### Note

- Do not carelessly press the screen when the backlight is not lit or when there is no display.  
Check system safety before pressing the screen.

## Displaying Cleared Screens

Screens that have been cleared using the screen saver function can be displayed again by pressing the PT screen or executing screen switch from the host. Even if the position for a functional object is pressed, the first input will be invalid after the PT screen is pressed to redisplay the screen.

Screens will not be re-displayed simply by changing numerals or character strings or by updating the display.

The screen saver function will be released if one of the operations listed below is performed by system memory or a macro.

- Switch screen (automatic screen switch from system memory, macro, or because of alarm or event)
- Opening, closing, or moving of pop-up screens (automatic screen switch from system memory, macro, or because of alarm or event)
- Error (Error Dialog Box displayed)
- Changing an Indirect Address (if the screen saver startup time is specified indirectly.)

## Screen Saver Function Settings

The screen saver settings can be made under CX-Designer system settings or from the System Menu. The settings include whether or not to use a screen saver and how long should lapse before the screen saver operates.

### Setting Screen Saver Using CX-Designer

- Select **PT - System setting**. The System Settings Dialog Box will be displayed. Select the PT Operation Tab Page.

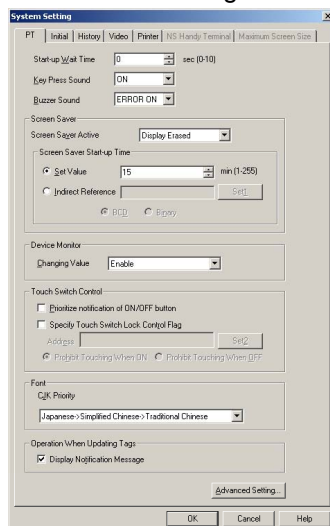

- Set *Display Erased* under *Screen Saver Active* and set the length of time in minutes (1 to 255) before the screen saver is started in the *Set Value* Field under *Screen Saver Start-up Time*.
- Select the *Indirect Reference* Option and set the communications address if the specified communications address value will be used as the screen saver start-up time.  
Select BCD or binary as the type for the value stored at the communications address.

**Note**

- ◆ If the screen saver start-up time is to be indirectly specified, store a value from 1 to 255 at the communications address in the specified format. The screen saver will not operate if a value outside that range is stored.

**Setting Screen Saver Using System Menu**

1. Open *PT* under the System Menu.

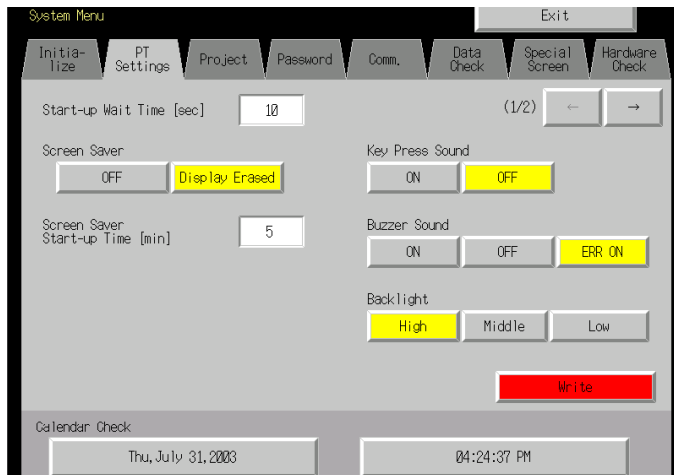

2. Set *Display Erased* under *Screen saver operation* and set the length of time in minutes (1 to 255) before the screen saver is started under *Screen Saver Start-up time*.
3. The allocation address will be displayed if the screen saver start-up time is specified indirectly. It cannot be set.

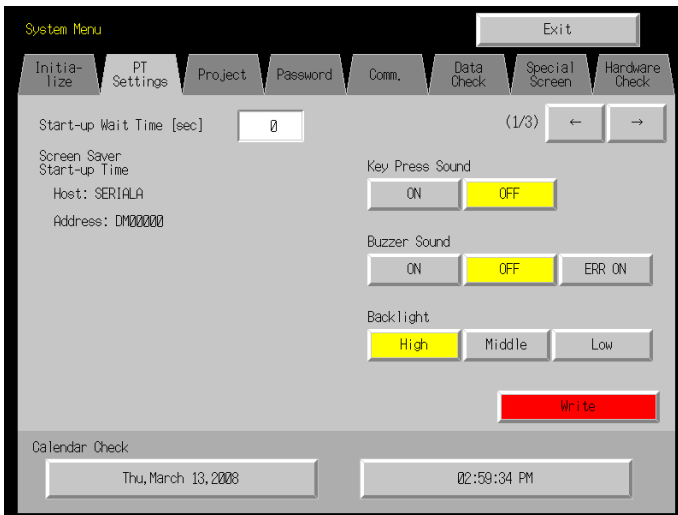

## 2-20-6 Buzzer Function

A PT buzzer can be sounded to signal an emergency situation or a host error.

### Reference

- ◆ The PT settings will determine whether or not a buzzer will actually sound.

One of the following three settings can be made.

OFF: The buzzer will not sound.

ERR ON: A buzzer will sound when a message is displayed using the “x” or “!” icons, when an error occurs on the PT.

ON A buzzer will sound when a message is displayed using the “x” or “!” icons or an instruction is given from the host that turns ON \$SB12 to \$SB14, when an error occurs on the PT.

The settings for buzzer sounds are made under the System Menu. Set the buzzer sounds under *PT - Buzzer sound* under the System Menu.

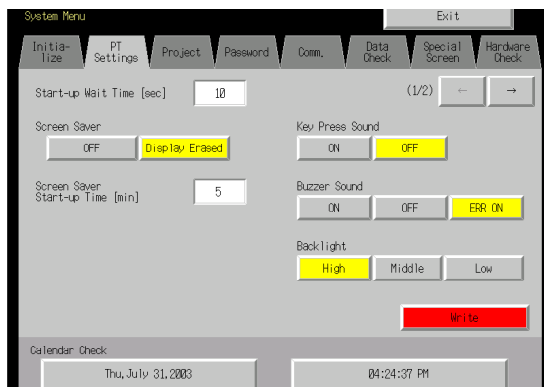

Refer to the next section *Buzzer Types* for information on continuous, short intermittent, and long intermittent buzzers.

The buzzer sound when functional objects are touched is not set under *Buzzer sound*. It is set under *Key Press sound*.

### Buzzer Types

Buzzer types can be controlled only from system memory.

Buzzer types cannot be set from the System Menu.

The following three types of buzzers can be sounded for NS-series PTs.

Continuous	Continuous buzzer	\$SB12
Short intermittent	Intermittent buzzer that repeats a cycle of sounding for 0.5 seconds and stopping for 0.5 seconds.	\$SB13
Long intermittent	Intermittent buzzer that repeats a cycle of sounding for 1 second and stopping for 1 second.	\$SB14

The order of priority for buzzers when multiple and different types of buzzers have been specified at the same time by system memory is outlined below. The highest priority buzzer is listed first and the corresponding system memory bit is indicated in parentheses ( ).

1. Continuous (\$SB12)
2. Short intermittent (\$SB13)
3. Long intermittent (\$SB14)

For example, the continuous buzzer will sound if continuous and short intermittent buzzers have been specified at the same time. If, for example, the long intermittent buzzer is specified while the short intermittent buzzer is sounding, the short intermittent buzzer will continue to sound.



## Sounding Buzzers

There are three ways to make buzzers sound on the PT.

### Control from Host

Buzzers can be sounded from the host if buzzers are set to ON under the CX-Designer system setting or the PT System Menu and system memory bits \$SB12 to \$SB14 are manipulated from the host during operation.

### Error Buzzers

Buzzers can be made to sound when communications or other errors occur during operation if buzzers are set to *ON* and *ERR ON* is set under the CX-Designer system setting or the PT System Menu.

### Dialog Box Buzzers

Buzzers can be made to sound when messages are displayed using the X or ! icons during operation if buzzers are set to *ON* and *ERR ON* is set under the CX-Designer system settings or the PT System Menu.

## Stopping Buzzers

Buzzers that are sounding can be stopped using the following methods.

- Turn OFF system memory bits \$SB12 to \$SB14 from the host.  
The buzzer will not stop, however, unless all bits for continuous, short intermittent, and long intermittent buzzers are changed to 0 (OFF).
- Press a Command Button that has the buzzer stop function set to it.  
Bits \$SB12 to \$SB14 will turn OFF.

### 2-20-7 Clock Function

NS-series PTs have a clock function used to set and display the date and time. The clock function is backed up by the built-in PT battery.

**Note**

- ◆ If the battery voltage drops, the time and date data can no longer be held when the PT is turned OFF or reset and the clock function will no longer operate correctly.
- ◆ Use the System Menu or create date or time functional objects and operate these to make and change date and time settings.

#### Setting Clock Data

There are two methods for setting clock data.

##### Setting from System Menu

Display the menu for displaying and setting clock data under the System Menu and make the settings. The date and time can be changed under *PT – Calendar Check* under the System Menu. The date and time will change as soon as the new settings are input. There is no need to press the Write Button.

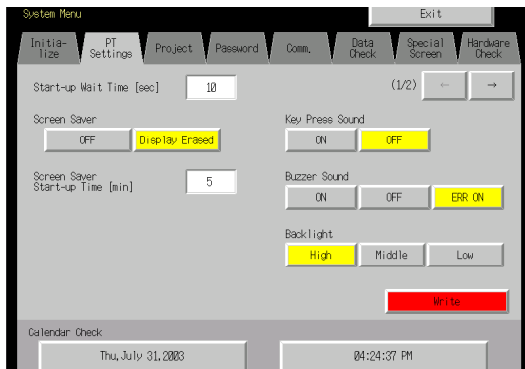

##### Setting from Functional Objects

Make the time data settings using data and time functional objects created on the screen.

The settings are input from the Date/Time Input Dialog Box.

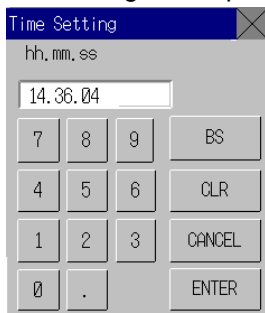

The date is entered in the yyyy.mm.dd format and the time is entered in the hh.mm.ss format.

Example

Date: 2000.4.22 (2000/4/22)

Time: 14.36.14 (2:36:14 PM)

When changing time during PT operation, refer to the table shown below and set the time.

	AM	PM
Time	0 1 2 3 4 5 6 7 8 9 10 11	0 1 2 3 4 5 6 7 8 9 10 11
Input to the PT	0 1 2 3 4 5 6 7 8 9 10 11	12 13 14 15 16 17 18 19 20 21 22 23

Refer to 3-9 *Displaying and Setting System Clock* for details.

## 2-20-8 Starting External Applications

The NS-series PTs provide the functionality to start ladder monitoring and other external applications.

### Method for Starting External Applications

External applications are started from the System Menu.

1. Display the System Menu, select the desired external applications from *Special Functions* on the Special Screen Tab Page, and press the **START** Button. (The following illustration shows the *Ladder Monitor* being selected.)

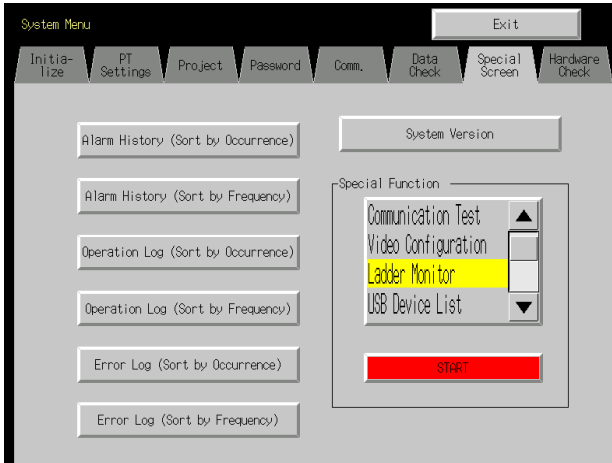

2. The PT will be reset.
3. The specified external application will be started after the PT restarts.

Refer to the manual for the external application for operating methods and procedures for messages that are displayed.

### Note

- ◆ *Ladder Monitor*, *Communication Test*, *Video Configuration*, *USB Device List*, *Show the Captured Data*, and *PLC Data Trace* are not external applications. If any of these is selected and the **START** Button is pressed, the display will change in the System Menu. The PT will not be restarted.
- ◆ For information on the *Ladder Monitor*, refer to the *NS-series Ladder Monitor Operation Manual* (Cat. No. V082).

The *Ladder Monitor Operation Manual* is included as a PDF file on the utility disk for the CX-Designer.

CX-Designer  
CD ROM:  
Utility\English\LadderMonitorFunc\V082.pdf

- ◆ Refer to 2-20-11 *Programming Console Functions* for information on programming console functions.

## 2-20-9 Device Monitor Function

NS-series PTs have, as standard, a device monitor function that displays in a list and changes the contents of PLC words and displays error data (details of PLC errors).

With CS/CJ Series PLCs only, NS-series switch box files exported from the CX-Designer's Switch Box Utility can be read to monitor or make changes to the data while viewing bit comments (using a Switch Box Screen). Error displays (such as details of errors in the PLC) can also be displayed.

<b>Note</b>	<p>When using the device monitor, check system safety before performing the following operations.</p> <ul style="list-style-type: none"> <li>• Changing monitor data or timer/counter current values</li> <li>• Switching operating mode</li> <li>• Forced set/reset</li> <li>• Changing timer/counter settings</li> </ul>
-------------	----------------------------------------------------------------------------------------------------------------------------------------------------------------------------------------------------------------------------------------------------------------------------------------------------------------------------

### Systems That Can Be Used

The combinations of PLCs and communications modes that can use the device monitor function are listed on the following table. Only PLCs marked with “\*1” can be used with the Switch Box Screens within the device monitor function.

Communications mode	Applicable PLCs	
1:1 NT Link	C200HS-CPU21 C200HS-CPU23 C200HS-CPU31 C200HS-CPU33 C200HE-CPU32-E/-ZE C200HE-CPU42-E/-ZE C200HG-CPU33-E/-ZE C200HG-CPU43-E/-ZE C200HG-CPU53-E/-ZE C200HG-CPU63-E/-ZE C200HX-CPU34-E/-ZE C200HX-CPU44-E/-ZE C200HX-CPU54-E/-ZE C200HX-CPU64-E/-ZE C200HX-CPU65-E/-ZE C200HX-CPU85-E/-ZE CQM1-CPU4 -V1 CQM1H-CPU21 CQM1H-CPU51 CQM1H-CPU61	CPM1A-10CD□-□ (-V1) CPM1A-20CD□-□ (-V1) CPM1A-30CD□-□ (-V1) CPM1A-40CD□-□ (-V1) CPM2A-30CP□□-□ CPM2A-40CP□□-□ CPM2A-60CP□□-□ CPM2C-10□□□□□□-□ CPM2C-20□□□□□□-□ CP1L-L14DR-□ CP1L-L20D□-D CP1L-L20DT1-D CP1L-M30D□-□ CP1L-M30DT1-D CP1L-M40D□-□ CP1L-M40DT1-D

**NS Series Programming Manual**

Communications mode	Applicable PLCs	
1:N NT Link	C200HE-CPU32-E/-ZE	CS1H-CPU67H (*1)
	C200HE-CPU42-E/-ZE	CJ1G-CPU42H (*1)
	C200HG-CPU33-E/-ZE	CJ1G-CPU43H (*1)
	C200HG-CPU43-E/-ZE	CJ1G-CPU44H (*1)
	C200HG-CPU53-E/-ZE	CJ1G-CPU45H (*1)
	C200HG-CPU63-E/-ZE	CJ1H-CPU65H (*1)
	C200HX-CPU34-E/-ZE	CJ1H-CPU66H (*1)
	C200HX-CPU44-E/-ZE	CJ1H-CPU67H (*1)
	C200HX-CPU54-E/-ZE	CJ1H-CPU65H-R (*1)
	C200HX-CPU64-E/-ZE	CJ1H-CPU66H-R (*1)
	C200HX-CPU65-E/-ZE	CJ1H-CPU67H-R (*1)
	C200HX-CPU85-E/-ZE	CJ1M-CPU12 (*1)
	CQM1H-CPU51	CJ1M-CPU13 (*1)
	CQM1H-CPU61	CJ1M-CPU22 (*1)
	CS1G-CPU42-E(V1) (*1)	CJ1M-CPU23 (*1)
	CS1G-CPU43-E(V1) (*1)	CP1H-XA40D□-□
	CS1G-CPU44-E(V1) (*1)	CP1H-XA40DT1-D
	CS1G-CPU45-E(V1) (*1)	CP1H-X40D□-□
	CS1H-CPU63-E(V1) (*1)	CP1H-Y20DT-D
	CS1H-CPU64-E(V1) (*1)	CP1L-L14DR-□
	CS1G-CPU45-E(V1) (*1)	CP1L-L20D□-D
	CS1H-CPU63-E(V1) (*1)	CP1L-L20DT1-D
	CS1H-CPU64-E(V1) (*1)	CP1L-M30D□-□
	CS1H-CPU65-E(V1) (*1)	CP1L-M30DT1-D
	CS1H-CPU66-E(V1) (*1)	CP1L-M40D□-□
	CS1H-CPU67-E(V1) (*1)	CP1L-M40DT1-D
	CS1G-CPU42H (*1)	CJ2H-CPU64 (-EIP)
	CS1G-CPU43H (*1)	CJ2H-CPU65 (-EIP)
	CS1G-CPU44H (*1)	CJ2H-CPU66 (-EIP)
	CS1G-CPU45H (*1)	CJ2H-CPU67 (-EIP)
	CS1H-CPU63H (*1)	CJ2H-CPU68 (-EIP)
	CS1H-CPU64H (*1)	CJ2M-CPU11
	CS1H-CPU65H (*1)	CJ2M-CPU12
	CS1H-CPU66H (*1)	CJ2M-CPU13
		CJ2M-CPU14
		CJ2M-CPU15
		CJ2M-CPU31
		CJ2M-CPU32
		CJ2M-CPU33
		CJ2M-CPU34
		CJ2M-CPU35

**NS Series Programming Manual**

Communications mode	Applicable PLCs	
Ethernet	CS1G-CPU42-E(V1) (*1) CS1G-CPU43-E(V1) (*1) CS1G-CPU44-E(V1) (*1) CS1G-CPU45-E(V1) (*1) CS1H-CPU63-E(V1) (*1) CS1H-CPU64-E(V1) (*1) CS1H-CPU65-E(V1) (*1) CS1H-CPU66-E(V1) (*1) CS1H-CPU67-E(V1) (*1) CS1G-CPU42H (*1) CS1G-CPU43H (*1) CS1G-CPU44H (*1) CS1G-CPU45H (*1) CS1H-CPU63H (*1) CS1G-CPU42H (*1) CS1G-CPU43H (*1) CS1G-CPU44H (*1) CS1G-CPU45H (*1) CS1H-CPU63H (*1) CS1H-CPU64H (*1) CS1H-CPU65H (*1) CS1H-CPU66H (*1) CS1H-CPU67H (*1) CJ1G-CPU42H (*1) CJ1G-CPU43H (*1) CJ1G-CPU44H (*1)	CJ1G-CPU45H (*1) CJ1H-CPU65H (*1) CJ1H-CPU66H (*1) CJ1H-CPU67H (*1) CJ1H-CPU65H-R (*1) CJ1H-CPU66H-R (*1) CJ1H-CPU67H-R (*1) CJ1M-CPU12 (*1) CJ1M-CPU13 (*1) CJ1M-CPU22 (*1) CJ1M-CPU23 (*1) CP1H-X40D□-□ CP1H-X40DT1-D CP1H-X40D□-□ CP1H-Y20DT-D CJ2H-CPU64 (-EIP) CJ2H-CPU65 (-EIP) CJ2H-CPU66 (-EIP) CJ2H-CPU67 (-EIP) CJ2H-CPU68 (-EIP) CJ2M-CPU11 CJ2M-CPU12 CJ2M-CPU13 CJ2M-CPU14 CJ2M-CPU15 CJ2M-CPU31 CJ2M-CPU32 CJ2M-CPU33 CJ2M-CPU34 CJ2M-CPU35
EtherNet/IP	CS1G-CPU42(-V1) CS1G-CPU43(-V1) CS1G-CPU44(-V1) CS1G-CPU45(-V1) CS1H-CPU63(-V1) CS1H-CPU64(-V1) CS1H-CPU65(-V1) CS1H-CPU66(-V1) CS1H-CPU67(-V1) CS1G-CPU42H CS1G-CPU43H CS1G-CPU44H CS1G-CPU45H CS1H-CPU63H CS1H-CPU64H CS1H-CPU65H CS1H-CPU66H CS1H-CPU67H CJ1G-CPU42H	CJ1G-CPU43H CJ1G-CPU44H CJ1G-CPU45H CJ1H-CPU65H CJ1H-CPU66H CJ1H-CPU67H CJ1H-CPU65H-R CJ1H-CPU66H-R CJ1H-CPU67H-R CJ1M-CPU12 CJ1M-CPU13 CJ1M-CPU22 CJ1M-CPU23 CJ2H-CPU64 (-EIP) CJ2H-CPU65 (-EIP) CJ2H-CPU66 (-EIP) CJ2H-CPU67 (-EIP) CJ2H-CPU68 (-EIP) CJ2M-CPU11 CJ2M-CPU12 CJ2M-CPU13 CJ2M-CPU14 CJ2M-CPU15 CJ2M-CPU31 CJ2M-CPU32 CJ2M-CPU33 CJ2M-CPU34 CJ2M-CPU35

**NS Series Programming Manual**

**Connection Methods**

**For CPM1A, CPM2A, CPM2C, CQM1H, and C200HX/HG/HE-E/-ZE PLCs:**

Either 1:1 NT Link or 1:N NT Link protocol can be used.

The connection method is the same for both 1:1 NT and 1:N NT Links.

Refer to *Section 4 Connecting to the Host to Serial Port* in the NS Series Setup Manual for information on how to connect to PLCs.

**CQM1 and C200 HS PLCs:**

1:1 NT Links can be used.

The connection methods are the same for 1:1 NT Links.

Refer to *Section 4 Connecting to the Host to Serial Port* in the NS Series Setup Manual for information on how to connect to PLCs.

**CS1G/CS1H and CS1G/CS1H-H PLCs:**

1:N NT Links, Ethernet, or Ethernet/IP can be used.

The connection method is the same as for 1:N NT Link, Ethernet, and Ethernet/IP connections. High-speed 1:N NT Link can also be used.

Refer to *Section 4 Connecting to the Host to Serial Port* and *Section 5 Connecting to Host via Ethernet or Controller Link* in the NS Series Setup Manual for information on how to connect to PLCs.

**CJ-series PLCs:**

1:N NT Links, Ethernet, or Ethernet/IP can be used.

The connection method is the same as for 1:N NT Link, Ethernet, and Ethernet/IP connections. High-speed 1:N NT Link can also be used.

Refer to *Section 4 Connecting to the Host to Serial Port* and *Section 5 Connecting to Host via Ethernet or Controller Link* in the NS Series Setup Manual for information on how to connect to PLCs.

**Note**

- ◆ Tags cannot be monitored if connection is made to the PLC using EtherNet/IP.
- ◆ The Device Monitor cannot be used when connected to the CP1E.

**Screen Configuration and Device Monitor Function**

The device monitor function is made up of the following three screens.

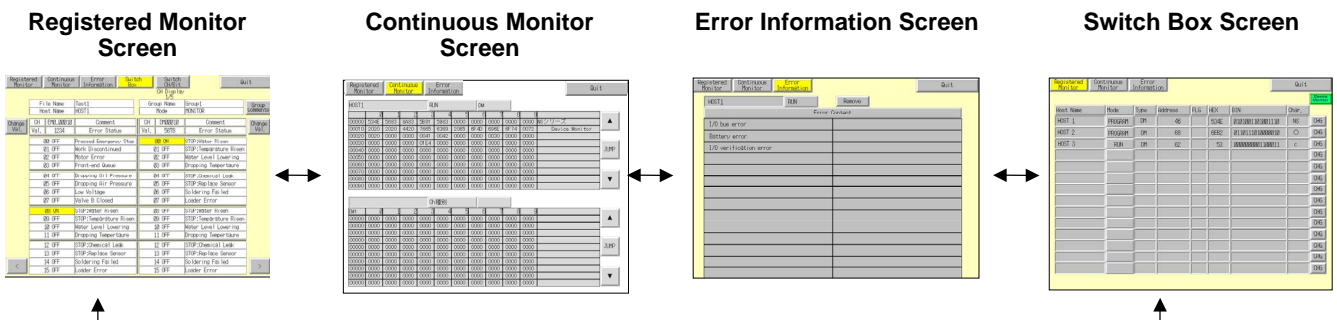

**Screen Functions**

**Common Screen Functions**

- Display and switch PLC operating modes.
- Switch screens within device monitor function.
- Close device monitor function.





**Note**

- ◆ Always press the Quit Button to close the device monitor. Otherwise, all settings will be lost when the power is turned OFF.
- ◆ PT operations will be stopped while the device monitor function is opened. This means that the following operations cannot be performed.
  - System memory manipulation from the host
  - Macro functions
  - Data log function
  - Alarm function

**Quitting**

Press the **Quit** Button located at the top right of the screen to close the device monitor function. The System Menu will be returned when the device monitor function is closed.

**Common Screen Operations**

This section describes the common screen operations using the device monitor function.

**Switching PLC Operating Modes**

Switches the operating mode of the PLC to which the PT is connected.



Perform the following procedure to switch PLC operating modes.

1. Press the mode display area.  
The Change Mode Dialog Box will be displayed.

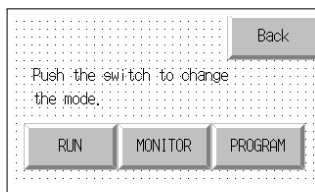

2. Press the touch switch for the desired mode.  
A confirmation dialog will appear. Press YES.  
The PLC operating mode will change to the specified mode.  
The label display in the mode display area will switch to the display for the specified mode.

**Switching Screens**

Switches screens within the device monitor function.



The four buttons located at the top left of the screens correspond to the Registered Monitor, Continuous Monitor, Error Information Screens, and Switch Box Screens. The button for the current screen will be displayed in reverse.

Press the button for the desired screen to switch to that screen.

**Selecting Hosts**

Use the following procedure to select hosts from the Registered Monitor, Continuous Monitor Screens, and Switch Box Screens.

1. Press the area where the Host name is displayed.  
The Host Selection Dialog Box will be displayed.

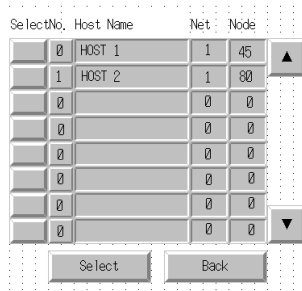

2. Press the button to the left of the name of the desired host.
3. Press the **Select** Button.

### Selecting Word Types

Selects the type of words monitored using the Registered Monitor and Continuous Monitor Screens.

1. Press the type display area.  
The CH Type Selection Dialog Box will be displayed.

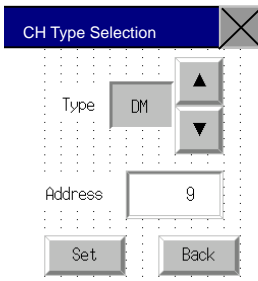

2. Press the ▲ and ▼ buttons to switch between word types. Select the type of words to be monitored.
3. Press the address display area to display a tenkey pad. Enter the addresses to be monitored.
4. Press the **Set** Button.

The Word Type Selection Dialog Box will close and the Registered Monitor or Continuous Monitor Screens will be returned. The settings will be reflected in the word type and address display areas.

#### Note

- ◆ If *CLEAR* is selected when selecting the type and the Set Button is pressed, the display up until that point will be cleared on the Registered Monitor and Continuous Monitor Screens.

### Registered Monitor Screen Functions and Usage

The Registered Monitor Screen displays current values for specified words, changes current values, and is used to perform force on/off/cancel of bits, timers, and counters. You can register 20 words for the NS15, 14 words for the NS12, 12 words for the NS10 or NS8, and 7 words for the NS5.

#### Note

- ◆ Current value changes and bit, timer, and counter force on/off/cancel cannot be performed while the PLC is in Run mode.
- ◆ The word monitor settings are enabled until the PT is turned OFF or reset. If the device monitor function is closed, the display will use the same settings the next time device monitor function is started.
- ◆ If a communications error occurs, the Host name, operating mode, and other information for the host that caused the error will disappear from the screen.

**NS Series Programming Manual**

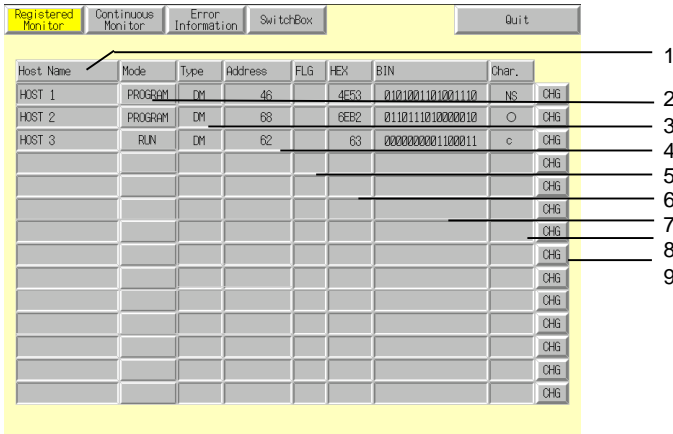

No.	Setting	Details
1	Host name	Press <i>Host name</i> to display the Host Selection Dialog Box and select the Host. Host names set using CX-Designer can be selected.
2	Mode (See note 1.)	Press <i>Mode</i> to display the Change Mode Dialog Box. Switches to the specified PLC mode.
3	Type (See note 2.)	Press <i>Type</i> to display the CH Type Selection Dialog Box. Sets the word type to be monitored.
4	Address (See note 3.)	Press <i>Address</i> to display the CH Type Selection Dialog Box. Sets the addresses to be monitored.
5	FLG (See note 4.)	If TIM or CNT are set as the type, the following data will be displayed. When TU or CU are counted: o For force on using device monitor: S For force off using device monitor: R
6	HEX	Displays the contents of the specified address in hexadecimal.
7	BIN (See note 5.)	Displays the contents of the specified address in binary.
8	Characters (See note 6.)	Displays the contents of the specified address in characters.
9	Change	Switches to the screen for changing current values.

- Note
1. NS5 PTs display P for Program, M for Monitor, and R for Run.
  2. Appears as *Type* for NS10, NS8, and NS5 PTs.
  3. Appears as *Address* for NS10 and NS8 PTs and as *add.* for NS5 PTs.
  4. Appears as *F* for NS10, NS8, and NS5 PTs.
  5. Blank for the NS5 PTs.
  6. Appears as *char* for NS5 PTs.

**Words Displayed on Registered Monitor Screen**

Words that can be displayed on the device monitor function Registered Monitor Screen depend on the PLC model. These word areas are shown in the following table.

Symbol	Word area	CJ1(-H), CS1(-H), CJ2H, CJ2M	C200HX/HG/HE-E/-ZE	CQM1, CPM1A, CPM2A, CPM2C, C200HS	CQM1H
DM	DM Area	○	○	○	○
CIO	I/O Area	○	○	○	○
TIM	Timer Area	○	○	○	○
CNT	Counter Area	○	○	○	○
HR	HR area	○	○	○	○
AR	AR Bit and Auxiliary Areas	○	○	○	○
LR	Link Area	—	○	○	○
WR	Work Area	○	—	—	—
EM	EM Area (current bank)	△	△	—	△
EM0 to EM18	EM Area (bank 0) to EM Area (bank 18)	△	△	—	△

○: Can be displayed, —: No area, △: Can be displayed within the existing ranges  
 ×: Cannot be displayed  
 The CS/CJ-series Task Flag (TK) and clock pulse (P) cannot be displayed.

**NS Series Programming Manual**

**Change Screen**

Press the **Change** Button on the Registered Monitor Screen to switch to the screen for changing current values. Hexadecimal and binary input are used.

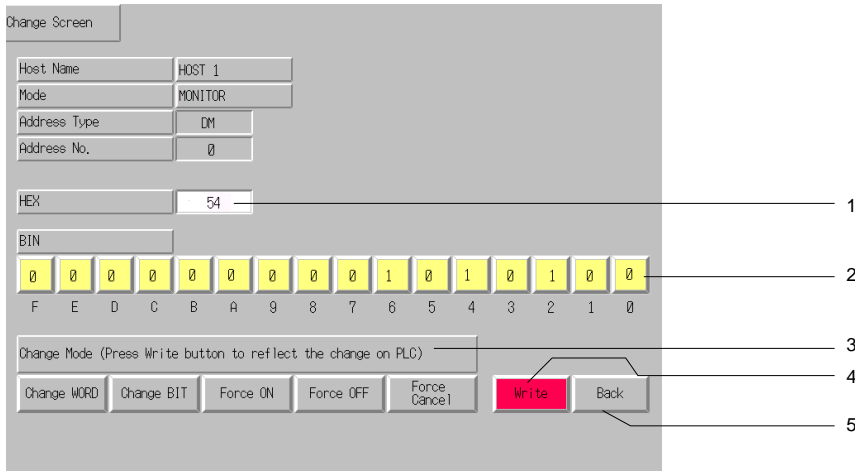

No.	Setting	Details
1	HEX	Sets the changed value in hexadecimal. Hexadecimal input is enabled when <i>Change word</i> is selected as the mode.
2	BIN	Enables changing values by pressing the buttons for 0 or 1 for each binary digit. Binary input is enabled when <i>Change bit</i> , <i>Force ON</i> , or <i>Force OFF</i> are selected as the mode.
3	Mode	Specifies the mode for changing current values. Change word: Uses hexadecimal input. Change bit: Uses binary input. Turns the specified bit ON or OFF. Force ON: Uses binary input. Force ON the specified bit. Force OFF: Uses binary input. Force OFF the specified bit. Force Cancel: Clears the force ON/OFF.
4	Write	Writes the changed value to the PLC and returns the Registered Monitor Screen.
5	Back	Makes the changed value invalid and returns the Registered Monitor Screen.

**Continuous Monitor Screen Functions and Usage**

The Continuous Monitor Screen displays the contents of the DM and EM Areas in list format.

NS15 PTs can display current value data for 300 words made up to two lists of 150 words (10 words × 15 lines). NS12 PTs can display current value data for 200 words made up of two lists of 100 words (10 words × 10 lines). NS10 and NS8 PTs can display current value data for 100 words made up of two lists of 50 words (10 words × 5 lines). NS5 PTs can display current value data for 25 words (5 words × 5 lines).

**Note**

- ◆ The word monitor settings are enabled until the PT is turned OFF or reset. If the device monitor function is closed, the display will use the same settings the next time device monitor function is started.

**NS Series Programming Manual**

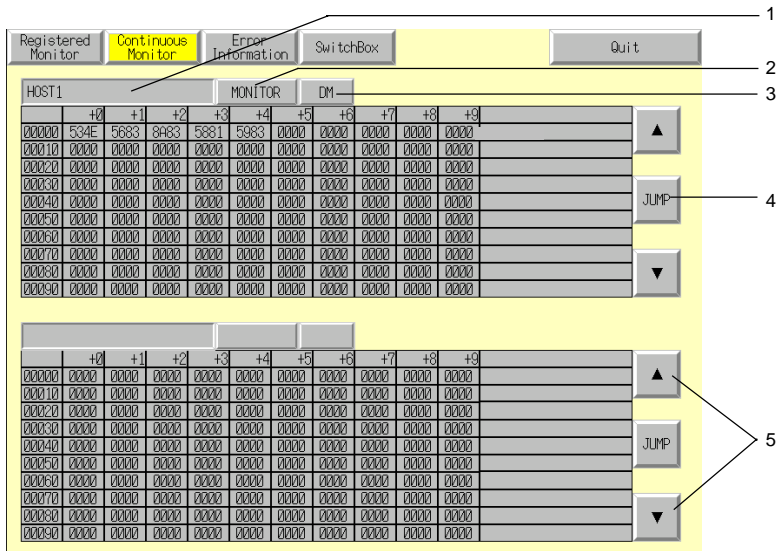

No.	Setting	Details
1	Host name	Press <i>Host name</i> to display the Host Selection Dialog Box and select the Host. Host names set using CX-Designer can be selected.
2	Mode	Press <i>Mode</i> to display the Mode Change Dialog Box. Switches to the specified PLC mode.
3	Type	Press <i>type</i> to display the CH Type Selection Dialog Box. Sets the word type to be monitored.
4	JUMP	Press <i>JUMP</i> to display the JUMP Dialog Box. Sets the addresses to be monitored. Press the <b>Set</b> Button in the JUMP Dialog Box to the following number of words starting from the specified address. NS15: 150 words NS12: 100 words NS10/NS8: 50 words NS5: 25 words
5	▲/▼ (Previous/ next)	Press the <b>Up</b> Button or <b>Down</b> Button to scroll the addresses being displayed by one page. You cannot scroll beyond the upper and lower limits of the addresses.

**NS Series Programming Manual**

**Words Displayed on Continuous Monitor Screen**

Words that can be displayed on the device monitor function Continuous Monitor Screen depend on the PLC model. These word areas are shown in the following table.

Symbol	Word area	CJ1(-H), CS1(-H), CJ2H, CJ2M	C200HX/HG/HE-E/-ZE	CQM1, CPM1A, CPM2A, CPM2C, C200HS	CQM1H
DM	DM Area	○	○	○	○
CIO	I/O Area	○	○	○	○
TIM	Timer Area	○	○	○	○
CNT	Counter Area	○	○	○	○
HR	HR area	○	○	○	○
AR	AR Bit and Auxiliary Areas	○	○	○	○
LR	Link Area	—	○	○	○
WR	Work Area	○	—	—	—
EM	EM Area (current bank)	△	△	—	△
EM0 to EM18	EM Area (bank 0) to EM Area (bank 18)	△	△	—	△

○: Can be displayed, ×: Cannot be displayed, —: No area,

△: Can be displayed within the existing ranges

**Error Information Screen Functions and Usage**

Error Information Screens read error information from PLC (information for current errors) and display this information in a list in order of priority. Also, the highest priority error can be cleared from the list of current errors.

Information for up to 40 errors can be displayed at one time for the NS15, information for up to 30 errors can be displayed at one time for the NS12, information for up to 22 errors can be displayed at one time for the NS10 or NS8, and information for up to 7 errors can be displayed at one time for the NS5. If more than the maximum number of errors have occurred, further errors will not be displayed until the highest priority errors have been cleared.

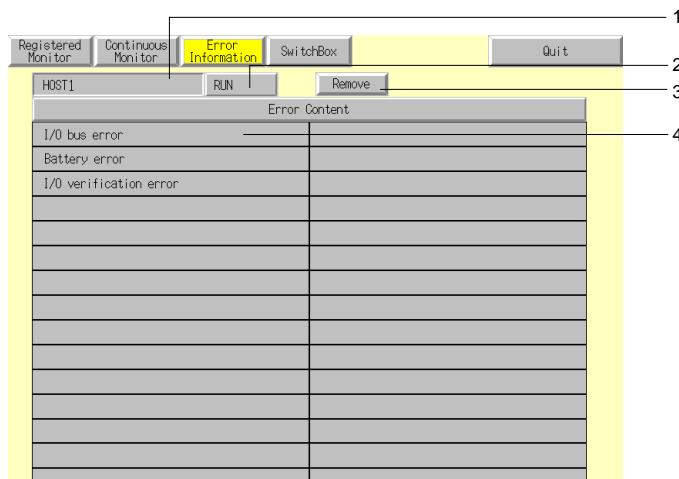

No.	Setting	Details
1	Host name	Press <i>Host name</i> to display the PLC Selection Dialog Box and select the PLC. Host names set using CX-Designer can be selected.
2	Mode	Press <i>Mode</i> to display the Change Mode Dialog Box. Switches to the specified PLC mode.
3	Remove	Clears the highest priority error (displayed at the top left of the display area) from the group of current errors. When an error is cleared, the error information is also cleared from the display area. However, the same error will occur again straight away unless the cause of the error is eliminated on the PLC.
4	Error content	Reads current PLC error information and displays the errors in order of priority. The display is refreshed if a new error occurs while the error information is being displayed.

### Error Information Lists

This section shows the PLC error information that is displayed on the Error Information Screen. The display data details and type depend on the connected PLC. Refer to the manual for the connected PLC for countermeasures for PLC errors.

Types of error information displayed		CS-series PLCs	C-series PLCs
Fatal errors	System error (FALS)	○	○
	Too many I/O Units	×	○
	I/O settings error	×	○
	I/O bus error *** (***: rack number)	○ (See note.)	○
	No END instruction	×	○
	Memory error	○	○
	Unit No. duplication error	○	×
	Rack No. duplication error	○	×
	INNER board error	○	×
	I/O points exceeded	○	×
	Cycle time exceeded	○	×
	Program error	○	×
	Unit No. duplication error	○	×
	Nonfatal errors	CPU Bus Unit error	○
PLC link transfer error		×	○
Cycle time exceeded		×	○
I/O verification error		○	○
Battery error		○	○
System error FAL *** (***: FAL No.)		○	○
Interrupt task error		○	×
Basic I/O error		○	×
PLC Setup error		○	×
Inner Board compatibility error		○	×
CPU Bus Unit error		○	×
SYSMAC BUS error *** (***: No. Of Master Unit with error)		○ (See note.)	○
CPU Bus Unit setting error		○	×
Special I/O setting error		○	×

○: Displayed, ×: Not displayed (or does not exist on corresponding PLC)

Note: The numbers indicated by \*\*\* are not displayed for CS-series or CJ-series PLCs.

#### Reference

- ◆ Numbers are not displayed for FAL or FALS errors.  
Check the number on the PLC.

## Switch Box Screen

The Switch Box Screen enables displaying the specified addresses with comments, monitoring, and changing current values. A Switch Box File for NS made using the Switch Box Utility (personal computer applications software) can be used directly on the PT. This makes it possible to debug and operate PLCs from the computer and establish the same environment for the onsite PT.

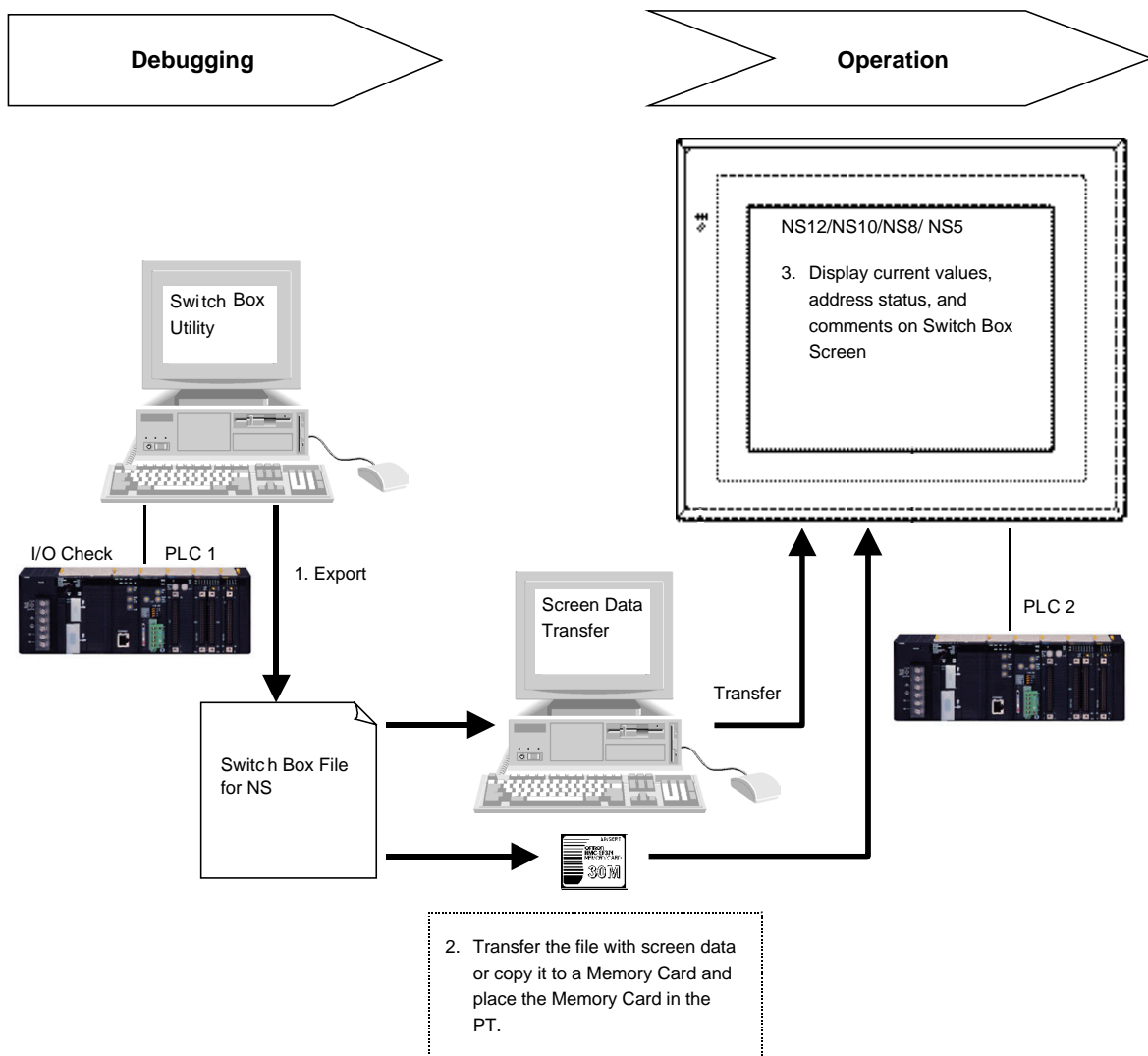

Before using the Switch Box Screen, create the Switch Box File for NS (extension .sbt) with Switch Box Utility Ver.1.4 or later (Execute <CDROM>:\Utility\Switch Box\Setup.exe.) supplied with CX-Designer, and then transfer it to the PT. In this way the specified address status with comments can be monitored by loading the file to the Switch Box Screen. Also, current values can be changed.

The Switch Box Utility enables monitoring/changing values of the specified addresses while showing their comments. In addition, PLC addresses and I/O comments can be imported from the symbol table of the CX-Programmer or a text file (tab-delimited) to the Switch Box Utility.

Up to 100 groups of addresses can be registered in the Switch Box Utility so users can easily change monitoring addresses by selecting the group name on the Switch Box Screen.

The Switch Box Screen is supported by CS(-H) and CJ(-H) PLCs. It is not supported by CV-series PLCs.

### Note

- ◆ Comments or group names cannot be registered on the Switch Box Screen.
- ◆ The Switch Box Utility helps debug operation for the PLC and allows display of visually I/O status of addresses specified by the user. The keyboard can be used to set/reset bits, force-set/force-reset bits, and change word PVs. The Switch Box Utility is packaged with the CX-Designer. NS-series switch box files can be output from Switch Box Utility Ver. 1.4.



## Switch Box File for NS

To create a Switch Box File for NS (extension .sbt), export the data from the Switch Box Utility (Ver.1.4) supplied with CX-Designer. The file contains PLC addresses (communications address), I/O comments, the number of registered groups, etc. Transferring this file to the PT or to a Memory Card placed in the PT enables monitoring addresses and comments set in Switch Box File for NS.

The Switch Box Utility can also import addresses with I/O comments from the global symbol table of the CX-Programmer or a text file (tab-delimited). It makes it possible to import to the PT I/O comments registered with the CX-Programmer or Excel (file saved as tab-delimited text) through the Switch Box Utility and Switch Box File for NS.

### Reference

- ◆ The file name must be no more than 42 characters including the sbt extension.  
Select a file name using alphanumerics, underscores(\_), dollar symbols(\$), and periods(.

## Exporting the Switch Box File for NS and Transferring It to the PT

1. Export the information set using the Switch Box Utility as a Switch Box File for NS. Export it as shown in the following figure. Select **File - Switch Box File for NS - Export**.

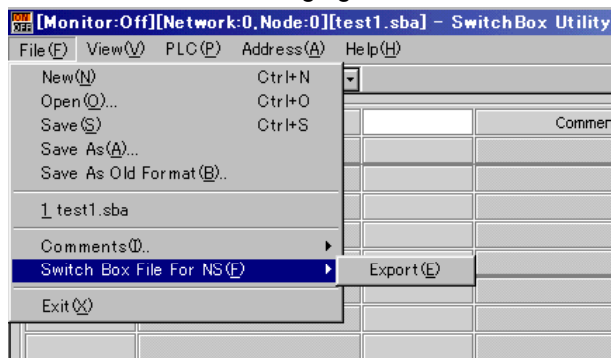

2. Transfer the Switch Box File for NS to the PT using any of the following methods.
  - Copy the Switch Box File for NS into the project folder manually and transfer to the PT by Screen Data Transfer Tool on CX-Designer.
  - Copy the Switch Box File for NS to the directory on a Memory Card placed in the PT by Memory Card Transfer Tool.
  - Copy the Switch Box File for NS to the root directory on a Memory Card using Explorer or similar software on the computer beforehand, and then place the Memory Card into the PT.

### Reference

- ◆ If the file name exceeds 42 characters including the sbt extension, an error message will be shown when transferring the Switch Box File for NS to the PT using method A or B given above. This error message will NOT appear when copying the file to the Memory Card using the Explorer, even if the file name contains more than 42 characters. Always check the length of the file name when using this method.
- ◆ When using the Screen Data Transfer Tool on CX-Designer, the Switch Box File for NS can also be transferred to the PT by sending it separately.
- ◆ Up to 100 Switch Box Files for NS can be saved.
- ◆ The Switch Box File for NS (extension .sbt) cannot be imported to the Switch Box Utility. To edit settings made on the Switch Box Utility, select **File - Save As** and save as the file with an sba extension beforehand.

**NS Series Programming Manual**

**Procedure for Switching the Screen to the Switch Box Screen**

1. Press the **Switch Box** Button on the **Registered Monitor** Screen.

Press any two corners on the touch panel (For the NS15, press any corner twice.) to display the **System Menu** and press the **Special Screen** Tab. Press **Device Monitor** on the **Special Screen** Tab Page. The **Registered Monitor Screen** will appear. Then, press the **Switch Box** Button at the top of the screen to switch to the Switch Box Screen.

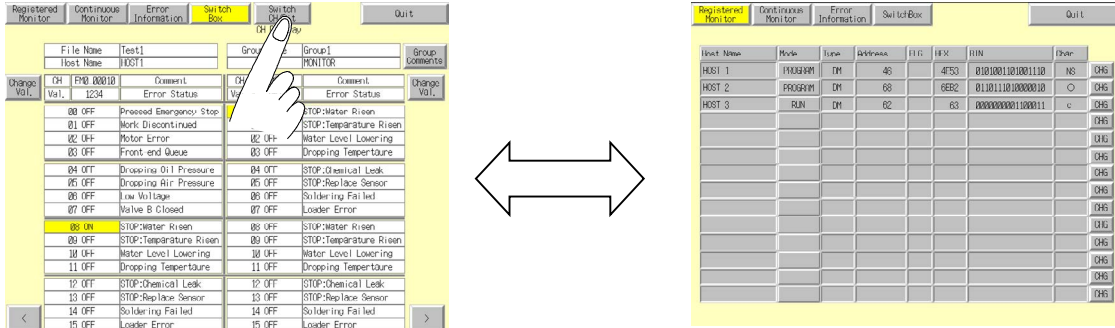

\*If the Switch Box Screen is switched to from the **System Menu**, the display will return to the **Special Screen** Tab Page of the **System Menu** after the **Quit** Button is pressed on the screen. If the screen is switched to another screen of the Device Monitor and the **Quit** Button is pressed, the display will also return to the **Special Screen** Tab Page of the **System Menu**.

2. Switch from a user screen by operating a command button or Multifunction Object on the screen

Refer to the **2-9 Buttons** or **2-11 Multifunction Objects** for details on setting command buttons or Multifunction Objects on the screen.

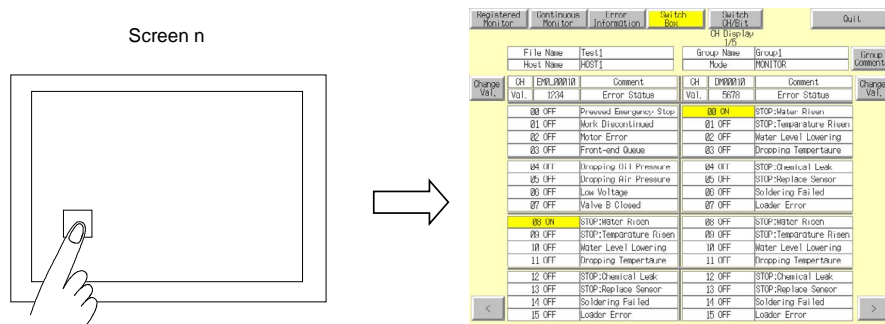

\*If the screen is switched from a user screen by operating a command button or Multifunction Object, the display will return to the user screen after the **Quit** Button is pressed on the screen. If the screen is switched to other screen on the Device Monitor and the **Quit** Button is pressed, the display will also return to the user screen that was previously displayed.

**NS Series Programming Manual**

**Switch Box Screen Layout**

**NS12 PTs**

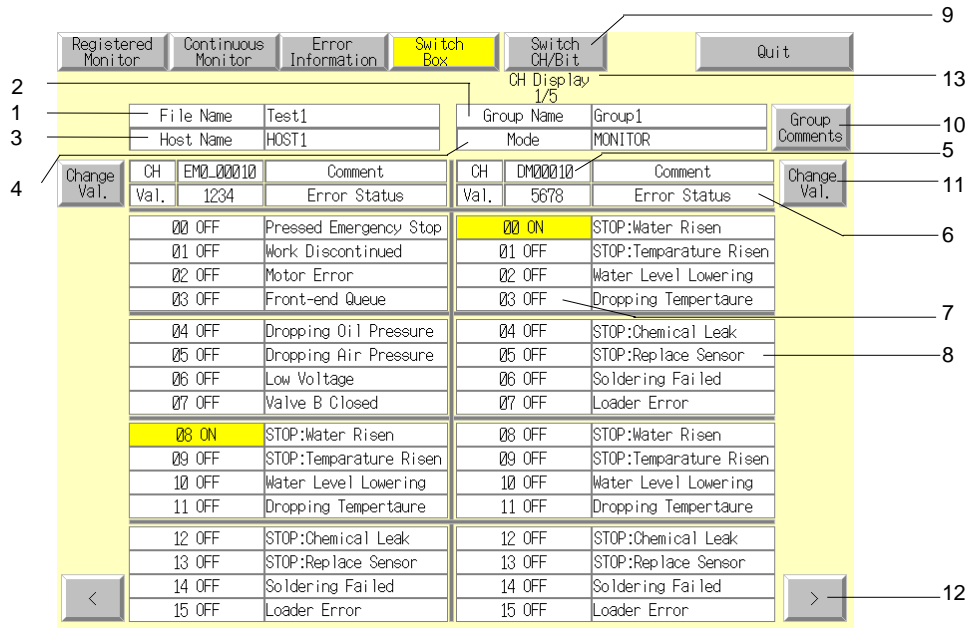

**NS5 PTs**

**Page 1**

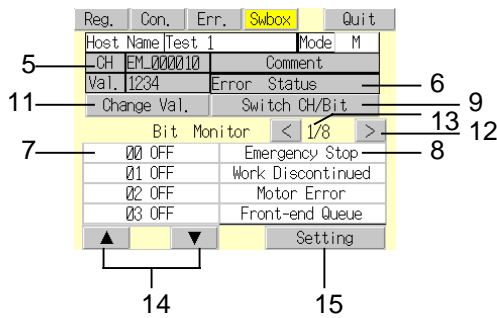

**Page 2**

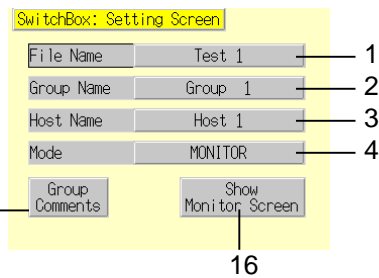

No.	Setting	Details
1	File Name	Sets and Displays Switch Box File for NS saved on Switch Box Utility. It contains addresses, comments, and group information to be displayed. Up to 20 characters can be displayed. Up to 100 files can be selected.
2	Group Name	Displays group name set on Switch Box Utility in a list. The group name that contains addresses to be monitored/displayed can be selected from the list. Up to 20 characters can be displayed. Six words can be registered for each group. Up to 100 groups can be registered.
3	Host Name	Press Host Name to display the Host Selection Dialog Box and select the host. Host names set using CX-Designer can be selected.
4	Mode	Press Mode to display Change Mode Dialog Box. Switches to the specified PLC mode.
5	CH	Displays communications address. Display will be blank when the Watch Monitor is selected.
6	Comment	Displays comments of the current address. Display will be blank when the Watch Monitor is selected.
7	Bit Status Display	Displays each bit ON/OFF status.
8	Bit Comment Display	Displays bit comments set using Switch Box Utility.
9	Switch CH/Bit	Switches monitor type from the Bit Monitor to the Watch Monitor and vice versa.
10	Group Comment Display	Displays comments set for the groups. Up to 20 characters per line and up to 50 lines can be displayed. For the NS5, up to 33 characters per line and up to 9 lines can be displayed
11	Value	Press Value Button to switch Change Screen.
12	< >	Switch to next /previous page.
13	Page Display	Displays current page number and the maximum page number. There are 3 pages maximum for the NS12, 6 pages for NS7 and NS10.
14	Up (▲) and Down (▼) Buttons (NS5 PTs only)	Switch the bits displayed in the bit status in increments of 4 bits from the specified address. Nothing will be displayed when Watch Monitor is selected.
15	Setting (NS5 PTs only)	Press the <b>Setting</b> Button to display the Setting Dialog Box in the Switch Box Utility.
16	Show Monitor Screen (NS5 PTs only)	Press the <b>Show Monitor Screen</b> Button to go to the first Monitor Screen page.

**NS Series Programming Manual**

**Procedure for Using the Switch Box Screen**

Switch to Switch Box Screen (**Go to System Menu - Special Screen - Device Monitor or operate Command Buttons**).

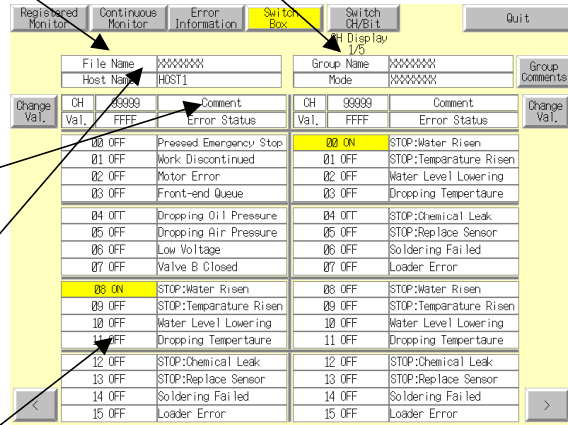
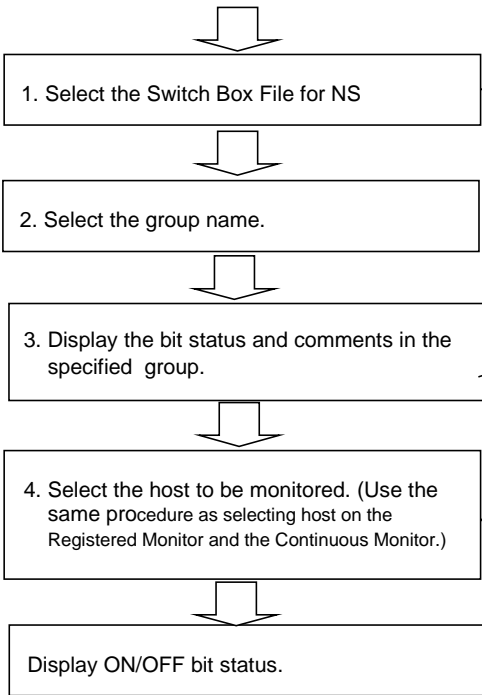

Goal	Refer to (Sections on the next page onward)
Want to change the Switch Box File for NS	1. Changing the File Name
Want to change the group name	2. Changing the Group Name
Want to display the group comments	3. Displaying the Group Comments
Want to change the ON/OFF status	4. Changing the ON/OFF Status
Want to change a current value	5. Changing the Current Value
Want to change the monitor type (from the Bit Monitor to the Watch Monitor and vice versa)	6. Switching the Monitor Type
Want to change the mode type	Common Screen Operation – Switching PLC Operation Mode
Want to change the host name	Common Screen Operation – Selecting Hosts

**Changing the File Name**

To select the file on the Switch Box Screen, use the following procedure.

1. Press the **File Name** or the File Name Display Area on the Switch Box Screen. The File Selection Dialog Box will appear.
2. Select the file name.
3. Press the **Select** Button.

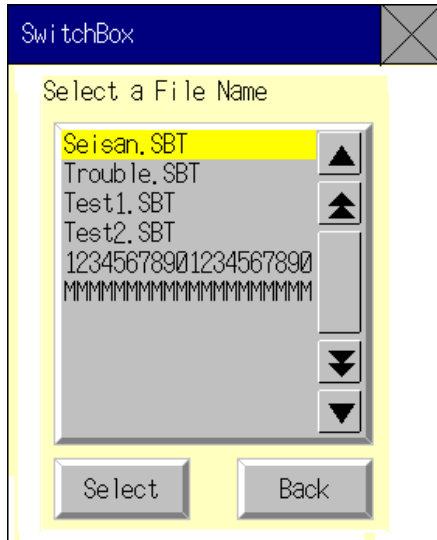

**Changing the Group Name**

To select the group name on the Switch Box Screen, use the following procedure.

1. Press the **Group Name** or the Group Name Display Area on the Switch Box Screen.
2. Select the group name.
3. Press the **Select** Button.

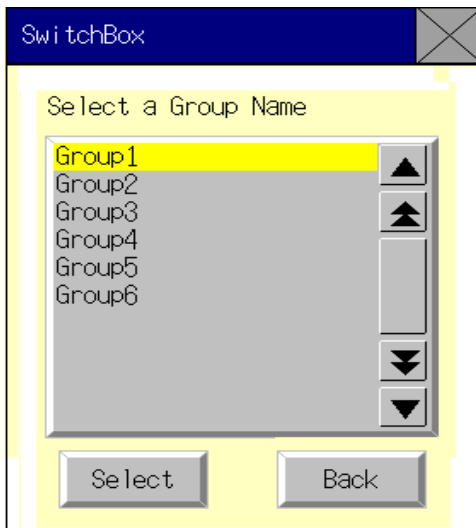

### Displaying the Group Comments

The comments registered for the each group can be displayed. Press the **Group Comments** Button on the Switch Box Screen to display the comments on the List Selection object in the Group Comments Display Dialog Box.

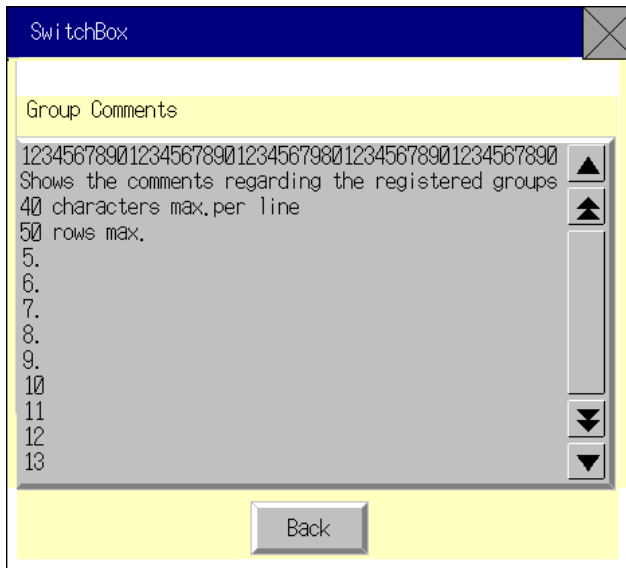

### Changing the ON/OFF Status

Press the button showing the bit status to change the ON/OFF status. This action is supported for both the Bit Monitor (continuous display) and the Watch Monitor (discontinuous display). Press the **Bit Status** Button. The following dialog will appear. Press the **YES** Button to change the ON/OFF status.

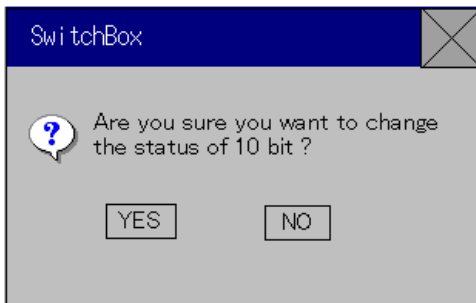

### Changing the Current Value

Displayed addresses can be changed on the Bit Monitor display. Press the **Change Val.** Button to switch to the **Change Screen**. Refer to the **Change Screen** under the **Registered Monitor** described earlier for details.

### Switching the Monitor Type

To switch the monitor type from the Bit Monitor to the Watch Monitor and vice versa, press the **Switch CH/Bit** Button. The Bit Monitor appears when stating the Switch Box Screen. Displayed addresses are enabled while the power to the PT is ON. If the Switch Box Screen is closed, addresses on the screen are the same after returning to the Switch Box Screen. (If the power to the PT is turned OFF, the same addresses will not be shown.)

**NS Series Programming Manual**

**Bit Monitor Display**

The Bit Monitor allows displaying the communications addresses, values, bit numbers, bit status (ON/OFF status), and comments. Up to 22 characters for the NS15 and 12 for the NS10, NS8, and NS5 can be displayed on the comments display area beside each bit.

**NS12 PTs**

Registered Monitor	Continuous Monitor	Error Information	Switch Box	Switch CH/Bit	Quit		
File Name		Test1		Group Name		Group1	
Host Name		HOST1		Mode		MONITOR	
Change Val.	CH	EM0_00010	Comment	CH	DM00010	Comment	Change Val.
	Val.	1234	Error Status	Val.	5678	Error Status	
	00	OFF	Pressed Emergency Stop	00	ON	STOP:Water Risen	
	01	OFF	Work Discontinued	01	OFF	STOP:Temperature Risen	
	02	OFF	Motor Error	02	OFF	Water Level Lowering	
	03	OFF	Front-end Queue	03	OFF	Dropping Tempertaure	
	04	OFF	Dropping Oil Pressure	04	OFF	STOP:Chemical Leak	
	05	OFF	Dropping Air Pressure	05	OFF	STOP:Replace Sensor	
	06	OFF	Low Voltage	06	OFF	Soldering Failed	
	07	OFF	Valve B Closed	07	OFF	Loader Error	
	08	ON	STOP:Water Risen	08	OFF	STOP:Water Risen	
	09	OFF	STOP:Temperature Risen	09	OFF	STOP:Temperature Risen	
	10	OFF	Water Level Lowering	10	OFF	Water Level Lowering	
	11	OFF	Dropping Tempertaure	11	OFF	Dropping Tempertaure	
	12	OFF	STOP:Chemical Leak	12	OFF	STOP:Chemical Leak	
	13	OFF	STOP:Replace Sensor	13	OFF	STOP:Replace Sensor	
	14	OFF	Soldering Failed	14	OFF	Soldering Failed	
	15	OFF	Loader Error	15	OFF	Loader Error	

**NS5 PTs**

Press the Left (<) or Right (>) Button in the center of the screen with Bit Monitor selected to switch pages on NS5 PTs. Press the Up (▲) or Down (▼) Button on the lower left of the screen to switch the bits displayed in the bit status in increments of 4 bits from the specified address. Press the **Setting Screen** Button to switch to the Setting Screen in the Switch Box Utility to enable making settings for displaying a new NS Switch Box File.

Reg.	Con.	Err.	Swbox	Quit	
Host Name		Test 1		Mode	M
CH	EM_000010	Comment			
Val.	1234	Error Status			
Change Val.	Switch CH/Bit				
Bit Monitor < 1/8 >					
00	OFF	Emergency Stop			
01	OFF	Work Discontinued			
02	OFF	Motor Error			
03	OFF	Front-end Queue			
▲	▼	Setting			



**NS Series Programming Manual**

**Watch Monitor Display**

The Watch Monitor allows displaying 14 bits and words at random. The display areas for the CH (word address) and Val (current value) will be blank. The comments will be shown beside each bit and word. Maximum number of characters for comments is the same as the Bit Monitor, up to 22 characters for the NS15 and 12 for the NS10, NS8, and NS5. The current value cannot be changed on the Watch Monitor display.

**NS12 PTs**

Registered Monitor	Continuous Monitor	Error Information	Switch Box	Switch CH/Bit	Quit		
CH Display 1/5							
File Name		Test1	Group Name		Group1		
Host Name		HOST1	Mode		MONITOR		
				Group Comments			
Change Val.	CH		Comment	CH		Comment	Change Val.
	Val.	0000	Error Status	Val.	0000	Error Status	
DM00000.10 OFF		Pressed Emergency Stop		HR00000.03 OFF		STOP:Water Risen	
C100000.09 OFF		Work Discontinued		DM00000.10 OFF		STOP:Temperature Risen	
HR00000.03 OFF		Motor Error		LR00002.00 OFF		Water Level Lowering	
LR00002.00 OFF		Front-end Queue		C100000.09 OFF		Dropping Tempertaure	
EM0_32767.15 OFF		Dropping Oil Pressure		EM_00000.00 OFF		STOP:Chemical Leak	
TIM00000.00 OFF		Dropping Air Pressure		CNT00000.00 OFF		STOP:Replace Sensor	
CNT00000.00 OFF		Low Voltage		EM0_32767.15 OFF		Soldering Failed	
EM_00000.00 OFF		Valve B Closed		TIM00000.00 OFF		Loader Error	
DM3267 FFFF		STOP:Water Risen		CNT01234 1234		STOP:Water Risen	
EM1_00000 ABCD		STOP:Temperature Risen		HR00000 0001		STOP:Temperature Risen	
HR00000 0001		Water Level Lowering		DM3267 FFFF		Water Level Lowering	
CNT01234 1234		Dropping Tempertaure		EM1_00000 ABCD		Dropping Tempertaure	
DM00000 0001		STOP:Chemical Leak		DM00004 0008		STOP:Chemical Leak	
DM00003 0001		STOP:Replace Sensor		DM00000 0001		STOP:Replace Sensor	
DM00004 0008		Soldering Failed					
DM00006 00A0		Loader Error					

**NS5 PTs**

The Watch Monitor Screen for the NS5 consists of a total of 8 pages. Four pages display the bit area and four pages display the word area in individual groups. Press the Left (<) or Right (>) Button in the center of the screen to display the four bit area pages followed by the 4 word area pages. After the last word area page is displayed, the screen returns to the first bit area page. Like the procedure with the Bit Monitor, press the Setting Button in the lower right corner of the screen to switch to the Setting Screen in the Switch Box Utility to enable making settings for displaying an NS Switch Box File.

Reg.	Con.	Err.	Swbox	Quit
Host Name	Test 1	Mode	M	
CH		Comment		
Val.	0000	Error Status		
Change Val.		Switch CH/Bit		
Watch Monitor < 1/8 >				
DM00000.10 OFF		Emergency Stop		
01 OFF		Work Discontinued		
02 OFF		Motor Error		
LR00002.00 OFF		Front-end Queue		
Setting				

### Words Displayed on Switch Box Screen

Words that can be displayed on Switch Box Screen are shown in the following table.

Symbol	Word area	CJ1(-H), CS1(-H)
DM	DM Area	○
CIO	I/O Area	○
TIM	Timer Area	○
CNT	Counter Area	○
HR	HR Area	○
AR	AR Bit and Auxiliary Areas	○
LR	Link Area	—
WR	Work Area	○
EM	EM Area (Current Bank)	△
EM0 to EMC	EM Area (bank 0) to EM Area (bank C)	△

○: Can be displayed, ×: Cannot be displayed,

—: No Area,

△: Can be displayed within the existing ranges

### Device Monitor Function Errors

Symptoms	Cause	Remedy
The screen does not change when the device monitor function is opened from the System Menu.	The protocol set on the PT is not 1:1 NT Link, 1:N NT Link, or Ethernet.	Change the protocol for the serial port connected to the PLC to 1:1 NT Link, 1:N NT Link, or Ethernet. Make the same settings on the PLC side. The device monitor function is not supported for the Controller Link.
The words monitored using the device monitor function are not displayed the next time the device monitor function is opened.	The PT has been turned OFF. The PT has been reset.	The words that are being monitored using the device monitor function are held even if the device monitor function is closed. However, all words are cleared if the power supply is turned OFF or the PT is reset. Set the words to be monitored again.

## Error Messages

Error	Possible cause	Remedy
Cannot write in RUN mode.	An attempt has been made to change the contents of words while the PLC is in RUN mode.	Change the PLC to another operating mode. The PLC operating mode can be changed from any device monitor screen.
Cannot clear error (When error cleared from Error Information Screen)	The cause of the error has not been cleared at the PLC.	Remove the cause of the error at the PLC. Refer to the manual for the connected PLC for details.
(Serial port receive error displayed)	Connection cable has been disconnected or has come out of the connection socket.	Check the connection between the PT and the PLC. Refer to <i>Section 7 Maintenance and Troubleshooting</i> in the <i>NS Series Setup Manual</i> .
Set address is out of range. Please set other address.	The Switch Box File for NS contained incorrect address settings is selected (e.g., set address range is not correct).	Select the host with correct address settings. Set addresses on the Switch Box Utility again.
Failed to read the Switch Box File for NS file.	The Switch Box File for NS not found when returning to the Switch Box Screen. Settings in the Switch Box File for NS are not correct.	Transfer Switch Box File for NS again. If error persists, make the address settings on the Switch Box Utility again.
Cannot use the Switch Box Function because no Host is registered.	An attempt was made to switch from the user screen to Switch Box Screen by operating command button when no host was set in Register Host.	Make the communications settings on CX-Designer and transfer the screen data contained to the registered host again.
Cannot connect to this PLC model.	The HOST type for PLC that is not supported by Switch Box function that was selected in the host Selection Dialog Box.	Select a host that can be used on the Switch Box Screen and change the connected PLC type.
Writing to this memory is not possible.	Either Change Val or Bit Status Button was pressed when monitoring device that cannot be written.	None (Change the communications address to write.)

### 2-20-10 Video Configuration

By mounting an NS-CA001 Video Input Unit on the NS12, NS10, or NS8, images can be shown on the PT from connected video cameras or Vision Sensors. Using the *Video Configuration*, the contrast of the images can be adjusted and outputs can be made to the Vision Sensor Console.

If an NS-CA002 RGB/Video Input Unit is mounted, refer to the *NS-series RGB/Video Input Unit Operation Manual (V086)* for details on the video adjustments.

#### Opening the Video Configuration Window

The Video Configuration Window is accessed from the System Menu.

1. Display the Special Screen Tab Page of the System Menu and select **Video Configuration** from the special functions. Then, press the **START** Button.

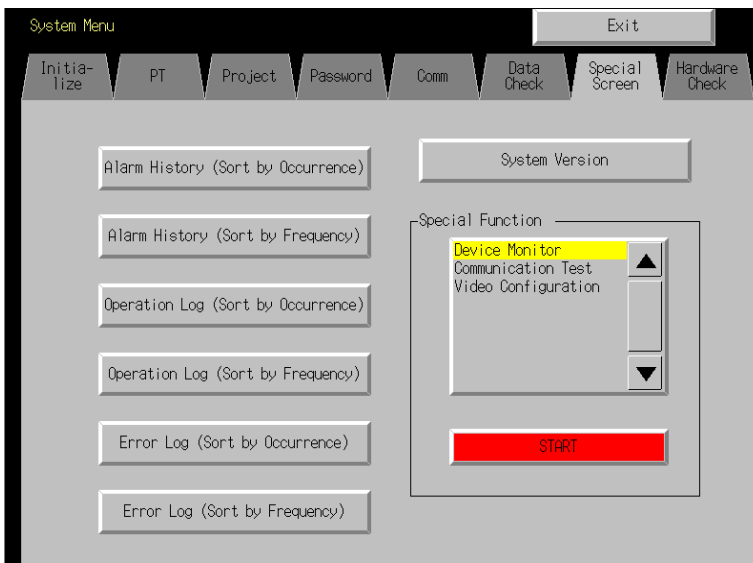

2. The Video Configuration Window will be displayed. Video Configuration Window will not be displayed unless the Video Input Unit is installed.

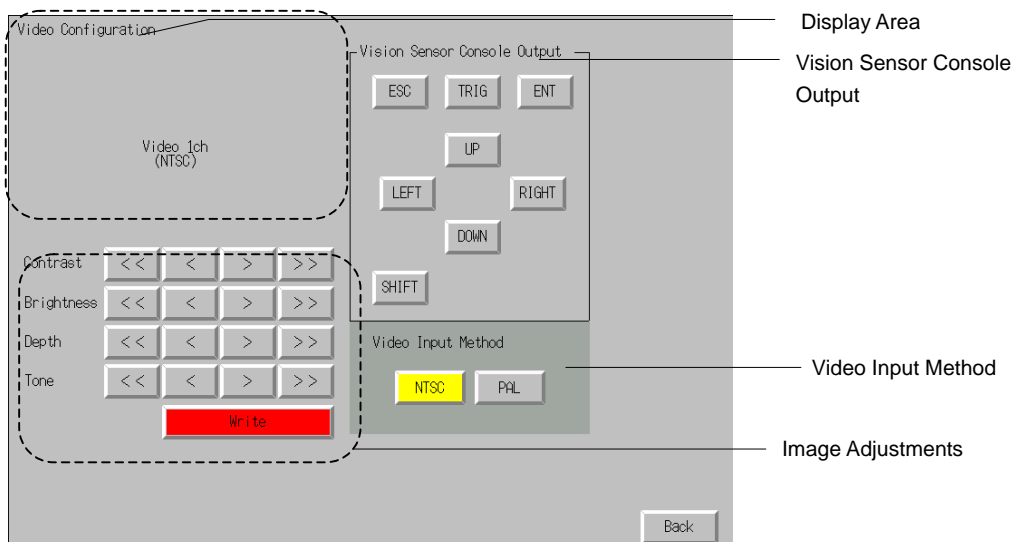

#### Exiting the Video Configuration

Click the **Back** Button to close the Video Configuration Window. The window will return to System Menu.

### Display Area

The image from the video device connected to channel 1 of the Video Input Unit is shown in the display area. This area turns blue if data is not input to channel 1.

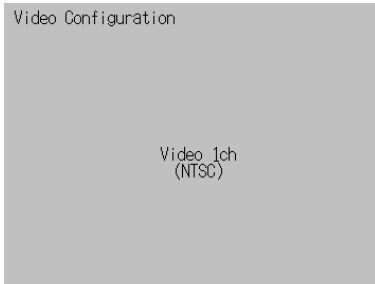

### Contrast Adjustments

The contrast adjustments affect the Video Input Unit. The contrast, brightness, depth, and tone of the image can be adjusted by clicking the buttons.

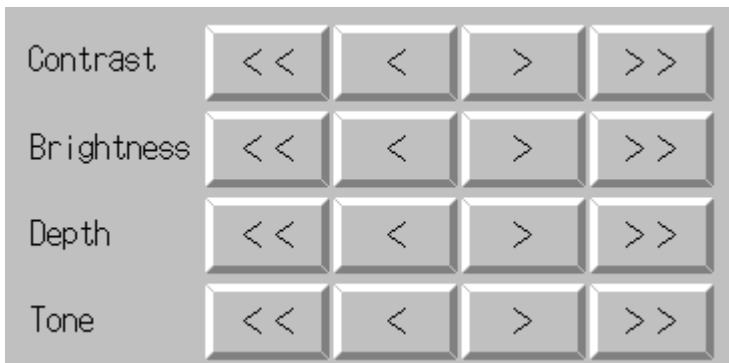

Values are changed as shown below.

Button	Increment/Decrement
<<	-10
<	-1
>	+1
>>	+10

#### *Reference*

- ◆ The image can be adjusted by using command buttons or Multifunction Objects as well. Refer to 2-9-3 *Command Buttons* or 2-11 *Multifunction Objects* for details.
- ◆ Settings will be written to the Video Input Unit when the **Write** Button is clicked. Previous settings will remain if the PT is restarted without clicking the **Write** Button.

## Vision Sensor Control Outputs

Various control signals can be sent to an OMRON Vision Sensor by pressing these buttons.

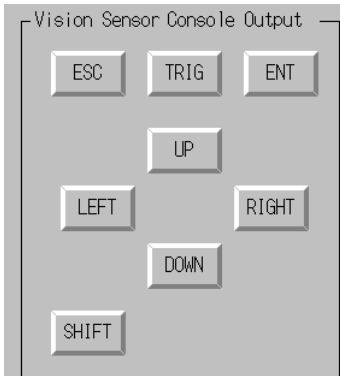

The signals and their actions are as follows:

Name	Description
ESC	Previous screen
TRIG	Execute measurement
ENT	Enter
UP	Move the cursor up or increase the setting by one.
DOWN	Move the cursor down or decrease the setting by one.
LEFT	Move the cursor left.
RIGHT	Move the cursor right.
SHIFT	Add the SHIFT signal. The SHIFT signal does not function by itself. It changes the function of another signal.

### Reference

- ◆ To add the SHIFT signal, press another signal button while holding down the **SHIFT** Button.
- ◆ The image can be adjusted by using command buttons or Multifunction Objects as well. Refer to 2-9-3 *Command Buttons* or 2-11 *Multifunction Objects* for details.

## 2-20-11 Programming Console Functions

Programming Console functions are utilities to enable a PT to be used in place of a Programming Console. These functions are included with the CX-Designer CD-ROM. The Programming Console functions are used on the PT as an external application. A separate Memory Card (15 MB min.) is required before these functions can be used.

Programming Console Function Programs for C-series PLCs

CX-Designer CD-ROM	<CD-ROM>: \\Utility\English\ProconFunc\For_C_series\proconC
-----------------------	----------------------------------------------------------------

Programming Console Function Programs for CS/CJ-series PLCs

CX-Designer CD-ROM	<CD-ROM>: \\Utility\English\ProconFunc\For_CS_CJ_series\procon
-----------------------	-------------------------------------------------------------------

### Note

- ◆ A CX-One CD-ROM is not included in the package. Please consult your OMRON representative.

Programming Console functions are built into the NS12, NS10, and NS8-V2 with system version 6.6 or higher and the NS5-□□1□-V2 or the NS15.

Communications method	Corresponding PLC
NT Link (1:1)	C Series (See notes 1 and 2) or SRM1
NT Link (1:N)	CS/CJ Series (See notes 1, 2 and 3)

- Note
1. Remove any Programming Console connected to the peripheral ports before using Programming Console functions.
  2. The PLCs cannot be connected to the Communications Board or a RS-232C port on the Communications Unit.
  3. The Programming Console function is not supported by the CJ2 CPU Units.

The following settings are required when using Programming Console functions.

- Set the unit number on the PT System Menu to "0". The Programming Console functions will not operate if any other unit number is set.
- Set the PLC DIP switch settings to write enabled. The Programming Console functions will not operate if the settings are write disabled.

### Preparations for Use of the Programming Console Functions

Copy the Programming Console function's program to the Memory Card.

Programming Console functions are built into the NS12, NS10, and NS8-V2 with system version 6.6 or higher and the NS5-□□1□-V2 or NS15, and so this preparation is not required.

#### For NT Link (1:1) Communications with C-series or SRM1 PLCs

1. Copy the *proconC* folder from the CD-ROM to the root directory of the Memory Card in the computer's PC card slot.  
The Memory Card will have the following configuration when the copying has been completed.  
Memory Card: \procon\  
                  \proconC\proconC\_v1\.

#### For NT Link (1:N) Communications with CS/CJ-series PLCs

1. Copy the *proconC* folder from the CD-ROM to the root directory of the Memory Card in the computer's PC card slot.  
The Memory Card will have the following configuration when the copying has been completed.  
Memory Card: \procon\  
                  \procon\procon\_v1\.

**Note**

- ◆ The Memory Card to which the files are copied must have at least 3.5 MB of free space to use the Programming Console functions on the C-series or CJ/CS-series PLCs.

2. Turn OFF the power supply to the PT and mount the above Memory Card into the Memory Card connector on the side of the PT.

**Note**

- ◆ Always stop Memory Card operations on the PT before inserting or removing the Memory Card.
- ◆ Always check system safety before turning the power supply ON or OFF or pressing the reset switch.
- ◆ Do not turn OFF the PT power or remove the Memory Card while the Memory Card is being accessed.

**Starting and Exiting the Programming Console Function****Starting the Programming Console Function**

There are two ways to start the Programming Console function.

1. Select **Special Function – PROCON** from the System Menu's Special Screen Tab Page.
2. From the user screen, write 4037 BCD (FC5 binary) or 4038 BCD (FC6 binary) to \$SW0.

**Note**

- ◆ Programming Console functions are built into the NS12, NS10, and NS8-V2 with system version 5.6 or higher and the NS5-□□1□-V2 or the NS15.

The Programming Console function's operations are the same as the Programming Console's operations.

**Note**

- ◆ Check system safety before performing the following operations using the Programming Console functions.
  - Changing Monitor data
  - Changing operating modes
  - Force ON or Force OFF
  - Changing present values or set values

**Starting from the System Menu**

1. Press two of the four corners of the PT touch panel simultaneously. (For the NS15, press any corner twice.)
2. The System Menu's Special Screen Tab Page will be displayed.
3. The Special Functions list will display the "Procon (C)" option for C-series and SRM1 PLCs with a 1:1 NT Link and the "Procon (CS)" option for CS/CJ-series PLCs with a 1:N NT Link. Touch the appropriate option to select it and then press the **Start** Button.



**NS Series Programming Manual**

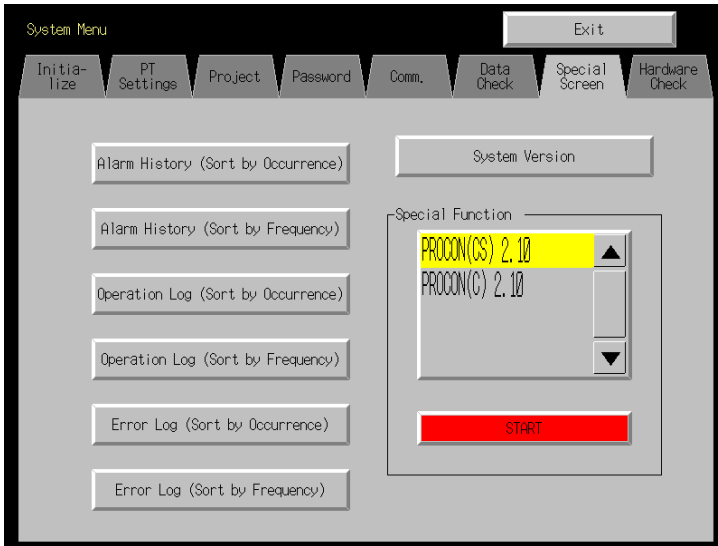

4. The Programming Console function will start.

**Starting from a User Screen**

1. Use a Macro or Word Button to set one of the following values in \$SW0.  
 C-series or SRM1 PLC with 1:1 NT Link: 4038 BCD or FC6 binary  
 CS/CJ-series PLC with 1:N NT Link: 4037 BCD or FC5 binary

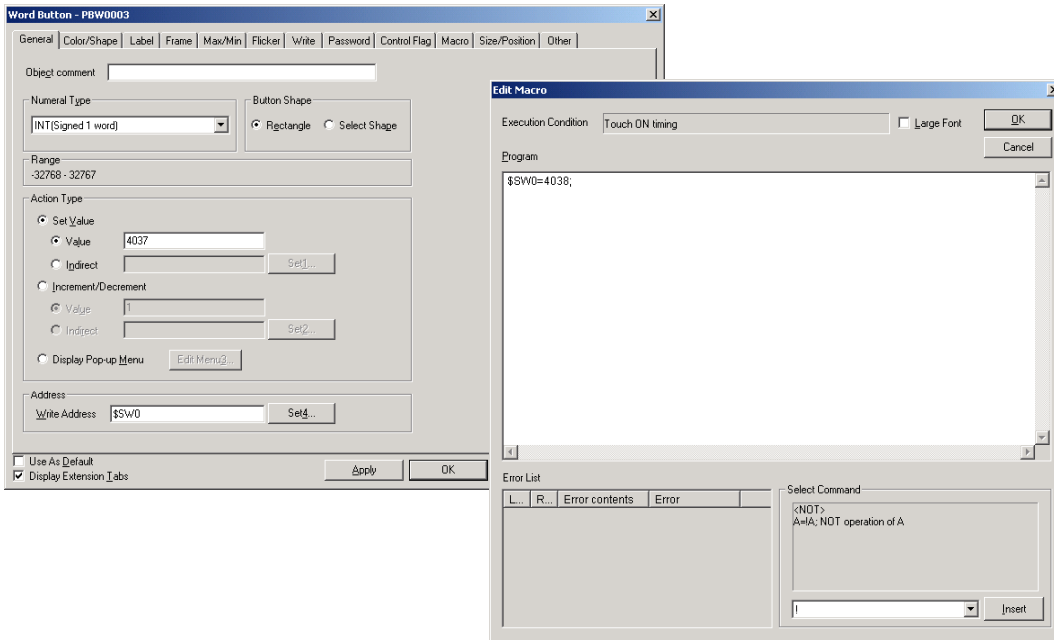

Or set a Multifunction Object to **Display System Menu – PROCON (CS)** or **PROCON (C)**.

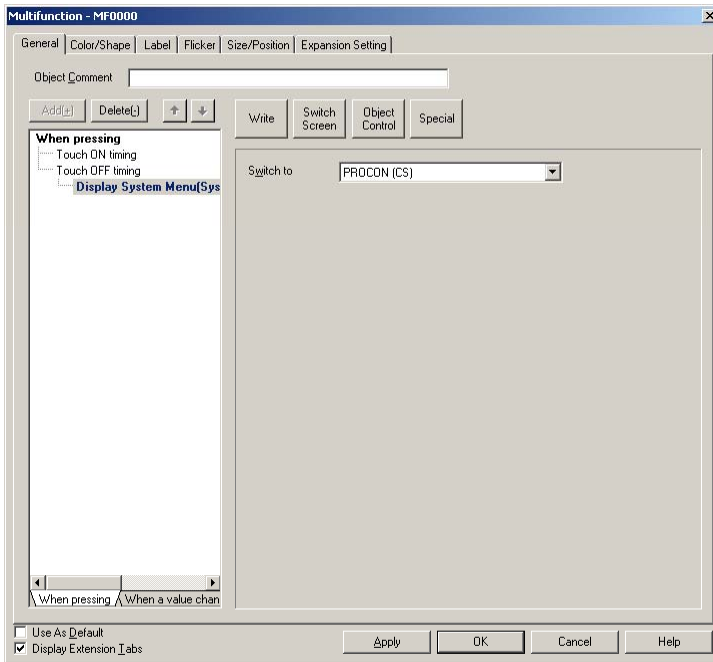

2. Operate the object (created in step 1) on the PT's screen.
3. The Programming Console function will start.

### Note

- ◆ The data storage format (binary or BCD) of the values set in \$SW0 is determined by the BCD/Binary setting in the System Memory List, which can be displayed by selecting **PT - System Setting**, clicking the **Initial** Tab, and clicking the **System Memory List** Button.

### Exiting the Programming Console Function

To close the Programming Console function, press the **Exit** Button. When the Programming Console function is closed in earlier-model PTs, the initial screen will be displayed. When the function is closed in a PT with the built-in Programming Console function, the PT will revert to the user screen that was displayed when the Programming Console function started. If the Programming Console function was started from the system menu, the PT will revert to the user screen displayed before the system menu.

### Note

- ◆ The NS-series PT will revert to the user screen that was displayed before the Programming Console function started only if the PT has system version Ver. 6.6 or higher and Programming Console function Ver. 2.10 or higher.

If the NS-series PT has a system version lower than Ver. 6.6 or a Programming Console function version lower than Ver. 2.10, the PT will be reset when the Programming Console function is closed. When the PT restarts, the initial screen is displayed.

## 2-20-12 PLC Data Trace

Like the CX-Programmer's Data Trace function, the PT's PLC Data Trace function uses the PLC's built-in Data Trace function and displays the results of the PLC's Data Trace operation on the PT.

When the trigger condition is met after the PLC receives the command from the NS-series PT to execute a data trace, the specified bit's status or specified word's present value is read according to the sampling condition and that data is stored in the CPU Unit's trace memory. The PT can read the data stored in the PLC and display the data on-screen in a time chart.

The PLC Data Trace function is supported only in NS-series PTs with system version Ver. 6.6 or higher. The function can be used in NS15, NS12, NS10, NS8, NSJ12, NSJ10, and NSJ8 PTs. The PLC Data Trace function is compatible with CS1/CJ1/CJ2 Series and NSJ Series PLCs (excluding CP Series PLCs).

### Specifications

Item	Description
Sampling period	During cyclic refreshing or once every 10 to 2,550 ms
Number of samples	2,000 samples
Number of bits in data trace	16 bits max.
Number of words in data trace	6 words max.
Trigger	Only a bit condition can be set.
Trace start delay	-1,999 to 2,000

### Reference

- ◆ A word cannot be set for the trigger. The sampling method cannot be set to use execution of TRSM instructions.
- ◆ The PLC Data Trace function is supported by the NS15, NS12, NS10, NS8, NSJ12, NSJ10, and NSJ8 PTs.  
The PLC Data Trace function is not supported by the NS5, NSJ5, or NSH-series PTs.
- ◆ Word PLC data trace cannot be performed with NS-series PT system versions that are lower than version 8.0.
- ◆ The PLC Data Trace function is compatible with CS/CJ Series and NSJ Series PLCs.  
For details on the Data Trace functions, refer to the PLC's Operation Manual.

### Starting and Exiting the PLC Data Trace Function

There are three ways to start the PLC Data Trace function.

1. Select **Special Function – PLC Data Trace** from the System Menu's Special Screen Tab Page.
2. From the user screen, write 4501 BCD (1195 binary) to \$SW0.
3. Execute a Multifunction Object for which displaying the system menu is set.

### Note

- ◆ The PLC Data Trace display will be switched between Japanese and English by the system language setting. The system language can be switched with the *Select Language* setting in the System Menu's Initialize Tab Page.

**Starting from the System Menu**

1. Select *PLC Data Trace* from the *Special Function* list on the System Menu's Special Screen Tab Page and press the **START** Button.

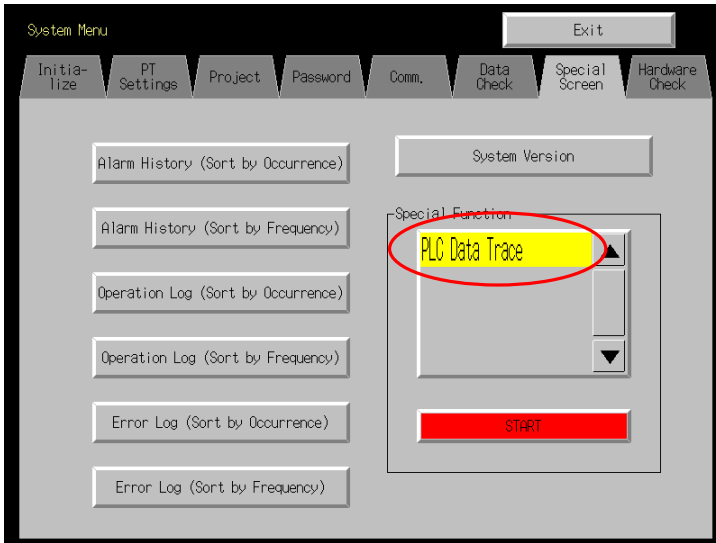

2. The PLC Data Trace function will start.

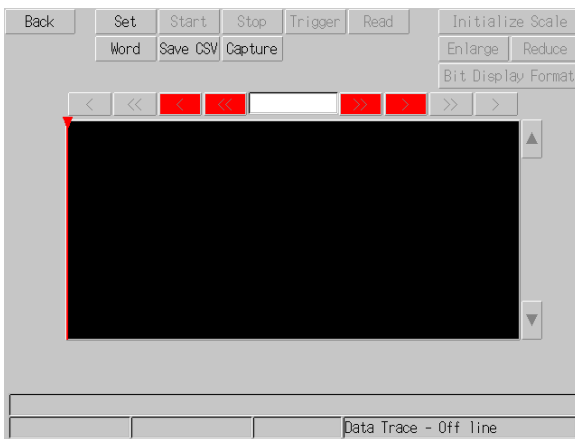

**Starting from a User Screen**

1. Use a Macro or Word Button to set 4501 BCD or 1195 binary in \$SW0.

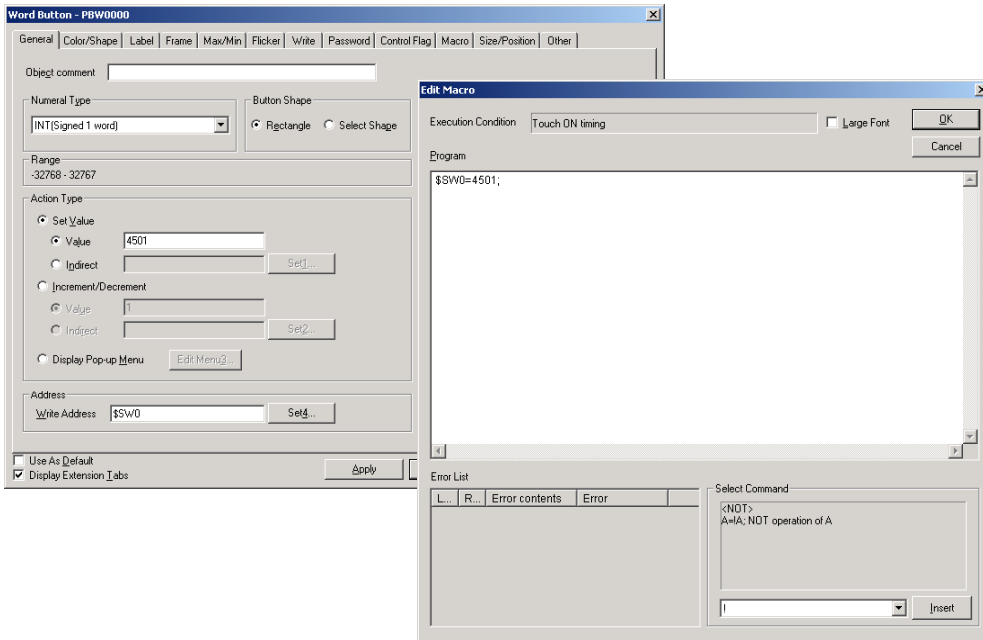

Or set a Multifunction Object to **Display System Menu - PLC Data Trace**.

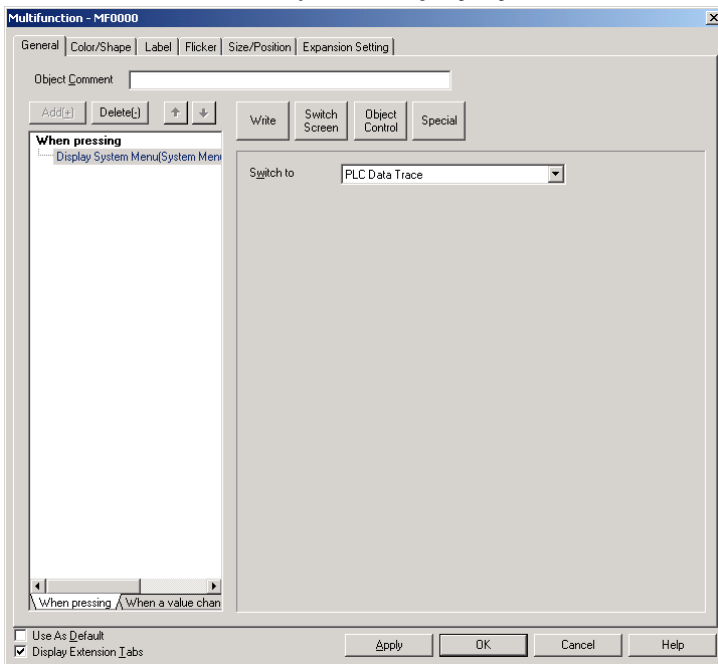

2. Operate the object (created in step 1) on the PT's screen.
3. The PLC Data Trace function will start.

**Note**

- ◆ The data storage format (binary or BCD) of the values set in \$SW0 is determined by the BCD/Binary setting in the System Memory List, which can be displayed by selecting **PT - System Setting**, clicking the **Initial** Tab, and clicking the **System Memory List** Button.

**Exiting the PLC Data Trace Function**

1. Press the **Back** Button in the PLC Data Trace Screen.

**NS Series Programming Manual**



2. The PT will revert to the user screen that was displayed before the PLC Data Trace function started. If the PLC Data Trace function was started from the system menu, the PT will revert to the user screen displayed before the system menu.

**Data Trace Parameter Settings**

The Data Trace function's parameters are set in the Data Trace Configuration Screen. Press the **Set** Button in the PLC Data Trace Screen.

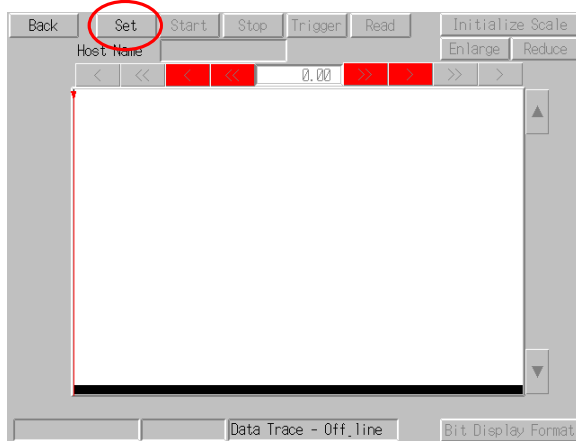

1. The Data Trace Configuration Screen will be displayed.

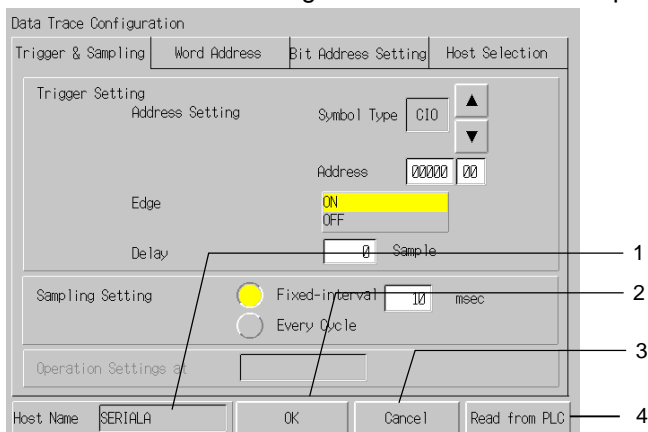

**NS Series Programming Manual**

No.	Item	Description
1	Host Name	Displays the name of the host that is currently connected. The host connection can be set in the Host Selection Tab page.
2	OK	Press this button to write the parameter settings to the PLC and return to the PLC Data Trace Screen.
3	Cancel	Press this button to cancel the parameter settings and return to the PLC Data Trace Screen.
4	Read from PLC	Reads the Data Trace execution conditions already set in the PLC. The settings read from the PLC will be reflected in each field in the screen. This feature can be used to execute another data trace with the same conditions.

**Setting the Trigger and Sampling Conditions**

The Trigger & Sampling Tab Page contains trigger settings such as the trigger bit conditions and delay, as well as the sampling settings.

1. Open the Data Trace Configuration Screen's Trigger & Sampling Tab Page.

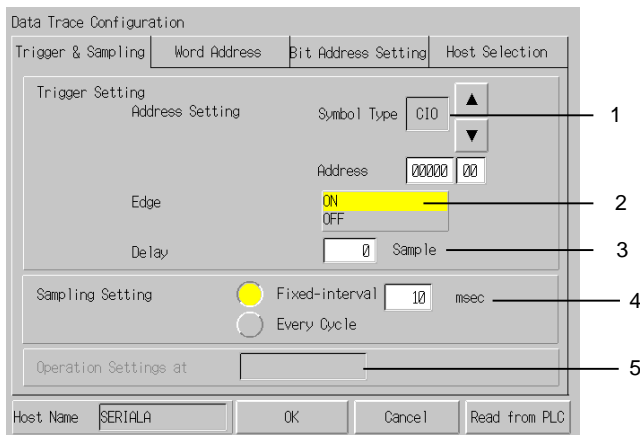

No.	Item	Description
1	Address Setting	Sets the bit to use as the Data Trace trigger. Press the ▲ and ▼ buttons to switch the data area. The CIO, WR, HR, AR, TU, or CU data area can be selected. Press the Address Field to display a tenkey pad. Input the address to be monitored. Addresses can be set between 0.0 and 32767.15, but be sure to input an address that is valid in the connected PLC.
2	Edge	Selects either ON or OFF (up-differentiated or down-differentiated) for the execution condition.
3	Delay	Sets the delay value between -1,999 and 2,000. The delay value specifies how many samples to offset the starting trace position from the point when the trigger condition was met.
4	Sampling Setting	Selects the sampling method. <ul style="list-style-type: none"> <li>• Fixed-interval: Sets sampling at regular intervals (10 to 2,550 ms). The I/O data is sampled at each sampling period.</li> <li>• Every Cycle: Samples the data once every cycle. The I/O data is sampled after execution of the END instruction.</li> </ul>
5	Operation Settings at Startup	When reading the configuration settings from a CJ2 CPU Unit, the Trace Start on Monitor/Run Mode settings will be displayed.

**Setting Word Addresses**

Set the address of the word to be sampled.

1. Open the Word Address Tab Page on the Data Trace Configuration Screen.

**NS Series Programming Manual**

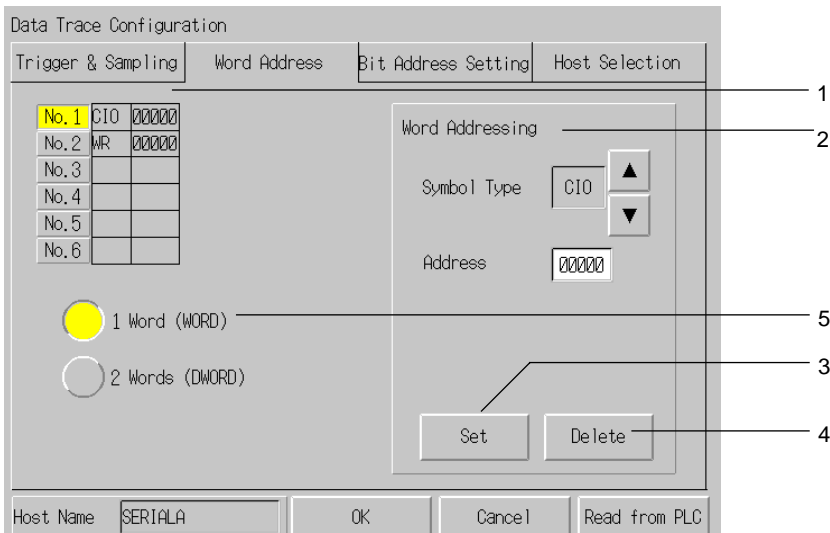

No.	Item	Description
1	Addresses	The word to be sampled is displayed. To change or delete the settings, click the No. Button and select the bit.
2	Word settings	Edit the word to be sampled. Click the Up or Down Buttons to change the type. Words can be set in the following areas: CIO, Work, Auxiliary, Timer, Counter, DM, current EM bank, and EM banks 0 to 18 hex. The ten-key will be displayed when the address display area is clicked. Enter the address to be monitored. Addresses 0 to 32,767 can be set, but enter a value that is within the address range of the area in the PLC to be connected.
3	Settings	Sets the specified word address in the address list.
4	Delete	Deletes the specified address from the address list.
5	Trace data size	Sets whether to sample the specified address as 1-word data or 2-word data.

**Note**

- ◆ Be sure to click the Set Button to add the specified address to the address list.

**Setting the Bit Addresses**

The Bit Address Setting Tab Page sets the bit addresses of the bits to be sampled.

1. Open the Data Trace Configuration Screen's Bit Address Setting Tab Page.

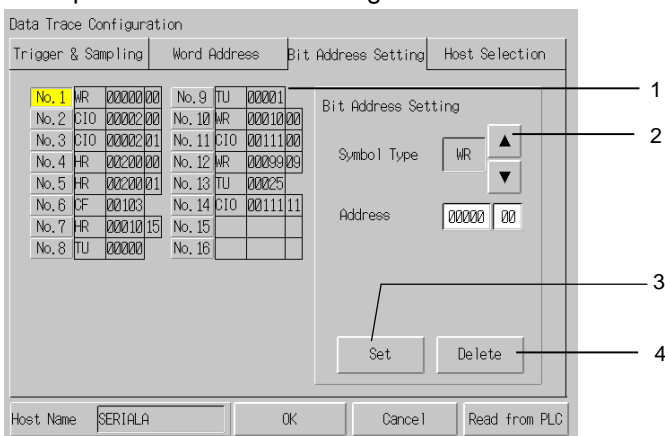

No.	Item	Description
1	Address List	Displays the bit address of the bit to be sampled. When changing or deleting a setting, press the No. Button and select the bit.



**NS Series Programming Manual**

No.	Item	Description
2	Bit Address Setting	<p>Edit the bit to be sampled.</p> <p>Press the ▲ and ▼ buttons to switch the data area. The CIO, WR, HR, AR, TU, CU, CF, DM, EM, or EM0 to EM18 data area can be selected.</p> <p>Press the Address Field to display a tenkey pad. Input the address to be monitored. Addresses can be set between 0.0 and 32767.15, but be sure to input an address that is valid in the connected PLC.</p> <p>If a CF address is being set, select the address from the displayed list.</p> 
3	Set	Sets the bit selected in the Bit Address Setting Field in the Address List.
4	Delete	Deletes the selected address from the Address List.

**Note**

- ◆ Always press the **Set** Button to set the edited *Bit Address Setting* in the Address List.

**Selecting the Host**

The Host Selection Tab Page sets the host in which the data trace will be executed.

1. Open the Data Trace Configuration Screen's Host Selection Tab Page.

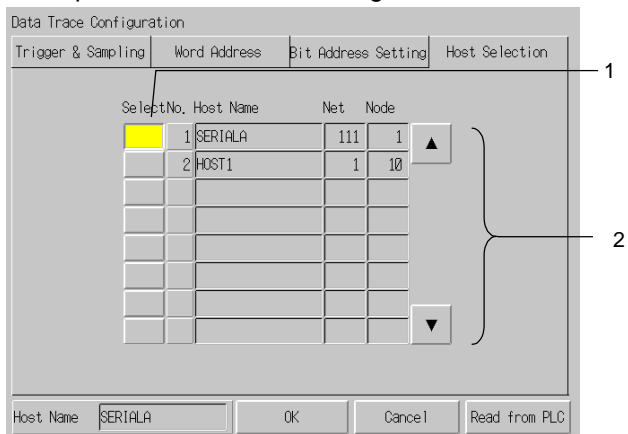

No.	Item	Description
1	Select	Selects the host.
2	Host Name	Lists the hosts registered in the project.

**Note**

- ◆ When a host has not been selected, the host at the top of the list is selected by default.
- ◆ The data tracing is supported by the CS/CJ Series (except the CP1) and the NSJ Series Controller section. Select a host that is set to one of these PLCs.

**Executing the Data Trace**

This section explains how to execute the data trace.

Before executing a data trace, the data trace parameters must be set in the Data Trace Configuration Screen.

**NS Series Programming Manual**

1. Press the **Start** Button at the top of the PLC Data Trace Screen.
2. The data trace will start. If the trigger condition is met, sampling will start and the trace data will be stored in the CPU Unit's trace memory. When the trace memory becomes full, sampling will stop automatically, the trace data will be read from the CPU Unit's trace memory, and the sampling data will be displayed as shown below. The trigger condition can also be forced by pressing the **Trigger** Button.
3. To stop the data trace before the trace memory is full, press the **Stop** Button. In this case, press the **Read** Button to display the sampling data.

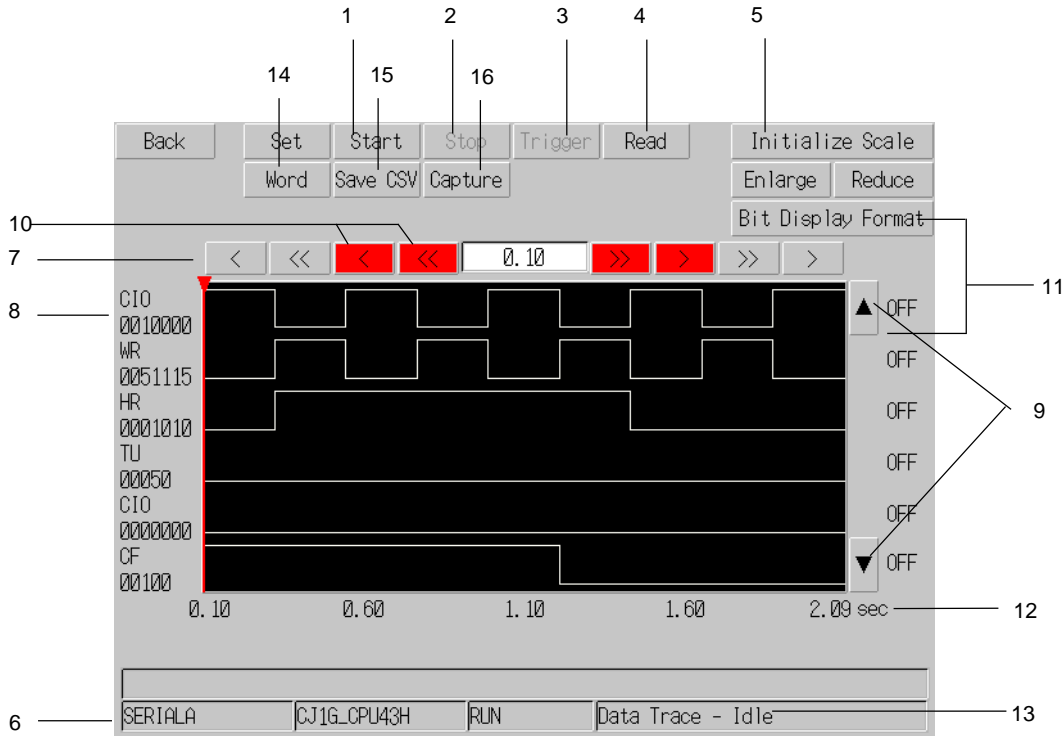

No.	Item	Description
1	Start	Starts the data trace.
2	Stop	Stops the data trace.
3	Trigger	Establishes the trace condition and starts sampling.
4	Read	Reads the results of the data trace. When the CPU Unit's trace memory is full, the results are read and displayed automatically, even if this button is not pressed.
5	Initialize Scale	Changes the display scale of the X axis (time axis). <ul style="list-style-type: none"> <li>Initialize Scale: Displays 200 points on the screen.</li> <li>Enlarge: Enlarges the display scale by one level.</li> <li>Reduce: Reduces the display scale by one level.</li> </ul> The display scale changes the number of displayed points in steps between 10, 20, 50, 100, 150, 200, 250, 300, 350, 400, 450, and 500.
6	Host Name	Displays the name of the host in which the data trace is being performed.
7	Horizontal Scroll Buttons	Scrolls in the horizontal direction. <ul style="list-style-type: none"> <li>The &lt; and &gt; Buttons scroll by one point.</li> <li>The &lt;&lt; and &gt;&gt; Buttons scroll by one page.</li> </ul>
8	Bit Addresses	Displays the specified bit address.
9	Vertical Scroll Buttons	Scroll up or down in each graph.
10	Cursor Movement	These Buttons move the cursor. <ul style="list-style-type: none"> <li>The &lt; and &gt; Buttons move the cursor by one point.</li> <li>The &lt;&lt; and &gt;&gt; Buttons move the cursor by 50 points.</li> <li>Numeral input: Displays the cursor position (X axis). The cursor can be moved to a any position by inputting the corresponding number.</li> </ul>

**NS Series Programming Manual**

No.	Item	Description
11	Status at cursor position	Displays the status of each bit address at the cursor position. The status is displayed as ON/OFF or 1/0. (The display format can be switched by pressing the <b>Bit Display Format</b> Button.)
12	Seconds/sample	Displays the seconds/sample at the beginning of the graph, the 1/4 position, 1/2 position, 3/4 position, and end of the graph.
13	Status Display	Displays the following information. <ul style="list-style-type: none"> <li>• PLC model: Displays model of the PLC performing the data trace.</li> <li>• Operating mode: Displays the operating mode of the PLC performing the data trace.</li> <li>• Trace status: Displays the status of the data trace.</li> </ul> Displays the status in the format "Data Trace - XXXX". Where the XXXX is one of the following. Offline: Disconnected from host. Idle: After the data trace was executed, it stopped without having the trigger condition met. Sampling: Executing the data trace. Reading: Reading the sampled data. Stopped: After the trigger condition was met, the data trace was stopped during sampling. Triggered: The trigger condition was met or the <b>Trigger</b> Button was pressed. Completed: Sampling was completed and trace data was collected in trace memory.
14	Word display	Switches to the screen displaying the word trace data.
15	Save CSV	Saves the result data collected from the data trace as a CSV file. For details, refer to <i>Saving Collected Data</i> .
16	Capture	Captures the screen and saves it to the Memory Card as a bit file. The bmp file will be created on the Memory Card in the following folder. Memory Card\LOG\CAPTURE The bmp file will be saved with the following name: screen_cap_XXX.bmp (XXX:001 to 999) All numbers from 001 to 999 of the file number for screen_cap_XXX.bmp will be used, but if the Memory Card does not have enough free space, the file will be saved after the oldest file is deleted.

**PLC Data Trace Screen (Word)**

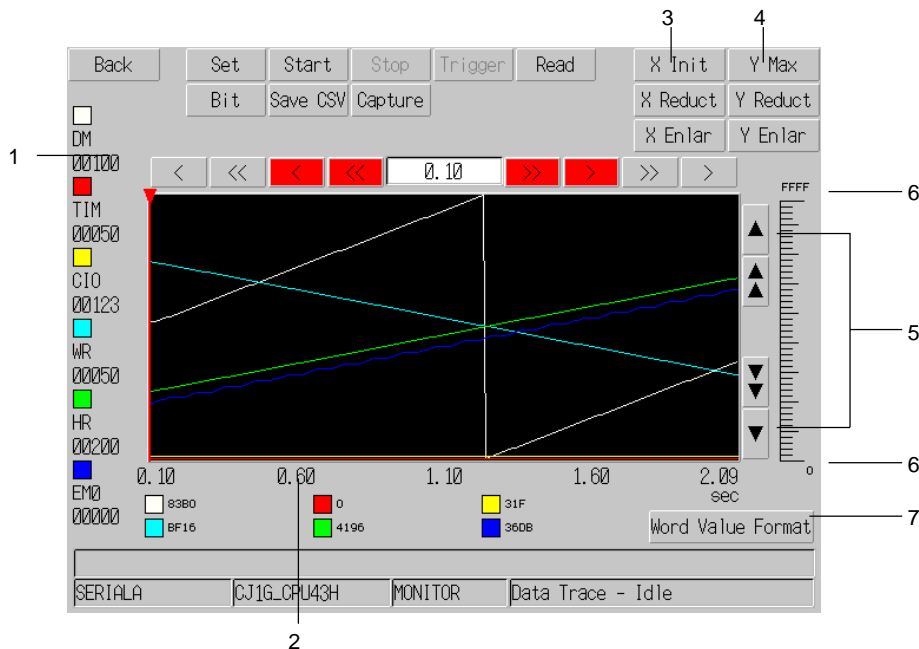

Note: The data trace screen slightly varies between the NS15, NS12, and NS10/NS8. (The functions are the same.) This section provides an explanation using the NS10 as an example.

**NS Series Programming Manual**

No.	Item	Description
1	Word address	Displays the specified word and the color for that word. The I/O comment read from the PLC will be displayed when the I/O Comment Button is turned ON.
2	Cursor position status	Displays the word address value at the cursor position.
3	X axis display magnification	Changes the X axis (time axis) display magnification. <ul style="list-style-type: none"> <li>• X axis initial setting: Displays 200 points.</li> <li>• X axis enlarge: Increase the display factor by one step.</li> <li>• X axis reduce: Reduce the display factor by one step.</li> </ul> The display magnification can be changed between the following number of display points: 10, 20, 50, 100, 150, 200, 250, 300, 350, 400, 450, and 500.
4	Y axis display factor	Changes the display magnification for the Y axis (value). <ul style="list-style-type: none"> <li>• Y axis maximum: The display magnification depends on the setting for the data trace size in the Data Trace Configuration Screen. (The display format can be changed with the word value format.)                             <ul style="list-style-type: none"> <li>• One word: 0 to 0Xffff</li> <li>• Two words: 0 to 0xFFFFFFF</li> </ul> </li> <li>• Y axis enlarge: Enlarges the display magnification. Sets the display range to 1/2 the present value. The display can be enlarged up to 256 points.</li> <li>• Y axis reduction: Reduces the display magnification. Doubles the present display range. Can be reduced to the Y axis maximum range.</li> </ul>
5	Vertical scroll button	Scrolls vertically on the graph.
6	Graph upper and lower limits	Displays the upper and lower limits of the graph.
7	Word value format	The number display format for cursor position status and graph upper and lower values can be selected from the following. <ul style="list-style-type: none"> <li>• BIN (binary)</li> <li>• Decimal</li> <li>• Signed decimal</li> <li>• HEX (hexadecimal)</li> </ul>

**Note**

- ◆ The bmp file of the captured screen can also be checked using the Display Capture Data in the System Menu of the NS-series PT. (Refer to the *NS-series PT Setup Manual*.)

**Saving Collected Data**

Data trace data read from the PLC can be saved as a CSV file on the Memory Card.

1. Click the **Save CSV** Button in the PLC Data Trace Window.

A CSV file will be created in the following folder on the Memory Card.

Memory Card¥LOG¥Trace

The CSV file name will be called PDT\_yyddmm\_hhmmss.csv.

PDT\_yyddmm\_hhmmss.csv

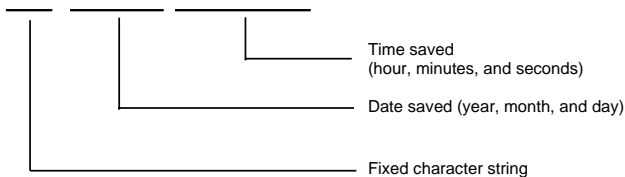

The CSV file format is as follows:

**NS Series Programming Manual**

[Trace Properties]			
Trace Mode	Data Trace		
Date	3/17/2008 12:48:11 PM	1	
Host Name	SERIALA	2	
PLC	CJ1G-H-CPU43		
Trigger Conditions:			
Address	CIO000008	3	
TIM/CNT	Off		
Edge	Falling Edge		
Delay	50		
Sampling Conditions:			
Once Per Cycle		4	
Trace data size(word)	Single Word		
[Trace data format]			
Contact	Bit	5	
Word	Hexadecimal		
[Trace Data]			
Sampling No	CIO0000000	D1	6
	50	0 0000 HEX	7
	51	0 0000 HEX	
	52	1 003C HEX	
	53	1 003C HEX	

No.	Item	Description
1	Date and time read	The date and time that the trace data is read are output.
2	Connection destination information	The host name and model name of the connected PLC are output.
3	Trigger conditions	The trigger settings made in the Data Trace Configuration Screen are output. The TIM/CNT Flag is always OFF.
4	Sampling conditions	The sampling conditions settings and trace data size settings made in the Data Trace Configuration Screen are output. The sampling cycle will be output if fixed interval is set as the sampling condition.
5	Data trace format	The display method for the cursor position bit and word values set in the PLC Data Trace Screen are output.
6	Sampling conditions/communications address	The first line is displayed is the sampling unit. The communications addresses for which data was traced are output to the second and further lines.
7	Trace data	The time (seconds) for sampling was performed or the sampling number is output to the first line. Communications addresses are output to the second and further lines. The output is performed in the format set for the trace data format.

**Errors When Using the PLC Data Trace Function**

**Error Messages Displayed on the PLC Data Trace Screen**

	Message	Corrective action
T	Failed to execute the trigger.	Check whether the connecting cable is connected properly.
	Failed to read the trace data.	Check whether the connecting cable is connected properly.
	Failed to start trace.	Check whether the connecting cable is connected properly.
	Failed to stop trace.	Check whether the connecting cable is connected properly.

**NS Series Programming Manual**

**Error Messages Displayed on the Data Trace Configuration Screen**

	Message	Corrective action
S	Unsupported setting data has been read. Please set again.	One of the following settings, which is not supported by the PLC Data Trace function, was read from the PLC. Correct the setting in the Data Trace Configuration Screen. Settings not supported by the PLC Data Trace function: <ul style="list-style-type: none"> <li>• A word address was set as the trigger address.</li> <li>• The Sampling Setting was a setting other than <i>Fixed-interval</i> or <i>Every Cycle</i>.</li> <li>• A word address was set as the address to be sampled.</li> <li>• More than 16 bits were set to be sampled.</li> </ul>
	Bit is not specified.	The <b>OK</b> Button was pressed without any bits set for sampling. Set a bit address.
		The <b>Delete</b> Button was pressed, but the selected <i>No.</i> does not have a bit address set. Select the <i>No.</i> of the row containing the bit address to be deleted.
T	Failed to read the trace setting area.	Check whether the connecting cable is connected properly.
	Failed to set the trace parameter.	Check whether the connecting cable is connected properly.
		An out-of-range bit address was set. Set an address that is valid in the PLC performing the data trace.
N	Exceeding Maximum/Minimum limit	Set a number within the allowed range.

## 2-21 System Settings and System Menu

The parameters for NS-series PT operation are set under CX-Designer system setting or the PT System Menu. These settings include backlight brightness, buzzer sound, communications settings, and data initialization.

The System Menu is also used to display operation and alarm histories and special screens such as the device monitor function screens and perform PT hardware checks. The settings that can be made under system setting or the System Menu are outlined in the following table.

Item	CX-Designer system setting	PT System Menu
Screen data area format	×	○
Operation log initialization and save	×	○
Alarm/event history initialization and save	×	○
Data log initialization and save	×	○
Error log initialization and save	×	○
Language selection	▲(See note 6.)	○
Startup wait time	○	○
Key press sound	○	○
Backlight	×	○
Buzzer sound	○	○
Screen saver (operation)	○	○
Screen saver start-up time	○	○
Calendar check	×	○
Printer control method	○	○
Printing method	○	○
Orientation	○	○
Tag update notification message	○	○
Double-touch Interval (NS15 Only)	×	○
Project title	▲ (See note 1.)	▲
Number of labels	▲ (See note 2.)	▲
Initial screen number	○	○
Initial label	▲ (See note 7.)	○
Operation log record method	○	▲
Alarm/event history record method	▲ (See note 3.)	▲
Data log record method	×	▲
Error log record method	×	▲
System memory (allocated addresses)	○	▲
Password	▲ (See note 4.)	○
Serial port A (usage)	▲ (See note 9.)	○
Serial port B (usage)	▲ (See note 9.)	○
Ethernet (usage)	▲ (See note 9.)	○
Controller Ling (usage)	▲ (See note 9.)	▲
\$SB and \$SW update cycle	○	×
Intervals of Run signal (Pulse)	○	×
Intervals of Message-Comm.	▲ (See note 9.)	×
Serial port A (communications method)	▲ (See note 9.)	○
Serial port B (communications method)	▲ (See note 9.)	○
Ethernet (communications conditions)	▲ (See note 9.)	○
Controller Link (Communications Conditions)	▲ (See note 9.)	○
Communications auto return	▲ (See note 9.)	○
Timeout interval	▲ (See note 9.)	○
Retry counts	▲ (See note 9.)	○
Screen data confirmation	×	▲
Read allocation address	▲ (See note 9.)	×

Item	CX-Designer system setting	PT System Menu
Host name	▲ (See note 9.)	△ (See note 10.)
Host type	▲ (See note 9.)	○ (See note 10.)
Network address	▲ (See note 9.)	○ (See note 10.)
Node address	▲ (See note 9.)	○ (See note 10.)
IP address	▲ (See notes 9 and 12.)	○ (See note 12.)
Route path	▲ (See notes 9 and 12.)	○ (See note 12.)
Operation log display	×	△
Alarm history display	×	△
Error log display	×	△
Device monitor	×	○
Communications test	×	○
Video Configuration	▲ (See note 5.)	○
Display Capture Data	▲ (See note 8.)	○
USB device list	×	○ (See note 13.)
PLC Data Trace	×	○
Version display	×	△
LCD check	×	△
Touch switch check	×	○
Touch panel Calibration (NS15 Only)	×	○
Video input method	○	×
Save in a file	○	×
Key Status Address	○	×

○: Can be set, ×: Cannot be set, △: Display only  
 ▲: Can be set using different CX-Designer menu

- Note
1. Set using Title Tab Page in the Project Property Dialog Box under *PT - Project Properties*.
  2. Set using Switch Labels Tab Page in the Project Properties Dialog Box under *PT - Project Properties*.
  3. Set in the Alarm/Event Parameter Setting Dialog Box, which is displayed when the Parameter Setting Button is pressed. The Parameter Setting Button is found in the Alarm/Event Setting Dialog Box under *PT - Alarm/Event*.
  4. Set in the Password Setting Dialog Box under *PT - Password setting*.
  5. Set in Video Control – Vision Sensor Console or Video Control – Contrast Adjustment in the Command Button Setting Dialog Box to control images.
  6. Set on the Select Language Tab of the Project Property Dialog Box under *PT - Project Properties*.
  7. Set using Switch Labels Tab Page in the Project Property Dialog Box under *PT – Project Properties*.
  8. A button to switch to the Display Capture Data screen can be created with the Display System Menu command button function.
  9. Set by selecting **PT – Communication Setting** on the Comm. Setting Dialog Box.
  10. Only for hosts connected via Ethernet or Controller Link.
  11. If the screen saver startup time is specified indirectly, only the allocated address will be displayed.
  12. Only when connected to the host through EtherNet/IP. The setting cannot be changed if the host type is set to EtherNet/IP,
  13. Only printers connected to the USB host connector will be displayed. (PictBridge-compatible printers will not be displayed.)

Refer to the *System Settings* and *Project Properties* settings in the *CX-Designer Online Help* and *Section 6 System Menu Operations* in the *NS Series Setup Manual* (Cat. No. V083) for detailed explanations of CX-Designer system settings and the PT System Menu.



## 2-22 Transferring Device Data

### 2-22-1 What Is Device Data Transfer?

Device data transfer is used to read a specified number of elements starting from a transfer source address at a specified time, and write them to memory starting from a destination address.

Multiple device data transfer entries can be set by saving device data transfer setting groups in a device data transfer table.

For example, assume that the process value (C00000) of the Temperature Controller connected to the PT is transferred to EM200 in the EM Area in the PLC as shown below. Here, the Temperature Controller would be the transfer source device and the PLC would be the transfer destination device. When the trigger condition is met (i.e., when address CIO 10.5 turns ON), device data 200 from the Temperature Controller will be transferred to EM200 in the PLC.

As you can see, the Temperature Controller is not connected directly to the PLC, but Temperature Controller data can be transferred to the PLC through the PT without any special programming.

Device data transfer settings

- Trigger condition: Serial B, CIO 10.5 turning ON
- Transfer source device: Serial A: 0#C00000
- Transfer destination device: Serial B: EM200

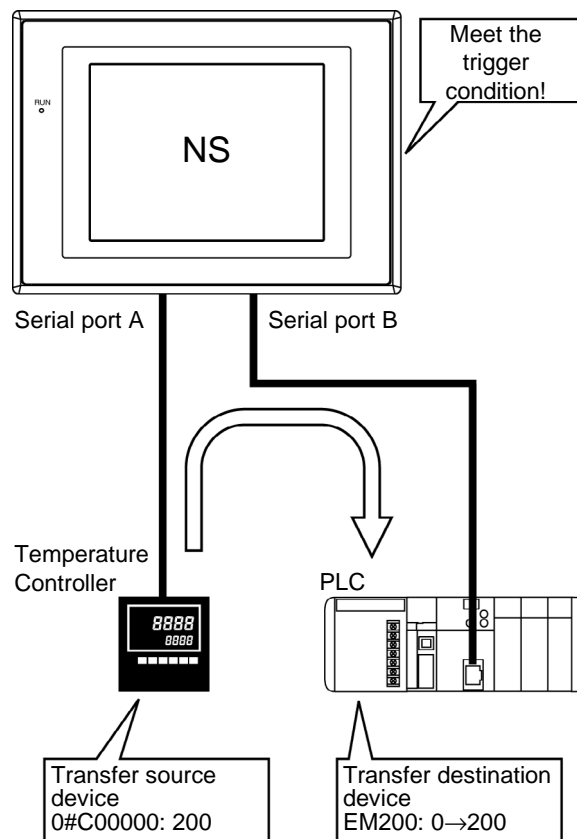

The device data transfer function consists of the following three elements.

- Device Data Transfer Setting Table  
A device data transfer setting table is used to manage multiple device data transfer setting groups. Only one device data transfer table can be set in a project.
- Device Data Transfer Setting Groups  
Device data transfer setting groups are used to manage multiple device data transfer entries. Trigger addresses and the transfer timing or cycle can be set. Up to 10 device data transfer setting groups can be set in a table.
- Device Data Transfer Entries  
The transfer source address, transfer destination address, and number of elements are set. Up to 1,024 device data transfer entries can be set in each group.

**NS Series Programming Manual**

One device data transfer table can be used to transfer up to 1,024 data elements. The maximum numbers of groups and entries that can be set may be less than those given above depending on the numbers of data elements that are set. For example, if 1,024 data elements are set for entry 0 of group 0, then no other groups or entries can be set.

A schematic diagram for device data transfer settings is shown below.

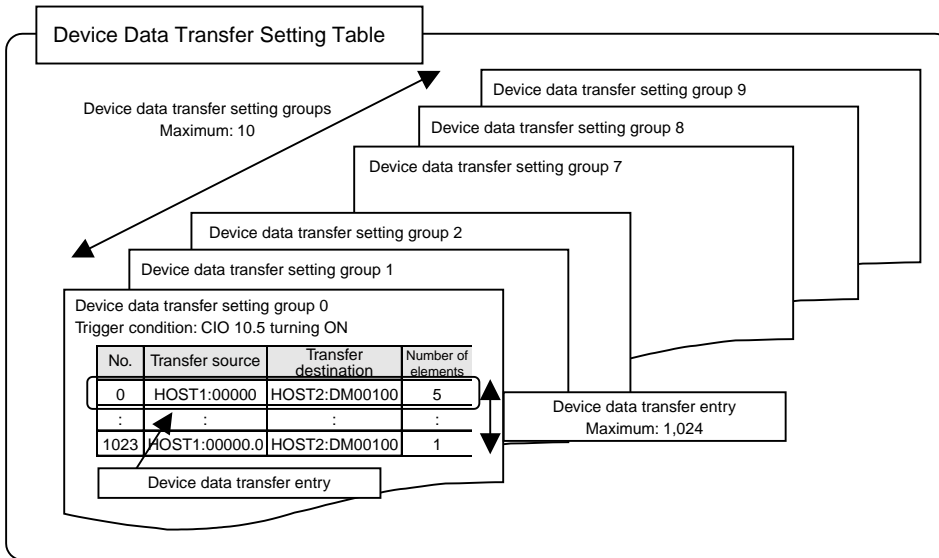

**2-22-2 Device Data Setting Dialog Box**

Select **Device Data Transfer Settings** from the PT Menu. The Device Data Transfer Setting Dialog Box will be displayed.

**Device Data Transfer Setting Table**

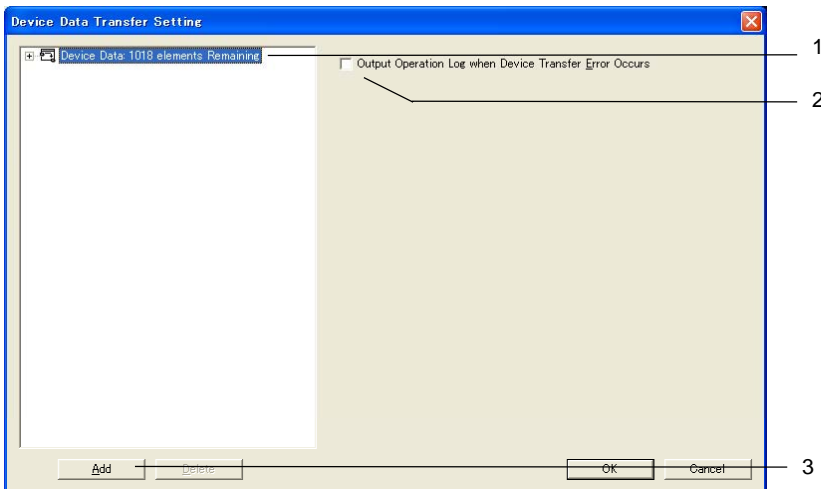

No.	Item	Description
1	Device data transfer setting table	Displays the device data transfer setting table and the number of elements remaining that can be set.
2	Output Operation Log when Device Transfer Error Occurs	When this check box is selected, a transfer error will be output to the operation log when a device transfer error occurs.
3	Add Button	Click the <b>Add</b> Button to add a device data transfer setting group. (The operation is the same as right-clicking the device data transfer setting table and selecting <b>Add</b> from the pop-up menu.)

**Note**

- ◆ The Device Data Transfer Setting Dialog Box can also be displayed by selecting Device Data Transfer Setting on the Common Settings Tab Page in the Property Workspace Window.

**NS Series Programming Manual**

**Device Data Transfer Setting Groups**

Select the device data transfer setting table and click the **Add** Button. A device data transfer setting group will be added and the settings will be displayed.

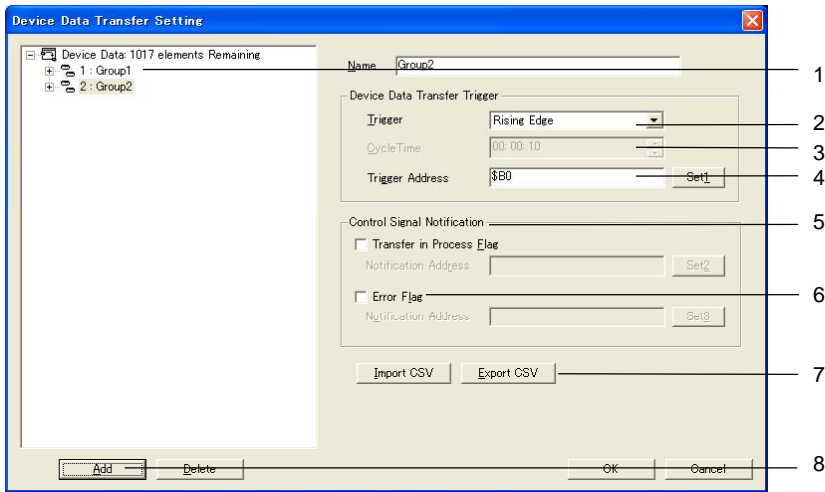

No.	Item	Description
1	Device data transfer setting groups	The names of the device data transfer setting groups are displayed. Up to 32 characters can be input for a group name.
2	Trigger type	Sets the device data transfer condition. Select from <i>Rising Edge</i> (turning ON), <i>Falling Edge</i> (turning OFF), or <i>Cycle</i> .
3	Cycle Time	Sets the cycle time in hours, minutes, and seconds. This setting can be made only when the trigger condition is set to <i>Cycle</i> .
4	Trigger address	Sets the trigger address. This setting cannot be made if the trigger condition is set to <i>Cycle</i> .
5	Transfer in Progress Flag	Sets a flag to indicate that device data is being transferred. If you set a flag, set the address of the flag in the <i>Notification Address</i> Field.
6	Error Flag	Sets a flag to indicate that an error has occurred. If you set a flag, set the address of the flag in the <i>Notification Address</i> Field.
7	Import CSV and Export CSV Buttons	Imports or exports a CSV file.
8	Add	Adds a group to the table if the focus is on the table. Adds an entry to the group if the focus is on a group.

**Device Data Transfer Setting Entries**

Select the device data transfer setting table and click the Add Button. A device data transfer setting group will be added and the settings will be displayed.

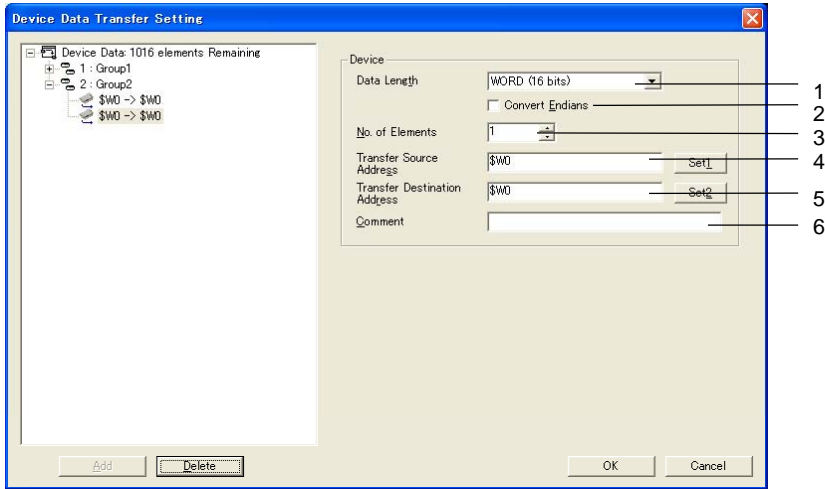

No.	Item	Description
1	Data Length	Sets the data length for the transfer source and destination addresses. The length will be the same for both the transfer source and destination addresses. Select from the following: BIT (1 bit), BYTE (8 bits), WORD (16 bits), or DWORD (32 bits).
2	Convert Endians	Select this check box to convert the endian when data is transferred from the source address to the destination address. This setting cannot be made when the data length is set to BIT.
3	No. of Elements	Sets the number of elements (1 to 1,024) to be transferred starting from the source address to memory starting from the destination address. This setting is always 1 when the data length is set to BIT.
4	Transfer Source Address (See note.)	Sets the transfer source address.
5	Transfer Destination Address (See note.)	Sets the transfer destination address.
6	Comment	Sets a comment.

Note: This address must be set. A tag cannot be set.

**Precautions for Correct Use**

- Reading from the transfer source and writing to the transfer destination of the device data transfer function is sometimes performed in multiple transfers. Data concurrency may not be maintained for the data.
- If a communications error or a PT power interruption occurs while data is being read from the transfer source, processing will stop and the data will not be transferred to the destination.
- If a communications error or a PT power interruption occurs while data is being read to the transfer destination device after having been read from the transfer source, processing will stop. Depending on the size of the data transfer, it is possible that only that portion of the data that was read to the destination device before the interruption will be transferred.

**NS Series Programming Manual**

**When the Size of Memory Accessed by Each Address (i.e., the Access Size) Is Different at the Source and Destination**

The data transfers that would be performed for various data lengths and numbers of elements are shown below for when the transfer source access size is 16 bits and the transfer destination access size is 8, 16, or 32 bits.

\* These examples all show the transfer source data and transfer destination data that would be displayed on the PT using Numeral Display and Input objects.

• **Transfer Destination Access Size of 8 Bits (without Endian Conversion)**

Offset	+0	+1	+2	+3	+4	+5	+6	+7
Transfer source (8 bits)	01	02	03	04	05	06	07	08

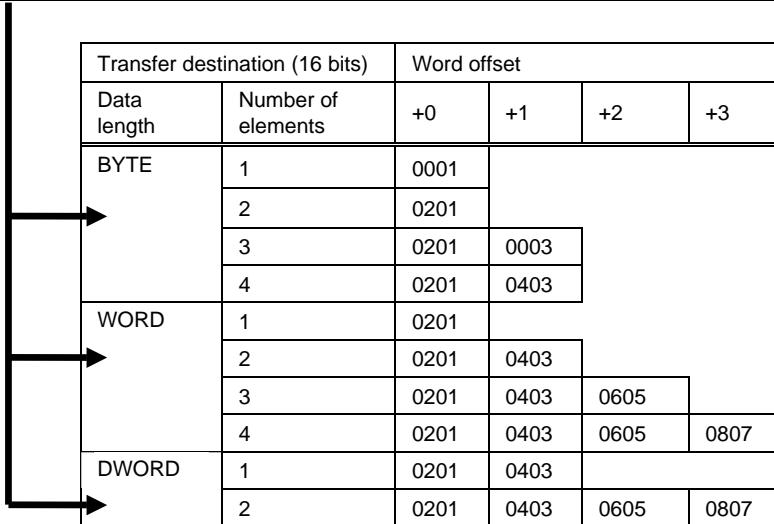

• **Transfer Destination Access Size of 16 Bits (without Endian Conversion)**

Offset	+0	+1	+2	+3	+4	+5	+6	+7
Transfer source (16 bits)	0102	0304	0506	0708	090A	0B0C	0D0E	0F10

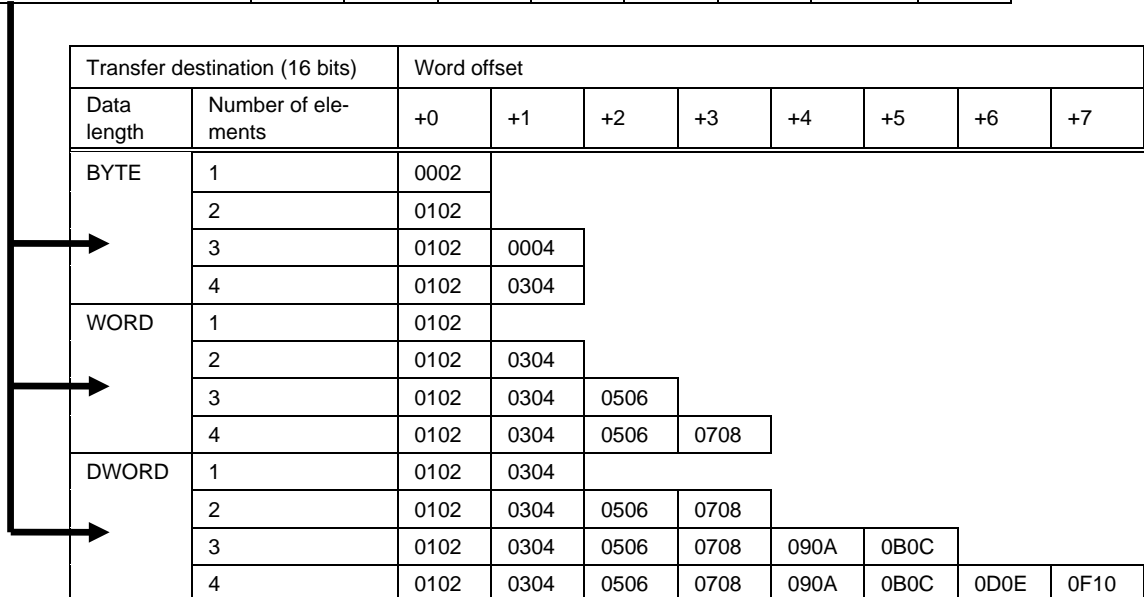

**NS Series Programming Manual**

- Transfer Destination Access Size of 32 Bits (without Endian Conversion)

Offset	+0	+1	+2	+3
Transfer source (32 bits)	01020304	05060708	090A0B0C	0D0E0F10

Transfer destination (16 bits)		Word offset							
Data length	Number of elements	+0	+1	+2	+3	+4	+5	+6	+7
BYTE	1	0004							
	2	0304							
	3	0304	0002						
	4	0304	0102						
WORD	1	0304							
	2	0304	0102						
	3	0304	0102	0708					
	4	0304	0102	0708	0506				
DWORD	1	0304	0102						
	2	0304	0102	0708	0506				
	3	0304	0102	0708	0506	0B0C	090A		
	4	0304	0102	0708	0506	0B0C	090A	0F10	0D0E

**Note**

The data will be converted as shown below if the Convert Endians Check Box is selected.

- Data Length: WORD (16 Bits)  
The endianness will be converted every 8 bits.  
Example: 12 34 → 34 12
- Data Length: DWORD (32 Bits)  
The endianness will be converted every 16 bits.  
Example: 00 01 0B 0A → 0B 0A 00 01

**Timing of Device Data Transfers**

Device data will be transferred when the transfer trigger condition is met and the Transfer in Progress Flag is OFF. The data will therefore not be transferred if the device data transfer trigger for one group occurs when device data is being transferred for another group.

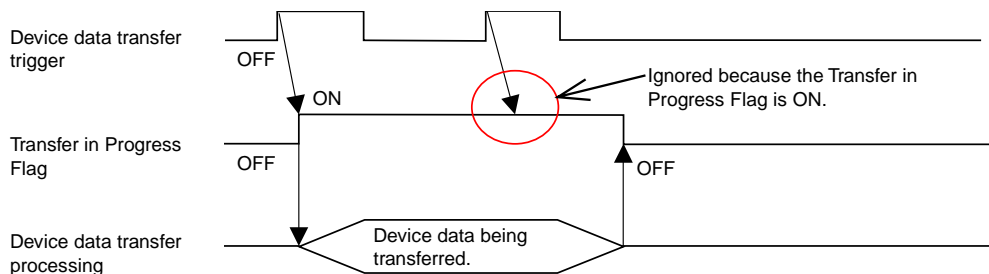

If the rising edge or falling edge is set as the trigger condition, the trigger address will not be automatically turned ON or OFF by the system after the trigger condition occurs. If a cyclic trigger is set, however, the triggers will be sorted with the shortest cycles first and transfers will be executed in order. An example of using cyclic triggers is provided below.

**NS Series Programming Manual**

Transfer group	Trigger condition
1	Cycle time: 2 s
2	Cycle time: 1 s
3	Cycle time: 1 s
4	Cycle time: 3 s
5	ON

Example 1: Short Device Data Transfer Times

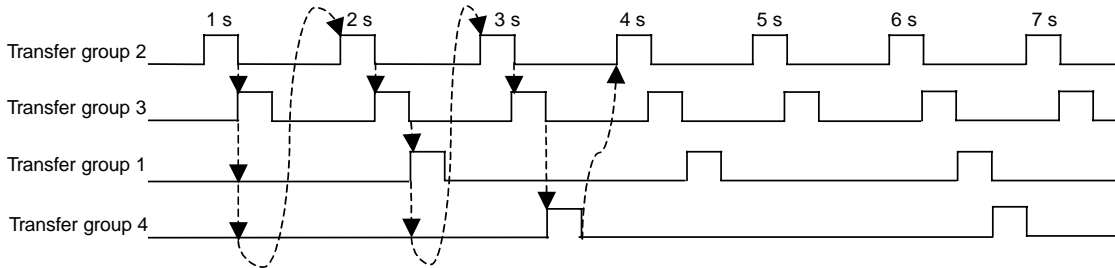

Example 2: Long Data Transfer Times for Transfer Groups 2 and 4

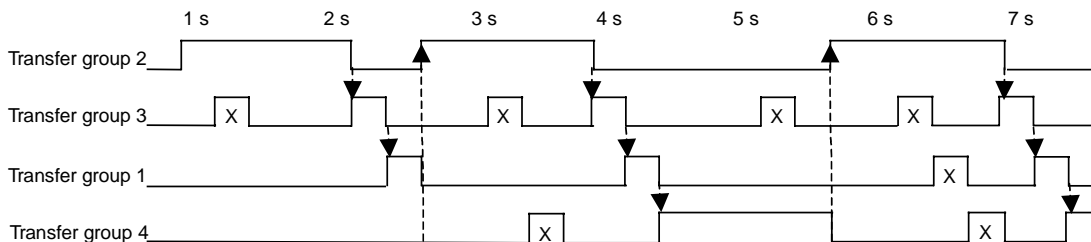

Even if the trigger condition is met, data will not be transferred while another transfer group is being processed. This will create inconsistencies in the transfer cycles.

Example 3: A Trigger Occurs During Operation

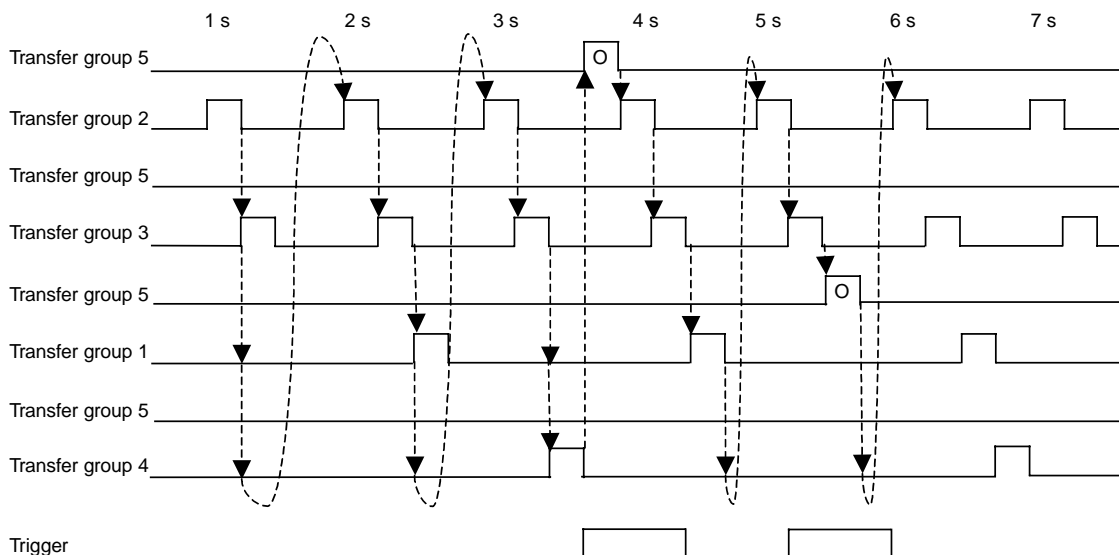

The trigger status is checked each cycle. If a trigger condition is met, cyclic transfer processing will be interrupted to transfer the data.

*NS Series Programming Manual*

**Reference Data**

The times are estimates of the device data transfer times\* when using NT Links via Ethernet.

The processing times are for the following configuration and conditions.

\*The transfer time is the time from when the trigger bit turns ON until the Transfer in Progress Flag turns OFF.

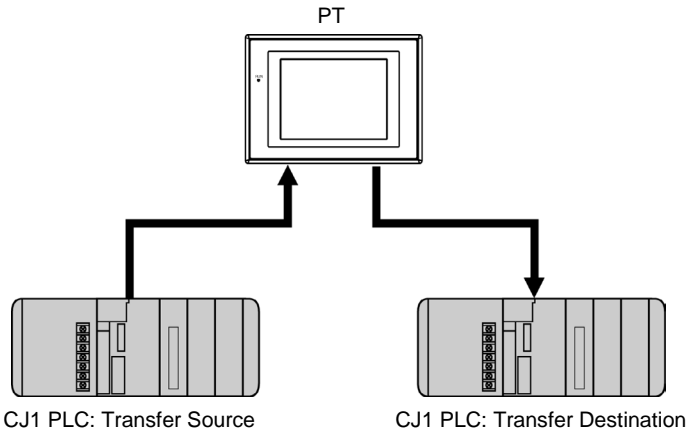

- Device data is transferred from the CJ1 PLC that is the transfer source device to the CJ1 PLC that is the transfer destination device.
- The transfer times are for 10 and 1,024 WORD data elements set for one group and one entry.
- The transfer times are for when no other processing is being performed.

Connection method	10 elements	1,024 elements
1:N High-speed NT Link	723 ms	8,733 ms
Ethernet	733 ms	8,915 ms



## **Section 3      Using PTs**

This section describes how to use PT functions.

3-1	Procedure before Operation .....	3-1
3-2	Controlling Buzzers, Backlights, and Display .....	3-2
3-3	Screen Display and Notification .....	3-5
3-4	Changing Numeral and Character String Display .....	3-10
3-5	Displaying Graphs .....	3-15
3-6	Inputting Numeral and Character Strings .....	3-17
3-7	Using Alarm/Event Summary History Functions .....	3-22
3-8	Using Operation Log Functions .....	3-26
3-9	Displaying and Setting System Clock .....	3-28
3-10	Prohibiting and Allowing PT Operation .....	3-29
3-11	Using Memory Cards .....	3-31
3-12	Function Key Settings (NS15 Only) .....	3-33

### 3-1 Procedure before Operation

Perform the following procedure to start the PT.

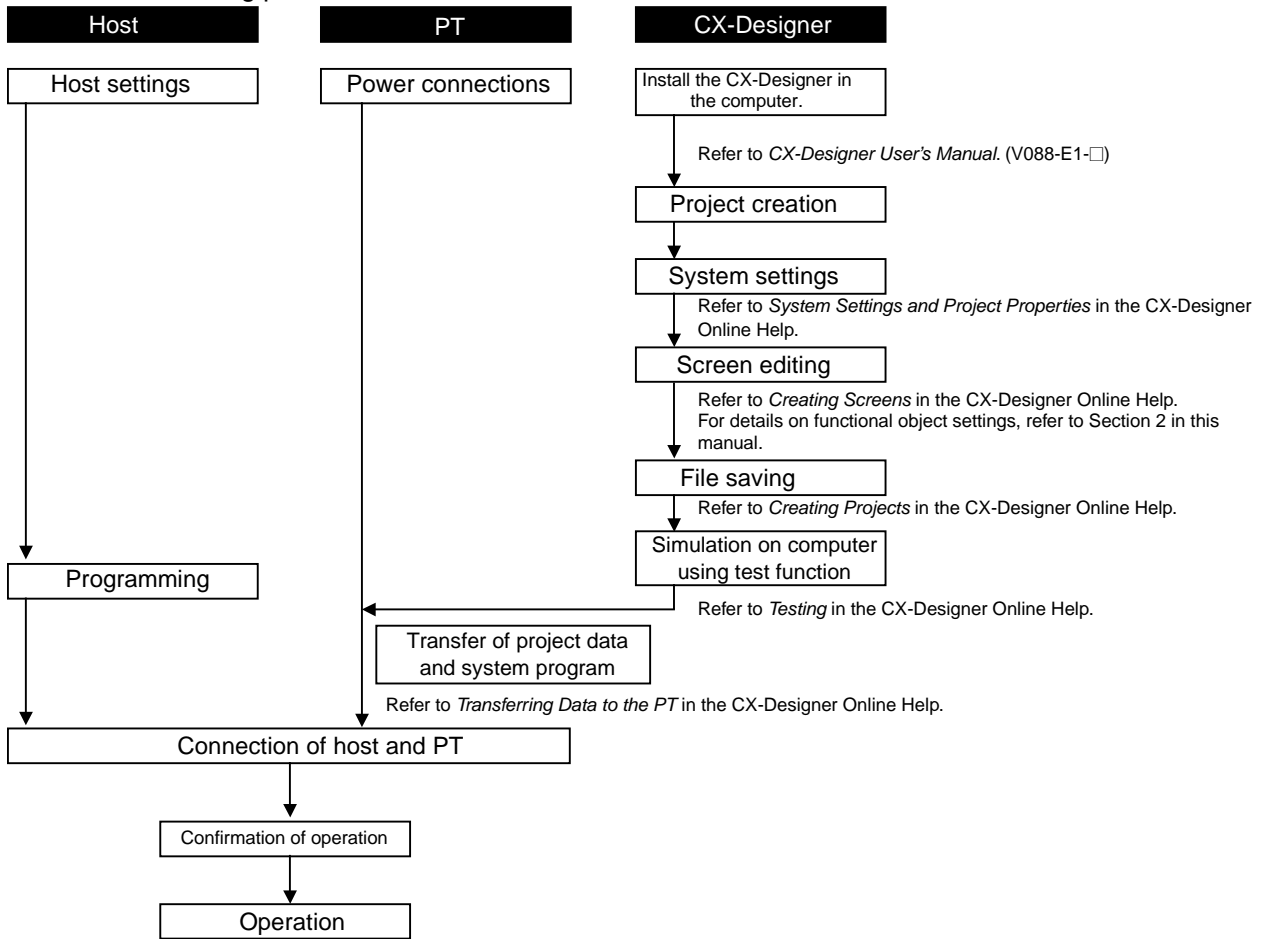

#### Reference

- ◆ Refer to the *CX-Designer Online Help* for information on how to operate the CX-Designer.
- ◆ Refer to the *NS Series -V1/-V2 Setup Manual* (V083-E1-□) for information on how to operate PTs.

## 3-2 Controlling Buzzers, Backlights, and Display

This section describes how to control the status of NS-series PTs, including buzzers, backlights, and screen display.

### 3-2-1 Sounding Buzzers

NS-series PTs have the following 3 types of buzzers.

Continuous:	Continuous buzzer
Short intermittent:	Intermittent buzzer that sounds at 0.5-second intervals.
Long intermittent:	Intermittent buzzer that sounds at 1-second intervals.

Buzzers can be sounded using the following method.

#### Sounding Buzzers Using System Memory

System memory word \$SB provides bits for sounding buzzers.

Set buzzer sound to *ON* under the CX-Designer system settings and select the *Basics* check box in the system memory list.

The system memory is manipulated as shown below when the need arises for a buzzer to sound. The bits listed on the following table will turn ON depending on the type of buzzer to be sounded.

Continuous buzzer:	\$SB12
Short intermittent buzzer:	\$SB13
Long intermittent buzzer:	\$SB14

### 3-2-2 Stopping Buzzers

Buzzers can be stopped using the following methods.

Using system memory.

Pressing a Command Button to which *Stop buzzer* has been set.

#### Stopping Buzzers Using System Memory

Turns OFF all bits in system memory \$SB used to sound buzzers, i.e., turns OFF \$SB12 to \$SB14.

#### Note

- ◆ If multiple bits listed above turn ON at the same time, only one buzzer will sound, depending on the order of priority. The order of buzzer priority is continuous buzzer, short intermittent buzzer, then long intermittent buzzer. When buzzers are turned OFF, not only the bit that corresponds to the buzzer but all of the bits listed above are turned OFF.

#### Stopping Buzzers Using Command Buttons

If Command Buttons are used, the buzzer can be stopped immediately from the PT. Press a Command Button to which *Stop buzzer* has been set under the button property settings.

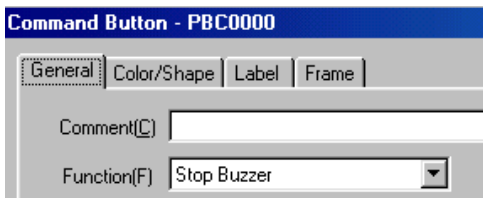

### 3-2-3 Controlling Backlights

NS-series PTs have the following two types of backlight modes.

ON: Backlight remain ON.

Flashing: Backlights alternates between ON and OFF.

Backlights can be controlled using the following method.

#### Controlling Backlights Using System Memory

System memory word \$SB provides bits for controlling the backlight.

The system memory is manipulated as shown below when the need arises to control a backlight.

\$SB10, the backlight mode control bit, operates as shown on the table.

To turn backlight ON: \$SB10 turns from ON to OFF.

To make backlight flash: \$SB10 turns from OFF to ON.

### 3-2-4 Turning OFF Screen Display

If the screen display is set to turn OFF when not required, the life of the backlight can be extended. The backlight also turns OFF automatically while the screen display is turned OFF.

Screen display can be turned OFF using the following method.

#### Turning OFF Screen Display Using Screen Saver

Under *System Menu – PT Settings*, set *Screen Saver* to *Display Erased* and set the time from the last operation until the screen saver will be started (1 to 255) under *Screen Saver Start-up Time*.

Specify a number from 1 to 255 in the Set Value Field to set a constant value for the screen saver start-up time. If an indirect specification is used, the value of the set communications address will be the screen saver start-up time. In that case, set BCD or binary as the storage type.

#### Note

- ◆ If the screen saver start-up time is specified indirectly, store 1 to 255 at the specified communications address.

The screen saver will not start if a value outside this range or a value that cannot be expressed by the specified storage format is stored.

### 3-2-5 Displaying Cleared Screens

If the screen display is turned OFF using the screen saver function, the screen display can be turned ON using the following method.

## Displaying Cleared Screens Using Touch Panels

Cleared screens are re-displayed when touch panels are pressed.

Any position on the screen can be pressed.

### Note

- ◆ Even if a functional object position is touched, the first touch will re-display the screen and the functional object will not react.
- ◆ The screen saver is automatically cleared in the following situations.
  - Base screens switched (automatic screen switch from system memory, macro, or because of alarm or event)
  - Pop-up screens opened, closed, or moved (automatic screen switch from system memory, macro, or because of alarm or event)
  - Error (Error Dialog Box displayed)
- ◆ The value of an indirectly specified address is changed (if the screen saver start-up time is indirectly specified).

## 3-3 Screen Display and Notification

This section describes how to switch screens displayed on NS-series PTs and how to check the screen number for the displayed screen.

### 3-3-1 Switching Screens

Screens can be switched using the following methods.

- Manipulating system memory.
- Pressing a Command Button or Multifunction Object with the *Switch screen* function.
- Using the alarm/event switch screen function.
- Using the macro function SHOWPAGE or SHOWPAGEBCD.

#### Manipulating System Memory to Switch Screens

System memory area \$SW has words for switching screens.

If a screen number is written to \$SW0, the display will switch to that screen.

Screen page numbers 0 to 3,999 are set to \$SW0 in BCD (0 to F9F in binary).

#### Note

- ◆ Pop-up screens set to \$SW0 will be ignored.
- ◆ Non-existent screen numbers set to \$SW0 will be ignored.

#### Manipulating System Memory to Switch Pop-up Screens

Pop-up screens can be switched from the system memory using the following method.

Store the desired pop-up screen page numbers to words \$SW1, \$SW4, and \$SW7.

#### Note

- ◆ Normal screens set to \$SW1, \$SW4, and \$SW7 will be ignored.

**NS Series Programming Manual**

**Using Command Buttons or Multifunction Objects to Switch Screens**

Screens can be switched on the spot from the PT by using Command Buttons. Press a Command Button to which *Switch screen* has been set under the button property setting.

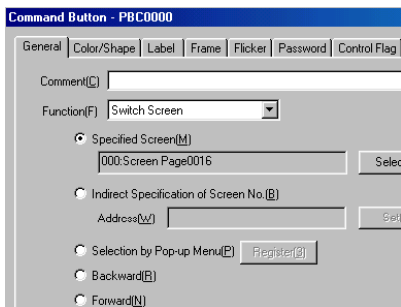

There are seven types of screen switching that can be performed with Command Buttons.

Specified screen	Switches to the screen (fixed) for the set page number.
Indirect Specification of Screen No.	Switches to the screen page number (specified binary or BCD) for the contents of the specified address.
Selection by Pop-up menu	Selects the desired screen from a pop-up menu.
Backward	Switches screens by going back through the last 32 screen switches (screen display history).
Forward	Switches screens by going forward through the last 32 screen switches after using <i>Backward</i> function.
Next Page (Multifunction Objects only)	Displays the screen at the next page number.
Previous Page (Multifunction Objects only)	Displays the screen at the previous page number.

**Note**

- ◆ The display cannot be switched to System Menu using *Switch to specified screen*.
- ◆ The display can be switched to System Memory (Data Initialization Screen) by specifying 4002 (BCD)/FA2 (binary) as the screen number under *Switch to Indirect Specification of screen number*.
- ◆ The display cannot be switched to System Menu using *Backward* or *Forward*.

**Using Command Buttons or Multifunction Objects to Open Pop-up Screens**

Pop-up screens can be displayed by using Command Buttons. The settings are the same as for opening normal screens. Specify a pop-up screen when a screen needs to be specified.

## Using Command Buttons or Multifunction Objects to Close or Move Pop-up Screens

Pop-up screens can be closed or moved by using **Command** Buttons.

Press a **Command** Button to which *control Pop-up screen* has been set under the button property setting.

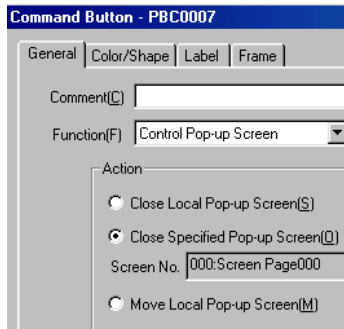

Close local pop-up screen:

Closes the current pop-up screen if the Command Button is inside the pop-up screen.

Close specified pop-up screen:

Closes a specified pop-up screen.

Move local pop-up screen:

Enables the current pop-up screen to be moved if the Command Button is inside the pop-up screen.

## Closing Pop-up Screens when Normal Screens Switched

Pop-up screens can be closed at the same time that the base screen used to open the pop-up screen is switched to another screen.

Select *Closes when base screen switches* on the Size/Pop-up Tab Page found in the pop-up screen property setting under *PT – Screen/Sheet properties*.

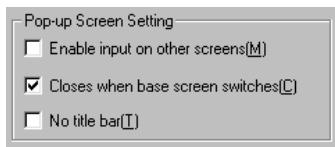



## Using Alarms/events to Switch Screens

Screens can be switched when alarms or events occur or when an alarm or event display object is pressed.

Alarms/events are functions that monitor addresses (bits). When the bit turns ON a corresponding message can be displayed. The display can also be switched to a corresponding screen.

If *Switch Screen when Address ON* is selected when alarms/events are registered, the display will automatically switch to the screen specified under *Switch screen No.* when an alarm or event occurs.

Switch Screen NO. 0 : Screen Page000

Switch Screen when Address ON(A)

Furthermore, if *Switch screen to the specified page set with an alarm/event setting* is selected in the alarm/event display object setting, the display will switch to the specified screen when the alarm/event display object is pressed on the screen during an alarm or event.

Movement when Display Area is Pressed

Switch Screen to the Specified Page Set with an Alarm/Event Setting(U)

Erase Displayed Message(X)

### Reference

- ◆ Alarms/events have a priority order, if multiple alarms occur at the same time, the display will switch to the screen with the highest priority.
- ◆ Level detection and rise trigger detection are available for screen switching using alarms or events. Refer to *Outline in 2-14 Alarms and Events* for details.

## Using Macro SHOWPAGE to Switch Screens

The SHOWPAGE function provided with the macro function is used to switch screens.

Specify the desired screen number in the SHOWPAGE argument.

**Edit Macro**

Execution Condition

Touch ON timing

Program(P)

SHOWPAGE(100);

## Using Macro SHOWPAGE to Open Pop-up Screens

The SHOWPAGE function provided in the macro function is used to switch screens.

The settings are the same as for opening normal screens. Specify a pop-up screen number when a screen needs to be specified.

### 3-3-2 Finding Current Screen Numbers

NS-series PTs have a function to notify the host that screens have been switched by the PT and to notify the host of the new screen number.

The host is informed the timing of the screen switch and the new screen number using the following method.

#### Reading System Memory

Screen switch notification is provided in the following system memory areas.

Screen switch timing	<i>Screen switch strobe</i> at system memory bit \$SB2. Turns ON when screens are switched and turns OFF automatically when the host is notified.
Current screen number	<i>Current screen number</i> at system memory word \$SW0.
Current pop-up screen number	<i>Current pop-up screen 1 number</i> , <i>Current pop-up screen 2 number</i> , and <i>Current pop-up screen 3 number</i> at system memory words \$SW1, \$SW4, and \$SW7. Store the screen numbers for pop-up screens 1, 2, and 3.

1. Screen switch timing  
Check the rising edge of \$SB2 in the host program.  
When bit \$SB2 turns ON, it means that a screen has been switched by PT operation.
2. Current screen number  
The host program reads the *Current Screen Number* from \$SW0 and the *Current pop-up screen 1 number*, *Current pop-up screen 2 number*, and *Current pop-up screen 3 number* from \$SW1, \$SW4, and \$SW7.

## 3-4 Changing Numeral and Character String Display

This section describes how to change the display for numerals and character strings.

Refer to *2-8 Common Functional Object Functions* for information on the functional objects used to display numerals and character strings. These functional objects are numeral display and input objects, string display and input objects, and text.

### 3-4-1 Methods for Changing Numeral and Character String Display

The following methods can be used to change numeral and character string display on NS-series PTs.

- Change the contents of addresses allocated to numeral display and input objects.
- Change the contents of addresses allocated to string display and input objects.
- Indirectly specify text character strings.
- Use Indirect Specification of String Tables for Labels.
- Using the label message display function
- Changing the contents displayed using the contents display function
- Press a Command Button with the Key Button function.
- Switch labels.

#### Changing Address Contents for Numeral Display and Input Objects

The display can be refreshed for numeral display and input objects if a host address is allocated to the object. The display is refreshed simply by changing the contents of that address in the host.

The address referenced by one numeral display and input object can be switched by modifying the index of the address.

Perform the following procedure to modify indexes.

1. Set index  $I_x$  ( $x:0$  to  $9$ ) to the allocated address under the numeral display and input object property setting made using CX-Designer.  
Example: HOST 1: DM0000010
2. During operation, change the contents of the word in system memory ( $\$SW27$  to  $\$SW36$ ) that corresponds to index  $I_x$  ( $x: 0$  to  $9$ ). The contents are set in BCD.  
Example: If 5 (BCD) is set to system memory word  $\$SW27$  which corresponds to  $I_0$ :  
HOST 1: The numeral display and input object to which DM0000010 is set will display the contents of HOST 1: DM00005.

#### Changing Address Contents for String Display and Input

Display can be refreshed for string display and input objects if words on the host at which a character code is stored are allocated as the address. The display is refreshed simply by changing the contents of those words from the host.

The displayed address by one string display and input object can be switched by modifying the index of the address.

The method for modifying indexes is the same as for numeral display and input objects.

#### Note

- ◆ ASCII and Unicode character codes can be used for string display and input objects.

### Indirectly Specifying Text Character Strings

Text objects normally display fixed character strings, but they can also be used to read and display character strings from text files. Text files can be selected from any directory but will be copied automatically when the text file is specified under the Properties Setting Dialog Box to the folder where the screen data files are stored.

1. Select *Indirect Reference of string* when making the text property setting using CX-Designer and set text file where the string to be referenced is stored and specify the address.
2. The string from the specified line (when a text file line number is specified) will be displayed when the contents of the set address are changed during operation.  
Refer to *Text Objects* under 2-13 *Display* for details.

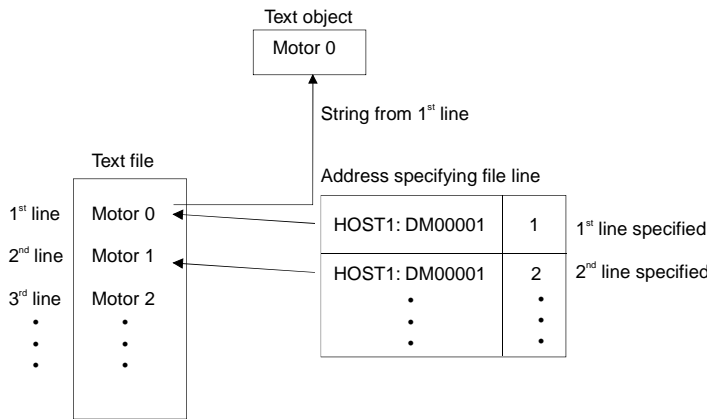

Create a text file in the following format.  
(The text file outlined shown above is used as an example.)

File extension: txt

File name: Up to 8 characters + txt

The following characters can be used in file names.  
Alphanumeric characters, underscore (\_), dollar signs (\$), and periods (.).

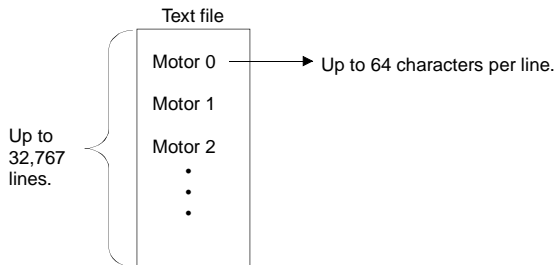

**Note**

- ◆ Character strings cannot be indirectly specified if vector fonts are specified for the text object.
- ◆ Up to 32,767 lines can be set but this may depend on the text editor being used.
- ◆ If the number of characters per line specified in the text file exceed the number of characters that can be displayed by the text object, only the portion of the character string from the beginning of the string to the last character that can be displayed by the text object will be displayed.

Example

Full display	Limited display

**NS Series Programming Manual**

### Using Indirect Specification of String Tables for Labels

Labels can be used to display strings read from a string table.

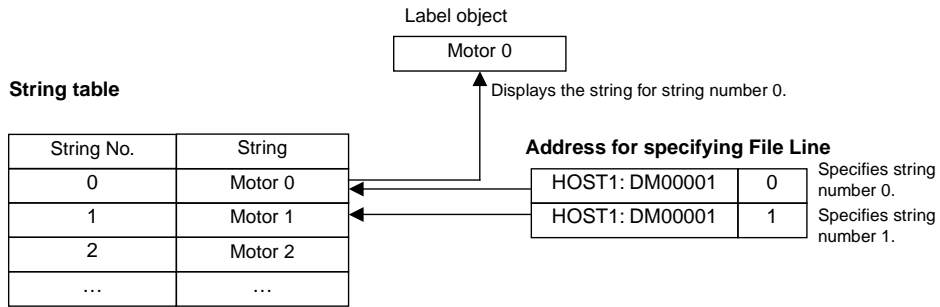

1. Select **PT – String table settings** from the CX-Designer to display the string table. Register the string to be displayed.
2. Select the *Refer to the String Table* checkbox when making the label property settings.
3. Select the *Indirect* checkbox and set the communications address.

Refer to *Labels in 2-8 Common Functional Object Functions* for details.

### Using the Label Message Display Function

This function registers a display string and background color for each status number set for the label. Any set status can be specified for display.

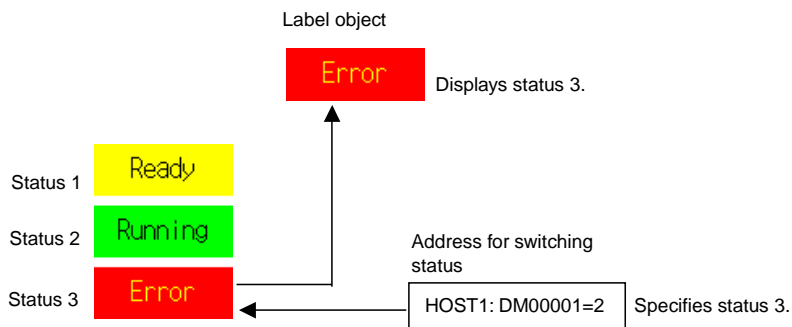

1. Select the *Use as a Message Display* checkbox on the General Tab Page when making the label property settings from the CX-Designer.
2. Set the string to be displayed, the background color, and other settings on the Message Tab Page.

Refer to *Labels in 2-13 Display* for details.

### Changing the Contents Displayed for a Contents Display

The Contents Display Object can display the contents registered for a screen.

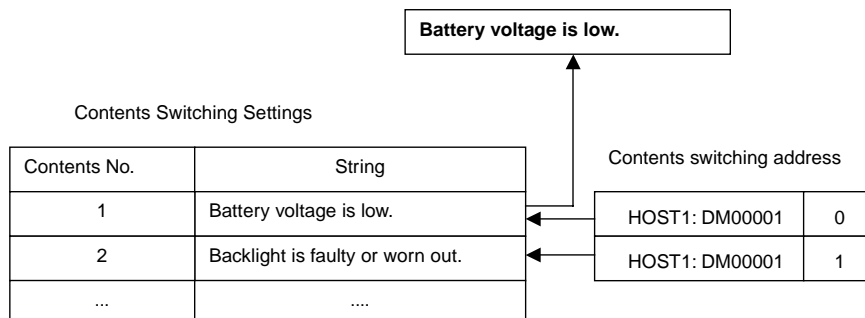

1. The contents display is placed in screens using CX-Designer.
2. Select the *Display a string* checkbox on the General Tab Page when making the contents display property settings.
3. Set the *No. of Contents* and *Address for switching Contents* on the Edit Contents toolbar in CX-Designer.
4. Enter the contents number to be edited in the input field for *Contents No.* on the Edit Contents toolbar.
5. Select **Contents Display**. Press the **Space** Key and enter the string to be displayed.
6. Repeat steps 4 and 5 for the number of contents to be set.

Refer to 2-19 *Machine Navigator Function* for details.

### Using Command Buttons with Key Button Function

1. Select **function - Key button** on the Command Button General Tab Page.
2. Select the destination.

### Indirect Specification of Target Strings

Specify the address where the numeral or string data is stored and the number of transmit words. Select **Transmit type - Indirect specification of string** and specify the address and number of words.

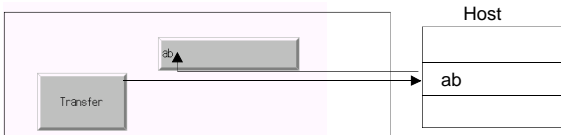

If more characters than are set for the character string display and input object are transferred, only the set number of characters will actually be transferred. For example, if 10 characters are transferred to a character string and display object to which only 3 characters are set, only three characters will actually be transferred.

### Transferring Label Strings Set to Command Buttons

Select **Transmit type - Label string**.

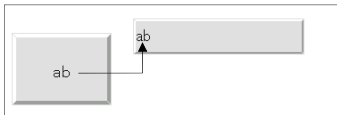

### Transferring Specified Strings

Select **Transmit type - specified string** and set the string to be transferred.

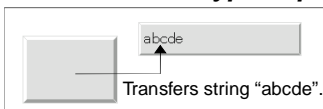

### Changing Label Strings by Switching Labels

Multiple strings can be set to functional object labels using CX-Designer. The functional object label display can then be changed by switching the labels.

1. Set the number of label switches and the name of each corresponding label in the Project Property Window's Switch Label Tab Page. (Select **PT - Project Properties** and click the **Switch Label** Tab.)

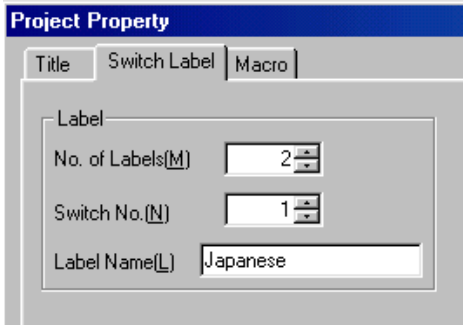

2. Set the label string for each corresponding label in the functional object property setting (Label Tab Page).

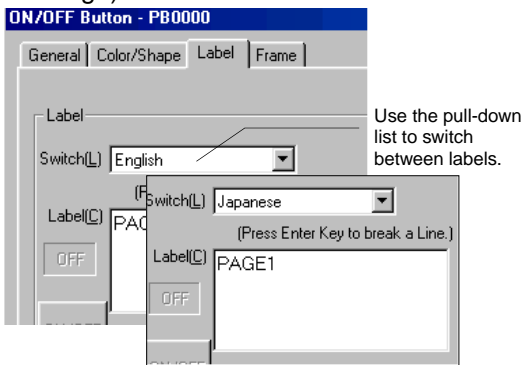

3. Use the following procedure to switch label displays during PT operation.  
\$SW10 stores the current label number. Write a label number directly to \$SW10 to switch to that label.

## 3-5 Displaying Graphs

This section describes how to change displayed graphs. Data log graphs will be used as an example.

### 3-5-1 Changing Graph Displays

Graph display can be changed using the following methods.

- Using icons.
- Using *address for updating display*.

#### Refreshing Display Using Icons

Special icons can be added to graphs.

1. Make the data log settings when creating a screen using CX-Designer and create a data log graph. A special icon will be added to the data log graph.
2. The data log graph display will change during operation based on the functions of the icon pressed.

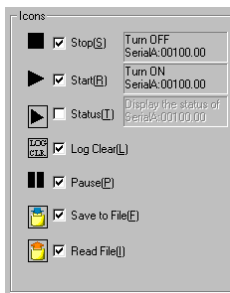

Multifunction Object Data Log Control can execute the same functions as icons.

#### Changing Display Using Addresses for Updating Display

Refreshing of data log graph display can be controlled by the contents of specified addresses.

#### Changing Time Axis Scales

The graph can be displayed using a different specified time scale.

1. Select **Scale for Time Axis - Indirect** under the data log graph property setting and specify the address that will specify the scale. The scale displayed on the graph will change based on the contents of the specified address.

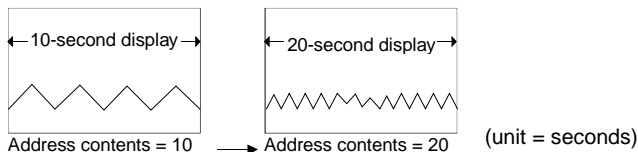

#### Note

- ◆ Nothing will be displayed on the graph if the content of the specified address is 0 or a lower number.



### Refreshing Graph Display at Specified Intervals

Graphs can be scrolled and the display refreshed at any time interval based on a specified time.

1. Select *Set Address for updating display* under the data log graph property setting, and then set an address for specifying refreshing the display under *Scroll Control Flag* and an address where the scroll time is stored under *Address for Specifying Scroll Interval*.

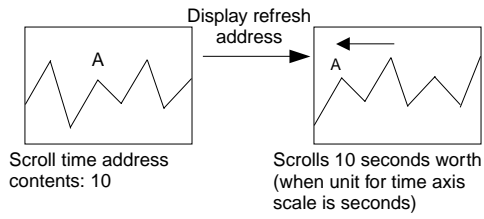

### 3-6 Inputting Numeral and Character Strings

This section describes how to input numerals and character strings.

#### 3-6-1 Inputting Numerals

The following two objects are used to input numerals.

- Numeral display and input objects
- Thumbwheel switches

#### Inputting to Numeral Display and Input Objects

There are two methods for inputting to numeral display and input objects.

- Input from a keypad.
- Input from Command Buttons.

#### Inputting From a Keypad

1. In the numeral display and input property setting on the Keypad Tab Page, set either *system keypad* or *Large system keypad* as the input method.
2. A keypad will be displayed during operation when a numeral display and input object is pressed.

The keypad displayed for input will depend on the display type selected on the General Tab Page.

#### List of Keypads

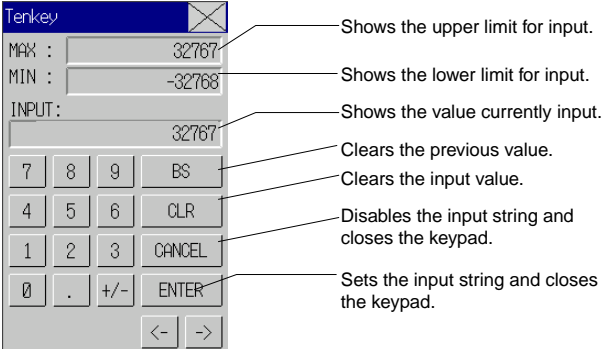
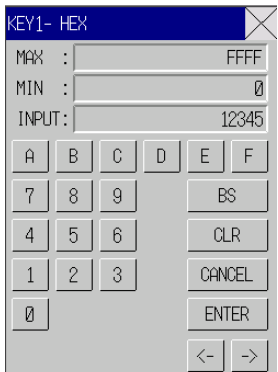
Display type	Keypad Dialog Box
Decimal Octal Binary	
Hexadecimal	

### Inputting from Command Buttons

1. In the numeral display and input property setting on the Keypad Tab Page, set either *Input from pop-up screen* or *Other Input method (e.g., Command Button)* as the input method.
2. Create a Command Button with a key button function on the same screen or pop-up screen.
3. If *Open pop-up screen* has been specified, the specified pop-up screen will be displayed when the numeral display and input object is pressed during operation. Command buttons inside the pop-up screen are used to enter numerals.
4. If *Other method (e.g., Command Button)* is specified, numerals are entered using the command buttons in the same screen.

### Command Button Settings

1. Set *Key button* under the Command Button property setting on the General Tab Page.
2. Set *Transmit to*.
3. Set *Transmit type*. Select *label string* and set 0 to 9 and A to F to the Command Button labels to create a button that inputs 0 to 9 and A to F like a tenkey pad. Select *control code* and specify a control code to create BS and Enter Command Buttons.  
Refer to *Command Buttons in 2-9 Buttons* for details on Command Button settings.

### Inputting Decimal Fractions

*Unit and scale* must be set using the CX-Designer for decimal fraction input. The number of decimal points must also be specified.

Refer to *2-8 Common Functional Object Functions* for details on numeral display and input setting.

### Maximum and Minimum Limits for Input

NS-series PTs can check maximum and minimum limits when setting numeral input, to ensure that illegal values that may affect the system are not input. Errors are prevented because an error message is displayed if a value outside the range is input. The maximum and minimum input limits can be set when numeral display and input objects are created using CX-Designer.

Refer to *2-8 Common Functional Object Functions* for details on numeral display and input settings.

### Moving Focus

In addition to moving the focus to a numeral display and input object by touching the screen, focus can also be moved using Command Buttons.

Set *Key button* for the Command Button to send a control code for moving the focus. Refer to *Command Buttons in 2-9 Buttons* for details on Command Button settings and control codes.

#### Example

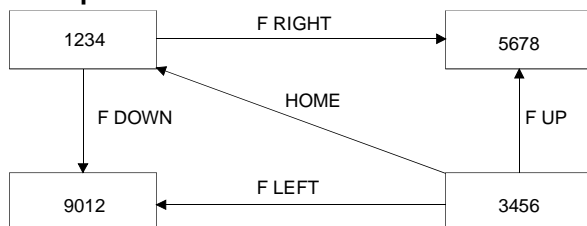

The focus can also be moved automatically to the right or down once the input has been confirmed, if the numeral display and input object is created using the table function.

---

#### Note

Always use set maximum and minimum limits to ensure the safety of numeral display and input objects.

---

## Inputting to Thumbwheel Switches

Thumbwheel switches are used to input numerals by using the + and – Buttons for each digit.



The value for that digit will increase or decrease by 1 each time the + or – Button is pressed. The changed value will be stored to the specified address each time the + or – Buttons are pressed. Unlike numeral display and input objects, there is no button operation required to confirm the input.

### Changing Signs

If thumbwheel switches have signed display, the sign is changed each time the + or – Button of the digit displaying the sign is pressed.

### Inputting Decimals

To input decimals, it is necessary to use CX-Designer to set the unit and scale and the number of decimal digits to be input. Refer to *Unit and Scale* in *2-8 Common Functional Object Functions* for information on setting units and scales.

#### Note

- ◆ Decimals can be input only when the display format is decimal.
- ◆ The scale for a thumbwheel switch must be set to a power of 10, and the offset must be set to 0. If any other values are set, the thumbwheel switch may not operate properly.

### Maximum and Minimum Limits for Input

NS-series PTs can check maximum and minimum limits when numerals are input (each time the + or – Button is pressed), to ensure that illegal values that may affect the system are not input. Errors are prevented because an error message is displayed if a value outside the range is input. The maximum and minimum input limits can be set when thumbwheel switches are created using CX-Designer.

Refer to *Thumbwheel Switches* in *2-12 Display and Input Objects* for details on Thumbwheel Switches setting.

**NS Series Programming Manual**

**3-6-2 Inputting Character Strings**

Character strings are input using string display and input objects.





**Inputting to String Display and Input Objects**

There are two methods for inputting to string display and input objects: Input from a keypad and Input from Command Buttons.

**Inputting From a Keypad**

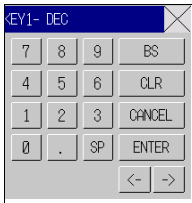
1. In the string display and input property setting on the Keypad Tab Page, set either *system keypad* or *Large system keypad* as the input method.
2. A keypad (virtual keyboard) will be displayed during operation when a string display and input object is pressed.

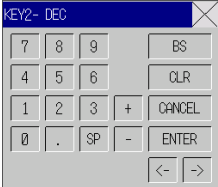
**List of Keyboards**

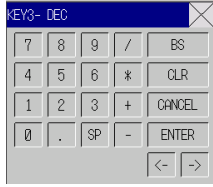
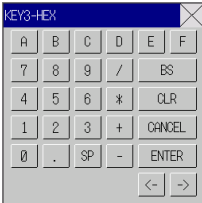
Full keyboard	Decimal key (unsigned)	Hexadecimal key (unsigned)
		
Decimal key (signed)	Hexadecimal key (signed)	Decimal key (signed, with * and /)
		
Hexadecimal key (signed, with * and /)		

### Operating Virtual Keyboard



The operation of virtual keyboards is almost the same as a normal keyboard. Refer to *Inputting Numerals-Inputting From a Keypad* in the previous section for information on operating keyboards other than the full keyboard.

1. Closes the virtual keyboard.
2. Disables the input character string and exits the virtual keyboard.
3. Deletes 1 character from the immediately preceding character string.
4. Deletes the character string stored at the first word.
5. Inserts a space each time this button is pressed.
6. Sets the input character string and exits the virtual keyboard.
7. Changes the input mode to upper case when alphanumeric input mode is selected.
8. Changes the characters that can be selected to !, \$, #, %, and other symbols. This does not affect upper or lower case for alphabet letters.

### Inputting from Command Buttons

1. In the string display and input property settings on the Keyboard Tab Page, set either *Input from pop-up screen* or *Other Input method (e.g., Command Button)* as the input method.
2. Create a Command Button with a key button function on the same screen or pop-up screen.
3. If *Input from pop-up screen* has been specified, the specified pop-up screen will be displayed when the string display and input object is pressed during operation. Command buttons inside the pop-up screen are used to enter character strings.
4. If *Other Input method (e.g., Command Button)* is specified, strings are entered using the command buttons in the same screen.

### Command Button Settings

1. Set *Key button* under the Command Button property settings on the General Tab Page.
2. Set *Transmit To*.
3. Set *Transmit type*. Select *control code* and specify a control code to create BS and Enter Command Buttons.  
Refer to *Command Buttons in 2-9 Buttons* for details on Command Button settings.

### Moving Focus

In addition to moving the focus to a string display and input object by touching the screen, focus can also be moved using Command Buttons.

Set a *Key button* for the Command Button to send a control code for moving the focus. Refer to *Command Buttons in 2-9 Buttons* for details on Command Button setting and control codes.

The focus can also be moved automatically to the right or down if the string display and input object is created using the table function.

### 3-7 Using Alarm/Event Summary History Functions

This section describes how to use alarm/event summary/history functional objects.

Alarms/events monitor host bits and display messages for the user when the bits turn ON.

Alarms/events can be used to record errors, operation start, and other events.

The main features of the alarm/event summary function (current alarm display) are to receive notification of alarms/events and display messages set to the alarms/events and a list of when the alarm/event occurred and when it was cleared. The alarm/event history function (alarm history display) displays messages set to past or current alarms/events and a list of when the alarms/events occurred and when they were cleared.

Alarm/event summary histories can be checked under the PT System Menu (histories only) and summaries and histories can be checked during an operation if an alarm/event summary/history functional object is placed on the screen.

Alarm/event histories recorded on PTs can be saved to a CSV-format file and saved on Memory Cards by turning ON system memory bit \$SB33.

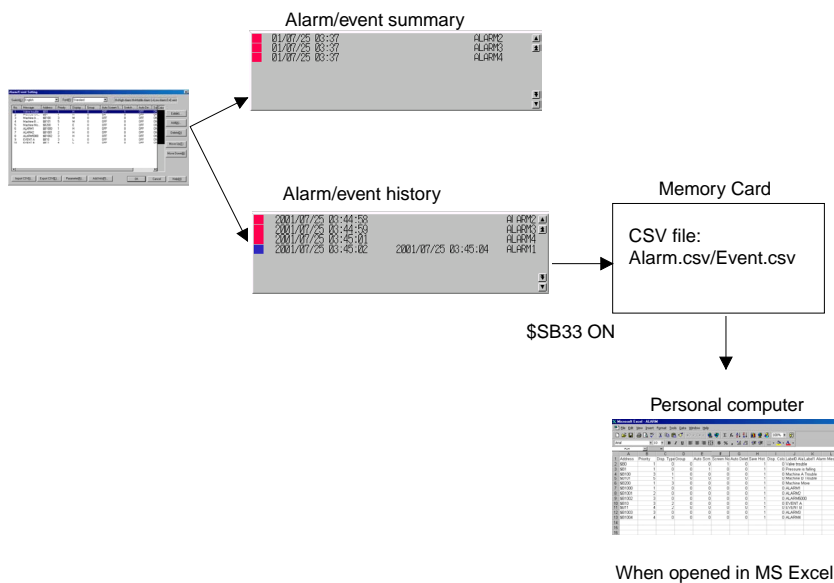

**NS Series Programming Manual**

**Alarms/Event Registration**

Monitored alarms/events can be registered using the following dialog box.

Refer to *Outline in 2-14 Alarms and Events* for details on each setting item.

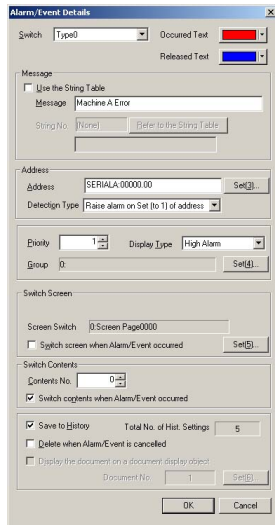

**Checking Without Stopping PT Operation**

The status of monitored bits (alarm current/cancelled) and records of status changes can be checked during PT operation.

1. Create a screen using CX-Designer and create an alarm/event summary & history object on the screen. Set whether the current alarm/event summary or history will be displayed. Select *Display data/Currently Occurred Alarms* to display the summary and select *Display data/Alarm history* to display the history. Refer to *Alarm/Event Summary and History in 2-14 Alarms and Events* for information on other settings.
2. Open the screen with the alarm/event summary & history object during operation. The alarm/event summary and history object displays the data recorded at that point. If the monitored host bit is turned ON, the message set to that bit will be displayed. Depending on the settings, the date and time the alarm/event occurred and was cancelled, the group number, display type, priority order, confirmation date and time, and number of occurrences will be displayed.

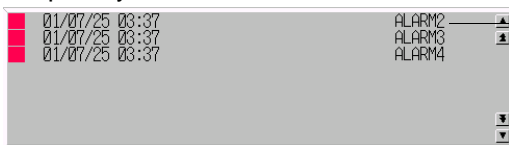

Example alarm/event summary

The previous display is cleared if the same alarm occurs.

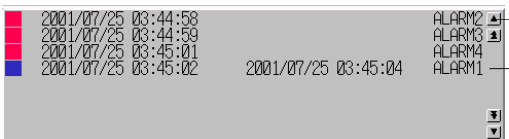

Example alarm/event history

Past alarms are also recorded.

For alarm/event summaries, if an alarm or event that is currently displayed occurs again, the record for the last occurrence will be cleared and only the latest information displayed. For alarm/event histories, however, previous records are not cleared from the list. The latest information is simply added to the list.

3. When a current alarm or event object is pressed, the alarm/event ID number can be written to the address specified at registration and switched to the registered screen.
4. To initialize alarm/event history data, either turn ON system memory bit \$SB32 or select *Initialize alarm/event history* on the Initialize Tab Page under the System Menu.



### Scroll Buttons and Icons











Alarm/event summary and history objects have scroll buttons and icons allocated to them. Use the scroll buttons and icons to scroll through lists and change the display order.

#### Scroll Buttons

Scrolls up and down one line or a specified number of lines.

#### Icons

The following 11 icons are available.

Icon	Description
	Displays from latest alarm/event.
	Displays from oldest alarm/event.
	Displays from highest priority alarm/event.
	Displays from lowest priority alarm/event.
	Displays from most frequent alarm/event.
	Displays from least frequent alarm/event.
	Deletes selected alarms.
	Checks selected alarms.
	Checks all alarms.
	Cancel all alarm's check.
	Changes display type (high alarm, middle alarm, low alarm, event).

### Reference

- ◆ The user can select whether or not to use scroll buttons and icons. Refer to *Alarm/Event Summary and History* in *2-14 Alarms and Events* for information on settings.
- ◆ Multifunction Object *Scroll Object* and *Alarm/Event Control* functions can execute similar functions to icons.

## Checking from System Menu

Recorded alarm history data can be checked from the System Menu.

1. Register an alarm/event. The procedure is the same as *Checking without Stopping PT Operation*, described in the previous section. (The settings are shared by all projects.)
2. Display the Alarm History Screen from the Special Screen Tab Page under System Menu. The recorded alarm history data will be displayed.

Alarm History (Sort by Occurrence)

	Time of Occurrence	Time of Cancellation	Message
■	2001/04/03 18:13:12		Alarm 1 Occurred
✕	2001/04/03 18:13:00	2001/04/03 18:16:38	Alarm 2 Occurred
■	2001/04/03 18:12:57		Alarm 3 Occurred
■	2001/04/03 18:12:53	2001/04/03 18:13:03	Alarm 4 Occurred
■	2001/04/03 18:12:51		Alarm 5 Occurred

■ Occurring Unchecked   
 ■ Occurring Checked   
 ■ Cancelled Unchecked   
 ■ Cancelled Checked

Back

3. Alarm histories can be displayed in order of occurrence and order of frequency.
4. The method for initializing alarm/event history data is the same as outlined under *Checking Without Stopping PT Operation*.

### 3-8 Using Operation Log Functions

This section describes how to use operation log functions.

Operation logs record the following operation histories.

- Functional object operation history
- Screen display history
- Macro execution history
- Communications Address (Bit) Value Change History

Recorded data can be stored as a CSV file and saved to a Memory Card by turning ON system memory bit \$SB38.

The various operation logs operate while the system memory bits outlined in the following table are turned ON.

Functional object operation history and communications address value change history	\$SB39
Screen display histories	\$SB40
Macro execution histories	\$SB41

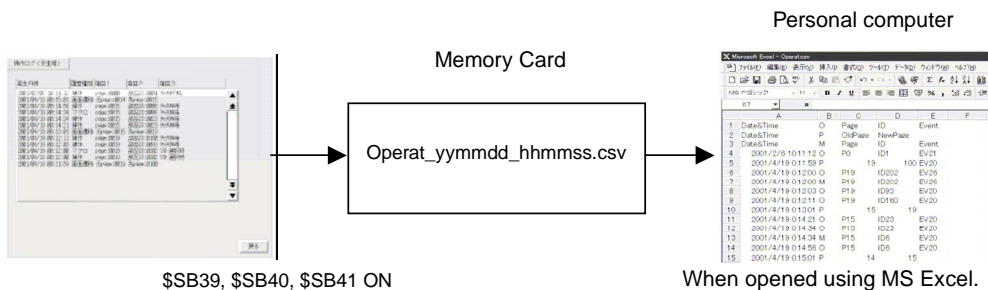

**Note**

- ◆ Refer to 2-20-1 Operation Log for information on the operation log.
- ◆ Operation log data can be saved by performing any of the following actions.
  - Execute a Multifunction Object set to save the operation log.
  - Click the **Save** Button for operation log on the Data Initialization Tab Page of the System Menu.
  - Click the Save Log Button in the Operation Log (Sort by Occurrence) Screen or Operation Log (Sort by Frequency) Screen.

### 3-8-1 Settings for Operation Logs

To record operation histories for functional objects, *Record to Operation Log* must be selected beforehand on the Write Tab Page (extension tab page) for each functional object when screens are created using CX-Designer.

This enables records to be kept for the functional objects.

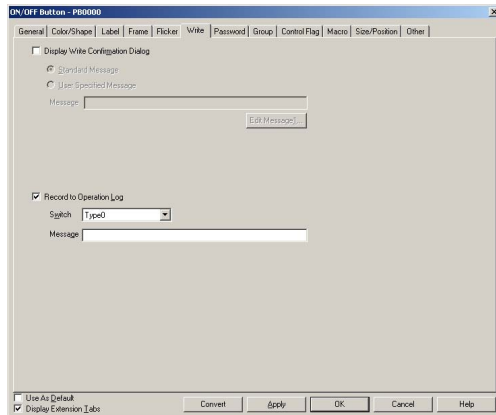

### 3-8-2 Checking Operation Logs

1. Display the Operation Log Screen from the Special Screen Tab Page under System Menu. The recorded operation log data will be displayed.

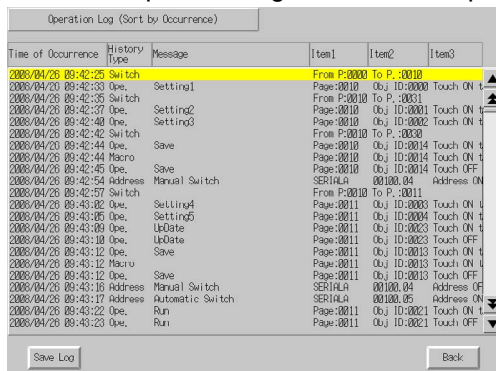

2. Operation logs can be displayed in order of occurrence and order of frequency.
3. Execute initialization of operation log data from the Initialize Tab Page under System Menu. Execute a Multifunction Object for which initializing the Operation Log is set.

## 3-9 Displaying and Setting System Clock

NS-series PTs have a functional object used to set and display the date and time.

### 3-9-1 Displaying Date and Time

Date and time objects display the system clock. The date and time can be displayed simply by creating these objects on the screen.

#### Method

1. Create both date and time functional objects when creating screens using CX-Designer. Select any display format in the property settings for each. Refer to *Date and Time Format* in *2-8 Common Functional Object Functions* for information.
2. The system clock will be displayed during PT operation.

### 3-9-2 Setting Date and Time

The date and time functions do not only display the system clock. They can also be used to change the date and time displayed during operation.

#### Changing Dates and Times

1. Press the date object during operation to display an input dialog box. Enter the desired date. The input format is yyyy.mm.dd. Enter four digits for the year.

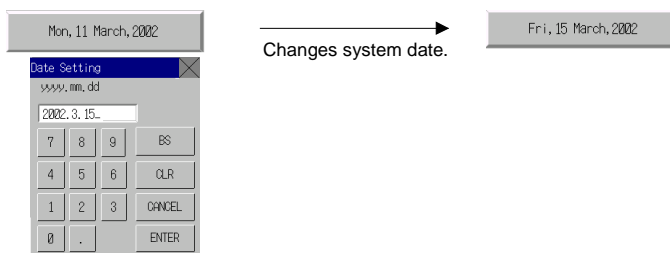

2. Press the time object during operation to display an input dialog box. Enter the desired time. The input format is hh.mm.ss. Enter the hour in 24-hour format. Refer to *2-18-2 Time Objects* for details on 24-hour format

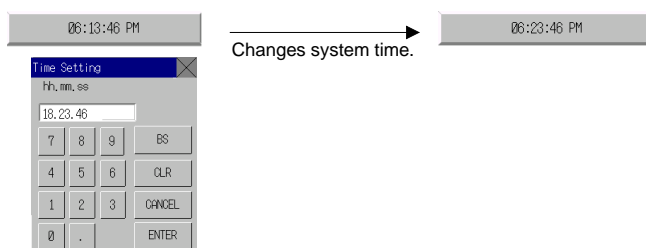

## 3-10 Prohibiting and Allowing PT Operation

Instructions from the host can be used to prohibit and permit NS-series PT operation for the following functions.

- System Menu movement (system memory operation)
- All screen functional object input (system memory operation)
- Input for each functional object (control flag operation)

### 3-10-1 Prohibiting and Allowing System Menu Movement

System Menu movement can be prohibited or allowed for NS-series PTs using the following method.

- Prohibit/allow System Menu movement by manipulating system memory bit \$SB3.

#### Controlling System Menu Movement Using System Memory

Change the status of system memory bit \$SB3 to prohibit or allow System Menu movement.

Prohibit System Menu movement: OFF → ON (0 → 1)

Allow System Menu movement: ON → OFF (1 → 0)

### 3-10-2 Prohibiting and Allowing Input to All Screen Functional Objects

Input to the whole screen can be prohibited or allowed for NS-series PTs by changing the status of system memory bit \$SB19 or the specified communications address.

#### Controlling All Screen Functional Object Input Using System Memory

1. Change the status of system memory bit \$SB19 to prohibit or allow input to all screen functional objects.

Prohibit input to screen: OFF → ON (0 → 1)

Allow input to screen: ON → OFF (1 → 0)

2. If the screen is touched while input is prohibited, a password dialog box will be displayed. Input the correct password to enable input to the screen functional objects. \$SB19 will automatically turn OFF. The password level is specified by system memory bit \$SW13.  
For example, if the content of \$SW13 is "3", a level 3 password must be input.

### Procedure for Prohibiting and Allowing Input to All Screen Functional Objects by Manipulating Specified Communications Addresses

1. In the CX-Designer, select **PT – System Settings**, select the *Touch Switch Lock Control Flag* in the **PT** Tab Page in the System Settings Dialog Box, and then set the desired communications address.
2. Specify *Prohibit Touch when ON* or *Prohibit Touch when OFF* as the prohibit condition.
3. The following table shows the Touch Switch Lock Control Flag during operation.

Prohibit/allow input	Condition	Communications address
Prohibit input	Prohibit touch when ON	OFF to ON (0 to 1)
	Prohibit touch when OFF	ON to OFF (1 to 0)
Allow input	Prohibit touch when ON	ON to OFF (1 to 0)
	Prohibit touch when OFF	OFF to ON (0 to 1)

#### Note

- ◆ Unlike with \$SB19 in the system memory, a dialog box for the password to cancel the input prohibit will not be displayed even if the screen is touched with input prohibited.
- ◆ The Touch Switch Lock Control Flag has priority if both \$SB19 in the system memory and the Touch Switch Lock Control Flag are used as input prohibit conditions.
- ◆ Entering the System Menu by pressing two corners of the screen (or by pressing any corner twice for the NS15) is prohibited when input is prohibited using the Touch Switch Lock Control Flag.

### 3-10-3 Prohibiting and Allowing Input for Individual Functional Objects

Input to functional objects is controlled by control flags for functional objects on NS-series PTs that accept input.

#### Method

1. When creating a screen using CX-Designer, select **Control flag - Input - Indirect** in the property settings for each functional object and set the control flag address.
2. Input can be prohibited and allowed by changing the status of the specified control flag address.
  - Prohibiting input: Change set address status from ON to OFF (1 → 0).
  - Allowing input: Change set address status from OFF to ON (0 → 1).

#### Note

- ◆ If *disable* is set using the control flag, no input from the PT to that functional object is possible during operation.
- ◆ Control flags also have a function for displaying or not displaying functional objects.

## 3-11 Using Memory Cards

This section describes how to use Memory Cards.

Memory Cards are used for the following operations.

- Transferring data.
- Saving history files.
- Saving data blocks
- Saving captured images

Data transfer enables screen data and system programs to be downloaded from a Memory Card to the PT and uploaded from the PT to the Memory Card.

When history files are saved, alarm/event history, data log, operation log, and error log data is saved in CSV file format. CSV files can be edited on personal computers.

Files can be saved from functional objects or by manipulating system memory.

Refer to *3-6 Using Memory Cards* in the *NS Series Setup Manual* for information on mounting Memory Cards.

### Note

- ◆ Use a Memory Card recommended by OMRON. Operation will may not be performed correctly if other Memory Cards are used.

### 3-11-1 Transferring Data Using Memory Cards

Data can be downloaded or uploaded, either automatically or manually, when the PT is started.

1. Use the DIP switches on the back of the PT to make the automatic/manual and download/upload settings.
2. Start the PT.
3. The download/upload operation will start.

Refer to *3-6 Using Memory Cards* in the *NS Series Setup Manual* for information on DIP switch settings and transferring data using Memory Cards.

Data can also be manually downloaded or uploaded using **System Menu – Special Screen – Memory Card transfer**. Refer to *6-8-9 Memory Card Transfers* in the *Setup Manual* for details.

### 3-11-2 Saving Alarm/Event Histories to Memory Cards

Alarm/event history files can be saved by turning ON system memory bit \$SB33 or by saving the data from the Initialize Tab Page on the System Menu.

The file name will be Alarm.csv for alarm histories and Event.csv for event histories.

### 3-11-3 Saving Data Logs to Memory Cards

Data log graph object data can be saved to a file by manipulating system memory.

1. Use the *Write to File* icon or save the group number to \$SW37 and turn ON \$SB36 to save data log graph files. The file name will be Trd@@.csv, and up to 999 files can be saved for each group. The output file name can be changed. If the output file names are 6 characters or longer, only up to 99 files can be saved in a folder.



**NS Series Programming Manual**

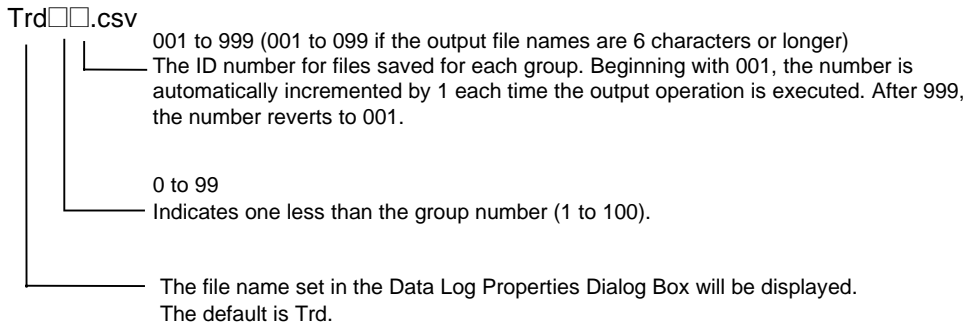

- Files can also be saved by storing “0” in \$SW37 and turning ON system memory bit \$SB36. The file name will be Trend@.csv, and the logs are saved for all registered groups.

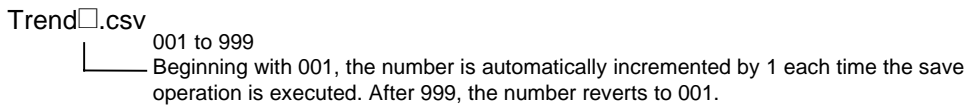

- The data log can be saved from the Initialize Tab Page on the System Menu. File names are the same as when using the system memory bit (\$SB36).

### 3-11-4 Saving Operation Logs to Memory Cards

Operation log data can be saved to an CSV file by using any of the following methods.

- Turn ON system memory bit \$SB38 from the host.
- Execute a Multifunction Object for which saving the operation log is set.
- Save the operation log from the Data Initialization Tab Page of the System Menu.
- Click the Save Log Button in the Operation Log (Sort by Occurrence) Screen or Operation Log (Sort by Frequency) Screen.

The name of the CSV file is Operat\_yymmdd\_hhmmss.CSV

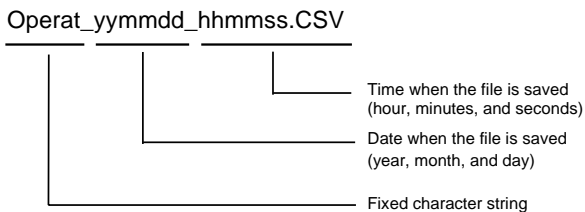

### 3-11-5 Saving Error Logs to Memory Cards

Error log files can be saved by turning ON system memory bit \$SB43 or by saving the data from the Initialize Tab Page on the System Menu. The file name will be MacroErr.csv.

Refer to 2-4 System Memory for details on system memory.

### 3-11-6 Saving Data Blocks to Memory Cards

A file can be saved in CSV format by pressing icons on the data block object.

When pressing the icon to save the file, the folder *DBLK* will be automatically created in the Memory Card, and the file will be saved in the folder.

### 3-11-7 Saving Captured Images to Memory Cards

Using the *Video Control – Video Capture* function, a captured image can be saved in bitmap (BMP) format. The file name can be specified in the property setting dialog box for the command button. When

**NS Series Programming Manual**

saving the file, a number from 001 to 999 will automatically be added in order to the end of the file name. Refer to 2-9-3 *Command Buttons* for details.

**Reference**

- ◆ When a video image is captured, a file with same name as the captured image file and an extension of .mng will be created in the /LOG/Capture folder in the Memory Card directory. These files are used to manage numbers for file names. Do not edit or delete these files.

### 3-12 Function Key Settings (NS15 Only)

Key status addresses can be set for NS15 function keys F1, F2, and F3.

A key status address can be set as a project common setting (system setting). Settings can be made separately for each screen or sheet. Function keys cannot, however, be used in a pop-up window.

**Note**

- ◆ A key status address displayed on the PT screen can be set as only one of the following: project common setting, a sheet setting, or a screen setting. Application is determined by the following order of priority.

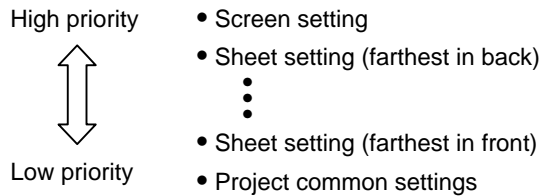

#### Key Status Address Setting Properties

Select **System Setting** from the PT Menu to display the System Setting Dialog Box. Then select the Function Key Tab to display the Key Status Address Setting Dialog Box.

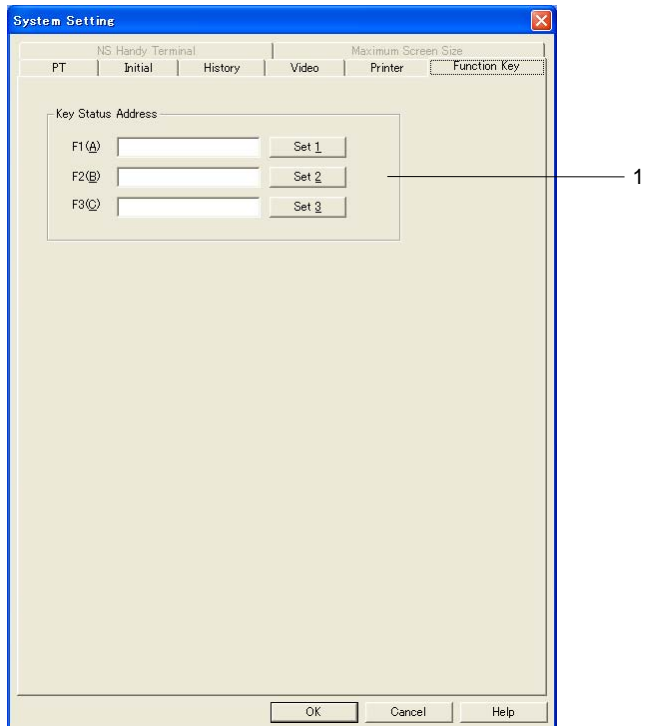

**NS Series Programming Manual**

No.	Item	Description
1	Key Status Address	Sets key status addresses for function keys F1 to F3.

The **Function Key** Tab can also be selected from the screen or sheet properties.

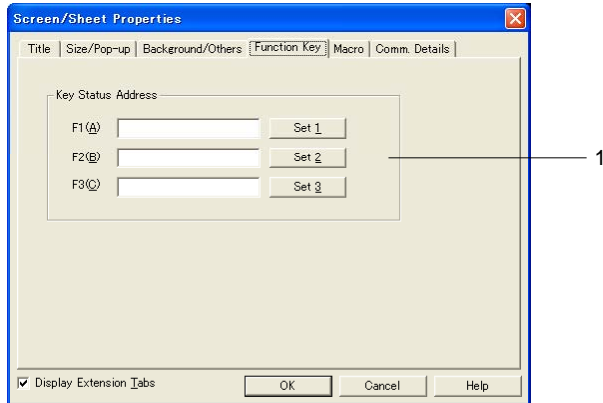

No.	Item	Description
1	Key Status Address	Sets key status addresses for function keys F1 to F3.

Note: The Function Key Tab will not be displayed for PTs other than the NS15, or when making the settings in a pop-up window.



## **Section 4      Using Functions**

This section describes some simple applications that may serve as reference for using PT functions.

Use this section as a reference when using the PT.

4-1 Application .....4-1

## 4-1 Application

This section gives examples of applications for PT functions.

Only the minimum settings required will be displayed. Make any other settings as required.

Refer to the *CX-Designer Online Help* for information on how to create screens using the CX-Designer.

Refer to *NS-series Macro Reference* in the CX-Designer for information on macro functions.

### 4-1-1 When Monitoring Bits Turn ON

#### Displaying Alarms When Bits Turn ON

Example 1: To display Temperature error in red on the screen when the monitored PLC bit turns ON, regardless of what screen is displayed.

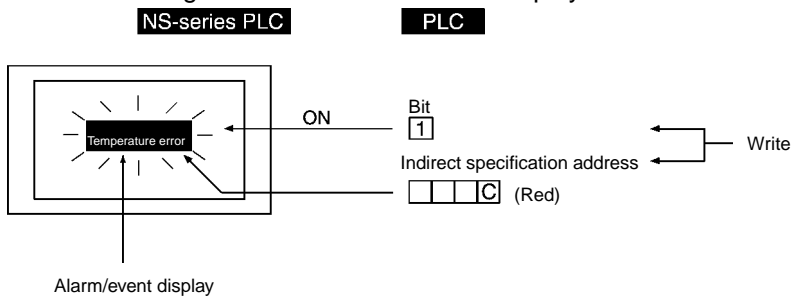

1. Allocate the bit to be monitored in the alarm/event settings and set the message as *Temperature error*. The red color code (12) must be set in the address set for indirect reference the background color using the PLC or macro function (=; substitution) when an alarm/event occurs.
2. Create a sheet and set alarm/event display as shown in the following table.
 

Frame:	None
Background:	Indirect reference (change background color at alarm)
Character color:	Black
3. Apply the sheet created in the previous step to all screens displayed on the PT.

#### Suggestions

- Set the sheet created in step 2 to be displayed on all displayed screens, so that the message *Temperature error* is displayed.
- Frames can also be used to achieve the same message display. Make the settings so that the frame page is switched when an alarm/event occurs and the text *Temperature error* is displayed.
- A combination of ON/OFF Buttons to switch colors and the label switching function can be used to achieve the same display.

**NS Series Programming Manual**

Example 2: To change the whole screen to red and display a screen with the message *Temperature error* in black when the monitored PLC bit turns ON.

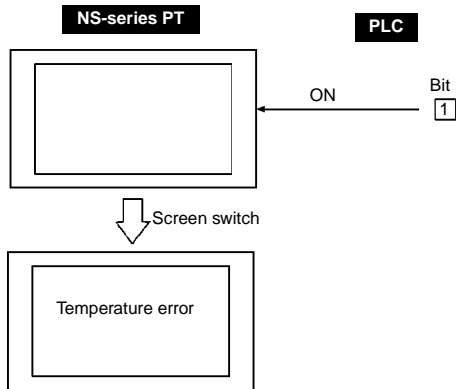

1. Make the following property settings for creating the screen to be displayed when the monitored bit turns ON.

Background color: Red

2. Create the following text for the above screen.

Label	Temperature error
Character color	Black
Background color	No tile
Frame	Frame and border set to OFF.

3. Make the following alarm/event settings.

Address	Number of the PLC bit to be monitored
Auto screen switch	ON (Select <i>Switch Screen when Address ON.</i> )
Screen No.	Screen number for the screen used in steps 1 and 2 above.

**Suggestions**

When this method is used, the error screen will remain even if the monitored PLC bit turns from ON to OFF after the display has switched to that error screen. Once the device error has been checked, a Command Button for switching screens must be created or the system memory bits for switching screens must be manipulated to switch back to the original screen.

Example 3: To display a screen with error details when the alarm message *Temperature error* is touched.

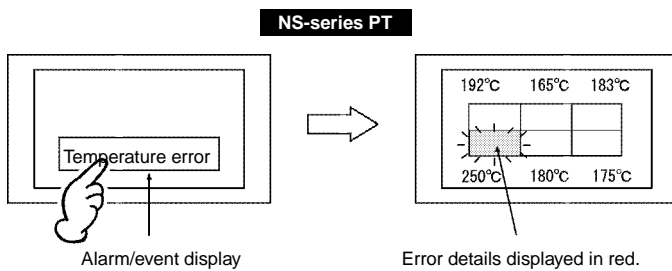

1. Make the following alarm/event settings.

Address	Number of the PLC bit to be monitored
Auto screen switch	OFF (Do not select.)
Screen No.	Number for the screen to display error details (Refer to step 3, below.)

**NS Series Programming Manual**

- Set alarm/event display on the screen as shown in the following table.

Background color	Red
Movement when Alarm/Event is selected	Select <i>Switch Screen to the specified Page Set with an Alarm/Event Setting.</i>

- Register objects to the error details screen, as shown in the following diagram.

Numerical display and input object that displays each temperature.

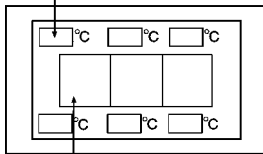

Bit lamp for each object

### Suggestions

A ladder program must be written to turn ON the bit lamp for indicating the error position for each temperature at the same time that the temperature error bit turns ON.

Example 4: To display a screen that provides a history of past alarms including the time of the error, when the *Temperature error* alarm message is touched.

PT

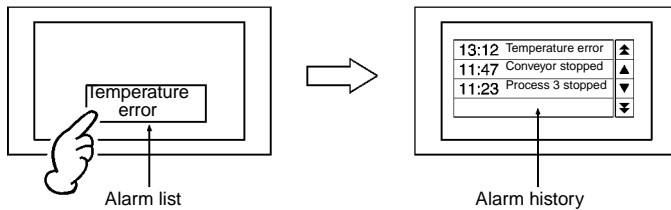

- Make the following alarm/event settings.

Message	Temperature error
Address	Number of the PLC bit to be monitored
Auto screen switch	OFF (Do not select.)
Screen No.	Number for the screen to display error details (Refer to step 3, below.)

- Set the alarm/event display on the screen as shown in the following table.

Background color	Red
Movement when Alarm/Event is selected	Select <i>Switch Screen to the Specified Page Set with an Alarm/Event Setting.</i>

- Create an alarm/event summary/history object with the settings shown in the following table on the destination alarm history display screen.

Display data	Alarm history
Default display order	From New Date & Time.



Example 5: To display the possible countermeasures for the error when the alarm message *Temperature error* is touched.

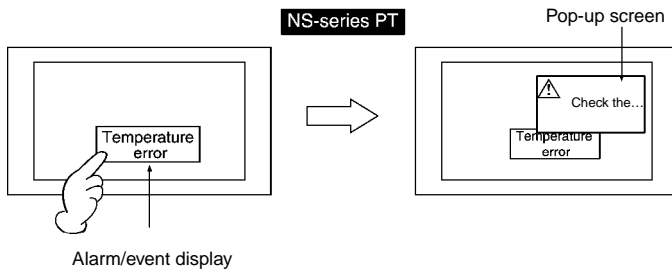

1. Make the following alarm/event settings.

Address	Number of the PLC bit to be monitored
Auto screen switch	OFF (Do not select.)
Screen No.	Number for the screen that displays countermeasures for the error.

2. Set the alarm/event display on the screen as shown in the following table.

Movement when Alarm/Event is selected	Select <i>Switch Screen to the Specified Page Set with an Alarm/Event Setting</i> .
---------------------------------------	-------------------------------------------------------------------------------------

3. Create text that describes the countermeasure (e.g., *Check the ...*) on the countermeasures screen. (Select *Use as pop-up screen* in the screen properties.)

### Displaying Messages on Pop-up Screen

Example: To open and display an error message on a pop-up screen when the monitored PLC bit turns ON.

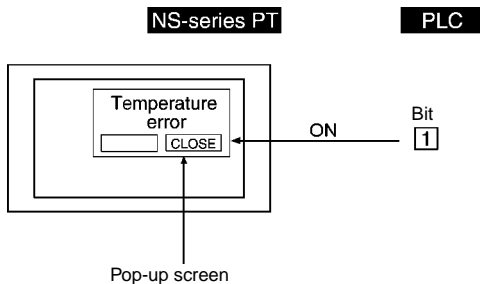

1. Make the following alarm/event settings.

Address	Number of the PLC bit to be monitored
Display type	High alarm
Auto screen switch	ON (Select.)
Screen No.	Number for the pop-up screen to be displayed (Refer to step 2.)

2. Create alarm/event display on the pop-up screen.

Background color	Red
------------------	-----

3. Create 2 Command Buttons with the following settings on the pop-up screen.

Close Button	
Function selection – control Pop-up screen	Close local pop-up screen
Label	CLOSE
Move Button	
Function selection – control Pop-up screen	Move local pop-up screen
Label	Move

### Suggestions

- Up to three pop-up screens can be created.
- When multiple pop-up screens are to be opened at the same time, the display positions for the screens can be specified so that they do not overlap.
- The pop-up screen display position can be moved by pressing the Move Button. Move the screens if there is overlap with the base screen that prevents the screens being viewed properly.
- The displayed message can be switched to match the alarm by placing a Contents Display Object in the pop-up screen and linking the alarm and contents switching.

### Executing Set Expressions

Example: To turn ON the *Error* lamp and sound a continuous buzzer when 1 or more monitored PLC bits turns ON.



1. Register the bits to be monitored under the alarm/event settings.
2. Register a macro with the following settings under the project properties.  
Alarm/Event ON Timing: Execute (i.e., select)  
Macro: \$B0 = 1  
      \$SB12 = 1  
Alarm/Event OFF Timing: Execute (i.e., select)  
Macro: \$B0 = 0  
      \$SB12 = 0
3. Set the lamp on the screen as shown below.  
Address: \$B0  
Label: Error

### Suggestions

Macros can also be used to switch screens or display pop-up screens.

### 4-1-2 Always Reading PLC Word Contents

#### Displaying Word Contents on Data Log Graph

Example: To use data logging function and data log graphs.

1. Register a group with the following settings under the data log settings.
  - Log period: Always.
  - Address: Word number for monitoring word contents.
2. Create a data log graph on the screen with the following settings.
  - Group name: The name of the group registered in step 1.
  - Scroll bar: Select *Use scroll bar*.

The reading of the contents of the specified word will start at the same time as operation starts, regardless of whether or not a data log graph is set to be displayed.

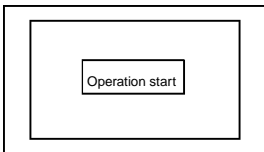

Data read starts at the same time as operation starts.



Display the data log screen to display the latest status.

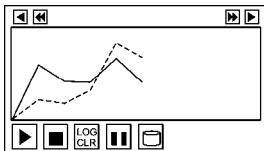

The latest data log graph is displayed based on the collected data.

The contents of the specified word continue to be read even while other screens are being displayed.

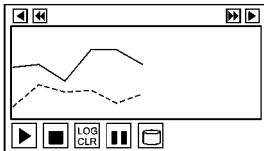

Screen switch  
Different screen

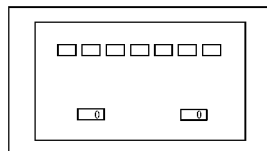

Original screen

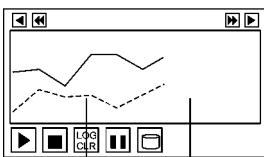

Data gathered during different screen display.



**NS Series Programming Manual**

Changes in past status are displayed if required.

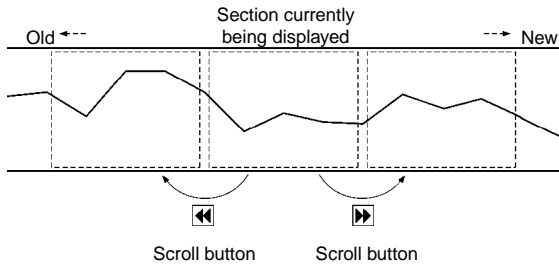

**Suggestions**

Data log graphs can display other icons in addition to the Scroll Button shown above. These icons can control display and data registration.

Stop		Stops data sampling.
Restart/Start		Restarts/Starts stopped data sampling.
Status		Displays the status of a specified address when <i>Start/stop data log</i> is controlled by an external address ON/OFF.
Log Clear		Clears the graph and starts drawing from the latest status. (Past records are held.)
Pause		Pauses graph display. (Continues data sampling.)
Write to File		Outputs logged data to a Memory Card as a CSV file.
Read File		Reads the CSV file saved on the Memory Card.

**Displaying Word Contents after Scaling with Macro Function**

Example: To execute the operation “ $Y = 2X + 3$ ” on the contents of the PLC word (X) and display the results on a data log graph.

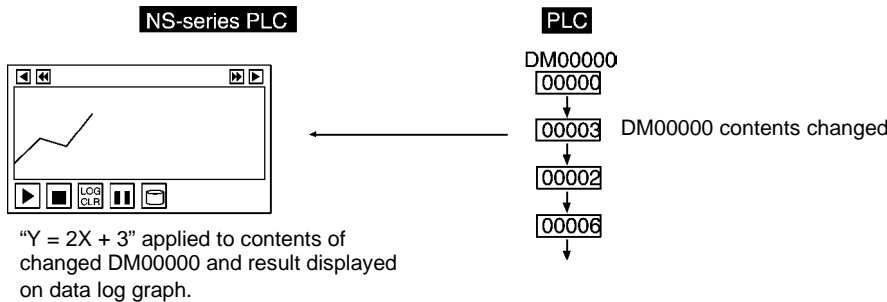

1. Use CX-Designer to set the following numeric expression to the word lamp macro (to change word contents).  
 Expression format:     READCMEM (\$W0, [SerialA:DM00000], 1);  
                               \$W10 = 2 × \$W0 + 3;  
                               (To store Serial A:DM00000 to \$W0 and operation result to \$W10.)
2. Register \$W10 in the data log settings.
3. Create and register a data log graph that will display \$W10 on the screen.

**Suggestions**

- Macros cannot directly specify PLC addresses. Use READCMEM() to store the address at \$W.
- A numeral display and input object can be used to display word contents. Set the scale and offset under *Unit & scale setting* to display an automatically scaled result without executing a macro operation.
- Word contents can be judged because operators can use logical and comparative operands in addition to arithmetic operands.
- If word lamp display is not required, change the settings to no display or move the word lamp outside the screen.

**4-1-3 Changed Bit Status**

**Prohibiting/Allowing Button Operation Based on Bit Status of Device Operation Status**

Example: To display *Initializing* on an ON/OFF Button and prohibit operation while the device is initializing and to display *Ready* on the ON/OFF Button and allow input (with the password “NS” required) when the initialization has been completed.

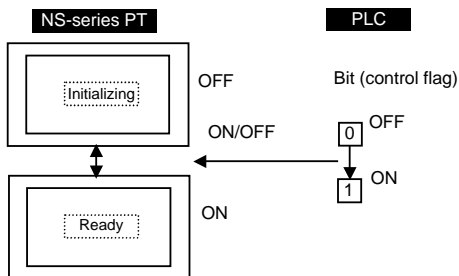

1. Create an ON/OFF Button on the screen with the following settings.

Address (write address)	PLC bit number manipulated using the ON/OFF Button
OFF label	Initializing
ON label	Ready
Switch label for address ON/OFF	Select <i>Switch label for address ON/OFF</i> and <i>Link with the Specified address ON/OFF</i> . Specify as the address the PLC bit number that reflects the device operation status.
Control flag – Input – Indirect	PLC bit number that reflects the device operation status. This bit turns OFF during device initialization and ON when device ready.
Password	Select <i>Level 1</i> and set <i>NS</i> under password level 1 settings.

With these settings, the ON/OFF Button display will depend on the device operation status and operation is prohibited or allowed.

The write address turns ON when input is allowed, the ON/OFF button is pressed, and the password NS is input.

**Suggestions**

Input can be prohibited or allowed for the entire screen by manipulating system memory.

### PLC Designated Switching from Japanese to English Screens

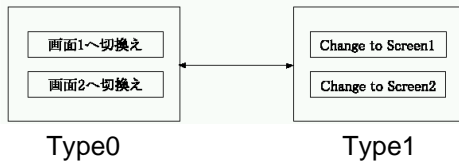

1. Select **PT - Project Properties**, open the Switch Label Tab Page, set the *No. of labels* to 2, and click the **OK** Button.

2. Create the first Command Button.

Function	Switch Screen
Specified screen	Select <i>ON</i> and select <i>Screen 1</i> .
Label ( <i>Type 0</i> under <i>Switch</i> )	Set <i>Switch</i> to <i>screen 1</i> .
Label ( <i>Type 1</i> under <i>Switch</i> )	Set <i>Change to Screen 1</i> .

3. Create the second Command Button.

Function	Switch Screen
Specified screen	Select <i>ON</i> and select <i>Screen 2</i> .
Label ( <i>Type 0</i> under <i>Switch</i> )	Set <i>Switch</i> to <i>screen 2</i> .
Label ( <i>Type 1</i> under <i>Switch</i> )	Set <i>Change to Screen 2</i> .

4. Set *\$\$SB* address and *\$\$SW* address under *System Memory* on the Initial Tab Page under *PT - System setting*.

Write the label switch number (0 or 1) from the PLC to the word corresponding to *\$\$SW10* to switch the display.

### Suggestions

Create a Word Button on the screen and manipulate *\$\$SW10* directly to switch labels.

**Note**

- The System Menu labels will not be changed even when a label change is executed. System Menu labels can be changed on the Initialize Tab Page in the System Menu Window.

### Changing Display Based on PLC Bit Status

**Example 1:** To change display string based on one PLC bit.

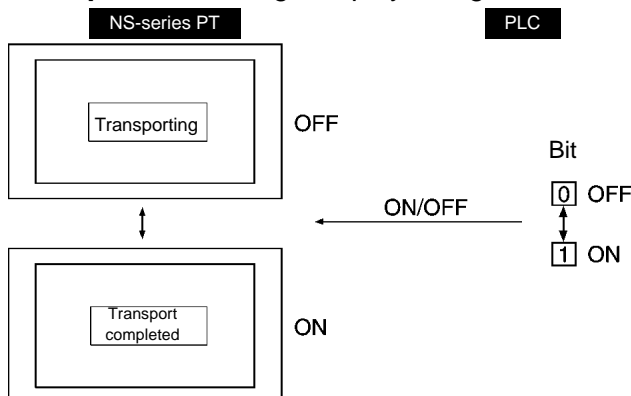

**NS Series Programming Manual**

1. Register an ON/OFF Button on the screen with the following settings.

Switch label for address ON/OFF	Select.
OFF – label	Transporting
ON – label	Transport completed
Address	PLC bit number used to change characters.
Control flag	Disable input (When operation not required.)

**Note**

- ◆ Image data (BMP or JPEG files) cannot be specified for labels.

Example 2: To indicate on the screen the position of the driverless transport vehicle based on the value (0 to F) in the PLC word that indicates the position of the vehicle.

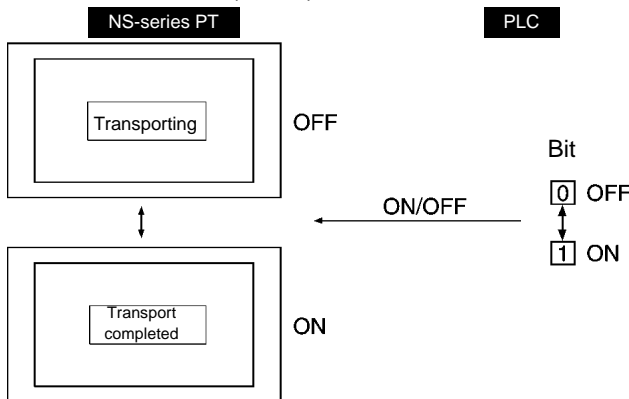

1. Create a bit map (object) for the vehicle position for 0.

Display file: Specify BMP file name for vehicle.

2. Create a word lamp outside the screen.

Address: PLC address that indicates the vehicle position (HOST:00000 in this example.)

Macro – when changing value:

Select.

Macro contents: READCMEM (\$W0, [HOST:00000], 1);

IF(\$W0==0)

MOVEPARTS(1,600,100); ← When display position for 0 is (600,100).

ENDIF

IF(\$W0==1)

MOVEPARTS(1,500,100); ← When display position for 1 is (500,100).

ENDIF

...

IF(\$W0==15)

MOVEPARTS(1,700,200); ← When display position for 15 is (700,200).

ENDIF

(\$W0 is used as a work area.) When ID for bit map (object) created in step 1 is 1.

## 4-1-4 For Numeral/String Input

### Notification of Numeral/String Input from PT

Example: To send a signal to the host notifying any numeral/string input from the PT.

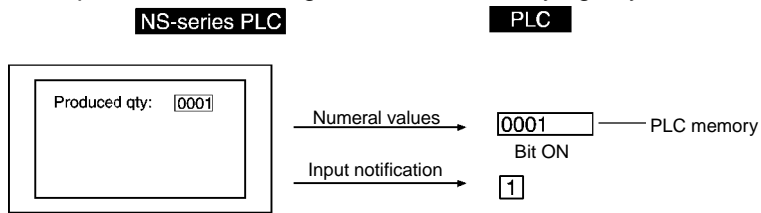

1. Create a numeral display and input object on the screen with the following settings.  
Write: *Select Turn ON the Specified Address when the Value is Confirmed.*  
(extension tab page) Set the PLC address for notification.
2. Create a string display and input object on the screen with the following settings.  
Write: *Select Turn ON the Specified Address when the Value is Written.*  
(extension tab page) Set the PLC address for notification.
3. The PLC address for notification turns ON when a numeral or string is input.

### Suggestions

Turn OFF the PLC notification address from the PLC.



## 4-1-5 For Button Operation By User

### Displaying Online Help Using a Button

Example: To display a pop-up help screen by pressing a button.

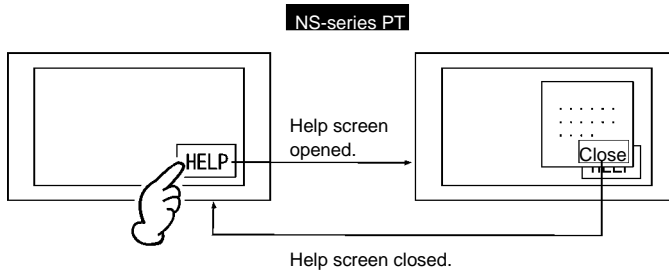

1. Use text on the screen and create the help contents.
2. Create a Command Button with the following settings on the screen from step 1.  
Function – control Pop-up screen: Close local pop-up screen
3. Set the above screen as a pop-up screen under *Screen Properties* by select **PT - Screen/Sheet Properties**, opening the Size/Pop-up Tab Page, and selecting the *Use as Pop-up Screen* Option.
4. Create a Command Button with the following settings on the screen that is the display basis for the help screen.  
Function – Switch screen: Specify the screen from step 1.

## 4-1-6 When Screens Are Switched

### Clearing Specific Sheet Objects

Example: To place a clock at the same position on all screens but to clear clock display for screen 1 only.

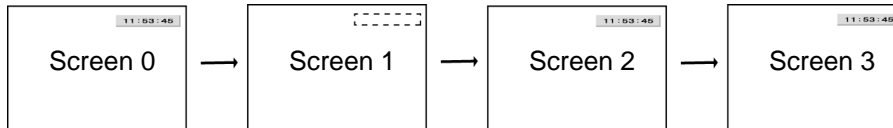

1. Create sheet 0.
2. Create a clock with the following settings on sheet 0.  
Display/no display of control flag – Indirect: \$B100
3. Apply sheet 0 to all screens.
4. Register a macro with the following settings under the project properties.  
Macro for project load: Execute (i.e., select)  
Macro: \$B100=1;
5. Register a macro with the following settings under *Screen properties* for screen 1.  
When Loading a screen: Execute (i.e., select)  
Macro: \$B100=0;  
When Unloading a screen: Execute (i.e., select)  
Macro: \$B100=1;

### Suggestions

If no other objects are created on the sheet, application of sheet 0 can be deselected from screen 1.



## **Section 5      Troubleshooting and Maintenance**

This section describes the countermeasures for errors that may occur on PTs.

5-1	Errors .....	5-1
5-2	Error Messages .....	5-6

## 5-1 Errors

If an error occurs during PT operation, find the symptoms of the error on the following table and then perform the suggested countermeasures.

<b>Note</b>	Check that the system is safe before turning the power ON/OFF or pressing the reset switch. Do not dismantle, repair, or modify NS-series PTs.
-------------	---------------------------------------------------------------------------------------------------------------------------------------------------

### Errors during Data Transfer

Symptoms	Cause	Possible countermeasure
Cannot communicate with CX-Designer.	Not in transfer mode.	Execute the transfer program from the CX-Designer. (Refer to <i>Transferring Data to the PT</i> in the <i>CX-Designer Online Help</i> .)
	Not connected to CX-Designer.	Check the connection cable wiring. (Refer to <i>3-3 Connecting the CX-Designer</i> in the <i>NS Series Setup Manual</i> (Cat. No. V083).)
Cannot execute serial data transfer.	The <i>Extension Interface</i> for serial port B is set to the extension interface (NS5 only).	Set <i>Disable</i> under the Extension Interface on the Comm Tab Page from the NS5.
	The Serial port used for connection with the CX-Designer is set to <i>Allen-Bradley DF1</i> .	Transfer cannot be performed using a serial port set to <i>Allen-Bradley DF1</i> . Use another serial port. Alternatively, disable the serial port on the <b>Comm.</b> Tab Page of the System Menu. Click the <b>Write</b> Button, reset the NS-series PT, and then transfer the data again.
Personal computer cannot detect PT when connected via USB.	The installed system is using system program lower than Ver. 6.2.	Install system program Ver. 6.2 or higher in the PT.
	The PT has a lot number earlier than that indicated in <i>3-3-2 Connecting via USB</i> .	Use a PT from the lot number (or later) indicated in <i>3-3-2 Connecting via USB</i> in the <i>NS Series Setup Manual</i> (Cat. No. V083).
	The USB cable is longer than 2 m.	To use a cable longer than 2 m, connect a USB Hub between the PT and personal computer as shown in <i>Connection Methods</i> under in <i>3-3-2 Connecting via USB</i> in the <i>NS Series Setup Manual</i> (Cat. No. V083).
	A malfunction has occurred due to external noise.	Configure the USB Hub and wire the USB cables taking measures to prevent noise.
	A PictBridge-compatible printer is connected to the USB slave connector	Connect the personal computer to the USB slave connector.
Timeout occurs during screen transfer using USB.	The USB cable is longer than 2 m.	To use a cable longer than 2 m, connect a USB Hub between the PT and personal computer as shown in <i>Connection Methods</i> under in <i>3-3-2 Connecting via USB</i> in the <i>NS Series Setup Manual</i> (Cat. No. V083).
	A malfunction has occurred due to external noise.	Configure the USB Hub and wire the USB cables taking measures to prevent noise.

## Errors at PT Startup

Symptoms	Cause	Possible countermeasure
Indicators are not lit.	Power not supplied to the PT.	Check the connections and supply power correctly to the PT. (Refer to 3-1 <i>Installing the PT</i> in the <i>NS Series Setup Manual</i> .)
	Power supply fuse broken.	The PT must be repaired. Contact your nearest OMRON representative.
	System program corrupted. (Fatal error.)	The PT must be repaired. Contact your nearest OMRON representative.
Indicator remains orange and screen is empty.	System program corrupted. (Fatal error.)	The PT must be repaired. Contact your nearest OMRON representative.
	Cannot check Memory Card.	Use an OMRON specified Memory Card. (Refer to 3-6 <i>Using Memory Cards</i> in the <i>NS Series Setup Manual</i> .)
Indicators flash green and buzzer alternates ON and OFF.	Backlight failure.	Replace the backlight. Contact your nearest OMRON representative.
Screen is empty and indicators flash green.	Automatic upload/download has ended normally.	This is not an error. To return to normal operation, set all DIP switches to OFF and cycle the PT power.
The indicator is lit green and the screen is blank.	The system program is corrupted (non-fatal error). The combination of NS-series PT hardware and system program version is incorrect.	Recovery/update the system program. (Refer to 3-6 <i>Using Memory Cards in the NS Series Setup Manual</i> (Cat. No. V083).) Contact your nearest OMRON representative if the same problem occurs after recovering/updating the system program.
	In the following cases, project data was downloaded without clearing the log data saved in the NS. <ul style="list-style-type: none"> <li>• A project was downloaded to the NS-series PT in which settings related to history, such as alarm/ event or data log settings, have been changed.</li> <li>• An attempt was made to download a project that was different from the project saved in the NS.</li> </ul>	Download the project data again. When downloading the project data again, be sure to clear the log data saved in the NS.
The screen is blank and the indicator is flashing red.	Automatic upload/download has ended abnormally.	The system program may be corrupted. Reinstall the system program. (Refer to 3-6 <i>Using Memory Cards in the NS Series Setup Manual</i> (Cat. No. V083).) If the same problem occurs after reinstalling the system program, the PT may be faulty. Contact your nearest OMRON representative. An attempt may have been made to transfer screens that are larger than the memory of the PT. Check the screen data at the transfer destination.
The indicator is lit red and the screen is blank.	The PT is faulty, or the system program is corrupted.	Reinstall the system program. (Refer to 3-6 <i>Using Memory Cards in the NS Series Setup Manual</i> (Cat. No. V083).) If the same problem occurs after reinstalling the system program, the PT may be faulty. Contact your nearest OMRON representative.

## NS Series Programming Manual

Symptoms	Cause	Possible countermeasure
The Tag Comparison Result Screen is shown.	The tag set for the project does not match and tag set for the host.	Correct the host tag, and then click the <b>Recompare</b> Button. Correct the project tag, and then download the project data to the NS-series PT again.

## Errors When Connecting the Host

Symptoms	Cause	Possible countermeasure
Cannot connect to host. ("Connecting" message displayed at bottom right of screen.)	If the connection is via the Ethernet, the node address, network number, IP address, or other settings are incorrect.	Refer to <i>Section 5-1 Connecting to Host via Ethernet</i> in the <i>NS Series Setup Manual</i> .
	Protocol settings for the host and PT settings do not match.	Use CX-Designer to make communications settings.
	PT and host not connected properly.	Check that the type of connection cable, the length, and the wiring meet the specifications. (Refer to <i>Section 4 Connecting the Host to Serial Port</i> in the <i>NS Series Setup Manual</i> (Cat. No. V083).)
	For 1:N NT Links, a duplicate unit number has been used.	Change the unit number setting so the number is not duplicated. (Refer to <i>6-6 Communications Settings</i> in the <i>NS Series Setup Manual</i> (Cat. No. V083).)
	With the NS5, the <i>Interface</i> for serial port B is set to the extension interface when the connection is to serial port B.	Set the interface to use port B on the Comm Tab Page from the NS5 System Menu.
Cannot communicate after changing communications port.	The communications port set under screen data or in the host settings is incorrect.	Store a correct screen number to display at the allocation address for \$SW0.  Change the CX-Designer communications settings or the host settings to the correct settings. (Refer to <i>System Settings and Project Properties</i> in the <i>CX-Designer Online Help</i> .)

## Errors during PT Operation

Symptoms	Cause	Possible countermeasure
Indicators remain orange while project data is read.	Battery is low or battery is not connected.	If the battery is low during startup, the indicators will be orange but normal operation will continue. Replace the battery within five minutes from when the power is next turned OFF.
RUN indicator is not lit.	Power not supplied to the PT.	Check the connections and supply power correctly to the PT. (Refer to <i>3-1 Installing the PT</i> in the <i>NS Series Setup Manual</i> (Cat. No. V083).)
	Power supply fuse broken.	The PT must be repaired. Contact your nearest OMRON representative.

Symptoms	Cause	Possible countermeasure
Screen is empty.	Waiting for system startup.	This is not an error. The screen will be empty if the wait time has been exceeded.
	Screen saver operating.	This is not an error. Touch the screen to display the screen data.
	Backlight is OFF.	Screen saver is started up. Please turn OFF the screen saver.
	Backlight failure.	Replace the backlight. Contact your nearest OMRON representative.
	The backlight is too dark.	Increase the brightness of the backlight on the PT Setting Tab Page of the System Menu.
No response from the touch panel.	Touch panel malfunctioning due to external noise.	Wire the ground wire to suit the conditions.
	Touch panel malfunction.	Test the touch panel by using <i>Hardware Check</i> under the System Menu. Contact your nearest OMRON representative if there is an error.
Display is dark.	Backlight defective or service life over.	Replace the backlight. Contact your nearest OMRON representative.
	The backlight is too dark.	Increase the brightness of the backlight on the PT Setting Tab Page of the System Menu.
Cannot open device monitor function.	Incorrect communications settings.	Make the following communications settings to use the device monitor function. For C-series PLCs: 1:1 NT Link or 1:N NT Link For CS/CJ-series PLCs: 1:N NT Link (standard or high speed)
	Not device monitor function PLC.	The PLCs that can be used with the device monitor function are limited. Check the model of the PLC being used. (Refer to 6-8-4 <i>Device Monitor</i> in the <i>NS Series Setup Manual</i> .)
Slow display refresh.	Frequent opening/closing of screens and pop-up screens or frequent switching of frames.	If screens or frames are switched or pop-up screens are opened and closed too frequently, the display may update slowly and communications may be delayed. Adjust the interval between screen switches to prevent system overload.
	Message communications interval is too long.	Select <b>PT – Communications Setting</b> in the CX-Designer, click <i>Comm-All</i> , and set a shorter interval in the <i>Intervals of Message-Comm.</i> Field. (Refer to <i>Making Communications Settings</i> in the <i>CX-Designer Online Help</i> .)
Slow screen switching.	Unable to communicate with host.	When a communications error is displayed, refer to 5-2-7 <i>Communications Errors and Countermeasures</i> . Communications errors will not be displayed when communications are set to recover automatically ( <i>Comm. Auto-return</i> set to <i>ON</i> ). In this case, verify that the PT can communicate with the host by performing a communications test from the system menu. If two or more hosts are registered, test communications with all of the hosts.

#### Errors During Object Operation

Symptoms	Cause	Possible countermeasure
Slow numeral or string refresh.	Communications unstable due to external noise.	Reset the power supply and wire the ground wire to suit the conditions. (Refer to 3-1 <i>Installing the PT</i> in the <i>NS Series Setup Manual</i> (Cat. No. V083).)
	Too many numeral display and input or string display and input objects on the current screen.	Reduce the number of numeral display and input objects or string display and input objects on the screen with the slow refresh.
	Host processing slow, increasing cycle time.	Shorten the host cycle time.

Symptoms	Cause	Possible countermeasure
Some objects set for the screen not displayed.	Communications error.	Check the communications settings again.
	A <i>No display</i> flag has turned ON for an object control flag.	Use the following method to set the control flags to <i>Display</i> for the objects not displayed. Set the object properties on the Control Flag Tab Page to <i>Display</i> using CX-Designer. Set the contents of the indirect address for the object control flag to <i>ON</i> for bits and <i>1</i> for words.
Log graph display does not match actual log timing.	Address set as log timing event turning ON/OFF at high speed.	Lengthen the ON/OFF cycle for the event address.
Cannot input numerals.	Maximum/minimum limit check function operating for numeral input.	Check the maximum and minimum limits for screen data numeral input and adjust if necessary.
Cannot input to some functional objects.	A <i>Disable input</i> flag has been set for an object control flag.	Use the following method to set the control flags to <i>Enable input</i> . Set the object properties on the Control Flag Tab Page to <i>Enable input</i> using CX-Designer. Set contents of indirect address for object control flag to ON.
	Password set.	Enter the password in the displayed Password Dialog Box.
	Input objects overlapping.	Some input objects do not operate correctly if they are overlapping. Arrange the input objects so that they do not overlap when creating screens.
Cannot input to any functional object.	In prohibit input mode.	Set system memory bit \$SB19 to OFF. Touch the screen and enter the password for clearing prohibit input into the displayed dialog box.
		Manipulate the Touch Switch Lock Control Flag from the host to allow input.
Nothing displayed on list selection or bitmap objects.	No reference file.	Use the CX-Designer (on the personal computer) to check that the reference file exists in the folder where project data is stored and transfer the screen data to the PT again.
	More than the maximum number of lines has been specified for first line of list selection.	Set a line number within the maximum number of lines.



## 5-2 Error Messages

If one of the messages listed on the following table is displayed on the PT, find the symptoms of the error below and then perform the suggested countermeasures.

### 5-2-1 Troubleshooting Data Transfers from the CX-Designer

This section describes possible errors during data transfer and their countermeasures.

Message	Cause	Possible countermeasure
Either Screen Data Transfer or Memory Card Transfer is already started up. Cannot start up both programs at once.	Tried to start both Memory Card Transfer and Screen Data Transfer.	Only one transfer program can be started at a time.
The file name can be up to 42 characters, including the extension.	Project file name (*.IPP) contains 43 or more characters.	There are limits on transferable file names. Check the error message and use CX-Designer to adjust the file name accordingly. There are similar limits on notation for text files indirectly accessed.
The file name can be up to 14 characters, including the extension, when characters other than alphanumeric characters, underscores, and dollar signs are contained.	Project file name (*.IPP) contains 14 or more characters when special characters are used.	There are limits on transferable file names. Check the error message and use CX-Designer to adjust the file name accordingly. There are similar limits on notation for text files indirectly accessed.
Specified file name contains an invalid character. Unusable character: \\ / : , ; * ? " < >	File name contains invalid characters.	There are limits on transferable file names. Check the error message and use CX-Designer to adjust the file name accordingly. There are similar limits on notation for text files indirectly accessed.
Downloading aborted. This project includes the file which name contains an invalid character. Usable characters are alphanumeric (0 to 9, A to Z, a to z), dollar mark (\$), underscore (_), and . Check the project file and correct it.	File name contains invalid characters.	There are limits on transferable file names. Check the error message and use CX-Designer to adjust the file name accordingly. Only one period (.) before the extension will be valid. There are similar limits on notation for text files indirectly accessed.
System Program Version differs. Do you want to continue downloading? Source: X.XX Destination: X.XX	The system version of the CX-Designer and PT are not the same.	If the system Program cannot be replaced by using automatic download of the PT, use the procedure in section 3-6-3 of the <i>NS Series -V1/-V2 Setup Manual</i> (Cat. No. V083).
Time-out error occurred. Check cable. Perform transmission again after restarting NS Hardware	Timeout occurred during PT connection or transfer.	Check the following items. PT power supply. Cable connection.
NS Hardware is already connected. Restart the NS Hardware to change the communication method.	Tried to use a different communications method while personal computer and PT connected (e.g., tried to switch to Ethernet and connect during serial communications).	Restart the PT and make the new connection.

## NS Series Programming Manual

Message	Cause	Possible countermeasure
Cannot establish connection with the specified communication method. (If the error persists after the suggested countermeasures are performed, close the application and restart the personal computer then try connecting again.)	Connection failed.	Check the following items. PT power supply. Cable connection.
	Pressed <b>Connect</b> Button even though some items remain unset under the Communications Method Settings Dialog Box.	Refer to <i>Transferring Data to the PT</i> in the <i>CX-Designer Online Help</i> for details on proper settings and check the settings.
	One of the following occurred while transferring a screen with the PLC or PT: <ul style="list-style-type: none"> <li>• An unsupported PLC CPU Unit was connected.</li> <li>• A setting required in CX-Programmer Ver. 3.1 or higher was not made.</li> <li>• The PLC CPU Unit was not started.</li> <li>• Attempted to transfer using CX-Designer Ver. 3.0 or lower.</li> <li>• Attempted to transfer to a PT with system program Ver. 3.0 or lower.</li> <li>• The unit number set in the PT does not match the unit number set in the program.</li> </ul>	Refer to <i>Transferring Data to the PT</i> in the <i>CX-Designer Online Help</i> for details on proper settings, check the settings, and correct as necessary.
Error occurred while writing to a flash memory Transmission failed	Data cannot be written.	Initialize data using <i>Screen data area format</i> on the Initialize Tab Page under System Menu and transfer the project.
Cannot find Project file at NS Hardware. Transmit the whole project again.	Cannot find project data on PT.	Resend the whole project.
Project file differs between transmission source and destination. Select the whole project and perform transmission again.	Tried to send separately a different project screen to the project stored on the PT.	With separate screen transfers, one project screen cannot be sent individually to a PT that stores a different project. Select the whole project and resend.
The capacity of NS Hardware is insufficient. Transmission failed.	The created project exceeds the storage capacity of the PT.	Reduce the size of the screen data and retransfer the project.
Cannot delete screen file in NS Hardware.	Could not delete PT screen file.	Initialize data using <i>Screen data area format</i> on the Data Initialize Tab Page under System Menu and transfer the whole project.
File size exceeded the maximum. Please check the Project data.	Transferable file size exceeded.	The maximum size file that can be transferred is 1.44 MB. Re-execute the transfer with a file smaller than 1.44 MB.
Cannot open COM port.	COM port used by another application.	Close the other application and try the connection again.
Failed to start the CX-Server.	CX-Server may not be installed correctly.	CX-Server may not be installed correctly. Refer to <i>Section 2 Setup, Starting, and Exiting</i> in the <i>CX-Designer User's Manual</i> and uninstall CX-Server then reinstall CX-Designer and CX-Server.

Message	Cause	Possible countermeasure
Failed to process the CX-Server.	CX-Server may not be installed correctly.	CX-Server may not be installed correctly. Refer to <i>Section 2 Setup, Starting, and Exiting</i> in the <i>CX-Designer User's Manual</i> and uninstall CX-Server then reinstall CX-Designer and CX-Server.
Error detected at NS Hardware. (0x03a6)	Unexpected error.	The PT may need repaired. Contact your nearest OMRON representative.
NS hardware error.	Possible PT hardware error.	The PT may need repaired. Contact your nearest OMRON representative.
Cannot execute because an invalid address exists. Check with the Find Invalid Addresses in the Symbol Table.	The host type ( <i>Type</i> ) was changed in the CX-Designer's Comm. Setting Dialog Box, but the communications address was created in an area that does not exist in that host. The user attempted to transfer a project containing that invalid address.	If there is an invalid address, the project cannot be transferred. Find the invalid address by right clicking the <b>Find Invalid Addresses</b> Button in the CX-Designer's Symbol Table Window and correct the address.

## 5-2-2 Troubleshooting Errors when Turning ON Power

This section describes possible errors immediately after power is turned ON to the PT and the countermeasures for these errors.

No.	Message	Cause	Possible countermeasure
1	FATAL ERROR No. 01: Touch Panel is not connected: Please contact your OMRON service center.	Touch panel error.	The PT may need repaired. Contact your nearest OMRON representative.
2	FATAL ERROR No. 02: SRAM Initialization Error: Please contact your OMRON service center.	Hardware error in log SRAM.	
3	FATAL ERROR No. 03: MAC Address Error: Please contact your OMRON service center.	Incorrect MAC address.	
4	FATAL ERROR No. 04: PT Model type Identify error.	The PT model cannot be determined.	The PT may need repaired. Contact your nearest OMRON representative.
10	ERROR No. 10: File System Error: Please recover the system program.	File system is corrupted. (A hardware fault occurred or power was interrupted during writing.)	Reinstall the system program by inserting the Memory Card containing the recovery program in the PT and resetting the PT or turning the power supply OFF and ON again. (Refer to 3-6 <i>Using Memory Cards</i> in the Setup Manual.) If a read-only file is stored in the PT, perform a clean install. After that, confirm that the file is not read-only and transfer the screen data to the PT. If the same problem occurs after reinstalling the system program, the PT may need repaired. Contact your nearest OMRON representative.
10	ERROR No. 10: Fail in loading files or executing program: Please recover the system program.	File reading or program execution failed. Read-only file is being transferred to the PT.	
10	ERROR No. 10: Fail in loading files: Please recover the system program.	File reading failed.	
11	ERROR No. 11: Fail in loading files: Please reinstall the system program.	File reading failed.	
11	ERROR No. 11: Device check program error: Please reinstall the system program.	Hardware check program is corrupted.	Execute automatic download of the system program. If the same problem occurs after downloading, insert the Memory Card containing the recovery program in the PT and reset the PT or turn the power supply OFF and ON again. (Refer to 3-6 <i>Using Memory Cards</i> in the Setup Manual.) If the same problem occurs after reinstalling the system program, the PT may need repaired. Contact your nearest OMRON representative.
11	ERROR No. 11: SRAM check program error: Please reinstall the system program.	Log SRAM check program is corrupted.	
11	ERROR No. 11: IP Address Setting Error: Please reinstall the system program.	IP address setting program is corrupted.	

No.	Message	Cause	Possible countermeasure
11	ERROR No. 11: Device check program error: Touch the screen to continue.	At startup with DIP switch 6 set to ON, the hardware check program is corrupted.	The Memory Card transfer program started up after this can be used. If operation is not restored after continuing with the Memory Card transfer program, insert the Memory Card containing the recovery program in the PT and reset the PT or turn the power supply OFF and ON again. (Refer to 3-6 <i>Using Memory Cards</i> in the Setup Manual.) If the same problem occurs after reinstalling the system program, the PT may need repaired. Contact your nearest OMRON representative.
12	ERROR No. 12: Fail in loading fonts: Please reinstall the system program.	Reading of font files when operation performed with DIP switch 6 set to ON failed.	Download the system program by automatic download that does not use DIP switch 6. If operation is not restored after downloading, insert the Memory Card containing the recovery system program in BANK 1 in the PT. (Refer to 3-6 <i>Using Memory Cards</i> in the Setup Manual.) If the same problem occurs after reinstalling the system program, the PT may need repaired. Contact your nearest OMRON representative.
12	ERROR No. 12: Installed system program is not applicable for this hardware: Please reinstall the system program.	The installed system program does not match the hardware.	Install the correct system program. For details on compatible system programs, refer to <i>Appendix C Exchanging Data between NS-series Products</i> in the <i>CX-Designer User's Manual</i> .
20	WARNING No. 20: Date and Time are not set: Touch the screen to continue.	Date set outside the PT's allowable range of 2000 to 2049.	Touch the touch panel to continue booting. Then set the correct date in the System Menu.
21	WARNING No. 21: SRAM previously broken... Initialization Complete: Touch the screen to continue.	SRAM contents could not be held because the battery was not connected or there was insufficient capacity. For this reason, SRAM was initialized.	Touch the touch panel to continue booting. Replace the battery the next time power is turned OFF.
22	WARNING No. 22: Memory Card Error: Some files in a memory card may be corrupted. Safely remove the memory card, and check whether files are not corrupted on a computer. You can continue to startup the PT by touching on the screen, however, it may NOT operate correctly when accessing to the memory card. (The same message will also be displayed in Japanese. This is not a fault.)	The two following causes are possible: The previous time the PT was used, power was turned OFF while accessing the Memory Card. Memory Card access safety information could not be held because the battery was connected or there was insufficient capacity.	Touch the touch panel to continue booting. When the Memory Card is accessed, however, the PT may not operate normally.

No.	Message	Cause	Possible countermeasure
23	WARNING No. 23: Screen data file(s) is not correct: Touch the screen to continue and transfer screen data again.	The screen data in the PT is damaged. (The PT power supply was turned OFF while screen data was being transferred, or a cable was disconnected.)	Touch the PT's touch panel, and after <i>connecting</i> is displayed at the bottom right of the screen, or after the message "No project data is registered. Press OK button and download project data." is displayed, reattempt screen transfer.
24	WARNING No. 24: The recovery program in the inserted Memory Card is not supported by the PT. Update the recovery program, referring to NS Series Setup Manual. To continue starting the PT without executing the program, touch the screen.	The recovery program cannot be started because the recovery program installer in the Memory Card that is inserted in the PT is not supported by the current hardware version of the PT.	Touch the screen to start the system that is currently installed in the PT (i.e., not the recovery program). To start the recovery program that is in the Memory Card, you must update the recovery program that is stored in the Memory Card. To update the program, install the CX-Designer in a personal computer and then select <b>Programs - OMRON - CX-One – CX-Designer – How to recover or update the system program</b> from the Window's Start Menu.

### 5-2-3 Troubleshooting Errors at Startup

This section describes possible errors after power is turned ON to the PT, when operation is started, and during operation and the countermeasures for these errors.

Message	Cause	Possible countermeasure
No project data is registered. Press <b>OK</b> button and download project data.	Cannot read project data (not transferred or corrupted).	Download the project data.
No project data is registered. Press <b>OK</b> button and download project data.		
Failed to read host registration. Correct host registration with CX-Designer. Then, press <b>OK</b> and download project data.	Cannot read project data (not transferred or corrupted).	Download the project data.
Initial Screen does not exist. Please set correct screen number in [Project] tab of System Menu.	No initial screen data.	Download screen data.
		Check that the screen exists with the number set under <i>Initial screen number</i> on the Project Tab Page under the System Menu. (The default screen number is 0.)
Cannot open pop-up screen without opening the base screen.	Specified pop-up screen as screen to be displayed at startup.	Specify a base screen as the initial screen number on the Project Tab Page under the System Menu and restart the PT.
Although Data Block Table exists on the screen, failed to read CSV file to display on Data Block Table. [Data Block (x) CSV file] The object will not be displayed correctly.	The CSV files set for the data block does not exist.	Create the CSV file for the data block in the project folder.
Video Board is not mounted on the PT or an error occurred. Although Video Display exists on the screen, the object will not be displayed correctly.	A Video Input Unit is not installed.	Install a Video Input Unit correctly according to the procedure in 3-6 <i>Installing a Video Input Unit</i> in the <i>NS Series Setup Manual</i> .
	The Video Input Unit is faulty.	Contact your nearest OMRON representative.
The mounted video board and the settings do not match. Please check the video board or settings.	The Video Board mounted in the PT is not the one specified in the project.	Use Support Software to revise the project data while referring to <i>System Settings and Project Properties</i> in the CX-Designer Online help, and then download the data.
	The NS-CA001 Video Input Unit (4 channels) is mounted on the NS15.	The NS15 does not support the NS-CA001 Video Input Unit. Mount the NS-CA002 RGB/Video Input Unit (2 channels).

### 5-2-4 Troubleshooting Errors when Switching Screens

This section describes possible errors when PT screens are switched and the countermeasures for these errors.

Message	Cause	Possible countermeasure
Page file load error. (Page: xxx, ERR: xxx)  (Page: Destination page number; ERR: Error code)	Cannot find specified screen file (ERR:-1).	Correct the destination screen number. Alternatively, download the corresponding screen data.
	Open error for specified screen file (ERR: -2).	Download the project data again.
	Cannot reserve buffer for reading screen header (ERR:-10).	Download the project data again.
	Cannot reserve buffer for reading screen data (ERR:-11).	Download the project data again. If the error persists after the data has been downloaded again, the screen data is too large for the memory capacity. Reduce the size of the screen data file by reducing, for example, the number of objects on the screen.
	Cannot reserve buffer for reading macro data (ERR:-12).	Download the project data again.
	File read error (screen header part) (ERR:-20).	Download the project data again.
	File read error (macro data part) (ERR:-21).	Download the project data again.
	Screen file ID error (ERR:-30).	Download the project data again.
	Screen file version error (ERR:-40).	Execute <i>Save all</i> under the CX-Designer File Menu and download the project data again.
	File read error (functional object header part) (ERR:-102).	Download the project data again.
	Functional object type error (ERR:-103).	Download the project data again.
	File read error (functional object properties part) (ERR:-104).	Download the project data again.
	Cannot reserve buffer for reading functional object data (ERR:-105).	Download the project data again. If the error persists after the data has been downloaded again, the screen data is too large for the memory capacity. Reduce the size of the screen data file by reducing, for example, the number of objects on the screen.
Video Board is not mounted on the PT or an error occurred. Although Video Display exists on the screen, the object will not be displayed correctly.	A Video Input Unit is not installed.	Install a Video Input Unit correctly according to the procedure in 3-6 <i>Installing a Video Input Unit</i> in the <i>NS Series Setup Manual</i> (Cat. No. V083).
	The Video Input Unit is faulty.	Contact your nearest OMRON representative.
No. of addresses that can be set in one page are 6,500.	The number of monitor points exceeds 6,500.	The maximum number of monitor points per screen is 6,500 (for both bits and words). Do not set more than 6,500.



### Reference

- ◆ If a screen switching error occurs, the current pop-up screen will automatically close.
- ◆ The number of communications points (bits and words) is the total number of addresses (in host and internal memory) set to functional objects in displayed screens, sheets, and pop-up screens and alarms/events and data logs.

If the same address is used multiple times, that address is counted for each time it is used. Addresses used in macros, however, are not counted. Addresses allocated in system memory are not counted either.

Example: To display the following screen data

- Allocate host DM00000 to system memory \$SW0. (Zero communications points (words) used.)
- Screen 1: Create 10 bit lamps and set bits \$B0 to \$B9 to each. (10 communications points (bits) used.)  
\$W0 used by macro for screen loading. (0 words used.)  
Sheet 0 applied. Set pop-up screen 10 to be opened at the same time.
- Sheet 0: Create one ON/OFF Button to which \$B10 is set. (1 bit used.)  
\$W1, \$W2, and \$B20 used by touch ON macro for this ON/OFF Button.  
(0 bits/words used.)
- Screen 10: Create 10 numeral display and input objects, to which \$W10 to \$W19 are set.  
(10 words used.)  
Alarm/event: Set 20 points, \$B0 to \$B19. (20 bits used.)
- Data log: Standard logging of 10 words, \$W100 to \$W109. (10 words used.)

A total of 51 communications points (bits and words) are used.

### 5-2-5 Troubleshooting Errors for Functional Objects

This section describes possible errors during operation of functional objects and their countermeasures.

Message	Cause	Possible countermeasure
Input date is incorrect.	Input error when changing date using date object.	Press the <b>OK</b> Button and input the correct date.
Input time is incorrect.	Input error when changing time using time object.	Press the <b>OK</b> Button and input the correct time.
Exceeding maximum limit.	Incorrect input to numeral display and input object.	Press the <b>OK</b> Button and return to the original screen. Input data below the upper limit.
Exceeding minimum limit.	Incorrect input to numeral display and input object.	Press the <b>OK</b> Button and return to the original screen. Input data above the lower limit.
Input data is incorrect.	Incorrect input.	Input the data again.
Password error.	Incorrect password input.	Press the <b>OK</b> Button and input the correct password.
Wrong passwords are entered three times. Password operation cancelled.	Incorrect password input.	Press the <b>OK</b> Button and display the password input screen again. Input the correct password. If you have forgotten the password, use CX-Designer to reset the password. Use the Password Tab Page under the System Menu to change the password if required.
Memory Capacity insufficient. Cannot continue operation.	Insufficient memory.	Reduce the data size by reducing number of screen objects, reducing the size of the displayed BMP file, or similar measures.
Failed to save to a file.	Failed to save CSV file from data log graph or Multifunction Object.	Insert a Memory Card with sufficient free space into the PT. Check to see if the Memory Card is damaged.
Failed to read file. [Data Block (Data Block No.) CSV File]	Failed to read data file at Data Block Table.	Create CSV file set for Data Block Setting under Project folder.
Failed to write to the file. [Data Block (Data Block No.) CSV File]	Failed to write data file at Data Block Table.	Create CSV file set for Data Block Setting under Project folder.
Cannot add any more.	Attempt to add more than the maximum number of the records using Add to the record icon.	Increase the maximum number of records for Data Block at Data Block Setting in CX-Designer.
Cannot write to Memory card. Confirm that Memory card is inserted.	Failed to write the file from Data Block.	Check whether or not Memory card is inserted or corrupted.
	Failed to save the file when performing Video Capture.	
Stop logging data before reading the CSV file.	The Read File icon was pressed during data logging.	When reading a CSV file, stop logging and then press the Read File icon.

## 5-2-6 Troubleshooting Errors during System Menu Operation

Message	Cause	Possible countermeasure
Error occurred while formatting screen data range.	Hardware failure.	Contact your nearest OMRON representative.
Failed to save to a file.	File system damaged.	Format the screen data area and transfer the screen data again.
The address set at CH type selection is not correct. Check the address and input the correct address again. Allocated host: XXXX Allocated address: XXXX MRES = XXXX, SRES = XXXX.	Set address is incorrect.	Check whether or not an illegal address has been set and set the correct address.
Time-out error occurs while downloading by the following case: <ul style="list-style-type: none"> <li>• Disconnection of the connecting cable</li> <li>• Stopped host</li> </ul> MRES = XXXX, SRES = XXXX. NS5: Time-out error occurs while downloading Host Allocated host: XXXX	Cable is disconnected. PLC power supply is OFF.	Connect the cable correctly. Turn ON the PLC power supply.
The address set at CH type selection is not for writing. Check the address and input the correct address again. Allocated host: XXXX Allocated address: XXXX MRES = XXXX, SRES = XXXX.	Host is in RUN mode. Tried to write to a write prohibited address.	Change to program or monitor mode. Check the address and set the correct address.
Other peripheral tool is accessing. Send commands again after access right is released. Allocated host: XXXX Allocated address: XXXX MRES = XXXX, SRES = XXXX.	CX-Programmer or other programming device is connected.	Disconnect the connected programming device.
Communication error detected while downloading by the following case: <ul style="list-style-type: none"> <li>• Corrupted data by noise</li> <li>• Transmit error by the host</li> </ul> MRES = XXXX, SRES = XXXX. NS5: Communication error detected while downloading the data Allocated host: XXXX	Data corrupted by noise. Invalid host communications command.	Check the cable connection and conduct a continuity test. Exchange the cable if there is a cable error. If necessary, rewire the cable.
Registered host information and communication setting are not match. Check the communication setting.	Registered host selected but not connected.	Change the communications settings under the System Menu so that the corresponding port is set.
Destination address is incorrect. Check the host information.	The remote address where the host is registered is incorrect. Connected to a different PLC while online.	Check the host registration and, if necessary, use CX-Designer to change the address.

Message	Cause	Possible countermeasure
Cannot cancel error by the following case: <ul style="list-style-type: none"> <li>• Operation mode is not in program mode.</li> <li>• Cause of error at host side is not yet removed.</li> </ul>	Not in program mode. Cause of error not cleared on host side.	Change to program mode. Clear error on host side.
Writing to this memory is not possible.	Tried to write to AR.	AR is write prohibited. Select another memory area.
Cannot write in during RUN mode.	Tried to write in RUN mode.	Change to program or monitor mode.
Force ON/OFF is not possible with this address type.	Tried to force ON/OFF DM or EM.	Select another memory area.
Cannot connect to this PLC model.	Tried to connect a PLC that cannot be connected to device monitor.	Check the PLC model and change to permissible PLC type.
No project data.	Tried to change settings even though there is no project data.	Download the project data.
Old password is NOT correct.	Input incorrect previous password when changing password.	Use CX-Designer to check the password and input the correct password.
Password input in the confirmation does NOT match with the New Password.	Input the incorrect new password to the Confirmation input field when changing password.	Enter the new password again.
Failed to save data to CSV file in a Memory Card. Check the Memory Card.	A Memory Card is not inserted or the Card is not one supported by the PT.	Check to see if a Memory Card is inserted, replace it if necessary, and try to save the data again.
Changing value is set as Disable so that the value cannot be changed.	Device Monitor value modification is disabled.	Use the PT Settings Tab Page under the System Menu to enable changes to the values.
Changing value is set as Disable so that the Mode cannot be changed.	Device Monitor value modification is disabled.	Use the PT Settings Tab Page under the System Menu to enable changes to the values.
Failed to delete the file.	The file is a read-only file.	Clear the read-only setting.
Printer error	The printer cable is not connected, the printer power is OFF, or a printer error occurred.	Make sure the cable is properly connected and the power is ON. Eliminate any printer hardware errors, such as an empty paper tray or empty ink cartridge.
Failed to stop the Memory Card. It is not ready to be removed.	The <b>Remove</b> Button was pressed while the Memory Card was being accessed.	Wait until the Memory Card stops being accessed, and then press the <b>Remove</b> Button again to remove the Memory Card.

## 5-2-7 Communications Errors and Countermeasures

This section describes the communications errors that may occur during operation and possible countermeasures.

Refer to 5-2-9 *Troubleshooting Errors with EtherNet/IP Communications*.

### PT Operation When Errors Occur

An error message is displayed on the PT when an error occurs, and a buzzer will sound if *Buzzer sound* under the System Menu is set to ON or ERR ON. Error messages are displayed when *Communications auto return* is turned OFF under the System Menu.

### User Operation When Errors Occur

Check the error message displayed and press the **OK** Button. When the OK Button is pressed, the screen before the communications error will be returned and operation will restart. Alternatively, the display may automatically switch to the System Menu. Check the settings under the System Menu and change if necessary.

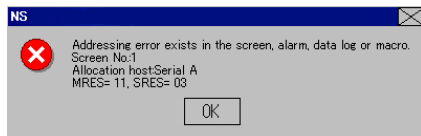

The information in the following table will be displayed, depending on the error.

Screen No.:	Screen number
Allocated host:	Host name
MRES:	Main response code
SRES:	Sub-response code

### Note

- ◆ If *Communications auto return* is set to ON and an error occurs at one port while both ports are being used, the other port will continue communications.
- ◆ When a communications error occurs, press the **OK** Button in the error message to return the original screen. The numeral and other data on the original screen will be the data from before the error occurred.

The following messages are displayed for communications errors.

Message	Cause	Possible countermeasure
Addressing error exists in the screen, alarm, data log, or macro. Correct address setting by the CX-Designer. Screen No.: XXXX Allocation host: XXXX MRES=XXX, SRES=XXXX	The set address is invalid.	Press the <b>OK</b> Button to move to the System Menu. Check the communications settings under <i>data check</i> , in particular that the address is valid. Use CX-Designer to change the settings.

Message	Cause	Possible countermeasure
<p>Time-out error occurs while downloading by the following case:</p> <ul style="list-style-type: none"> <li>• Disconnection of the connecting cable.</li> <li>• Stopped host</li> <li>• Incorrect time-out period.</li> </ul> <p>NS5: Time-out error occurs while downloading Host Allocated host: XXXX</p>	<p>The communications cable is not connected properly.</p> <p>The host communications service has stopped.</p> <p>The timeout monitor time is too short.</p>	<p>Check the cable connection and conduct a continuity test. Exchange the cable if there is a cable error. If necessary, rewire the cable.</p>
<p>Communication error detected while downloading by the following case:</p> <ul style="list-style-type: none"> <li>• Corrupted data by noise</li> <li>• Transmit error by the host</li> </ul> <p>MRES=XXX, SRES=XXXX NS5: Communication error detected while downloading the data Allocated host: XXXX</p>	<p>Data corrupted by noise.</p> <p>Invalid host communications command.</p>	<p>Check the cable connection and conduct a continuity test. Exchange the cable if there is a cable error. If necessary, rewire the cable.</p>
<p>Addressing error exists in the screen, alarm, data log, or macro. Correct address setting by the CX-Designer.</p> <p>Screen No.: XXXX Allocation Host: XXXX Allocation Address: XXXX MRES: XXXX SRES: XXXX NS5: Addressing error exists in the screen, alarm, data log or macro. Screen No.: XXXX Allocation Host: XXXX Allocation Address: XXXX MRES: XXXX SRES: XXXX</p>	<p>An illegal address is set.</p>	<p>Press the <b>OK</b> Button to go to the System Menu. Select Data Check to see whether the address is valid and the communications settings are correct. Use CX-Designer to change settings if necessary.</p>
<p>Communication error detected while uploading by the following cases:</p> <p>Corrupted data by noise Transmit error by the host Allocation Host: XXXX NS5: Communication error detected while uploading the data Allocation Host: XXXX</p>	<p>Data corrupted by noise</p> <p>Invalid host communications command</p>	<p>Check the cable connection and conduct a continuity test. Replace the cable if there is a cable error, or rewire the cable if necessary.</p>

Message	Cause	Possible countermeasure
Failed to read host registration. Correct host registration with CX-Designer. Then, press OK and then download project data.	Project data cannot be downloaded (was not transmitted or is corrupted).	Use a Programming Device to repair the data and try to download it again.
Time-out error occurred while writing by the following case: Disconnection of the connecting cable Stopped host_- Incorrect time-out period Allocation Host: XXXX Do you want to retry? NS5: Time-out error occurred while writing the data Allocation Host: XXXX Do you want to retry?	The communications cable is not properly connected. The host communications service has stopped. The timeout monitoring time is too short.	Check the cable connection and conduct a continuity test. Replace the cable if there is a cable error, or rewire the cable if necessary.
Time-out error occurred while writing due to the following: Disconnection of the connecting cable Stopped host_- Incorrect time-out period Allocation Host: XXXX Do you want to retry? NS5: Time-out error occurred while writing to the System Memory Area. Allocation Host: XXXX Do you want to retry?	The communications cable is not properly connected. The host communications service has stopped. The timeout monitoring time is too short.	Check the cable connection and conduct a continuity test. Replace the cable if there is a cable error, or rewire the cable if necessary.
Communication error detected while writing by the following case: Corrupted data by noise Transmit error by the host Allocation Host: XXXX Do you want to retry? NS5: Communication error detected while writing to the System Memory Area Allocation Host: XXXX Do you want to retry?	Data corrupted by noise Invalid host communications command	Check the cable connection and conduct a continuity test. Replace the cable if there is a cable error, or rewire the cable if necessary.

Message	Cause	Possible countermeasure
Communication error detected while writing by the following case: Corrupted data by noise Transmit error by the host Allocation Host: XXXX Do you want to retry? NS5: Communication error detected while writing to the System Memory Area. Allocation Host: XXXX Do you want to retry?	Data corrupted by noise Invalid host communications command	Check the cable connection and conduct a continuity test. Replace the cable if there is a cable error, or rewire the cable if necessary.



### Probable Causes and Possible Countermeasures

Perform the following countermeasures for the displayed cause.

Errors	Suggested cause as displayed	Possible countermeasure
Local node error (MRES:01)	Local node not connected to network (SRES:01).	Connect the node to the network.
	No token received (SRES:02).	Set the local node within the maximum node address range.
	Cannot send because number of retries exceeded (SRES:03).	If tests executed between nodes do not operate normally, check the operating environment again.
	Cannot send because allowable number of frames exceeded (SRES:04).	Check the status of the event executed in the network and reduce the number of events in one cycle. Alternatively, increase the number of frames allowed to be sent.
	Node address setting incorrect (SRES:05).	Make the correct rotary switch settings. Make sure the node address is not outside the specified range and is not duplicated.
	Node address duplicated in network (SRES:06).	Change the duplicated node address.
Destination node errors (MRES:02)	Remote node not connected to network (SRES:01).	Connect the remote node to the network.
	No Unit for the unit address (SRES:02).	Check the remote unit address.
	No third node (SRES:03).	Check the address for the unit used as the third node. Check the third node address in the CMND instruction send data.
	Broadcast specified (SRES:03).	Specify only one node as the third node.
	Reception concentrated at remote node (SRES:04).	Increase the number of retries or redesign the system so that there is not concentration at the remote node.
	Message frame broken (SRES:05).	Increase the number of set retries. Perform an internode test to check the noise status.
	Response monitor time too short (SRES:05).	Increase the response monitor time parameters.
	Send/receive frame discarded (SRES:05).	Check the error history and take the correct action.
Controller error (MRES:03)	Parity error, BBC error, or similar error has occurred (SRES:06).	Set the maximum unit number to 1 or higher for NT Link mode in the PLC Setup.
	Communications controller error (SRES:01).	Refer to the Unit and Board user's manuals and take the correct action.
	CPU error on remote node CPU Unit. (SRES:02)	Refer to the CPU Unit manual and remove the cause of the CPU Unit error.
	No response returned because of Board error (SRES:03).	Check the network communications status and restart the Board. If the error persists, replace the Board.
Service unsupported (MRES:04)	Incorrect Unit number setting (SRES:04)	Make the correct rotary switch settings. Make sure the Unit number is not outside the specified range and is not duplicated.
	The Unit or Board do not support the command code used (SRES:01).	Check the command code.
	Command cannot be executed because the model or version is different (SRES:02).	Check the model and version.

Errors	Suggested cause as displayed	Possible countermeasure
Routing table error (MRES:05)	No destination address set on routing table (SRES:01).	Set the destination address on the routing table.
	Destination unclear because there is no routing table (SRES:02).	Set routing tables to the source, destination, and relay nodes.
	Routing table error (SRES:03).	Make the correct routing table settings.
	Command used more than 3 levels (SRES:04).	Edit the network or change the routing tables so that the command uses 3 or fewer levels.
Command format error (MRES:10)	Command too long (SRES:01).	Check the command format and set the correct command data.
	Command too short (SRES:02).	Check the command format and set the correct command data.
	The specified number of elements and the number of data to write do not match (SRES:03).	Check and match the number of nodes and the number of data writes.
	Different format (SRES:04).	Check the command format and set the correct command data.
	Local node relay table or relay node local network table settings incorrect (SRES:05).	Make the correct routing table settings.
Parameter error (MRES:11)	No corresponding variable code or EM (SRES:01).	Check command variables and parameter codes and set the corresponding code.
	Different access size specification or odd start address specified (SRES:02).	Check the variable and parameter access sizes and set the correct access size.
	Start address in processing range for command is in access-prohibited area (SRES:03).	Check the allowable processing range and set the processing range within the allowable range.
	End position in processing range for command is outside allowable processing range (SRES:04).	Check the allowable processing range and set the processing range within the allowable range.
	Total number of words exceeds limit (SRES:04).	Make the correct data link table settings.
	Non-existent program number set (SRES:05).	Check the valid program numbers and make the correct size relationship settings.
	Incorrect size relationship for command elements (SRES:09).	Check the command data and set the correct size relationships.
	Node not set in common link parameters is set in refresh parameters (SRES:09).	Make the correct data link table settings.
	Tried to execute derivative monitor during data trace or tried to execute data trace during derivative monitoring. (SRES:0A)	Abort the current processing or wait until it has been completed and then execute the command.
	Duplicate node address. (SRES:0A)	Make the correct data link table settings.
	Response exceeds maximum response length (SRES:0B).	Check the command format and set the correct number of elements.
	Error in set parameters (SRES:0C).	Check the command data and set the correct parameters.
	Error in file (SRES:0C).	Check file contents.

Errors	Suggested cause as displayed	Possible countermeasure
Read not possible (MRES:20)	Program area protected. (SRES:02)	Use support software to remove the protection and re-execute the command.
	No registered tables (SRES:03).	Set tables.
	Table error (SRES:03).	Make the correct table settings.
	No data to match search data (SRES:04).	-----
	Non-existent program number set (SRES:05).	Check valid program numbers and set valid number.
	No corresponding file on specified file device (SRES: 06).	Check that the file name, including the subdirectory, is correct.
	Mismatched data in data being verified (SRES:07).	Check memory contents and write the correct data.
	File read failed (SRES:07).	Check file contents.
Write not possible (MRES:21)	Cannot access because read-only area. (SRES:01)	If write protected by switch settings, remove the protection and re-execute the command. Write commands cannot be executed for write-prohibited areas.
	Program area protected (SRES:02).	Use support software to remove the protection and re-execute the command.
	Write prohibited due to automatic data link table settings (SRES:02).	Change the system settings to allow any data link table settings.
	Tried to create file when number of files that can be registered has been exceeded (SRES:03).	Delete unnecessary files and then create a new file or create memory area for new files.
	Tried to open too many files for system limits (SRES:03).	Close open files and then re-execute the command.
	Non-existent program number set (SRES:05).	Check valid program numbers and set valid number.
	No corresponding file on specified file device (SRES: 06).	Check file name and re-execute command.
	Same file already on specified file device (SRES:07).	Change the write file name and re-execute the command.
	Cannot change because change caused error. (SRES:08)	-----
Not executable in current mode (MRES:22)	The mode is incorrect (SRES:01).	Check operating mode.
	Cannot execute because data link starting (SRES:01)	Check the data link startup status.
	Cannot execute because data link stopped (SRES:02).	Check the data link startup status.
	Different command operating mode (program mode) (SRES:03).	Check PLC and FA computer operating mode.
	Different command operating mode (debug mode) (SRES:04).	Check PLC and FA computer operating mode.
	Different command operating mode (monitor mode) (SRES:05).	Check PLC and FA computer operating mode.
	Different command operating mode (run mode) (SRES:06).	Check PLC and FA computer operating mode.
	Not polling node (SRES:07)	Check the polling node on the network.
	Different command operating mode (SRES:08).	Check active status of the step.

Errors	Suggested cause as displayed	Possible countermeasure
No such device Unit (MRES:23)	No memory (media) for file device (SRES:01).	Mount memory (media). Alternatively, format EM.
	No file memory (SRES:02).	Check that file memory is mounted.
	No clock (SRES:03).	Check the model.
Cannot start/stop (MRES:24)	Data link table not registered or data link table error (SRES:01).	Make the data link table settings.
Unit error (MRES:25)	Memory error (SRES:02)	Resend correct data to memory.
	Registered I/O and actual I/O configurations different (SRES:03).	Change the actual configuration to match the registered configuration or create the I/O tables again.
	Registered number of I/O points or remote I/O points exceeded (SRES:04).	Change the registered number of points so that it will not be exceeded.
	Data transfer error between CPU and CPU Bus Unit (SRES:05).	Check that the Unit, Board, and cable are connected correctly and execute the <i>ERROR CLEAR</i> command.
	Duplicate number in rack or Unit numbers or I/O address settings under system settings (SRES:06).	Check the system settings and change any duplicate numbers.
	Data transfer error between CPU and I/O Unit. (SRES:07)	Check that the Unit, Board, and cable are connected correctly and execute the <i>ERROR CLEAR</i> command.
	SYSMAC BUS/2 data transfer error. (SRES:09)	Check that the Unit, Board, and cable are connected correctly and execute the <i>Clear error</i> command.
	CPU Bus Unit data transfer error. (SRES:0A)	Check that the Unit, Board, and cable are connected correctly and execute the <i>Clear error</i> command.
	Duplicate word settings (SRES:0D).	Verify I/O table data and reset I/O words.
	Error during error check of internal memory, Memory Card, or EM file memory (SRES:0F).	<ul style="list-style-type: none"> <li>For internal memory errors, write the correct data and re-execute the command.</li> <li>Memory Card or EM file memory errors indicate that the file data has been corrupted. Execute the <i>Format extension memory</i> command.</li> <li>Replace the memory if the error is not cleared after the above processing has been performed.</li> </ul>
The communications load is too heavy when connected using Host Link (SRES: 0F).	<ul style="list-style-type: none"> <li>Use NT Link.</li> <li>Reduce the size of the system word memory (\$SW) allocation.</li> </ul>	
Terminator has not been set (SRES:10).	Make the correct end station settings.	

Errors	Suggested cause as displayed	Possible countermeasure
Command error (MRES:26)	No protection (SRES:01).	Protection does not need to be removed because there is no protection on the program area.
	Specified password different from registered password (SRES:02).	Specify the correct registered password.
	Protected (SRES:03).	Use support software to remove the protection and re-execute the command.
	More than 5 commands processing at command receive node (SRES:04).	Close or stop a service being executed and re-execute the command.
	Service executing. (SRES:05)	Close or stop a service being executed and re-execute the command.
	Service not executed (SRES:06).	Execute the corresponding service as required.
	No authority to execute service (SRES:07).	Local node not in data link. Execute service from node in data link.
	No response received due to buffer error (SRES:07).	Restart the Board. Replace the Board if the error persists.
	Settings not made before service executed (SERS:08).	Make the required settings.
	Required settings not made for command data (SRES: 09).	Check the command format and set the required command data.
	Tried to register program using already registered action/transition numbers (SRES:0A).	Change to unregistered action/transition numbers and re-execute the command.
	Cause of error not removed (SRES:0B).	Remove the cause of the error and execute the <i>ERROR CLEAR</i> command.
Access right error (MRES:30)	Another node has the access right. (SFC online edit using other node FIT is executed or <i>ACCESS RIGHT ACQUIRE</i> or <i>ACCESS RIGHT FORCE ACQUIRE</i> command executed on another node.) (SRES:01)	Wait until access rights are cleared and re-execute the command. (Execute <i>ACCESS RIGHT FORCE ACQUIRE</i> or <i>ACCESS RIGHT RELEASE</i> command to enable execution of original command. Current processing on the node that had access rights may be affected, however.)
Abort (MRES:40)	Interrupted by ABORT command (SRES:01).	-----

Errors	Suggested cause as displayed	Possible countermeasure
PT memory error (MRES:7F)	Exception error during processing. (SRES:05)	System program corrupted. Download the system program. If the error persists, contact your nearest OMRON representative.
	Incorrect element type (SRES:13).	Screen data corrupted. Download screen data.
	Incorrect start address. (SRES:1A)	Address outside range has been set. Check the setting data and use CX-Designer to correct the setting.
	Insufficient read data buffer (SRES:1B).	System program corrupted. Download the system program. If the error persists, the PT may need repaired. Contact your nearest OMRON representative.
	Standby processing failed for exclusive processing. (SRES:1C)	System program corrupted. Download the system program. If the error persists, the PT may need repaired. Contact your nearest OMRON representative.
	Insufficient write data elements. (SRES:1D)	System program corrupted. Download the system program. If the error persists, the PT may need repaired. Contact your nearest OMRON representative.
	Incorrect end address. (SRES:2B)	Address outside range has been set. Check the setting data and use CX-Designer to correct the setting.
	Access method initialization failure (SRES:3C).	System program corrupted. Download the system program. If the error persists, the PT may need repaired. Contact your nearest OMRON representative.
	Access method exit processing failure (SRES:3D).	System program corrupted. Download the system program. If the error persists, the PT may need repaired. Contact your nearest OMRON representative.
	Incorrect Access Method parameters (SRES:3E).	System program corrupted. Download the system program. If the error persists, the PT may need repaired. Contact your nearest OMRON representative.
Other incorrect subresponse code.	The PT may need repaired. Contact your nearest OMRON representative.	

## 5-2-8 Troubleshooting Macros

This section describes possible errors during macro execution and their countermeasures.

The following message is displayed if an error occurs during macro execution.

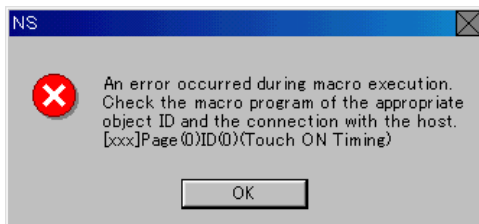

[xxx]	Error details.
Page (xxx)	Screen number where error occurred ("-1" for project macros).
ID (xxx)	Functional object ID number where error occurred ("-1" for project and screen macros).
(xxx)	Macro execution timing.

The information displayed under error details, the cause, and the countermeasures are outlined in the following table.

Error details	Cause	Possible countermeasure
0 division error	Divided by zero.	Set a numeral other than 0.
Illegal argument.	Illegal value set to function argument.	Check the set argument and make the correct setting.
Illegal program	Illegal program has been set or timeout error occurred.	Check the macro contents again and program again correctly. Check for the following: <ul style="list-style-type: none"> <li>• Disconnection of the connecting cable</li> <li>• Stopped host</li> <li>• Incorrect timeout period</li> </ul>
BCD code error	Value has been set that cannot be converted to BCD or BIN command argument.	Check the set argument and make the correct setting.

The following information is displayed under macro execution timing.

Macro execution timing	Details
When loading a project	Macro executed when project loaded.
Alarm/Event ON	Macro executed when alarm or event ON.
Alarm/Event OFF	Macro executed when alarm or event cleared.
When loading a screen	Macro executed when screen opened.
When unloading a screen	Macro executed when screen closed.
Touch ON	Macro executed when ON/OFF, Word, or Command Buttons touched ON.
Touch OFF	Macro executed when ON/OFF, Word, or Command Buttons touched OFF.
Before Inputting numeral and string	Macro executed when numeral display and input or string display and input objects touched.
Before writing numeral and string	Macro executed when input made to numeral display and input or string display and input objects or thumbwheel switches.
When changing numeral or string	Macro executed when contents of address set to a bit lamp, word lamp, numeral display and input object, string display or input object, or thumbwheel switch are changed.
When selecting a list	Macro executed when selection made from list selection.
When Pressing a Display Area A	Macro executed when alarm or event display area is pressed during an alarm or event.
	Macro executed when displayed alarm/event selected using alarm/event summary and history object.

#### Note

- ◆ A communications error message will also be displayed if an illegal address is accessed by a macro.



## 5-2-9 Troubleshooting Errors with EtherNet/IP Communications

This section describes the countermeasures for EtherNet/IP errors that may occur.

### PT Operation When Errors Occur

An error message is displayed on the PT when an error occurs, and a buzzer will sound if *Buzzer sound* under the System Menu is set to ON or ERR ON. Error messages are displayed when *Communications auto return* is turned OFF under the System Menu.

### User Operation When Errors Occur

Check the error message displayed and press the **OK** Button. When the OK Button is pressed, the screen before the communications error will be returned and operation will restart. Alternatively, the display may automatically switch to the System Menu. Check the settings under the System Menu and change if necessary.



The information in the following table will be displayed, depending on the error.

Screen No.:	Screen number
Allocated host:	Host name
General:	General Status (0xXX)
Additional:	Additional Status (0xXX XXXX)
	Upper 2 digits: Number of words of additional status
	Lower 4 digits: Error code

### Note

- ◆ If *Communications auto return* is set to ON and an error occurs at one port while both ports are being used, the other port will continue communications.
- ◆ When a communications error occurs, press the **OK** Button in the error message to return the original screen. The numeral and other data on the original screen will be the data from before the error occurred.

The following messages are displayed for communications errors.

Message	Cause	Possible countermeasure
<p>Addressing error exists in the screen, alarm, data log, or macro. Correct address setting by the CX-Designer. Screen No.: XXXX Allocation host: XXXX General=XXX, Additional=XXXX</p> <p>NS5: Addressing error exists in the screen, alarm, macro or data log. Screen No.: XXXX Allocation Host: XXXX General=0xXX, Additional=0xXX XXXX</p>	<p>The set address is invalid.</p>	<p>Press the <b>OK</b> Button to move to the System Menu.</p> <p>Check the communications settings under <i>data check</i>, in particular that the address is valid.</p> <p>Use CX-Designer to change the settings.</p>
<p>Time-out error occurs while downloading by the following case:</p> <ul style="list-style-type: none"> <li>• Disconnection of the connecting cable.</li> <li>• Stopped host</li> <li>• Incorrect time-out period.</li> </ul> <p>NS5: Time-out error occurs while downloading Host Allocated host: XXXX</p>	<p>The communications cable is not connected properly.</p> <p>The host communications service has stopped.</p> <p>The timeout monitor time is too short.</p>	<p>Check the cable connection and conduct a continuity test. Exchange the cable if there is a cable error. If necessary, rewire the cable.</p>
<p>Communication error detected while downloading by the following case:</p> <ul style="list-style-type: none"> <li>• Corrupted data by noise</li> <li>• Transmit error by the host</li> </ul> <p>General=0xXX, Additional=0xXX XXXX</p> <p>NS5: Communication error detected while downloading the data Allocated host: XXXX</p>	<p>Data corrupted by noise.</p> <p>Invalid host communications command.</p>	<p>Check the cable connection and conduct a continuity test. Exchange the cable if there is a cable error. If necessary, rewire the cable.</p>

Message	Cause	Possible countermeasure
<p>Addressing error exists in the screen, alarm, data log, or macro. Correct address setting by the CX-Designer.</p> <p>Screen No.: XXXX Allocation Host: XXXX Allocation Address: XXXX General=0xXX, Additional=0xXX XXXX</p> <p>NS5: Addressing error exists in the screen, alarm, data log or macro.</p> <p>Screen No.: XXXX Allocation Host: XXXX Allocation Address: XXXX General=0xXX, Additional=0xXX XXXX</p>	An illegal address is set.	Press the <b>OK</b> Button to go to the System Menu. Select Data Check to see whether the address is valid and the communications settings are correct. Use CX-Designer to change settings if necessary.
<p>Communication error detected while uploading by the following cases:</p> <p>Corrupted data by noise Transmit error by the host Allocation Host: XXXX</p> <p>NS5: Communication error detected while uploading the data Allocation Host: XXXX</p>	<p>Data corrupted by noise Invalid host communications command</p>	Check the cable connection and conduct a continuity test. Replace the cable if there is a cable error, or rewire the cable if necessary.
Failed to read host registration. Correct host registration with CX-Designer. Then, press OK and then download project data.	Project data cannot be downloaded (was not transmitted or is corrupted).	Use a Programming Device to repair the data and try to download it again.
<p>Time-out error occurred while writing by the following case:</p> <p>Disconnection of the connecting cable Stopped host_- Incorrect time-out period Allocation Host: XXXX Do you want to retry?</p> <p>NS5: Time-out error occurred while writing the data Allocation Host: XXXX Do you want to retry?</p>	<p>The communications cable is not properly connected. The host communications service has stopped. The timeout monitoring time is too short.</p>	Check the cable connection and conduct a continuity test. Replace the cable if there is a cable error, or rewire the cable if necessary.

Message	Cause	Possible countermeasure
<p>Time-out error occurred while writing due to the following: Disconnection of the connecting cable Stopped host_- Incorrect time-out period Allocation Host: XXXX Do you want to retry? NS5: Time-out error occurred while writing to the System Memory Area. Allocation Host: XXXX Do you want to retry?</p>	<p>The communications cable is not properly connected. The host communications service has stopped. The timeout monitoring time is too short.</p>	<p>Check the cable connection and conduct a continuity test. Replace the cable if there is a cable error, or rewire the cable if necessary.</p>
<p>Communication error detected while writing by the following case: Corrupted data by noise Transmit error by the host Allocation Host: XXXX Do you want to retry? NS5: Communication error detected while writing to the System Memory Area Allocation Host: XXXX Do you want to retry?</p>	<p>Data corrupted by noise Invalid host communications command</p>	<p>Check the cable connection and conduct a continuity test. Replace the cable if there is a cable error, or rewire the cable if necessary.</p>
<p>Communication error detected while writing by the following case: Corrupted data by noise Transmit error by the host Allocation Host: XXXX Do you want to retry? NS5: Communication error detected while writing to the System Memory Area. Allocation Host: XXXX Do you want to retry?</p>	<p>Data corrupted by noise Invalid host communications command</p>	<p>Check the cable connection and conduct a continuity test. Replace the cable if there is a cable error, or rewire the cable if necessary.</p>
<p>Addressing error exists in the screen, alarm, data log, or macro. Correct address setting by the CX-Designer. Screen No.: XXXX Allocation Host: XXXX Allocation Address: XXXX NS5: Addressing error exists in the screen, alarm, data log or macro. Screen No.: XXXX Allocation Host: XXXX Allocation Address: XXXX</p>	<p>The storage type of the number set for a functional object does not match the data type of the tag. Settings are made to monitor data that exceeds the maximum number of elements for an array variable.</p>	<p>Change the settings using the CX-Designer. Alternatively, change the host tag settings.</p>

## CIP Error Codes

General	Additional	Error	Possible countermeasure
0x01	0x01 0203	Communications error	Check the cable connections and test the cables for continuity. If there are any problems, replace the cable or connect a ground wire.
0x1F	0x02 0102 (Writing disabled.)	<ul style="list-style-type: none"> <li>The number of elements does not agree with the write data size.</li> <li>The write start address exceeds the range of the variable area.</li> <li>The write end position exceeds the range of the variable area.</li> </ul>	Confirm the range that can be processed and set the write operation within that range.
		<ul style="list-style-type: none"> <li>The relevant part of the EM Area has been converted to file memory.</li> <li>The specified EM Area bank does not exist.</li> <li>The variable type specification is not valid.</li> </ul>	Set the correct code, referring to information on the command variables and parameter type codes.
		<ul style="list-style-type: none"> <li>Write-protected words are included in the write area.</li> </ul>	If write protection is set with a switch, release the protection and execute the instruction again. Execution is not possible for read-only areas.
	0x02 0104 (Writing disabled.)	<ul style="list-style-type: none"> <li>FINS write protection is in effect.</li> </ul>	Clear protection from Support Software and execute the instruction again.
		<ul style="list-style-type: none"> <li>One of the specified EM Area banks does not exist.</li> <li>The relevant part of the EM Area has been converted to file memory.</li> </ul>	Set the correct code, referring to information on the command variables and parameter type codes.
		<ul style="list-style-type: none"> <li>The read start address exceeds the range of the variable area.</li> <li>The specified read exceeds the maximum value.</li> </ul>	Confirm the range that can be processed and set the read operation within that range.
0xFF	0x01 6008	Communications error	Check the communications settings in the Unit and set them to enable using Ethernet.



# Appendices

Appendix-1	Specifications.....	A-1
Appendix-2	List of Models.....	A-10
Appendix-3	PLC Memory Areas.....	A-12
Appendix-4	Addresses for Functional Objects.....	A-16
Appendix-5	Controller Link Network Status Read List .....	A-29
Appendix-6	Additional NS Series Functions.....	A-32

## Appendix-1 Specifications

### A-1-1 Display Specifications

Item	Specification
Functional objects	A total of 1,024 functional objects in frames or tables can be created for each screen. There are some functional objects, however, for which it is not possible to create more than one functional object for the same screen.
ON/OFF Buttons	<ul style="list-style-type: none"> <li>• Button shape Rectangle, circle, 2-light rectangle, select shape.</li> <li>• Button operation Momentary, alternate, SET, RESET.</li> </ul>
Word Buttons	<ul style="list-style-type: none"> <li>• Button type Rectangle, select shape.</li> <li>• Button operation Set value, increase/reduce value, display pop-up menu.</li> <li>• Numeral specifications Word, 2-word, real number</li> </ul>
Command Buttons	<ul style="list-style-type: none"> <li>• Button operation Screen switch, key button, pop-up screen control, System menu display, buzzer stop, no processing, Video control-Video capture, Video control-Contrast adjustment, Video control-Vision Sensor Console Output, Data Block Control, and Authentication cancellation</li> </ul>
Bit lamps	<ul style="list-style-type: none"> <li>• Lamp type: Single-line circle, single-line rectangle, double-line circle, double-line rectangle, specify shape.</li> </ul>
Word lamps	<ul style="list-style-type: none"> <li>• Lamp type: Single-line circle, single-line rectangle, double-line circle, double-line rectangle, specify shape.</li> <li>• Color change Up to 10 colors.</li> </ul>
Numeral display and input objects	<ul style="list-style-type: none"> <li>• No. of display digits Up to 25. Integer part: Up to 15 digits Decimal fraction part: Up to 10 digits.</li> <li>• (Decimal fraction display is available only when decimal display format has been selected and gradations have been set or when <i>Real number</i> has been selected for the storage format.)</li> <li>• Input method Keypad or Command Button.</li> </ul>
String display and input objects	<ul style="list-style-type: none"> <li>• Character display format ASCII code (Shift JIS), Unicode.</li> <li>• No. of characters Up to 256.</li> <li>• Input method Keypad, Command Button, bar code reader.</li> </ul>
Text objects	<ul style="list-style-type: none"> <li>• Fixed string display or indirect specification. (With indirect specification, either multibyte code or Unicode can be selected.)</li> <li>• No. of characters Up to 256.</li> <li>• Reference file format File name (8 characters) + .TXT</li> </ul>



Item	Specification
List selection objects	<ul style="list-style-type: none"> <li>• Reference file format File name (up to 8 characters) +.LST</li> <li>• Operations at list selection Display/no display of selected bar. Store selected line number to specified address. Store selected line character string to specified address.</li> <li>• Character display format ASCII code (Shift JIS), Unicode.</li> <li>• No. of characters per line Up to 256.</li> <li>• Maximum number of display lines 1,024.</li> </ul>
Thumbwheel switches	<ul style="list-style-type: none"> <li>• No. of displayable digits Integer part: Up to 15 digits Decimal fraction part: Up to 10 digits. (Decimal fraction input is enabled only when the display format is set to decimal and scaling is set, or when real number storage is set.)</li> <li>• Input method + and – Buttons.</li> </ul>
Analog meters	<ul style="list-style-type: none"> <li>• Display direction Up, down, left, right.</li> <li>• Incremental direction Clockwise, counterclockwise.</li> <li>• Shape Quarter circle, half circle, circle.</li> <li>• Display format Colored, needle.</li> <li>• Needle type Straight line, arrow, triangular arrow</li> <li>• Needle width 1 to 3 dots</li> </ul>
Level display objects	<ul style="list-style-type: none"> <li>• Display direction From bottom to top, top to bottom, right to left, left to right</li> <li>• Coloring 3 levels</li> </ul>
Broken-line graphs	<ul style="list-style-type: none"> <li>• No. of graph points per broken line Up to 1000.</li> <li>• No. of displayable graphs per broken-line graph Up to 256.</li> <li>• No. of graphs that can be registered per project Up to 16.</li> <li>• No. of graphs that can be registered per group Up to 256.</li> <li>• Amount of data that can be stored in log 300,000 bytes</li> </ul>
Bitmaps	<ul style="list-style-type: none"> <li>• Displayable file formats BMP, JPEG (RLE and progressive jpeg are not supported.)</li> </ul>
Alarm/Event display objects	<ul style="list-style-type: none"> <li>• Display format Fixed character, flowing text</li> <li>• Maximum number of display objects 5,000</li> </ul>
Alarm/Event summary and history objects	<ul style="list-style-type: none"> <li>• Display data Current alarms/events, alarm/event history.</li> <li>• Maximum number of display objects 2,048 (for histories).</li> </ul>
Date objects	<ul style="list-style-type: none"> <li>• Date displayed on PT (year, month, day)</li> <li>• Display format: 27 types.</li> </ul>

**NS Series Programming Manual**

Item	Specification
Time objects	<ul style="list-style-type: none"> <li>• Time displayed on PT (hour, minute, seconds)</li> <li>• Display format: 8 types.</li> </ul>
Data log graphs	<ul style="list-style-type: none"> <li>• No. of log points 1 to 50,000.</li> <li>• No. of data logs per project Up to 100 groups.</li> <li>• No. of logging points per project Up to 160,000 (NS5: 120,000 points)</li> <li>• No. of addresses that can be recorded to 1 group Up to 16.</li> <li>• No. of addresses for standard logging Up to 128.</li> <li>• Number of always logging points 50,000 max.</li> </ul>
Data Block Table	<ul style="list-style-type: none"> <li>• Maximum number of records Up to 1,000 lines</li> <li>• Maximum number of fields Up to 500 columns</li> <li>• Data Quantity for 1 Data Block 524,288 bytes</li> </ul>
Video Display	<ul style="list-style-type: none"> <li>• Maximum number of simultaneous display channels NS-CA001: 4ch (320x240 size only) NS-CA002: 1ch</li> <li>• Input method NTSC/PAL NS-CA001: NTSC/PAL NS-CA002: Analog RGB or NTSC/PAL</li> </ul>
Consecutive Line Drawing	<ul style="list-style-type: none"> <li>• Number of vertices Up to 128 points</li> </ul>
Multifunction Object	<ul style="list-style-type: none"> <li>• Shape Select Shape, Single-lined Circle, Single-lined Rectangle, Double-lined Circle, Double-lined Rectangle, Rectangle 2 Light, Polygon, Sector</li> <li>• Change Color/Shape Up to 16 types</li> </ul>
Contents Display	<ul style="list-style-type: none"> <li>• String, bmp file, jpg file (RLE-format bmp files and progressive jpeg are not supported).</li> <li>• No. of characters Up to 1,024. Line wrapping is possible.</li> </ul>
Graphic display (fixed)	<ul style="list-style-type: none"> <li>• Displayed at any position. Rectangle, circle, ellipse, line, polyline, polygon, sector, arc.</li> <li>• Up to 2,048 graphic displays can be created per screen.</li> </ul>
Frames	<ul style="list-style-type: none"> <li>• Up to 10 can be created per screen.</li> <li>• Up to 256 functional objects can be created per frame page. However, a limit of 1,024 functional object per screen applies, and this may restrict the number of objects per frame.</li> </ul>
Tables	<ul style="list-style-type: none"> <li>• No. of tables Any number of tables can be created, as long as the total number of functional objects per screen does not exceed 1,024.</li> <li>• Horizontal Up to 30 columns.</li> <li>• Vertical Up to 40 lines.</li> <li>• No. of functional objects per table Up to 256.</li> </ul>
Libraries	<ul style="list-style-type: none"> <li>• Up to 4,096 libraries can be registered.</li> </ul>

**NS Series Programming Manual**

Item	Specification
User screens	<ul style="list-style-type: none"> <li>• Up to 4,000 screens, including base and pop-up screens, can be created per project.</li> <li>• Up to 3 pop-up screens can be overlapped.</li> </ul>
Sheets	<ul style="list-style-type: none"> <li>• Up to 32 sheets can be created per project.</li> <li>• Up to 10 sheets can be set for layered display on standard screens.</li> <li>• Up to 1,024 functional objects, including those inside frames and tables, can be created per sheet. Up to 2,048 graphic displays can be created per sheet.</li> </ul>
No. of label switches	<ul style="list-style-type: none"> <li>• Up to 16.</li> </ul>
Background screen files	<ul style="list-style-type: none"> <li>• Displayable file formats BMP, JPEG (RLE-format bmp files and progressive jpeg are not supported.)</li> </ul>
Background colors	256
Project registration method	Transfer from CX-Designer <i>Data transfer</i> (under <i>File/Data transfer</i> ) to PT. <ul style="list-style-type: none"> <li>• PT - Transfer - Transfer [To PT]</li> <li>• PT - Transfer - Quick Transfer [To PT]</li> <li>• PT - Transfer - Transfer Program</li> </ul>

**Note**

- ◆ With project data versions lower than 8.0, a maximum total of 1,024 objects (including functional objects, frames, tables, and graphic displays) can be created per screen.

### A-1-2 Specifications for Display Elements

Display element	Specifications																				
Characters	Raster font/Vector font Scalable font/7-segment font Raster font																				
	<table border="1"> <thead> <tr> <th>Font name</th> <th>Characters that can be displayed</th> <th>Base sizes</th> <th>Magnification</th> </tr> </thead> <tbody> <tr> <td>Rough</td> <td>Half-width alphanumerics, Katakana, Greek, Coptic, Cyrillic</td> <td>8x8</td> <td>1x1, 1x2, 2x1, 2x2, 3x3, 4x4, 8x8</td> </tr> <tr> <td>Standard</td> <td>Half-width alphanumerics, Katakana, full-width JIS1 and JIS2 standard characters, Greek, Coptic, Cyrillic, Korean, simplified Chinese</td> <td>8x16, 16x16</td> <td>1x1, 1x2, 2x1, 2x2, 3x3, 4x4, 8x8</td> </tr> <tr> <td>Fine</td> <td>Half-width alphanumerics, Katakana, full-width JIS1 and JIS2 standard characters, Greek, Coptic, Cyrillic</td> <td>16x32, 32x32</td> <td>1x1, 1x2, 2x1, 2x2, 3x3, 4x4, 8x8</td> </tr> <tr> <td>Gothic numeral</td> <td>0 to 9, A to F, +, -, decimal point, comma, space, and colon</td> <td>---</td> <td>8x16, 16x32, 24x48, 32x64, 48x96, 64x128</td> </tr> </tbody> </table>	Font name	Characters that can be displayed	Base sizes	Magnification	Rough	Half-width alphanumerics, Katakana, Greek, Coptic, Cyrillic	8x8	1x1, 1x2, 2x1, 2x2, 3x3, 4x4, 8x8	Standard	Half-width alphanumerics, Katakana, full-width JIS1 and JIS2 standard characters, Greek, Coptic, Cyrillic, Korean, simplified Chinese	8x16, 16x16	1x1, 1x2, 2x1, 2x2, 3x3, 4x4, 8x8	Fine	Half-width alphanumerics, Katakana, full-width JIS1 and JIS2 standard characters, Greek, Coptic, Cyrillic	16x32, 32x32	1x1, 1x2, 2x1, 2x2, 3x3, 4x4, 8x8	Gothic numeral	0 to 9, A to F, +, -, decimal point, comma, space, and colon	---	8x16, 16x32, 24x48, 32x64, 48x96, 64x128
	Font name	Characters that can be displayed	Base sizes	Magnification																	
	Rough	Half-width alphanumerics, Katakana, Greek, Coptic, Cyrillic	8x8	1x1, 1x2, 2x1, 2x2, 3x3, 4x4, 8x8																	
	Standard	Half-width alphanumerics, Katakana, full-width JIS1 and JIS2 standard characters, Greek, Coptic, Cyrillic, Korean, simplified Chinese	8x16, 16x16	1x1, 1x2, 2x1, 2x2, 3x3, 4x4, 8x8																	
	Fine	Half-width alphanumerics, Katakana, full-width JIS1 and JIS2 standard characters, Greek, Coptic, Cyrillic	16x32, 32x32	1x1, 1x2, 2x1, 2x2, 3x3, 4x4, 8x8																	
	Gothic numeral	0 to 9, A to F, +, -, decimal point, comma, space, and colon	---	8x16, 16x32, 24x48, 32x64, 48x96, 64x128																	
	Vector font All fonts, types, and sizes that can be specified o for CX-Designer can be displayed.																				
	Scalable Font																				
	<table border="1"> <thead> <tr> <th>Font</th> <th>Size</th> <th>Magnification</th> </tr> </thead> <tbody> <tr> <td>Scalable Gothic</td> <td>6 to 255 pixels</td> <td>50% to 200%</td> </tr> </tbody> </table>	Font	Size	Magnification	Scalable Gothic	6 to 255 pixels	50% to 200%														
Font	Size	Magnification																			
Scalable Gothic	6 to 255 pixels	50% to 200%																			
7-segment Font																					
<table border="1"> <tbody> <tr> <td>7-segment numeral</td> <td>8x14, 12x21, 16x27, 20x34, 24x41, 32x54, 48x82, 64x108, 80x135, 96x161, 112x188, 128x216, 160x269, 200x336</td> </tr> </tbody> </table>	7-segment numeral	8x14, 12x21, 16x27, 20x34, 24x41, 32x54, 48x82, 64x108, 80x135, 96x161, 112x188, 128x216, 160x269, 200x336																			
7-segment numeral	8x14, 12x21, 16x27, 20x34, 24x41, 32x54, 48x82, 64x108, 80x135, 96x161, 112x188, 128x216, 160x269, 200x336																				
Numerals 0 to 9, characters A to F, the plus and minus signs (+ and -), periods (.), commas (,), spaces ( ) and colon (: ) can be displayed on the 7-segment display.																					
Text attributes	<ul style="list-style-type: none"> <li>• Colors 256</li> <li>• Font style (only when vector fonts are specified.) Bold, italics</li> <li>• Vertical position Top, center, bottom</li> <li>• Horizontal position Left-aligned, center, right-aligned</li> </ul>																				
Flicker	<p>Objects for which flicker can be set: Functional Objects and Fixed Objects</p> <p>Flicker settings: Up to 10 objects can be registered per screen. The flicker method, speed, and range can be set.</p> <p>Flicker method: Select one of the following three options. Invert color display. Display/hide whole object or label string. Specify flicker color (text color, background color, or line color).</p> <p>Functional Object: Select under flicker settings.</p> <p>Fixed Object: Select from flicker settings or select from one of three types for each Fixed Object (Select flicker speed. The flicker range is set to the whole object.)</p>																				
Unit and scale settings	Up to 1,000.																				
Alarm/event settings	Up to 5,000.																				
Display colors	Up to 256. (Up to 32,000 with BMP or JPEG. Up to 4,096 for the NS5.)																				

**NS Series Programming Manual**

Display element	Specifications	
Numeral display and storage formats	Numeral display format	
	Format	Details
	Decimal	BCD and real number storage formats can be specified. Word:     –32768 to 32767 (signed) 0 to 65535 (unsigned) 2-word:   –2147483648 to 2147483647 (signed) 0 to 4294967295 (unsigned)
	Hexadecimal	BCD and real number storage formats cannot be specified. Word:     0 to FFFF (unsigned) 2-word:   0 to FFFFFFFF (unsigned)
	Binary	BCD and real number storage formats cannot be specified. Word:     0 to 1111111111111111 (unsigned) 2-word:   0 to 11111111111111111111111111111111 (unsigned)
	Octal	BCD and real number storage formats cannot be specified. Word:     0 to 177777 (unsigned) 2-word:   0 to 3777777777 (unsigned)
	Storage format	
	Format	Details
	INT (1-word signed)	Stores the data as a 2-byte integer at the write destination address. (–32,768 to 32,767 in decimal)
	UNIT (1-word unsigned)	Stores the data as a 2-byte integer at the write destination address. (0 to 65,535 in decimal)
	DINT (2-word signed)	Stores the data as a 4-byte integer at the write destination address. (–2147483648 to 2147483647 in decimal)
	UDINT (2-word unsigned)	Stores the data as a 4-byte integer at the write destination address. (0 to 4294967295 in decimal)
	REAL (real number)	Stores the data as a 4-byte real number at the write destination address. (Can be set in decimal between approximately $\pm 1.175494351 \times 10^{-38}$ and approximately $\pm 3.402823466 \times 10^{+38}$ (7 digits enabled)). 4-byte real numbers that conform to IEEE754.
	BCD1 (1-word signed, most significant digit: F)	Stores the data as 2-byte BCD at the write destination address. Negative value when most significant digit is F. (–999 to 9,999 in decimal)
	BCD1 (2-word signed, most significant digit: F)	Stores the data as 4-byte BCD at the write destination address. Negative value when most significant digit is F. (–9999999 to 99999999 in decimal)
	BCD2 (1-word signed, most significant bit))	Stores the data as 2-byte BCD at the write destination address. Negative value when most significant digit is 1. (–7,999 to 7,999 in decimal)
	BCD2 (1-word unsigned)	Stores the data as 2-byte BCD at the write destination address. (0 to 9,999 in decimal)
	BCD2 (1-word unsigned)	Stores the data as 2-byte BCD at the write destination address. (0 to 9,999 in decimal)
	BCD2 (1-word unsigned)	Stores the data as 2-byte BCD at the write destination address. (0 to 9,999 in decimal)
	BCD2 (2-word signed, most significant bit))	Stores the data as 4-byte BCD at the write destination address. Negative value when most significant digit is 1. (–79,999,999 to 79,999,999 in decimal)
	BCD2 (2-word unsigned)	Stores the data as 4-byte BCD at the write destination address. (0 to 99999999 in decimal)

**NS Series Programming Manual**

Display element	Specifications																																																																																																				
Date and time format	Display item	Display format																																																																																																			
	Date display	<p>yyyy: year (4 digits);                      yy: year (2 digits)                      mm: month; dd: day of month                      ddd: day of the week (1 character, e.g., S)                      dddd: day of the week (3 characters, e.g., Sat)</p> <table border="0"> <tr> <td data-bbox="641 474 1018 501">Display formats</td> <td data-bbox="1024 474 1423 501">Display examples</td> </tr> <tr> <td>yyyy[JY]mm[JM]dd[JD] dddd</td> <td>2000年06月17日 土曜日</td> </tr> <tr> <td>yy[JY]mm[JM]dd[JD] dddd</td> <td>00年06月17日 土曜日</td> </tr> <tr> <td>yyyy[JY]mm[JM]dd[JD] (dddd)</td> <td>2000年06月17日 (土曜日)</td> </tr> <tr> <td>yy[JY]mm[JM]dd[JD] (dddd)</td> <td>00年06月17日 (土曜日)</td> </tr> <tr> <td>yyyy[JY]mm[JM]dd[JD]</td> <td>2000年06月17日</td> </tr> <tr> <td>yy[JY]mm[JM]dd[JD]</td> <td>00年06月17日</td> </tr> <tr> <td>yyyy mm dd ddd</td> <td>2000 06 17 Sat</td> </tr> <tr> <td>yy mm dd ddd</td> <td>00 06 17 Sat</td> </tr> <tr> <td>yyyy mm dd (ddd)</td> <td>2000 06 17 (Sat)</td> </tr> <tr> <td>yy mm dd (ddd)</td> <td>00 06 17 (Sat)</td> </tr> <tr> <td>yyyy mm dd</td> <td>2000 06 17</td> </tr> <tr> <td>yy mm dd</td> <td>00 06 17</td> </tr> <tr> <td>yyyy/mm/dd ddd</td> <td>2000/06/17 Sat</td> </tr> <tr> <td>yy/mm/dd ddd</td> <td>00/06/17 Sat</td> </tr> <tr> <td>yyyy/mm/dd (ddd)</td> <td>2000/06/17 (Sat)</td> </tr> <tr> <td>yy/mm/dd (ddd)</td> <td>00/06/17 (Sat)</td> </tr> <tr> <td>yyyy/mm/dd</td> <td>2000/06/17</td> </tr> <tr> <td>yy/mm/dd</td> <td>00/06/17</td> </tr> <tr> <td>ddd mm/dd/yyyy</td> <td>S 06/17/2000</td> </tr> <tr> <td>ddd mm/dd/yy</td> <td>S 06/17/00</td> </tr> <tr> <td>(ddd) mm/dd/yyyy</td> <td>(S) 06/17/2000</td> </tr> <tr> <td>(ddd) mm/dd/yy</td> <td>(S) 06/17/00</td> </tr> <tr> <td>yyyy.mm.dd ddd</td> <td>2000.06.17 Saturday</td> </tr> <tr> <td>yy.mm.dd ddd</td> <td>00.06.17 Saturday</td> </tr> <tr> <td>yyyy.mm.dd (ddd)</td> <td>2000.06.17 (Saturday)</td> </tr> <tr> <td>yy.mm.dd (ddd)</td> <td>00.06.17 (Saturday)</td> </tr> <tr> <td>yyyy.mm.dd</td> <td>2000.06.17</td> </tr> <tr> <td>yy.mm.dd</td> <td>00.06.17</td> </tr> <tr> <td>ddd mm.dd.yyyy</td> <td>S 06.17.2000</td> </tr> <tr> <td>(ddd) mm.dd.yyyy</td> <td>S 06.17.00</td> </tr> <tr> <td>(ddd) mm.dd.yy</td> <td>(S) 06.17.2000</td> </tr> <tr> <td>yyyy-mm-dd</td> <td>(S) 06.17.00</td> </tr> <tr> <td>mm/dd/yyyy</td> <td>2000-06-17</td> </tr> <tr> <td>mm/dd/yy</td> <td>02/23/2001</td> </tr> <tr> <td>DDD,MMMM dd,yyyy</td> <td>02/23/01</td> </tr> <tr> <td>MMMM dd,yyyy</td> <td>Fri,February 23,2001</td> </tr> <tr> <td>DDD,MMM dd,yy</td> <td>February 23,2001</td> </tr> <tr> <td>MMM dd,yy</td> <td>Fri,Feb 23,01</td> </tr> <tr> <td>dd/mm/yyyy</td> <td>Feb 23,01</td> </tr> <tr> <td>dd/mm/yy</td> <td>23/02/2001</td> </tr> <tr> <td>DDD/dd/mm/yyyy</td> <td>23/02/01</td> </tr> <tr> <td>DDD/dd/mm/yy</td> <td>Fri/23/02/2001</td> </tr> <tr> <td>DDD,dd MMMM,yyyy</td> <td>Fri/23/02/01</td> </tr> <tr> <td>Dd MMMM,yyyy</td> <td>Fri,23 February,2001</td> </tr> <tr> <td>DDD,dd MM,yy</td> <td>23 February,2001</td> </tr> <tr> <td>dd MMM,yy</td> <td>Fri,23 Feb,01</td> </tr> <tr> <td>dd.mm.yy</td> <td>23 Feb.01</td> </tr> <tr> <td>DDD.dd.mm.yy</td> <td>23.02.01</td> </tr> <tr> <td>DDD.dd.mm.yy</td> <td>Fri.23.02.01</td> </tr> </table>	Display formats	Display examples	yyyy[JY]mm[JM]dd[JD] dddd	2000年06月17日 土曜日	yy[JY]mm[JM]dd[JD] dddd	00年06月17日 土曜日	yyyy[JY]mm[JM]dd[JD] (dddd)	2000年06月17日 (土曜日)	yy[JY]mm[JM]dd[JD] (dddd)	00年06月17日 (土曜日)	yyyy[JY]mm[JM]dd[JD]	2000年06月17日	yy[JY]mm[JM]dd[JD]	00年06月17日	yyyy mm dd ddd	2000 06 17 Sat	yy mm dd ddd	00 06 17 Sat	yyyy mm dd (ddd)	2000 06 17 (Sat)	yy mm dd (ddd)	00 06 17 (Sat)	yyyy mm dd	2000 06 17	yy mm dd	00 06 17	yyyy/mm/dd ddd	2000/06/17 Sat	yy/mm/dd ddd	00/06/17 Sat	yyyy/mm/dd (ddd)	2000/06/17 (Sat)	yy/mm/dd (ddd)	00/06/17 (Sat)	yyyy/mm/dd	2000/06/17	yy/mm/dd	00/06/17	ddd mm/dd/yyyy	S 06/17/2000	ddd mm/dd/yy	S 06/17/00	(ddd) mm/dd/yyyy	(S) 06/17/2000	(ddd) mm/dd/yy	(S) 06/17/00	yyyy.mm.dd ddd	2000.06.17 Saturday	yy.mm.dd ddd	00.06.17 Saturday	yyyy.mm.dd (ddd)	2000.06.17 (Saturday)	yy.mm.dd (ddd)	00.06.17 (Saturday)	yyyy.mm.dd	2000.06.17	yy.mm.dd	00.06.17	ddd mm.dd.yyyy	S 06.17.2000	(ddd) mm.dd.yyyy	S 06.17.00	(ddd) mm.dd.yy	(S) 06.17.2000	yyyy-mm-dd	(S) 06.17.00	mm/dd/yyyy	2000-06-17	mm/dd/yy	02/23/2001	DDD,MMMM dd,yyyy	02/23/01	MMMM dd,yyyy	Fri,February 23,2001	DDD,MMM dd,yy	February 23,2001	MMM dd,yy	Fri,Feb 23,01	dd/mm/yyyy	Feb 23,01	dd/mm/yy	23/02/2001	DDD/dd/mm/yyyy	23/02/01	DDD/dd/mm/yy	Fri/23/02/2001	DDD,dd MMMM,yyyy	Fri/23/02/01	Dd MMMM,yyyy	Fri,23 February,2001	DDD,dd MM,yy	23 February,2001	dd MMM,yy	Fri,23 Feb,01	dd.mm.yy	23 Feb.01	DDD.dd.mm.yy	23.02.01	DDD.dd.mm.yy
Display formats	Display examples																																																																																																				
yyyy[JY]mm[JM]dd[JD] dddd	2000年06月17日 土曜日																																																																																																				
yy[JY]mm[JM]dd[JD] dddd	00年06月17日 土曜日																																																																																																				
yyyy[JY]mm[JM]dd[JD] (dddd)	2000年06月17日 (土曜日)																																																																																																				
yy[JY]mm[JM]dd[JD] (dddd)	00年06月17日 (土曜日)																																																																																																				
yyyy[JY]mm[JM]dd[JD]	2000年06月17日																																																																																																				
yy[JY]mm[JM]dd[JD]	00年06月17日																																																																																																				
yyyy mm dd ddd	2000 06 17 Sat																																																																																																				
yy mm dd ddd	00 06 17 Sat																																																																																																				
yyyy mm dd (ddd)	2000 06 17 (Sat)																																																																																																				
yy mm dd (ddd)	00 06 17 (Sat)																																																																																																				
yyyy mm dd	2000 06 17																																																																																																				
yy mm dd	00 06 17																																																																																																				
yyyy/mm/dd ddd	2000/06/17 Sat																																																																																																				
yy/mm/dd ddd	00/06/17 Sat																																																																																																				
yyyy/mm/dd (ddd)	2000/06/17 (Sat)																																																																																																				
yy/mm/dd (ddd)	00/06/17 (Sat)																																																																																																				
yyyy/mm/dd	2000/06/17																																																																																																				
yy/mm/dd	00/06/17																																																																																																				
ddd mm/dd/yyyy	S 06/17/2000																																																																																																				
ddd mm/dd/yy	S 06/17/00																																																																																																				
(ddd) mm/dd/yyyy	(S) 06/17/2000																																																																																																				
(ddd) mm/dd/yy	(S) 06/17/00																																																																																																				
yyyy.mm.dd ddd	2000.06.17 Saturday																																																																																																				
yy.mm.dd ddd	00.06.17 Saturday																																																																																																				
yyyy.mm.dd (ddd)	2000.06.17 (Saturday)																																																																																																				
yy.mm.dd (ddd)	00.06.17 (Saturday)																																																																																																				
yyyy.mm.dd	2000.06.17																																																																																																				
yy.mm.dd	00.06.17																																																																																																				
ddd mm.dd.yyyy	S 06.17.2000																																																																																																				
(ddd) mm.dd.yyyy	S 06.17.00																																																																																																				
(ddd) mm.dd.yy	(S) 06.17.2000																																																																																																				
yyyy-mm-dd	(S) 06.17.00																																																																																																				
mm/dd/yyyy	2000-06-17																																																																																																				
mm/dd/yy	02/23/2001																																																																																																				
DDD,MMMM dd,yyyy	02/23/01																																																																																																				
MMMM dd,yyyy	Fri,February 23,2001																																																																																																				
DDD,MMM dd,yy	February 23,2001																																																																																																				
MMM dd,yy	Fri,Feb 23,01																																																																																																				
dd/mm/yyyy	Feb 23,01																																																																																																				
dd/mm/yy	23/02/2001																																																																																																				
DDD/dd/mm/yyyy	23/02/01																																																																																																				
DDD/dd/mm/yy	Fri/23/02/2001																																																																																																				
DDD,dd MMMM,yyyy	Fri/23/02/01																																																																																																				
Dd MMMM,yyyy	Fri,23 February,2001																																																																																																				
DDD,dd MM,yy	23 February,2001																																																																																																				
dd MMM,yy	Fri,23 Feb,01																																																																																																				
dd.mm.yy	23 Feb.01																																																																																																				
DDD.dd.mm.yy	23.02.01																																																																																																				
DDD.dd.mm.yy	Fri.23.02.01																																																																																																				

**NS Series Programming Manual**

Display element	Specifications	
	Display Time	Display format hh: hour, mm: minutes, ss: seconds, xxxx: a.m./p.m. Display formats xxxx hh[Jh]mm[Jm]ss[Js] xxxx hh[Jh]mm[Jm] hh[Jh]mm[Jm]ss[Js] hh[Jh]mm[Jm] hh mm ss xxxx hh mm xxxx hh mm ss hh mm hh:mm:ss xxxx hh:mm xxxx hh:mm:ss hh:mm
Write settings	Up to 200 messages	

### A-1-3 Special Functions

Setting		Specifications
Buzzer sound		<ul style="list-style-type: none"> <li>• Three types (continuous, short intermittent, long intermittent) The type of buzzer sound is controlled at system memory bits \$SB12 to \$SB14.</li> <li>• Press the Command Button with the <i>Buzzer stop</i> function to stop the buzzer. Alternatively, turn OFF system memory bits \$SB12 to \$SB14.</li> <li>• Settings under System Menu <i>PT Operation Settings Screen/CX-Designer system settings</i>.                      ON: Buzzer sounds when \$SB12 to \$SB14 turn ON or when an error occurs. When an error message or other x or ! dialog boxes are displayed.                      OFF: Buzzer does not sound.                      ERR ON: Buzzer sounds when an error occurs. When an error message or other x or ! dialog boxes are displayed.</li> </ul>
Key press sound		<ul style="list-style-type: none"> <li>• Settings under System Menu <i>PT Operation Settings Screen/CX-Designer system settings</i>.                      ON: Input sound when functional object that receives PT input is pressed.                      OFF: No input sound even when functional object that receives PT input is pressed.</li> </ul>
Maintenance function		<ul style="list-style-type: none"> <li>• All settings status monitor function The status of all settings can be checked from the System Menu Screen.</li> <li>• Communications test function Communications can be tested by performing simple communications.</li> <li>• Data initialization Data saved to the PT can be initialized from the System Menu.</li> <li>• Operation log/error log/alarm/event history/data log display The record settings and data for all kinds of log data can be displayed.</li> <li>• Registered Screen test display function Registered screens can be displayed and checked from the System Menu.</li> <li>• Hardware check Hardware can be checked.</li> </ul>
Battery back up		<ul style="list-style-type: none"> <li>• Operation log/error log/alarm/event history/data log back up</li> <li>• Calendar clock settings back up.</li> <li>• Battery life: 5 years (25°C)</li> <li>• At voltage drop: Orange RUN indicator</li> </ul>
Calendar clock function		<ul style="list-style-type: none"> <li>• Current date and time display based on internal clock.</li> <li>• Display and settings using System Menu <i>PT Operation Settings Screen/CX-Designer Date/Time Object</i>.</li> <li>• Maximum monthly margin at normal error temperature (25°C) is -39 to +65 seconds.</li> </ul>
Device monitor function		Can connect to CPM2A, CPM2C, CQM1, CQM1H, C200HS, C200HX/HG/HE-E/-ZE, CS1G/CS1H, CS1G/CS1H-H, CJ1G, CJ1M, CJ2H, and CJ2M PLCs and switch operation modes and display or change current word contents.
Video configuration		Image adjustments for Video Input Unit. Vision Sensor Console outputs.
Transfer function	System program transfer	Downloads/uploads from CX-Designer (computer) or Memory Card.
	Screen data transfer	Downloads/uploads from CX-Designer (computer) or Memory Card.
History save function		Saves operation log, error log, alarm, event history, or data log data to Memory Card.
Printing function		Screen hardcopies The printing method and compatible printers can be selected.
PLC Data Trace		Reads the data from a CS/CJ-series PLC's trace memory and displays the data as a time chart. This function can also set the data trace parameters.
Device data transfer		Data can be transferred from the transfer source to the transfer destination under specified conditions.



## Appendix-2 List of Models

### A-2-1 PT Models

Model	LCD				Ethernet	Body Color
	Type	Size	Color	No. of dots		
NS15-TX01S	TFT	15.0 inches	Color	1024 x 768	10/100Base-T	Silver
NS15-TX01B	TFT	15.0 inches	Color	1024 x 768	10/100Base-T	Black
NS12-TS01-V1	TFT	12.1 inches	Color	800 x 600	10/100Base-T	Ivory
NS12-TS01B-V1	TFT	12.1 inches	Color	800 x 600	10/100Base-T	Black
NS12-TS00-V1	TFT	12.1 inches	Color	800 x 600	None	Ivory
NS12-TS00B-V1	TFT	12.1 inches	Color	800 x 600	None	Black
NS12-TS01-V2 (See note 3.)	TFT	12.1 inches	Color	800 x 600	10/100Base-T	Ivory
NS12-TS01B-V2 (See note 3.)	TFT	12.1 inches	Color	800 x 600	10/100Base-T	Black
NS12-TS00-V2 (See note 3.)	TFT	12.1 inches	Color	800 x 600	None	Ivory
NS12-TS00B-V2 (See note 3.)	TFT	12.1 inches	Color	800 x 600	None	Black
NS10-TV01-V1	TFT	10.4 inches	Color	640 x 480	10/100Base-T	Ivory
NS10-TV01B-V1	TFT	10.4 inches	Color	640 x 480	10/100Base-T	Black
NS10-TV00-V1	TFT	10.4 inches	Color	640 x 480	None	Ivory
NS10-TV00B-V1	TFT	10.4 inches	Color	640 x 480	None	Black
NS10-TV01-V2 (See note 3.)	TFT	10.4 inches	Color	640 x 480	10/100Base-T	Ivory
NS10-TV01B-V2 (See note 3.)	TFT	10.4 inches	Color	640 x 480	10/100Base-T	Black
NS10-TV00-V2 (See note 3.)	TFT	10.4 inches	Color	640 x 480	None	Ivory
NS10-TV00B-V2 (See note 3.)	TFT	10.4 inches	Color	640 x 480	None	Black
NS8-TV01-V1 (See note 1.)	TFT	8.0 inches	Color	640 x 480	10/100Base-T	Ivory
NS8-TV01B-V1 (See note 1.)	TFT	8.0 inches	Color	640 x 480	10/100Base-T	Black
NS8-TV11-V1 (See note 1.)	TFT	8.0 inches	Color	640 x 480	10/100Base-T	Ivory
NS8-TV11B-V1 (See note 1.)	TFT	8.0 inches	Color	640 x 480	10/100Base-T	Black
NS8-TV00-V1 (See note 1.)	TFT	8.0 inches	Color	640 x 480	None	Ivory
NS8-TV00B-V1 (See note 1.)	TFT	8.0 inches	Color	640 x 480	None	Black
NS8-TV10-V1 (See note 1.)	TFT	8.0 inches	Color	640 x 480	None	Ivory
NS8-TV10B-V1 (See note 1.)	TFT	8.0 inches	Color	640 x 480	None	Black
NS8-TV01-V2 (See note 3.)	TFT	8.4 inches	Color	640 x 480	10/100Base-T	Ivory
NS8-TV01B-V2 (See note 3.)	TFT	8.4 inches	Color	640 x 480	10/100Base-T	Black
NS8-TV00-V2 (See note 3.)	TFT	8.4 inches	Color	640 x 480	None	Ivory
NS8-TV00B-V2 (See note 3.)	TFT	8.4 inches	Color	640 x 480	None	Black
NS5-SQ01-V1 (See note 2.)	STN	5.7 inches	Color	320 x 240	10/100Base-T	Ivory
NS5-SQ01B-V1 (See note 2.)	STN	5.7 inches	Color	320 x 240	10/100Base-T	Black
NS5-SQ00-V1 (See note 2.)	STN	5.7 inches	Color	320 x 240	None	Ivory
NS5-SQ00B-V1 (See note 2.)	STN	5.7 inches	Color	320 x 240	None	Black
NS5-SQ01-V2 (See note 2.)	STN	5.7 inches	Color	320 x 240	10/100Base-T	Ivory
NS5-SQ01B-V2 (See note 2.)	STN	5.7 inches	Color	320 x 240	10/100Base-T	Black
NS5-SQ00-V2 (See note 2.)	STN	5.7 inches	Color	320 x 240	None	Ivory
NS5-SQ00B-V2 (See note 2.)	STN	5.7 inches	Color	320 x 240	None	Black
NS5-SQ11-V2 (See notes 3 and 4.)	TFT	5.7 inches	Color	320 x 240	10/100Base-T	Ivory
NS5-SQ11B-V2 (See notes 3 and 4.)	TFT	5.7 inches	Color	320 x 240	10/100Base-T	Black
NS5-SQ10-V2 (See notes 3 and 4.)	TFT	5.7 inches	Color	320 x 240	None	Ivory
NS5-SQ10B-V2 (See notes 3 and 4.)	TFT	5.7 inches	Color	320 x 240	None	Black
NS5-TQ01-V2 (See note 2.)	TFT	5.7 inches	Color	320 x 240	10/100Base-T	Ivory
NS5-TQ01B-V2 (See note 2.)	TFT	5.7 inches	Color	320 x 240	10/100Base-T	Black
NS5-TQ00-V2 (See note 2.)	TFT	5.7 inches	Color	320 x 240	None	Ivory
NS5-TQ00B-V2 (See note 2.)	TFT	5.7 inches	Color	320 x 240	None	Black
NS5-TQ11-V2 (See note 3.)	TFT	5.7 inches	Color	320 x 240	10/100Base-T	Ivory
NS5-TQ11B-V2 (See note 3.)	TFT	5.7 inches	Color	320 x 240	10/100Base-T	Black
NS5-TQ10-V2 (See note 3.)	TFT	5.7 inches	Color	320 x 240	None	Ivory
NS5-TQ10B-V2 (See note 3.)	TFT	5.7 inches	Color	320 x 240	None	Black
NS5-MQ01-V2 (See note 2.)	STN	5.7 inches	Monochrome	320 x 240	10/100Base-T	Ivory
NS5-MQ01B-V2 (See note 2.)	STN	5.7 inches	Monochrome	320 x 240	10/100Base-T	Black
NS5-MQ00-V2 (See note 2.)	STN	5.7 inches	Monochrome	320 x 240	None	Ivory

**NS Series Programming Manual**

Model	LCD				Ethernet	Body Color
	Type	Size	Color	No. of dots		
NS5-MQ00B-V2 (See note 2.)	STN	5.7 inches	Monochrome	320 × 240	None	Black
NS5-MQ11-V2 (See note 3.)	STN	5.7 inches	Monochrome	320 × 240	10/100Base-T	Ivory
NS5-MQ11B-V2 (See note 3.)	STN	5.7 inches	Monochrome	320 × 240	10/100Base-T	Black
NS5-MQ10-V2 (See note 3.)	STN	5.7 inches	Monochrome	320 × 240	None	Ivory
NS5-MQ10B-V2 (See note 3.)	STN	5.7 inches	Monochrome	320 × 240	None	Black

Note 1: The data capacity for NS8-TV00(B)-V1 and NS8-TV01(B)-V1 PTs is 6 MB. The data capacity for NS8-TV10(B)-V1 and NS8-TV11(B)-V1 PTs is 20 MB.

Note 2: The data capacity for NS5-SQ00(B)-V1 and NS5-SQ01(B)-V1 PTs is 6 MB. The data capacity for NS5-□□0□(B)-V2 PT is 20 MB.

Note 3: The data capacity for NS15-V2, NS8-V2, NS10-V2, NS12-V2, and NS5-□□1□-V2 is 60 MB.

Note 4: The specifications for NS5-SQ1□-V2 PTs with lot number 2110 or earlier are given below.

Item	Specification
Display panel	Color STN LCD
Display colors	256 colors (4,096 colors for BMP/JPEG images)
View angle	Left: 50°, Right: 50°, Top: 45°, Bottom: 50°

## Appendix-3 PLC Memory Areas

### A-3-1 OMRON C-series PLC Memory Areas (Same for 1:1 and 1:N NT Links)

PLC model	Data area (CIO)	Holding area (HR)	AR area (AR)	Link area (LR)	Timer/counter present value (TIM/CNT)	Data memory area (DM)	EM Area (Current bank) (EM)	
C200HS	00000 to 00511	00000 to 00099	00000 to 00027	00000 to 00063	00000 to 00511	00000 to 06655 07000 to 09999	---	
C200HE-E/-ZE C200HG-E/-ZE C200HX-E/-ZE							00000 to 06143 (See note 1.)	
CQM1 (See note 2.)	00000 to 00255	00000 to 00099	00000 to 00027	00000 to 00063	00000 to 00511	00000 to 06655 (See note 1.)	---	
CQM1H							00000 to 06143 (See note 1.)	
CPM1A	00000 to 00019 00200 to 00255	00000 to 00019	00000 to 00015	00000 to 00015	00000 to 00127	00000 to 01023	---	
CPM2A	00000 to 00049		00000 to 00023		00000 to 00255	00000 to 00255		00000 to 02047
CPM2C (See note 2.)	00200 to 00255							06144 to 06655

Note 1. The memory areas that can be used depend on the model of the CPU Unit  
 2. CQM1, CPM2A, and CPM2C PLCs only support 1:1 NT Link communications.

### A-3-2 OMRON CVM1 and CV-series PLC Memory Areas

For 1:1 NT Links

PLC model	Data area (CIO)	Holding area (HR)	AR area (AR)	Link area (LR)	Timer/counter present value (TIM/CNT)	Data memory area (DM)	EM Area (Current bank) (EM)
CV500 CVM1-CPU01-V□	00000 to 02555	---	00000 to 00511	---	00000 to 00511	00000 to 08191	---
CVM1-CPU11-V□	00000 to 02555	---	00000 to 00511	---	00000 to 01023	00000 to 24575	---
CV1000 CV2000 CVM1-CPU21-V□	00000 to 02555	---	00000 to 00511	---	00000 to 01023	00000 to 24575	00000 to 32765

CVM1 and CV-series PLCs only support 1:1 NT Link communications.

**NS Series Programming Manual**

**A-3-3 OMRON CS-series CS1G, CS1H, CS1G-H, and CS1H-H PLC Memory Areas**

For 1:N NT Links

PLC model	Data area (CIO)	Holding area (HR)	Auxiliary area (AR) (See note 1.)	Link area (LR) (See note 2.)	Timer/counter present value (TIM/CNT)	Data memory area (DM)	EM area (EM, EM0 to EMC) (See note 5.)
CS1G CS1H CS1G-H CS1H-H CS1D	00000 to 06143	00000 to 00511	00000 to 00959	00000 to 00199	00000 to 04095	00000 to 32767	00000 to 32767
	<b>Work area (WR)</b>	<b>Task flags (TK) (See note 3.)</b>	<b>Timer completion flags (TU) (See note 4.)</b>	<b>Counter completion flags (CU) (See note 4.)</b>			
	00000 to 00511	---	00000 to 04095	00000 to 04095			

CS1G, CS1H, CS1G-H, and CS1H-H PLCs only support 1:N NT Link communications.

- Note
1. For CS1G, CS1H, CS1G-H, and CS1H-H PLCs, AR00000 to AR00447 is a read-only area.
  2. CS1G, CS1H, CS1G-H, and CS1H-H PLCs do not have an LR area, but if the screen data uses the LR area, this will be automatically converted internally to CIO01000 to CIO01199 in the CIO area.
  3. Task flags cannot be used with PTs.
  4. These areas cannot be set as the allocated addresses for system memory \$SB or \$SW. Communications cannot be performed simultaneously for 63 or more points. If 64 or more points are set, a communications (settings) error will occur during operation. These areas cannot be used by READCMEM or WRITECMEM macros. These areas cannot be set to ON/OFF Buttons or other objects that write bit data. These areas can be set only to bit lamps and other objects that read bit data.
  5. Specify a bank for the data area when setting a bit address in the EM. If the data area is specified using the current bank, the ON/OFF function may not be able to be used correctly, depending on the status of other bits in the EM area for the same word number.

### A-3-4 OMRON CJ-series CJ1G, CJ1G/H-H, CJ1M, and CJ2H PLC Memory Areas

For 1:N NT Links

PLC model	Data area (CIO)	Holding area (HR)	Auxiliary area (AR) (See note 1.)	Link area (LR) (See note 2.)	Timer/counter present value (TIM/CNT)	DM area (DM)	EM area (EM, EM0 to EM18) (See note 6.)
CJ1G CJ1G-H CJ1H-H CJ1M CJ2H	00000 to 06143	00000 to 00511	00000 to 00959 00960 to 01471 10000 to 11535	00000 to 00199	00000 to 04095	00000 to 32767	00000 to 32767 (See note 5.)
	<b>Work area (WR)</b>	<b>Task flags (TK) (See note 3.)</b>	<b>Timer completion flags (TU) (See note 4.)</b>	<b>Counter completion flags (CU) (See note 4.)</b>			
	00000 to 00511	---	00000 to 04095	00000 to 04095			

CJ1G, CJ1G/H-H, and CJ1M PLCs support only 1:N NT Link communications.

- Note
- AR00000 to AR01471 and AR10000 to AR11535 can be read or written in CJ2 PLCs. For other PLCs, AR00000 to AR00959 can be read or written and AR00000 to AR00447 and AR10000 to AR11535 are read only.
  - CJ1G, CJ1G-H, CJ1H, CJ1H-H, and CJ1M PLCs do not have an LR area, but if the screen data uses the LR area, this will be automatically converted internally to CIO 01000 to CIO 01199 in the CIO area.
  - Task flags cannot be used with PTs.
  - These areas cannot be set as the allocated addresses for system memory \$SB or \$SW. Communications cannot be performed simultaneously for 63 or more points. If 64 or more points are set, a communications (settings) error will occur during operation. These areas cannot be used by READCMEM or WRITECMEM macros. These areas cannot be set to ON/OFF Buttons or other objects that write bit data. These areas can be set only to bit lamps and other objects that read bit data.
  - CJ1M PLCs do not have an EM area.
  - Specify a bank for the data area when setting a bit address in the EM. If the data area is specified using the current bank, the ON/OFF function may not be able to be used correctly, depending on the status of other bits in the EM area for the same word number.

### A-3-5 List of Areas with Bit Access

Symbol	C-series PLCs	Allocation	CVM1/CV-series PLCs	Allocation	CS/CJ-series PLCs	Allocation
None	I/O area	OK	I/O area	OK	I/O area	OK
H	Holding area	OK	---	--	Holding area	OK
A	AR Area	OK	Auxiliary Area	No	Auxiliary Area	OK
L	LR area	OK	---	--	LR area (See note 1.)	OK
T	Timer present values	No	Timer present values	No	Timer present values	No
TU	---	--	---	---	Timer completion flags	No
C	Counter present values	No	Counter present values	No	Counter present values	No
CU	---	--	---	--	Counter completion flags	No
W	---	--	---	--	Work area	OK
TK	---	--	---	--	Task flags	No
D	DM area	No	DM area	No	DM area	OK
E	EM area (See note 2.) (Current bank)	No	EM area (Current bank)	No	EM area (Current bank)	OK
E0_	---	--	---	--	EM area Bank 0	OK
	---	--	---	---		
E18_	---	--	---	--	EM area Bank 18	OK

- Note 1. LR 00000 to LR 00199 are converted to and used as I/O area words CIO 01000 to CIO 01199.  
 2. The EM area (EM) is supported only for C200HX/HG/HE-E/-ZE PLCs in the C Series.

## Appendix-4 Addresses for Functional Objects

### A-4-1 Using Direct Addresses

The following table shows the types of addresses that can be set for functional objects.

- B: Bit
- W: Word
- L: 32-bit data

If data is written to a bit for an address for which only W or L can be set, all other bits will be set to 0.

Refer to Appendix 3 for information on the PLC addresses that can be used.

Functional object	Tab page name	Set address	B	W	L
ON/OFF Buttons	General	Write address	OK	No	No
		Display address 1	OK	No	No
		Display address 2	OK	No	No
	Color/Shape	Color 1 (OFF color) (See note.)	No	OK	No
		Color 2 (ON color) (See note.)	No	OK	No
		Color 3	No	OK	No
		Color 4	No	OK	No
	Label	Switch label specification	OK	No	No
		Indirect specification of label character color	No	OK	No
	Frame	Indirect specification of frame ON/OFF	OK	No	No
	Flicker	Flicker specification	OK	No	No
	Control Flag	Input enabled/disabled flags	OK	No	No
		Display/no display flags	OK	No	No
Word Buttons	General	Write address	No	OK	OK
		Indirect write value specification	No	OK	OK
		Indirect increment/decrement specification	No	OK	OK
	Color/Shape	Indirect specification of normal background color	No	OK	No
		Indirect specification of background color when object is pressed	No	OK	No
	Label	Indirect specification of label character color	No	OK	No
	Frame	Indirect specification of frame ON/OFF	OK	No	No
	Upper/lower Limits	Indirect specification of upper limit	No	OK	OK
		Indirect specification of lower limit	No	OK	OK
	Flicker	Flicker specification	OK	No	No
	Write Settings	Write notification address	OK	No	No
	Control Flag	Input enabled/disabled flags	OK	No	No
		Display/no display flags	OK	No	No
Command Buttons	General	Indirect specification of screen switch page	No	OK	No
		Switch screen page notification address	No	OK	No
		String source address	No	OK	No
	Color/Shape	Indirect background color specification	No	OK	No
	Label	Indirect specification of label character color	No	OK	No
	Flicker	Flicker specification	OK	No	No
	Control Flag	Input enabled/disabled flags	OK	No	No
		Display/no display flags	OK	No	No

Note: The address name in parentheses ( ) is the name when Rectangle Simple (Type 1), Rectangle Simple (Type 2-1), Rectangle Simple (Type 2-2), Circle Simple (Type 1), Circle Simple (Type 2-1), or Circle Simple (Type 2-2) are selected as the button type.

**NS Series Programming Manual**

Functional object	Tab page name	Set address	B	W	L
Bit lamps	General	Display address	OK	No	No
	Color/Shape	Indirect specification of background color when ON	No	OK	No
		Indirect specification of background color when OFF	No	OK	No
	Label	Indirect specification of label character color	No	OK	No
	Flicker	Flicker specification	OK	No	No
Control Flag	Display/no display flags	OK	No	No	
Word lamps	General	Display address	No	OK	No
	Color/Shape	Indirect specification of background color when 0	No	OK	No
		Indirect specification of background color when 1	No	OK	No
		Indirect specification of background color when 2	No	OK	No
		Indirect specification of background color when 3	No	OK	No
		Indirect specification of background color when 4	No	OK	No
		Indirect specification of background color when 5	No	OK	No
		Indirect specification of background color when 6	No	OK	No
		Indirect specification of background color when 7	No	OK	No
		Indirect specification of background color when 8	No	OK	No
	Indirect specification of background color when 9	No	OK	No	
	Label	Indirect specification of label character color	No	OK	No
	Flicker	Flicker specification	OK	No	No
	Control Flag	Display/no display flags	OK	No	No
Text objects	Background	Indirect background color specification	No	OK	No
	Label	Indirect specification of label character color	No	OK	No
		Indirect specification of label string file line	No	OK	No
		Indirect reference to string number	No	OK	No
	Message	Address for switching status	No	OK	No
	Frame	Indirect specification of frame ON/OFF	OK	No	No
	Flicker	Flicker specification	OK	No	No
Control Flag	Display/no display flags	OK	No	No	
Numeral display & input objects	General	Communications address	No	OK	OK
		Indirect specification of units/scale number	No	OK	No
	Text Attributes	Indirect specification of numeral/character color	No	OK	No
	Background	Indirect background color specification	No	OK	No
	Frame	Indirect specification of frame ON/OFF	OK	No	No
	Input Upper and Lower Limits	Indirect specification of input upper limit	No	OK	OK
		Indirect specification of input lower limit	No	OK	OK
	Limit Monitor	Indirect specification of upper limit monitoring	No	OK	OK
		Indirect specification of lower limit monitoring	No	OK	OK
	Flicker	Flicker specification	OK	No	No
	Write Settings	Write notification address	OK	No	No
	Control Flag	Input enabled/disabled flags	OK	No	No
		Display/no display flags (all)	OK	No	No
Display/no display flags (numerals)		OK	No	No	
String display & input objects	General	String start address	No	OK	No
	Text Attributes	Indirect character color specification	No	OK	No
	Background	Indirect background color specification	No	OK	No
	Frame	Indirect specification of frame ON/OFF	OK	No	No
	Flicker	Flicker specification	OK	No	No



**NS Series Programming Manual**

Functional object	Tab page name	Set address	B	W	L
String display & input objects	Write Settings	Write notification address	OK	No	No
	Control Flag	Input enabled/disabled flags	OK	No	No
		Display/no display flags	OK	No	No
List selection objects	General	List data address	No	OK	No
		Indirect file line specification	No	OK	No
	Background	Indirect background color specification	No	OK	No
	Selection Operation	Selection line number address	No	OK	No
		Selection line string address	No	OK	No
	Frame	Indirect specification of frame ON/OFF	OK	No	No
	Flicker	Flicker specification	OK	No	No
	Control Flag	Input enabled/disabled flags	OK	No	No
		Display/no display flags	OK	No	No
	External Control	Display block number specification address	No	OK	No
		Address specifying display start line	No	OK	No
List re-display specification		OK	No	No	
Thumbwheel switches	General	Communications address	No	OK	OK
	Text Attributes	Indirect specification of numeral/character color	No	OK	No
	Background	Indirect background color specification	No	OK	No
	Upper/lower Limits	Indirect specification of input upper limit	No	OK	OK
		Indirect specification of input lower limit	No	OK	OK
	Flicker	Flicker specification	OK	No	No
	Write Settings	Write notification address	OK	No	No
	Control Flag	Input enabled/disabled flags	OK	No	No
Display/no display flags		OK	No	No	
Analog meters	General	Communications address	No	OK	OK
	Border	Indirect specification of border value (maximum)	No	OK	OK
		Indirect specification of border value (delimiter 1)	No	OK	OK
		Indirect specification of border value (delimiter 2)	No	OK	OK
		Indirect specification of border value (minimum)	No	OK	OK
	Color	Indirect specification of range 1 color	No	OK	No
		Indirect specification of range 2 color	No	OK	No
		Indirect specification of range 3 color	No	OK	No
	Background	Indirect background color specification	No	OK	No
		Indirect specification of range 1 background color	No	OK	No
		Indirect specification of range 2 background color	No	OK	No
		Indirect specification of range 3 background color	No	OK	No
	Flicker	Flicker specification	OK	No	No
Control Flag	Display/no display flags	OK	No	No	
Level meters	General	Communications address	No	OK	OK
	Border	Indirect specification of border value (maximum)	No	OK	OK
		Indirect specification of border value (delimiter 1)	No	OK	OK
		Indirect specification of border value (delimiter 2)	No	OK	OK
		Indirect specification of border value (minimum)	No	OK	OK
	Color	Indirect specification of range 1 color	No	OK	No
		Indirect specification of range 2 color	No	OK	No
		Indirect specification of range 3 color	No	OK	No

Functional object	Tab page name	Set address	B	W	L
Level display objects	Frame	Indirect specification of frame ON/OFF	OK	No	No
	Background	Indirect background color specification	No	OK	No
		Indirect specification of range 1 background color	No	OK	No
		Indirect specification of range 2 background color	No	OK	No
		Indirect specification of range 3 background color	No	OK	No
	Flicker	Flicker specification	OK	No	No
Control Flag	Display/no display flags	OK	No	No	
Broken-line Graphs	General	Display refresh bit	OK	No	No
		No. of display-enabled points	No	OK	No
		Indirect specification of scale line display/hide setting	OK	No	No
	Graph	Graph data	OK	OK	OK
		Indirect specification of number of graph points	No	OK	No
		Indirect specification of display start position	No	OK	No
		Indirect specification of maximum graph data value	OK	OK	OK
		Indirect specification of minimum graph data value	OK	OK	OK
	Background	Indirect background color specification	No	OK	No
	Flicker	Flicker specification	OK	No	No
	Control Flag	Input enabled/disabled flags	OK	No	No
		Display/no display flags	OK	No	No
	Bitmaps	General	Address for indirect specification of display file	No	OK
Frame		Indirect specification of frame ON/OFF	OK	No	No
Flicker		Flicker specification	OK	No	No
Control Flag		Display/no display flags	OK	No	No
Alarm/event display objects	General	Alarm/event data	OK	No	No
		Alarm and event information	OK	OK	No
	Flowing Text	Specification of flowing text display start	OK	No	No
	Background	Indirect background color specification	No	OK	No
	Frame	Indirect specification of frame ON/OFF	OK	No	No
	Flicker	Flicker specification	OK	No	No
	Control Flag	Input enabled/disabled flags	OK	No	No
		Display/no display flags	OK	No	No
Alarm/event summary and history objects	General	Selected alarm ID write address	No	OK	No
		Alarm/event data	OK	No	No
		Alarm information	OK	OK	No
	Background	Indirect background color specification	No	OK	No
	Frame	Indirect specification of frame ON/OFF	OK	No	No
	Flicker	Flicker specification	OK	No	No
	Control Flag	Input enabled/disabled flags	OK	No	No
		Display/no display flags	OK	No	No
Date objects	Background	Indirect background color specification	No	OK	No
	Frame	Indirect specification of frame ON/OFF	OK	No	No
	Flicker	Flicker specification	OK	No	No
	Control Flag	Input enabled/disabled flags	OK	No	No
		Display/no display flags	OK	No	No
Time objects	Background	Indirect background color specification	No	OK	No
	Frame	Indirect specification of frame ON/OFF	OK	No	No
	Flicker	Flicker specification	OK	No	No
	Control Flag	Input enabled/disabled flags	OK	No	No
		Display/no display flags	OK	No	No

**NS Series Programming Manual**

Functional object	Tab page name	Set address	B	W	L	
Data log graphs	General	Graph data	OK	OK	OK	
		Indirect specification of maximum graph data value	OK	OK	OK	
		Indirect specification of minimum graph data value	OK	OK	OK	
	Display	Indirect specification of time axis	No	OK	No	
		Time axis data destination	No	OK	No	
		Time axis data enable/disable bit	OK	No	No	
		Display refresh notification	OK	No	No	
		Scroll seconds specification	No	OK	No	
		Time data transmission destination	No	OK	No	
	Background	Indirect background color specification	No	OK	No	
	Flicker	Flicker specification	OK	No	No	
Control Flag	Input enabled/disabled flags	OK	No	No		
	Display/no display flags	OK	No	No		
Frame objects	General	Frame page number	No	OK	No	
	Control Flag	Input enabled/disabled flags	OK	No	No	
		Display/no display flags	OK	No	No	
Data block tables	General	Specify interlock (Data Prohibition Flag)	OK	No	No	
		Indirect reference of maximum limit for numeral field	No	OK	OK	
		Indirect reference of minimum limit for numeral field	No	OK	OK	
		Address for numeral field	No	OK	OK	
		Address for string field	No	OK	OK	
	Text Attribute	Indirect specification of text colors	No	OK	No	
	Write Setting	Write notification address	OK	No	No	
	Control Flag	Input enable/disable flag	OK	No	No	
Display enable/disable flag		OK	No	No		
Consecutive Line Drawing	General	Indirect specification of color	No	OK	No	
		Indirect specification of the number of vertices	No	OK	No	
		Starting address of the X-Y coordinates data	No	OK	No	
Multifunction Object	General	Input	OK	No	No	
		Perform an action when a value changed	OK	OK	No	
		Write bit	OK	No	No	
		Write word	No	OK	OK	
		Write string	No	OK	No	
		Switch screen	No	OK	No	
		Key Buttons	No	OK	No	
		Data Block Control	No	OK	No	
		Contents Control	No	OK	No	
		Macro	OK	OK	OK	
	Color/Shape	Display Address 1	OK	OK	OK	
		Display Address 2	OK	No	No	
		Indirect Reference for Color	No	OK	No	
		Display/hide	OK	No	No	
	Label	Switch labels	OK	OK	No	
		Indirect Reference for Text Color	No	OK	No	
	Flicker	Flicker specification	OK	No	No	
	Contents Display	Frame	Indirect reference for frame ON/OFF.	OK	No	No
		Flicker	Flicker specification	OK	No	No
		Control Flag	Display/hide flag	OK	No	No

**Note**

- ◆ When using direct addresses, NS-series PLCs treat communications addresses set to any data type other than BOOL as if they were set to CHANNEL. (CHANNEL stands for word data.) Data types other than BOOL and CHANNEL are used for compatibility with the CX-Programmer symbol table.

### A-4-2 Using Tags

The data types for tags that can be set for functional objects (including arrays) are shown in the following table.

- B (bit):                BOOL
- W (1 word):         CHANNEL, INT, UINT, UINT\_BCD, WORD
- D (2 words) h:     DINT, UDINT, REAL, UDINT\_BCD, DWORD
- S (text string):    STRING

Functional object	Tab page name	Set address	B	W	D	S
ON/OFF Buttons	General	Write address	OK	No	No	No
		Display address 1	OK	No	No	No
		Display address 2	OK	No	No	No
	Color/Shape	Color 1 (OFF color)	No	OK	No	No
		Color 2 (ON color)	No	OK	No	No
		Color 3	No	OK	No	No
		Color 4	No	OK	No	No
	Label	Switch label specification	OK	No	No	No
		Indirect specification of label character color	No	OK	No	No
	Frame	Indirect specification of frame ON/OFF	OK	No	No	No
	Flicker	Flicker specification	OK	No	No	No
	Control Flag	Input enabled/disabled flags	OK	No	No	No
		Display/no display flags	OK	No	No	No
	Word Buttons	General	Write address	No	OK (See note 1.)	OK (See note 1.)
Indirect write value specification			No	OK (See note 1.)	OK (See note 1.)	No
Indirect increment/decrement specification			No	OK (See note 1.)	OK (See note 1.)	No
Color/Shape		Indirect specification of normal background color	No	OK	No	No
		Indirect specification of background color when object is pressed	No	OK	No	No
Label		Indirect specification of label character color	No	OK	No	No
Frame		Indirect specification of frame ON/OFF	OK	No	No	No
Upper/lower Limits		Indirect specification of upper limit	No	OK (See note 1.)	OK (See note 1.)	No
		Indirect specification of lower limit	No	OK (See note 1.)	OK (See note 1.)	No
Flicker		Flicker specification	OK	No	No	No
Write Settings		Write notification address	OK	No	No	No
Control Flag		Input enabled/disabled flags	OK	No	No	No
		Display/no display flags	OK	No	No	No
Command Buttons		General	Indirect specification of screen switch page	No	OK	No
	Switch screen page notification address		No	OK	No	No
	String source address		No	OK (See note 2.)	No	OK
	Indirect specification of data block number		No	OK	No	No
	Indirect specification of the record number		No	OK	No	No
	Specification of address when the final record is read		OK	No	No	No

**NS Series Programming Manual**

Functional object	Tab page name	Set address	B	W	D	S
Command Buttons	General	Indirect specification of the file location	OK	No	No	No
		Indirect specification of the record method	OK	No	No	No
		Executed when the specified address changes from OFF to ON	OK	No	No	No
	Color/Shape	Indirect background color specification	No	OK	No	No
	Label	Indirect specification of label character color	No	OK	No	No
	Flicker	Flicker specification	OK	No	No	No
	Control Flag	Input enabled/disabled flags	OK	No	No	No
		Display/no display flags	OK	No	No	No
Bit lamps	General	Display address	OK	No	No	No
	Color/Shape	Indirect specification of background color when ON	No	OK	No	No
		Indirect specification of background color when OFF	No	OK	No	No
	Label	Indirect specification of label character color	No	OK	No	No
	Flicker	Flicker specification	OK	No	No	No
	Control Flag	Display/no display flags	OK	No	No	No
Word lamps	General	Display address	No	OK	No	No
	Color/Shape	Indirect specification of background color when 0	No	OK	No	No
		Indirect specification of background color when 1	No	OK	No	No
		Indirect specification of background color when 2	No	OK	No	No
		Indirect specification of background color when 3	No	OK	No	No
		Indirect specification of background color when 4	No	OK	No	No
		Indirect specification of background color when 5	No	OK	No	No
		Indirect specification of background color when 6	No	OK	No	No
		Indirect specification of background color when 7	No	OK	No	No
		Indirect specification of background color when 8	No	OK	No	No
		Indirect specification of background color when 9	No	OK	No	No
	Label	Indirect specification of label character color	No	OK	No	No
	Flicker	Flicker specification	OK	No	No	No
	Control Flag	Display/no display flags	OK	No	No	No
Label objects	Background	Indirect background color specification	No	OK	No	No
	Label	Indirect specification of label character color	No	OK	No	No
		Indirect specification of label string file line	No	OK	No	No
	Message	Address for switching status	No	OK	No	No
	Frame	Indirect specification of frame ON/OFF	OK	No	No	No
	Flicker	Flicker specification	OK	No	No	No
	Control Flag	Display/no display flags	OK	No	No	No
Numeral display & input objects	General	Communications address	No	OK (See note 1.)	OK (See note 1.)	No
		Indirect specification of units/scale number	No	OK	No	No
	Text Attributes	Indirect specification of numeral/character color	No	OK	No	No
	Background	Indirect background color specification	No	OK	No	No
	Frame	Indirect specification of frame ON/OFF	OK	No	No	No
	Input Upper and Lower Limits	Indirect specification of input upper limit	No	OK (See note 1.)	OK (See note 1.)	No
		Indirect specification of input lower limit	No	OK (See note 1.)	OK (See note 1.)	No

**NS Series Programming Manual**

Functional object	Tab page name	Set address	B	W	D	S
Numeral display & input objects	Limit Monitor	Indirect specification of upper limit monitoring	No	OK (See note 1.)	OK (See note 1.)	No
		Indirect specification of lower limit monitoring	No	OK (See note 1.)	OK (See note 1.)	No
	Flicker	Flicker specification	OK	No	No	No
	Write Settings	Write notification address	OK	No	No	No
	Control Flag	Input enabled/disabled flags	OK	No	No	No
		Display/no display flags (all)	OK	No	No	No
Display/no display flags (numerals)		OK	No	No	No	
String display & input objects	General	String start address	No	OK (See note 2.)	No	OK
	Text Attributes	Indirect character color specification	No	OK	No	No
	Background	Indirect background color specification	No	OK	No	No
	Frame	Indirect specification of frame ON/OFF	OK	No	No	No
	Flicker	Flicker specification	OK	No	No	No
	Write Settings	Write notification address	OK	No	No	No
	Control Flag	Input enabled/disabled flags	OK	No	No	No
		Display/no display flags	OK	No	No	No
List selection objects	General	List data address	No	No	No	No
		Indirect file line specification	No	OK	No	No
	Background	Indirect background color specification	No	OK	No	No
	Selection Operation	Selection line number address	No	OK	No	No
		Selection line string address	No	OK (See note 2.)	No	OK
	Frame	Indirect specification of frame ON/OFF	OK	No	No	No
	Flicker	Flicker specification	OK	No	No	No
	Control Flag	Input enabled/disabled flags	OK	No	No	No
		Display/no display flags	OK	No	No	No
	External Control	Display block number specification address	No	OK	No	No
Address specifying display start line		No	OK	No	No	
List re-display specification		OK	No	No	No	
Thumbwheel switches	General	Communications address	No	OK (See note 1.)	OK (See note 1.)	No
	Text Attributes	Indirect specification of numeral/character color	No	OK	No	No
	Background	Indirect background color specification	No	OK	No	No
	Upper/lower Limits	Indirect specification of input upper limit	No	OK (See note 1.)	OK (See note 1.)	No
		Indirect specification of input lower limit	No	OK (See note 1.)	OK (See note 1.)	No
	Flicker	Flicker specification	OK	No	No	No
	Write Settings	Write notification address	OK	No	No	No
	Control Flag	Input enabled/disabled flags	OK	No	No	No
Display/no display flags		OK	No	No	No	

**NS Series Programming Manual**

Functional object	Tab page name	Set address	B	W	D	S	
Analog meters	General	Communications address	No	OK (See note 1.)	OK (See note 1.)	No	
	Border	Indirect specification of border value (maximum)	No	OK (See note 1.)	OK (See note 1.)	No	
		Indirect specification of border value (delimiter 1)	No	OK (See note 1.)	OK (See note 1.)	No	
		Indirect specification of border value (delimiter 2)	No	OK (See note 1.)	OK (See note 1.)	No	
		Indirect specification of border value (minimum)	No	OK (See note 1.)	OK (See note 1.)	No	
	Color	Indirect specification of range 1 color	No	OK	No	No	
		Indirect specification of range 2 color	No	OK	No	No	
		Indirect specification of range 3 color	No	OK	No	No	
	Background	Indirect background color specification	No	OK	No	No	
		Indirect specification of range 1 background color	No	OK	No	No	
		Indirect specification of range 2 background color	No	OK	No	No	
		Indirect specification of range 3 background color	No	OK	No	No	
	Flicker	Flicker specification	OK	No	No	No	
	Control Flag	Display/no display flags	OK	No	No	No	
	Level meters	General	Communications address	No	OK (See note 1.)	OK (See note 1.)	No
		Border	Indirect specification of border value (maximum)	No	OK (See note 1.)	OK (See note 1.)	No
			Indirect specification of border value (delimiter 1)	No	OK (See note 1.)	OK (See note 1.)	No
Indirect specification of border value (delimiter 2)			No	OK (See note 1.)	OK (See note 1.)	No	
Indirect specification of border value (minimum)			No	OK (See note 1.)	OK (See note 1.)	No	
Color		Indirect specification of range 1 color	No	OK	No	No	
		Indirect specification of range 2 color	No	OK	No	No	
		Indirect specification of range 3 color	No	OK	No	No	
Frame		Indirect specification of frame ON/OFF	OK	No	No	No	
Background		Indirect background color specification	No	OK	No	No	
		Indirect specification of range 1 background color	No	OK	No	No	
		Indirect specification of range 2 background color	No	OK	No	No	
		Indirect specification of range 3 background color	No	OK	No	No	
Flicker		Flicker specification	OK	No	No	No	
Control Flag		Display/no display flags	OK	No	No	No	
Broken-line Graphs		General	Display refresh bit	OK	No	No	No
			No. of display-enabled points	No	OK	No	No
	Graph	Graph data	OK	OK (See note 1.) (See note 2.)	OK (See note 1.) (See note 2.)	No	



**NS Series Programming Manual**

Functional object	Tab page name	Set address	B	W	D	S
Broken-line Graphs	Graph	Indirect specification of number of graph points	No	OK	No	No
		Indirect specification of maximum graph data value	OK	OK (See note 1.)	OK (See note 1.)	No
		Indirect specification of minimum graph data value	OK	OK (See note 1.)	OK (See note 1.)	No
	Background	Indirect background color specification	No	OK	No	No
	Flicker	Flicker specification	OK	No	No	No
	Control Flag	Input enabled/disabled flags	OK	No	No	No
Display/no display flags		OK	No	No	No	
Bitmaps	General	Address for indirect specification of display file	No	OK	No	No
	Frame	Indirect specification of frame ON/OFF	OK	No	No	No
	Flicker	Flicker specification	OK	No	No	No
	Control Flag	Display/no display flags	OK	No	No	No
Alarm/event display objects	General	Alarm/event data	OK	No	No	No
		Alarm and event information	OK	OK	No	No
	Flowing Text	Specification of flowing text display start	OK	No	No	No
	Background	Indirect background color specification	No	OK	No	No
	Frame	Indirect specification of frame ON/OFF	OK	No	No	No
	Flicker	Flicker specification	OK	No	No	No
	Control Flag	Input enabled/disabled flags	OK	No	No	No
		Display/no display flags	OK	No	No	No
Alarm/event summary and history objects	General	Selected alarm ID write address	No	OK	No	No
		Alarm/event data	OK	No	No	No
		Alarm information	OK	OK	No	No
	Background	Indirect background color specification	No	OK	No	No
	Frame	Indirect specification of frame ON/OFF	OK	No	No	No
	Flicker	Flicker specification	OK	No	No	No
	Control Flag	Input enabled/disabled flags	OK	No	No	No
		Display/no display flags	OK	No	No	No
Date objects	Background	Indirect background color specification	No	OK	No	No
	Frame	Indirect specification of frame ON/OFF	OK	No	No	No
	Flicker	Flicker specification	OK	No	No	No
	Control Flag	Input enabled/disabled flags	OK	No	No	No
		Display/no display flags	OK	No	No	No
Time objects	Background	Indirect background color specification	No	OK	No	No
	Frame	Indirect specification of frame ON/OFF	OK	No	No	No
	Flicker	Flicker specification	OK	No	No	No
	Control Flag	Input enabled/disabled flags	OK	No	No	No
		Display/no display flags	OK	No	No	No
Data log graphs	General	Graph data	OK	OK (See note 1.)	OK (See note 1.)	No
		Indirect specification of maximum graph data value	OK	OK (See note 1.)	OK (See note 1.)	No
		Indirect specification of minimum graph data value	OK	OK (See note 1.)	OK (See note 1.)	No

**NS Series Programming Manual**

Functional object	Tab page name	Set address	B	W	D	S
Data log graphs	Display	Indirect specification of time axis	No	OK	No	No
		Time axis data destination	No	No	No	No
		Time axis data enable/disable bit	OK	No	No	No
		Display refresh notification	OK	No	No	No
		Scroll seconds specification	No	OK	No	No
		Time data transmission destination	No	OK (See note 2.)	No	No
	Background	Indirect background color specification	No	OK	No	No
	Flicker	Flicker specification	OK	No	No	No
	Control Flag	Input enabled/disabled flags	OK	No	No	No
		Display/no display flags	OK	No	No	No
Frame objects	General	Frame page number	No	OK	No	No
	Control Flag	Input enabled/disabled flags	OK	No	No	No
		Display/no display flags	OK	No	No	No
Data block tables	General	Address for numeral field	No	OK (See note 1.)	OK (See note 1.)	No
		Indirect reference of maximum limit for numeral field	No	OK (See note 1.)	OK (See note 1.)	No
		Indirect reference of minimum limit for numeral field	No	OK (See note 1.)	OK (See note 1.)	No
		Address for string field	No	OK (See note 2.)	No	OK
		Specify interlock	OK	No	No	No
	Text Attribute	Indirect specification of text colors	No	OK	No	No
	Write Setting	Write notification address	OK	No	No	No
	Control Flag	Input enable/disable flag	OK	No	No	No
		Display enable/disable flag	OK	No	No	No
	Consecutive Line Drawing	General	Indirect specification of color	No	OK	No
Indirect specification of the number of vertices			No	OK	No	No
Starting address of the X-Y coordinates data			No	OK (See note 2.)	No	No
Multifunction Object	General	Input	OK	No	No	No
		Perform an action when a bit value changes	OK	No	No	No
		Perform an action when a word value changes	No	OK	No	No
		Write bit	OK	No	No	No
		Write word – write address	No	OK (See note 1.)	OK (See note 1.)	No
		Write word – indirect specification of value	No	OK (See note 1.)	OK (See note 1.)	No
		Write word – indirect specification of upper limit	No	OK (See note 1.)	OK (See note 1.)	No
		Write word – indirect specification of upper limit	No	OK (See note 1.)	OK (See note 1.)	No
		Write string	No	OK (See note 2.)	No	OK

**NS Series Programming Manual**

Functional object	Tab page name	Set address	B	W	D	S	
Multifunction Object	General	Indirect specification of the switch screen page	No	OK	No	No	
		Switch screen page notification address	No	OK	No	No	
		Key Buttons – string source address	No	OK (See note 2.)	No	OK	
		Indirect specification of data block number	No	OK	No	No	
		Indirect specification of the record number	No	OK	No	No	
		Specification of address when the final record is read	OK	No	No	No	
		Indirect specification of the file location	OK	No	No	No	
		Indirect specification of the record method	OK	No	No	No	
		Executed when the specified address changes from OFF to ON	OK	No	No	No	
		Switch to the indirect reference contents number	No	OK	No	No	
		Macro	OK	OK	OK	OK	
	Color/Shape	Display Address 1	OK	OK (See note 1.)	OK (See note 1.)	No	
		Display Address 2	OK	No	No	No	
		Indirect specification of set value	OK	No	No	No	
		Indirect Reference for Color	No	OK	No	No	
		Display/hide	OK	No	No	No	
		Label	Switch labels	OK	OK	No	No
	Indirect Reference for Text Color		No	OK	No	No	
	Contents Display	General	Contents switching address	No	OK	No	No
			Specified switching address	OK	No	No	No
Frame		Indirect reference for frame ON/OFF.	OK	No	No	No	
Flicker		Flicker specification	OK	No	No	No	
Control Flag		Display/hide flag	OK	No	No	No	

- Note 1. Set the same data type as is used for the storage type of the functional object, or set a tag with a CHANNEL type. For information on data types for storage types, refer to 2-8-4 Numeral Display and Storage Type (General Tab).
2. Can only be set for array variables.

**Note**

- ◆ The ULINT, LINT, ULINT\_BCD, LREAL, and LWORD data types can be set for tags. However, tags that are set using these data types cannot be used for functional objects. They can be used only for READCMEM or WRITECMEM macros.

## Appendix-5 Controller Link Network Status Read List

First read address (n)	Bits	Status	Details
n	0 to 7	Error information	Not used.
	8		1: Node address setting range error
	9		1: Duplicated node address
	10		1: Inconsistent network parameters
	11		1: Hardware error
	12		1: Communications controller send section error
	13		Not used.
	14		Not used.
	15		1: Error log exists
n+1	0 to 7	Startup/polling node address	1: Startup node address
	8 to 15		1: Polling node address
n+2	0	Network participation status	Node 1
	1		Node 2
	2		Node 3
	3		Node 4
	4		Node 5
	5		Node 6
	6		Node 7
	7		Node 8
	8		Node 9
	9		Node 10
	10		Node 11
	11		Node 12
	12		Node 13
	13		Node 14
	14		Node 15
	15		Node 16
n+3	0	Network participation status	Node 17
	1		Node 18
	2		Node 19
	3		Node 20
	4		Node 21
	5		Node 22
	6		Node 23
	7		Node 24
	8		Node 25
	9		Node 26
	10		Node 27
	11		Node 28
n+3	12	Network participation status	Node 29
	13		Node 30
	14		Node 31
n+4	15	Network participation status	Node 32
			(Reserved.)
n+5			(Reserved.)
n+6	0 to 14	Local Data Link Participation Status	Not used.
	15		0: Local node not participating in data links or data links not started 1: Local node participating in data links

**NS Series Programming Manual**

First read address (n)	Bits	Status	Details
n+7	0 to 7	Data Link Status	Node 1
	8 to 15		Node 2
n+8	0 to 7		Node 3
	8 to 15		Node 4
n+9	0 to 7		Node 5
	8 to 15		Node 6
n+10	0 to 7		Node 7
	8 to 15		Node 8
n+11	0 to 7		Node 9
	8 to 15		Node 10
n+12	0 to 7		Node 11
	8 to 15		Node 12
n+13	0 to 7		Node 13
	8 to 15		Node 14
n+14	0 to 7		Node 15
	8 to 15		Node 16
n+15	0 to 7		Node 17
	8 to 15		Node 18
n+16	0 to 7		Node 19
	8 to 15		Node 20
n+17	0 to 7		Node 21
	8 to 15		Node 22
n+18	0 to 7		Node 23
	8 to 15		Node 24
n+19	0 to 7		Node 25
	8 to 15		Node 26
n+20	0 to 7		Node 27
	8 to 15		Node 28
n+21	0 to 7		Node 29
	8 to 15		Node 30
n+22	0 to 7		Node 31
	8 to 15		Node 32
n+23	0	Data Link Normal Operation Status	Node 1
	1		Node 2
	2		Node 3
	3		Node 4
	4		Node 5
	5		Node 6
	6		Node 7
	7		Node 8
	8		Node 9
	9		Node 10
	10		Node 11
	11		Node 12
	12		Node 13
	13		Node 14
	14		Node 15
15	Node 16		
n+24	0		Node 17
	1		Node 18
	2		Node 19
	3		Node 20
	4		Node 21
	5		Node 22
	6		Node 23
7	Node 24		

**NS Series Programming Manual**

First read address (n)	Bits	Status	Details
n+24	8	Data Link Normal Operation Status	Node 25
	9		Node 26
	10		Node 27
	11		Node 28
	12		Node 29
	13		Node 30
	14		Node 31
	15	Node 32	
n+25	0	Data Link Error Detection Status	Node 1
	1		Node 2
	2		Node 3
	3		Node 4
	4		Node 5
	5		Node 6
	6		Node 7
	7		Node 8
	8		Node 9
	9		Node 10
	10		Node 11
	11		Node 12
	12		Node 13
	13		Node 14
	14		Node 15
	15	Node 16	
n+26	0		Node 17
	1		Node 18
	2		Node 19
	3		Node 20
	4		Node 21
	5		Node 22
	6		Node 23
	7		Node 24
	8		Node 25
	9		Node 26
	10		Node 27
	11		Node 28
	12		Node 29
	13		Node 30
	14		Node 31
	15		Node 32

## Appendix-6 Additional NS Series Functions

The following tables show the main functions that have been added or improved with the NS Series upgrade.

### Ver. 3.0

Supplement/ Enhancement	Function
Screen data transfer through PLCs	Enables transferring screen data to NS Hardware through a PLC and transferring ladder program to the PLC through the NS Hardware.
Switch Box Function	Displays I/O status of addresses on the NS Hardware. Addresses and their comments can be reused from a ladder program using the Switch Box Utility.
Multiple language support	Multiple languages (Simplified Chinese, Korean, Traditional Chinese, etc.) can be displayed on user screens.
Video capture using a PLC trigger	Enables performing video captures using system memory (\$SB24) as a trigger.
Enhanced parts List	Vastly increased library objects for use as buttons and lamps.
Reading CLK status	Displays status of CLK Board attached with NS Hardware on the screen.
Macro to set time	Automatically sets the time, which as set manually before.
Screen data can be transferred using Ethernet directly the first time	Screen data can be transferred using Ethernet directly the first time.

### Ver. 4.0

Supplement/ Enhancement	Function
Equipped with USB port as a standard feature.	Equipped with a USB port as a standard feature enabling display contents to be printed using USB-compatible general-purpose color printers (e.g., Canon or Epson printers).
Display possible in up to 32,000 colors.	BMP and JPEG images can now be displayed using up to 32,000 colors.
Screen data capacity greatly increased.	The data capacity has increased from 4 Mbytes to 20Mbytes.
High-speed drawing	The drawing speed is twice that of existing OMRON products.

### Ver. 5.0

Supplement/ Enhancement	Function
NS5-series models added.	Added NS5-SQ0□ (B) -V1 with compact 5.7-inch STN color display.
Object forms can be selected by user.	The forms of ON/OFF Button, Word Button, Bit Lamp, and Word Lamp objects can now be specified as BMP or JPEG image files.
Windows fonts can be used in Button and Lamp objects.	The labels used in ON/OFF Button, Word Button, Bit Lamp, Word Lamp, and Command Button objects can now be specified using Windows fonts.
Continuous input can be received from Bar Code Reader.	Input order of numeric values and character strings can now be controlled, allowing continuous input from a bar code reader.
Ver. 1.X projects can be created and edited.	CX-Designer Ver. 5.0 can be used to create and edit projects for NS System Ver. 1.X.

**NS Series Programming Manual**

**Ver. 6.0**

Supplement/ Enhancement	Function
A PT model added.	Added NS8-TV1□ (B)-V1.
Transfer program functions added.	Screen data can be transferred from a personal computer to the PT via modem. Installing a CLK board in the personal computer enables screen data to be transferred. CX-Server compatibility has also simplified settings required for data transfer.
Data log function expanded.	The number of always logging points has been increased from 5,000 to 50,000 points, and logging data can be automatically saved to the memory card. Saved CSV files can be read and displayed overlapping the log graph with a reference.
Video captures can be read from the memory card.	Image data saved in the memory card can be specified from a list and displayed. The list can be called using the command buttons or from the system menu.
Appearance of command buttons can be specified.	The appearance of command buttons can be specified as round buttons. BMP and JPEG image files can be specified for button appearance. Write confirmation messages can also be set.
Temporary input object added.	Objects for temporarily displaying input numerical values or character strings are provided for use when creating tenkeys or keyboards for Numerical Display & Input and String Display & Input objects using command buttons. Temporary input objects can also be used to display maximum and minimum values.
The storage format of numeric values in system memory can be selected.	The numerical value storage format for system memory can be selected from BCD and binary.
The data format for specifying line numbers in indirectly specified files for functional objects can be selected.	The data format for specifying line numbers in indirectly specified files set using functional object properties can be selected from BCD and binary.
The number of alarms has been increased.	The maximum number of alarms that can be registered has been increased to 5,000.
Macros FOR, NEXT, CONTINUE, and BREAK have been added.	Loop processing can be performed using macros. This improves efficiency of macro creation.
Label application function for importing CSV files has been added.	When importing CSV files, the character properties for a specified label name can be applied to the character properties for another label. This function is useful when setting multiple labels.
System memory functions have been added.	The following flags have been added: PT battery low flag PT memory card free space check flag Memory card power OFF bit Memory card removing status Video capture start bit Video capture executing flag Video capture results flag Periodical Data Log Save in process flag Print screen/video capture switching bit



**NS Series Programming Manual**

**Ver. 6.2**

Supplement/ Enhancement	Function
PT models added	Added NS5-SQ0□-V2, NS5-TQ0□-V2, and NS5-MQ0□-V2.
Project trigger macro added	Setting the macro to execute when the bit or value at a specified address changes has been enabled.
Data block control functions added to command buttons	Data block control functions have been added to command buttons to enable reading/writing between CSV files and PLC memory, CVS files and PT memory, and PT memory and PLC memory when a button is pressed or a specified address turns ON while the command button is displayed.
Added items to system memory	The following have been added to system memory: data block control complete flag, internal holding bit/word memory (\$HB/\$HW) initialization flag, and data block error number.
Added arrows	Arrow heads can be added to the start and/or end of straight lines.
Expanded Alarm/Event Summary & History	The titles of each display item can now be displayed on the top line. Also, alarm messages that are not completely displayed can be touched to display them in a message box.
Added program transfer function	Screen data transfer to the PT from a personal computer has been enabled using a USB cable.
Added installation method	CX-Designer can be installed from the CX-One FA Integrated Tool Package.
Added startup method	Startup has been enabled by right-clicking the NS-series PT in the CX-Integrator Network Configuration Window and selecting <i>Start Special Application</i> . If <i>Start with Settings Inherited</i> is selected, startup through to new project creation will be automatically executed.

**Ver. 6.6**

Supplement/ Enhancement	Function
Multi-vendor connectivity	It is now possible to connect OMRON NS-series PTs to Mitsubishi FX-series PLCs, A-series PLCs, and Siemens S7-series PLCs.
Data security	A password can now be set for creating data. When data with a set password is transferred to a PT, the password is then required in order to upload the data. This prevents users who do not know the password from obtaining that data from the PT. In addition, a password can be required to transfer data to the PT. This prevents data from being accidentally overwritten.
User security	Once a user inputs the password to use a functional object for which a password has been set, the password does not have to be input again as long as the user continues using only functional objects for which lower level passwords have been set. Functional objects with a higher-level password cannot be manipulated. (A warning message will be displayed if an attempt is made.) This makes it possible to create applications that permit only the necessary operations by users who have entered passwords, and thus helps prevent faulty operations.
Consecutive line drawing	Data in memory is treated as X and Y coordinates, and straight lines are drawn between the applicable coordinates to create consecutive line drawing. This makes it possible to handle applications involving the drawing of various graphics in two-dimensional space that could not be drawn using the existing graph components.
Improvements in broken-line graph	<ul style="list-style-type: none"> <li>• Number of monitor points: 1,000 max.</li> <li>• Batch reading</li> <li>• Graph overwriting</li> <li>• Indirect specification of starting display position</li> <li>• Indirect specification of displaying/hiding graph lines</li> <li>• Indirect specification of displaying/hiding scale lines</li> </ul>

**NS Series Programming Manual**

Supplement/ Enhancement	Function
Ladder Monitor	With version-2 NS-series PTs (except for the NS5-V2 and NSJ5), Ladder Monitoring is built into the PT as a standard feature, so no separate Memory Card is required. (A Memory Card is required for version-1 PTs, however, just as before.) In addition, neither version-1 nor version-2 PTs are reset when starting or ending the Ladder Monitor when Ladder Monitor version 2.8 is used. These improvements make the Ladder Monitor easier to use and reduce operating time.
Symbol table transfers when transferring screen data	When screen data is downloaded from the CX-Designer, the symbol tables are downloaded together with it. Likewise, when screen data is uploaded, the symbol tables are uploaded too.
Holding log and alarm information when transferring screen data	It is now possible to select whether log and alarm information is to be initialized when screen data is downloaded.
PLC data trace reading	Trace results from data traces (which is a CPU Unit function) can now be read by the PT and displayed in time chart format. (CSV files cannot be saved.) This makes it possible, using just the PT without CX-Programmer, to isolate the causes of errors that occur on-site.
Addition of European fonts	All Russian and Greek characters are now available, and all characters are half-width.
Video display mode setting	It is now possible to select from three patterns for image quality adjustment. When a visual sensor is connected, even small display characters can be read. It is now also possible to adjust the display position for RGB display.
SAP (Smart Active Parts)	SAP has been added for the EJ1 Modular Temperature Controller, G3ZA Multi-channel Power Controller, and Troubleshooters.
Temperature Controller Unit	It is now possible to connect the EJ1 Modular Temperature Controller to the PT as a host.

**Ver. 7.0**

Supplement/ Enhancement	Function
Multi-vendor connectivity	It is now possible to connect NS-series PTs to the following devices. <ul style="list-style-type: none"> <li>• OMRON Trajexia Motion Controllers</li> <li>• Yaskawa MP-series Machine Controllers</li> <li>• Yaskawa F7-series Varispeed and VS Mini V7-series Machine Controllers</li> <li>• Mitsubishi Q-series PLCs</li> </ul>
NT compatibility	System memory can now be allocated to PLC memory areas in the same way as for the NT Series, enabling PLC ladder programs to be easily transferred when migrating from the NT Series to the NS Series.
Holding previous system memory values	It is now possible to display at the next startup the screen that was being displayed when the program was closed.
Multilingual system capability	In addition to English and Japanese, the system now also supports German, French, Italian, Spanish, and Chinese (both traditional and simplified).
Multifunction Objects	Multifunction Objects have been added to functional objects. With Multifunction Object, multiple processes can be registered and can then be executed with the press of a button. Processes that previously required the creation of macros can now be executed by simply setting properties.
Machine Navigator function	A Machine Navigator function and a functional object contents display function have been added. Machine Navigator provides unified control of text and image files (i.e., "contents") to be displayed, and the new display function displays those contents. Contents requiring association can be managed in ID units, and the display can be easily changed by simply changing the ID specification.

**NS Series Programming Manual**

Supplement/ Enhancement	Function
Flicker function	The following flicker methods have been added. <ul style="list-style-type: none"> <li>• Display/hide (entire object or label)</li> <li>• Flicker color specification (fill color, character, and line colors)</li> </ul>
Improved alarm/event summary and history display	A function has been added to provide a summary of a particular alarm/event on a single line, making it possible to quickly check conditions without unnecessary displays. A horizontal scrolling function has also been added to allow all items to be checked.
Fonts	Scalable fonts have been added to enable smooth displays. Gothic numeral and 7-segment displays have also been added to allow more attractive and up-to-date screens to be created.
Improved screen switching function	Speed and bitmap performance have been improved for switching screens.
Improved connection operations	Even if one host is not connected, the monitoring results of the connected host can be displayed on the screen without "Connecting" being displayed.
SAP Library allocated unit number and communications setting information display	The following information can now be displayed. <ul style="list-style-type: none"> <li>• Command destination port names</li> <li>• Destination network addresses</li> <li>• Destination node addresses</li> <li>• Destination unit numbers</li> <li>• DeviceNet Slave Unit address and Inverter node addresses</li> </ul>
Bar codes	The maximum data length has been increased to 254 bytes, allowing the data to be processed by two-dimensional bar code readers.
Changing host settings with the System Menu	A list of hosts can now be displayed by selecting Communications Settings from the System Menu. It is now also possible to change the host network address, node address, and host type.

**Ver. 8.0**

Supplement/ Enhancement	Function
CJ2 support	Connection to the CJ2 CPU Units is supported.
EtherNet/IP support	Supports tag message communications.
Ladder Monitor	Ladder Monitor functions and operability have been greatly improved. The main functions that have been added or improved are as follows: <ul style="list-style-type: none"> <li>• It is now possible to start the Ladder Monitor from the alarm/event summary and history, and automatically search for communications addresses set as alarm/events.</li> <li>• The display colors and display size were changed.</li> <li>• I/O comments can now be read from the PLC.</li> <li>• It is now possible to switch the number of display lines in I/O comments.</li> <li>• Address search and backward search functions have been added, and existing search functions have been improved.</li> <li>• The number of objects that can be registered for the I/O monitor has been increased.</li> <li>• It is now possible to change the present value or search for addresses at the cursor position.</li> <li>• It is now possible to switch the display and input formats of the present value of a word between hexadecimal, decimal, and signed decimal format.</li> <li>• It is now possible to perform a screen capture and save the data as a bitmap (bmp) file.</li> </ul>

**NS Series Programming Manual**

Supplement/ Enhancement	Function
Operation log	The following functions have been added to the operation log. <ul style="list-style-type: none"> <li>• It is now possible to log the ON/OFF status of a specified address. Using this function, it is possible to log operations from sources other than a PT screen by, for example, allocating a communications address to switch a control panel screen.</li> <li>• Messages can now be set in the operation log.</li> <li>• It is now possible to save a history file (a CSV file), and display the operation log screen of the System Menu from a Multifunction Object.</li> <li>• Multiple history files can now be saved.</li> </ul>
PLC Data Trace	The following functions have been added to PLC data trace. <ul style="list-style-type: none"> <li>• Now supports data trace of words.</li> <li>• Data trace results can now be saved in CSV format.</li> <li>• It is now possible to perform a screen capture of the PLC Data Trace Screen and save the data as a bitmap (bmp) file.</li> </ul>
Screen data transfer	When uploading project data from the PT, it is no longer necessary to switch to the transfer screen, or to reset the PT after the upload is complete. This makes it possible to perform screen operations from the PT even while uploading.
Multi-vendor connectivity	It is now possible to connect OMRON NS-series PTs to the following devices. <ul style="list-style-type: none"> <li>• SLC500 Controller manufactured by Rockwell Automation (Allen-Bradley), MicroLogix, PLC-5, CompactLogix, and ControlLogix</li> <li>• Modbus RTU-compatible devices</li> </ul>
Screen saver	The startup time of the screen saver can now be indirectly specified.
Supports character string tables for alarms/events	Message characters from alarms/events can now be referenced from the character string table.
Screen Input Prohibit Function	By turning ON/OFF a specified communications address, inputs for the entire screen can now be enabled/disabled.
NS5-series models added	The following models have been added to the NS5-series. NS5-SQ10□-V2 NS5-SQ11□-V2 NS5-TQ10□-V2 NS5-TQ11□-V2 NS5-MQ10□-V2 NS5-MQ11□-V2

**Ver. 8.1**

Supplement/ Enhancement	Function
Model addition	The NS15-TX01□-V2 was added.
Multivendor support	The PT can be connected to the following PLC: Yokogawa Electric FA-M3/FA-M3R-series PLCs
Printers	The PT can be connected to a PictBridge-compatible printer. (Not possible, however, for the NS12/10/8/5-V1, NS5-SQ0□□-V2, NS5-TQ0□□-V2, and NS5-MQ0□□-V2.)
Data Log Graphs	An option was added to enable displaying data log graphs without blanks for intervals when data logging was stopped.
Alarm history clear improvement	A setting was added for \$SB32 in system memory so that the number of occurrences could also be cleared when initializing the alarm/event history.
Number of objects per screen	The number of object per screen has been increased. <ul style="list-style-type: none"> <li>• Functional objects (including frames and tables): Up to 1,024</li> <li>• Graphic displays: Up to 2,048</li> </ul>
Screen switching performance improvement	The speed for switching screens was improved when giving priority to displaying graphic displays and frames as the display method. (Project data version 8.1 or higher is required.)

**NS Series Programming Manual**

Supplement/ Enhancement	Function
Ladder Monitor	<ul style="list-style-type: none"> <li>The CJ2 CPU Units are now supported.</li> <li>A host can be connected to the PT for monitoring using EtherNet/IP. Passwords can be set for changing present values and other operations.</li> </ul>

**Ver. 8.2**

Supplement/ Enhancement	Function
Device data transfer	Conditions can be set to transfer data from a source to a destination.
SPMA communications	Applications running on a computer can access other devices through USB.
Batch format settings	The following can be set to the same values for all labels: <ul style="list-style-type: none"> <li>Address information</li> <li>List data</li> <li>Date display objects</li> </ul>
Batch label settings	A specified character string can be set for all of the labels for the following objects: <ul style="list-style-type: none"> <li>Bit Lamp objects</li> <li>Bit Button objects</li> <li>Multi Function objects</li> </ul>
String Display and Input objects	An input method setting was added to move the cursor to in front of the character string when the focus is set.
Analogue Meter improvements	<ul style="list-style-type: none"> <li>The shape of the needle can be set to a straight line, arrow, or triangle arrow.</li> <li>The line width can be changed to up to 3 dots.</li> </ul>
Password input keyboard	The user can specify the keyboard used to input a password.
Time setting to move to System Menu	The time before moving to the System Menu when two of the four corners of the screen are pressed can be set.
Macro additions	Trigonometric and floating-point functions were added.
Screen switch settings	The default setting for the display sequence for screens now gives priority to displaying fixed objects and frames first.
Improvements in creation methods for fixed objects	The method to create sectors and arcs has been improved.
Data graphs for 128 points	The total number of addresses for constant logging was increased to 128 points max.
Data blocks with 512 KB	The size of one data block was increased to 512 KB.
CP1W-CIF41 compatibility	To connect to the CP1W-CIF41, select the check box to use the CP1W-CIF41 in the Ethernet host settings under the CX-Designer communications settings. Note: Connecting to the CP1E is not supported.

**Ver. 8.3**

Supplement/ Enhancement	Function
Numeral Display & Input	The input method can now be restricted to use only functional objects or barcodes, but not both.
String Display & Input	The input method can now be restricted to use only functional objects or barcodes, but not both.

**Ver. 8.4**

Supplement/ Enhancement	Function
Support for CJ2 data structures	Data structures for CJ2 CPU Units can now be accessed.
PictBridge support improved	The printing method and orientation can now be specified.
Modbus support improved	Bit devices can now be read.
Memory Card error detection	Added support to detect Memory Card errors at startup.
Backlight brightness	The brightness can be adjusted to any of 32 levels. (NS5-SQ1/-TQ1)



## Revision History

A manual revision code appears as a suffix to the catalog number on the cover of the manual.

<b>Cat. No.</b>	<b>V073-E1-15</b>
-----------------	-------------------

↑  
Revision code

The following table outlines the changes made to the manual during each revision. Page numbers refer to the previous version.

Revision code	Date	Revised content
01	May 2002	Original production
02	January 2003	Addition of data transfer passing through the networks Addition of Switch Box function Contents revised to reflect the upgrade from version 2.0 to version 3.0
03	April 2003	Addition of information related to the printing function Addition of information related to "V1" models Addition of information related to other version upgrades
04	October 2003	Addition of information related to the NS5-V1 Series. Addition of information related to other version upgrades.
05	July 2004	Addition of information mainly related to data logs. Addition of information mainly related to temporary input objects. Addition of information mainly related to icon functionality.
06	February 2005	Addition of information related to the NS5-V2 Series. Addition of information related to other version upgrades.
07	July 2006	Addition of information related to the CX-Designer release. Addition of information related to other version upgrades.
08	July 2007	Addition of information related to CX-Designer release. Addition of information related to the addition of new functions.
09	June 2008	Addition of information related to CX-Designer release. Addition of information related to the addition of new functions.
10	October 2008	Changes related to version upgrade.
11	November 2008	Changes and corrections.
12	April 2009	Changes related to version upgrade.
13	May 2010	Addition of information.
14	October 2010	Changes related to version upgrade.
15	November 2010	Revisions accompanying changes to the backlight in the NS5-SQ1/-TQ1.







**OMRON Corporation Industrial Automation Company**

Tokyo, JAPAN

Contact: [www.ia.omron.com](http://www.ia.omron.com)

**Regional Headquarters**

**OMRON EUROPE B.V.**

Wegalaan 67-69-2132 JD Hoofddorp  
The Netherlands  
Tel: (31)2356-81-300/Fax: (31)2356-81-388

**OMRON ELECTRONICS LLC**

One Commerce Drive Schaumburg,  
IL 60173-5302 U.S.A.  
Tel: (1) 847-843-7900/Fax: (1) 847-843-7787

**OMRON ASIA PACIFIC PTE. LTD.**

No. 438A Alexandra Road # 05-05/08 (Lobby 2),  
Alexandra Technopark,  
Singapore 119967  
Tel: (65) 6835-3011/Fax: (65) 6835-2711

**OMRON (CHINA) CO., LTD.**

Room 2211, Bank of China Tower,  
200 Yin Cheng Zhong Road,  
PuDong New Area, Shanghai, 200120, China  
Tel: (86) 21-5037-2222/Fax: (86) 21-5037-2200

Authorized Distributor:

© OMRON Corporation 2002 All Rights Reserved.  
In the interest of product improvement,  
specifications are subject to change without notice.

Printed in Japan

Cat. No. V073-E1-15

1110