

Solid State Relays G3R-I/O

Compact SSRs for I/O Interface with High Dielectric Strength Requirements

- High-speed models with optimum input ratings for a variety of sensors are available.
- Input Modules and Output Modules that can be used for the G2R are available.
- Use a coupler conforming to VDE 0884 and assuring an I/O dielectric strength of 4,000 V.
- Incorporate an easy-to-see monitoring indicator.
- -UTU models certified by UL, CSA, and TÜV.



Model Number Structure

■ Model Number Legend

G3R-□□□□□□□□-□-□
 1 2 3 4 5 6 7 8 9 10

1. Basic Model Name

G3R: Solid State Relay

2. I/O Classification

I: Input module

O: Output module

3. Load Power Supply Type

A: Switches AC loads

D: Switches DC loads

4. Rated Load Power Supply Voltage

Z: 24 VDC

X: 48 VDC

2: 240 VAC

5. Rated Load Current

R1: 0.1 A

01: 1 A

02: 2 A

6. Terminal Type

S: Plug-in terminals

7. Zero Cross Function

Z: Equipped with zero cross function

L: Not equipped with zero cross function

Blank: DC-output model

8. Operation Indicator

N: Equipped with operation indicator

9. Response Speed (only for DC Input Models)

I: Low-speed (10 Hz)

Blank: High-speed (1 kHz)

10. Certification

UTU: Certified by UL, CSA, and TÜV

Ordering Information

■ List of Models

Input Module

Isolation	Indicator	Response speed	Logic level		Rated input voltage	Model
			Supply voltage	Supply current		
Photocoupler	Yes	---	4 to 32 VDC	0.1 to 100 mA	100 to 240 VAC	G3R-IAZR1SN-UTU
		High-speed (1 kHz)			5 VDC	G3R-IDZR1SN-UTU
		Low-speed (10 Hz)			12 to 24 VDC	G3R-IDZR1SN-1-UTU
					5 VDC	
					12 to 24 VDC	

Output Module

Isolation	Indicator	Zero cross function	Rated output load	Rated input voltage	Model
Phototriac	Yes	Yes	2 A at 100 to 240 VAC	5 to 24 VDC	G3R-OA202SZN-UTU
		No			G3R-OA202SLN-UTU
Photocoupler		---	2 A at 5 to 48 VDC		G3R-ODX02SN-UTU
			1.5 A at 48 to 200 VDC		G3R-OD201SN-UTU

Note: When ordering, specify the rated input voltage.

■ Accessories (Order Separately)

Track/Surface Mounting Socket (Recommended)

Model	Number of poles
P2RF-05-E	1 pole (G2R: 1 pole usage)

Note: Refer to page 72 for details on other Sockets.

Connecting Socket Attaching Plate

Model	Applicable Socket
P2R-P	P2R-05A

I/O Indication

I/O module classification and AC/DC use are indicated on the mark affixed to the top of the product.

Mark indication	Specification
AC IN	Input module, AC input
DC IN	Input module, DC input
AC OUT	Output module, AC output
DC OUT	Output module, DC output

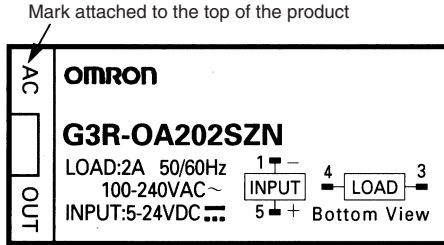

Specifications

Ratings (at an Ambient Temperature of 25°C)

Input Module

Input

Model	Rated voltage	Operating voltage	Input current	Must operate voltage	Must release voltage
G3R-IAZR1SN-UTU	100 to 240 VAC	60 to 264 VAC	15 mA max.	60 VAC max.	20 VAC min.
G3R-IDZR1SN-UTU	5 VDC	4 to 6 VDC	8 mA max.	4 VDC max.	1 VDC min.
	12 to 24 VDC	6.6 to 32 VDC		6.6 VDC max.	3.6 VDC min.
G3R-IDZR1SN-1-UTU	5 VDC	4 to 6 VDC		4 VDC max.	1 VDC min.
	12 to 24 VDC	6.6 to 32 VDC		6.6 VDC max.	3.6 VDC min.

Output

Model	Logic level supply voltage	Logic level supply current
G3R-IAZR1SN-UTU	4 to 32 VDC	0.1 to 100 mA
G3R-IDZR1SN-UTU		
G3R-IDZR1SN-1-UTU		

Output Module

Input

Model	Rated voltage	Operating voltage	Input current	Must operate voltage	Must release voltage
G3R-OA202SZN-UTU	5 to 24 VDC	4 to 32 VDC	15 mA max. (at 25°C)	4 VDC max.	1 VDC min.
G3R-OA202SLN-UTU			8 mA max.		
G3R-ODX02SN-UTU					
G3R-OD201SN-UTU					

Output

Model	Rated load voltage	Load voltage range	Load current (See note.)	Inrush current
G3R-OA202SZN-UTU	100 to 240 VAC	75 to 264 VAC	0.05 to 2 A	30 A (60 Hz, 1 cycle)
G3R-OA202SLN-UTU				
G3R-ODX02SN-UTU	5 to 48 VDC	4 to 60 VDC	0.01 to 2 A	8 A (10 ms)
G3R-OD201SN-UTU	48 to 200 VDC	40 to 200 VDC	0.01 to 1.5 A	8 A (10 ms)

Note: The minimum current value is measured at 10°C min.

■ Characteristics

Input Module

Item	G3R-IAZR1SN-UTU	G3R-IDZR1SN-UTU	G3R-IDZR1SN-1-UTU
Operate time	20 ms max.	0.1 ms max.	15 ms max.
Release time	20 ms max.	0.1 ms max.	15 ms max.
Response frequency	10 Hz	1 kHz	10 Hz
Output ON voltage drop	1.6 V max.		
Leakage current	5 μ A max.		
Insulation resistance	100 M Ω min. between input and output		
Dielectric strength	4,000 VAC, 50/60 Hz for 1 min between input and output		
Vibration resistance	10 to 55 to 10 Hz, 0.75-mm single amplitude		
Shock resistance	1,000 m/s ²		
Ambient temperature	Operating: -30°C to 80°C (with no icing) Storage: -30°C to 100°C (with no icing)		
Certified standards	UL508 File No. E64562 CSA C22.2 (No. 14, No. 950) File No. LR35535 TÜV File No. R9650094 (EN60950)		
Ambient humidity	Operating: 45% to 85%		
Weight	Approx. 18 g		

Output Module

Item	G3R-OA202SZN-UTU	G3R-OA202SLN-UTU	G3R-ODX02SN-UTU	G3R-OD201SN-UTU
Operate time	1/2 of load power source cycle + 1 ms max.	1 ms max.	1 ms max.	
Release time	1/2 of load power source cycle + 1 ms max.		2 ms max.	
Response frequency	20 Hz		100 Hz	
Output ON voltage drop	1.6 V max.			2.5 V max.
Leakage current	1.5 mA max.		1 mA max.	
Insulation resistance	100 M Ω min. between input and output			
Dielectric strength	4,000 VAC, 50/60 Hz for 1 min between input and output			
Vibration resistance	Destruction: 10 to 55 to 10 Hz, 0.75-mm single amplitude			
Shock resistance	Destruction: 1,000 m/s ²			
Ambient temperature	Operating: -30°C to 80°C (with no icing) Storage: -30°C to 100°C (with no icing)			
Certified standards	UL508 File No. E64562 CSA C22.2 (No. 14, No. 950) File No. LR35535 TÜV File No. R9650094 (EN60950)			
Ambient humidity	Operating: 45% to 85%			
Weight	Approx. 18 g			

Engineering Data

Load Current vs. Ambient Temperature

G3R-OA202SZN-UTU/OA202SLN-UTU

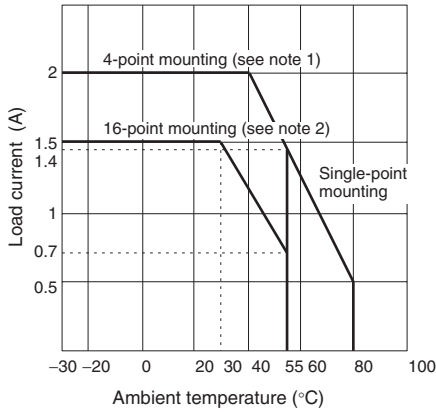

G3R-ODX02SN-UTU (4 to 60 VDC)

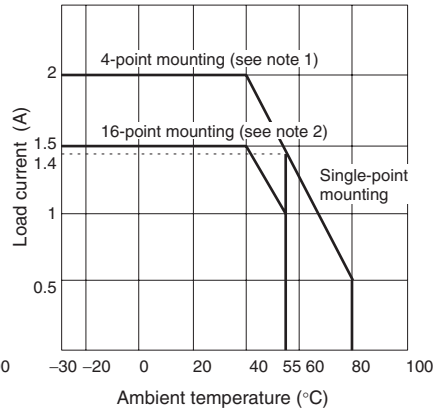

G3R-OD201SN-UTU (40 to 200 VAC)

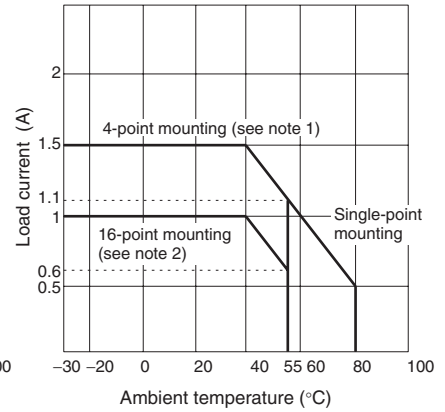

Note: 1. When G730-Z0M04-B is mounted.
2. When G70A-Z0C16 is mounted.

One Cycle Surge Current: Non-repetitive

Note: Keep the inrush current to half the rated value if it occurs repetitively.

G3R-OA202SZN-UTU/OA202SLN-UTU

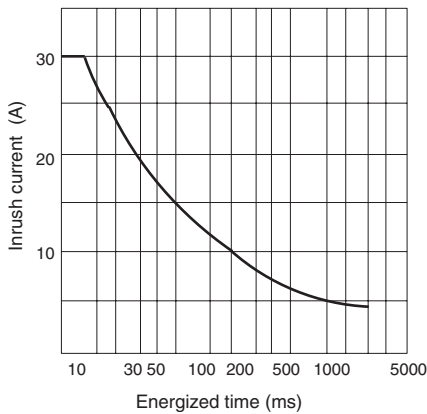

G3R-ODX02SN-UTU

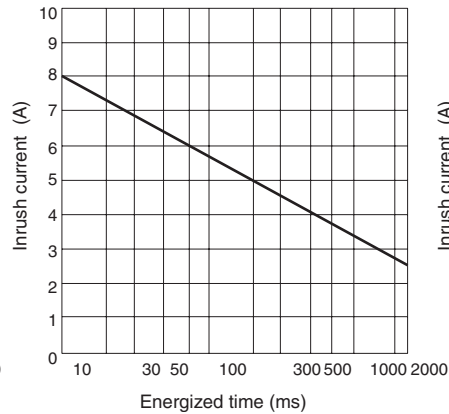

G3R-OD201SN-UTU

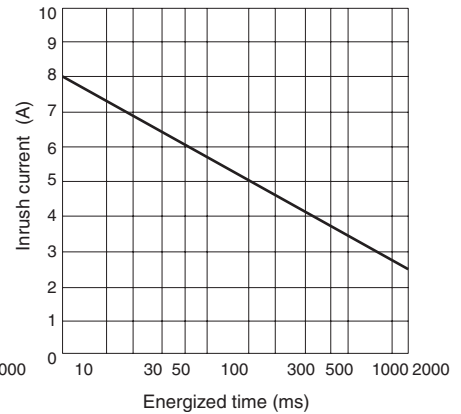

Dimensions

Note: All units are in millimeters unless otherwise indicated.

G3R

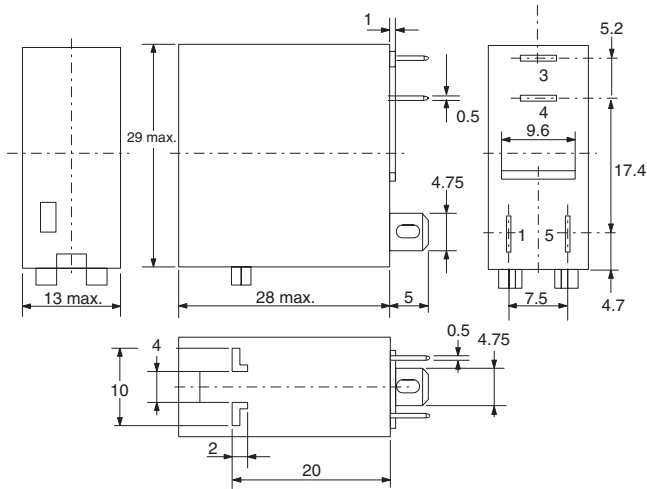

Terminal Arrangement/ Internal Connections (Bottom View)

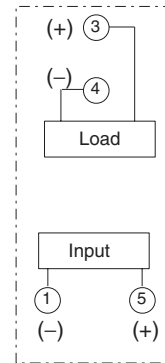

Connecting Sockets

Connecting Socket Attaching Plates

P2RF-05

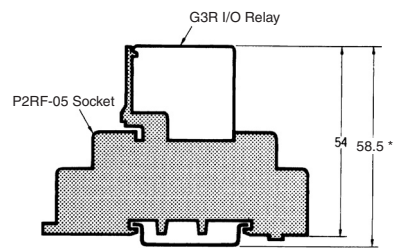
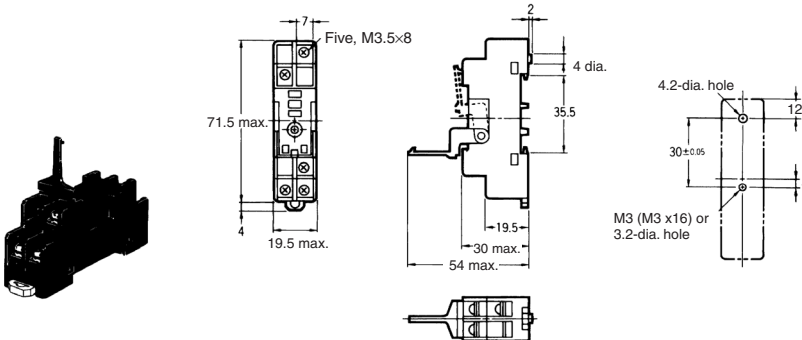

* Indicates a value when using the PFP-□N Supporting Rail. The value is 67.5 when using the PFP-□N2.

P2RF-05-E

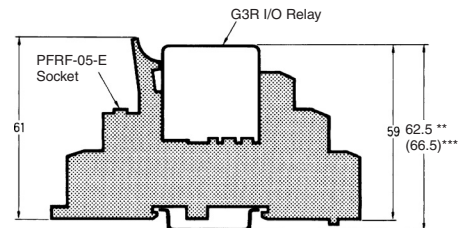
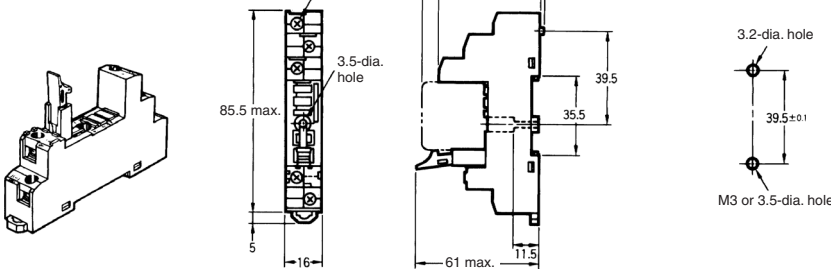

** Indicates a value when using the PFP-□N Supporting Rail with the P2RF-05-E. The value is 71.5 when using the PFP-□N2.

*** Indicates a value when using the PFP-□N Supporting Rail with the P2RF-08-E. The value is 75.5 when using the PFP-□N2.

P2R-05A

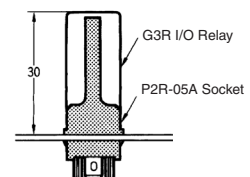
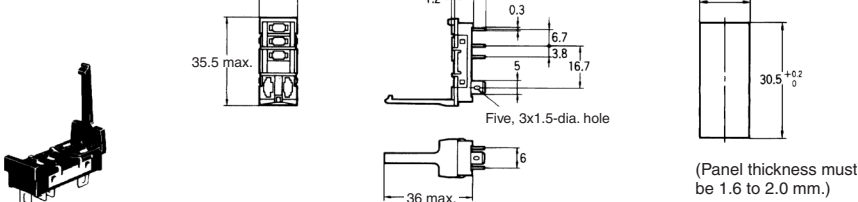

(Panel thickness must be 1.6 to 2.0 mm.)

P2R-05P

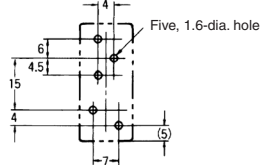
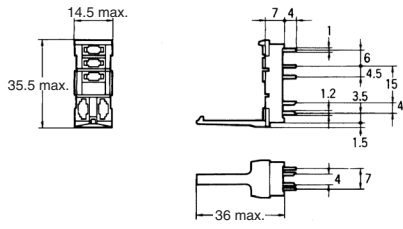

Dimensional tolerance is ± 0.1 .

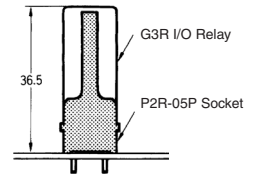

P2R-057P

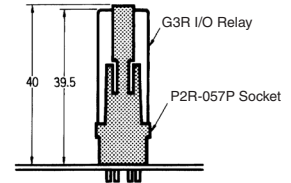
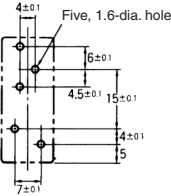
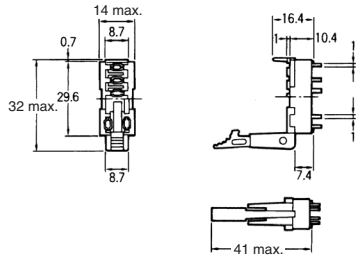
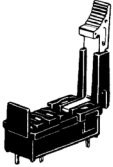

Socket Mounting Plate

Use the Socket Mounting Plate when arranging several Sockets in a row.

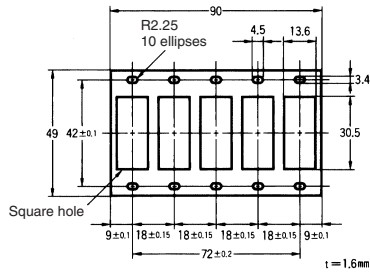

G70A I/O Block Base

Ordering Information

Classification	Internal I/O circuit common	Rated voltage	Model
Output	NPN (+ common)	24 VDC	G70A-ZOC16-3
	PNP (- common)	24 VDC	G70A-ZOC16-4
Input	NPN/PNP	110 VDC max., 240 VAC max. (See note.)	G70A-ZIM16-5

Note: Each relay to be mounted must incorporate a coil that has proper specifications within the maximum rated voltage range.

Dimensions

Note: All units are in millimeters unless otherwise indicated.

G70A-ZOC16 (Output)

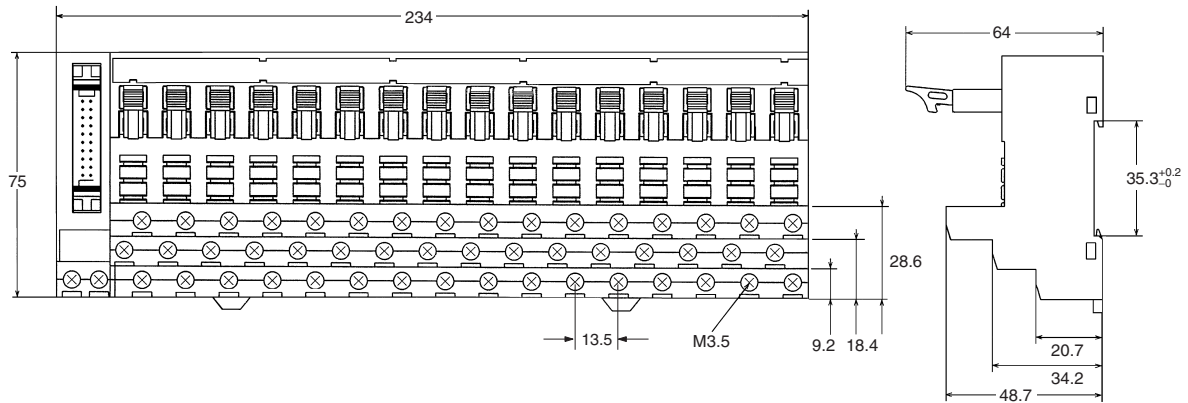

G70A-ZIM16 (Input)

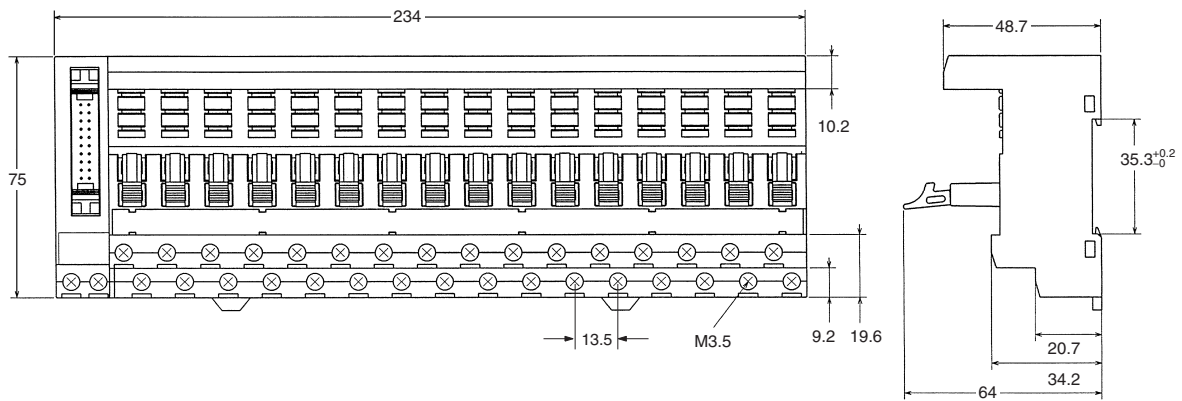

Terminal Arrangement/Internal Connection

G70A-ZOC16-3 (NPN)

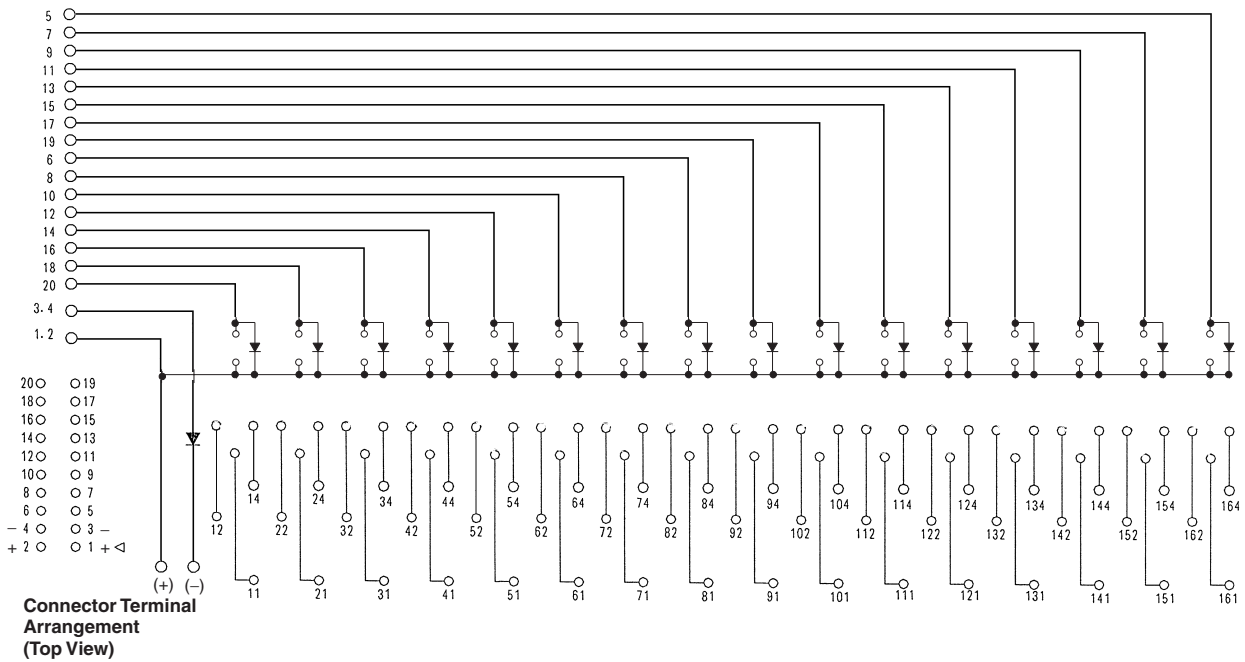

G70A-ZOC16-4 (PNP)

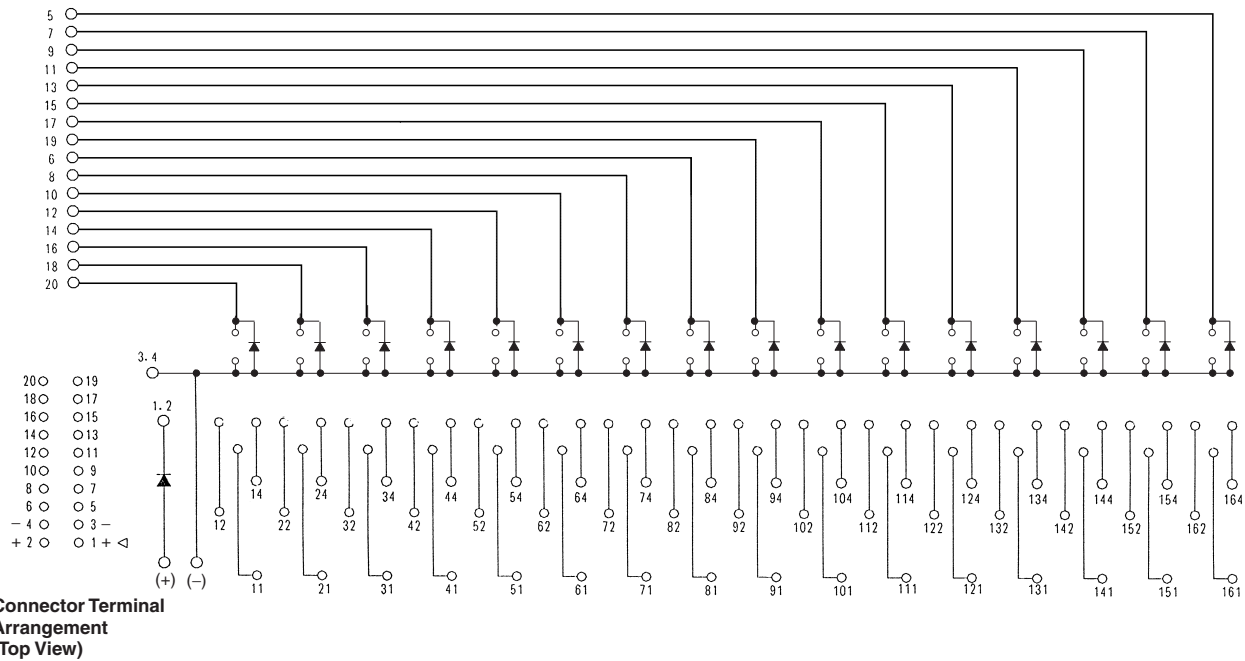

SSR

G70A-ZIM16-5 (NPN/PNP)

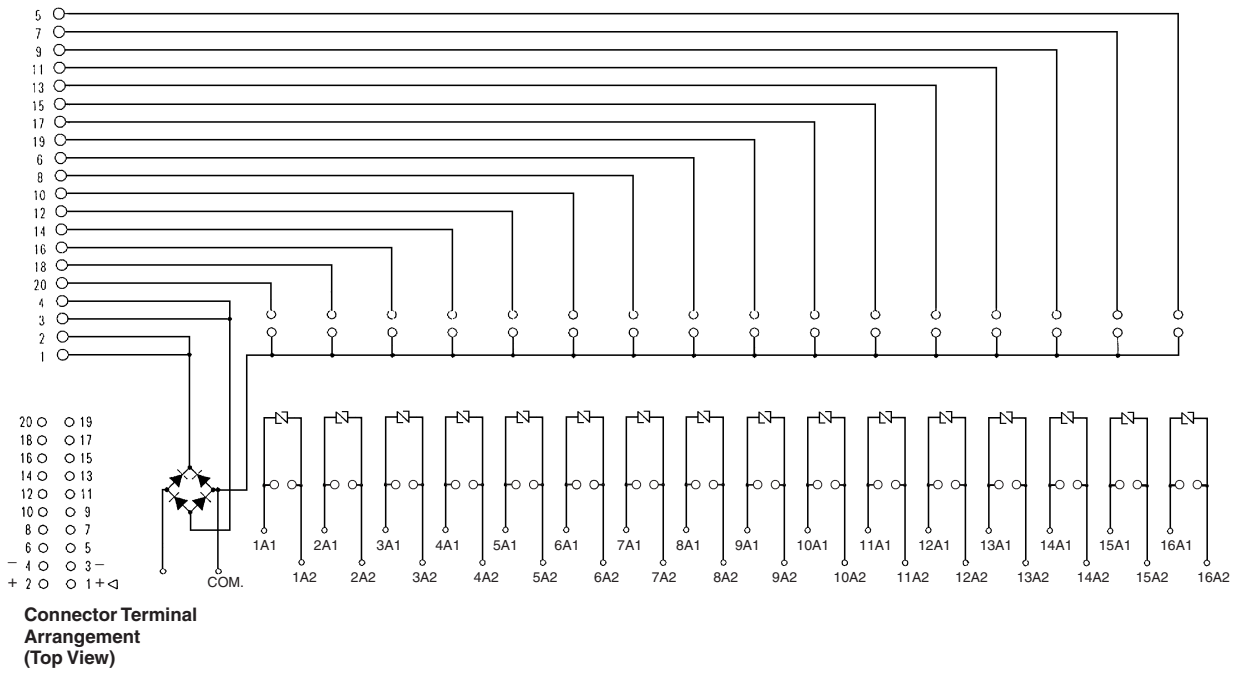

Safety Precautions

■ Precautions for Correct Use

Please observe the following precautions to prevent failure to operate, malfunction, or undesirable effect on product performance.

Connection

With the SSR for DC switching, the load can be connected to either positive or negative output terminal of the SSR.

Precaution of Mounting Output Modules

With up to four G3R SSRs mounted closely and side by side, 2-A loads can be switched.

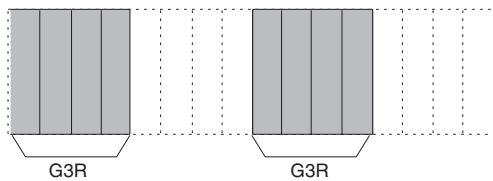

Protective Element

Since the SSR does not incorporate an overvoltage absorption component, be sure to connect an overvoltage absorption component when using the SSR under an inductive load.

With a G3R SSRs mounted every other slot, 2-A loads can be switched.

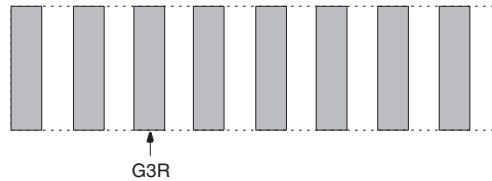

ALL DIMENSIONS SHOWN ARE IN MILLIMETERS.

To convert millimeters into inches, multiply by 0.03937. To convert grams into ounces, multiply by 0.03527.