

SYSMAC CS Series
WS02-LCTC1-E

CX-Process Monitor
(Ver. 2.60)

OPERATION MANUAL

OMRON

WS02-LCTC1-E

CX-Process Monitor (Ver. 2.60)

Operation Manual

Revised December 2003

Notice:

OMRON products are manufactured for use according to proper procedures by a qualified operator and only for the purposes described in this manual.

The following conventions are used to indicate and classify precautions in this manual. Always heed the information provided with them. Failure to heed precautions can result in injury to people or damage to property.

 **DANGER** Indicates an imminently hazardous situation which, if not avoided, will result in death or serious injury.

 **WARNING** Indicates a potentially hazardous situation which, if not avoided, could result in death or serious injury.

 **Caution** Indicates a potentially hazardous situation which, if not avoided, may result in minor or moderate injury, or property damage.

OMRON Product References

All OMRON products are capitalized in this manual. The word “Unit” is also capitalized when it refers to an OMRON product, regardless of whether or not it appears in the proper name of the product.

The abbreviation “Ch,” which appears in some displays and on some OMRON products, often means “word” and is abbreviated “Wd” in documentation in this sense.

The abbreviation “PLC” means Programmable Controller. “PC” is used, however, in some Programming Device displays to mean Programmable Controller.

Visual Aids

The following headings appear in the left column of the manual to help you locate different types of information.

Note Indicates information of particular interest for efficient and convenient operation of the product.

1, 2, 3... 1. Indicates lists of one sort or another, such as procedures, checklists, etc.

© OMRON, 2000

All rights reserved. No part of this publication may be reproduced, stored in a retrieval system, or transmitted, in any form, or by any means, mechanical, electronic, photocopying, recording, or otherwise, without the prior written permission of OMRON.

No patent liability is assumed with respect to the use of the information contained herein. Moreover, because OMRON is constantly striving to improve its high-quality products, the information contained in this manual is subject to change without notice. Every precaution has been taken in the preparation of this manual. Nevertheless, OMRON assumes no responsibility for errors or omissions. Neither is any liability assumed for damages resulting from the use of the information contained in this publication.

TABLE OF CONTENTS

PRECAUTIONS	xi
1 Intended Audience	xii
2 General Precautions	xii
3 Safety Precautions	xii
4 Application Precautions	xiii
SECTION 1	
Introduction	1
1-1 CX-Process Monitor	2
1-2 Basic Operating Procedure	18
SECTION 2	
Setup	21
2-1 Installation	22
2-2 Connecting the PLC	33
SECTION 3	
Monitor Screen Functions and Operations	37
3-1 Outline	38
3-2 Procedure to Start Monitoring	38
3-3 Starting and Stopping	39
3-4 Overview Screen	40
3-5 Screen Configurations	42
3-6 Control Screens	44
3-7 Tuning Screens	52
3-8 Trend Screens	57
3-9 Graphic Screens	63
3-10 Annunciator Screens	64
3-11 Operation Guide Message Screens	65
3-12 Alarm Log Screens	67
3-13 Operation Log Screens	68
3-14 System Monitor Screens	69
3-15 System Monitor Log Screens	77
SECTION 4	
Configuration Screens	79
4-1 Before Configuring	80
4-2 Basic Configuration Procedure	82
4-3 Basic Configuration Operations	83
4-4 System Monitor Settings	86
4-5 Creating Graphic Screens	89
4-6 Screen Configuration	99
4-7 System Information Settings	117
4-8 Checking Configurations	131
SECTION 5	
Troubleshooting	135
Appendices	
A Reading/Writing Function Block ITEMS	139
B FinsGateway Settings when Connected Using Controller Link	159
Revision History	177

About this Manual:

This manual describes the installation and operation of the WS02-LCTC1-E CX-Process Monitor software package and includes the sections described below. The CX-Process Monitor is used to control and monitor the operation of the CS1W-LC001 Loop Control Unit.

Please read this manual carefully and be sure you understand the information provided before attempting to install and operate the CX-Process Monitor. Please read the following manuals carefully and be sure you understand the information provided before setting up or using an application for a Loop Control Unit.

Product	Manual name	Cat. No.	Contents
WS02-LCTC1-E CX-Process Tool	CX-Process Tool Operation Manual	W372	Installation and operation procedures for the CX-Process Tool.
WS02-LCTC1-E CX-Process Monitor	CX-Process Monitor Operation Manual	W373 (this manual)	Installation and operation procedures for the CX-Process Monitor.
CS1W-LC001 Loop Control Unit	Loop Control Unit Operation Manual	W374	Installation and operation procedures for the Loop Control Unit (except for function blocks).
	Loop Control Unit Function Block Reference Manual	W375	Detailed information on function blocks.

Section 1 introduces the CX-Process Monitor.

Section 2 describes installing the CX-Process and connections to the PLC.

Section 3 describes the monitor screens used with the CX-Process Monitor.

Section 4 describes operating procedures to create screens and monitor using the CX-Process Monitor.

Section 5 describes errors that can occur while using the CX-Process Monitor.

Appendices are provided containing a list of ITEM settings for function blocks and FinsGateway settings to connect to the PLC using Controller Link.

 **WARNING** Failure to read and understand the information provided in this manual may result in personal injury or death, damage to the product, or product failure. Please read each section in its entirety and be sure you understand the information provided in the section and related sections before attempting any of the procedures or operations given.

PRECAUTIONS

This section provides general precautions for using the CX-Process Monitor.

The information contained in this section is important for the safe and reliable application of the CX-Process Monitor. You must read this section and understand the information contained before attempting to set up or operate the CX-Process Monitor.

1 Intended Audience	xii
2 General Precautions	xii
3 Safety Precautions	xii
4 Application Precautions	xiii

1 Intended Audience

This manual is intended for the following personnel, who must also have knowledge of electrical systems (an electrical engineer or the equivalent) and knowledge about instrumentation system.

- Personnel in charge of installing FA systems.
- Personnel in charge of designing FA systems.
- Personnel in charge of managing FA systems and facilities.

2 General Precautions

The user must operate the product according to the performance specifications described in the operation manuals.

Before using the product under conditions which are not described in the manual or applying the product to nuclear control systems, railroad systems, aviation systems, vehicles, combustion systems, medical equipment, amusement machines, safety equipment, petrochemical plants, and other systems, machines, and equipment that may have a serious influence on lives and property if used improperly, consult your OMRON representative.

Make sure that the ratings and performance characteristics of the product are sufficient for the systems, machines, and equipment, and be sure to provide the systems, machines, and equipment with double safety mechanisms.

This manual provides information for programming and operating the Unit. Be sure to read this manual before attempting to use the Unit and keep this manual close at hand for reference during operation.

 **WARNING** It is extremely important that a PLC and all PLC Units be used for the specified purpose and under the specified conditions, especially in applications that can directly or indirectly affect human life. You must consult with your OMRON representative before applying a PLC System to the above-mentioned applications.

3 Safety Precautions

 **WARNING** Check the following items before starting Loop Control Unit operation:

Analog I/O Units used in combination with the Loop Control Unit must be mounted correctly, and the unit number set on the front panel of the Analog I/O Unit must be the same as the unit number set on the Field Terminal Function Block. If the unit numbers are not the same, I/O (read/write) will be performed on the data for another Special I/O Unit (i.e., the one whose unit number is set in the Field Terminal Function Block).

The initial settings of the System Common Block on the Loop Control Unit must be set correctly. In particular, make sure that the Data Memory for the Node Terminals in the CPU Unit controlling the Loop Control Unit is not used for other applications on the PLC. If the same words in Data Memory are used for more than one application, the PLC system may act unexpectedly and cause injury.









When writing data to the I/O memory in the CPU Unit with function blocks (e.g., using Send All Blocks, Expanded DO/AO Terminal to CPU Unit, or DO/AO Terminal to CPU Unit), be sure that the words written to in the I/O memory are not being used for any other purpose. If I/O memory words are allocated to more than one purpose, the PLC system may act unexpectedly and cause injury.

 **WARNING** Do not perform processing in such a way that the Loop Control Unit and CPU Unit write to identical I/O memory words allocated to a contact output or analog output of an external Unit. If the same words are written to, the externally connected loads may act unexpectedly and cause injury.

-  **Caution** Before transferring function block data (initial setting data or operation data) to the Loop Control Unit, confirm that the destination for the data is correct and also confirm the overall safety of the system (including the Loop Control Unit). Not doing so may result in unexpected operation.

4 Application Precautions

Observe the following precautions when using CX-Process Tool.

-  **Caution** Loop Control Unit data is monitored and operated using CX-Process Monitor based on the monitor tag files created using CX-Process Tool. CX-Process Tool can be used on Microsoft Windows 95, 98, Me, 2000, or NT (Service Pack 4 or later). When creating monitor tag files using CX-Process Tool, CX-Process Monitor must be installed on the same computer.
-  **Caution** Before using function block data in actual operation, confirm operation by monitoring run status (to check the load rate; select **Execute/Operation/Monitor Run Status**) and validating actions (select **Validate Action/Start**) with CX-Process Tool. In particular, be sure to confirm that the load rate will be less than 60%. (For details on the load rate, refer to the *Loop Control Unit Operation Manual*.)
-  **Caution** The Loop Control Unit can read and write I/O memory in the CPU Unit using the Field Terminal Function Blocks or CPU Terminal Blocks independent of the user program (Step Ladder Program) in the CPU Unit. Do not write to the same I/O memory words from both the Loop Control Unit and the CPU Unit.
-  **Caution** To hold an analog output or contact output at a specific value (for example, the maximum value or minimum value) when the Loop Control Unit stops running, create a Step Ladder Program in the CPU Unit so that the corresponding output bit allocated to Analog Output Unit or Contact Output Unit is set to the desired value using an NC condition of the Loop Control Unit Running Flag (bit 00 in allocated CIO word “n”) as an input condition.
-  **Caution** If a fatal error occurs in the CPU Unit (including fatal errors created by execution of an FALS instruction), the Loop Control Unit will also stop running. To hold analog outputs to the previous values before the stop occurred, and to set analog outputs to either the minimum value or maximum value, use the output hold function of the Analog Output Unit or Analog I/O Unit.
-  **Caution** Before turning ON the power to the PLC, make sure that the facilities are safe. The analog output values and contact outputs from the Loop Control Unit are updated when the power to the PLC is turned ON regardless of the operating mode of the CPU Unit (including in the PROGRAM mode). (Internally, the analog output values and contact outputs are sent from the CPU Unit to Basic I/O Units and Analog Output Units.)
-  **Caution** Fail-safe measures must be taken by the customer to ensure safety in the event of incorrect, missing, or abnormal signals caused by broken signal lines, momentary power interruptions, or other causes.
-  **Caution** Confirm that no adverse effect will occur in the system before attempting any of the following:

- Changing the operating mode of the PLC
- Force-setting/force-resetting any bit in memory
- Changing the present value or any set value in memory

 **Caution** Be sure that all mounting screws, terminal screws, and cable connector screws are tightened to the torque specified in the user manuals. Incorrect tightening torque may result in malfunction.

 **Caution** In the event of system or power failure, CX-Process function files (extension “.ist”) may not be saved. It is recommended that function files are saved regularly.

SECTION 1

Introduction

This section introduces the CX-Process Monitor.

- 1-1 CX-Process Monitor 2
 - 1-1-1 Outline 2
 - 1-1-2 Screen Outlines 4
 - 1-1-3 CX-Process Monitor System Requirements 9
 - 1-1-4 Relationship to CX-Process Tool 10
 - 1-1-5 Relation between Screens and Function Blocks 12
 - 1-1-6 Monitor Software Specifications 13
 - 1-1-7 CX-Process Monitor Setting and Monitoring Capabilities 17
 - 1-1-8 Version Changes 17
- 1-2 Basic Operating Procedure 18

1-1 CX-Process Monitor

1-1-1 Outline

The CX-Process Monitor is a Windows NT/2000/XP-based application that monitors the Function Block data within the Loop Control Unit using selection, Control screen (on-site instrument image), Trend screen, Graphic screen, and Annunciator screen, etc., via the Controller Link, serial communications, or an Ethernet. The CX-Process Monitor uses settings and the CX-Process Tool to create function blocks within Loop Control Units.

Note To use the CX-Process Monitor, you also need License key WS02-LCTK1-EL01 (sold separately). In addition to installing the CX-Process Monitor, make sure to first connect License key WS02-LCTK1-EL01 to the IBM PC/AT or compatible printer port, and then install the License key driver before using the CX-Process Monitor. Also, when using the CX-Process Monitor, make sure that the License key WS02-LCTK1-EL01 is always connected to the printer port.

You can also perform the following four functions.

Monitoring Function Blocks in a Loop Control Unit

Monitor PV, SP, and MV, etc., within the Control Block, monitor analog signals, and monitor contact signals.

Perform Run/Stop instructions in the Loop Control Unit.

Display the status of the CPU Unit, such as the current operating mode.

Controlling Function Blocks in a Loop Control Unit

Change settings, switch between auto and manual, and perform manual operations, tune PID constants, etc., in the Control Block.

You can perform stop block operation commands for each Control Block (when using the Tuning screen).

Monitoring Function Block Alarm Status in a Loop Control Unit

Display Control Block and Alarm Block alarms if they occur, and store the alarms in the alarm history.

Configuring CX-Process Monitor Screens

You can configure the screen to suit your needs.

CX-Process Monitor Functions

---	Screen	Monitoring operating status	Controlling operation	Monitoring alarm status
User-defined screens	Overview	---	---	OK
	Control	OK (Display PV bar)	OK (Change SP, switch between auto/manual, and perform manual operations)	OK
	Tuning	OK (Display PV, SP, and MV trends for 1 loop)	OK (Change SP, and change P, I, D, etc.)	OK (Change bar graph colors)
	Trend	OK (Display Control Block or analog signal trends)	---	OK
	Graphic	OK (Display status for contact or analog signal graphics)	OK (Turn ON/OFF the contact, and set the analog value)	OK
	Annunciator	---	---	OK (Use colors or sound to notify of an alarm)
	Operation Guide Message	OK (Display message when Internal Switch is turned ON)	---	OK
	System Monitor	OK (Display the run/stop status for the Loop Control Unit, display Execution errors, RAM checksum errors, and battery errors, and monitor the status of the CPU Unit control mode, etc.)	OK (Run/stop command for the Loop Control Unit)	OK
System screens	Alarm Log	---	---	OK (Stored when an alarm occurs)
	Operation Log	---	OK (Stores run operation history; e.g., SP change, etc.)	OK
	System Monitor Log	OK (Displays run/stop command history and Execution error history when an error occurs)	---	OK

Note If License key WS02-LCTK1-JL01 is not connected to the IBM PC/AT or compatible printer port, or even if it is connected, if the License key driver is not installed, you cannot use the following monitor screens or configuration screens. (If you try to switch to the following screens, an error message will be displayed.)

Monitor Screens

Item	Screen
User-defined screens	Trend Screens
	Graphic Screens
	Operation Guide Screens
System screens	Alarm Log Screens
	Operation Log Screens
	System Monitor Log Screens

Configuration Screens

Item	Screen
Created using Graphic Builder Button	Graphic Screen Create Window

1-1-2 Screen Outlines

Overview Screen

Possesses the functions of all menu screens and alarm display screens.

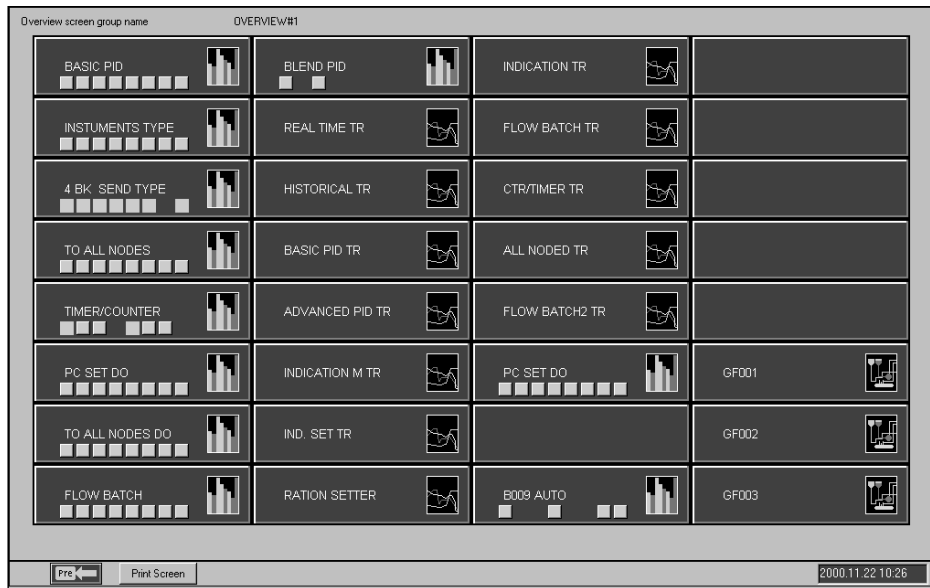

Control Screens

Monitor and set the Control Block and part of the Operation Block, monitor analog signals, and monitor and set contact signals.

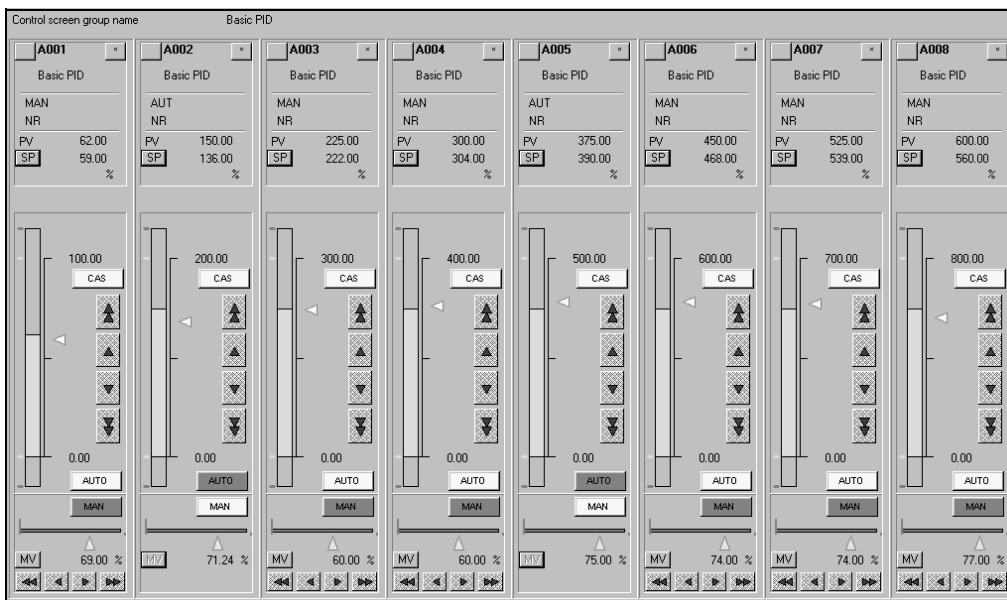

Tuning Screens

Use this screen to change Control Block P, I, D constants specified using Send Terminals per block addressed to the computer.

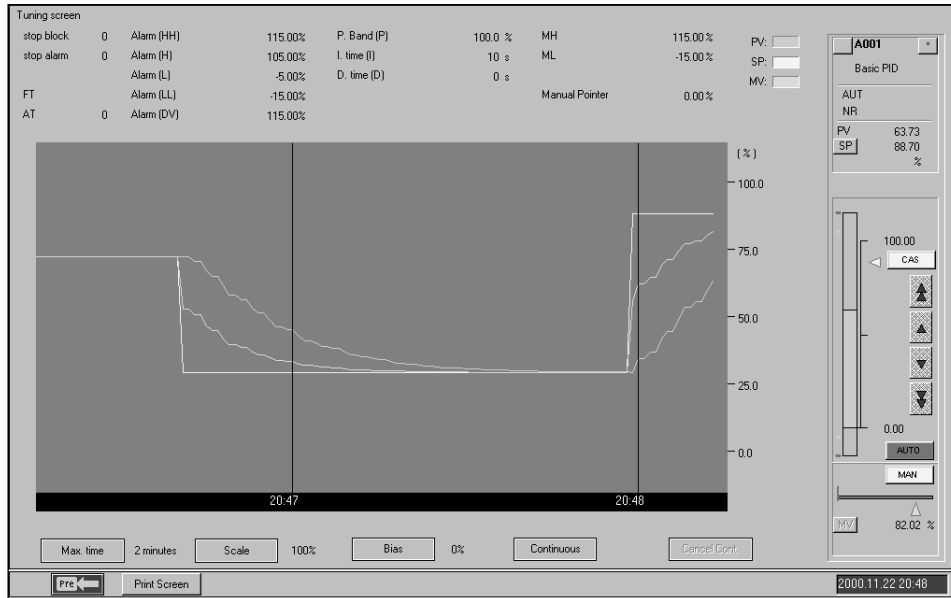

Trend Screens

Display as an image changes due to the passage to time of the Control Block PV, SP, MV, or other analog signals.

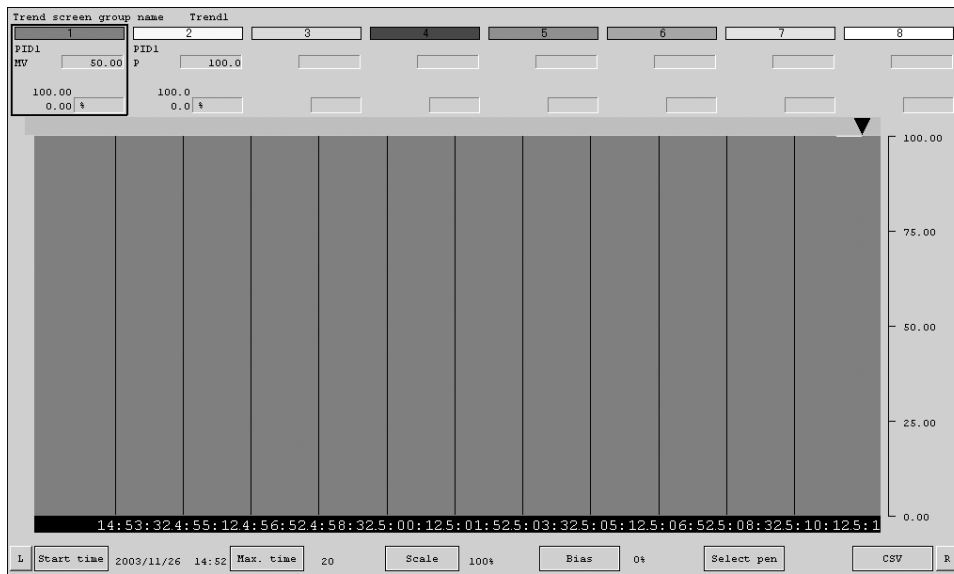

Graphic Screens

Use the screen to display the device status as a schematic.

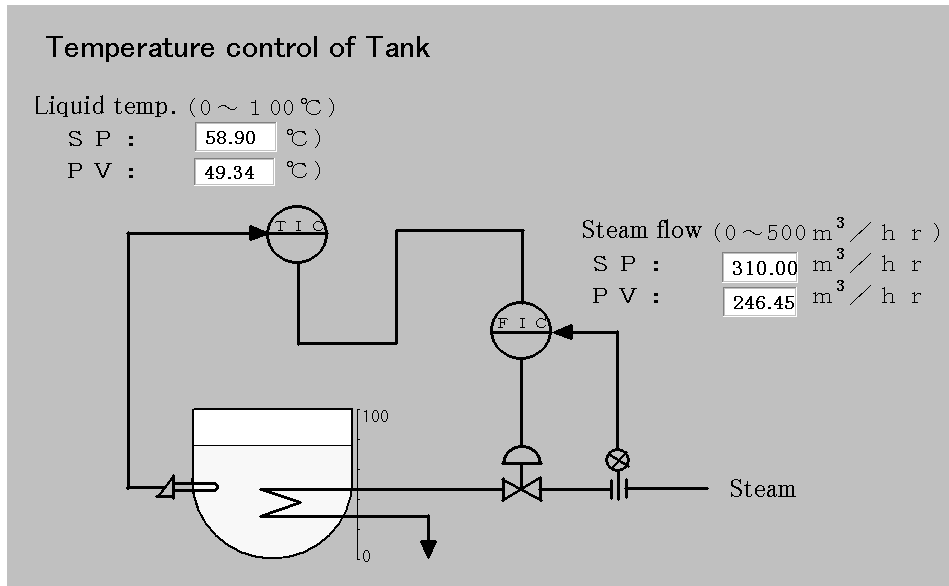

Annunciator Screens

Use this screen to display comprehensively the status (mainly the alarm status) of the contacts.

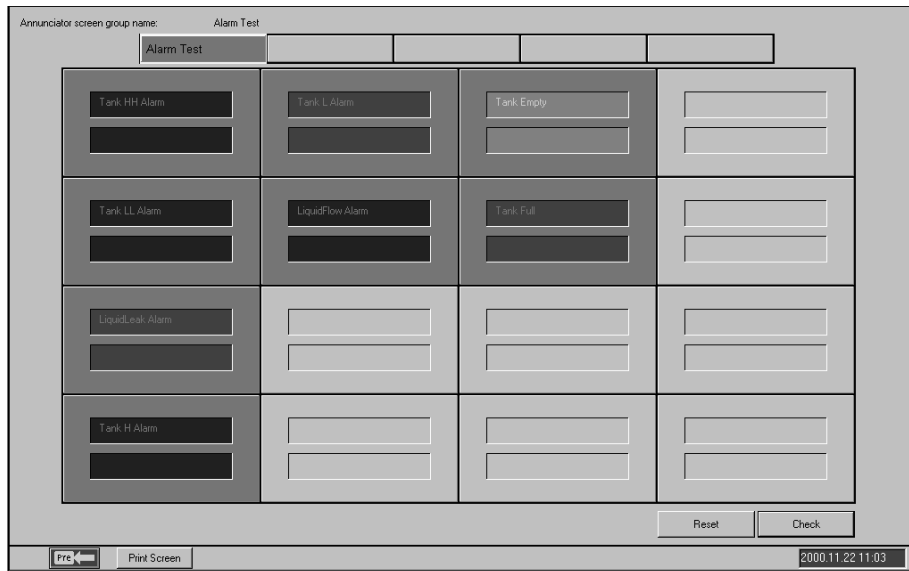

Operation Guide Screens

Use this screen to display registered messages when the contact signal is ON.

Operation Guide Message screen OpplLog Mess 01 01/01

2000.11.15 14:39:11 Message TOP	Message MID
2000.11.15 14:39:09 Omron Technocult Co., LTD I Project Masamitsu Shibayama	
2000.11.15 11:08:24 Message TOP	Message MID
2000.11.15 11:08:22 Omron Technocult Co., LTD I Project Masamitsu Shibayama	
2000.11.15 10:16:41 Message TOP	Message MID
2000.11.15 10:16:39 Omron Technocult Co., LTD I Project Masamitsu Shibayama	
2000.11.15 10:12:58 Message TOP	Message MID
2000.11.15 10:12:54 Omron Technocult Co., LTD I Project Masamitsu Shibayama	

CSV PREV PAGE NEXT PAGE NEW PAGE

Print Screen Print 2000.11.22 20:50

Alarm Log Screens

Use this screen to display the alarm history.

Alarm Log screen group name AlmLog Mess 01 01/04

2000.11.22 14:36:20 b031	Blend-PID	0.00 %	Deviation Low limit alarm reset
→ 2000.11.22 14:36:20 B030	3-positionON/OFF	0.00 %	FV Low limit alarm occurred
● 2000.11.21 19:09:12 dummy-2	dummy-2	15.00 %	FV Low/Low limit alarm reset
● 2000.11.21 19:09:12 dummyt	dummyt	15.00 %	FV Low/Low limit alarm reset
● 2000.11.21 19:09:12 A006	Basic PID	90.00 %	FV Low/Low limit alarm reset
● 2000.11.21 19:09:12 A001	Basic PID	15.00 %	FV Low/Low limit alarm reset
● 2000.11.21 19:08:58 A006	Basic PID	90.00 %	FV Low/Low limit alarm occurred
● 2000.11.21 19:08:58 A001	Basic PID	15.00 %	FV Low/Low limit alarm occurred
● 2000.11.21 19:08:56 dummy-2	dummy-2	15.00 %	FV Low/Low limit alarm occurred
● 2000.11.21 19:08:56 dummyt	dummyt	15.00 %	FV Low/Low limit alarm occurred
● 2000.11.21 19:07:38 A006	Basic PID	90.00 %	FV Low/Low limit alarm reset
● 2000.11.21 19:07:38 A001	Basic PID	15.00 %	FV Low/Low limit alarm reset
● 2000.11.21 19:07:36 dummy-2	dummy-2	15.00 %	FV Low/Low limit alarm reset
● 2000.11.21 19:07:36 dummyt	dummyt	15.00 %	FV Low/Low limit alarm reset
● 2000.11.21 18:38:03 A006	Basic PID	90.00 %	FV Low/Low limit alarm occurred
● 2000.11.21 18:38:03 A001	Basic PID	15.00 %	FV Low/Low limit alarm occurred
● 2000.11.21 18:38:02 dummy-2	dummy-2	15.00 %	FV Low/Low limit alarm occurred
● 2000.11.21 18:38:02 dummyt	dummyt	15.00 %	FV Low/Low limit alarm occurred
● 2000.11.21 18:37:53 A006	Basic PID	90.00 %	FV Low limit alarm reset
● 2000.11.21 18:37:53 A001	Basic PID	15.00 %	FV Low limit alarm reset

CSV ALL HEAVY LIGHT CONTINUE PREV PAGE NEXT PAGE NEW PAGE

Print Screen Print 2000.11.22 20:51

Operation Log Screens

Use this screen to display the operation history.

Operation Log screen group name		Control Mess 01		01/08		
2000.11.22 20:47:56 A001	Basic PID	LP_SP	88.70	29.00	%	
2000.11.22 20:46:39 A001	Basic PID	LP_SP	29.70	72.00	%	
2000.11.22 20:45:03 A001	Basic PID	LP_SP	72.70	87.00	%	
2000.11.22 20:45:03 A001	Basic PID	LP_SP	73.70	87.00	%	
2000.11.22 20:45:02 A001	Basic PID	LP_SP	74.70	87.00	%	
2000.11.22 20:45:02 A001	Basic PID	LP_SP	75.70	87.00	%	
2000.11.22 20:45:02 A001	Basic PID	LP_SP	76.70	87.00	%	
2000.11.22 20:45:02 A001	Basic PID	LP_SP	77.70	87.00	%	
2000.11.22 20:44:55 A001	Basic PID	LP_SP	87.70	81.00	%	
2000.11.22 20:44:52 A001	Basic PID	LP_SP	81.70	45.00	%	
2000.11.22 20:44:47 A001	Basic PID	LP_SP	45.70	29.00	%	
2000.11.22 20:43:46 A001	Basic PID	LP_SP	29.70	66.00	%	
2000.11.22 20:43:40 A001	Basic PID	A/M_SW	1	1	%	
2000.11.22 20:43:40 A001	Basic PID	R/L_SW	0	1	%	
2000.11.22 16:30:15 A001	Basic PID	A/M_SW	1	1	%	
2000.11.22 16:30:15 A001	Basic PID	R/L_SW	0	0	%	
2000.11.22 15:53:45 A001	Basic PID	LP_SP	80.00	0.00	%	
2000.11.22 15:27:12 A001	Basic PID	LP_SP	0.00	80.00	%	
2000.11.22 15:27:11 A001	Basic PID	LP_SP	1.00	80.00	%	
2000.11.22 15:27:10 A001	Basic PID	LP_SP	-7.00	80.00	%	

2000.11.22 20:52

System Monitor Screens

Use this screen to display the system status, and run/stop the Loop Control Unit.

System Monitor screen

Node number	01	02	03	04	05	06	07
CPU Unit	<input type="button" value="C"/> running <input type="button" value="M"/>						
LC001-1	<input type="button" value="1"/> running <input type="button" value="E"/>						
-2	<input type="button" value="2"/> Not registered <input type="button" value="E"/>						
-3	<input type="button" value="3"/> Not registered <input type="button" value="E"/>						
Node number	08	09	10	11	12	13	14
CPU Unit							
LC001-1							
-2							
-3							
Node number	15	16	17	18	19	20	21
CPU Unit							
LC001-1							
-2							
-3							
Node number	22	23	24	25	26	27	28
CPU Unit							
LC001-1							
-2							
-3							
Node number	29	30	31	32			
CPU Unit							
LC001-1				<input type="button" value="CLK"/> <input type="button" value="Run"/> <input type="button" value="DTL"/>			
-2							
-3							

2000.11.22 21:15

System Monitor Log Screens

Use this screen to display the run/stop history and Execution error history, and to record the time at which they occurred.

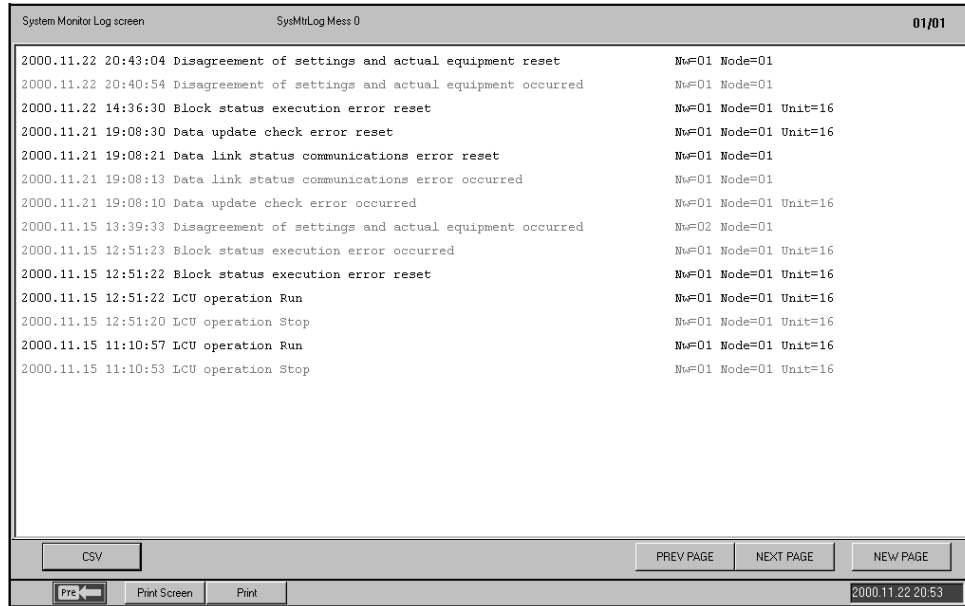

1-1-3 CX-Process Monitor System Requirements

FinsGateway Version 3

As shown below, the CX-Process Monitor uses the communications driver FinsGateway Version 3 (Embedded version) to communicate with the PLC (Programmable Controller) mounted to the Loop Control Unit.

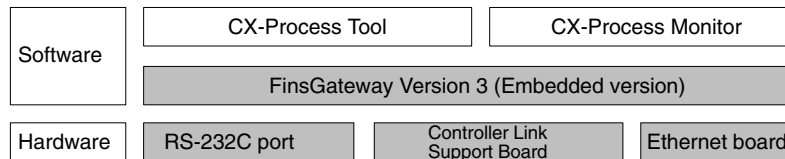

You can use any one of the FinsGateway Version 3 (Embedded version) given below.

- Serial Unit driver
- Controller Link driver
- CLK (PCI) driver
- ETN_UNIT driver

Creating Monitor Tag Files Using CX-Process Tool

The CX-Process Monitor reads/writes data within the Loop Control Unit via the Tag names of Execution blocks addressed to the IBM PC/AT or Compatible set using the CX-Process Tool. Consequently, when using the CX-Process Monitor, you must first set items 1 to 3 below, using on the CX-Process Tool.

- 1, 2, 3...** 1. Register the Function Block to Exchange Data with the CX-Process Monitor. Specify a Function Block, analog signal (including parameters), or contact signal (including parameters) as the source, depending on the Send Terminal to Computer Block (Block Models 401 to 404), using on the CX-Process Tool. Also, prepare to receive analog signals or contact signals from the IBM PC/AT or compatible using on the IBM PC/AT or compatible AO setting or DO Terminal Block setting.
2. Set the Tag Name. Next, set the Tag name for the Function Block, analog signal (including parameters), or contact signal (including parameters) you have set as the

source, using the CX-Process Tool. Also, set the Tag name for the analog output or contact output for the IBM PC/AT or compatible AO setting or DO Terminal setting. At the same time, you must set the zero point, span point, decimal point location, and the engineering units scaling for the analog signals (including parameters).

3. Compile Tag Files for the CX-Process Monitor.

Compile Tag files to pass Tag data to the CX-Process Monitor. The Tag files must be compiled using the CX-Process Tool installed on the same computer as the CX-Processor Monitor.

Note Monitor Tag files are stored in the following directory with fixed file names.

Directory: Omron/CX-Process Monitor/db (The underlined part is the directory in which the CX-Process Monitor is installed.)

File name: mtagmst, and mtagsubmst

It is possible to create multiple Monitor Tags and switch between them. For details, refer to *4-6 Screen Configuration*.

Set Network Address, Node Address, and Unit Address Using CX-Process Tool

The network address, node address, and unit address for communications between the CX-Process Monitor and PLC using the CX-Process Tool address settings (**Setting/Network**).

- Note**
1. Be aware that you cannot start CX-Process Monitor if FinsGateway Version 3 (Embedded version) is not installed.
 2. CX-Process (Monitor and Tool) cannot use FinsGateway Version 1 as a communications driver. Be sure to use Version 3.
 3. If CX-Programmer, CX-Protocol, CX-Motion, or other Support Software (i.e., CX-Server communications software), or applications that use special serial drivers, are connected online, they use the same COM port, so CX-Process (Monitor and Tool) cannot connect online (i.e., initialize serial communications) using the Host link (SYSMAC WAY). First disconnect offline other Support Software or applications that use special serial drivers, before reconnecting online (i.e., initializing serial communications) CX-Process. Conversely, while CX-Process is connected online (i.e., initializing serial communications), other Support Software that communicate using CX-Server cannot connect online.
 4. You cannot install CX-Process and FinsGateway Version 1 on the same IBM PC/AT or compatible.
 5. If using Windows NT 4.0 as your OS, you must use Service Pack 4 or later.
 6. FinsGateway Version 3 (Embedded version) is bundled with CX-Process, but you can also use FinsGateway Version 3 (Runtime version). If FinsGateway Version 3 (Runtime version) is already installed, you do not need to install FinsGateway Version 3 (Embedded version).

1-1-4 Relationship to CX-Process Tool

Tag Names

(As shown earlier in *CX-Process Monitor Conditions of Use*, if monitoring or operating Function Blocks using CX-Process monitor, you must first compile Tag names and Monitor Tag files using CX-Process Tool. Also, CX-Process Monitor handles all items allocated Tag names as one string. CX-Process Monitor does not differentiate which Function Block was used to specify the Tag names; Send to Computer Block, DO/AO Terminal to all Nodes Block, or DO/AO Terminal Settings from Computer Block. (In Tuning screen, however, you can use only the Function Block specified using 1-Block Send Terminal to Computer.

ITEM Settings

Function block ITEMS are set as shown in the following table. The CX-Process Tool is normally used to set initial data S and the CX-Process Monitor is normally used to set operation data O.

CX-Process Tool data classification	Type	ITEM	Example: PID Block	CX-Process Tool	CX-Process Monitor
Initial settings	S	Initial setting parameter for each function block	Forward/Reverse direction, SP setting method, compensation method, etc.	Set	Cannot be set
Operation data	O	Operation parameters for each function block	Example: PID Block SP, alarm settings, PID constants, etc.	Set in special cases	Set

Note Initial settings O and operation data S classifications are displayed on ITEM Setting Screens of the CX-Protocol Tool. For details on the ITEMS set each function block, refer to the *Function Block Reference Manual*.

Example

ITEM type	ITEM	Contents	R: Read, W: Write, R/W: Read/write, ---: R/W disabled r, t/w: CX-Process Tool operation monitor/Operation monitor read and write (S): Initial setting, (O): Operation data	
			CX-Process Tool	CX-Process Monitor
Parameter	004	Operation cycle (s)	R/W (S)	---
Parameter	008	High/Low alarm	R/W (O)	R/W
	012	Hysteresis set value	R/W (S)	---
Parameter	023	Local SP set value	R/W (O)	R/W
	024	SP set method (Initial setting) 0: Local, 1: Remote/Local	R/W (S)	R

Note Analog values are normally set with the CX-Process Monitor. They can be set with the CX-Process Tool provided that they are in percentage increments between 0% and 100%. Scaling engineering units cannot be set with the CX-Process Tool.

1-1-5 Relation between Screens and Function Blocks

The relation between screens and function blocks is shown below.

Screen		1-Block Send to Computer (403)	4-Block Send to Computer (404)	AO to Computer (402), AO Terminal to All Nodes (408)	DO to Computer (401), DO Terminal to All Nodes (407)	AO Terminal Settings from Computer (410)	DO Terminal Settings from Computer (409)
User-defined screens	Overview Screen	---	---	---	---	---	---
	Control Screens	Basic PID, Advanced PID, batch flowrate capture (See note), Indication and Setting, Indication and Operation, Ratio Setting, Indicator, 2-Position ON/OFF, 3-Position ON/OFF, blended PID	Basic PID, Advanced PID, Indication and Setting, Indication and Operation, Ratio Setting, Indicator, 2-Position ON/OFF, 3-Position ON/OFF, High/Low Alarm, Segment Program 2, ON/OFF Valve Manipulator, Motor Manipulator, Reversible Motor Manipulator, Motor Opening Manipulator, Timer, Counter	Analog signal or analog value parameters	Contact signal or contact parameters	Analog output	Contact output
	Tuning Screens	(As above)	Segment Program 2	---	---	---	---
	Trend Screens	(As above) (PV, SP, MV only)	Basic PID, Advanced PID, Indication and Setting, Indication and Operation, Ratio Setting, Indicator, 2-Position ON/OFF, 3-Position ON/OFF (PV, SP, MV only), Segment Program 2, ON/OFF Valve Manipulator, Motor Manipulator, Reversible Motor Manipulator, Motor Opening Manipulator	Analog signal or analog value parameters	Contact signal or contact parameters	Analog output	Contact output
	Graphic Screens	Tag ITEMS as above	Same tag ITEMS as for Control screens.	Analog signal or analog value parameters	Contact signal or contact parameters	Analog output	Contact output
	Annunciator Screens	Contacts within tag ITEMS as above	Same tag ITEMS as for Control screens.	---	Contact signal or contact parameters	---	Resend contact output
	Operation Guide Message Screens	---	---	---	Contact signal or contact parameters	---	Resend contact output
	System Monitor Screens	---	---	---	---	---	---

Screen		1-Block Send to Computer (403)	4-Block Send to Computer (404)	AO to Computer (402), AO Terminal to All Nodes (408)	DO to Computer (401), DO Terminal to All Nodes (407)	AO Terminal Settings from Computer (410)	DO Terminal Settings from Computer (409)
System screens	Alarm Log Screens	Alarms only within Tag ITEMS as above	Same as alarm tag ITEMS as for Control screens.	---	---	---	---
	Operation History Screens	---	---	---	---	---	---
	System Monitor Log Screens	---	---	---	---	---	---

Note Be sure to send Batch Flowrate Capture (014) and Blended PID (013) using 1-Block Send Terminal to Computer (403). You can specify batch flowrate capture (014) and blended PID (013) as the send source for 4-Block Send Terminal to Computer (404) using CX-Process Tool. You cannot monitor batch flowrate capture sent using 4-Block Send Terminal to Computer (404) using CX-Process Monitor, however.

1-1-6 Monitor Software Specifications

CX-Process Monitor Specifications

Item		Descriptions
Product name		CX-Process Monitor
Model		WS02-LCTC1
Applicable PLC-series		CS1-series
Applicable Unit		Loop Control Unit
Applicable computer	Personal computer	PC AT or compatible
	CPU	Min. required: Pentium MMX233 MHz or faster, Recommended: Pentium Celeron 400 MHz or faster
	OS	Microsoft Windows NT4.0 Service Pack 4 or later, Windows 2000, or Windows XP (Windows 95 and 98 cannot be used.)
	Memory	Min. required: 96 Mbytes, Recommended: 128 Mbytes or more
	Hard disk drive	Min. required: 400 Mbytes of free space, Recommended: 500 Mbytes or more of free space
	Monitor	Min. required: XGA, Recommended: XGA or higher, min. 1024 x 768 dots, 256 colors
	CD-ROM drive	At least one
	Mouse	Recommended: Microsoft mouse or compatible pointing device
	Printer (See note.)	Any printer supported by Microsoft Windows.
	Sound board	1 board
Required software		One of the FinsGateway Version 3 (Embedded version) drivers given below must be installed on the computer. Serial Unit driver (Host Link) Controller Link driver (Controller Link) CLK (PCI) driver (Controller Link, PCI bus) ETN_UNIT driver (Ethernet)

Item		Descriptions		
Connecting method	Connection with CPU Unit (or Serial Communications Board/Unit)	Using FinsGateway Serial Unit version	The computer is connected to the CPU Unit peripheral ports or integrated RS-232C port, or RS-232C port of the Serial Communications Unit. (Only a 1:1 connection is possible.) – Connector cable: When connecting to the CPU Unit peripheral ports: Model CS1W-CN□□□ (2 m, 6 m) When connecting to the CPU Unit's RS-232C port: Model XW2Z□□□-□ (2 m, 5 m) – Communications protocol with PLC: Host Link (not supported on Peripheral bus)	
	Connection via Controller Link	Using FinsGateway CLK (PCI) Driver	Install the driver in a computer equipped with a Controller Link Support Board (PCI slot) to support communications between the computer and PLCs equipped with a Controller Link Unit.	
		Using FinsGateway Controller Link driver	Install the driver in a computer equipped with a Controller Link Support Board (ISA slot) to support communications between the computer and PLCs equipped with a Controller Link Unit.	
	Connection via Ethernet	Using FinsGateway ETN_UNIT driver	Install the FinsGateway ETN_UNIT driver on the computer on which an Ethernet board is mounted to enable to enable communications with the PLC on which the Ethernet Unit is mounted.	
Loop Control Unit data specification method		Function blocks, analog signals and contact signals (including parameters) that are designated as the source by the Send to Computer blocks (Block Models 401 to 404) are appended a tag name by the CX-Process Tool. Specify this tag name to specify the Loop Control Unit data.		
Data exchange method with CPU Unit mounted on Loop Control Unit		Mode name	Description	Connection method
		On-demand read mode:	CX-Process Monitor reads the data in the terminal to computer send area whenever necessary.	One of Host Link, Ethernet or Controller Link
		Data Link mode:	CX-Process Monitor reads the terminal to computer send area at all times by the Controller Link data link.	Only Controller Link is possible
Offline operation functions		Prepare the user configuration screen for use in the online operation screen.		

Item		Descriptions		
Online operation functions	User Configuration screen	Overview screen	Place buttons for progressing to the Control screen, Trend screen and other screens. 4 columns and 8 lines are displayed on each screen (max. 32 screens).	
		Control screen	Control blocks such as the PID blocks and Indication blocks, and some Operation blocks are displayed for up to 8 loops in a single screen in the form of a field device. The maximum number of screens is 400. This screen displays the Set Point, PV and MV numeric values, displays PV as a bar graph, and can be used for changing Set Point, MAN and other setting values. The color of bar graphs changes when an alarm occurs. You can progress to the Tuning screen from the Control screen. Fine tuning according to the degree specified by the user is possible for PID constants.	
		Tuning screen	This screen is for setting P, I, D parameters in Control blocks such as the PID blocks, and for setting alarm setting values. PV, Set Point and MV can be tuned while their trends are monitored. The maximum number of screens is 3200. Run stop/stop cancellation are possible on each function block. Note Only the Control block that is designated as the source at the 1-Block Send Terminal to Computer block can be registered.	
		Trend screen	The analog signals (analog values such as the Control block Set Point, PV and MV, and other analog values) input from the terminals to the computer are collected at a fixed cycle and saved to a file. If necessary, up to 8 analog signals can be displayed on one screen in the form of a multi-dot recorder.	
		Data collected (logger function)	<table border="1"> <tr> <td>Real time trend 12 hour's of data is saved at 10-second cycles appended with up to 480 tags. Output possible in CSV format.</td> <td rowspan="2">Data can be saved in CSV format either using button commands, or automatically at a set interval (every 1, 2, 3, 4, 6, 8, 10, 12, 18, 20, 24, 48, 72, 96, 120, or 240 hours)</td> </tr> <tr> <td>Historic trend 10 day's of data is saved at 1-minute cycles appended with up to 960 tags. Output possible in CSV format.</td> </tr> </table>	Real time trend 12 hour's of data is saved at 10-second cycles appended with up to 480 tags. Output possible in CSV format.
Real time trend 12 hour's of data is saved at 10-second cycles appended with up to 480 tags. Output possible in CSV format.	Data can be saved in CSV format either using button commands, or automatically at a set interval (every 1, 2, 3, 4, 6, 8, 10, 12, 18, 20, 24, 48, 72, 96, 120, or 240 hours)			
Historic trend 10 day's of data is saved at 1-minute cycles appended with up to 960 tags. Output possible in CSV format.				
Data display	Horizontal (time) axis: 2, 4, 8, 12 and 24 hour time units can be scrolled Vertical (8-point common) axis: Graduation can be enlarged by a factor of 1, 2, 5 and 10. Data is displayed from the time when the specified display start time is reached. Display color: red, yellow, green, blue, magenta, purple, cyan, white			

Item		Descriptions	
Online operation functions	User Configuration screen	Graphic screen	<p>This screen displays changes in the plant status using graphic elements representing plant devices pasted to the screen from the graphic elements library (provided with the CX-Process Monitor). The maximum number of screens is 200.</p> <p>Fixed graphic elements provided in library: Devices, thermometers, transmitters, orifices, text</p> <p>Variable graphic elements provided in library:</p> <p>Analog input: Bar graph display, numeric indication, tanks</p> <p>Analog output: Numeric setting (by AO Terminal Settings from Computer block)</p> <p>Contact input: Pumps, valves, indicators</p> <p>Contact output: Switches (by DO Terminal Settings from Computer block)</p>
		Annunciator screen	<p>This screen notifies the operator of alarms or errors that occur by changing the display color and emitting sound. At the same time, a 32-character message is displayed over two lines on screen elements.</p> <p>A total of 16 screen elements (4 columns x 4 lines) can be displayed on each screen. The maximum number of screens is 5.</p>
		Operation Guide Message screen	<p>This screen displays pre-registered 128-character messages over two lines together with the date of occurrence when the specified internal switch is set to ON.</p> <p>Max. number of registerable messages: 100, Number of display colors: 7</p> <p>Up to 1000 messages are displayed in a single screen.</p> <p>Output possible in CSV format.</p>
Online operation functions	System Fixed screen	Alarm Log screen	<p>A record of alarms (time of error occurrence, tag name, PV or MV current value at occurrence, alarm type, etc.) that occur and that are input from the Control and Alarm blocks is saved and displayed as a list later.</p> <p>Up to 1000 alarm messages are displayed in a single screen.</p> <p>Output possible in CSV format.</p>
		Operation Log screen	<p>A record of changes (date and time of change, tag name, original ITEM data setting, new ITEM data setting, etc.) made to ITEM data on the Loop Control Unit in the Control or Tuning screen is saved and displayed as a list later.</p> <p>Up to 1000 operation messages are displayed in a single screen.</p> <p>Output possible in CSV format.</p>
		System Monitor screen	<p>This screen displays the Loop Control Unit operation run/stop commands, operation start/stop status, execution errors, RAM sum errors, battery errors, and the status of the Controller Link Data Link.</p>
		System Monitor Log screen	<p>This screen displays a log of the run/stop history and a history of execution errors that occur on the Loop Control Unit together with the date of occurrence.</p> <p>Output possible in CSV format.</p>

1-1-7 CX-Process Monitor Setting and Monitoring Capabilities

Target	Function Block		Read using CX-Process Monitor	Written using CX-Process Monitor
Control Block (and part of Operation Block) Tag ITEMS (See note 1)	1-Block Send Terminal to Computer (403) or 4-Block Send Terminal to Computer (block 404)		OK	OK
Contact signal (including parameters) or analog signal (including parameters)	DO Terminal Settings from Computer (block 401)/AO Terminal Settings from Computer (block 402), or DO Terminal to all nodes (block 407)/AO Terminal to all nodes (block 408)		OK	Not possible
Contact output or analog output	DO Terminal Settings from Computer (block 409), AO Terminal Settings from Computer (block 410)	Resend signal to Network ON	OK	OK
		Resend signal to network OFF	Not possible (You cannot use CX-Process Monitor when resend signal is OFF)	OK

- Note**
1. Refer to *Appendix A ITEM Settings for Function Blocks* for which tag ITEMS you can monitor and set using CX-Process Monitor for Function Blocks specified as send source using 1-Block Send Terminal to Computer or 4-Block Send Terminal to Computer.
 2. Using CX-Process Monitor, you can monitor and set only the data given above to which Tag names have been allocated. Also, be sure to use CX-Process Tool to make Tag name settings.
 3. If using Tuning screen, be sure to use 1-Block Send Terminal to Computer (403). You cannot register data on the Tuning screen using 4-Block Send Terminal to Computer.
 4. The Control Block and part of the Operation Block (with 4-Block Send Terminal to Computer) are the only Function Blocks that can send to CX-Process Monitor using 1-Block Send Terminal to Computer or 4-Block Send Terminal to Computer. Also, ITEMS within these blocks are determined beforehand for each Function Block as the default. (Fixed names called Tag ITEMS are allocated to each ITEM.) To send other ITEMS (contact or analog value parameters) to CX-Process Monitor, specify the required ITEM as the send source using DO to Computer or AO to Computer (or DO Terminal to all nodes or AO Terminal to all nodes).

1-1-8 Version Changes

Version 2.50 to 2.60

The following functions have been added to the CX-Process Monitor with the upgrade from Ver. 2.50 to Ver. 2.60.

- Alarms can be selected to sound at recovery (recovery alarm setting).
- Tag ITEMS MHA and MLA can be selected to function as warnings (MHA, MLA alarm setting).
- The alarm sound can be stopped for a specified tag (alarm stop function).
- The Next/Prev. Buttons can be set to move in Block Database registration order or Builder Window display order (page order function)
- The number of messages that can be registered as alarm messages has been expanded from 50 to 2,000.
- The Trend Screen has been changed.
- The pen can be changed, deleted, or added in the Trend Screen without having to shut down Monitor Plus (changing online trend definitions).

Version 2.00 to 2.50

The following functionality has been added or upgraded in version 2.50 (compared to version 2.00).

- FinsGateway Version 3 (embedded version) is now supported.
Although version 2.00 of the Process Monitor supported FinsGateway Version 2 (embedded version), either FinsGateway Version 2 or Version 3 (embedded version) can be used as the communications driver for version 2.50.
- Windows 2000 is now supported.
- The monitor process startup operation when configuring screens has been changed.
The monitor process will start automatically when the File Mapping Button is clicked when configuring screens. (With version 2.00, the Start Up Button had to be clicked before the monitor process would start.)
- The graphic file name can now be displayed for a graphic screen button on the overview screen.

Version 1.50 to 2.00

The following functionality has been added or upgraded in version 2.00 (compared to version 1.50).

- Fine tuning can now be used to adjust PID constants to the extent specified by the user.
- An Auto-start setting is now available in System Information to specify the screen to be automatically displayed when the CX-Monitor is started.
- The trend data collected for a Trend screen can be automatically saved to an CSV file as a specified interval. The file name and save interval are specified when creating the Trend screen. You can also set an alarm or error to occur when available disk space has reached a set level (CSV save settings in the System Information).
- More than one overview mode screen can be displayed at the same time (Multi-screen settings in System Information).
- An Auto-exit setting is available to automatically exit the background task (monitor process) for automatic ends in Operator Mode.
- The unit can be displayed to engineering units or percentages for the scale display in a Tuning or Trend screen (Auto-start settings in System Information).
- Direct switching is possible from an Overview screen to a Tuning screen, and the type of Tuning screen (list or analog) can be specified (Auto-start settings in System Information).
- Previous/Next Page Buttons have been added to switch between the same type of screen without going through the Overview screen.
- Time-scrolling can be performed on a Trend screen using Arrow Buttons.
- The color can be specified for alarms on an Annunciator screen (Auto-start settings in System Information).
- A setting is available to control the display of confirmation dialog boxes when contact output buttons are pressed. (Added to color settings in System Information.)
- A tenkey size setting (large/small) has been added.
- Printing the entire screen (hardcopy) has been added.
- Printing is supported for Operation Guide Message Screens, Alarm Log Screens, Operation Log Screens, and System Monitor Log Screens.

1-2 Basic Operating Procedure

This section explains the procedure up to monitoring using CX-Process Monitor. Before performing settings and operations using CX-Process Monitor, you must make the following settings using CX-Process Tool.

- 1, 2, 3...**
1. Install CX-Process Monitor and License Key Driver (Refer to *Section 2 Setup*).
 - a) Install CX-Process Monitor.
 - b) Mount License key WS02-LCTK1-EL01 to the IBM PC/AT or compatible printer port. (Keep the key attached while CX-Process Monitor is in use.)
 - c) Install the License key driver.
 2. Make Settings and Transfer Using CX-Process Tool (Refer to *CX-Process Tool Operation Manual (W372)*).
 - Create Function Blocks.
 - Set the Network address, Node address, and Unit Address (**Settings/Network**).
 - Set the CX-Process Monitor Tag (**Tag Setting/Monitor Tag**).
 - Compile the Monitor Tags (**Execute/Create Tag File/Monitor Tag**).
 - Download the Function Block data to the Loop Control Unit.

Note

 - a) If not setting and compiling Monitor Tags using CX-Process Tool, you cannot monitor using CX-Process Monitor.
 - b) You can also enable the Network address, Node address, and Unit address settings made with CX-Process Tool using CX-Process monitor.
 3. Configure the Screen Using CX-Process Monitor (refer to *Section 4 Screen Configuration*).
 - Design the monitor system using CX-Process Monitor.
 - Create and register the Control screen, Trend screen, Graphic screen, and Annunciator screen on the Overview screen.
 - When registering, specify on the screen the Loop Control Unit data by selecting the Tag name set using CX-Process Tool.
 - Set the communications conditions with the PLC using the system monitor setting window (if using serial communications).

Perform the following operation.

 - a) Select **Omron/CX-Process Monitor/CX-Process Monitor** from the Windows Start Menu.
 - b) Click the **Start** Button in the Main Window.
 - c) Click the **Engineer** Button in the Mode Selection Dialog Box.
 - d) Click the **Set Up** Button in the Mode Selection Dialog Box.
 - e) Enter password.
 - f) Click the **System Monitor Builder** Button in the Setup Dialog Box, and make settings using the System Monitor Setting Window.
 - g) Click the **Graphic Builder** Button in the Setup Dialog Box, create the Graphic Screen Create Window (including Tag name specifications), and save.
 - h) Click the **CRT Builder** Button in the Setup Dialog Box, and register the screen using the Builder Window (including Tag name specifications).
 - i) From the Builder Window **Settings** menu, select **Save**, and then click the **OK** Button.
 4. Check Screen Configuration Using CX-Process Monitor (Refer to *4-8 Checking Configurations*).
 - Check if you can monitor the Loop Control Unit using the configured screen.
 - Start FinsGateway Serial Unit communications according to the communications conditions set using the System monitor setting window by start-

ing the monitoring process (i.e., start FinsGateway Controller Link and Ethernet manually).

Perform the following operation.

- a) Click the **Start** Button in the Main Window.
 - b) Click the **Engineer** Button in the Mode Selection Dialog Box.
 - c) Click the **Set Up** Button in the Mode Selection Dialog Box.
 - d) Enter password.
 - e) Click the **File Mapping** Button in the Setup Dialog Box (mapping to the Monitor Tag File Screen).
 - f) Click the **Overview** Button in the Mode Selection Dialog Box.
 - g) Select the screens using the Overview Screen, and check that each function is operating normally.
5. Start the Monitor Operation to monitor the Loop Control Unit (Refer to *Section 3 Monitor Screen Functions and Operations* for details).

Perform the following operation.

- a) Click the **Start** Button in the Main Window.
- b) Click the **Operator** Button in the Mode Selection Dialog Box.
- c) Click the screens using the Overview Screen.

SECTION 2

Setup

This section describes installing the CX-Process and connections to the PLC.

2-1	Installation	22
2-1-1	Before Installing FinsGateway	22
2-1-2	Installing FinsGateway	23
2-1-3	Installing CX-Process Monitor	28
2-1-4	Installing the License Key Driver	32
2-2	Connecting the PLC	33
2-2-1	Connecting via Host Link	33
2-2-2	Connecting through a Controller Link Support Board	35
2-2-3	Connections via Ethernet	35

2-1 Installation

To use CX-Process Monitor, you must install the following software on the same computer. After installing FinsGateway Embedded Version 3, install CX-Process Monitor.

- FinsGateway Embedded Version 3
- CX-Process Monitor
- License Key Driver

- Note**
1. To use the CX-Process Monitor, you also need the WS02-LCTK1-EL01 License Key (sold separately). In addition to installing the CX-Process Monitor, make sure to first connect the WS02-LCTK1-EL01 License Key to the computer printer port, and then install the License Key Driver before using the CX-Process Monitor. When using the CX-Process Monitor, make sure that the WS02-LCTK1-EL01 License Key is always connected to the printer port.
 2. This software must be installed on a computer using Windows NT 4.0 or Windows 2000 as its OS. It will not operate on Windows 95, 98, or Me.
 3. Be sure to install FinsGateway Embedded Version 3 before installing CX-Process Monitor. You cannot install CX-Process Monitor first.
 4. Be aware that you cannot start CX-Process Monitor if FinsGateway Embedded Version 3 is not installed.
 5. If connecting CX-Process online using a PLC and Host Link, you cannot install and use CX-Process on the same computer as FinsGateway Version 1.

2-1-1 Before Installing FinsGateway

If an earlier version of FinsGateway has been installed already, start from *Step 1: Backing Up the FinsGateway Settings*.

If FinsGateway is being installed on the computer for the first time, skip to *Step 5: ComCtl32.dll Update*.

Step 1: Backing Up the FinsGateway Settings

If necessary, back up the previous FinsGateway settings, as follows:

- Note** If FinsGateway is removed (uninstalled) without backing up the setting data, the previous setting data will all be lost.

- 1, 2, 3... 1. Execute the Backup/Restore FinsGateway Setting Data program on the CD.

```
<CD-ROM drive>:\Fgwv3\FgwUtils\SettingSalvage.exe
```

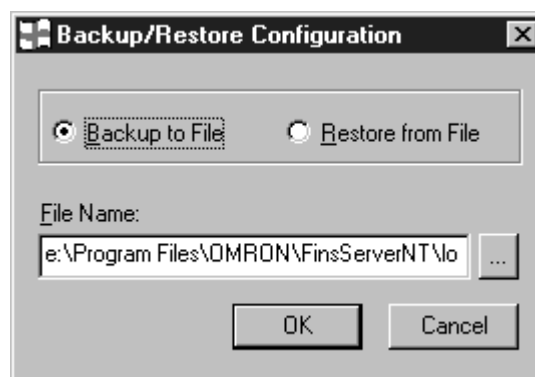

2. Select the Backup to File option, and click OK.

Step 2: Removing the Previous FinsGateway

Remove the previous version of FinsGateway by referring to that manual for details.

Note The FinsGateway removal process does not delete all of the FinsGateway files and registry data used by FinsGateway. As a result, the FinsGateway reinstallation process sometimes fails. If this happens, execute the following program from the distribution CD to remove all the files and registry data used by FinsGateway.

```
<CD-ROM drive>:\Fgwv3\FgwUtils\FgwRemover3.exe
```

Step 3: System Restart

After removing FinsGateway, restart the computer. If the following steps are performed without restarting the computer, the installation will not be completed properly.

Step 4: Internet Explorer Installation

If Internet Explorer is not already installed, or if the version is old, the FinsGateway installation will display a warning to update it. Update Internet Explorer. Internet Explorer is not included with FinsGateway. Refer to the Microsoft website for details, and install the newest version.

Step 5: ComCtl32.dll Update

If the operating system is Windows 95, the Windows 95 ComCtl32.dll has a bug that must be corrected. Be sure to update the ComCtl32.dll file.

If using Windows NT 4, use the following procedure to update ComCtl32.dll for systems where the display or other operations do not function properly.

For Windows 2000 and Windows 98 no update is necessary for this file.

Microsoft provides an update program called 401comupd.exe.

Step 6: DCOM95 for Windows 95, Version 1.3 Installation

If the operating system is Windows 95, FinsGateway requires the DCOM95 for Windows 95, version 1.3 from Microsoft.

Note If the operating system is Windows 95, FinsGateway requires the DCOM95 for Windows 95, version 1.3 from Microsoft.

1, 2, 3...

1. Execute the following program from the FinsGateway CD:

```
<CD-ROM drive>:\Fgwv3\Update\DCOM\English\dcom95.exe
```

2. The program will suggest a system restart when it finishes.

Do not proceed to the next step without restarting the computer. If the installation is continued without restarting the computer, the FinsGateway will not operate properly.

Step 7: Updating the HTML Help Runtime Component

If the HTML Help runtime component is not already installed, or if the version is old, the FinsGateway installation will display a warning to update it. Update the HTML Help runtime component as follows:

1, 2, 3...

1. Execute the following program from the FinsGateway CD:

```
<CD-ROM drive>:\Fgwv3\Update\hhupd.exe
```

2. Update the HTML Help runtime component according to the instructions displayed on the screen.

3. The program will suggest a system restart when it finishes.

Do not proceed to the next step without restarting the computer. If the installation is continued without restarting the computer, the FinsGateway will not operate properly.

2-1-2 Installing FinsGateway

You cannot install and use CX-Process Tool alone. You must install FinsGateway Embedded Version 3 on the same computer.

Note FinsGateway Embedded Version 3 is bundled with CX-Process, but you can also use FinsGateway Runtime Version 3. If FinsGateway Runtime Version 3 is already installed, you do not need to install FinsGateway Embedded Version 3.

Use the following procedure to complete the installation.

1, 2, 3...

1. Install the FinsGateway drivers compatible with your communications protocol.

2. Update FinsGateway.

First, install the FinsGateway drivers compatible with your communications protocol.

- 1, 2, 3... 1. Using Explorer, select one of the following folders from within the FinsGateway V2 folder on the CD-ROM, depending on the communications protocol compatible with your PLC.

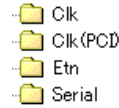

CLK (PCI)	Select if connecting CX-Process Tool and CX-Process Monitor to your PLC (Programmable Controller) using the Controller Link Support Board for a PCI Bus.
Serial	Select if connecting CX-Process Tool and CX-Process Monitor to your PLC (Programmable Controller) using the Host Link.
Clk	Select if connecting CX-Process Tool and CX-Process Monitor to your PLC (Programmable Controller) using the the Controller Link Support Board for an ISA Bus.
Etn	Select if connecting CX-Process Tool and CX-Process Monitor to your PLC (Programmable Controller) using an Ethernet.

The following explanation is for Host Link.

2. On the CD-ROM, select **Serial**, and then **disk1**, and then double-click the **Setup.exe** icon as shown below.



The following screen will be displayed.

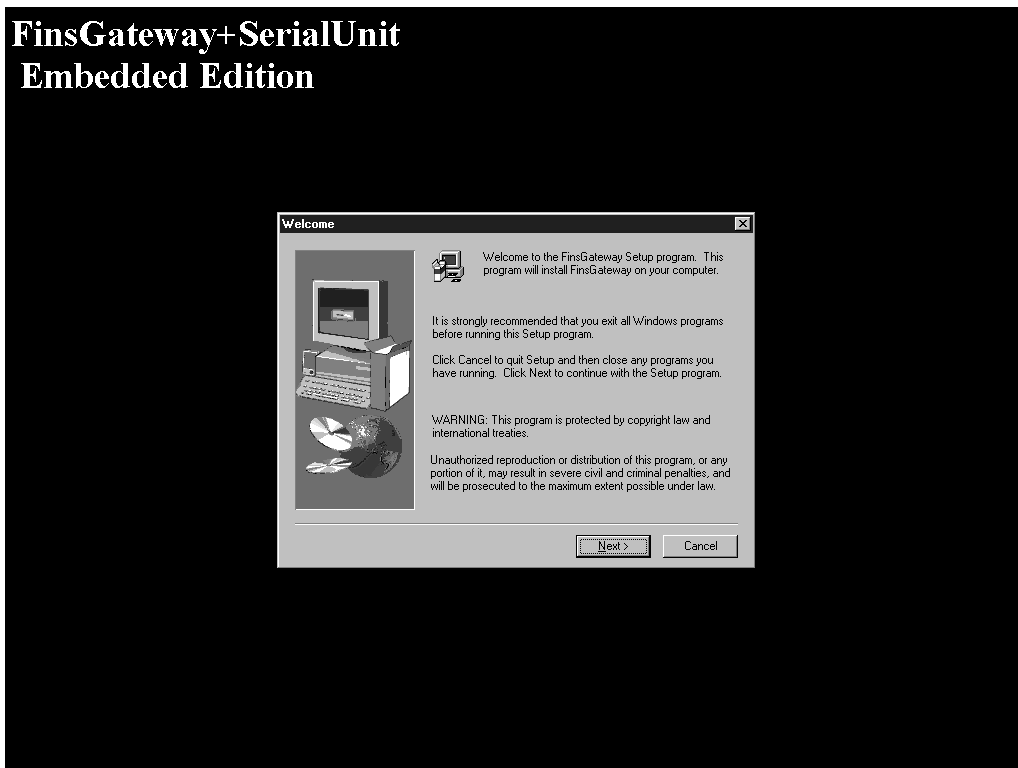

3. Click the **Next** Button. The User Registration Dialog Box will be displayed.

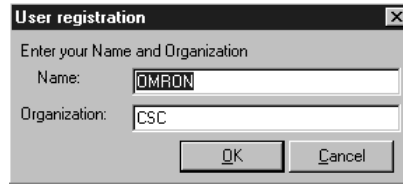

4. Enter your name and organization, and then click the **OK** Button. The Note Dialog Box will be displayed.

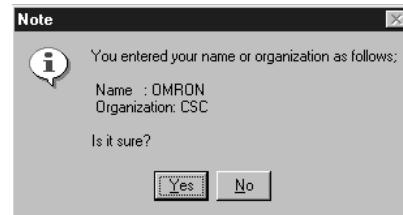

5. Click the **Yes** Button. The Choose Destination Location Dialog Box will be displayed.



6. Click the **Next** Button. The Select Program Folder Dialog Box will be displayed.

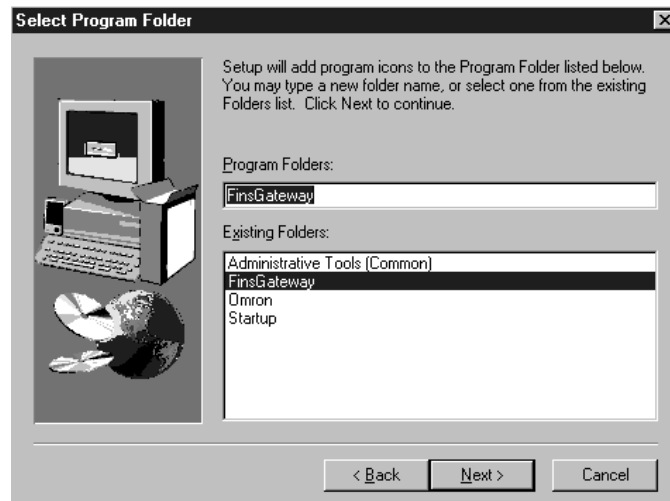

- 7. Check the installation destination is correct, and then click the **Next** Button. Installation will start automatically.

When installation is completed, the following dialog box will be displayed.



- 8. Click the **Finish** Button.

Next, update FinsGateway.

- 9. On the CD-ROM, select **Fgww3**, and then **FgwUpdate**, and then double-click the **FgwUpdate3.exe** icon as shown below.



FgwUpdate3.exe

- 10. The following screen will be displayed.

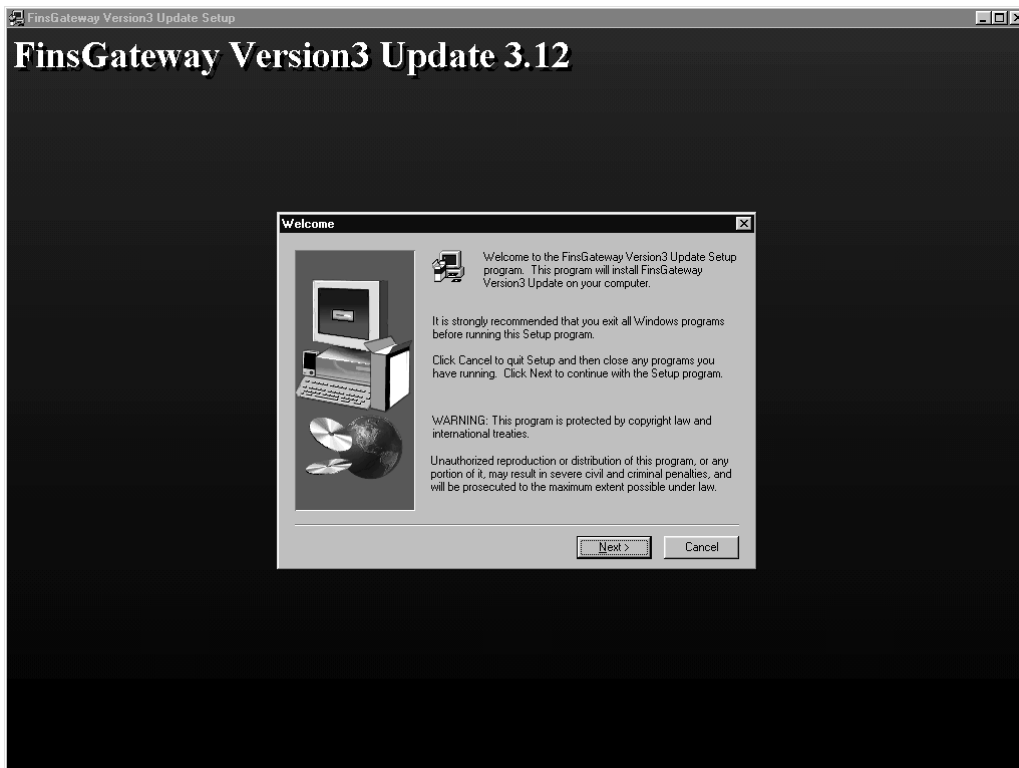

- Click the **Next** Button. The Select Program Folder Dialog Box will be displayed.

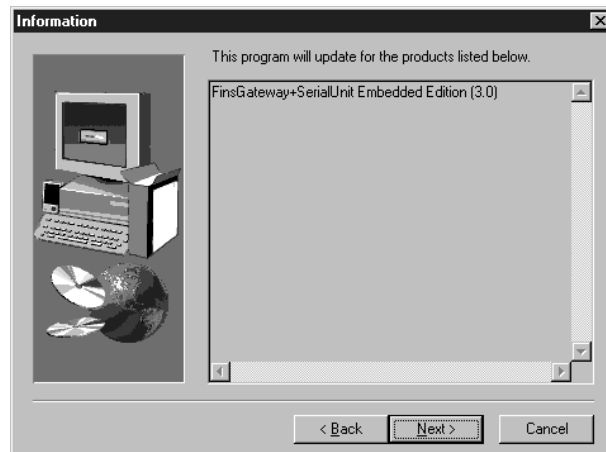

- Check the installation destination is correct, and then click the **Next** Button. The Start Copying Files Dialog Box will be displayed.



- Check the installation destination is correct, and click the **Next** Button. Installation will start automatically. When installation is completed, the following dialog box will be displayed.



- Click the **Finish** Button. The FinsGateway installation is now completed.

Note You cannot start CX-Process Monitor if FinsGateway is not installed.

2-1-3 Installing CX-Process Monitor

- 1, 2, 3...
1. Insert the installation CD-ROM in the CD-ROM drive.
 2. On the CD-ROM, select **CX-Process Monitor**, and then **disk1**, and then double-click the **Setup.exe** icon as shown below.



After the Preparing Setup Dialog Box has been displayed, the following screen will appear.

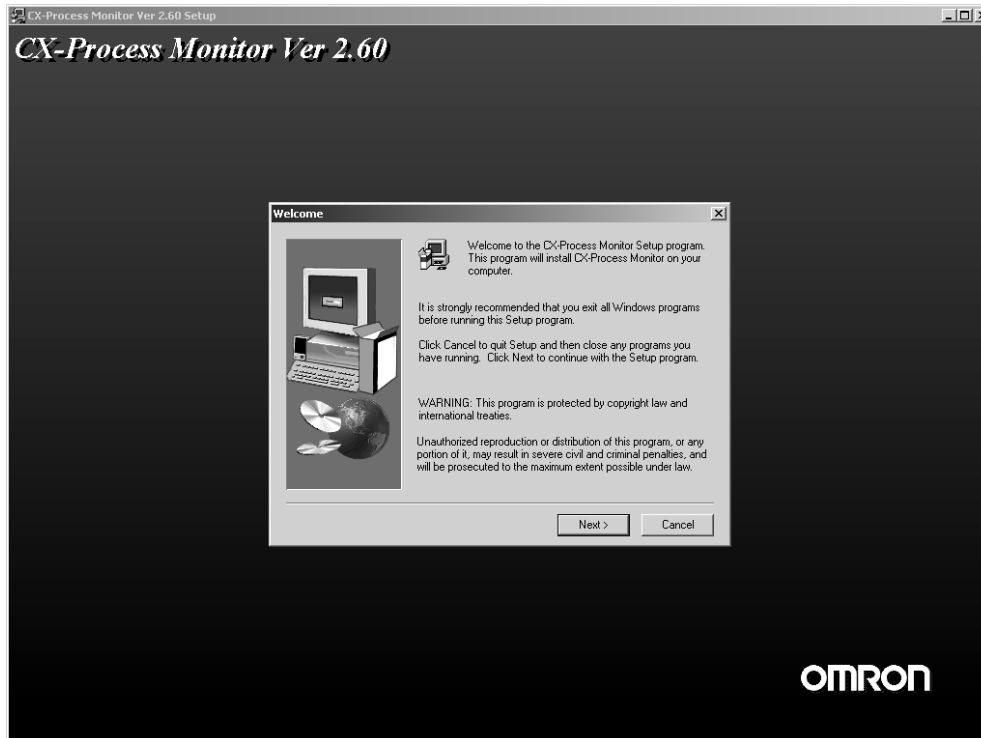

3. Click the **Next** button. The Software License Agreement Dialog Box will be displayed.
4. Click the **Yes** Button.
The Read Me Information Dialog Box will be displayed.
5. Click the **Next** Button.
The User Information Dialog Box will be displayed.
6. Enter your name and company name, and then click the **Next** Button.

The Choose Destination Location Dialog Box will be displayed.

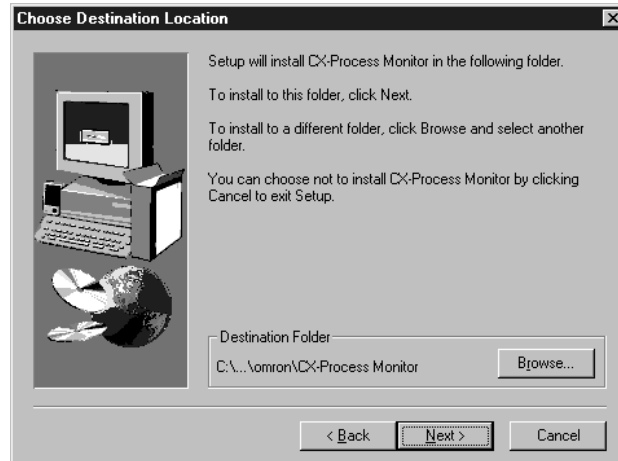

7. Specify the drive and folder to which you want to install CX-Process Monitor. The default is as follows:

C:\ Program Files\omron\CX-Process Monitor

You do not need to make any changes to install to the directory displayed. To change the destination, click the **Browse** Button, and then select the directory.

8. Click the **Next** Button. The Select Program Folder Dialog Box will be displayed. Select the program folder. The default is as follows:

Omron/CX-Process Monitor

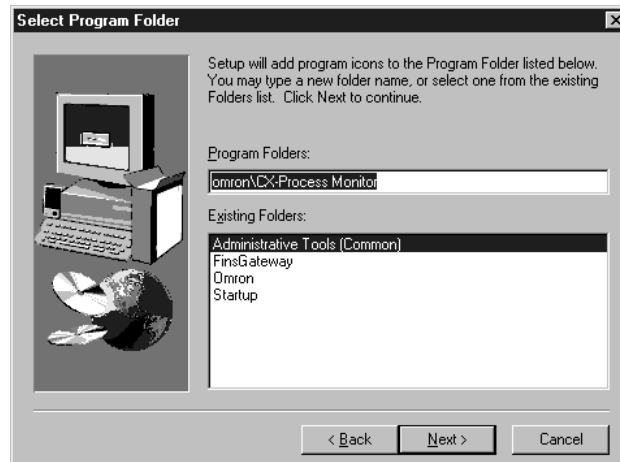

9. Click the **Next** Button.

The Start Copying Files Dialog Box will be displayed.

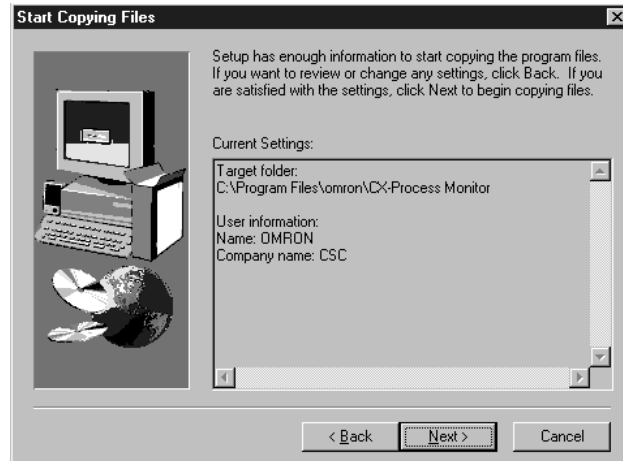

10. Click the **Next** Button.

Installation will start automatically.

Note a) If there is already a DB folder (Monitor Tag file) in the destination folder, the following dialog box will be displayed.

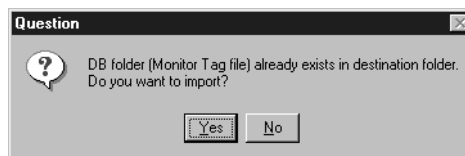

- Click the **Yes** Button to import the existing DB folder.
 - Click the **No** Button to not import the existing DB folder.
- b) If trend data created on version 1.50 or earlier of the software exists in the destination folder, a dialog box will be displayed asking if the trend data should be converted to data for version 2.00/2.50/2.60.

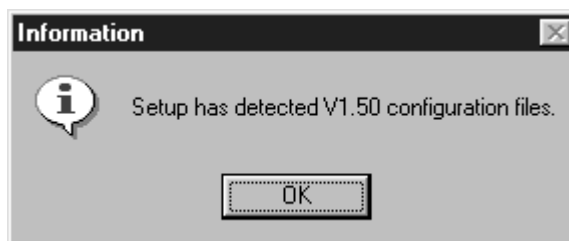

If conversion is specified, the following dialog box will be displayed.

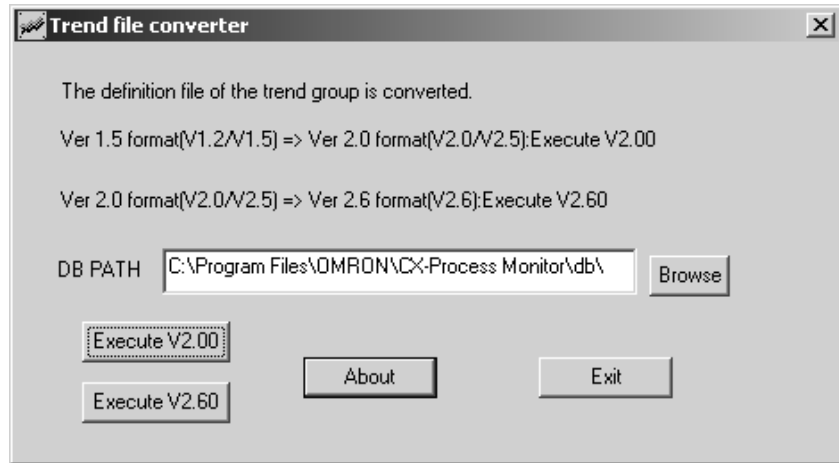

Specify the path of the CX-Process Monitor tags (i.e., the db path) and click the **Execute** Button. (If there is more than one tag file, double-click **TrgrpCnv.exe** under Omron\CX-Process Monitor to display the above Trend File Conversion Dialog Box. Then click the **Browse** Button, specify the tag file, and click the **Execute** Button to convert each file.) When conversion is completed, click the **Finish** Button.

The installation process will continue.

If installation is completed normally, the following dialog box will be displayed.



11. Click the **Finish** Button.

- Note**
1. To uninstall CX-Process Monitor, first end the Monitor process (from the Setup Dialog Box, click the **Shut Down** Button), and then uninstall.
 2. If the dialog box in step 10 is displayed while CX-Process Monitor is being installed (refer to note (a) in step 10 on page 30), after installation select

System Info from the **Set up** Menu and then open CRT Builder. After saving once, set the main system settings.

2-1-4 Installing the License Key Driver

This section describes the License key driver installation procedure. You can also install the License key driver before installing CX-Process Monitor.

- 1, 2, 3...** 1. Connect the WS02-LCTK1-EL01 License Key to your computer printer port.

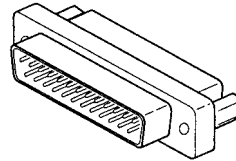

WS02-LCTK1-EL01

2. Using Explorer, select **Setup.exe** from the **SystemDriver** folder on the CD-ROM.
3. After installation is completed, be sure to restart Windows NT/2000.

Note If your computer is a Fujitsu FM/V, after installing the License Key Driver, you must cycle the power supply to the computer, and then restart Windows NT/2000.

- Note**
1. When using the CX-Process Monitor, make sure that the the WS02-LCTK1-EL01 License Key is always connected to the printer port. If the WS02-LCTK1-EL01 License Key is not connected to the computer printer port, or even if it is connected, if the License key driver is not installed, you cannot use CX-Process Monitor.
 2. Even if the License key driver is installed, nothing will be displayed on the screen. To check that the driver is installed correctly, select **Settings**, and then **Control Panel**, and then **Multimedia**. Check using the Multimedia Properties dialog box, by selecting **Other Multimedia Devices**, and then displaying **Sentinel for i386 Systems**.
 3. To uninstall the License key driver, in the Multimedia Properties dialog box, select **Sentinel for i386 Systems**, and then select the **Remove** Button.

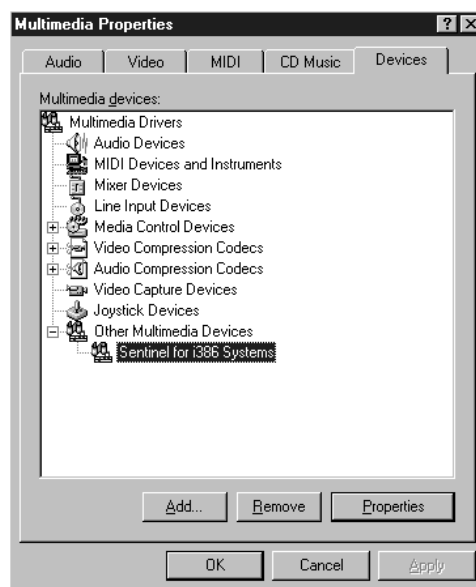

2-2 Connecting the PLC

The following three methods can be used to connect to the PLC. Regardless of the connection method, the FinsGateway communications driver (embedded version 2) is used.

Communications network	FinsGateway communications driver	Contents
Host Link Network (See note.)	Serial Unit Driver	Connecting to the peripheral or RS-232C port of the PLC over Host Link.
Controller Link Network	CLK (PCI slot) Driver (Not supported by FinsGateway Version 2)	Connecting through the Controller Link Support Board to a PLC with a Controller Link Unit mounted.
Ethernet Network	ETN_UNIT Driver	Connecting through the Ethernet Board to a PLC with an Ethernet Unit mounted.

Note Host Link communications use FINS commands wrapped in header and terminator data (i.e., SYSWAY-CV for FinsGateway). Host Link communications (SYSMAC WAY) is set for the PLC.

2-2-1 Connecting via Host Link

The personal computer uses the FinsGateway’s Serial Unit Driver to connect to the peripheral or RS-232C port of the PLC via Host Link communications.

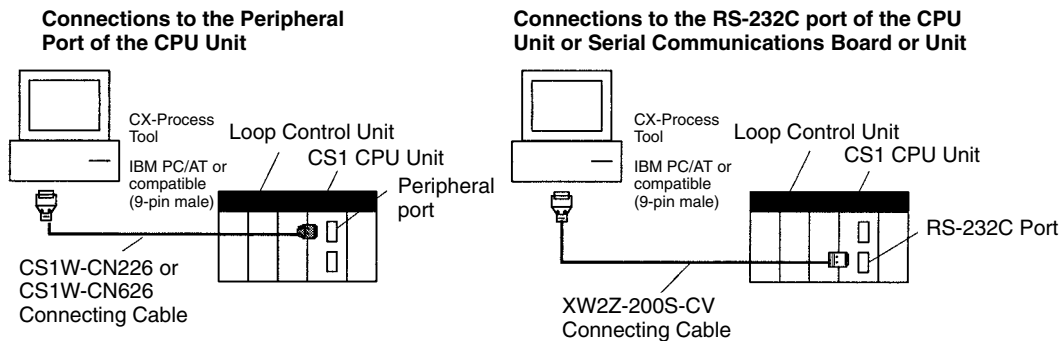

- Note**
1. The Serial Communications Mode must be set to Host Link. Host Link communications use FINS commands wrapped in header and terminator data (i.e., SYSWAY-CV for FinsGateway). The peripheral bus cannot be used.
 2. The FinsGateway Version 2 Serial Unit Driver must be installed to enable connecting the PLC via Host Link communications.
 3. The following Connecting Cables are used to connect the CX-Process Tool (personal computer) to the PLC (CPU Unit or Serial Communications Board/Unit).

Connecting Cables

Unit	Port on Unit	Computer	Port on computer	Serial Communications Mode	Model	Length	Remarks
CPU Unit	Built-in peripheral port	IBM PC/AT or compatible	Male 9-pin D-SUB	Host Link	CS1W-CN226	2.0 m	---
					CS1W-CN626	6.0 m	
	Built-in RS-232C port Female 9-pin D-SUB				XW2Z-200S-CV	2 m	Anti-static connector
					XW2Z-500S-CV	5 m	
Serial Communications Board or Unit	RS-232C port Female 9-pin D-SUB				XW2Z-200S-CV	2 m	anti-static connector
					XW2Z-500S-CV	5 m	

Note Touch a grounded metal to discharge all static electricity from your body before connecting any of the above cable connectors to the RS-232C port of the PLC. The XW2Z-□□□S-CV Cable uses the anti-static XM2S-0911-E Connector Hood. For safety sake, however, discharge all static electricity from your body before touching the connector.

The following components are used to connect RS-232C cable to the peripheral port.

Unit	Port on Unit	Computer	Port on computer	Serial Communications Mode	Model	Length	Remarks
CPU Unit	Built-in peripheral port	IBM PC/AT or compatible	Male 9-pin D-SUB	SYSMAC WAY (Host Link)	CS1W-CN118 + XW2Z-200S-CV/500S-CV	0.1 m + (2 or 5 m)	The XW-2Z□□□S-CV is an anti-static connector.
					CS1W-CN118 + XW2Z-200S-V/500S-V		---

The following components are available for connecting the CQM1-CIF01 or CQM1-CIF02 Cable to the peripheral port.

Unit	Port on Unit	Computer	Port on computer	Serial Communications Mode	Model	Length	Remarks
CPU Unit	Built-in peripheral port	IBM PC/AT or compatible	Male 9-pin D-SUB	SYSMAC WAY (Host Link)	CS1W-CN114 + CQM1-CIF02	0.05 m + 3.3 m	---

The following components are available for connecting the IBM PC/AT or compatible over RS-232C

Unit	Port on Unit	PLC	Port on PLC	Serial Communications Mode	Model	Length	Remarks
CPU Unit	Built-in RS-232C port Female 9-pin D-SUB	IBM PC/AT or compatible	Male 9-pin D-SUB	SYSMAC WAY (Host Link)	XW2Z-200S-V	2 m	---
					XW2Z-500S-V	5 m	
Serial Communications Board or Unit	RS-232C Port Female 9-pin D-SUB				XW2Z-200S-V	2 m	
					XW2Z-500S-V	5 m	

2-2-2 Connecting through a Controller Link Support Board

The personal computer uses the FinsGateway Version 2 Controller Link Driver to connect to the PLC over a Controller Link Network.

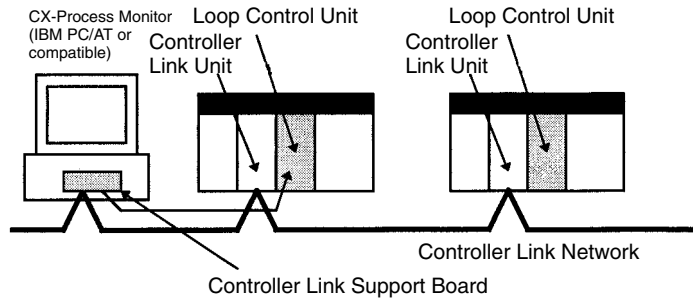

Note The FinsGateway Version 2 Controller Link Driver must be installed to enable connecting the PLC via a Controller Link Network.

Controller Link Unit Models

Controller Link Unit	PLC	Unit	Type	Transmission path
CS1W-CLK21-V1	CS1	CPU Bus Unit	Wired	Twisted-pair cable
CS1W-CLK11-V1			Optical	Optical fiber cable
CS1W-CLK12-V1			Optical Ring	Optical fiber cable
CS1W-CLK52-V1			Optical	GI Optical fiber cable

Controller Link Support Boards

Controller Link Support Board	Transmission medium	Computer	FinsGateway Driver
3G8F7-CLK12-V1	Optical fiber cable (ring configuration)	IBM PC/AT or compatible (PCI slot)	CLK (PCI slot) Driver (FinsGateway Version 2 cannot be used.)
3G8F7-CLK52-V1			
3G8F7-CLK21-V1	Wire		
3G8F5-CLK11-V1	Optical fiber cable	IBM PC/AT or compatible	Controller Link Driver
3G8F5-CLK21-V1	Wire		

Note When connecting the CX-Process Monitor to a PLC via Controller Link, refer to *Appendix B FinsGateway Settings when Connected Using Controller Link* for details on FinsGateway Settings.

2-2-3 Connections via Ethernet

The personal computer uses the FinsGateway Version 2 ETN_UNIT Driver to connects to the PLC via Ethernet.

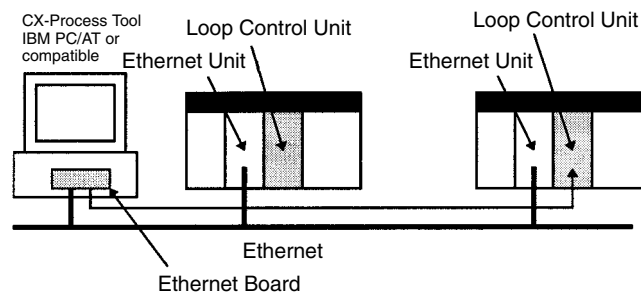

Note The FinsGateway Version 2 ETN_UNIT Driver must be installed to enable connecting the PLC via Ethernet.

Ethernet Unit Model

Model	PLC	Unit	Transmission path
CS1W-ETN01	CS1	CPU Bus Unit	Ethernet 10Base-5
CS1W-ETN11			Ethernet 10Base-T

SECTION 3

Monitor Screen Functions and Operations

This section describes the monitor screens used with the CX-Process Monitor.

3-1	Outline	38
3-2	Procedure to Start Monitoring	38
3-3	Starting and Stopping	39
3-4	Overview Screen	40
3-5	Screen Configurations	42
3-6	Control Screens	44
3-6-1	Outline	44
3-6-2	Basic Displays and Operations	45
3-6-3	Display Examples	47
3-7	Tuning Screens	52
3-8	Trend Screens	57
3-9	Graphic Screens	63
3-10	Annunciator Screens	64
3-11	Operation Guide Message Screens	65
3-12	Alarm Log Screens	67
3-13	Operation Log Screens	68
3-14	System Monitor Screens	69
3-14-1	System Monitor Screen Outline	69
3-14-2	Loop Control Unit Run/Stop	70
3-14-3	Function Block Error Dialog Box Operations	71
3-14-4	Data Link Status	75
3-15	System Monitor Log Screens	77

3-1 Outline

This section explains the functions and operations for each screen primarily for those people who will operate CX-Process Monitor. The explanations assume that CX-Process Tool settings and screen configuration for the CX-Process Monitor have already been completed.

Refer to *Section 4 Screen Configuration* for how to configure CX-Process Monitor screens. Also, refer to *CX-Process Tool Operation Manual (W372)* for CX-Process Tool settings.

CX-Process Monitor screen configuration is already completed, monitor the Loop Control Unit mainly by performing the following operations.

- 1, 2, 3...**
1. Start CX-Process Monitor (refer to *3-3 Starting and Stopping CX-Process Monitor*).
 2. In the Mode Selection Dialog Box, click the **Operator** Button to display the Overview Screen (refer to *3-3 Starting and Stopping CX-Process Monitor*).
 3. From the Overview Screen, move to each of the following screens.
 - Control Screen (see *3-6 Control Screens*)
 - Tuning Screen (see *3-7 Tuning Screens*)
 - Trend Screen (see *3-8 Trend Screens*)
 - Graphic Screen (see *3-9 Graphic Screens*)
 - Annunciator Screen (see *3-10 Annunciator Screens*)
 - Operation Guide Message Screen (see *3-11 Operation Guide Message Screens*)
 - Alarm Log Screen (see *3-12 Alarm Log Screens*)
 - Operation Log Screen (see *3-13 Operation Log Screens*)
 - System Monitor Screen (see *3-14 System Monitor Screens*)
 - System Monitor Log Screen (see *3-15 System Monitor Log Screens*)

Note If the WS02-LCTK1-JL01 License key is not connected to the computer printer port, or even if it is connected, if the License key driver is not installed, you cannot use the following monitor screens or configuration screens. (If you try to switch to the following screens, an error message will be displayed.)

Monitor Screens

Item	Screen
User-defined screens	Trend screen
	Graphic screen
	Operation Guide screen
System screens	Alarm Log screen
	Operation Log screen
	System Monitor Log screen

3-2 Procedure to Start Monitoring

The procedure until starting monitoring is as follows:

- 1, 2, 3...**
1. Select **Start, Programs, Omron, CX-Process Monitor, CX-Process Monitor**.
 2. In the Main Window, click the **Start** Button.
 3. In the Mode Selection Dialog Box, click the **Operator** Button.
 4. In the Overview Screen, select **Control Screen, Trend Screen**, etc. as required.

Note Steps 2 and 3 will not be required and a specified screen will be displayed if auto-starting is enabled. Autostarting can be enabled by clicking the **System Info**.

Button when configuring the screen and then setting the Auto-start–Auto-start setting to *Enable*.

3-3 Starting and Stopping

This section explains how to start and stop CX-Process Monitor.

- 1, 2, 3... 1. Select **Start, Programs, Omron, CX-Process Monitor, CX-Process Monitor**.

The CX-Process Monitor's Main Window will be displayed.

Main Window



Note When you have finished using CX-Process Monitor, click the **Exit** Button in the Main Window. The Main Window and CX-Process Monitor will both close.

2. Click the **Start** Button.

The Mode Selection Dialog Box will be displayed.

If configuration has already been completed, display the Overview Screen using the step after next, and start monitoring. Refer to *Section 4 Screen Configuration* for configuration.

Mode Selection Dialog Box

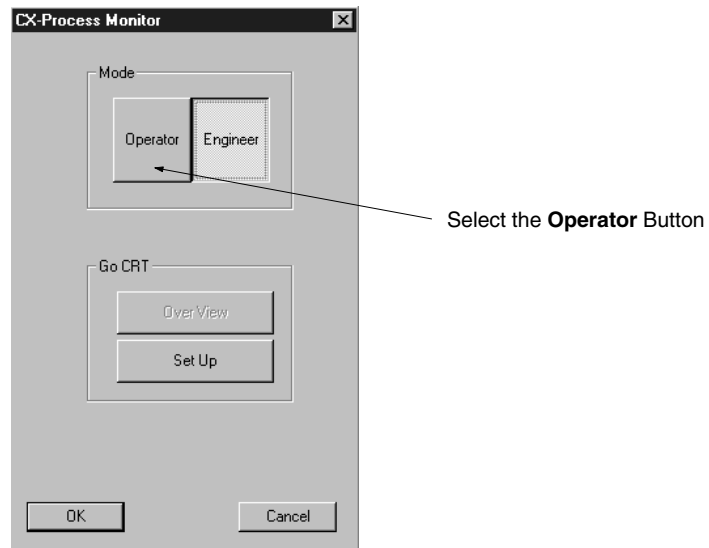

3. In the Mode field, select the **Operator** Button.

The monitoring process will be started and the Overview Screen will be displayed (Refer to 3-4 Overview Screen).

- Note**
- a) Steps 2 and 3, above, will not be required and the Overview Screen will be displayed immediately if auto-starting has been specified by setting the Auto-start–Auto-start setting to *Enable*.
 - b) To finish using CX-Process Monitor while in Operator mode, click the **Close** Button in the top right of the Overview Screen, and the monitor process will automatically end. In Engineer mode, click the **Close** Button in the top right of the Overview Screen. If the monitor process is running, a dialog box will be displayed to confirm whether the monitor process should be ended or not. Select **Yes** to end the monitor process. Select **No** to continue running the monitor process.

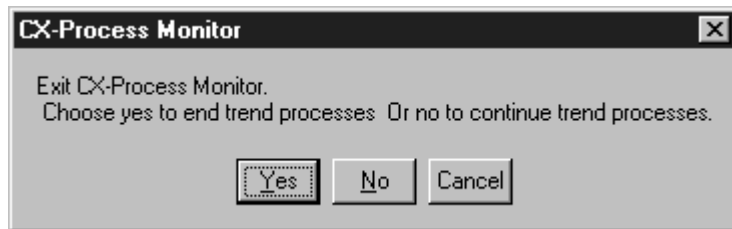

3-4 Overview Screen



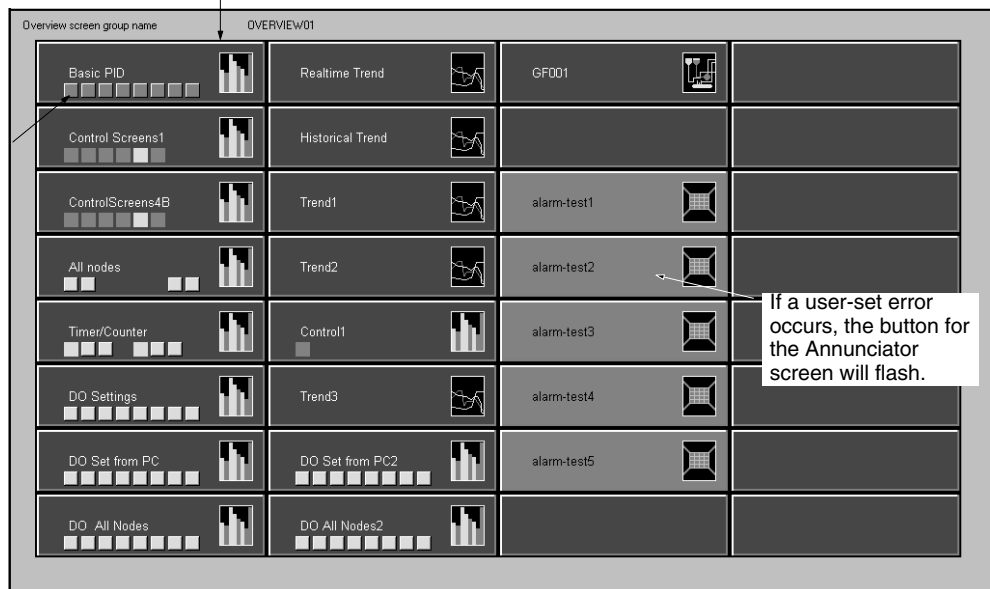

The Overview Screen displays all the menu screens and displays alarms.

Click this button to move to the Control screen

Each button represents one loop. Click the button to display the Tuning screen for the loop.



The button icons for the registered Control Screen, Trend Screen, Graphic Screen, and Annunciator Screen will be displayed.

Icon	Screen type
	Control Screen
	Trend Screen
	Graphic Screen
	Annunciator Screen

Each screen displays eight rows and four columns to a maximum of 32 screens. The alarm status for each loop is shown on the Control Screen button.

Select the icon to move to the registered screen.

If a user-set alarm occurs, the icon for the Annunciator Screen flashes.

When returning to the Overview Screen from any screen, first select **Overview** from among the screen selection buttons, and then select the Overview Screen name.

More than one Overview Screen can be displayed by clicking the **System Info.** Button when configuring the screen and then setting the Multi-screen–Multi-screen setting to *Enable*. Refer to *4-7 System Information Settings* for details.

Note Auto-starting can be disabled by clicking the right mouse button at the top of an Overview Screen. Click the **Yes** Button on the dialog box that appears and then set **Auto-start** to *Disable*.

3-5 Screen Configurations

This section explains the configuration of the CX-Process Monitor Screen as a whole. The following example shows the Overview Screen.

Screen Selection Buttons: Right-click here to confirm the CRT-ID, group number, and position of the screen specified for automatic startup. Refer to the table below for each button's function.

Click here and then set a tag name to select any Tuning Screen.

When a new message appears in the Operation Guide Screen, a red mark is displayed, and a buzzer will sound at the same time.

System Monitor Message Display Area: Displays the most recent System Monitor message, and a buzzer will sound at the same time. The message is stored in the System Monitor Log. Click the Button to delete the message. The buzzer will also stop at the same time.

Use these buttons to scroll to other displays of the same type without going through the Overview Screen.

Alarm Message Display Area: Displays the most recent alarm message, and a buzzer will sound at the same time. The message is stored on the Alarm Log screen. Click the Button to delete the message. The buzzer will also stop at the same time.

This area displays all the Monitor Screens. The example shows the Overview Screen. Use the Screen Selection Buttons to change the display.

Prints a hardcopy of the screen.

Return to previous screen

Displays the date and time

Note The bottom line will appear as follows for some screens.



Prints error log data on Operation Guide Message Screens, Alarm Log Screens, Operation Log Screens, and System Monitor Log Screens.

**Screen Selection
Buttons**

Button name	Function
Overview	Displays the Overview Screen. If multiple Overview Screens are registered, a pull-down menu will be displayed from which you can select the Overview Screen you want.
Alarm	Displays the Alarm Log Screen.
Operation Log	Displays the Operation Log Screen.
Operation Guide	Displays the Operation Guide Message Screen.
System Monitor	Displays the System Monitor Screen to show system status.
System Monitor Log	Displays the System Monitor Log Screen, which registers system messages.
About	Displays information on the CX-Process Monitor version.

3-6 Control Screens

3-6-1 Outline

Use Control Screens to monitor and set the Control Block and part of the Operation Block, to monitor analog signals, and to monitor and set contact signals. For the Control Block in particular, use the Control screen to perform such operations as monitoring Set Point (SP), Process Variable (PV), Manipulated Variable (MV) run status, and Set Point (SP) changes, etc.

Click the **Control Screen** Button in the Overview screen to display the following information on the Control Screen.

- You can display up to a maximum of eight loops per screen of PID, Indicators, and other Control Blocks as on-site Instrument images. The maximum is 400 screens x eight loops.
- You can perform SP changes, auto/manual switching, and manual operations, etc. (Items indicated by a Button can be changed. Items without a Button are displayed only.)
- You can also move to the Tuning Screen.

	Block name (mode)	Send source function block, or ITEM
Target function block	1-Block Send Terminal to Computer (403)	Control Block: Basic PID (011), Advanced PID (012), Batch flowrate capture (014), Indication and Setting (031), Indication and Operation (032), Ratio Setting (033), Indicator (034), blended PID (013), 2-position ON/OFF (001), 3-position ON/OFF (002)
	4-Block Send Terminal to Computer (404)	Control Block: Basic PID (011), Advanced PID (012), Indication and Setting (031), Indication and Operation (032), Ratio Setting (033), Indicator (034), 2-position ON/OFF (001), 3-position ON/OFF (002) Operation Block: High/Low Alarm (111), Segment Program 2(157), ON/OFF Valve Manipulator (221), Motor Manipulator (222), Reversible Motor Manipulator (223), Motor Opening Manipulator (224), Timer (205), Counter (208)
	AO to Computer (402), AO Terminal to All Nodes (408)	Analog input signals or analog output signals for all function blocks, or analog value parameters
	DO to Computer (401), DO Terminal to All Nodes (407)	Contact input signals or contact output signals for all function blocks, or contact value parameters
	AO Terminal Settings from Computer (410)	Analog output ITEM for AO Terminal Settings from Computer (Used to set ordinary analog values. Displays using network resend monitoring.)
	DO Terminal Settings from Computer (409)	Contact output ITEM for DO Terminal Settings from Computer (Used to set ordinary contact values. Displays using network resend monitoring.)
Display		SP, PV, MV, A/M status, R/L status (See note 1), bar color change analog signal when an alarm occurs, contact signal
Setting		SP, MV (only in manual mode), A/M switching (See note 3), R/L switching (See note 1 and note 2) Contact signal (See note 4)

- Note**
1. When the SP setting (local only, or remote/local both possible) for ITEM024 for Basic PID, Advanced PID, Indication and Setting, Ratio Setting, 2-position ON/OFF, and 3-position ON/OFF is 1 (remote/local both possible), CAS is displayed. If the setting is 0 (local only), nothing is displayed.
 2. When the SP setting (local only, or remote/local both possible) for ITEM024 for Basic PID, Advanced PID, Indication and Setting, Ratio Setting, 2-position ON/OFF, and 3-position ON/OFF is 1 (remote/local both possible), CAS is displayed, and settings can be made.
 3. When set to remote, only auto is possible; manual is disabled (this limit only applies to CX-Process Monitor).
 4. Analog signals are not possible.

3-6-2 Basic Displays and Operations

Basic PID (011)

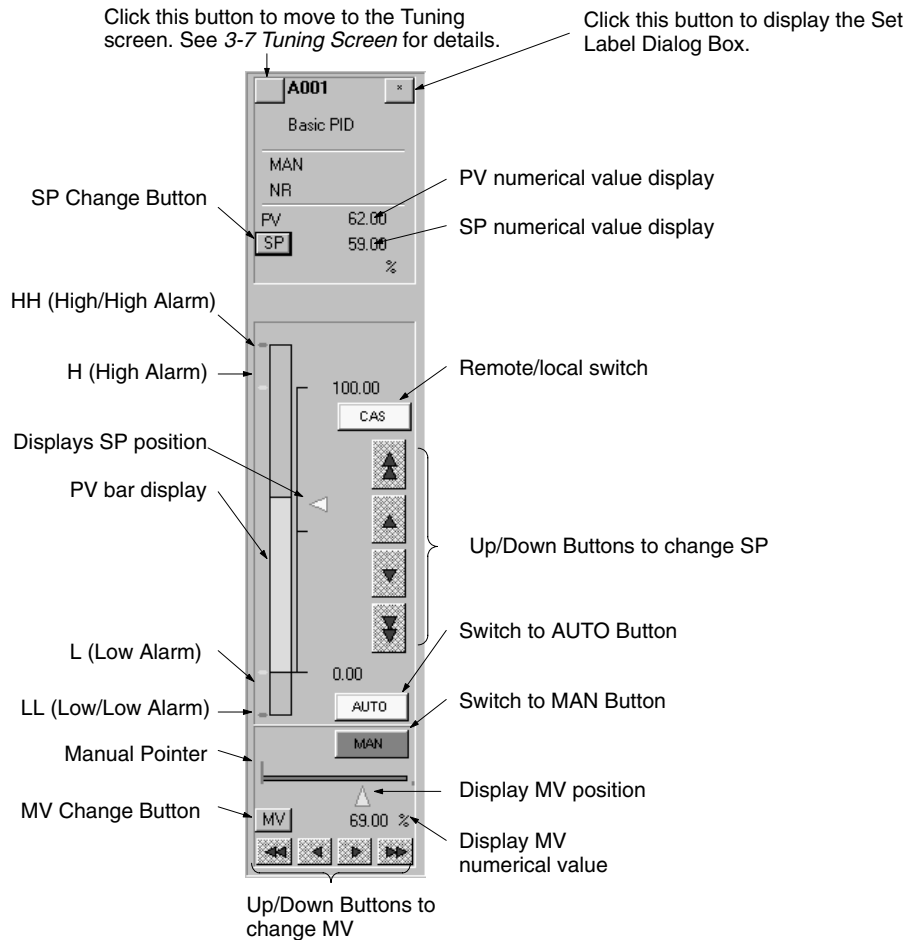

PV Bar Display

Displays the PV range from upper to lower limit as a bar.

Green: Status normal

Red: PV Alarm (either HH, H, L, LL)

Yellow: Deviation Alarm

Blue: Alarm OFF

Light blue: Function block calculations stopped

Changing SP

Change SP using the SP Change Up/Down Buttons.

First press the **SP** Button, select the value column, and then enter the change using the ten-key dialog (using the mouse), or the keyboard. (The ten-key pad is displayed when the input box is selected. To enable inputting from the ten-key, click the **System Info.** Button in the Setup Dialog Box, and then change the setting to enable the ten-key.

Changing MV

Change the MP using the MP Change Up/Down Buttons.

First press the **MP** Button, and then enter the change using the ten-key dialog box (using the mouse), or the keyboard.

Remote/Local (R/L) Switching

When the SP setting (local only, or remote/local both possible) for ITEM024 for Basic PID, Advanced PID, Indication and Setting, Ratio Setting, 2-position ON/OFF, and 3-position ON/OFF is 1 (remote/local both possible), CAS is displayed. When the **CAS** Button is red, the setting is on remote SP. When the **CAS** Button is blue, the setting is on local SP. Click the **CAS** Button to switch the setting.

Note When the CX-Process Monitor is set to Remote SP, A/M automatically switches to AUTO. You cannot set Manual.

A/M Switching

When AUTO is lit red, the setting is AUTO. You can change the SP value. When MAN is lit blue, the setting is manual. You can change MV and SP values. Select AUTO or MAN to switch.

MV Adjustment Area Details

Basic PID (011), Advanced PID (012), Batch Flowrate Capture (014), Indication and Operation (032), Ratio Setting (033)

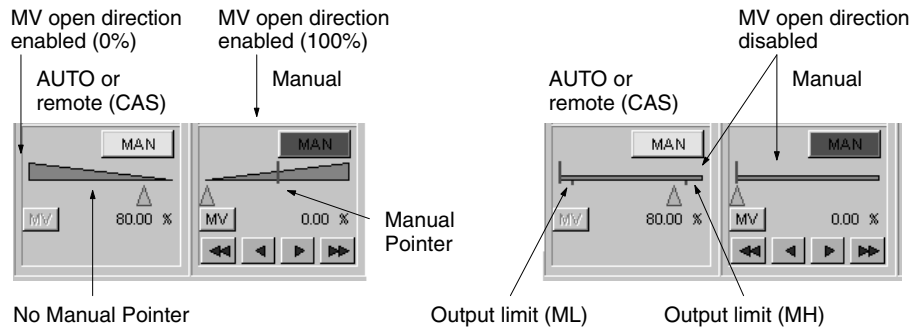

Make Manual Pointer and MV open direction settings when registering the Control Screen. Refer to *4-6 Screen Configuration* for details.

Make output limit (ML, MH) settings using the Tuning screen. Refer to *3-7 Tuning Screen* for details.

2-position ON/OFF (001)

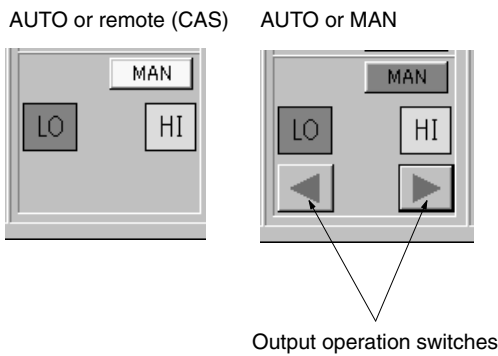

3-position ON/OFF (002)

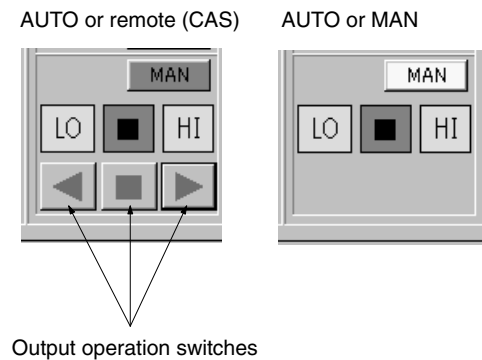

3-6-3 Display Examples

Indication and Setting (031)

Click this button to move to the Tuning screen.
See 3-7 Tuning Screen for details.

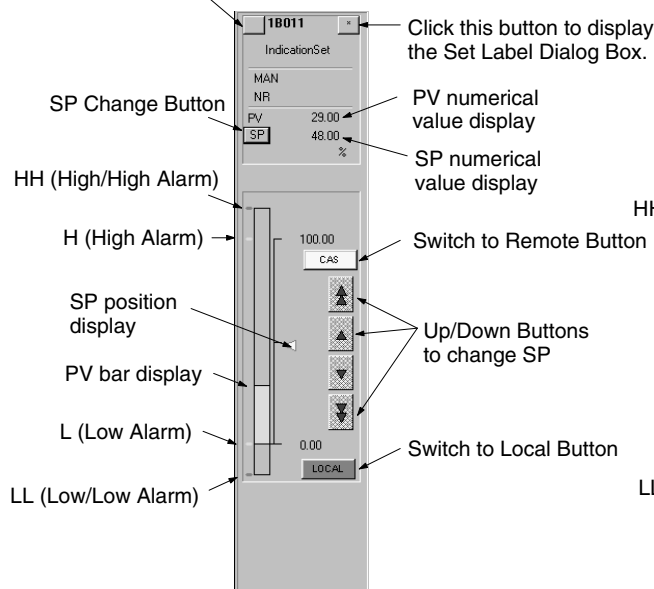

Indication and Operation (032)

Click this button to move to the Tuning screen.
See 3-7 Tuning Screen for details.

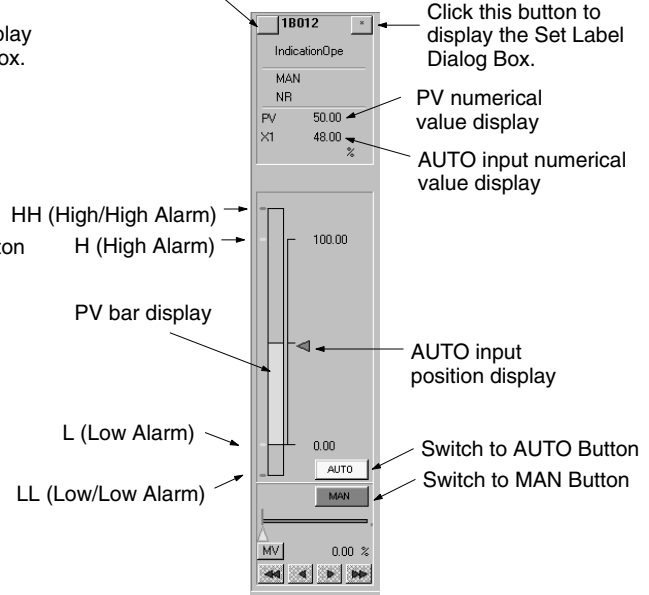

PV Bar Display

Displays the PV range from upper to lower limit as a bar.
Green: Status normal
Red: PV Alarm (either HH, H, L, LL)
Blue: Alarm OFF
Light blue: Function block calculations stopped

PV Bar Display

Displays the PV range from upper to lower limit as a bar.
Green: Status normal
Red: PV Alarm (either HH, H, L, LL)
Blue: Alarm OFF
Light blue: Function block calculations stopped

Ratio Setting (033)

Click this button to move to the Tuning screen.
See 3-7 Tuning Screen for details.

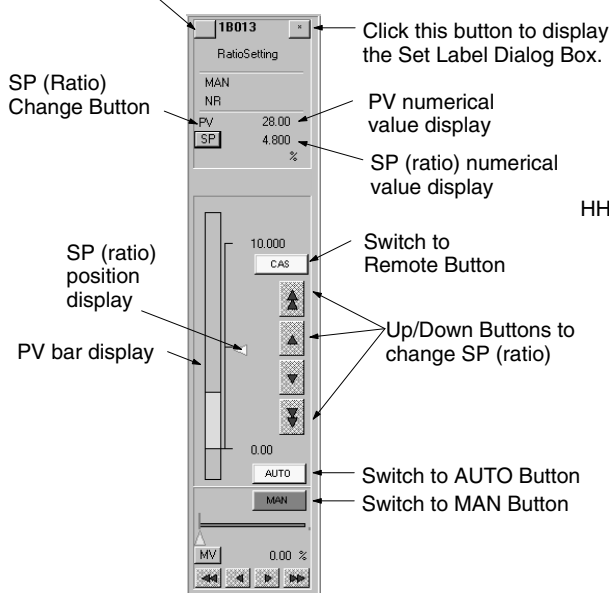

PV Bar Display

Displays the PV range from upper to lower limit as a bar.
Green: Status normal
Red: PV Alarm (either HH, H, L, LL)
Blue: Alarm OFF
Light blue: Function block calculations stopped

Indicator (034)

Click this button to move to the Tuning screen.
See 3-7 Tuning Screen for details.

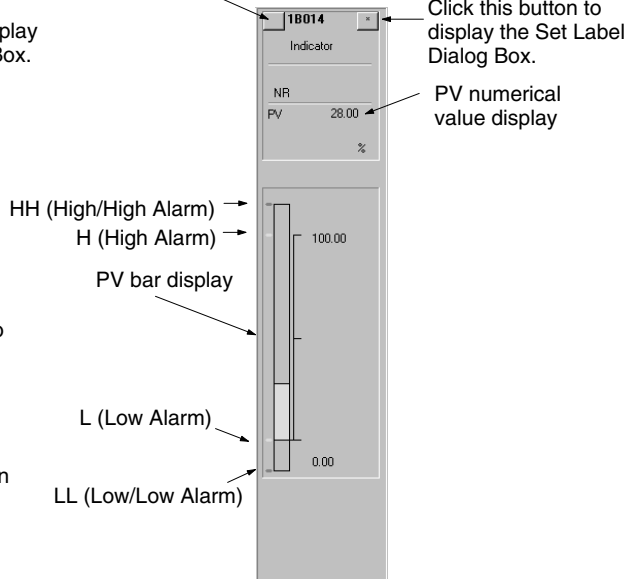

PV Bar Display

Displays the PV range from upper to lower limit as a bar.
Green: Status normal
Red: PV Alarm (either HH, H, L, LL)
Blue: Alarm OFF
Light blue: Function block calculations stopped

High/Low Alarm (111)

Click this button to move to the Tuning screen.
See 3-7 Tuning Screen for details.

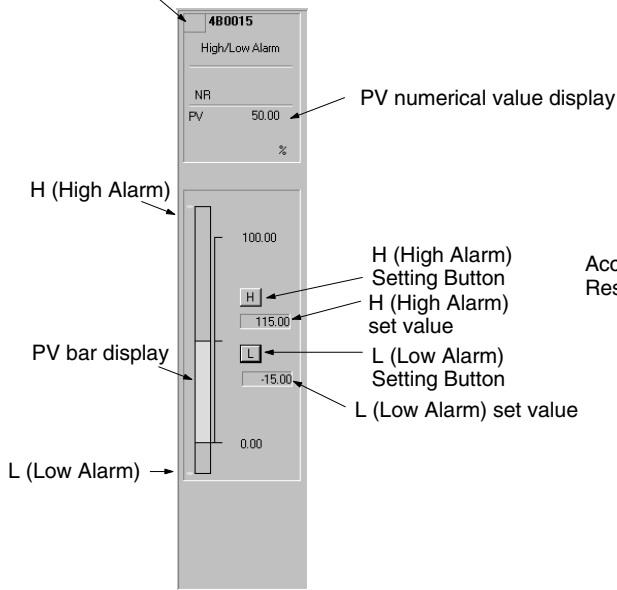

PV Bar Display

Displays the PV range from upper to lower limit as a bar.
Green: Status normal
Red: Alarm
Light blue: Function block calculations stopped

Batch Flowrate Capture (014)

Click this button to move to the Tuning screen.
See 3-7 Tuning Screen for details.

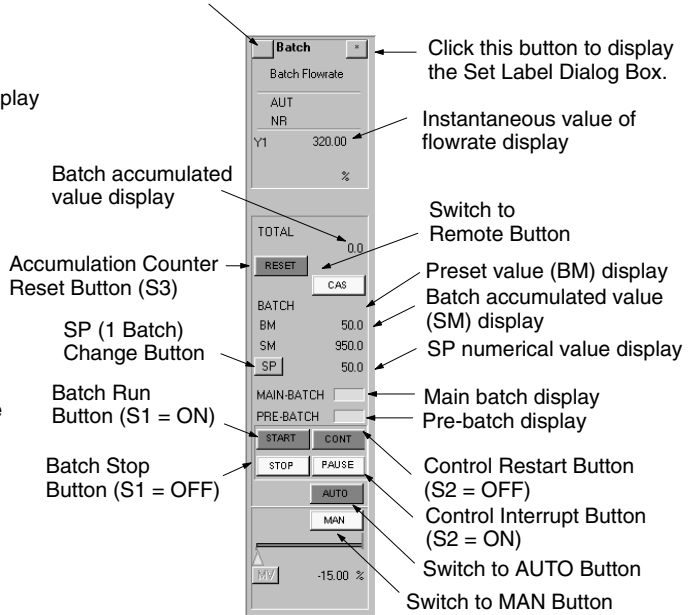

Blended PID (013)

Click this button to move to the Tuning screen.
See 3-7 Tuning Screen for details.

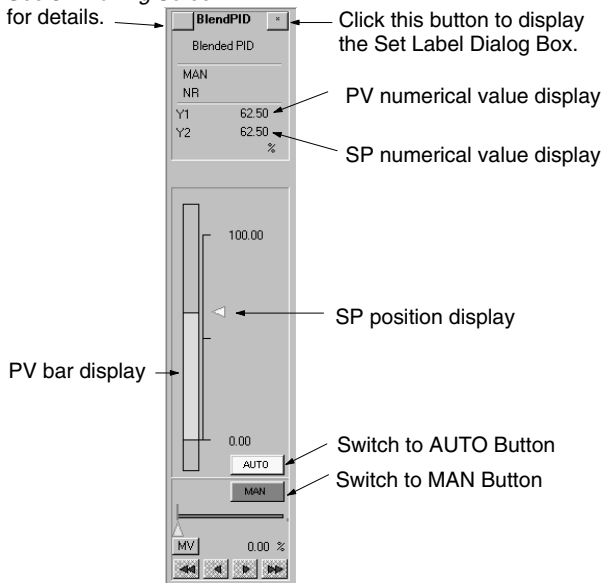

PV Bar Display

Displays the PV range from upper to lower limit as a bar.
Green: Status normal
Red: Deviation Alarm (DHH, DH, DL, or DLL)
Yellow: MV Limit High/Low
Blue: Alarm OFF
Light blue: Function block calculations stopped

Segment Program 2 (157)

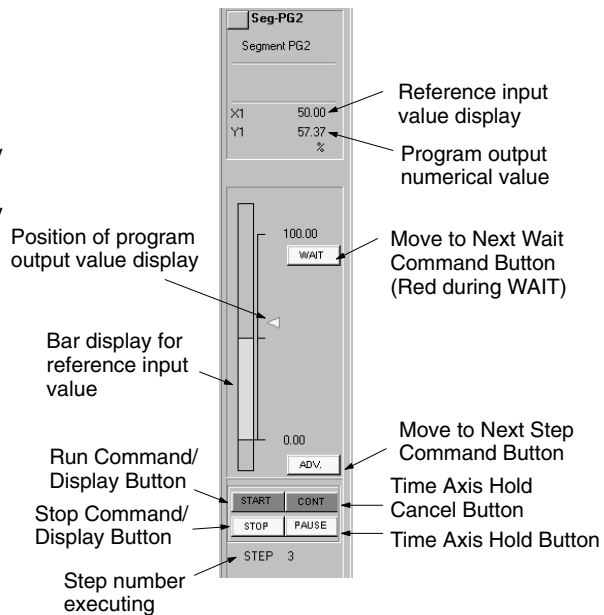

Timer (205)

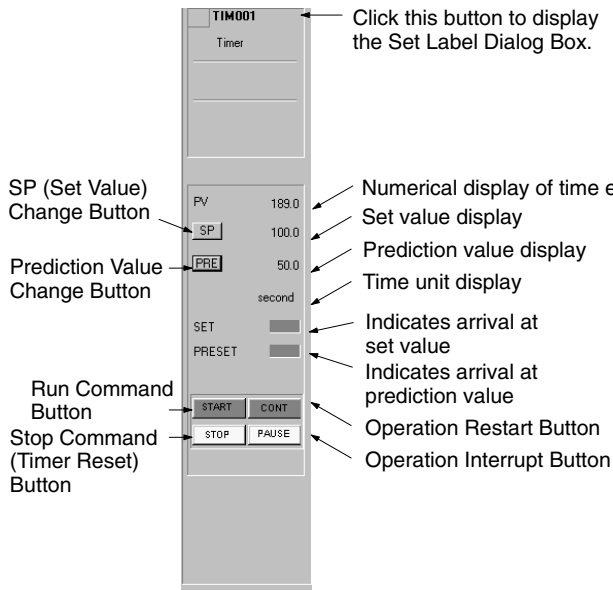

Counter (208)

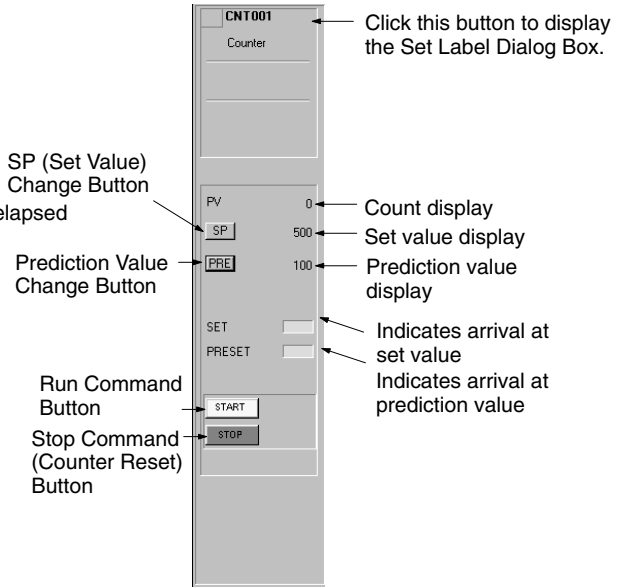

ON/OFF Valve Manipulator (221)

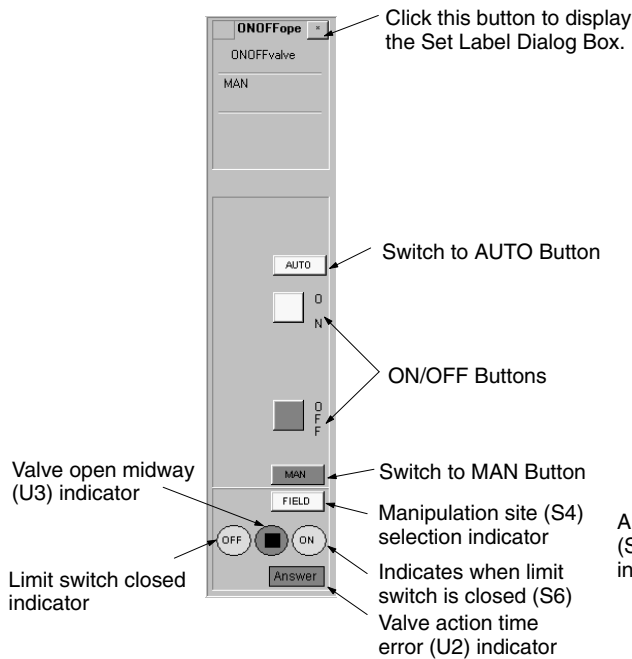

Motor Manipulation (222)

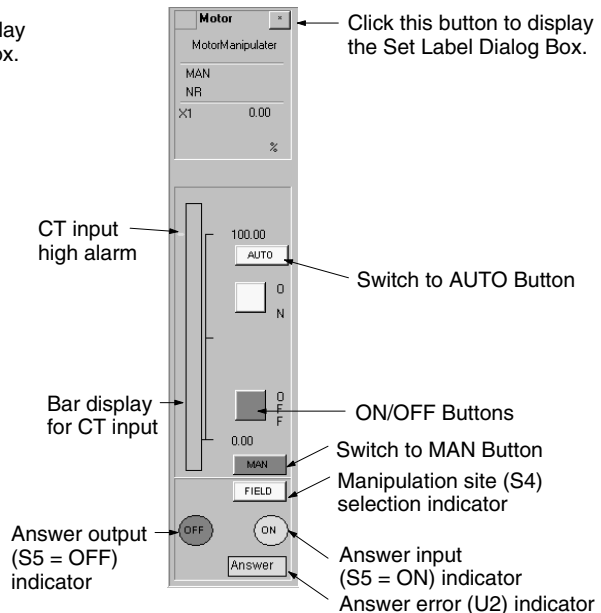

PV Bar Display

Displays the PV range from upper to lower limit as a bar.
 Green: Status normal
 Red: Alarm (H)

Reversible Motor Manipulator (223)

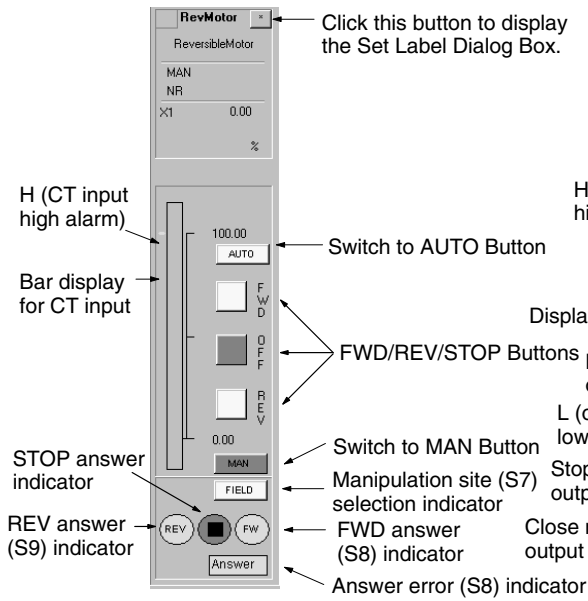

Motor Opening Manipulator (224)

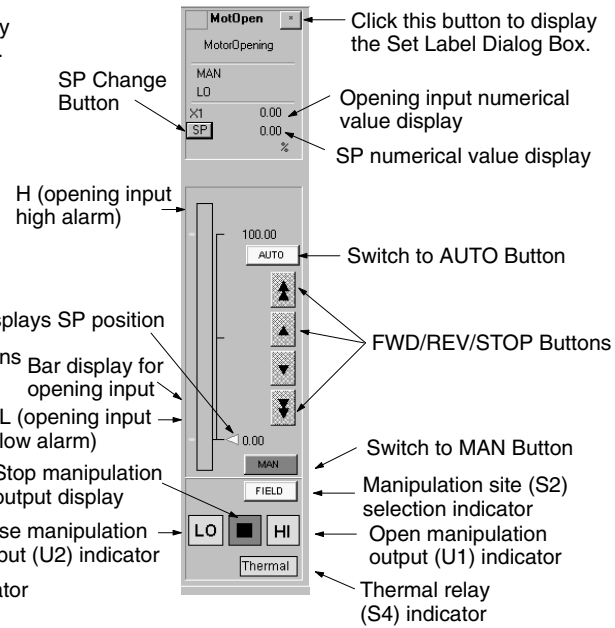

PV Bar Display

Displays the PV range from upper to lower limit as a bar.
Green: Status normal
Red: Alarm (H)

PV Bar Display

Displays the PV range from upper to lower limit as a bar.
Green: Status normal
Red: Alarm (H)

Control Screen for 1-Block Send Terminal to Computer

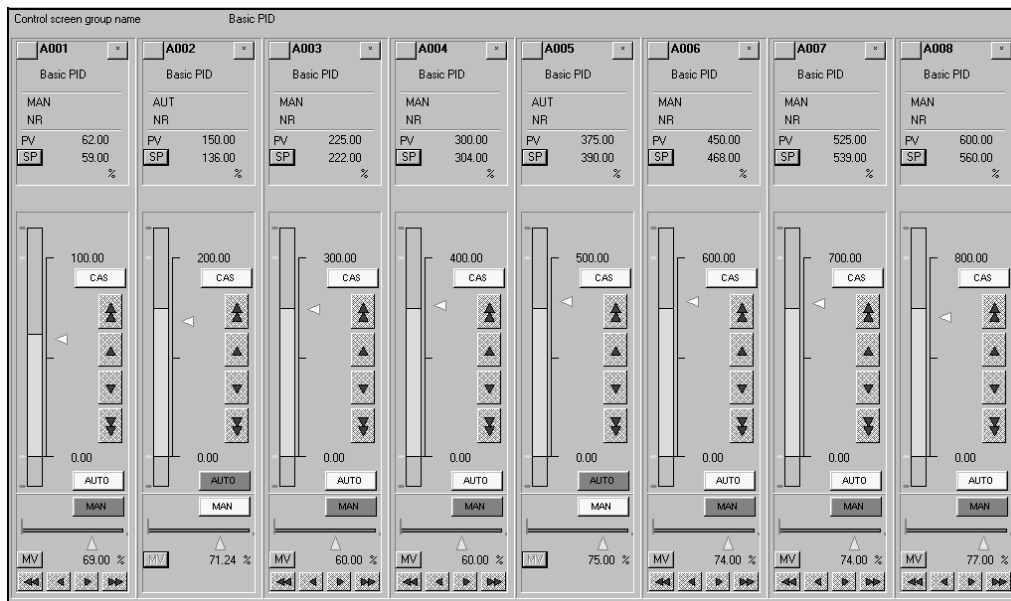

Control Screen for 4-Block Send Terminal to Computer

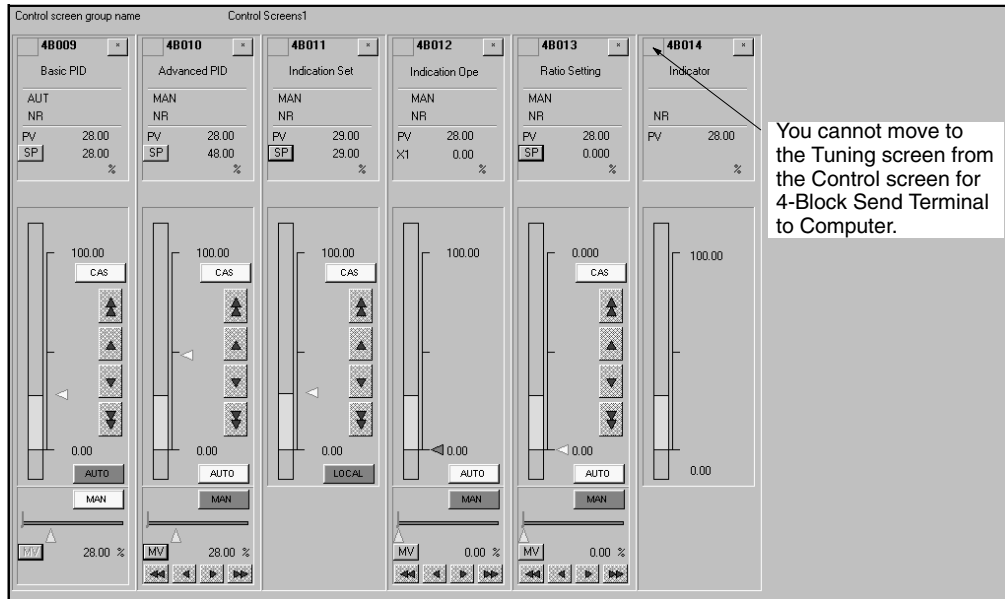

Control Screen for AO Terminal Settings from Computer, AO to Computer, and AO Terminal to All Nodes

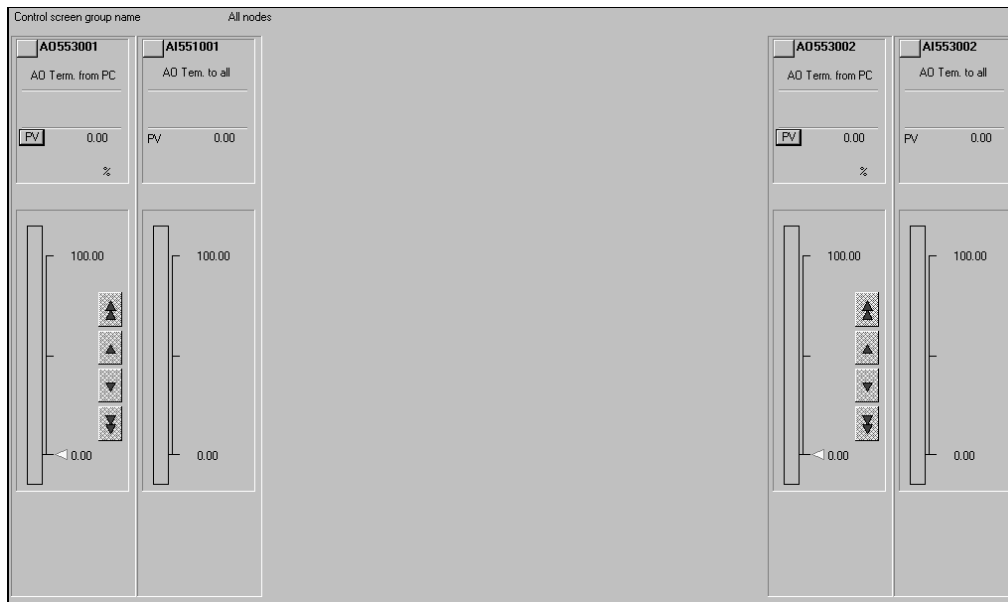

Note As shown above, the AO Terminal to All Nodes Function Block cannot be adjusted using the display alone.

Control Screen for DO Terminal Settings from Computer, DO to Computer, and DO Terminal to All Nodes



3-7 Tuning Screens

Use Tuning Screens to change Control Block P, I, and D constants specified using 1-Block Send Terminal to Computer.

- You can set the parameters for PID Block P, I, D, and alarm set values.
- You can make adjustments while monitoring PV, SP, and MV trends.
- A maximum of 3,200 screens can be displayed.
- If an alarm occurs, the bar graph color changes.

Use one of the following methods to display the Tuning Screen.

- Select a button to move to the Tuning Screen using the Control Screen. Refer to 3-6 Control Screen for details.
- Click the button displayed by the Control Screen icon in the Overview Screen. Refer to 3-4 Overview Screen for details.

A pop-up menu of tag names or a dialog box to specify the tag name will be displayed if the button on the upper left of an Overview Screen is displayed. (Refer to 3-5 Screen Configurations.) (Either a pop-up menu or a dialog box can be selected by clicking the **System Info**. Button when configuring the screen and then setting the Auto-start–Tuning screen list setting.

Block name (model)		Signal source Function Block or ITEM
Target function block	1-Block Send Terminal to Computer (403)	Control Block: Basic PID (011), Advanced PID (012), Batch flowrate capture (014), Indication and Setting (031), Indication and Operation (032), Ratio Setting (033), Indicator (034), blended PID (013), 2-position ON/OFF (001), 3-position ON/OFF (002)
	4-Block Send Terminal to Computer (404)	Segment Program 2 (157) (A 4-Block Send Terminal cannot be used.)
Display	Example: Basic or Advanced PID	SP, PV, and MV trends Setting values for P, I, D, and MV limit High/Low, High/High Alarm, High Alarm, Low Alarm, Low/Low Alarm, and Deviation Alarm. Alarm OFF switch, Stop block operation command, SP, PV, MV, and A/M status, R/L status (See note 1), bar color change if alarm occurs.
Settings	Example: Basic or Advanced PID	Setting values for P, I, D, and MV limit High/Low, High/High Alarm, High Alarm, Low Alarm, Low/Low Alarm, and Deviation Alarm. SP, MV (manual mode only), A/M switching (See note 1), R/L switching (See note 1).

- Note**
1. Same as for Control Screen
 2. If using the Tuning Screen, use the 1-Block Send Terminal to Computer function block (403). Tag names specified using the 4-Block Send Terminal to Computer function block(404) cannot be displayed on the Tuning Screen.

Click the text to display the dialog boxes for changing the settings. You can make changes uses the ten-key dialog box (using the mouse), or the keyboard. (The ten-key pad is displayed when you select the Enter box. Refer to 4-7 Labels, Alarm Sounds, and Ten-key Settings for ten-key/keyboard switching settings.)

Refer to 3-6 Control Screen for how to operate.

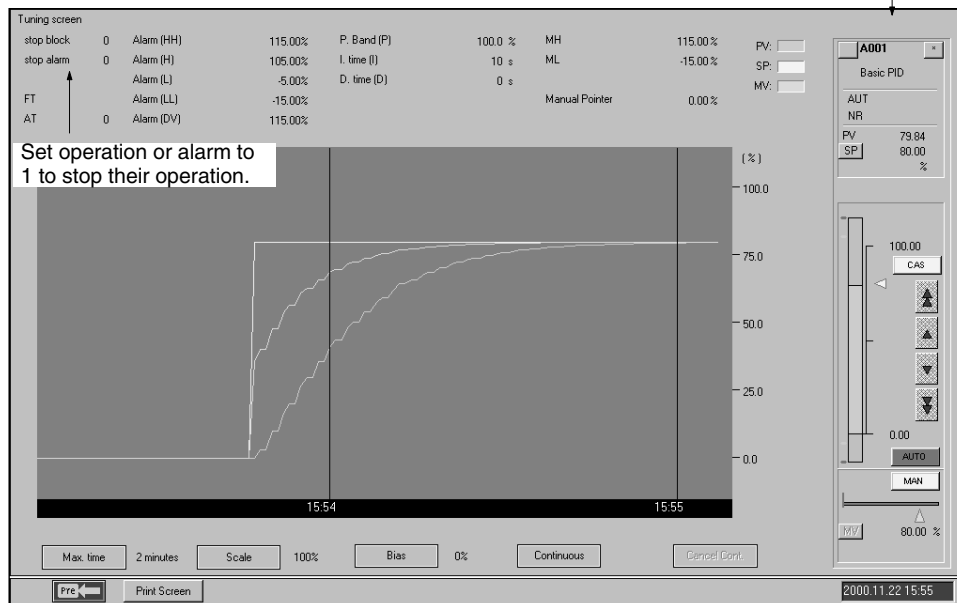

Select these buttons to display the dialog boxes for changing the settings.

Click the **Time Range** Button to set the maximum amplitude for the time axis displayed on the screen.

The scale can be set to either percentages or engineering units. The setting can be made by clicking the **System Info.** Button when configuring the screen and then setting the Auto-start–Divisions in Tuning screen setting.

To zoom in on the scale displayed, click the **Scale** Button and change the setting.

To add bias to the display, click the **Bias** Button and change the setting.

Collection of Trend data for the Tuning Screen starts once you have moved to the Tuning Screen, and is displayed only while the Tuning Screen is displayed. To continue to collect trend data even if you then move from the Tuning Screen to another screen, and to display the data continuously if you return to the Tuning Screen, click the **Continuous** Button. In this way, the data from three screens is collected against the background of the Tuning Screen.

To cancel the Continuous function explained above, click the **Cancel** button.

Note The display for Segment Program 2 (157) is shown below.

Step settings can be changed by clicking on the word.

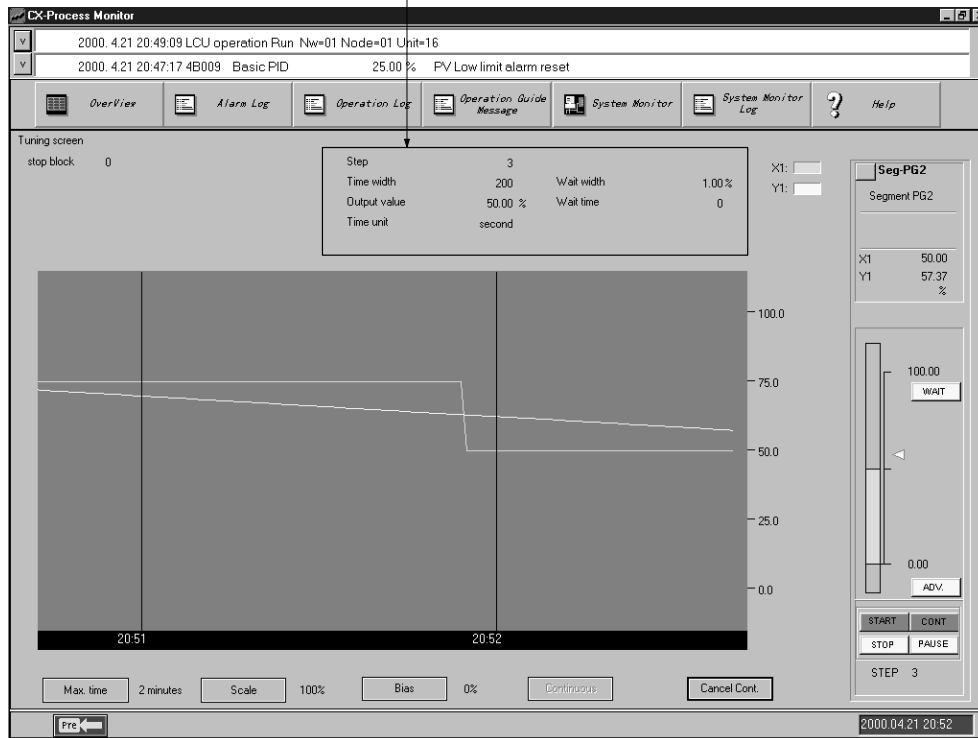

Auto-tuning (AT)

It is possible to automatically calculate and store the PID constants used for Basic PID (011) or Advanced PID (012). This function is called auto-tuning (AT). For details of the AT function, refer to the section on Basic PID (011) in the Loop Control Unit Function Block Reference Manual. AT can be set in the same way as the other settings, as shown below.

- 1, 2, 3... 1. If the value for AT displayed in the upper-left region of the Tuning Screen is 0, then AT will not be executed.
2. Click **AT**.

The Change Data Dialog Box shown below will be displayed.

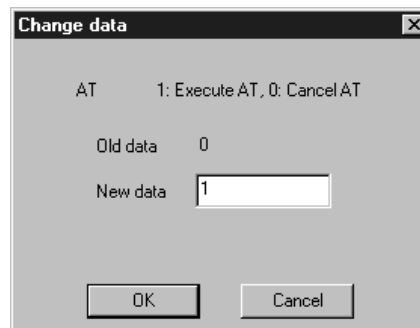

3. To execute AT, input 1 in the New Data Field.
4. Click the **OK** Button. AT will be executed (see note). The value for AT displayed in the upper-left region of the Tuning Screen will change to 1.
5. When the PID constants have been calculated and stored and AT has been completed, the value for AT displayed in the upper-left region of the Tuning Screen will return to 0.

Note Execution of AT can be cancelled from the above dialog box by inputting 0 in the New Data Field and clicking the **OK** Button. (The value for AT displayed in the upper-left region of the Tuning Screen will return to 0.)

Changing P, I, D

The following example shows how to change P (the proportional band).

- 1, 2, 3... 1. Click **Proportional Band (P)** displayed in the upper center of the screen. The Change Data Dialog Box will be displayed.

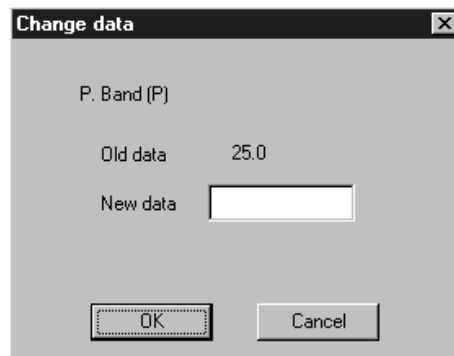

2. Select the Change To Field.

The ten-key dialog box will be displayed as shown.

Note Refer to *4-7 Labels, Alarm Sounds, and Ten-key Settings* for settings to disable the ten-key pad (i.e., to input directly from the keyboard).

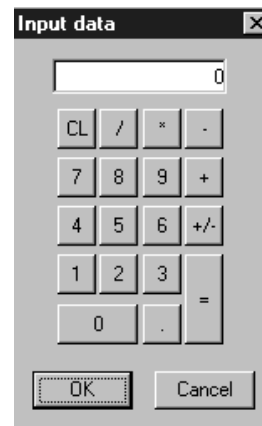

3. After using the mouse (or the keyboard) to enter a numerical value, click the **OK** Button (or press **Enter**).

The display will return to the Change Data Dialog Box shown in Step 1.

4. Click the **OK** Button.

You can change the settings for I (integral time) and D (differential time) in the same way.

Changing Other Settings

You can use the procedure explained above to change the settings for MV High/Low Limit, High/High Alarm, High Alarm, Low/Low Alarm, Low Alarm, and Deviation Alarm in the same way.

Executing Fine Tuning

Fine tuning (FT) can be executed for either Basic PID (011) or Advanced PID (012). Fine tuning lets the user use fuzzy inferences to set PID constants as required for more accurate control.

- 1, 2, 3... 1. Click **Execute FT** at the upper left portion of the Tuning Screen, as shown below.

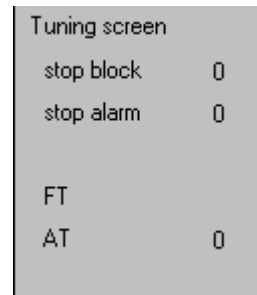

The following FT Execution Dialog Box will be displayed.

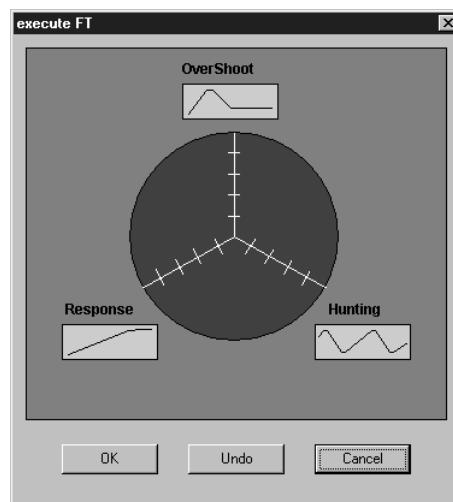

2. Set the degree of **Response** improvement, **Overshooting** control, and **Hunting** control to any of the five levels and then click the **OK** Button. Either one or two of these can be set for one executed, but all three cannot be set at the same time.

Fine tuning will be executed according to the settings, the resulting PID constants will be stored automatically, and the new values will be displayed at the top of the Tuning Screen.

3. Repeat the above process as many times as required to achieve suitable settings.
4. Click the **Undo** Button to return to the previous PID constant settings. If the Undo Button is pressed a second time, the FT settings will be returned to.

Execute fine tuning when the control performance produced by autotuning is not acceptable, when autotuning produces inconsistency in the PV, or when you cannot allow control to be interrupted.

Fine tuning uses three user settings for hunting control, overshooting, and response improvement along with fuzzy inferences from previous control conditions to improve control by automatically setting PID parameters.

Either one or two of the user settings for hunting control, overshooting, and response improvement can be set to any of five levels. For example, to better con-

ontrol hunting and overshooting, the *Overshoot* and *Hunting* parameters can be set to to the desired levels.

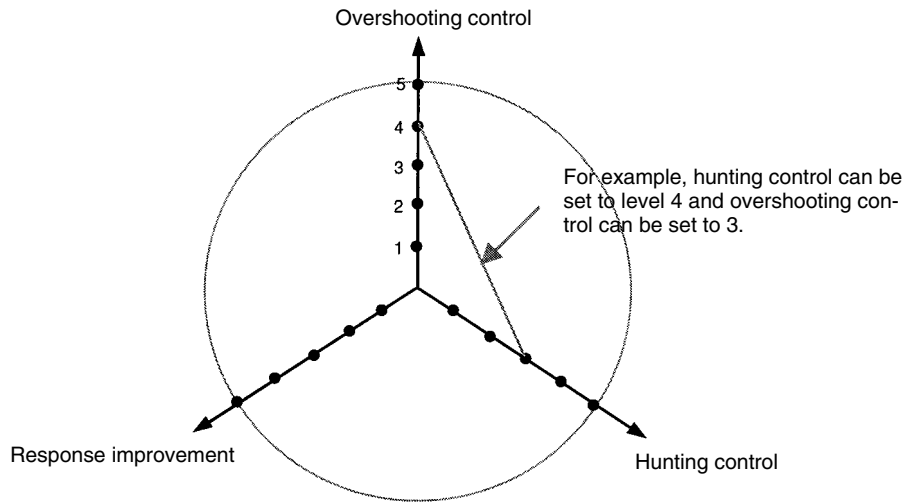

3-8 Trend Screens

Trend Screens display changes in Control Block PV, SP, MV, and analog signals across the passage of time as recording meter images. To display the Trend Screen, click the **Trend Screen** Button in the Overview Window.

Real Time Trend Screen Display

Data setting values marked with this symbol are graded on the graph. Select the number icon to change the setting.

Data values at the point in time displayed by this mark (the current value for the default) are displayed in the upper part of the screen. You can drag this mark to move it about the screen. All data is displayed as real numbers.

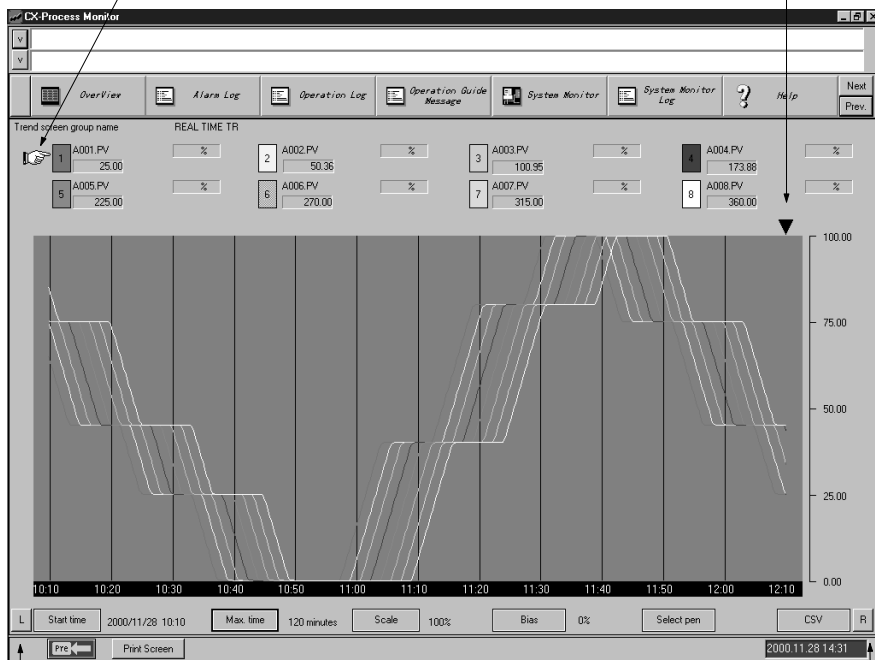

Time Scroll
Shifts one screen further to the past.

Time Scroll
Shifts one screen further to the future.

Function block PV, SP, MV, and analog signals output from the Send Terminal to Computer function block are collected in fixed cycles, the trend displayed, and simultaneously stored in a file.

Trends are displayed as multi-dot recorder screen images to a maximum of eight dots per screen.

The following two Trend Screens are supported.

Data collection (Logger function)	Realtime Trend	10-s cycle, 480 Tags max., stored for 12 hours
	Historical Trend	60 s cycle, 960 Tags max., stored for 10 days
Data display	Horizontal axis: Time display axis: You can scroll through 2, 4, 8, 12, and 24-hour axes. Vertical axis: 8-dot all-points axis. You can magnify the gradations by 1x, 2x, 5x, or 10x. Specify the display start time to display data from that point in time. Display colors: Red, yellow, green, blue, magenta, purple, cyan, and white.	

You can register a maximum of 60 Realtime Trend Screens, or 120 Historical Trend Screens.

Set either Realtime Trend or Historical Trend when configuring the screen.

Regardless of the trend, trend data collection itself starts at the same time as the monitor process is started (using the **Start Up** Button in the Set Up Dialog Box).

- Click the **Start Time** Button in the lower left of the screen to set the time from which data will be displayed.
- Click the Maximum Display Time Button to set the maximum width of the time axis displayed on the screen.
- To zoom in on the scale displayed, click the **Scale** Button and change the setting.
- To add bias to the display, click the **Bias** Button and change the setting.
- Use the **Select Pen** Button to select the pen you want to display.

Realtime trends can be recorded for up to 12 hours, after which the oldest data is discarded.

	Function block name (format)	Send source function block, or ITEM
Target function block	1-Block Send Terminal to Computer (403)	Control Block: PV, SP, MV, Y1, Y2, and HL only for Basic PID (011), Advanced PID (012), Batch flowrate capture (014), Indication and Setting (031), Indication and Operation (032), Ratio Setting (033), Indicator (034), blended PID (013), 2-position ON/OFF (001), and 3-position ON/OFF (002).
	4-Block Send Terminal to Computer (404)	Control Block: PV, SP, and MV only for Basic PID (011), Advanced PID (012), Indication and Setting (031), Indication and Operation (032), Ratio Setting (033), Indicator (034), 2-position ON/OFF (001), and 3-position ON/OFF (002), Segment Program 2 (157), ON/OFF Valve Manipulation (223), Motor Manipulator (222), Reversible Motor Manipulator (223), Motor Opening Manipulator (224)
	AO to Computer (402), AO Terminal to all nodes (408)	Analog input signals or analog output signals for all Function Blocks, or analog value parameters
	DO to Computer (401), DO Terminal to all nodes (407)	Contact input signals or contact output signals for all Function Blocks, or contact value parameters
Display		SP, PV, and MV, analog value, and contact (See note.)
Setting		None

Note MV is displayed as an SP and PV range, not as a percentage.

Historical Trend Screen Display

Data setting values marked with this symbol are graded on the graph. Select the number icon to change the setting.

Data values at the point in time displayed by this mark (the current value for the default) are displayed in the upper part of the screen. You can drag this mark to move it about the screen. All data is displayed as real numbers.

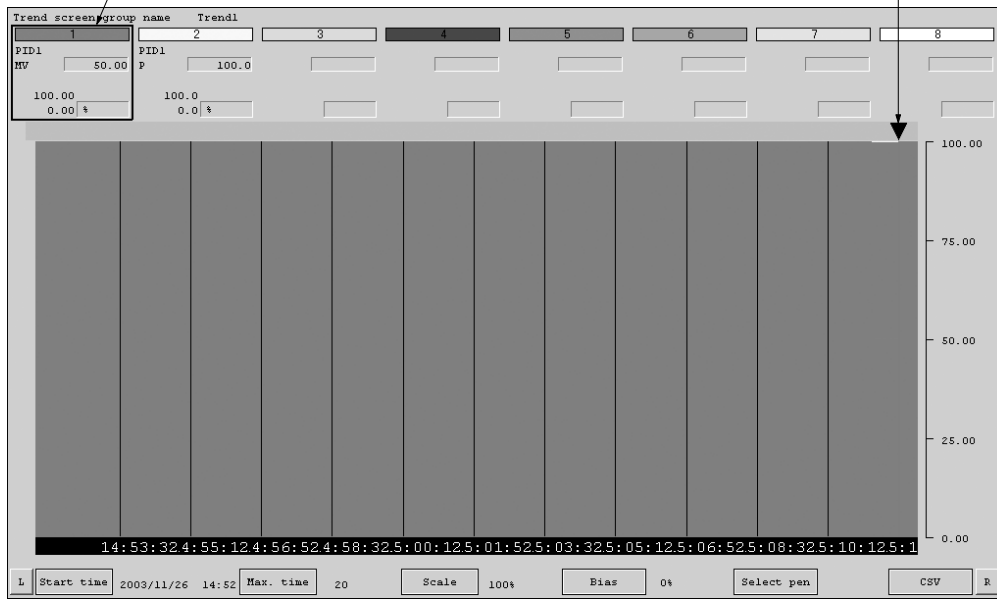

Time Scroll
Shifts one screen further to the past.

Time Scroll
Shifts one screen further to the future.

CSV File Output

Realtime Trend data and Historical Trend data (data grouped by date, time, or Tag Name) can be output in CSV (Comma Separated Value) file format using the following procedure.

- 1, 2, 3... 1. Press the **CSV** Button to display the Export to CSV File Dialog Box.

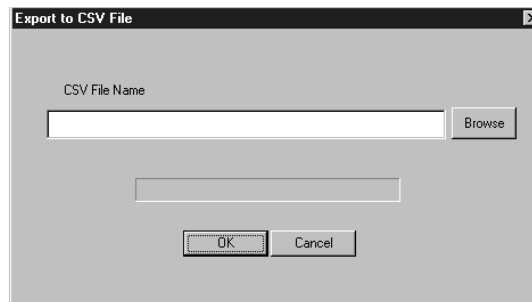

2. Specify a name for the CSV file, and click the **OK** Button. A CSV file will be created. (By clicking the **Browse** Button, the CSV file can be created in a desired folder. The default filename for Realtime Trend data is Trtl.csv and the default filename for Historical Trend data is Trhl.csv.) The contents of CSV files created are as follows.

Realtime Trend

“Real-time Trend”(carriage return)
 <Screen_name>(carriage return)
 <Date_exported>(comma)<Time_exported>(carriage return)
 (comma)(comma)<Number_tag_number_1>(comma)<Number_tag_number_2>(comma)...(comma)<Number_Tag_number_8>(carriage return)

(comma)(comma)<Configuration_tag_number_1>(comma)<Configura-
 tion_tag_number_2>(comma)...(comma)<Configuration_tag_number_8>(car-
 riage return)
 <Date_of_trend_data>(comma)<Time_of_trend_data>(comma)<Data_1>(co
 mma)<Data_2>(comma)...(comma)<Data_8>(carriage return)

Note Data for tag names that have not been registered will be 0.

Historical Trend

“Historical Trend”(carriage return)
 <Screen_name>(carriage return)
 <Date_exported>(comma)<Time_exported>(carriage return)
 (comma)(comma)<Number_tag_number_1>(comma)<Number_tag_num-
 ber_2>(comma)...(comma)<Number_Tag_number_8>(carriage return)
 (comma)(comma)<Configuration_tag_number_1>(comma)<Configura-
 tion_tag_number_2>(comma)...(comma)<Configuration_tag_number_8>(car-
 riage return)<Date_of_trend_data>(comma)<Time_of_trend_data>(comma)
 <Data_1>(comma)<Data_2>(comma)...(comma)<Data_8>(carriage return)

Note Data for tag names that have not been registered will be 0.

Example: The following screen shows how Realtime Trend data exported to spreadsheet software (e.g., Microsoft Excel) will be displayed.

	A	B	C	D	E	F	G	H	I	J	K
1	Real-time Trend										
2	REAL TIME TR										
3	11/22/00	20:57:24									
4			A001	A002	A003	A004	A005	A006	A007	A008	
5			PV	PV	PV	PV	PV	PV	PV	PV	
6	11/22/00	9:01:10	0	0	0	0	0	0	0	0	0
7	11/22/00	9:01:20	0	0	0	0	0	0	0	0	0
8	11/22/00	9:01:30	0	0	0	0	0	0	0	0	0
9	11/22/00	9:01:40	0	0	0	0	0	0	0	0	0
10	11/22/00	9:01:50	0	0	0	0	0	0	0	0	0
11	11/22/00	9:02:00	0	0	0	0	0	0	0	0	0

Updating Trend Definitions Online

Pens can be changed, deleted, or added to Trend Screens without shutting down the CX-Process Monitor Plus.

Changing/Deleting Pens from the Dialog Box

- 1, 2, 3... 1. Double-click the pen selection area.

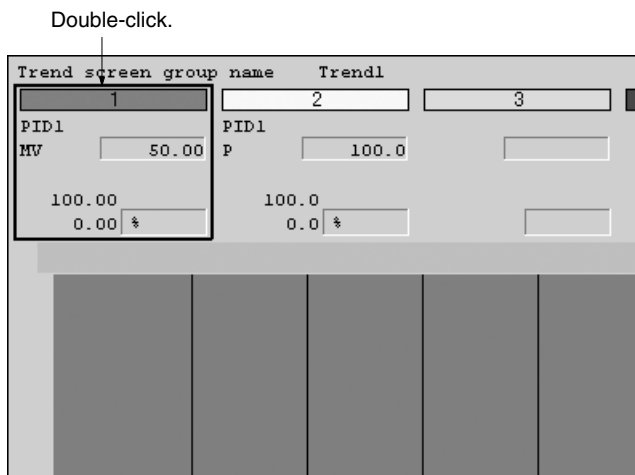

2. The following dialog box will be displayed. Click where indicated by numbers 1 to 4 in the following diagram to set the items.

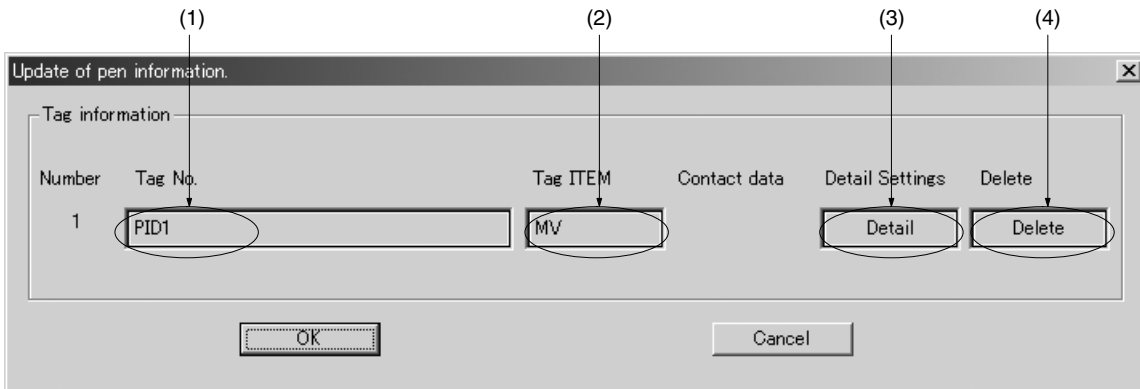

(1) Tag Name Selection for CSV Tag

Displays a list of tags registered in CX-Process Monitor Plus.

(2) ITEM Tag Selection

Set the type of ITEM to use to narrow the ITEM list displayed for the tag names above.

(3) Detailed Settings

When the tag name is set above, the upper/lower limits of the specified tag will be displayed by default. The setting can be changed.

(4) Delete

Deletes the selected pen.

- Note**
- When the button is pressed, all tag information will be deleted from the Trend Screen, including the graphic display for the pen.
 - After the four items above are set and the **OK** Button is clicked, some time will be required before the results are displayed on the Trend Screen. This time will be the collection cycle (approximately 10 s for realtime trends and 60 s for historical trends) plus the screen refresh cycle (a few seconds). If another screen is switched to, the changes will be reflected in the screen as soon as it is returned to.

Adding Pens from the Dialog Box

Use the following procedure to assign a tag to a pen for which one is not yet assigned.

- 1, 2, 3... 1. Double-click in the area circled in the screen shown below.

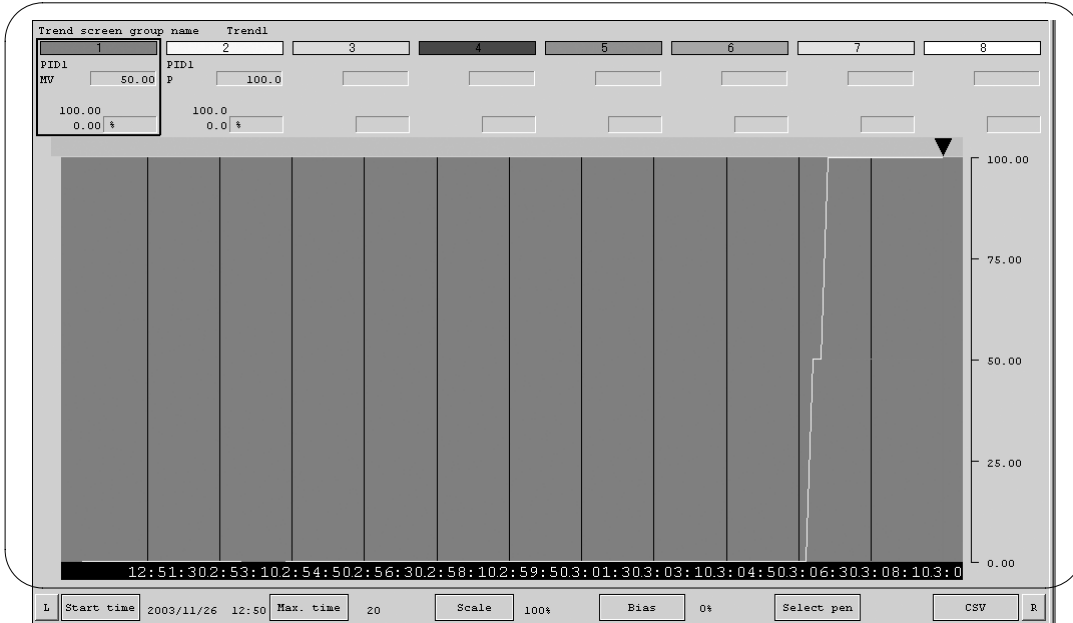

The following dialog box will appear to change the pen.

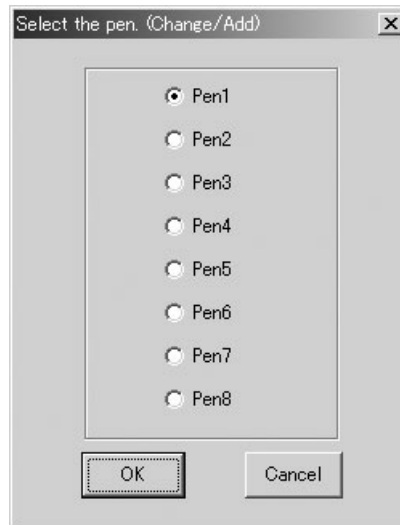

2. Select a pen to which a tag is not yet assigned and click the **OK** Button.
3. Assign the pen using the same dialog box as used to change and delete pens in the previous procedure.

3-9 Graphic Screens

Graphic Screens display the status of the system or device in graphic form. To display the Graphic Screen, click the **Graphic Screen** Icon in the Overview Screen.

Graphic Screen

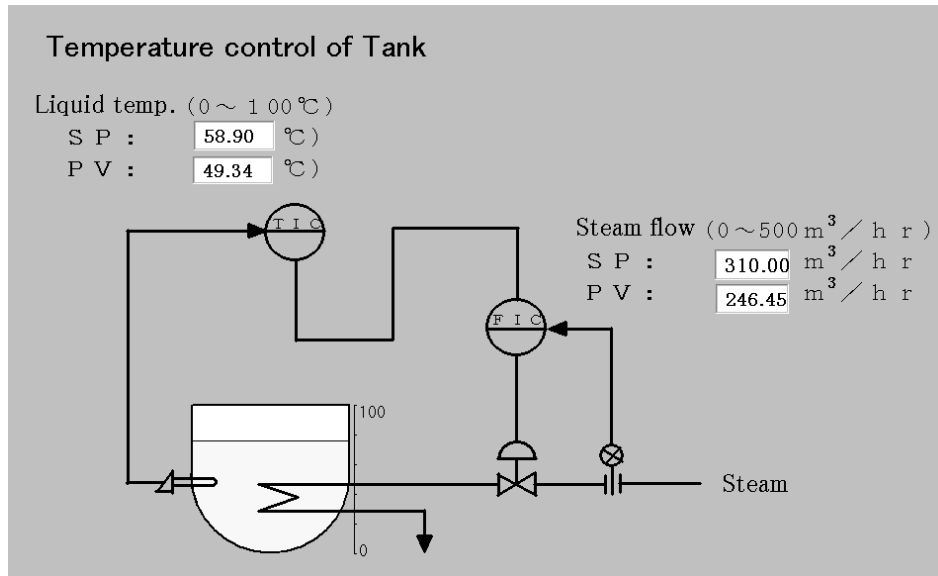

Paste to the screen graphic elements representing plant instrumentation, which have been pre-prepared, and use them to display the device status, to a maximum of 200 screens.

Pre-prepared fixed graphic display elements: Text, instruments, thermometers, transmitters, orifices.

Pre-prepared changeable graphic display elements:

Analog inputs: Bar graph displays, numerical value displays, tanks

Analog settings: Numerical settings (See note.)

Contact inputs (display): Pumps, valves, pipes

Contact settings (operation): Switches (See note.)

Note If making analog values or contact settings, use AO Settings from Computer or DO Settings from Computer Tags function blocks.

For other fixed graphics, read and paste created using bitmap files. Basically, after cutting and pasting the background and other graphics, paste the pre-prepared fixed or changeable graphic display elements mentioned above to create the complete Graphic Screen.

Element	Function block name (model)	Function block or ITEM set as send source
Function block	1-Block Send Terminal to Computer (403)	Control Block: Tag ITEMS for Basic PID (011), Advanced PID (012), Batch flowrate capture (014), Indication and Setting (031), Indication and Operation (032), Ratio Setting (033), Indicator (034), blended PID (013), 2-position ON/OFF (001), 3-position ON/OFF (002)
	4-Block Send Terminal to Computer (404)	Control Block: Basic PID (011), Advanced PID (012), Indication and Setting (031), Indication and Operation (032), Ratio Setting (033), Indicator (034), 2-position ON/OFF (001), 3-position ON/OFF (002) Operation Block: High/Low Alarm (111), Segment Program 2 (157), ON/OFF Value Manipulator (221), Motor Manipulator (222), Reversible Motor Manipulator (223), Motor Opening Manipulator (224), Timer (205), Counter (208)
	AO to Computer (402), AO Terminal to all nodes (408)	Analog input signals or analog output signals for all Function Blocks, or analog value parameters
	DO to Computer (401), DO Terminal to all nodes (407)	Contact input signals or contact output signals for all Function Blocks, or contact value parameters
	AO Terminal Settings from Computer (410)	Analog output ITEM for AO Terminal Settings from Computer (Used to set ordinary analog values. Displays using network resend monitoring.)
	DO Terminal Settings from Computer (409)	Contact output ITEM for DO Terminal Settings from Computer (Used to set ordinary contact values. Displays using network resend monitoring.)
	Display	Analog values: Bar graphs, numerical values, tank level Contacts: Indicators, pumps, valves, pipes
Setting	Analog values: Numerical values (using AO Terminal Settings from Computer) Contacts: Switches (using DO Terminal Settings from Computer)	

3-10 Annunciator Screens

Annunciator Screens display comprehensively the contacts status (mainly the alarm status). To display the Annunciator Screen, click the **Annunciator Screen** icon on the Overview Screen.

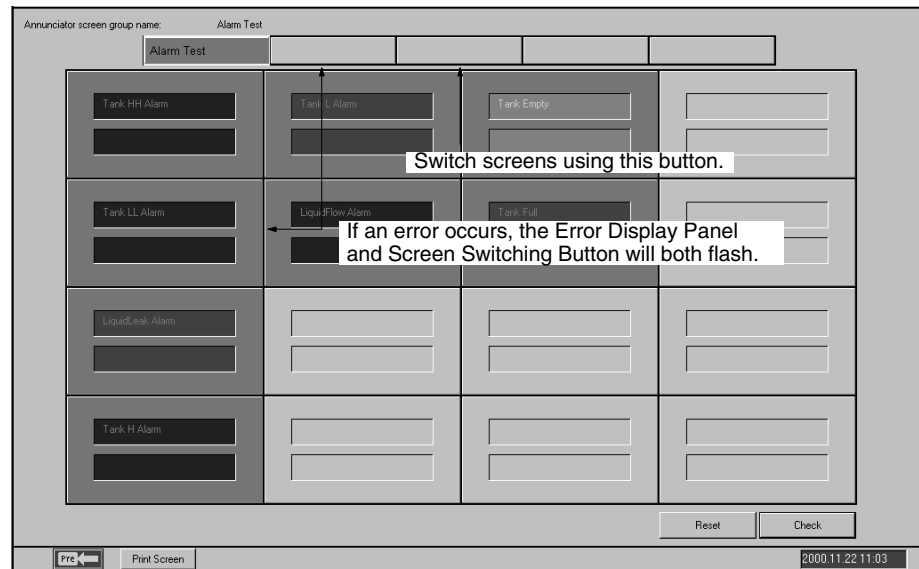

There are no particular limits to contacts that can be specified. Basically, however, register contacts that display the alarm status of the Control Block's HH (High/High Alarm), H (High Alarm), L (Low Alarm), and LL (Low/Low Alarm), etc.

If an alarm/error occurs, the icon color will change and a beep will sound. At the same time, two rows of eight wide-size characters making a user-registered message can be displayed.

You can display a total of 16 separate elements per screen as 4 rows x 4 columns, to a maximum of five screens.

	Function block name (format)	Send source Function Block, or ITEM
Target function block	1-Block Send Terminal to Computer (403)	Control Block: Contacts within Tag ITEMS for Basic PID (011), Advanced PID (012), Batch flowrate capture (014), Indication and Setting (031), Indication and Operation (032), Ratio Setting (033), Indicator (034), blended PID (013), 2-position ON/OFF (001), and 3-position ON/OFF (002).
	4-Block Send Terminal to Computer (404)	Control Block: PV, SP, and MV only for Basic PID (011), Advanced PID (012), Indication and Setting (031), Indication and Operation (032), Ratio Setting (033), Indicator (034), 2-position ON/OFF (001), and 3-position ON/OFF (002). Operation Block: High/Low Alarm (111), Segment Program 2(157), ON/OFF Valve Manipulator (221), Motor Manipulator (222), Reversible Motor Manipulator (223), Motor Opening Manipulator (224), Timer (205), Counter (208)
	DO to Computer (401), DO Terminal to all nodes (407)	Contact input signals or contact output signals for all Function Blocks, or contact value parameters
	DO Terminal Settings from Computer (409)	Contact output ITEM for DO Terminal Settings from Computer (Network resend only.)
Display		Color, sound, and messages displayed when contact is ON.
Setting		None

3-11 Operation Guide Message Screens

Operation Guide Message Screens display messages registered when the contact signal was turned ON. To display the Operation Guide Message Screen, click the **Operation Guide Button**.

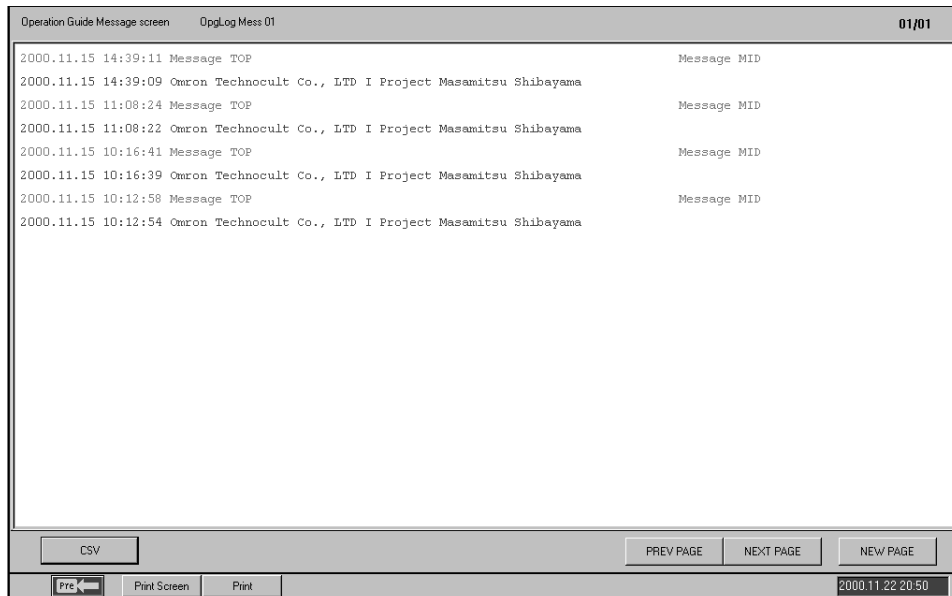

When the specified contact (internal switch, etc.) is turned ON, the pre-prepared wide-size character message (32 characters x 2 lines) will be displayed together with the time the contact was turned ON. (When the contact is turned ON, a red mark will be displayed next to the Operation Guide icon on the Overview Screen.)

Possible No. of registrations: 100 messages max.

Message colors: 16 colors, displayed with sound.

You can display a message with a maximum of 1,000 elements on one screen.

Note The internal switches are collated as one by the DO to Computer and the AO Terminal to All Nodes function blocks, and then sent to the computer for use.

	Function block name (format)	Send source Function Block, or ITEM
Target function block	1-Block Send Terminal to Computer (403)	Control Block: Contacts within Tag ITEMS for Basic PID (011), Advanced PID (012), Batch flowrate capture (014), Indication and Setting (031), Indication and Operation (032), Ratio Setting (033), Indicator (034), blended PID (013), 2-position ON/OFF (001), and 3-position ON/OFF (002).
	4-Block Send Terminal to Computer (404)	Control Block: PV, SP, and MV only for Basic PID (011), Advanced PID (012), Indication and Setting (031), Indication and Operation (032), Ratio Setting (033), Indicator (034), 2-position ON/OFF (001), and 3-position ON/OFF (002). Operation Block: High/Low Alarm (111), Segment Program 2 (157), ON/OFF Value Manipulator (221), Motor Manipulator (222), Reversible Motor Manipulator (223), Motor Opening Manipulator (224), Timer (205), Counter (208)
	DO to Computer (401)	Contact input signals or contact output signals for all Function Blocks, or contact value parameters
	DO Terminal Settings from Computer (409)	Contact output ITEM for DO Terminal Settings from Computer (Network resend only.)
Display		Color, sound, and messages displayed when contact is ON.
Setting		None

CSV File Output

Operation Guide message data (date, time, contents of Operation Guide) can be output in CSV (Comma Separated Value) file format using the following procedure.

- 1, 2, 3... 1. Press the **CSV** Button to display the Export to CSV File Dialog Box.
2. Specify a name for the CSV file, and click the **OK** Button. A CSV file will be created. (By clicking the **Browse** Button, the CSV file can be created in a desired folder. The default filename is Opglog.csv.) The contents of CSV files created are as follows.

```

"Operation Guide Message Log"(carriage return)
<Screen_name>(carriage return)
<Date_exported>(comma)<Time_exported>(carriage return)
<Date_of_Operation_Guide>(comma)<Time_of_Operation_Guide>(comma)<Contents_of_Operation_Guide>(carriage return)
    
```

Note "Contents of Operation Guide" refers to all the data in one line of an Operation Guide Message Screen.

3-12 Alarm Log Screens

Alarm Log Screens display alarm logs. To display the Alarm Log Screen, click the **Alarm** Button.

The targets monitored for alarms are as follows: Control Block's HH (High/High Alarm), H (High Alarm), L (Low Alarm), LL (Low/Low Alarm), and DA (Deviation Alarm) contacts, and other contact signals (including parameters).

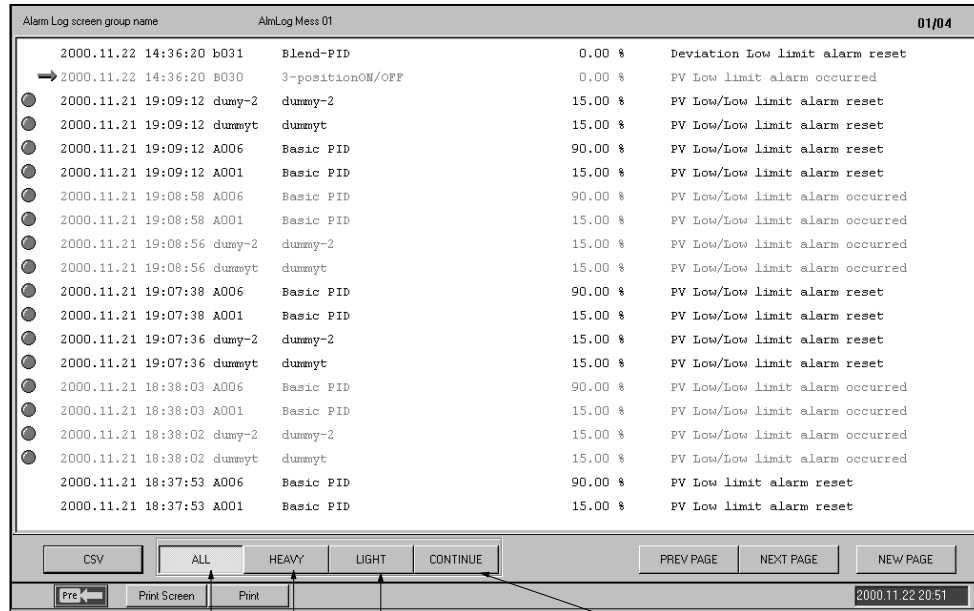

Display all

Display only LIGHT (Light alarm), H (High alarm), or L (Low alarm)

Display only current errors

Display only HEAVY (Heavy alarm), HH (High/High alarm), or LL (Low/Low alarm)

Save and display comprehensively alarm records (time error occurred, Tag name, current value when PV or MV occurred, alarm type, etc.) occurring from the Controller and Alarm Blocks.

You can display a maximum of 1,000 alarm messages on one screen.

Element	Function block name (model)	Function block or ITEM set as send source
Function block	1-Block Send Terminal to Computer (403)	Control Block: High/High alarm, High alarm, Low alarm, Low/Low alarm, and Deviation alarm for Basic PID (011), Advanced PID (012), Batch flowrate capture (014), Indication and Setting (031), Indication and Operation (032), Ratio Setting (033), Indicator (034), blended PID (013), 2-position ON/OFF (001), and 3-position ON/OFF (002).
	4-Block Send Terminal to Computer (404)	Control Block: High/High alarm, High alarm, Low alarm, Low/Low alarm, and Deviation alarm for Basic PID (011), Advanced PID (012), Indication and Setting (031), Indication and Operation (032), Ratio Setting (033), Indicator (034), 2-position ON/OFF (001), and 3-position ON/OFF (002), Segment Program 2 (157), ON/OFF Value Manipulator (221), Motor Manipulator (222), Reversible Motor Manipulator (223), Motor Opening Manipulator (224).
	DO to Computer (401)	Contact input signals or contact output signals for all Function Blocks, or contact value parameters
Display		Alarm history (date and time of occurrence, and value when alarm occurred) Time of occurrence: Red; Time of recovery: Black
Setting		None

CSV File Output

Alarm log data (date, time, current value when alarm occurred, type of alarm) can be output in CSV (Comma Separated Value) file format using the following procedure.

- 1, 2, 3... 1. Press the **CSV** Button to display the Export to CSV File Dialog Box.
2. Specify a name for the CSV file, and click the **OK** Button. A CSV file will be created. (By clicking the **Browse** Button, the CSV file can be created in a desired folder. The default filename is Almlog.csv.) The contents of CSV files created are as follows.

“Alarm Log”(carriage return)
 <Date_exported>(comma)<Time_exported>(carriage return)
 <Date_of_alarm>(comma)<Time_of_alarm>(comma)<Contents_of_alarm>(carriage return)

Note “Contents of alarm” refers to all the data in one line of an Alarm Log Screen.

Example: The following screen shows how alarm log data exported to spreadsheet software (e.g., Microsoft Excel) will be displayed.

	A	B	C	D	E	F	G	H	I	J	K
	Alarm Log										
Date exported	4/21/00	22:00:43									
	4/21/00	21:56:18	2000. 4.21	21:56:18	1B014	Indicator		28.00 %		PV Low limit alarm reset	
	4/21/00	21:56:18	2000. 4.21	21:56:18	1B012	IndicationOpe		50.00 %		PV Low limit alarm reset	

Date of alarm Time of alarm

Contents of alarm
(All the data in one line of an Alarm Log Screen)

3-13 Operation Log Screens

Operation Log Screens display operation logs. To display the Operation Log Screen, click the **Operation Log** Button.

Operation Log screen group name		Control Mess 01		01/08	
2000.11.22	20:47:56	A001	Basic PID	LP_SP	88.70 29.00 %
2000.11.22	20:46:39	A001	Basic PID	LP_SP	29.70 72.00 %
2000.11.22	20:45:03	A001	Basic PID	LP_SP	72.70 87.00 %
2000.11.22	20:45:03	A001	Basic PID	LP_SP	73.70 87.00 %
2000.11.22	20:45:02	A001	Basic PID	LP_SP	74.70 87.00 %
2000.11.22	20:45:02	A001	Basic PID	LP_SP	75.70 87.00 %
2000.11.22	20:45:02	A001	Basic PID	LP_SP	76.70 87.00 %
2000.11.22	20:45:02	A001	Basic PID	LP_SP	77.70 87.00 %
2000.11.22	20:44:55	A001	Basic PID	LP_SP	87.70 81.00 %
2000.11.22	20:44:52	A001	Basic PID	LP_SP	81.70 45.00 %
2000.11.22	20:44:47	A001	Basic PID	LP_SP	45.70 29.00 %
2000.11.22	20:43:46	A001	Basic PID	LP_SP	29.70 66.00 %
2000.11.22	20:43:40	A001	Basic PID	A/M_SW	1 1 %
2000.11.22	20:43:40	A001	Basic PID	R/L_SW	0 1 %
2000.11.22	16:30:15	A001	Basic PID	A/M_SW	1 1 %
2000.11.22	16:30:15	A001	Basic PID	R/L_SW	0 0 %
2000.11.22	15:53:45	A001	Basic PID	LP_SP	80.00 0.00 %
2000.11.22	15:27:12	A001	Basic PID	LP_SP	0.00 80.00 %
2000.11.22	15:27:11	A001	Basic PID	LP_SP	1.00 80.00 %
2000.11.22	15:27:10	A001	Basic PID	LP_SP	-7.00 80.00 %

CSV PREV PAGE NEXT PAGE NEW PAGE

Print Screen Print 2000.11.22 20:52

Save and display comprehensively records (time and date operation occurred, Tag name, ITEM data before change, ITEM data after change, etc.) of ITEM data changed within the Loop Control Unit, using the Control Screen or the Tuning Screen.

You can display a maximum of 1,000 operation messages on one screen.

CSV File Output

Operation log data (date, time, contents of operation) can be output in CSV (Comma Separated Value) file format using the following procedure.

- 1, 2, 3... 1. Press the **CSV** Button to display the Export to CSV File Dialog Box.
2. Specify a name for the CSV file, and click the **OK** Button. A CSV file will be created. (By clicking the **Browse** Button, the CSV file can be created in a desired folder. The default filename is Ctrllog.csv.) The contents of CSV files created are as follows.

“Operation Log”(carriage return)
 <Screen_name>(carriage return)
 <Date_exported>(comma)<Time_exported>(carriage return)
 <Date_of_operation>(comma)<Time_of_operation>(comma)<Contents_of_operation>(carriage return)

Note “Contents of operation” refers to all the data in one line of an Operation Log Screen.

Example: The following screen shows how operation log data exported to spreadsheet software (e.g., Microsoft Excel) will be displayed.

	A	B	C	D	E	F	G	H	I	J	K
1	Operation Log										
2	Control Mess 01										
3	4/21/00	21:59:09									
4	4/21/00	21:58:10	2000. 4.21	21:58:10	3-ONOFF	3-pos	ONOFF	A/M_SW	1	0 %	
5	4/21/00	21:58:10	2000. 4.21	21:58:10	3-ONOFF	3-pos	ONOFF	R/L_SW	0	0 %	
6	4/21/00	21:58:09	2000. 4.21	21:58:09	2-ONOFF	2-pos	ONOFF	A/M_SW	1	0 %	

Date exported

Date of operation Time of operation

Contents of operation log
(All the data in one line of an Operation Log Screen)

3-14 System Monitor Screens

3-14-1 System Monitor Screen Outline

System Monitor Screen display the system status, and runs/stops the Loop Control Unit. To display the System Monitor Screen, click the **System Monitor** Button.

You can display and operate the following items.

Display/operation	Item
Display	All system allocations
	All CPU Unit modes
	All Loop Control Unit statuses (run/stop)
	Block errors (Execution errors, RAM checksum errors, battery errors)
	Type of connection to computer (CLK, Ethernet, serial), and connection status (OK, error)
	Controller Link’s data link status (only with Controller Link connection)
Operation	Loop Control Unit run/stop

Note The system status display on the System Monitor Screen depends on the settings made in the System Monitor Setting Window (using the **System Monitor Builder** Button in the Setup Dialog Box).

Select a number to display the run/stop command for the relevant Loop Control Unit. Refer to 3-14-2 Loop Control Unit Run/Stop later in this manual for operation details.

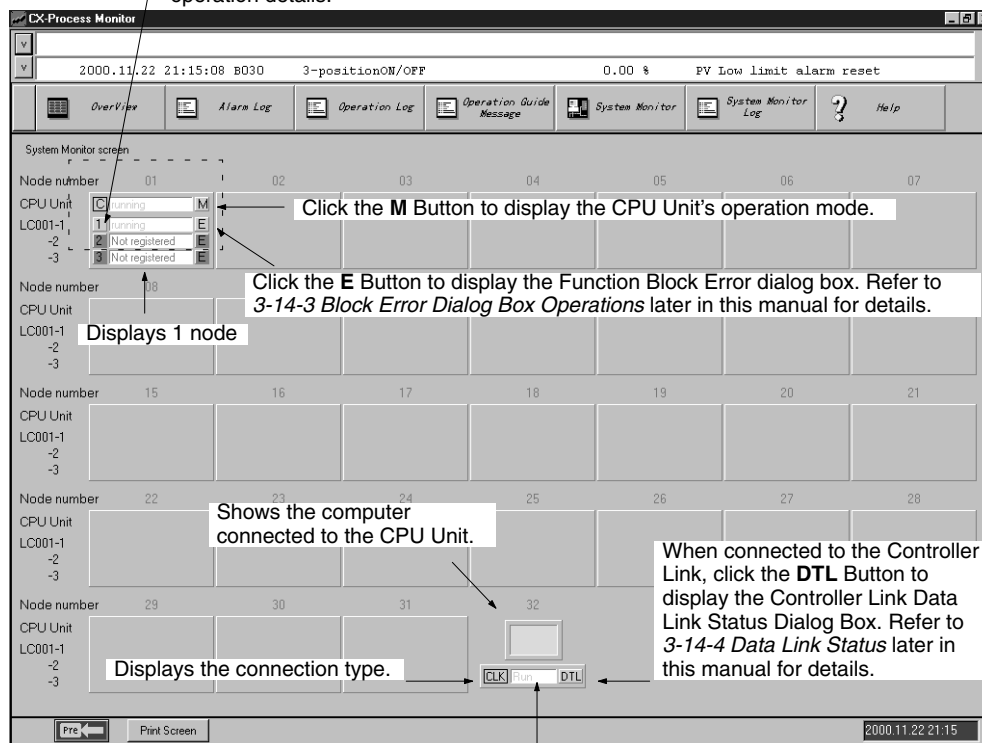

Displays the connection status

3-14-2 Loop Control Unit Run/Stop

! WARNING Before starting a Loop Control Unit, check the following points.

- Make sure that I/O Units used in combination are correctly mounted. Also, make sure that the Unit number on the front of analog I/O Units agree with the Unit number set using the field terminals. If the Unit numbers do not agree, I/O (i.e., read and write) will be performed incorrectly, with data for another Special I/O Unit (with the Unit number set using the field terminal).
- Make sure that the initial settings for System Common Block within the Loop Control Unit are correct. In particular, check that data memory (DM) for node terminals within the CPU Unit used by the Loop Control Unit is not allocated to other applications in the PLC as well. If the same DM has been allocated twice, there is a risk that the PLC system will misoperate, resulting in injury.
- When writing data to the I/O memory in the CPU Unit with function blocks (e.g., using Send All Blocks, Expanded DO/AO Terminal to CPU Unit, or DO/AO Terminal to CPU Unit), be sure that the words written to in the I/O memory are not being used for any other purpose. If I/O memory words are allocated to more than one purpose, the PLC system may act unexpectedly and cause injury.

Note First sufficiently check system operation using the CX-Process Tool (check the load rate, etc.: Execution, Operation, Monitor Run Status), and sufficiently check operation (Monitor Run Status, Start) for the Function Block data that has been created, and then change to actual operation. In particular, first check that the load rate is 60% or less, and then change to actual operation. (Refer to the *Loop Control Unit Operation Manual* for load rate details.)

- 1, 2, 3... 1. Click the number button for the Loop Control Unit you want to use, as shown.

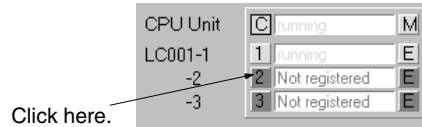

The Run/Stop Command Dialog Box will be displayed as shown.

- Loop Control Unit is stopped.



- Loop Control Unit is running.



2. Select **Stop**, **HOT START**, or **COLD START**, and then click the **Execute** Button.

Click the **Refresh** Button to check and redisplay the run status of the Loop Control Unit.

3-14-3 Function Block Error Dialog Box Operations

- 1, 2, 3... 1. Click the **E** Button.



The Function Block Error Dialog Box will be displayed.

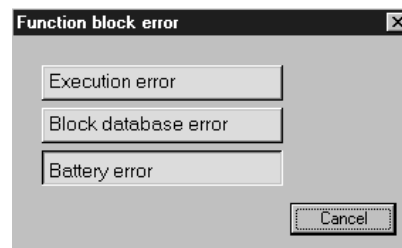

Note A Block database error indicates an error has occurred in the function block database.

The Function Block Error Dialog Box is displayed in green during normal operation, and red if there is an error.

- Click the **Execution Error** or the **Block Database Error** button (Battery Error is displayed only and cannot be selected).

The Details of Function Block Error Dialog Box will be displayed.

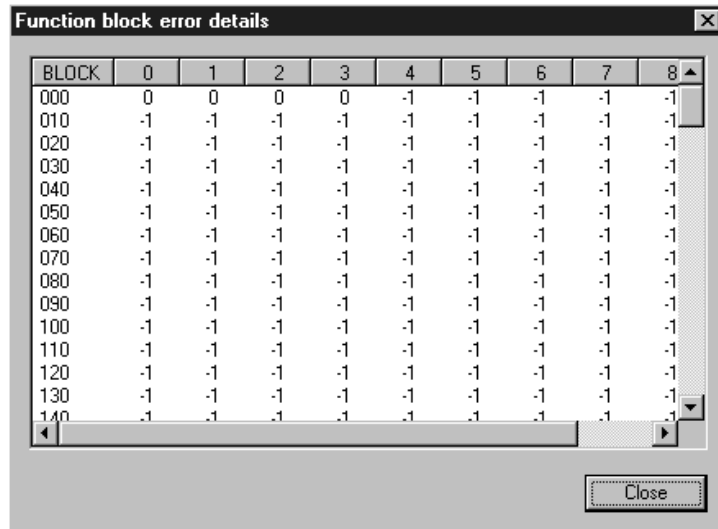

Block Database Error

0 = Normal (no errors), -1 = Block number not in use, 90 = Relevant Function Block has a database error.

Execution Error

0 = Normal (no errors), -1 = Block number not in use, other numbers (1 to 89) = Error code.

The following table gives the function error codes.

Code	Description	Explanation	Operation at Error	Remedy
0	Normal			
1	Connection terminal/output terminal connection not defined	Either the function block is not registered to the block address of the source designation or the destination, or the ITEM number does not exist.	Running of the function block in question is stopped, and the functions in question do not operate normally.	Check the block address and ITEM number of the source designation or destination designation.
2	Default error	When run/stop command S1 turned ON in the ramp program or segment program, the reference input was outside the rise ramp range.	The program is not started.	Check the connection of the reference input and program settings.
3	Variable value error	A constant between A1 and A8 or an intermediate buffer between B1 and B4 that is used in the conditional statement for Arithmetic Operation (Block Model 126) is not defined.	Execution of the Arithmetic Operation block will be stopped.	Set definitions for all constants A1 to A8 and an intermediate buffers B1 to B4 that are used.

Code	Description	Explanation	Operation at Error	Remedy
10	Operation process: Division by "0"	An attempt was made to execute division by a "0" denominator in the operation process.	In the case of Multiplication, DI/AI Terminal from CPU Unit, DI/AI Terminal from Expanded CPU Unit or Field Terminal blocks, the maximum value is output. In the case of the Segment Linearizer or Temperature and Pressure Correction blocks, the previous data is retained.	In the case of DI/AI Terminal from CPU Unit, DI/AI Terminal from Expanded CPU Unit or Field Terminal blocks, check the scaling value, and in the case of the Segment Linearizer block, check the setting value of the input coordinate side. In the case of temperature and pressure correction, check the gain bias value.
		An attempt was made to execute division by a "0" denominator in Arithmetic Operation block (Block Model 126).	Execution of the Arithmetic Operation block will be stopped.	Check the contents of the conditional statement and calculation expressions for division by 0.
11	Operation process: Operation out of restricted value	The output value of the operation result exceeded the data length of two bytes. Note An error does not occur even if the output range (e.g., 320.00) is exceeded if the data length of two bytes is not exceeded.	Output becomes the maximum value or minimum value of the output range. (For example, when the output range is 320.00, the output becomes +320.00 or 320.00.)	If there is a problem, review the settings of related ITEMS.
		The arguments or results for a Arithmetic Operation block exceed the defined limits.	Execution of the Arithmetic Operation block will be stopped.	Check the contents of the conditional statement and calculation expressions and correct the mistake.
12	Argument beyond definition	An argument used in Arithmetic Operation (Block Model 126) is beyond the definition.	Execution of the Arithmetic Operation block will be stopped.	Check the range of the arguments and correct the conditional statement or calculation expressions.
15	AT error	A limit cycle cannot be generated for Basic PID (Block Model 011) or Advanced PID (Block Model 012) or suitable PID constants cannot be calculated.	Execution of the relevant block will be stopped.	Check the following AT parameters: ITEM 036 to ITEM 040. Also, set ITEM 051 to 2 s or less.
19	Inappropriate operation	Two or more S1 to S3 select switches are set to 1 (ON) at the same time in the 3-output Selector block (Block Model 163) or 3-input Selector block (Block Model 164).	The output value that was active before the error occurred is held.	Re-program the Step Ladder Program block so that S1 to S3 select switches are set to 1 (ON) independent of each other.
20	Download terminal data exchange error	Data exchange with the CPU Unit is not being executed correctly on the CPU Unit Terminal, Expanded CPU Unit Terminal, Node Terminals and Field Terminal blocks.	The data of the function block in question is not updated.	If a malfunction has occurred on the CPU Unit, follow the remedy for that error. If the CPU Unit is normal, turn ON the power supply again.

Code	Description	Explanation	Operation at Error	Remedy
21	I/O memory address out-of-range	An address out of the I/O memory address range has been specified on the CPU Unit Terminal, Expanded CPU Unit Terminal, Node Terminals and Field Terminal blocks.	Operation of the function block in question is stopped.	On the CPU Unit Terminal and Expanded CPU Unit Terminal blocks, check the leading address, and on field terminals check the setting of the CIO (channel I/O) Area number setting. In the case of Node Terminals, check the setting of the "leading address of the memory for the node terminals" specified by System Common block ITEM043.
29	Reception error for external device	A communications frame error was generated by the data received from an ES100X Controller for an ES100X Controller Terminal (Block Model 045). (An FCS check error or frame error occurred 3 times in a row.)	Communications will be stopped with the specified ES100X and tried with another ES100X.	Check the communications path and the communications settings (7 data bits, even parity, and 2 stop bits).
30	Response timeout	A response was not returned after sending data to the Controller for a ES100X Controller Terminal (Block Model 045). (Response was not returned for 5 s 3 times.)	Communications will be stopped with the specified ES100X and tried with another ES100X.	Check the communications path, the communications settings (7 data bits, even parity, and 2 stop bits), and other required settings in the ES100X (parameter setting mode, unit number, etc.).
31	Controller unit number duplicated	The unit number set in ITEM 006 for a ES100X Controller Terminal (Block Model 045) is the same as another ES100X Controller Terminal. (A response timeout will occur if the unit number does not exist.)	Communications will be stopped with the ES100X Controllers	Change the unit number settings (ITEM 006) so that each is used only once.
70	Illegal combination of function blocks	The function block on the primary loop side is not basic PID or advanced PID when bumpless processing between primary/secondary loops was specified in basic PID or advanced PID.	Running of the function block in question is stopped.	Check the function block model number on the primary loop side.
71	Inappropriate parameter	a) When restricted conditions are applied across two ITEMS: (example: when the unit pulse output is equal to or greater than the operation cycle when there is unit pulse output in run time accumulation) b) An attempt has been made to write out-of-range data at the ITEM Setting block.3.	a) The function block in question is not executed. b) Data cannot be written.	Check the settings of the ITEMS.

Code	Description	Explanation	Operation at Error	Remedy
80	Step Ladder Program command error	There is an irrelevant command in the Step Ladder Program, or the method of use of commands is wrong, for example, there is an AND command even though there is no input command.	The command in question and onwards are not executed.	Check the program within the Step Ladder Program block.
81	Step Ladder Program source designation not defined	Either the function block is not registered to the block address currently specified by each command in the Step Ladder Program, or the ITEM number does not exist.	The command in question and onwards are not executed.	Check the block address and ITEM number.
89	Overuse of Step Ladder Program differentiated instruction	The number of differentiated instructions to be simultaneously executed has exceeded 256.	Differentiated instructions exceeding 256 instructions are not executed.	Reduce the number of differentiated instructions to be executed simultaneously.

3-14-4 Data Link Status

If using a Controller Link connection, you can display the Controller Link Network's data link status.

Click the **DTL** Button.

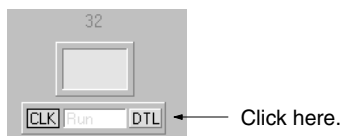

The Data Link Status Dialog Box will be displayed.

Displays data link participation status. (See note 2.) (1 bit per node.)

Displays the data link status. (See note 1.) (8-bit 2-digit hexadecimal per node.)

Note 1. Data link status: The data link status is displayed for each node using the following 8 bits (2-digit hexadecimal).

Bit		Contents
Odd node addresses	Even node addresses	
0	8	PLC status (0: Inactive, 1: Active)
1	9	PLC's CPU Unit error (0: Normal, 1: Error)
2	10	Communications error (data link reception) (0: Normal, 1: Error)
3	11	Data link participation (0: Not in data link or data link inactive, 1: In data link)
4	12	Offset error (0: Normal, 1: Error)
5	13	Insufficient (short) receive area (0: Sufficient, 1: Insufficient)
6	14	Remaining receive area (0: Not remaining, 1: Remaining)
7	15	Set to 0

The relationship between nodes and words displayed on the screen is as follows:

Word	0		1		2		3		4	
000	Node 2	Node 1	Node 4	Node 3	Node 6	Node 5	Node 8	Node 7	Node 10	Node 9
005	Node 12	Node 11	Node 14	Node 13	Node 16	Node 15	Node 18	Node 17	Node 20	Node 19
010	Node 22	Node 21	Node 24	Node 23	Node 26	Node 25	Node 28	Node 27	Node 30	Node 29
015	Node 32	Node 31	Data link participation status (nodes 1 to 16)		Data link participation status (nodes 17 to 32)		Set to 00	Set to 00	Set to 00	Set to 00

2. Data Link Participation Status

Network participation status (0: Not part of the network, 1: Part of the network)

The relationship between nodes and each bit in a word on the screen is as follows:

Word	Bit															
	15	14	13	12	11	10	9	8	7	6	5	4	3	2	1	0
016	16	15	14	13	12	11	10	9	8	7	6	5	4	3	2	1
017	32	31	30	29	28	27	26	25	24	23	22	21	20	19	18	17

Refer to the Controller Link Unit or Board manuals for details of data link status.

3-15 System Monitor Log Screens

System Monitor Log Screens record and display run/stop logs and the execution error logs as soon as they occur. To display the System Monitor Log Screen, click the **System Monitor Log Button**.

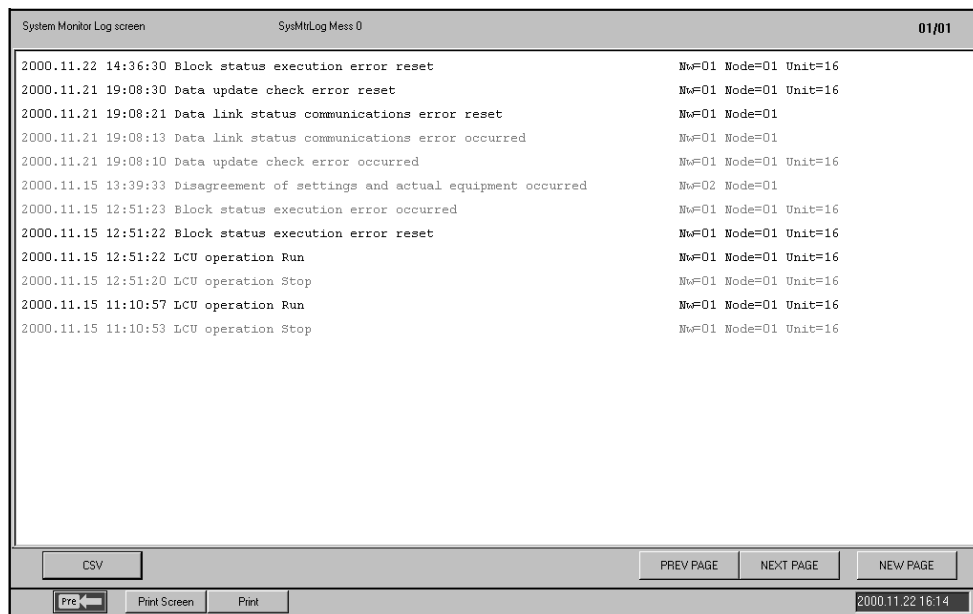

Display is red for an occurrence, and black following recovery.

CSV File Output

System monitor log data (date, time, contents of runs/stops and execution errors) can be output in CSV (Comma Separated Value) file format using the following procedure.

- 1, 2, 3...** 1. Press the **CSV** Button to display the Export to CSV File Dialog Box.
2. Specify a name for the CSV file, and click the **OK** Button. A CSV file will be created. (By clicking the **Browse** Button, the CSV file can be created in a desired folder. The default filename is Sysmlog.csv.) The contents of CSV files created are as follows.

"System Monitor Log"(carriage return)
 <Date_exported>(comma)<Time_exported>(carriage return)
 <Date>(comma)<Time>(comma)<Contents_of_system_monitor_log>(carriage return)

Note "Contents of system monitor log" refers to all the data in one line of a System Monitor Log Screen.

SECTION 4

Configuration Screens

This section describes operating procedures to create screens and monitor using the CX-Process Monitor.

4-1	Before Configuring	80
4-2	Basic Configuration Procedure	82
4-3	Basic Configuration Operations	83
4-3-1	Starting and Stopping	83
4-3-2	Mode Selection Dialog Box	83
4-3-3	Password	84
4-3-4	Setup Dialog Box	85
4-4	System Monitor Settings	86
4-5	Creating Graphic Screens	89
4-5-1	Outline	89
4-5-2	Graphic Screen Creation Window Operations	90
4-5-3	Basic Operations	94
4-5-4	Graphic Objects	94
4-5-5	Creation Example	95
4-6	Screen Configuration	99
4-6-1	CRT Builder Functions	99
4-6-2	Overview of Screen Registration	100
4-6-3	Registering Operation Guide Messages	112
4-6-4	Registering Alarm Messages	114
4-6-5	Saving Settings	116
4-6-6	Deleting Registered Screens	116
4-6-7	Starting the Monitor Process	117
4-7	System Information Settings	117
4-7-1	Setting for Stopping Alarm Sound	128
4-8	Checking Configurations	131
4-8-1	Starting the Monitor Process	132
4-8-2	Executing File Mapping and Starting the Monitor Process	132
4-8-3	Displaying the Overview Screen	134
4-8-4	Setting the Auto-start Function	134
4-8-5	Ending the Monitor Process	134

4-1 Before Configuring

To send tag data to the CX-Process Monitor, you must first perform the following three operations using CX-Process Tool.

Register Function Blocks for Data Exchange

Note The function blocks include the Send to Computer Block (401 to 404), Send Terminal to All Nodes Block (407 and 408), and DO/AO Terminal Settings from Computer (409 and 410).

Example: Register the 1-Block Send Terminal to Computer Function Block, and specify block address 001 as the send source.

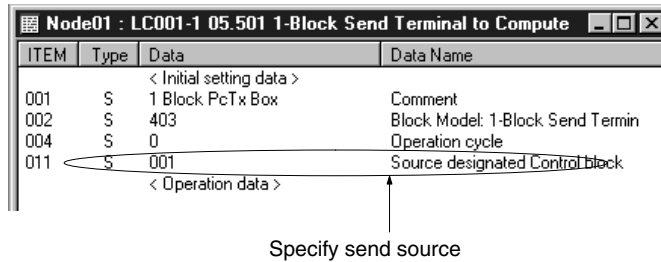

Set the Tag Names

Enter the tag names. The CX-Process Monitor differentiates data using tag names.

Example: 1-Block Send Terminal to Computer/4-Block Send Terminal to Computer (403 and 404)

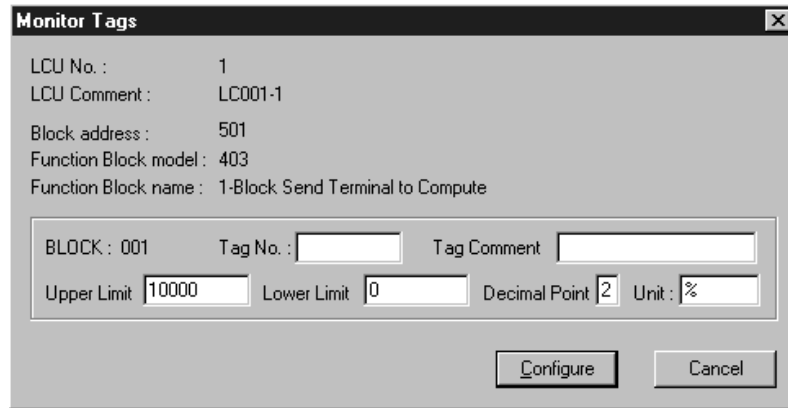

Item	Max. No. of characters	Forbidden characters
Tag Name	8 standard characters	None
Tag comment	16 standard characters	None

Note Make sure to set the range high limit (RH) and range low limit (RL) to indicate the the CX-Process Monitor scaling within the following range.

No. of digits	5 digits max. (Including symbols and digits below the decimal point.)
Value range	-5000 to 99999 Example: With one digit below the decimal point: -550.0 to 9999.9

Compiling Monitor Tags

Compile monitor tags for CX-Process Monitor using the following operation. This operation is possible only when CX-Process Monitor is installed.

- 1, 2, 3... 1. From the Execution Menu, select **Output Tag Files - Monitor Tags**. The Compile Monitor Tags Dialog Box, shown below, will be displayed.

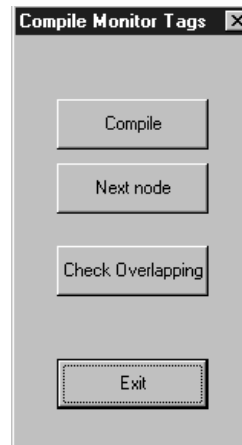

2. Click the **Compile** Button. The Compiler Dialog Box, shown below, will be displayed.

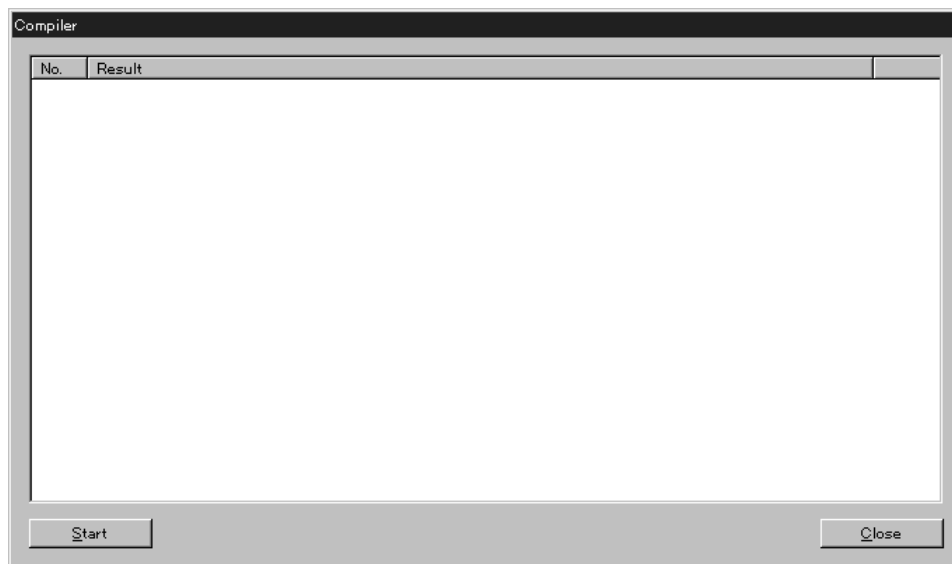

3. Click the **Start** Button.

When compilation is complete, the following screen will be displayed.

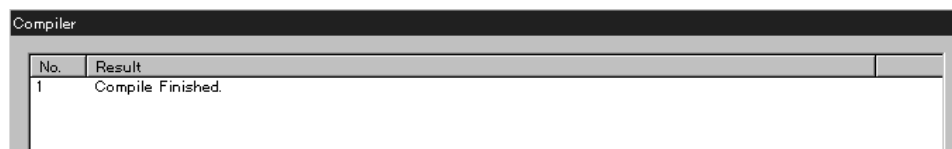

Note The Monitor Tag file (i.e., Monitor Tag data for one CPU Unit) is compiled automatically with a fixed file name in the following directory, using the compile operation.

Directory: Omron/CX-Process Monitor/db (The underlined part is the directory in which the CX-Process Monitor is installed.)

File names: mtagmst and mtagsubmst

4-2 Basic Configuration Procedure

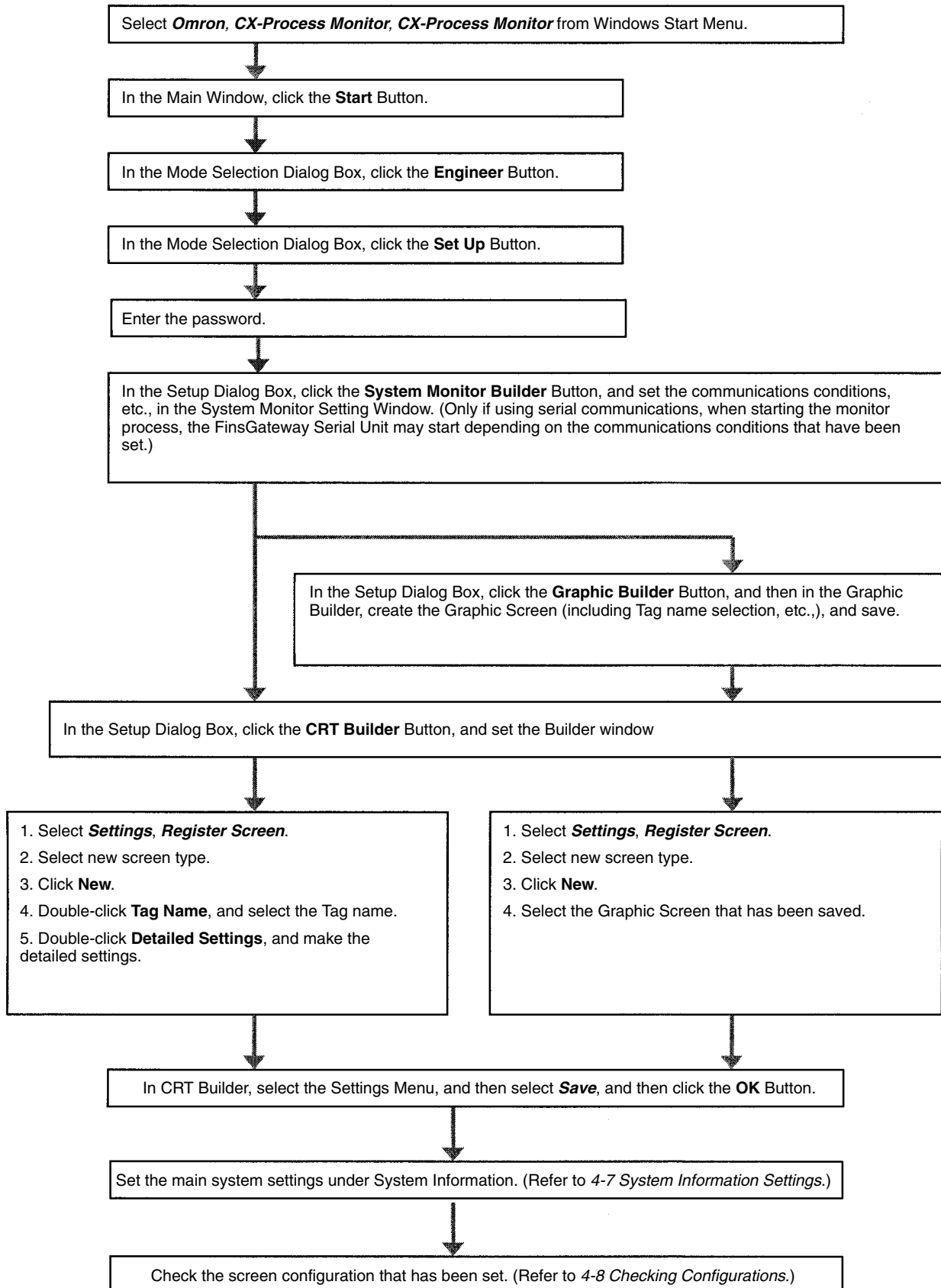

4-3 Basic Configuration Operations

4-3-1 Starting and Stopping

Starting

- 1, 2, 3... 1. Select **Programs, Omron, CX-Process Monitor, and CX-Process Monitor** from the Windows Start Menu.

The CX-Process Monitor Main Window will be displayed.



2. Click the **Start** Button. The Mode Selection Dialog Box will be displayed as shown below.
3. Select the function.

Stopping

In the Main Window, click the **Exit** Button.

The Main Window will close, and CX-Process Monitor will stop running.

4-3-2 Mode Selection Dialog Box

This section explains the functions of the Mode Selection Dialog Box.

- 1, 2, 3... 1. In the Main window, click the **Start** Button.

The Mode Selection Dialog Box will be displayed.

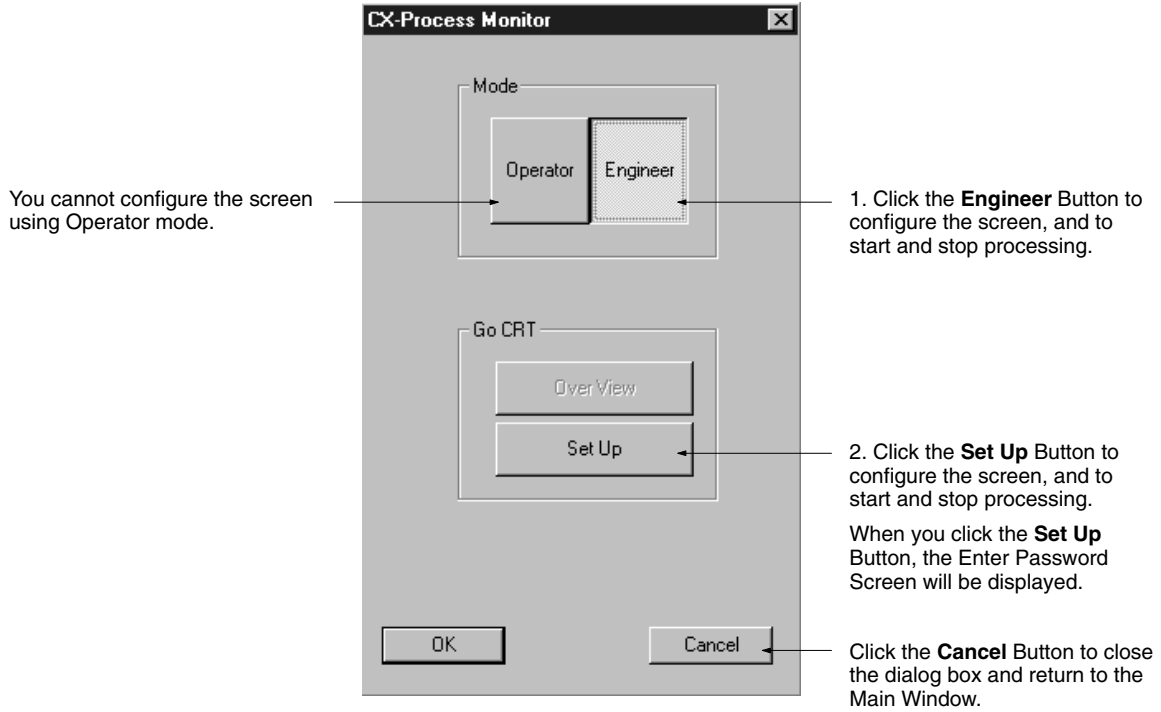

Note If you did not set a password the first time you started CX-Process Monitor, when you click the **Set Up** Button, the password registration screen will be displayed. Register a password, and unless the correct password is entered thereafter, you cannot configure the screen or make any settings. Make sure that people who make settings register a password.

2. To set the CX-Process Monitor (i.e., to configure the screens, edit the Graphic Screen, and run/stop processing, etc.), first click the **Engineer** Button (which is the default), and then click the **Set Up** Button. The input password box will be displayed.

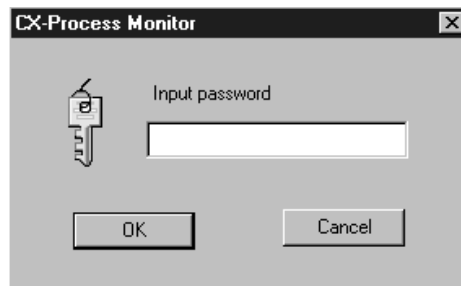

3. Enter the password, and click the **OK** Button. The Setup Dialog Box will be displayed.

4-3-3 Password

Set the password to configure the CX-Process Monitor Screen and to protect the settings you have made.

Note Register a password, and unless the correct password is entered thereafter, you cannot change to Engineer mode to make any settings (i.e., use the **Set Up** Button in the Mode Selection Dialog Box).

- 1, 2, 3... 1. If you do not set a password, when you click the **Set Up** Button in the Mode Selection Dialog Box, the following dialog box will be displayed.



2. Click the **OK** Button.
The following dialog box will be displayed.

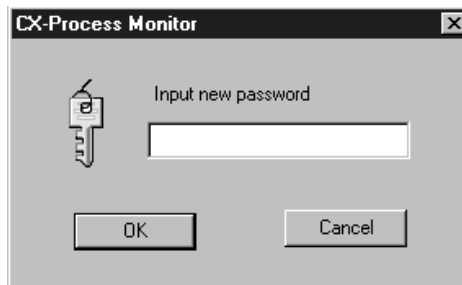

3. Enter the password, and click the **OK** Button.
The following dialog box will be displayed.

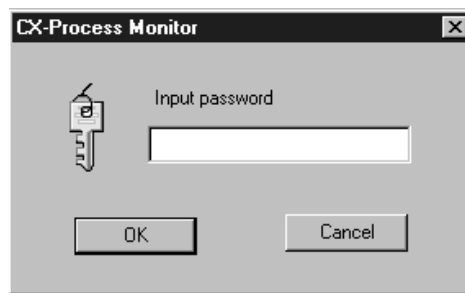

4. Enter the password once again, and click the **OK** Button.

Note If you have forgotten the password or want to change the password, perform the following operation using the Registry Editor, and after deleting the PassWord key, set the password once again using the above procedure.

- 1, 2, 3... 1. Select **Start**, then select **Run**, enter *regedt32*, and then click the **OK** Button.



The Registry Editor will start.

2. On the local machine, select **HKEY_LOCAL_MACHINE, SOFTWARE, OMRON, CX-Process Monitor, 2.00**, and then delete the password.

4-3-4 Setup Dialog Box

This section explains the functions of the Setup Dialog Box.

- 1, 2, 3... 1. In the Mode Selection Dialog Box, click the **Set Up** Button. The input password box will be displayed. If you have not set a password, you cannot

change to Engineer mode. Refer to 4-3-3 Password Settings above for how to set the password.

2. Enter the password, and click the **OK** Button.
The Setup Dialog Box will be displayed.
3. Click any button, and then select a function.

Setup Dialog Box

Sets auto-start, tuning trend scale display, multi-screen, label information, alarm sound information, and ten-key. Refer to 4-7 System Information Settings for details.

1. Sets the System Monitor Screen. Refer to 4-4 System Monitor Settings for details.

2. Opens the Graphic Screen Create Window. Refer to 4-5 Graphic Screen Creation for details.

3. Configures the screen. Refer to 4-6 Screen Configuration for details.

Refer to the following sections for details on the functions of each button.

4-4 System Monitor Settings

Using the System Monitor Setting Window, register the PLC and Loop Control Unit to be monitored using the System Monitor Screen. Also register the local computer to perform the monitoring.

The setting items are as follows:

PLC setting	PLC node number (address)	Use the System Monitor Screen for this setting.
	Loop Control Unit address	
Computer setting	Computer node number (default is 32)	
	Communications type (CLK, Serial, Ethernet) (Use the System Monitor Screen to set CLK or Ethernet communications.)	
	For serial connections, you must also set the COM port and baud rate.	

With serial (Host Link) communications only, when you start the Monitor Process (i.e., select **Start Up** in the Setup Dialog Box), FinsGateway communications will start according to the communications conditions given below that have been set.

- Communications type: Serial (Host Link)
- COM port used and baud rate

Note The PLC settings (node address, Unit address, etc.) set here can be used only from the System Monitor Screen. Actual communications processing depends on the network address, node address, and Unit address set using the CX-Process Tool. Controller Link and Ethernet settings within the computer settings made here can also be used only from the System Monitor Screen. Perform actual communications processing by manually starting FinsGateway.

Note Set the PLC settings (node address, Unit address, etc.) made here to agree with the network address, node address, and Unit address settings made using CX-Process Tool. If the settings do not agree, monitoring using the System Monitor Screen will not be performed correctly.

- 1, 2, 3... 1. In the Setup Dialog Box, click the **System Monitor Builder** Button.

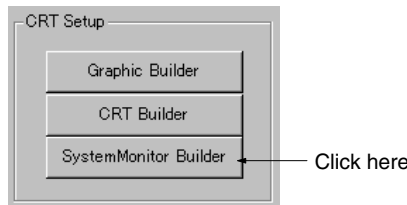

The System Monitor Setting Window will be displayed.

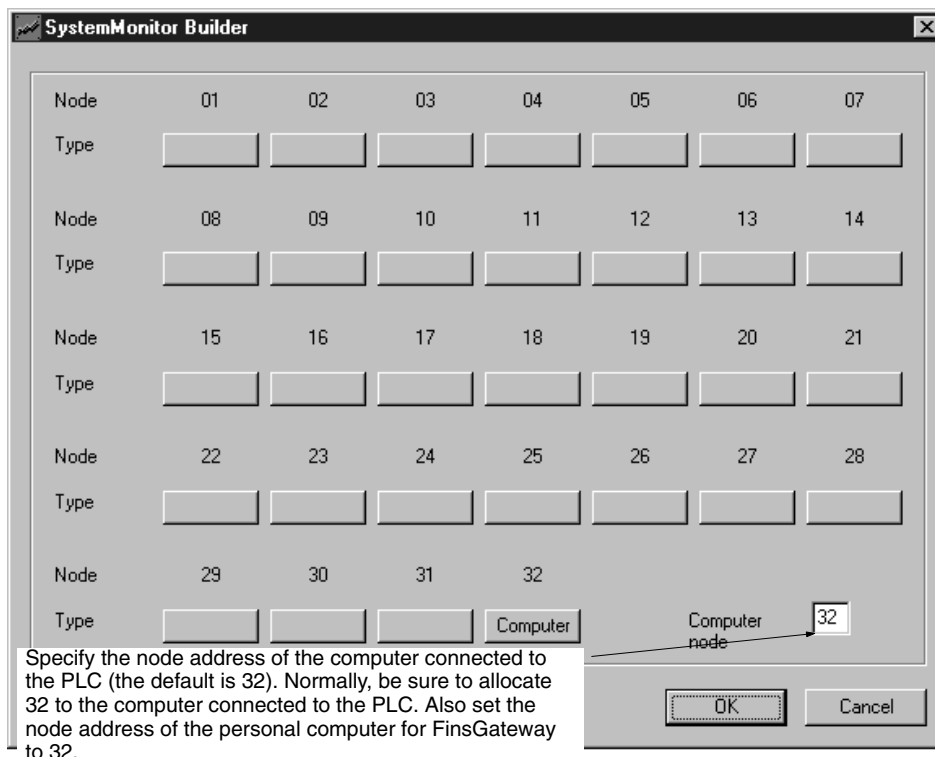

2. Select the node address allocated to the PLC or computer. Select the button displayed beneath the node address. Normally, the computer is node 32. The System Monitor Builder Dialog Box will be displayed.

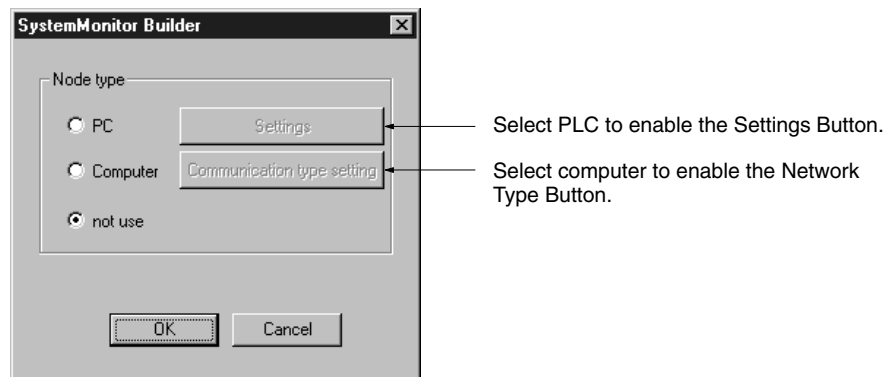

3. Select the device (PLC or computer), and then make the appropriate settings.

PLC Settings

In Node Type, select **PC** to enable the **Settings** Button.
Click the **Settings** Button. The following dialog box will be displayed.

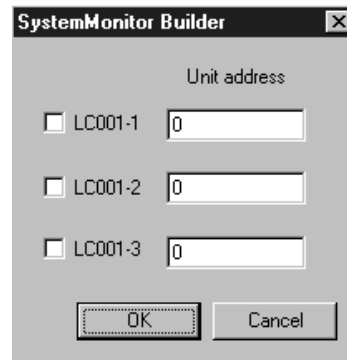

Note When mounting multiple Loop Control Units to a single PLC, register the Units in ascending order of unit addresses and LCU numbers.

You can connect up to three Loop Control Units to one PLC. Select the check box for the Loop Control Unit mounted to the PLC, and enter the unit address.

Click the **OK** Button to return to the Set Node Dialog Box.

Note The unit address value for each node Unit (address) set here can be used only from the System Monitor Screen. Which Loop Control Unit's data and which PLC CX-Process Monitor will access depends on the network address, node address, and unit address set using CX-Process Tool. (This is linked to the Tag information.)

Computer

In Node Type, select Computer to enable the Network Type Button.
Click the **Communication type setting** Button. The following dialog box will appear.

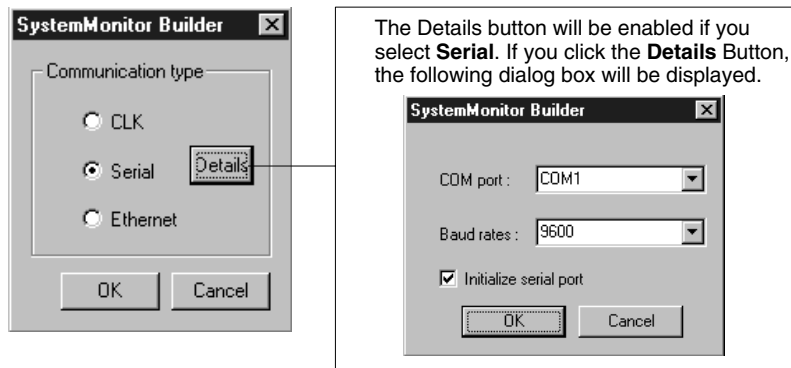

In Network Type, select **CLK**, **Serial**, or **Ethernet**.

If you select **Serial**, set the computer COM port, and the baud rate. If necessary, also set **Initialize serial port**. Refer to the following Note.

Click the **OK** Button to return to the Set Node Dialog Box.

Note a) If you set the communications type to Serial (Host Link), when you start the monitor process (i.e., select **Start Up** in the Setup Dialog Box), FinsGateway Serial Unit driver will start according to the communications conditions set here. If you have not selected **Initialize serial port**, however, the FinsGateway Serial Unit driver will not start automatically.

If you select another communications type (Controller Link or Ethernet), the communications type set here can be used only from the System Monitor Screen. You must start the FinsGateway manually.

- b) When using Controller Link as the communications network, you must create Controller Link data link tables, and register to each node (refer to *Appendix B FinsGateway Settings when Connected Using Controller Link*). Use Ethernet as the communications type if not creating data link tables.
4. When you have finished making all the PLC and computer settings, click the **OK** Button in the System Monitor Settings Window. This completes the System Monitor settings.

4-5 Creating Graphic Screens

4-5-1 Outline

The Graphic Screen displays schematically the device status.

Create the Graphic Screen using the Graphic Builder.

- Paste to the screen graphics representing plant instrumentation, which have been pre-prepared, and use them to display the device status, to a maximum of 200 screens.
- Pre-prepared fixed graphics: Text, instruments, thermometers, transmitters, orifices.
- Pre-prepared changeable graphics:
 - Analog inputs: Bar graph displays, numerical value displays, tanks
 - Analog settings: Numerical settings (See note.)
 - Contact inputs (display): Pumps, valves, pipes
 - Contact settings (operation): Switches (See note.)

Note If setting analog values or contact settings, use AO Settings from Computer or DO Settings from Computer Tags.

- For other fixed graphics, read and paste graphics created using bitmap files. Basically, after cutting and pasting the background and other graphics, paste the pre-prepared fixed or changeable graphic display elements mentioned above to create the complete Graphic Screen.

Element	Function block name (model)	Function block or ITEM set as send source
Function block	1-Block Send Terminal to Computer (403)	Control Block: Tag ITEMS for Basic PID (011), Advanced PID (012), Batch flowrate capture (014), Indication and Setting (031), Indication and Operation (032), Ratio Setting (033), Indicator (034), blended PID (013), 2-position ON/OFF (001), 3-position ON/OFF (002)
	4-Block Send Terminal to Computer (404)	Control Block: Basic PID (011), Advanced PID (012), Indication and Setting (031), Indication and Operation (032), Ratio Setting (033), Indicator (034), 2-position ON/OFF (001), 3-position ON/OFF (002) Operation Block: High/Low Alarm (111), Segment Program 2(157), ON/OFF Valve Manipulator (221), Motor Manipulator (222), Reversible Motor Manipulator (223), Motor Opening Manipulator (224), Timer (205), Counter (208)
	AO to Computer (402), AO Terminal to all nodes (408)	Analog input signals or analog output signals for all Function Blocks, or analog value parameters
	DO to Computer (401), DO Terminal to all nodes (407)	Contact input signals or contact output signals for all Function Blocks, or contact value parameters
	AO Terminal Settings from Computer (410)	Analog output ITEM for AO Terminal Settings from Computer (Used to set ordinary analog values. Displays using network resend monitoring.)
	DO Terminal Settings from Computer (409)	Contact output ITEM for DO Terminal Settings from Computer (Used to set ordinary contact values. Displays using network resend monitoring.)
Display		Analog values: Bar graphs, numerical values, tank level Contacts: Indicators, pumps, valves, pipes
Setting		Analog values: Numerical values (using AO Terminal Settings from Computer) Contacts: Switches (using DO Terminal Settings from Computer)

Note If the WS02-LCTK1-EL01 License Key is not connected to the computer printer port, or even if it is connected, if the License key driver is not installed, you cannot use the Graphic Builder. (If you try to click the **Graphic Builder** Button and change to the Graphic Builder, an error message will be displayed.)

4-5-2 Graphic Screen Creation Window Operations

Starting

In the Setup Dialog Box, click the **Graphic Builder** Button.

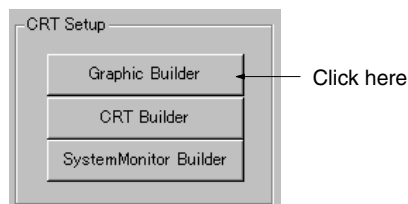

The Graphic Builder will be displayed.

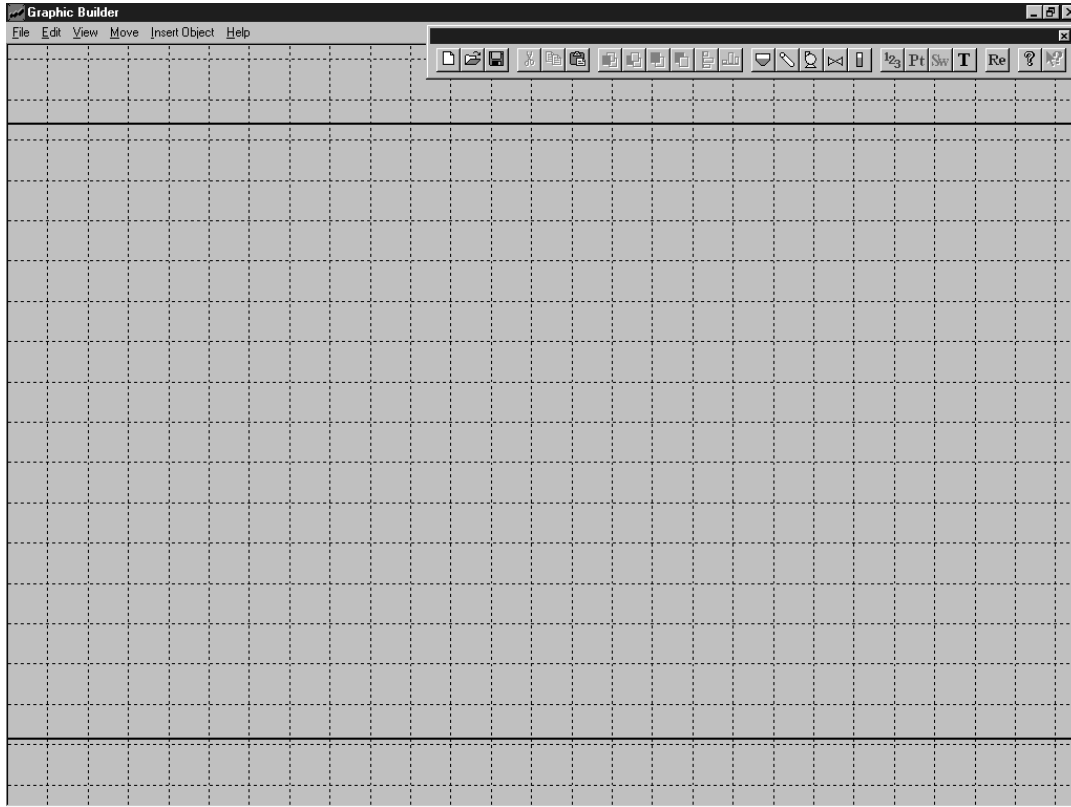

Stopping

In the File menu, click **Exit**.

The Graphic Builder will close.

- Note**
1. When using the Graphic Screen, first create and save the graphics using Graphic Builder (using the **CRT Builder** Button in the Setup Dialog Box), and then register the saved graphics in the Overview Screen in the format you have selected. Consequently, before registering the graphics in the Overview screen, you must create and save the graphics using the Graphic Builder.
 2. If you have not saved the edited data when you click **Exit**, a window recommending that you save the data will be displayed. Save all necessary data. After performing this operation, the Graphic Builder will close.
 3. You must configure the screen to display the Graphics Screen you have created using CX-Process Monitor. Refer to *Graphic Screen Registration in 4-6 Screen Configuration* for how to make the settings.

Menu Command

This shows the commands available in the Graphics Builder.

Menu	Command	Shortcut key	Function
File	New	Ctrl + N	Create new Graphic Screen
	Open	Ctrl + O	Close created Graphic Screen
	Save	Ctrl + S	Overwrite project being edited
	Save As	---	Save project being edited with a new name
	Delete File Information	---	Specify name of a registered Graphic Screen, and delete that file information
	Modify File Information	---	Specify name of a registered Graphic Screen, and change the file information for it
	Recent Files	---	Display the most recent files
	Exit	---	Close Graphic Builder

Menu	Command	Shortcut key	Function
Edit	Undo	Ctrl + Z	Undo the previous operation
	Cut	Ctrl + X	Cut the specified range
	Copy	Ctrl + C	Copy the specified range
	Paste	Ctrl + V	Paste the contents of the clipboard
	Delete	Del	Delete the specified range
	Select All	Ctrl + A	Select all items
	Create/Paste Objects	---	Display the Insert Objects dialog box Select and create objects from the menu of objects supported by CX-Process Monitor and objects that can be inserted into the Graphic Screen. Specify and paste file names
	Links	---	
	Object	---	Open the selected object
View	Toolbars	---	Select whether to display or hide toolbars
	Paper Color: Basic Color/System Color	---	Set the background color Basic color: Set the background color System color: Restore the default background color
	Display Frame	---	Select whether to display or hide object frame
	Grid line	---	Set the grid lines 20 point, 40 point, 60 point, none You can also change the line color
	Refresh	---	Refresh the screen
Move	To Front	+	Move the selected object to the front
	To Back	-	Move the selected object to the back
	To Top	Ctrl + +	Move the selected object to the top
	To Bottom	Ctrl + -	Move the selected object to the bottom
	Align: Vertical/Horizontal	---	Vertical: Align vertically multiple selected objects Horizontal: Align horizontally multiple selected objects
Insert Object	Tank	---	Insert a tank
	Pipe	---	Insert a pipe
	Pump	---	Insert a pump
	Valve	---	Insert a valve
	Meter bar	---	Insert a meter bar
	Parts	---	Insert parts (instrument, thermometer, transmitter, or orifice)
	Switch	---	Insert a switch
	Numerical Data Box	---	Insert a data box
	Text Box	---	Insert a text box
Help	Help Topics	---	Display the Help Topics dialog box
	About Graphic Builder	---	Display the Graphics Builder version information

Graphics Builder Toolbar

To display or hide the toolbar, select **View, Toolbars**.

The following functions are displayed on the Graphic Builder toolbar.













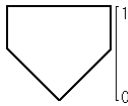

Icon	Function
	New
	Open
	Save
	Cut
	Copy
	Paste
	To Top
	To Bottom
	To Front
	To Back
	Align multiple objects vertically
	Align multiple objects horizontally
	Insert a tank
	Insert a pipe
	Insert a pump
	Insert a valve
	Insert a meter bar
	Insert a numerical data box
	Insert parts (instrument, thermometer, transmitter, or orifice)
	Insert a switch
	Insert a text box
	Refresh the screen
	About Graphic Builder

4-5-3 Basic Operations

The following table displays the basic Graphic Builder operations (operations other than those displayed on the menu and toolbars).

Objective	Operation
Select object	Double-click
Select multiple objects	Drag to surround the multiple objects
Cancel selection	Click an area outside of the selected object
Move object	Select the object, and then drag it
Enlarge/reduce object	Select the object, and then drag one of the 8 points displaying the outline of the object
Set object properties (shape, color, font, etc.)	Right-click the object, select Grf*** Control Object, Properties , and then select the tab for the item you want to set.

4-5-4 Graphic Objects

Elements	Object name	Shape (typical)	Display/setting function	General properties	
Changeable objects	Tank		Displays analog value	Number of divisions, High limit, Low limit, type (Tank 1 to Tank 3), Tag data	
	Pipe		Displays contact	Display Frame, top line, bottom line, right line, left line, color, Tag data	
	Pump		Displays contact	Direction (Up, Down, Right, Left), color, Tag data	
	Valve		Displays contact	Type (horizontal/vertical), Up square/Right square/Left square/Up semicircle/Right semicircle/Left semicircle, Tag data	
	Meter bar		Displays analog value	Number of divisions, High limit, Low limit, direction (vertical/horizontal), Tag data	
	Numerical Data Box		Displays analog value (displays numerical value), and analog value setting (numerical value setting)	Type (3D display, display frame 0 to 4, flat display), Tag data, display data/input data	
	Switch		Displays contact (indicator), and contact setting (switch)	ON text string, ON START/ON STOP, OFF text string, OFF START/OFF STOP, ON color, OFF color, type (DI/DO), Tag data, operation confirmation (Y/N)	
Fixed objects	Text box		---	Text, Type (3D display/display frame 0 to 4/flat display)	
	Parts	Transmitter		---	Direction (up/down/right/left)
		Orifice			
		Instrument			
		Temperature meter			

4-5-5 Creation Example

This section explains how to create a Graphic Screen, using the following example.

Creating a Graphic Screen

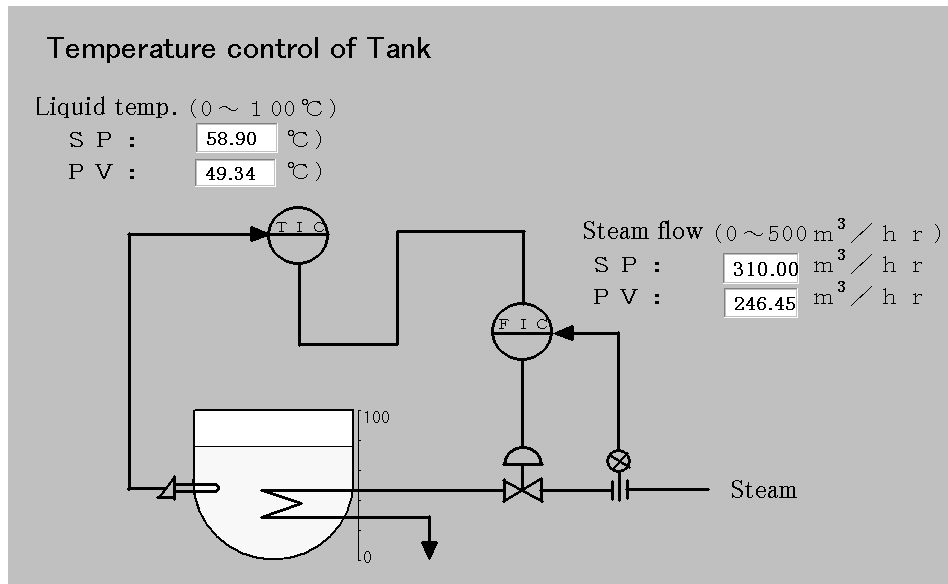

Operation Procedure

- 1, 2, 3... 1. Create fixed graphics and text (in this example, all graphics except for SP and PV data boxes, and tanks) using commercially-available graphic software.
2. Copy the graphics created in Step 1. using the graphics software, and then in Graphic Builder select **Edit**, and then select **Paste** (Ctrl + V) to paste the graphic, or in Graphic Builder, select **Edit**, and then select **Create/Paste Objects**, and then specify and insert the graphic file you have created.

The following diagram will be displayed.

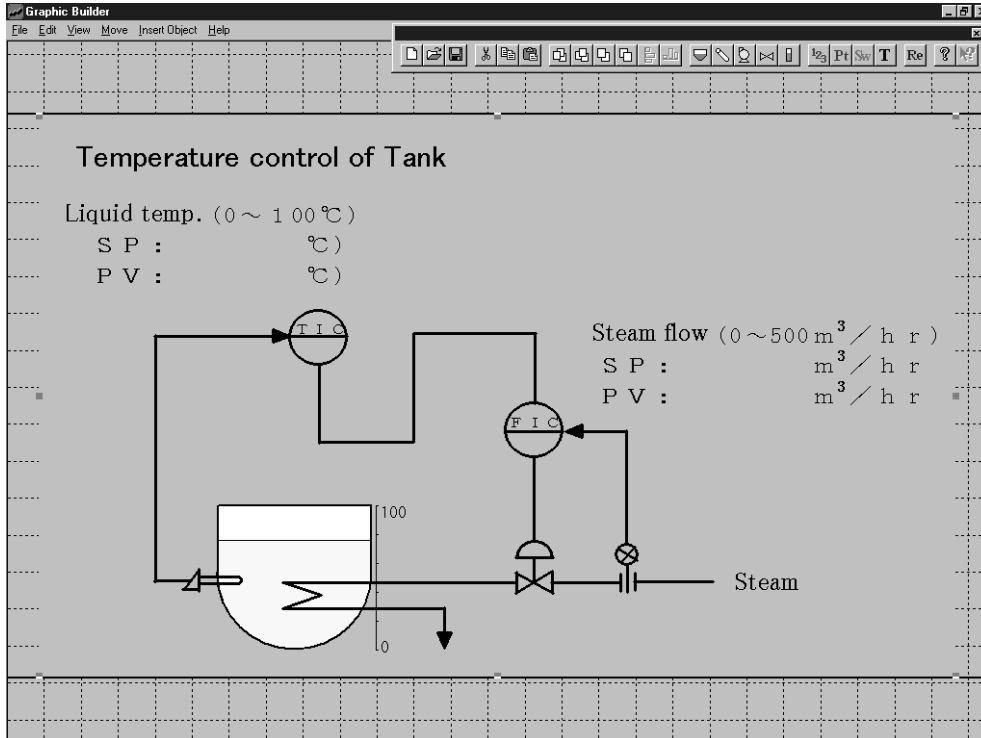

To enlarge or reduce the image, drag any of the eight points that display the image frame.

3. First, insert the data box for the liquid temperature's SP, and then set the properties.

Select **Insert Object**, and then **Data** (or click the **Data Box** icon). A data box will be displayed in the upper right of the window, as shown below.

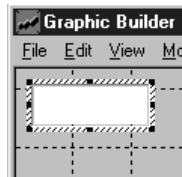

Click an area where nothing is displayed, next double-click the data box to select it, and then drag the data box to the SP display position.

Correct the size by enlarging or reducing the object size.

Right-click the data box, and then from the menu that is displayed select **GrfData Control Object**, and then **Properties**. The GrfData Control Properties Dialog Box will be displayed.

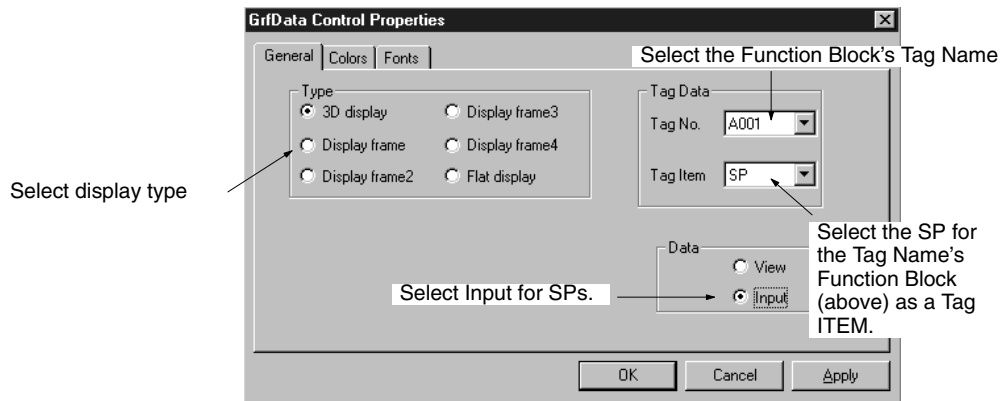

Note If you select Input for data, to enable settings using the ten-key, in the Setup Dialog Box, select **System Info.**, and then set the ten-key setting to Use Ten-Key.

Click the **OK** Button.

4. Insert the data box for the liquid temperature's PV, and then set the properties.

Insert and position the data box by performing the operation in Step 3., and then right-click and select **GrfData Control Object**, the **Properties**. The GrfData Control Properties dialog box will be displayed.

Make the following settings.

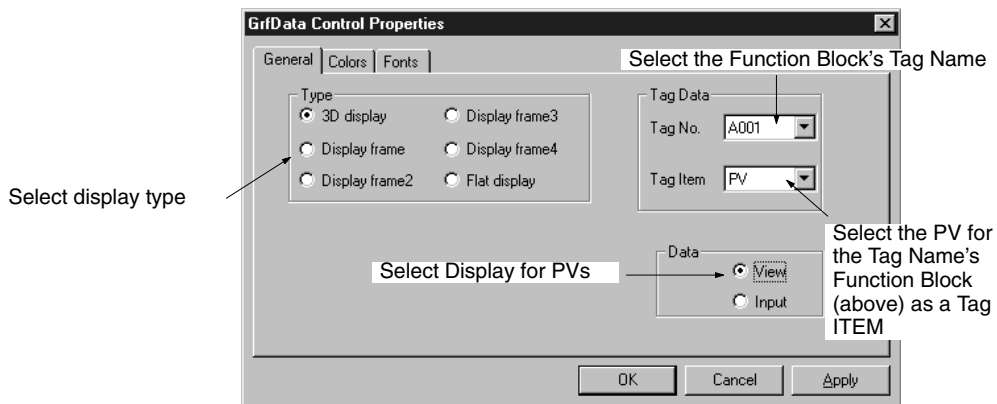

Set Colors and Fonts as necessary.

Click the **OK** Button.

5. Repeat Step 3. and Step 4. to insert and set the properties for the steam flowrate's SP and PV.
6. Insert and set the properties for the tank.

Select **Insert Object**, and then **Tank** (or click the **Insert Tank** icon). A data box will be displayed in the top right of the window.

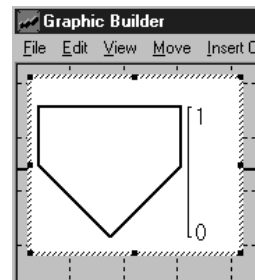

Insert the data box for the liquid temperature's PV, and then set the properties.

Insert and position the data box by performing the operation in Step 3., and then right-click and select **GrfData Control Object**, the **Properties**. The GrfData Control Properties Dialog Box will be displayed.

Make the following settings.

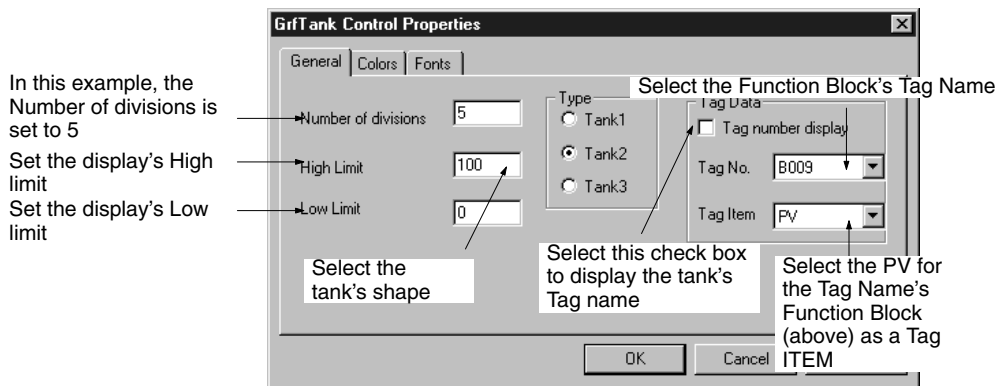

Click the **OK** Button.

This completes the Graphic Screen creation.

7. Save the data you have created.

Select **File**, and then **Save** or **Save As** (or click the **Save** icon).

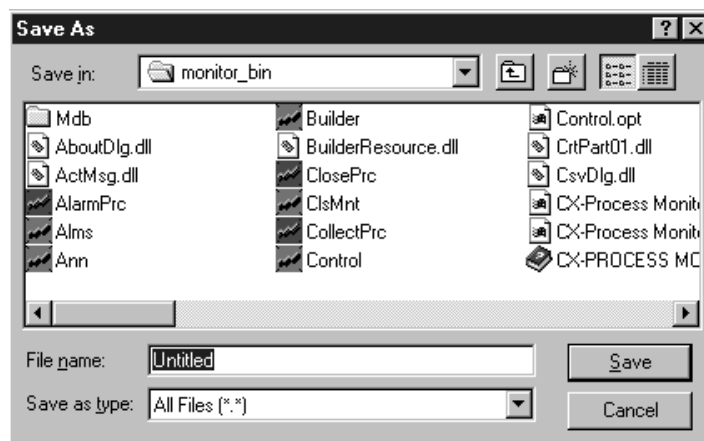

Insert a file name, the click the **Save** Button.

Note To display the Graphic Screen you have created, you must configure the screen. Refer to *4-6 Screen Configuration* for how to make the settings.

4-6 Screen Configuration

This section explains how to perform operations to configure the CX-Process Monitor Screen.

Use the CRT Builder to configure the following screens.

- Overview Screen
- Control Screen
- Trend Screen
- Graphic Screen (You must create this screen beforehand. Refer to 4-4 System Monitor Settings.)
- Annunciator Screen
- Alarm Log Screen
- Operation Guide Screen

Note The Tuning Screen is created automatically when the Control Screen is registered.

When all screens have been configured, save their settings.

4-6-1 CRT Builder Functions

Starting the CRT Builder In the Setup Dialog Box, click the **CRT Builder** Button.

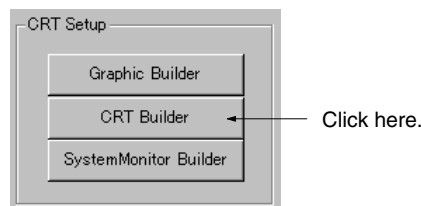

The CRT Builder Window will be displayed.

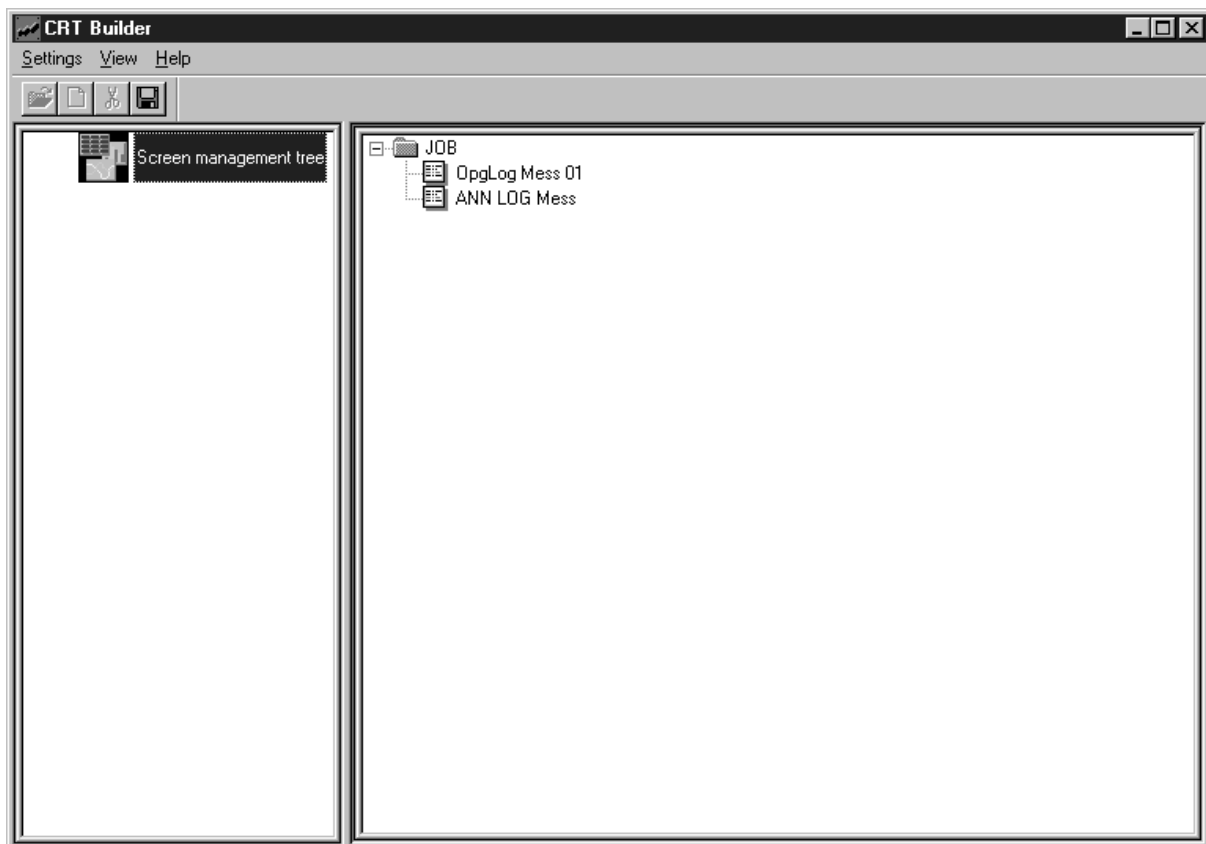

CRT Builder Menu

The CRT Builder menu contains the following functions.

Menu	Commands	Function
Settings	Create Overview Screen	Add a new Overview Screen based on the current Overview Screen.
	Register Screen	Set and register screen items. Enabled only when you have selected screen items using the Screen Management Tree.
	Delete	Deletes registered screen items.
	Save	Saves setting in CRT Builder.
	Exit	Ends the application.
View	Toolbars	Select whether to display or hide toolbars.
Help	About CRT Builder	Display the CRT Builder version information.

CRT Builder Toolbar

The CRT Builder toolbar contains the following functions.

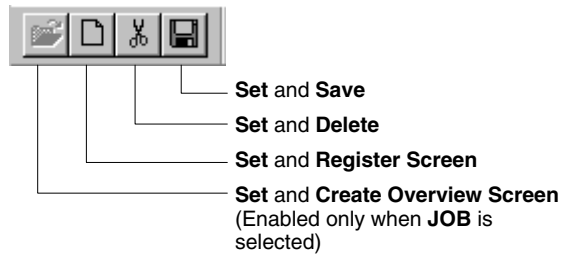

4-6-2 Overview of Screen Registration

This section explains how to register the Overview Screen and set and register the sub-elements of the Overview Screen given below.

Control Screen

Trend Screen

Graphic Screen (You must create the Graphic Screen beforehand. Refer to 4-2 Basic Configuration Procedure.)

Annunciator Screen

Note The Tuning Screen is created automatically when the Tag Name is allocated.

Registering the Overview Screen

- 1, 2, 3... 1. Start CRT Builder, and then in the CRT Builder's Screen Management Tree, select **JOB**, and then select **Setting**, and then select **Create Overview Screen**. The CRT Builder Dialog Box will be displayed.

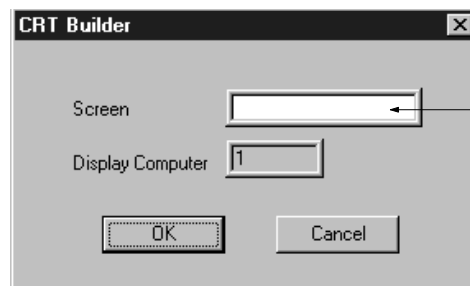

Enter the name of the Overview Screen using 8 full-width characters or 16 half-width characters. Make sure to enter a name for the Overview Screen.

Note Make sure to enter a name for the Overview Screen. If you do not enter a name, you will be unable to move to the Overview Screen.

2. Enter a screen name, and then click the **OK** Button.

The Overview Screen will be registered, and the name of the screen you entered will be displayed in the Screen Management Tree.

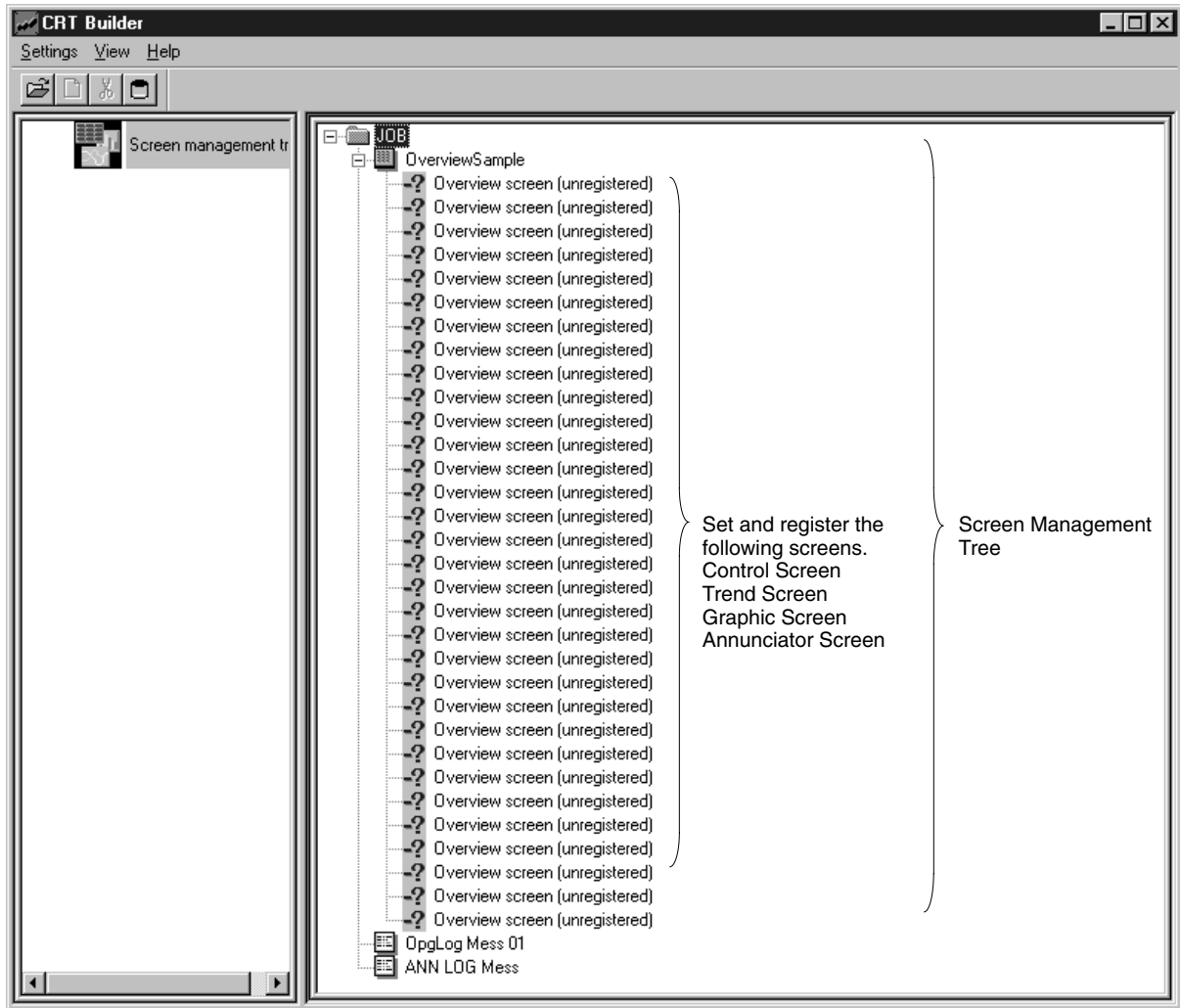

3. Select the screen item, and then select **Set**, and then select **Register Screen** (or double-click the screen item), to set and register the screens. Settings differ for each screen item. Refer to later in this manual for how to set each screen.

Setting the Screen Tag Names

To specify the Function Block data within the Loop Control Unit, specify a tag name when registering each screen.

Note To specify the Tag name, you must create a Monitor Tag file (select **Execute**, and then select **Compile Monitor Tags**) using CX-Process Tool (on Windows NT). If you do not create a Monitor Tag file, you cannot specify Tag Names from CX-Process Monitor.

There are two types of Tag names:

- 1, 2, 3... 1. Tag names for function blocks. If specifying tag names for Function Blocks, specify the function block ITEMs using tag ITEM. (See note.)

Note Tag ITEM is a fixed name allocated beforehand to specific ITEMs (PV, SP, and MV, etc.) for a specific Function Block (Control Block, and part of the Operation Block). Refer to *Appendix A ITEM Settings for Function Blocks* for details.

2. Tag names for analog ITEMs and contact ITEMs.

Refer to the following table for the relation between each screen and the tag name/tag ITEM given above.

Screen	1		2
	Tag names for function blocks	Tag ITEMS for the function block	Tag names for analog ITEMS and contact ITEMS
Control Screen	Can be specified	---	Can be specified
Trend Screen	Can be specified	Can be specified	Can be specified
Graphic Screen	Can be specified	Can be specified	Can be specified
Annunciator Screen	Can be specified	Can be specified	Can be specified
Operation Guide Message Screen	Can be specified	Can be specified	Can be specified
Alarm Log Screen	Can be specified	Can be specified	Can be specified

Note Set tag names for the function blocks using the 1-Block Send Terminal to Computer (403) and 4-Block Send Terminal to Computer (404) function blocks.

Set tag names for analog ITEMS and contact ITEMS using the functions blocks DO to Computer (Block Model 401), AO to Computer (Block Model 402), DO Terminal to All Nodes (Block Model 307), AO Terminal to All Nodes (Block Model 408), DO Terminal Settings from Computer (Block Model 409), and AO Terminal Settings from Computer (Block Model 410).

Example 1

Specifying the Function Block for the Control Screen as Function Block with Tag name "ABC."

Tag name	ABC
----------	-----

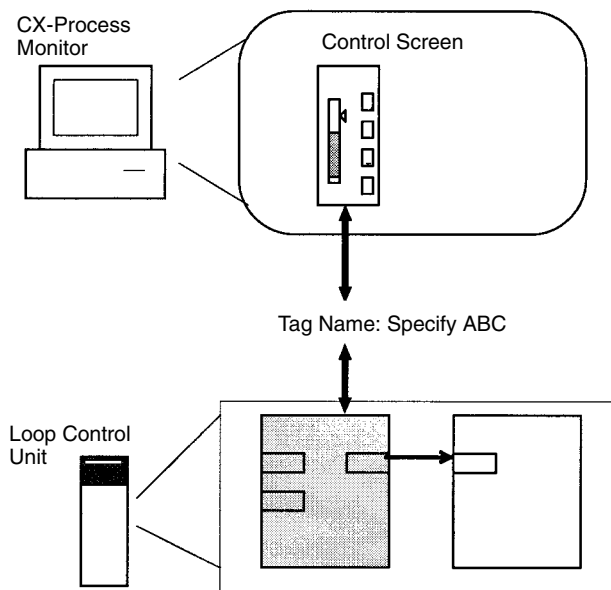

Example 2

Specifying the analog ITEM for the Trend Screen trends as Function Block Tag ITEM "MV" for Tag name "ABC."

Tag name	ABC
Tag ITEM	MV

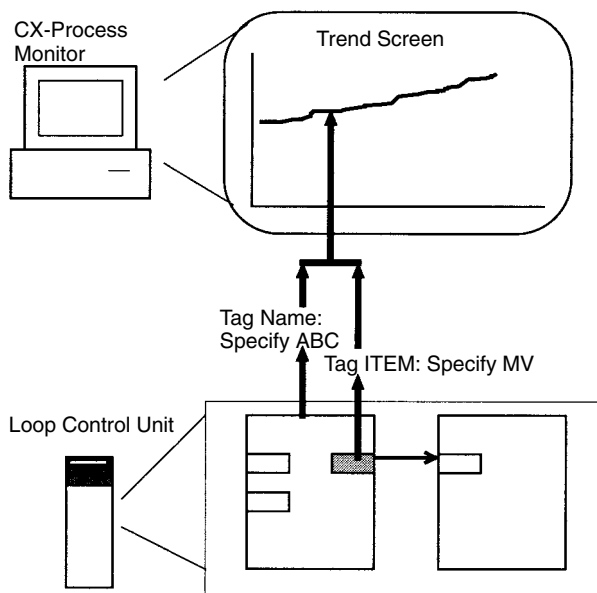

Example 3

Specifying the Trend Screen trend as analog ITEM for Tag name "IN1."

Tag name	IN1
----------	-----

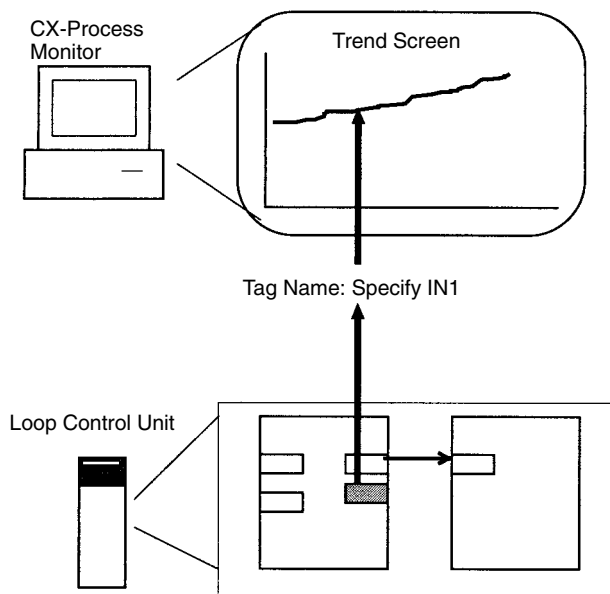

Changing Monitor Tag File Paths

Monitor Tag files are saved to the following directory at installation with a fixed file name.

Directory: Omron/CX-Process Monitor/db (The underlined part is the directory in which the CX-Process Monitor is installed.)

File names: mtagmst and mtagsubmst

It is possible to create several Monitor Tag files and switch between them by changing the application path. In this way, by creating new Monitor Tag files in a

directory different from the default one, and changing the application path to this directory, the Monitor Tag files that are used by CX-Process Monitor can be changed. The procedure is as follows.

- 1, 2, 3... 1. In the Mode Selection Dialog Box, click the **Set Up** Button. A box for entering the password will be displayed.
2. Enter the password and click the **OK** Button. The following Setup dialog Box will be displayed.

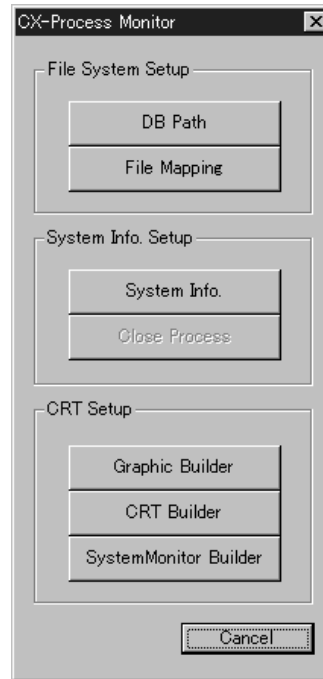

3. Click the **DB Path** Button. The following dialog box will be displayed.

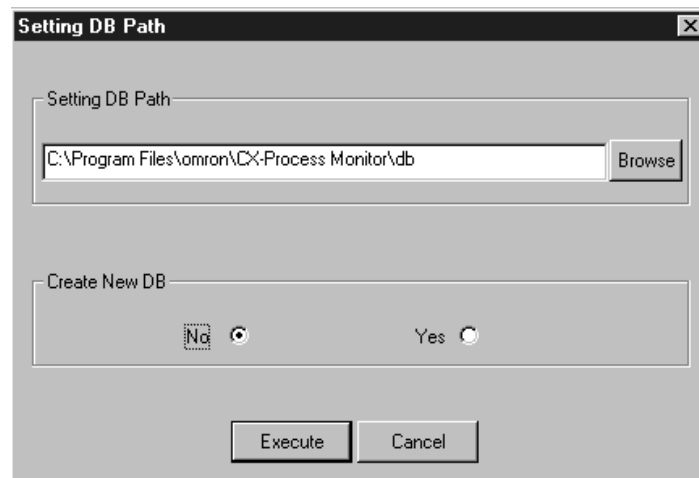

4. The current path setting is displayed in the Setting DB Path field. (The default setting, as in the above example, is Omron/CX-Process Monitor/db.)
5. Click the **Browse** Button and specify the new path in the dialog box that is displayed.
6. Select **Yes** in the Create New DB field and click the **Execute** Button. Initialized Monitor Tag files will be created at the specified path, and the application path will change to the specified one (i.e., the Monitor Tag files used by CX-Process Monitor will change to the newly created ones.)

- Note**
- a) Several files are created. Therefore, if a folder that is used only for Monitor Tag files is not specified, the Monitor Tag files will be created in the same folder as other files.
 - b) When creating new Monitor Tag files, files will be created with nothing registered. Therefore, CX-Process Monitor tags must be created (**Execution – Output Tag Files - Monitor Tags**), and CX-Process Monitor must be restarted.
 - c) Some time may be required until completion of new tag creation.

To return the Monitor Tag files that are use to the ones at the original path, select **No** in the Create New DB field and click the **Execute** Button. The application path will change to the original one (i.e., the files that CX-Process Monitor uses will change to the ones corresponding to the original path.) If, however, there are no Monitor Tag files at the specified path, an error will be generated when file mapping is attempted (i.e., the **File Mapping** Button is clicked.)

Note Specifying **No** in the Create New DB field is used to return the application path to the original one after it has been changed by specifying **Yes** in the Create New DB field.

Registering Control Screens

- 1, 2, 3... 1. Select **Screen** in the Overview Screen sub-elements using Screen Management Tree in CRT Builder.

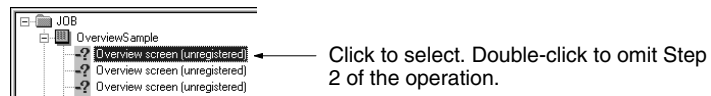

2. From the **Settings** menu, select **Register Screen**, or double-click **Screen**. The following dialog box will be displayed.

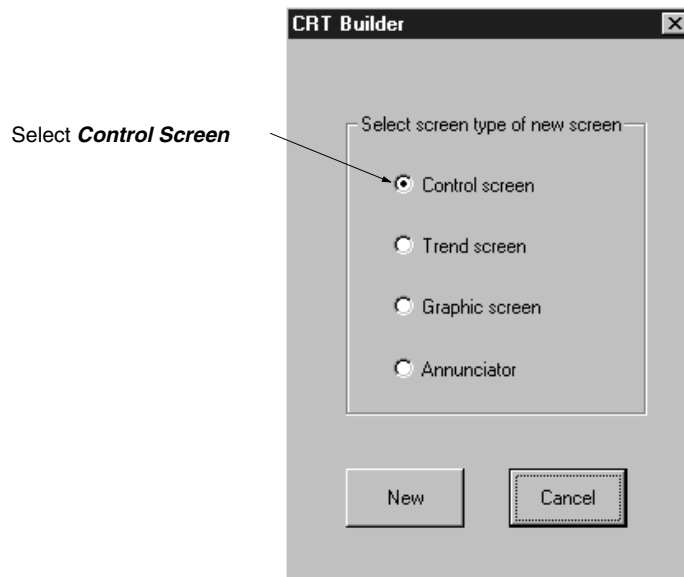

3. Select **Control Screen**, and then click the **New** Button. The following dialog box will be displayed.

You can register up to eight function blocks in the Control Screen. Specify the function blocks using Tag names.

Select the box. The following dialog box will be displayed.

Select the Tag Name corresponding to the function block, analog ITEM, or contact ITEM you want to register, and then click the **OK** Button.

As shown in the screen on the right, you can allocate up to eight Tag names.

Enter the name of the Control Screen using 16 characters.

Number	TAG No	Detail	Delete
1	<input type="text"/>	<input type="button" value="Detail"/>	<input type="button" value="Delete"/>
2	<input type="text"/>	<input type="button" value="Detail"/>	<input type="button" value="Delete"/>
3	<input type="text"/>	<input type="button" value="Detail"/>	<input type="button" value="Delete"/>
4	<input type="text"/>	<input type="button" value="Detail"/>	<input type="button" value="Delete"/>
5	<input type="text"/>	<input type="button" value="Detail"/>	<input type="button" value="Delete"/>
6	<input type="text"/>	<input type="button" value="Detail"/>	<input type="button" value="Delete"/>
7	<input type="text"/>	<input type="button" value="Detail"/>	<input type="button" value="Delete"/>
8	<input type="text"/>	<input type="button" value="Detail"/>	<input type="button" value="Delete"/>

Deletes the registered Tags. When you register a Tag, the button is enabled.

When you select a Tag Name, the Details Button is enabled.

Select the box. The following dialog box will be displayed.

When you select this box, the Manual Pointer is not displayed. Refer to the next page for details of displays.

Select this box, and then select the direction MV will open. If you do not specify a direction, no direction will be displayed. Refer to the next page for details of displays.

Displays the settings made using CX-Process Tool. You cannot change the settings.

Select this box to set the Prominent Tag. When setting the Prominent Tag, the following mark will be added to the icon on the Overview Screen, as shown.

Make the settings, and then click the **OK** Button.

The Manual Pointer and MV direction settings will be reflected in the MV adjustment area in the lower part of the instrument diagram. Refer to the next page for details of displays.

MV Adjustment Area Display in the Lower Part of the Instrument Diagram

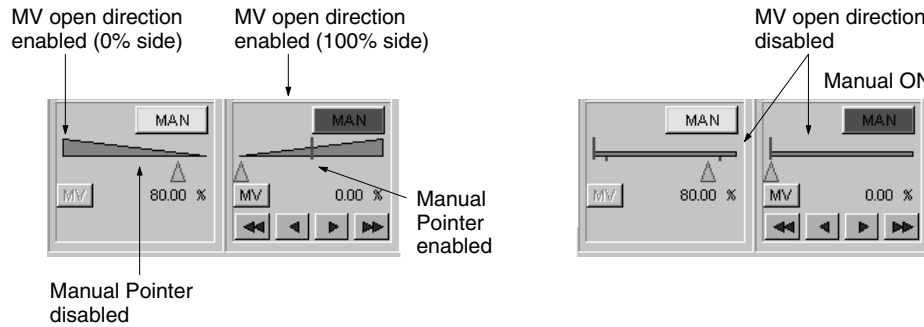

4. Enter the Screen Name, set the Tag Name and Detailed Settings, then click the **OK** Button.

The Control Screen will be registered, and the Screen Name you have entered will be displayed on the Screen Management Tree.

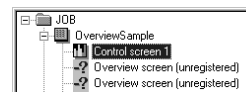

Registering Trend Screens

You can register up to 60 Realtime Trend Screens, and up to 120 Historical Trend Screens.

1, 2, 3...

1. Select the Overview Screen's sub-element **Screen** in the CRT Builder's Screen Management Tree.

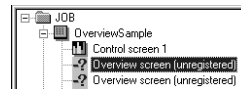

Click to select. Double-click to omit Step 2 of the operation.

2. In the **Settings** Menu, select **Register Screen**, or double-click **Screen**.
The dialog box shown in Step 2 of the preceding section, Control Screen Registration, will be displayed.

3. Select the Trend Screen, and then click the **New** Button.

The following dialog box will appear.

You can register a maximum to eight analog ITEMS (PV, SP, MV, or other analog signals), or eight contact ITEMS in the Trend Screen. Specify analog ITEMS or contact ITEMS using either a) or b) below.

- a) Tag name and relevant Tag ITEM (either PV, SP, or MV) corresponding to the function block.

b) The Tag name corresponding to the analog ITEM or contact ITEM.

Please check here to enable automatically saving a CSV file. When automatic saving has been enabled, the save period (time), save destination folder, save file name, and browse button will be enabled.

Select the Trend type

Enter the name of the Overview Screen using 16 characters.

Deletes the registered tags. When you register a tag, the button is enabled.

Click the box. The following dialog box will be displayed.

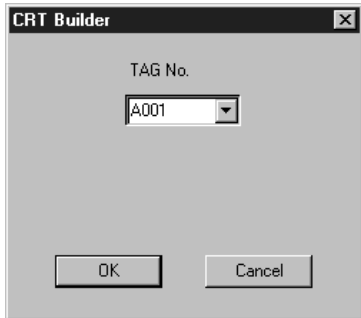

Select a) the tag name for the Function Block (including the analog ITEMS you want to register), or b) the tag name for the for the analog ITEMS or contact ITEMS you want to register. In this example, the tag name for the Function Block for a) has been specified.

As shown in the screen on the right, you can allocate up to eight tag names.

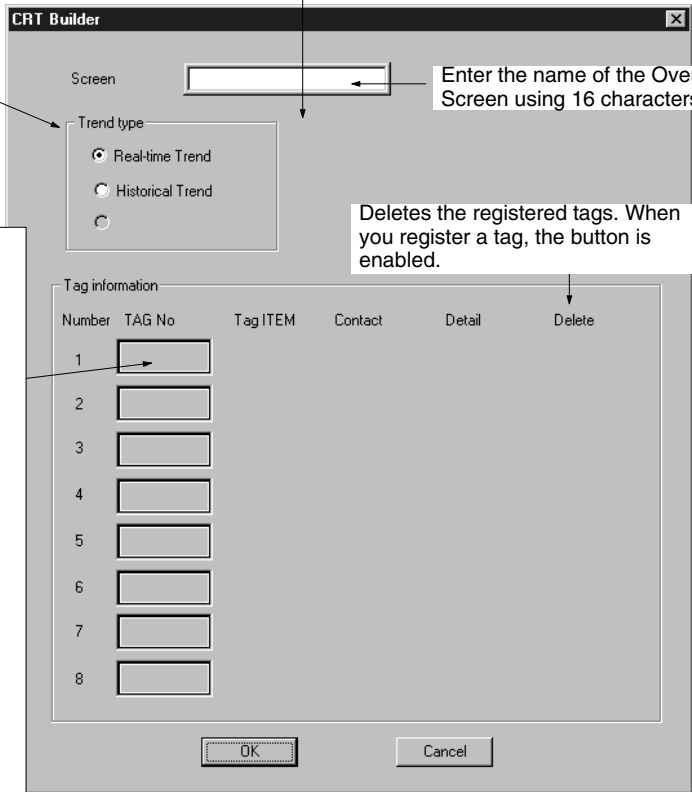

4. Enter the Screen Name, set the **Trend Type**, and then select **Tag Name**. When you register the Tag name, the dialog box will change as follows.



Select the box. The following dialog box will be displayed.

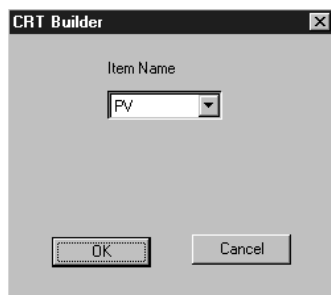

Select the Tag ITEM corresponding to the analog ITEM you want to register. In this example, Tag ITEM "PV" for the Function Block for Tag name 4B009 has been selected.

Select the box. The following dialog box will be displayed.

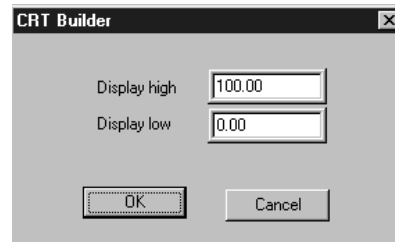

Normally, there is no need to make settings because they are set automatically.

Part of the data (PID constants, etc.), however, may not match the display on the chart. Set the settings for the High Limit and Low Limit for this data only.

- Set **Configure Tag Name**, **Tag ITEM**, and **Detailed Settings**, and then click the **OK** Button.

The Trend Screen will be registered, and the name of the screen you entered will be displayed in the Screen Management Tree.

Saving to an CSV File

Automatically saving to an CSV file is described below.

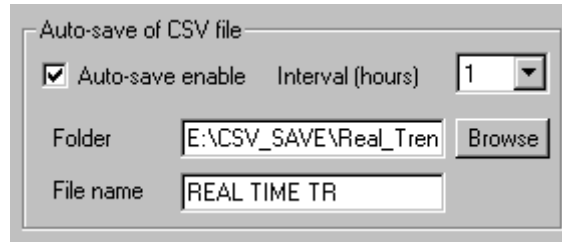

To automatically save a CSV file, check *Autosave enable* on the above screen and then make the following settings.

Interval (hours)

The time can be set to 1, 2, 3, 4, 6, 10, 12, 18, 20, 24, 48, 72, 86, 120, or 240 hours. The default for Real Time Trends is 12 hours, and the default for Historical Trends is 240 hours.

Folder

Specify the folder in which to save the file. The *Browse* Button can be use to simplify setting the folder.

Filename

Specify the name of the file to save. Do not specify the file name extension. The actual name of the file will be as follows: *filename_date_number.csv*. The date will be in the form *yymmdd*. The number will be consecutively assigned from 00 and will be reset to 00 when the date changes. For example, if the file name is specified as "RealTime," the actual name of the first file saved on 19 September 2000 would be "RealTime_000919_00.csv."

Note The number attached to the file name is not saved. If the system is shutdown and restarted in the same day, files will be overwritten starting from 00.

The autosave function will start on the hour (00 minutes 00 seconds) after the monitoring process is started, possibly creating a waiting period of up to 59 minutes and 59 seconds before the autosave function starts. For example, if the save interval is set to 3 hours and the monitoring process starts at 3:32:47 pm, data collection would be started at 4:00:00 pm and the first file would be saved at 7:00:00 pm.

Registering Graphic Screens

You can register up to 200 Graphic Screens.

Note Before registering the Graphic Screen, you must create and save the Graphic Screen using the **Graphic Builder** Button. Refer to 4-5 *Graphic Screen Creation* for how to create a Graphic Screen.

The registration procedure is as follows:

- 1, 2, 3...** 1. Select **Screen** in the Overview Screen sub-elements using Screen Management Tree in CRT Builder.



2. From the **Settings** menu, select **Register Screen**, or double-click **Screen**. The dialog box shown in Step 2 of the proceeding Control Screen Registration will be displayed.

3. Select **Graphic Screen**, and then click the **New** Button.

The following dialog box will be displayed.

Select the Graphic Screen you created and saved using CRT Builder (i.e., the **Graphic Builder** Button).

Note Before registering the Overview Screen, you must create and save the Graphic Screen using CRT Builder.

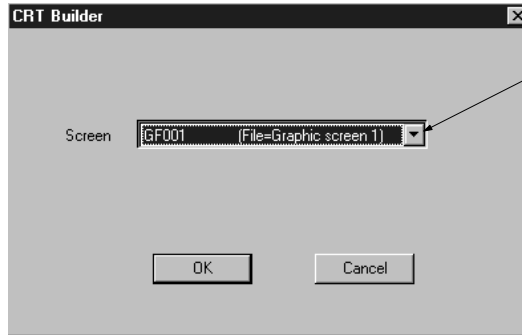

Select the name of Graphic Screen to be allocated.

All of the saved Graphic Screen names will be displayed.

4. Select the screen name, and then click the **OK** Button.

The Overview Screen will be registered, and the name of the screen you entered will be displayed in the Screen Management Tree.

Registering Annunciator Screens

You can register up to five Annunciator Screens. The registration procedure is as follows:

1, 2, 3...

1. Select the Overview Screen's sub-element **Screen** in the CRT Builder's Screen Management Tree.

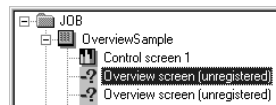

Click to select. Double-click to omit Step 2 of the operation.

2. In the **Settings** Menu, select **Register Screen**, or double-click **Screen**.

The dialog box shown in Step 2 of the preceding section, Control Screen Registration, will be displayed.

3. Select the Trend Screen, and then click the **New** Button.

The following dialog box will appear.

You can register up to 16 contact ITEMS in the Annunciator Screen. Specify the contact ITEM using the Tag name.

Enter the name of the Control Screen using 16 characters.

Select the box. The following dialog box will be displayed.

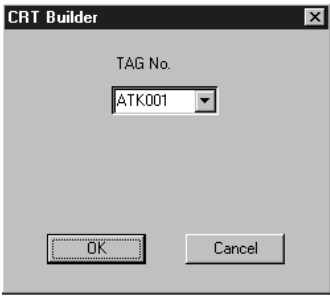

Select a) the Tag name for the function block (including the contact ITEMS you want to register), or b) the Tag name for the for the contact ITEMS you want to register. In this example, the Tag name for the function block for a) has been specified.

As shown in the screen on the right, you can allocate up to 16 Tag name.

Set the Tag name to display the following Buttons.

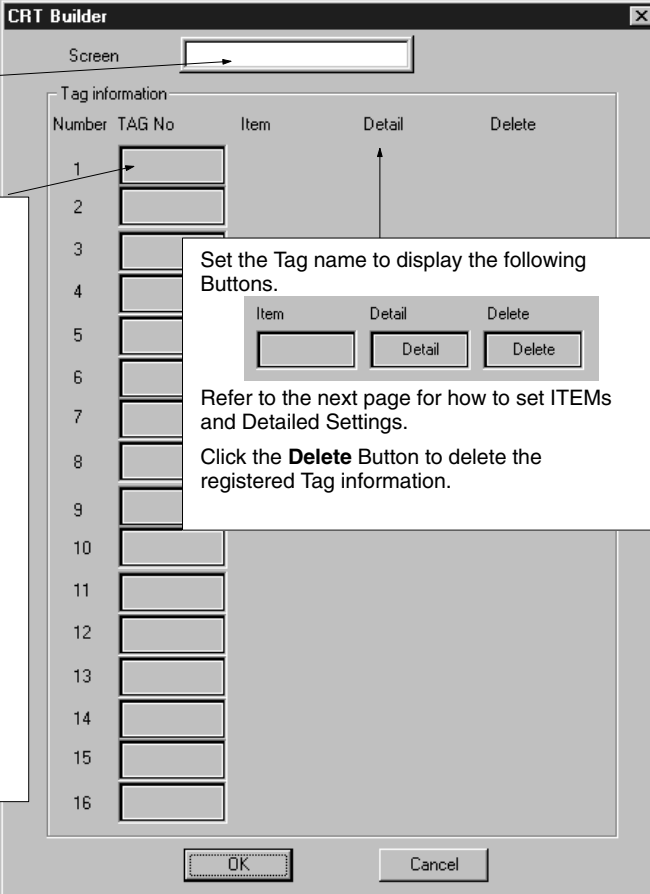

Refer to the next page for how to set ITEMS and Detailed Settings.

Click the **Delete** Button to delete the registered Tag information.

Setting ITEMS

Select the tag name, and then click the **ITEM** Button. The following dialog box will be displayed.

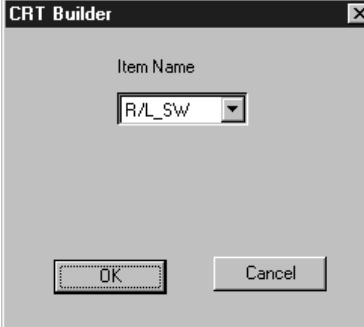

Select the Tag ITEM corresponding to the contact ITEM you want to set. In this example, Tag ITEM “RL_SW” for the Function Block for Tag Name ATK001 has been selected. Next, click the **OK** Button.

Detailed Settings

Select the Tag name, and then click the **Details** Button. The following dialog box will be displayed.

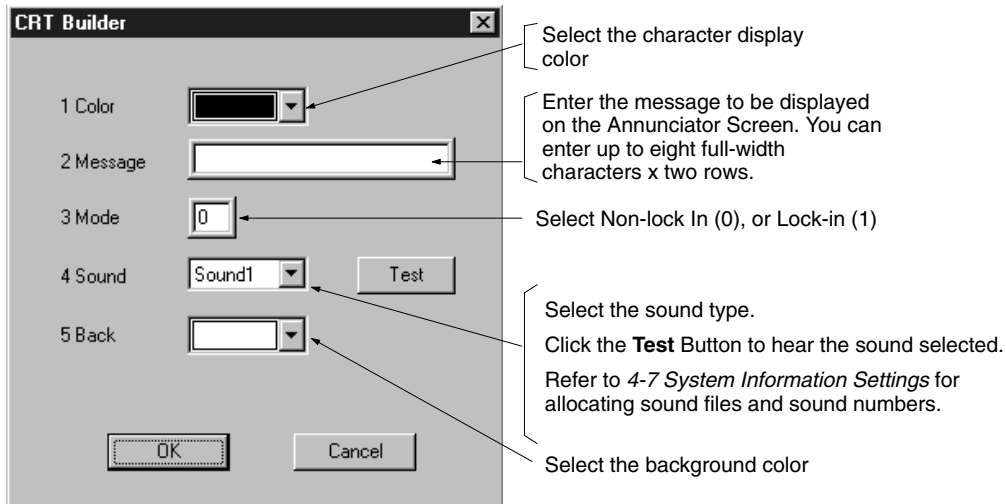

Complete the settings, and then click the **OK** Button.

4. Make the above settings, and then click the **OK** Button.

The Annunciator Screen will be registered, and the name of the screen you entered will be displayed in the Screen Management Tree.

4-6-3 Registering Operation Guide Messages

This section explains how to register Operation Guide Messages.

If the conditions registered here occur, the corresponding message will be displayed on the Operation Guide Log Screen, and saved.

- 1, 2, 3... 1. Select **OpgLog Mess01** int the CRT Builder’s Screen Management Tree.

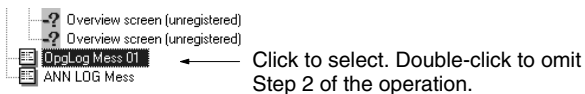

2. In the **Settings** Menu, select **Register Screen**, or double-click **OpgLog Mess01**.

The following dialog box will appear.

You can register up to 100 contact ITEMS in the Operation Guide Messages. Specify the contact ITEM using the Tag names.

Enter the name of the Overview Screen using 16 characters.

Switch the page numbers. Click either button to move up and down the table of registered Tag names below by 10 at a time.

Select the box. The following dialog box will be displayed.

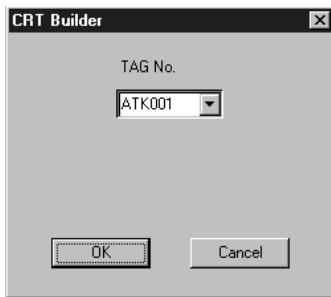

Select a) the Tag name for the function block (including the contact ITEMS you want to register), or b) the Tag name for the for the contact ITEMS you want to register. In this example, the Tag name for the function block for a) has been specified.

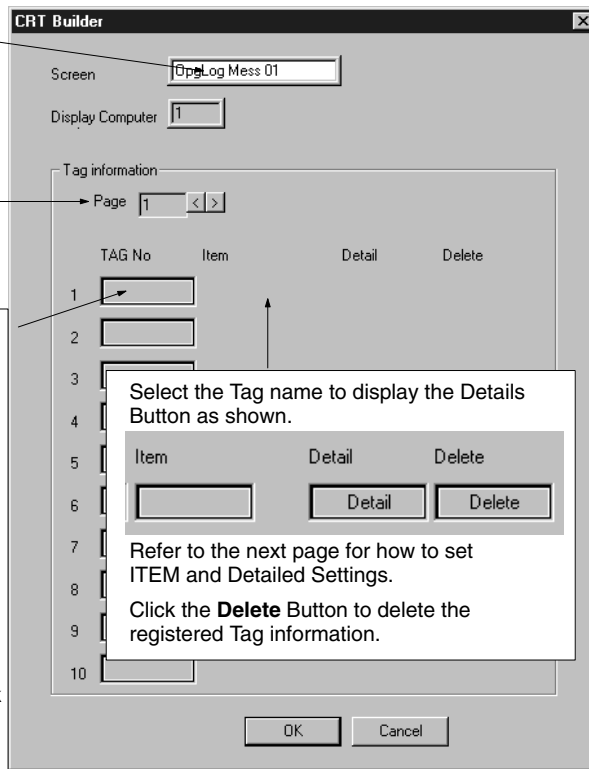

Setting Items

Select the Tag name, and then click the **ITEM** Button. The following dialog box will be displayed.

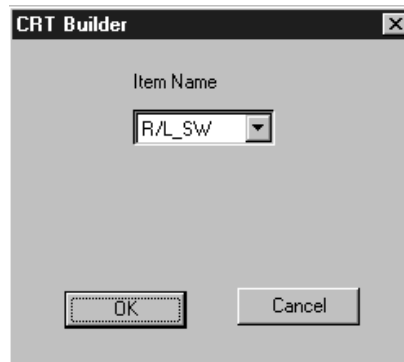

Select the Tag ITEM corresponding to the contact ITEM you want to set. In this example, Tag ITEM “PV” for the Function Block for Tag Name ATK001 has been selected. Next, click the **OK** Button.

Detailed Settings

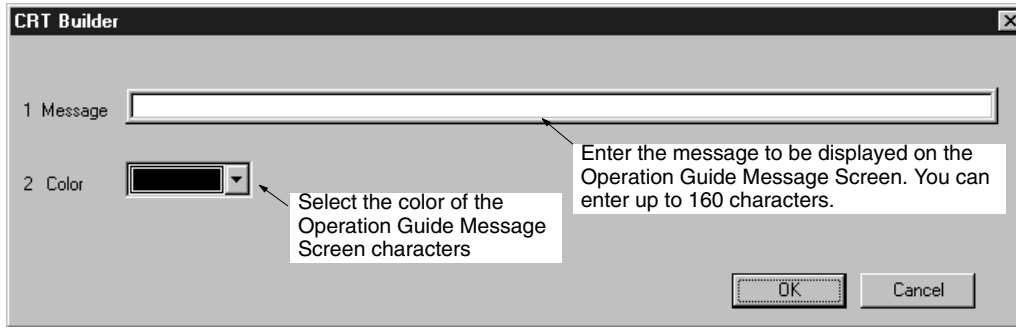

After completing the settings, click the **OK** Button.

3. After completing the above settings, click the **OK** Button.

The Operation Guide Message Screen will be registered, and the name of the screen you entered will be displayed in the Screen Management Tree.

4-6-4 Registering Alarm Messages

This section explains how to register alarm messages.

If the conditions registered here occur, the corresponding alarm message will be displayed in the second line of the Monitor Screen, and the alarm message will be saved on the Alarm Log Screen.

- 1, 2, 3... 1. In the CRT Builder's Screen Management Tree, select **Register Alarm Message**.

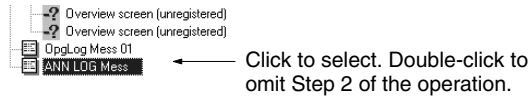

2. From the Settings Menu, select **Register Screen**, or double-click **ANN LOG Mess**.

The following dialog box will be displayed.

You can register up to 50 contact ITEMS in the alarm messages. Specify the setting ITEMS using the Tag name.

Enter the name of the Alarm Message Registration Screen using 16 characters.

Switch the page numbers. Click either button to move up and down the table of registered Tag names below by 10 at a time.

Select the box. The following dialog box will be displayed.

Select the Tag name to display the Details Button as shown.

Item Detail Delete

Refer to the next page for how to set ITEM and Detailed Settings.

Click the **Delete** Button to delete the registered Tag information.

Select a) the Tag name for the function block (including the contact ITEMS you want to register), or b) the Tag name for the for the contact ITEMS you want to register. In this example, the Tag name for the function block for a) has been specified.

Setting ITEMS

Select the Tag name, and then click the **ITEM** Button. The following dialog box will be displayed.

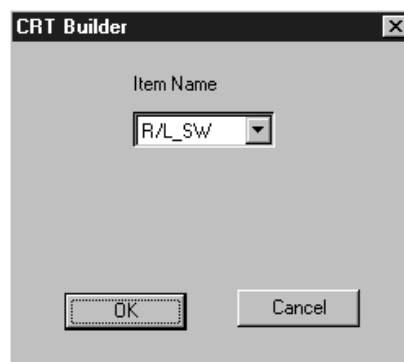

Select the Tag ITEM corresponding to the contact ITEM you want to set. In this example, Tag ITEM “RL_SW” for the Function Block for Tag name ATK001 has been selected. Next, click the **OK** Button.

Detailed Settings

Select the Tag name, and then click the **Details** Button. The following dialog box will be displayed.

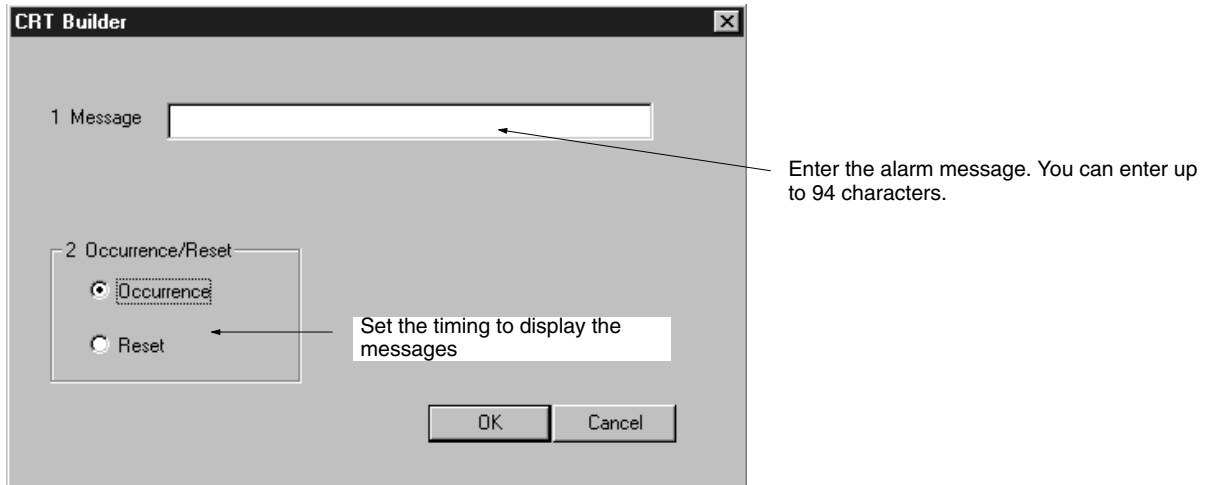

After making the settings, click the **OK** Button.

Display is red for an occurrence, and black following recovery.

3. Complete the above settings, and then click the **OK** Button.

The alarm message will be registered, and the name of the screen you entered will be displayed in the Screen Management Tree.

4-6-5 Saving Settings

Save the screen configurations that you have set.

Note If setting or changing screen configurations, make sure to save the settings or changes.

- 1, 2, 3... 1. From the Settings Menu in the CRT Builder, select **Save**.



2. Click the **OK** Button.

4-6-6 Deleting Registered Screens

To delete registered screens, perform the following operation.

- 1, 2, 3... 1. In the CRT Builder's Screen Management Tree, click to select the screen you want to delete.

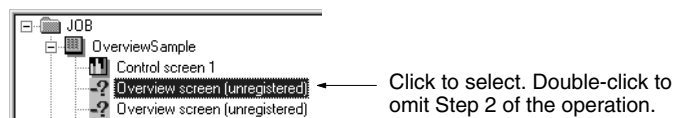

2. From the CRT Builder Settings Menu, select **Delete**.



3. Click the **OK** Button.

4-6-7 Starting the Monitor Process

To start the monitor process, perform the following operation.

- 1, 2, 3... 1. In the Mode Selection Dialog Box, click the **Set Up** Button.
2. In the Setup Dialog Box, click the **File Mapping** Button.
3. In the Setup Dialog Box, click the **Start Up** Button.
4. Click the **OK** Button.
5. In the Mode Selection Dialog Box, click the **Overview** Button.

4-7 System Information Settings

This section explains label information, alarm sound information, and how to make the ten-key, color, and key-lock settings.

The contents of the settings are as follows.

Item	Contents
Label information	Label name
	Label color
Alarm sound information	Allocate an alarm sound file to each alarm number (1 to 10)
Ten-key settings	Set whether you want to use the Ten-key Dialog Box when entering numerical values. This setting will be enabled for all Monitor Screens. If you enable the ten-key, the Ten-key Dialog Box will be displayed when you select the numerical input box.
Color settings	Specify the color of the buttons used for the Function Block diagrams in the Control Screen and Tuning Screen.
Key-lock settings	It is possible to prohibit the values of ITEMS being changed from the Control Screen or the Tuning Screen.
Multi-screen settings	Specify if multiple screens can be displayed and automatic exiting of the background window for the monitoring process when automatically ending in operator mode. Set the order in which pages are to change.
Auto-start settings	Specify the scale display (engineering units or percentages) for the Tuning and Trend Screens, the Tuning Screen opening method, auto-starting, and the color of alarms on Annunciator Screens.
CSV file auto-save settings	Set automatic saving, the folder and file name, and the available disk space at which to generate an alarm or error.
Alarm sound stop settings	<ul style="list-style-type: none"> • Set whether the alarm will sound during alarm recovery. • Set whether MHA and MLA are handled as alarms. • Register tags for which alarms will stop.

- 1, 2, 3... 1. In the Setup Dialog Box, click the **System Info.** Button.

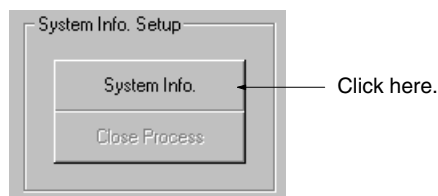

The following window will be displayed.

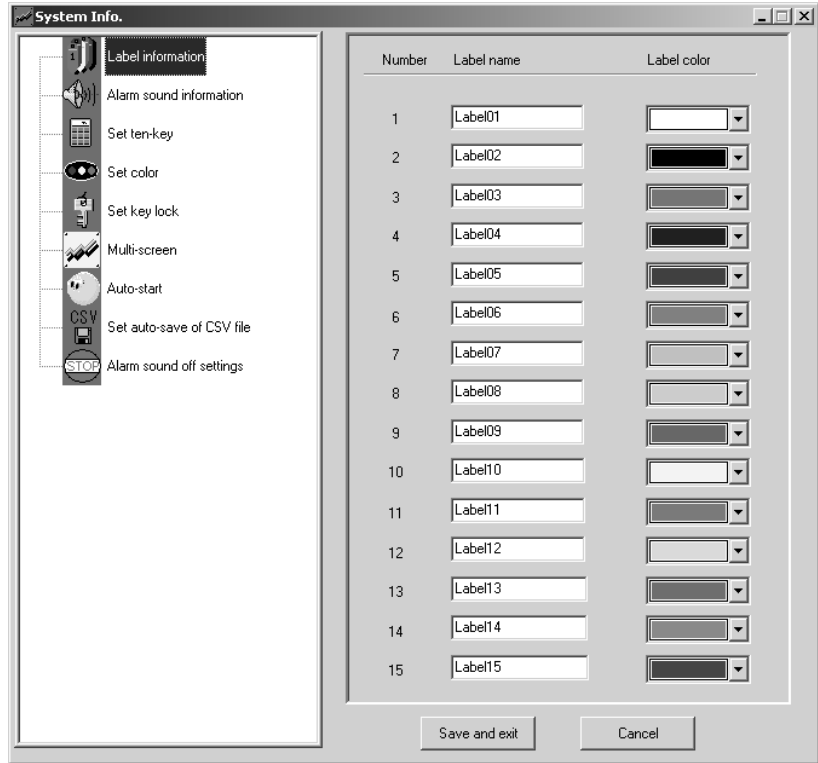

2. In the leftmost window, select **Label information, Alarm sound information, Set ten-key, Set color, or Set key lock.**
3. Perform the following settings as shown.
4. When you have completed all the settings, click the **Save and Exit** Button.

Label Information Settings

In the leftmost window, select **Label Information.** The screen shown in Step 1 will be displayed.

Set **Label name** and **Label color.**

Alarm Sound Information Settings

In the leftmost window, select **Alarm sound information**. The following screen will be displayed.

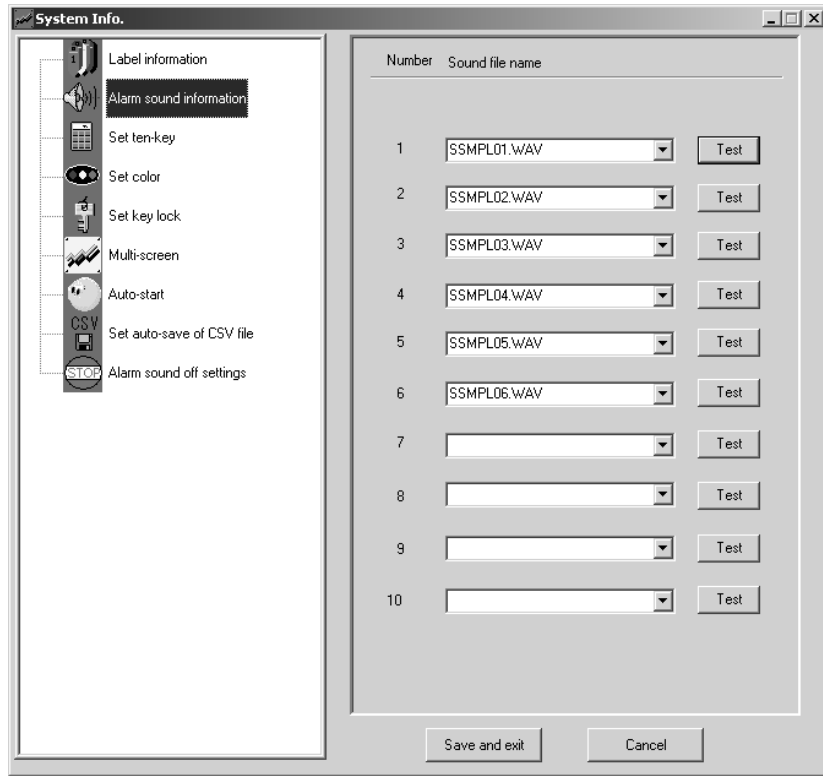

Allocate a sound file to each alarm sound number to register the sound you want to use.

Click the **Test** Button to try sounding the alarm.

Ten-key Settings

In the leftmost window, select **Set ten-key**. The following screen will be displayed.



Click the **Use ten-key** Button or the **Don't Use ten-key** Button. The setting will be enabled for all Monitor Screens.

If you set **Use ten-key**, when you select the input numerical value box, the Input Data Dialog Box will be displayed.

Example

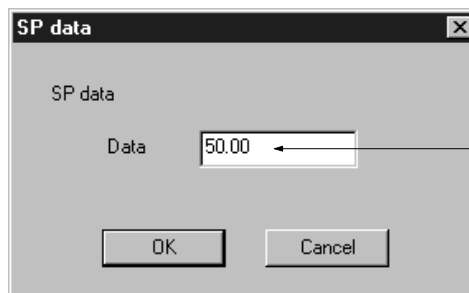

If you set Use Ten-key, when you select the input numerical value box, the Input Data Dialog Box will be displayed.

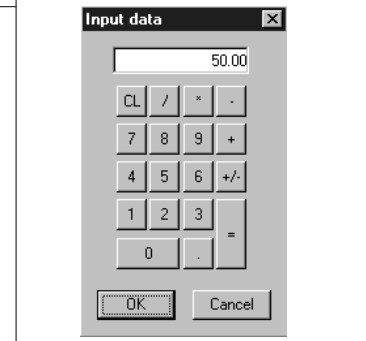

Set the ten-key size to either large or small.

Color Settings

In the leftmost window, select **Set color**. The following screen will be displayed.

Color setting for the buttons used in the AUT/MAN/CAS/FIELD/
CONT/PAUSE/START/STOP/RESET Function Block diagrams

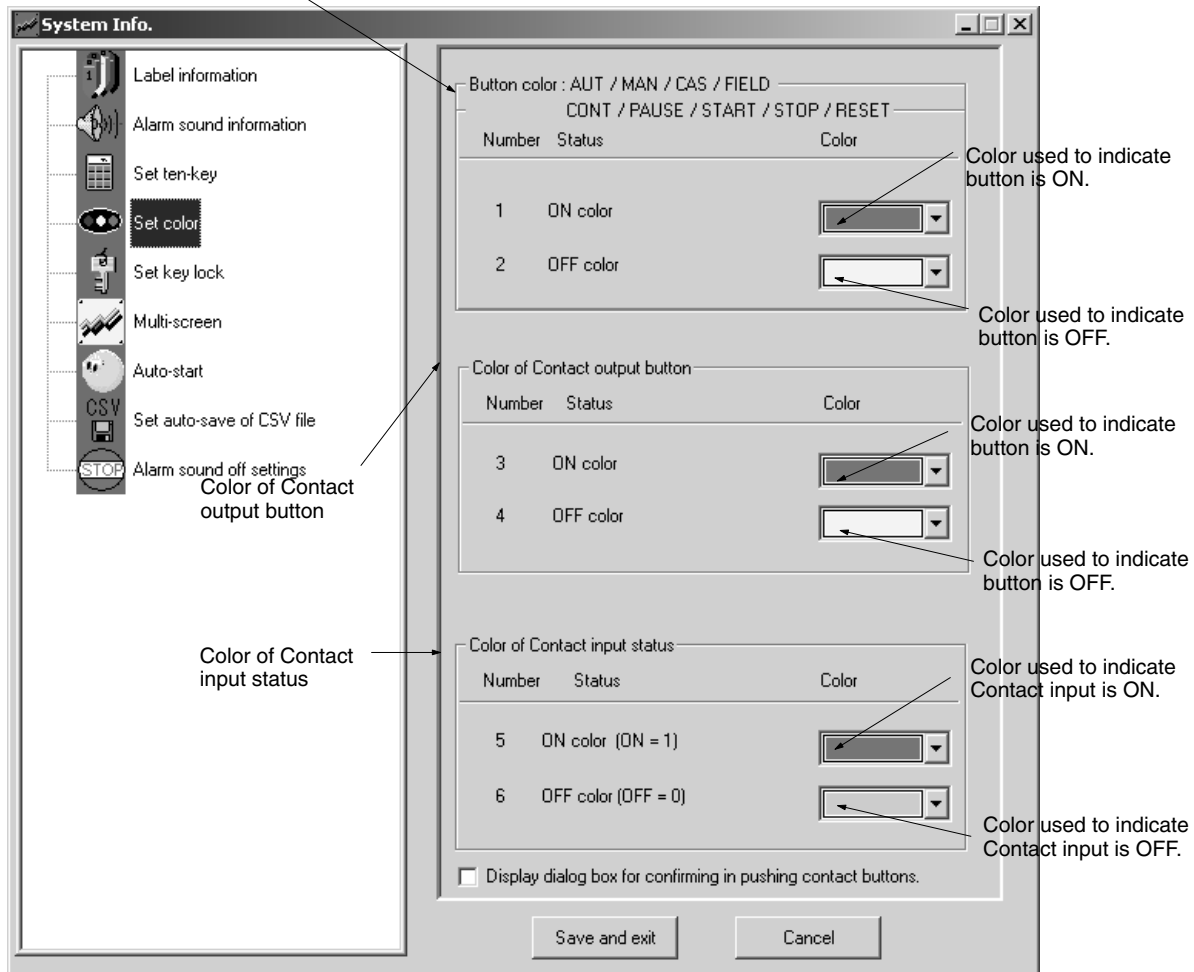

Use the above screen to specify the color used for the AUT/MAN/CAS/FIELD/CONT/PAUSE/START/STOP/RESET Function Block diagrams, the Contact output buttons, and the Contact input status.

If the **Display dialog box for confirming in pushing contact buttons** setting is clicked, a confirmation dialog box like the one shown below will be displayed to confirm operation when a contact output button, like AUTO/MAN is clicked.



Key-lock Settings

In the leftmost window, select **Set key lock**. The following screen will be displayed.

It is possible to prohibit changing specified ITEM values (e.g., changing SP values or PID constants) of specified Function Blocks (e.g., Basic PID Block) in screens, such as the Control Screen and the Tuning Screen, that can be using for setting operations from the CX-Process Monitor. These settings are called "key locks."

Note Key-lock specifications are made in terms of block models (setting in terms of the CX-Process Monitor's tag names is not possible). The following operation is only possible in Operator mode.

Setting Procedure

- 1, 2, 3...** 1. Select **Block Model**. The Function Blocks will be displayed below it.

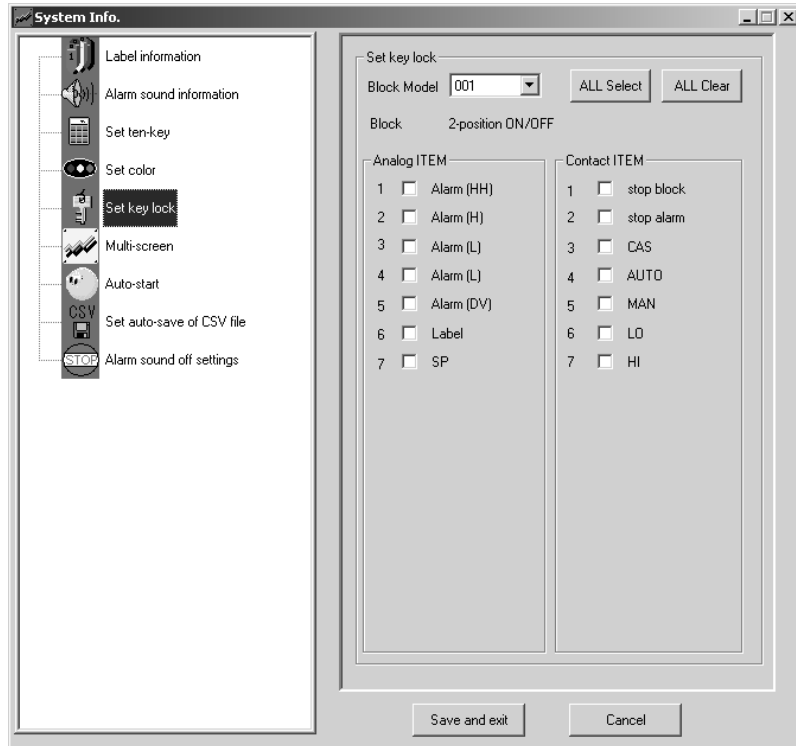

2. To set key locks for all the analog and contact ITEMS of the Function Blocks of the specified Block Model that can usually be changed using CX-Process Monitor, click the **All Select** Button. Similarly, to clear the key locks for all of the ITEMS, click the **All Clear** Button.

To set key locks for specific ITEMS, click in the check box of the required ITEMS in either the analog ITEM or Contact ITEM fields.

3. Click the **Save and exit** Button to enable the key lock settings.

Operation with Key Locks Enabled

- 1, 2, 3...** 1. If an attempt to change the value of an ITEM (e.g., SP) for which key lock has been set (e.g., by pressing the **SP** Button), the following dialog box will be displayed.

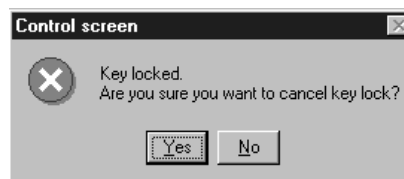

2. If **Yes** is clicked, the following dialog box, requesting entry of a password, will be displayed. (If **No** is clicked, the operation to change the ITEM will be cancelled.)

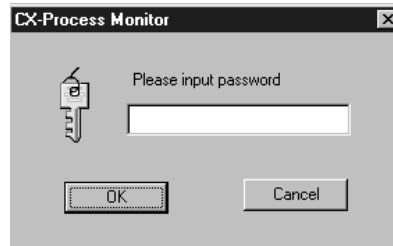

If the password set in Engineer mode is entered (refer to 4-3-3 Password), the key lock for the ITEM will temporarily be cleared and it will be possible to change the value. The next time, however, that an attempt to change the value of the same ITEM is made, the key lock will be enabled and the above procedure will have to be repeated.

Multi-screen Settings

If **Multi-screen** is selected, the following screen will be displayed.

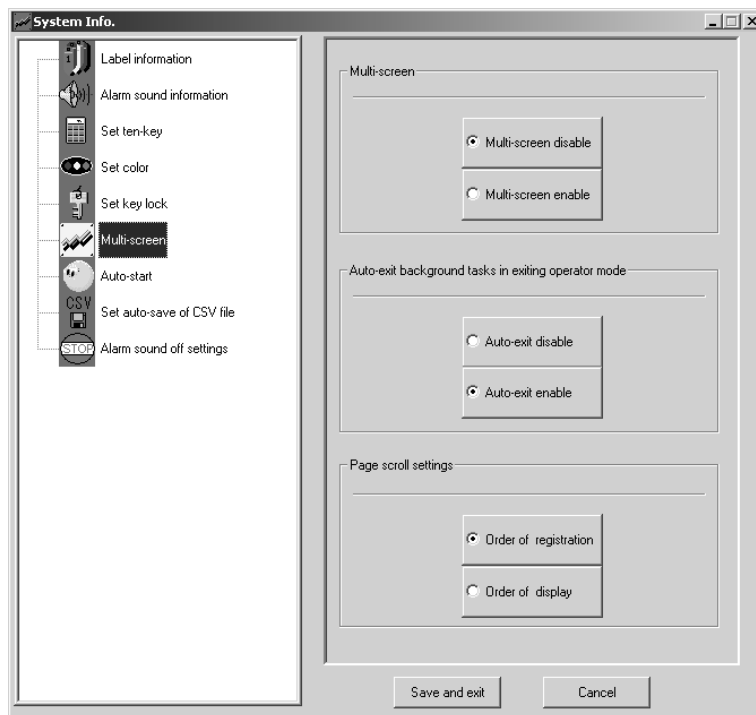

The following settings can be made.

Multi-screen

Set whether or not more than one Overview Screen can be displayed at the same time.

Auto-exit Background Tasks in Exiting Operator Mode

Set whether or not to close the background tasks (monitoring processes) automatically when exiting the operator mode screen.

Note Always disable automatically exiting background tasks if more than one screen is going to be opened in operator mode.

Setting the Order of Page Changes

The order in which pages are changed when the **Next** and **Previous** Buttons are clicked can be set to either the order they are registered in the database or the order they are displayed in the Builder Window. Both realtime trends and historical trends are treated in the same group.

Note The first page in each group will be displayed when the **Next** Button is pressed at the last page in the group. The last page in each group will be displayed when the **Previous** Button is pressed at the first page in the group.

Order of Database Registration

Pages will change in the order they are registered using the Builder Window. Both realtime trends and historical trends are treated in the same group.

Example:

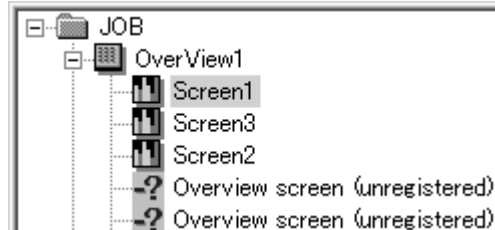

If the pages were registered in the order 1, 2, 3, then they will be displayed in that order.

Order of Display

Pages will change in the order they are displayed in the Builder Window. Both realtime trends and historical trends are treated in the same group.

Example:



The pages will be displayed in the order 1, 3, 2 regardless of the order in which they were registered.

Auto-start Settings

If **Auto-start** is selected, the following screen will be displayed.

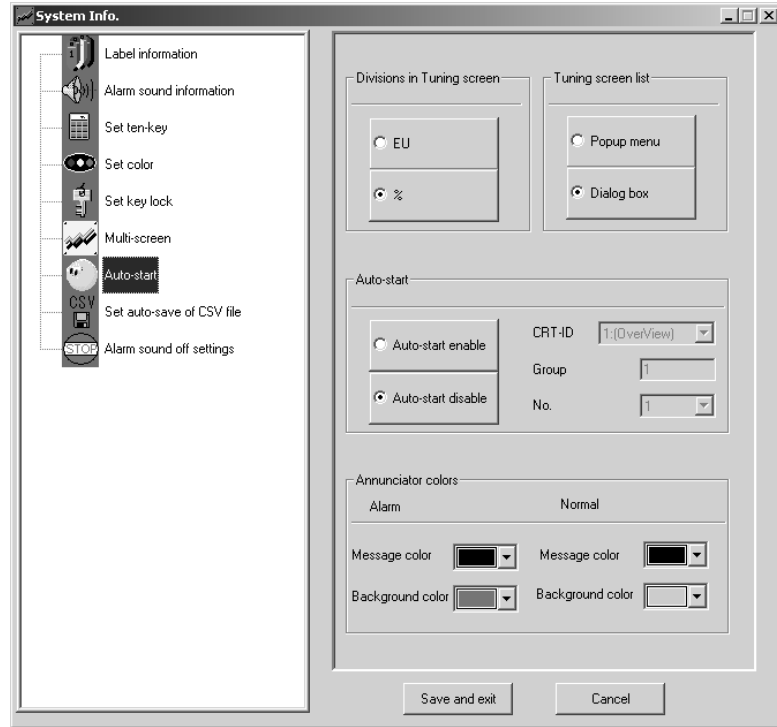

The following settings can be made.

Divisions in Tuning Screen

Specify whether to use engineering units or percentages for the scale displayed in a Tuning Screen. The default is for percentages.

Tuning Screen List

Specify whether to input the tag name directly or to select the tag name from a pull-down menu when switching to a Tuning Screen by clicking in the upper left corner of an Overview Screen.

Pull-down Menu

1 D1550001	33 D0552015	65 A003	97 aa020
2 D1550002	34 D0552016	66 A004	98 aa021
3 D1550003	35 CNT_L51	67 A005	99 aa022
4 D1550004	36 TIM_L51	68 A006	100 aa023
5 D1550005	37 TIM_L52	69 A007	101 aa024
6 D1550006	38 B009AUT	70 A008	102 aa025
7 D1550007	39 B009PID1	71 B009	103 aa026
8 D1550008	40 B009PID2	72 B010	104 aa027
9 D1550009	41 A0553001	73 B011	105 aa028
10 D1550010	42 A0553002	74 B012	106 B029
11 D1550011	43 CNT_U1	75 B013	107 B030
12 D1550012	44 CNT_U2	76 B014	108 b031
13 D1550013	45 TIM_U1	77 CNT001	
14 D1550014	46 TIM_U2	78 TIM001	
15 D1550015	47 D0555001	79 ARM001	
16 D1550016	48 D0555002	80 DUMY01	
17 A1551001	49 D0555003	81 4B009	
18 A1553002	50 D0555004	82 4B010	
19 D0552001	51 D0555005	83 4B011	
20 D0552002	52 D0555006	84 4B012	
21 D0552003	53 D0555007	85 4B013	
22 D0552004	54 D0555008	86 4B014	
23 D0552005	55 D0555009	87 dummy1	
24 D0552006	56 D0555010	88 dummy2	
25 D0552007	57 D0555011	89 TIME136	
26 D0552008	58 D0555012	90 TIME137	
27 D0552009	59 D0555013	91 TIME138	
28 D0552010	60 D0555014	92 TIME139	
29 D0552011	61 D0555015	93 X015	
30 D0552012	62 D0555016	94 X016	
31 D0552013	63 A001	95 X017	
32 D0552014	64 A002	96 X018	

Dialog Box



Auto-start

Specify whether to open a specified screen when the CX-Process is started or to start normally. If the auto-start is enabled, the screen specified in the fields on the right will be displayed automatically when the CX-Process Monitor is started from the menus. (This eliminates the need to click the Start Button on the Main Window and click the Operator Button on the Mode Selection Dialog Box. The auto-start settings are saved when if the program is ended.

CRT-ID

Set the type of screen. 1: Overview, 2: Control, 3: Trend, 4: Graphic, 5: Annunciator, or 10: Tuning.

Group Number

The group number specifies the order of registration by the CRT builder.

Position

Specify the position on the function block diagram between 1 and 8. This setting is valid only for Tuning Screens.

Disabling Auto-start

The auto-start setting can be disabled by either of the following two methods.

- Double-click the MonitorCom.exe file from your Explorer to open the System Information settings and disable auto-starting under the *Auto-start* settings.
- Click the right mouse button at the top of an Overview Display and then click the Yes Button on the dialog box that will appear to open the System Information settings. Disable auto-starting under the *Auto-start* settings

Note The CRT-ID, group number, and position can be confirmed by clicking at the top of a screen as shown below.

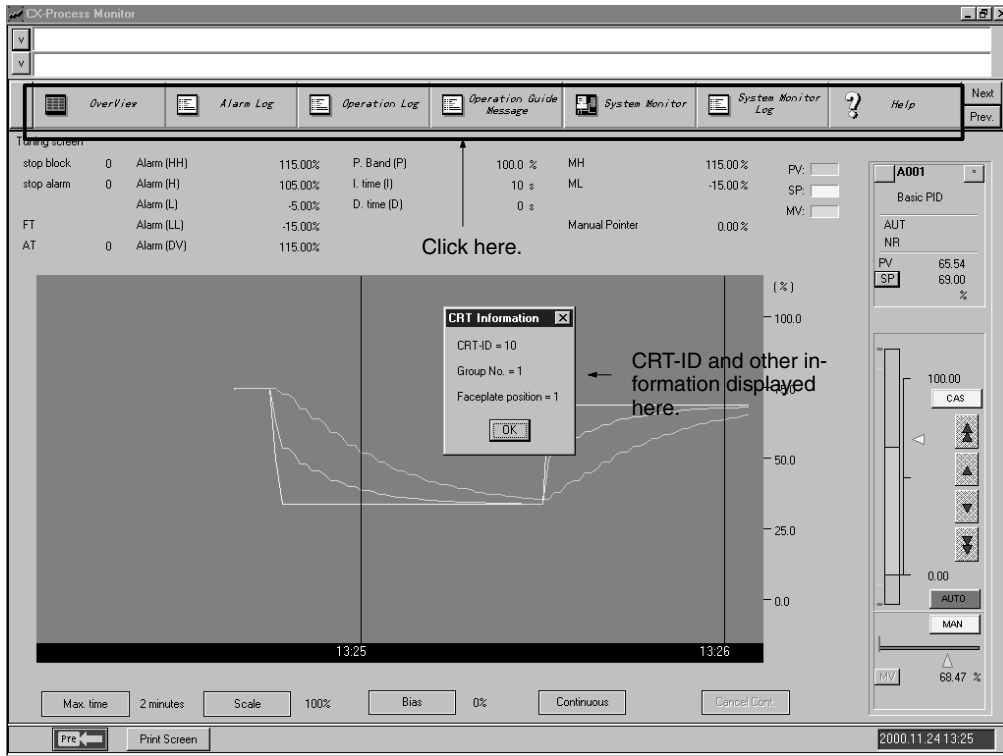

CSV File Auto-save Settings

If **Set auto-save of CSV file** is selected, the following screen will be displayed.

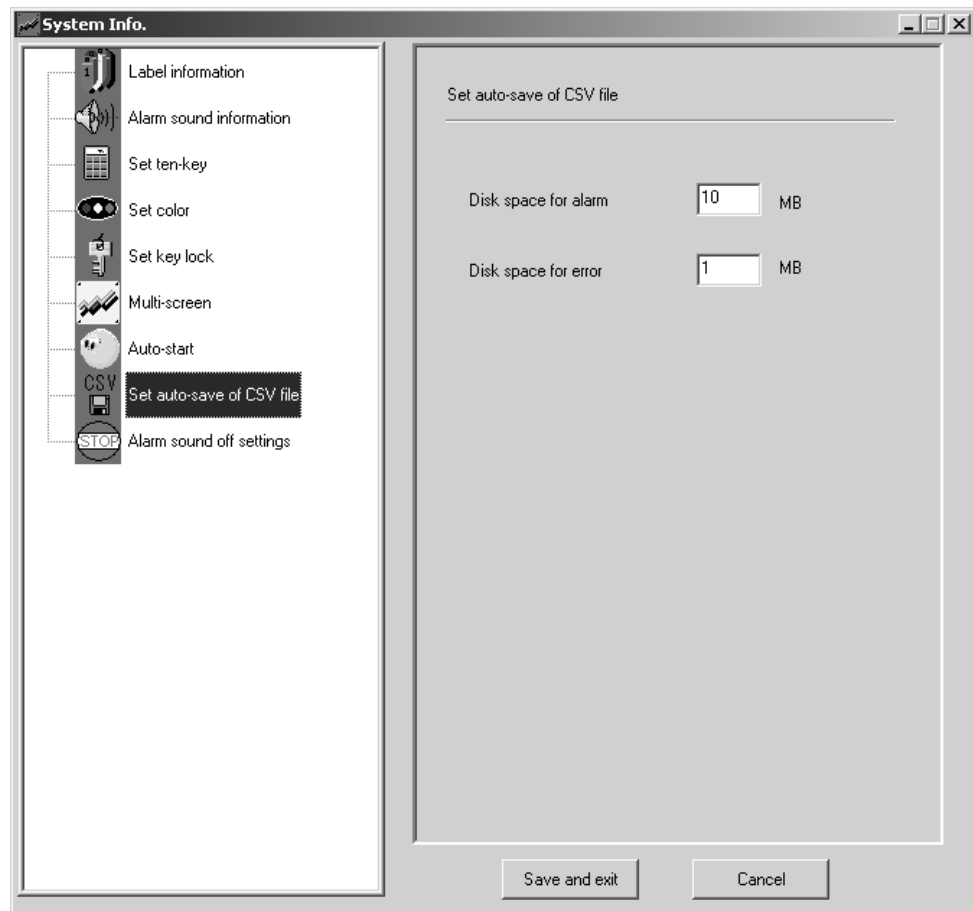

Set the amount of disk space at which to generate an alarm or error when the drive in which the CSV file is being saved starts becoming full. Setting the values as megabytes. An alarm or error will be generated when the drive set to save the CSV file in for Trend Screens reaches the specified level or lower.

The default for an alarm is 10 Mbytes and the default for an error is 1 Mbyte.

The CSV files will still be saved if an alarm occurs, but they will not be saved if an error occurs.

The CX-Process Monitor does not provide functions to delete or overwrite old files.

Note Although different drives can be set for the Trend Screens, the error and alarm settings are used for all of them.

4-7-1 Setting for Stopping Alarm Sound

Alarm Reset Settings

These settings specify whether or not an alarm sound will be produced when alarms are reset. There are separate settings for process alarms and system alarms.

- Process Alarms
An alarm message is displayed in the Alarm Log Screen.

- System Alarms

An alarm message is displayed in the System Monitor Screen.

Enable process alarm sounds to produce a sound when an alarm message is displayed in the Alarm Log Screen.

Enable system alarm sounds to produce a sound when an alarm message is displayed in the System Monitor Screen.

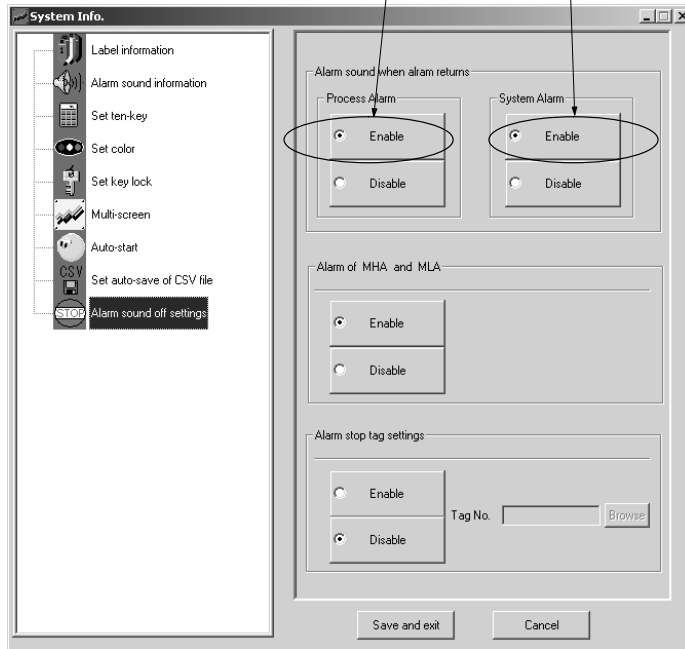

Both alarms are disabled by default.

Note When the alarm sound is disabled, no sound will be produced when the alarm is reset, but the alarm event will remain in the alarm log.

MHA and MLA Alarm Setting

This setting specifies whether or not the MHA and MLA ITEM tags are treated as alarms. If MHA and MLA are treated as alarms, an alarm event will be recorded in the Alarm Log when MHA or MLA goes ON. If the alarm output is disabled, alarm events will not remain in the Alarm Log.

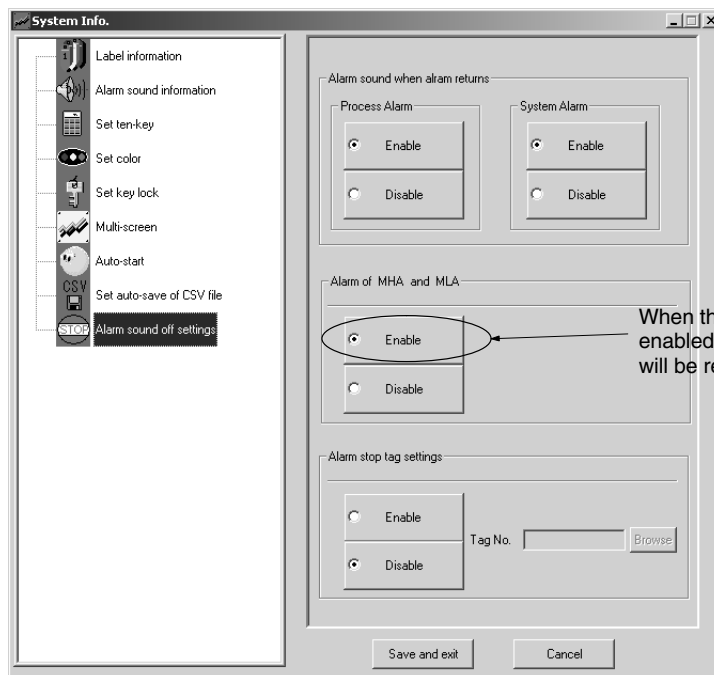

Alarm Stop Function

All alarm sounds can be silenced when the specified tag is ON.

When this function is enabled and the specified tag is ON, all alarm sounds (such as process alarms, system alarms, and annunciator alarms) will be stopped.

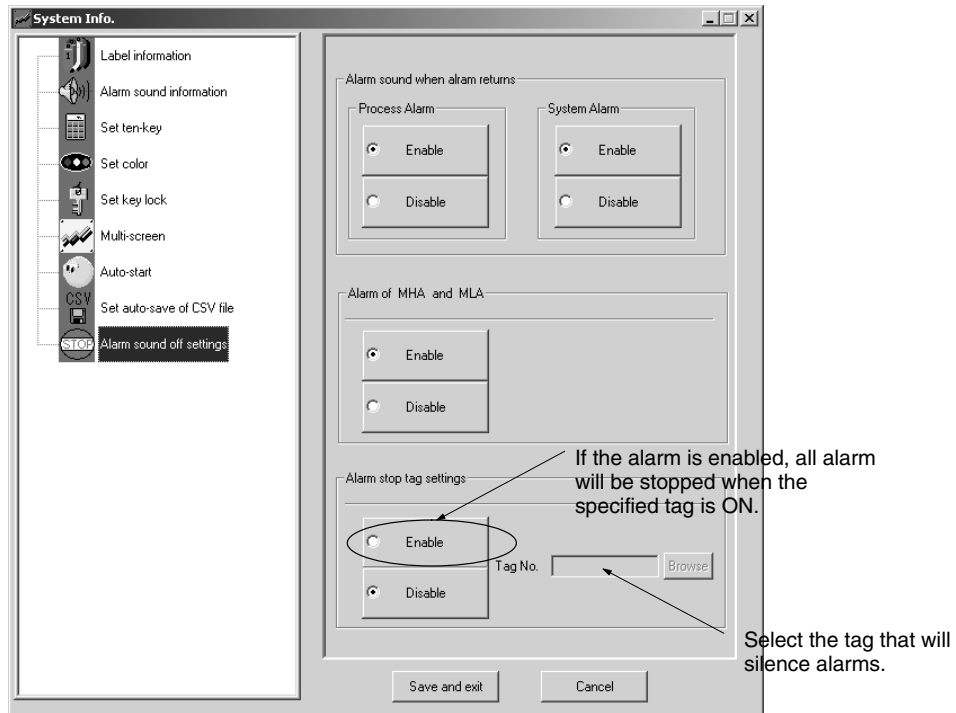

Setting the Alarm Stop Tag

Click the **Browse** Button next to the Tag Name field to display the following dialog box. Select the tag name of the tag that will control alarm sounds and click the **OK** Button.



Note The following dialog box will be displayed if a tag name longer than 8 characters is input directly into this field. In this case, input an existing tag name that is up to 8 characters long.

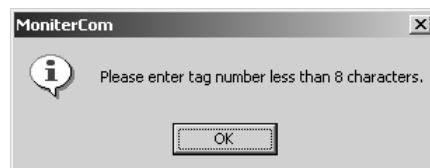

The following dialog box will be displayed if a non-existent tag name is input. In this case, click the **Browse** Button and select a tag name.



Time Chart of Alarm Stop Tag Operation

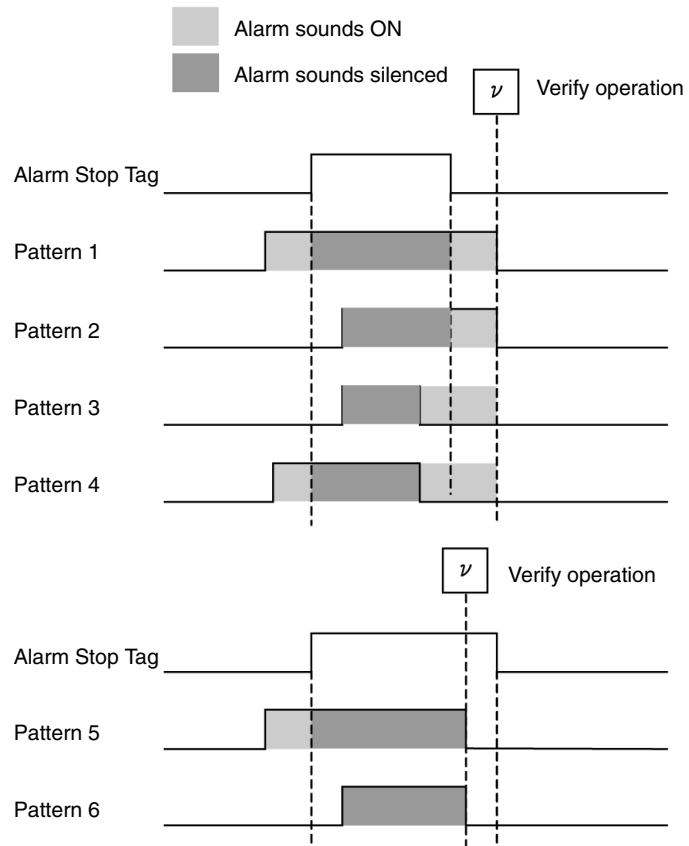

4-8 Checking Configurations

In Engineer Mode, start Monitor Process, and display the Overview Screen to check that the screen configurations have been set correctly.

Refer to 3-4 Overview Screen for details of operations in Monitor Screens selected from the Overview Screen.

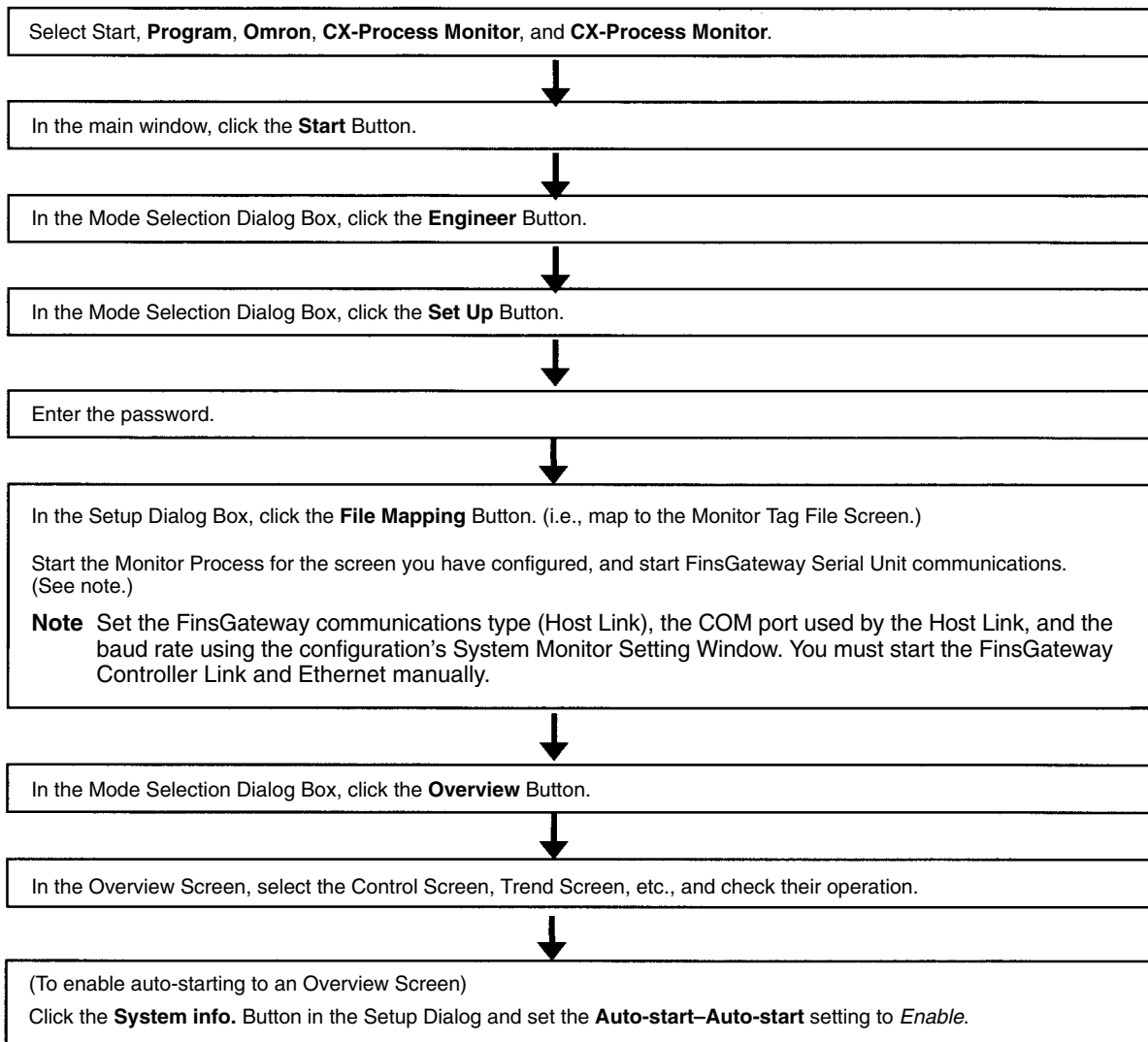

4-8-1 Starting the Monitor Process

Perform the following procedure to start the Monitor Process and display the Overview Screen.

- 1, 2, 3...**
1. Perform file mapping (using the Setup Dialog Box).
 2. Start the Monitor Process (using the Setup Dialog Box).
 3. Display the Overview Screen (Using the Mode Selection Dialog Box).
- Select the Monitor Screen you have created using the Overview Screen.

Note The above steps are not required if auto-starting has been set. Refer to 4-7 System Information Settings for details.

4-8-2 Executing File Mapping and Starting the Monitor Process

- 1, 2, 3...**
1. In the Mode Selection Dialog Box, click the **Set Up** Button.
The input password box will be displayed.
 2. Enter the password, and then click the **OK** Button.
The following Setup Dialog Box will be displayed.

3. Click the **File Mapping** Button.

Setup Dialog Box

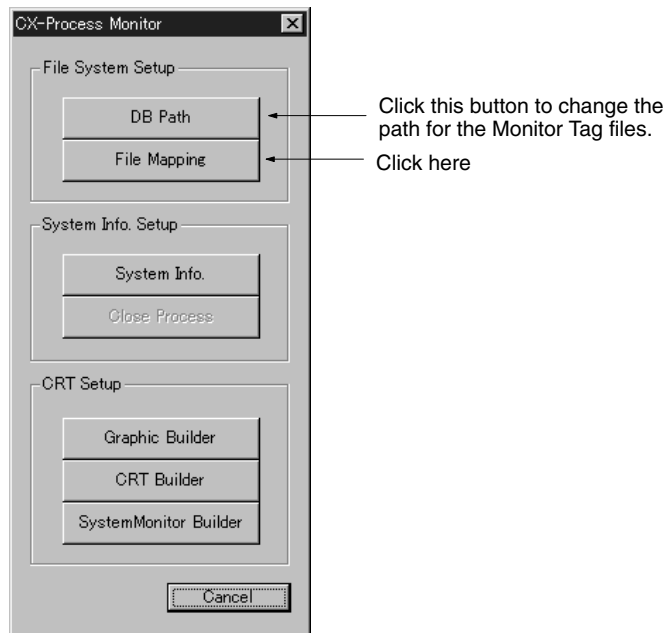

File Mapping will be performed.

When file mapping is completed, you can click the **Start Up** Button.

4. The Monitor Process will start and the Setup Dialog Box will be closed. Only if using Serial (i.e., Host Link) communications, FinsGateway Serial Unit communications with the PLC will start according to the following communications conditions set using the System Monitor Setting Window (using the System Monitor Builder Button in the Setup Dialog Box) at the same time as the Monitor Process starts. Unless **Initialize Serial Port** in the Serial Communications Detailed Settings Dialog Box is selected, however, communications will not start automatically. Refer to *4-4 System Monitor Settings* for details.

- Communications type: Serial (Host Link)
- COM port used and baud rate (if using Host Link)

Note a) PLC network address, node address, and Unit address communications are based upon the settings made using the CX-Process Tool (select **Settings, Network Settings**). (Set the node address and Unit address using the System Monitor Settings Window to use the System Monitor Screen).

- b) If using Controller Link or Ethernet, you must start FinsGateway communications manually. (Set Controller Link and Ethernet communications type using the System Monitor Settings Window to use the System Monitor Screen).

5. In the Setup Dialog Box, click the **OK** Button.

The Mode Selection Dialog Box will be displayed.

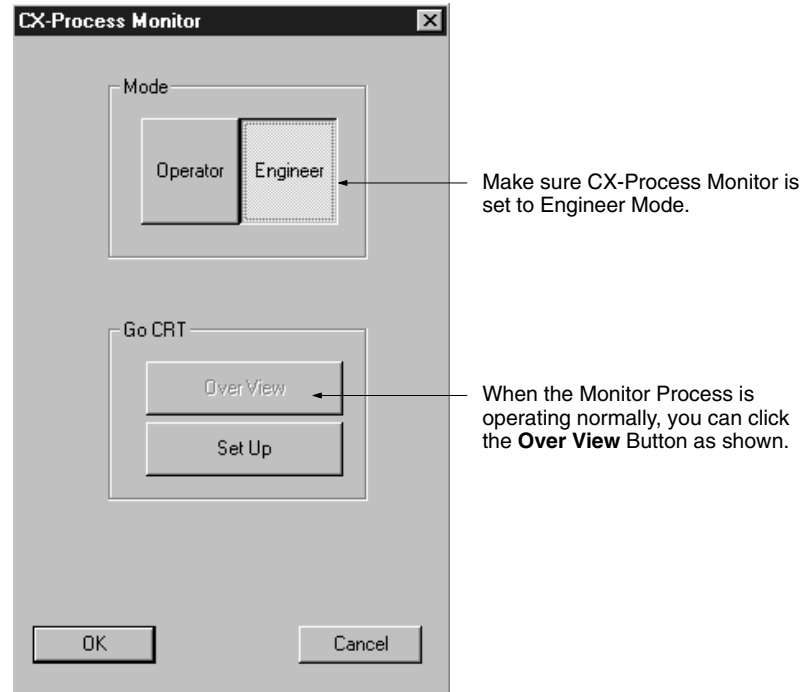

4-8-3 Displaying the Overview Screen

- 1, 2, 3...**
1. In the Mode Selection Dialog Box, click the **Overview** Button, as shown above.
The Overview Screen will be displayed, as shown in *3-4 Overview Screen*.
 2. Select the screens using the Overview Screen, and check that the screen settings are operating normally. Refer to *3-5 Screen Configuration* and later for details of each screen.

4-8-4 Setting the Auto-start Function

- 1, 2, 3...**
1. Click the **System Info.** Button in the Setup Dialog Box.
 2. Select **Auto-start.**
 3. Set **Auto-start** to *Enable*.

Note If the auto-start function is enabled, an Overview Screen will be displayed as soon as the CX-Process is started. The auto-start setting can be disabled by either of the following two methods.

- Double-click the MonitorCom.exe file from your Explorer to open the System Information settings and disable auto-starting under the *Auto-start* settings.
- Click the right mouse button at the top of an Overview Display and then click the Yes Button on the dialog box that will appear to open the System Information settings. Disable auto-starting under the *Auto-start* settings

4-8-5 Ending the Monitor Process

- 1, 2, 3...**
1. Click the **Set Up** Button in the Mode Selection Dialog Box.
 2. Input the password and click the **OK** Button.
The monitor process will be ended.

SECTION 5

Troubleshooting

This section describes errors that can occur while using the CX-Process Monitor.

The following table shows the causes of errors that may occur during CX-Process Monitor operations, and the action to take to clear the errors. Clear the cause of the error using the table below.

Phenomenon	Cause	Action
Even pressing the Operator Button, the Overview Screen is not displayed.	No tag numbers have been registered in the Monitor Tag Settings using CX-Process Tool.	Register the tag using CX-Process Tool, and then compile the Monitor Tags.
Even pressing the File Mapping Button, the Start Button remains disabled.		
Cannot display Tag numbers.		
The Loop Control Unit reads Information Not Refreshed in the System Monitor Screen.	The computer communications type setting in the System Monitor Builder Screen is incorrect.	Change the communications type setting.
	The Loop Control Unit's address in the System Monitor Screen's node settings and the actual Loop Control Unit's address do not agree.	Change the Loop Control Unit's address in the node settings to agree with the actual Loop Control Unit's address.
Error in Data Refresh Check is displayed in the System Monitor Messages.	If the communications type setting is CLK, the data link is stopped, or the FinsGateway CLK_UNIT communications setting is incorrect.	Reset the communications setting correctly using FinsGateway CLK_UNIT, or start the data link.
	The Monitor Tag settings between CX-Process Tool and CX-Process Monitor agree, but the Function Block data when the Monitor Tag settings were made using CX-Process Tool have not been downloaded to the Loop Control Unit.	Download the Function Block from when the Tags were set using CX-Process Tool to the Loop Control Unit, and restart the Loop Control Unit.
	Power supply to the PLC Unit is turned OFF.	Turn ON the power supply to the PLC Unit.
	Communications cable is not connected.	Connect the communications cable.
Cannot move from the Overview Screen to the Control Screens or Tuning Screens.	The Tag name registered using CX-Process Tool is not set correctly in CX-Process Monitor.	Reset the Tags using the Graphic Builder Screen and the CRT Builder Screen.
Error in Data Link Status Communications is displayed in the System Monitor Messages.	If the communications type setting is CLK, the FinsGateway CLK_UNIT communications setting is incorrect.	Reset the communications settings correctly using FinsGateway CLK_UNIT.
	If the communications type setting is not CLK, the power supply to the PLC is turned OFF, or the communications cable is not connected.	Turn ON the power supply to the PLC Unit, or connect the communications cable.
The message dialog box Could Not Initialize FinsGateway is displayed.	FinsGateway Serial Unit initialization failed. (i.e., network address set using CX-Process Tool and FinsGateway Serial Unit network address do not agree.)	<ol style="list-style-type: none"> 1. Make sure the network address set using CX-Process Tool, and FinsGateway Serial Unit network address agree. 2. Compile the Monitor Tags, and then reset the node PLC using the System Monitor Builder Screen. 3. (If the above two actions fail) Clear the Initialize Serial Port check box using the System Monitor Builder Screen.

Phenomenon	Cause	Action
Definitions Don't Agree With System is displayed in the System Monitor Messages.	The actual Loop Control Unit in the System Monitor Builder Screen has not been set using the System Monitor Builder.	Register the actual Loop Control Unit using all the System Monitor Builders.
	The network address when the Tag settings were made using CX-Process Tool, and the node address settings, do not agree with the actual Unit.	<ol style="list-style-type: none"> 1. Make sure the network address and node address set using CX-Process tool, and the actual node address agree. 2. Compile the monitor Tags using CX-Process Tool, and then reset the node PLC using the System Monitor Builder Screen.
The message dialog box Could Not Get System Information is displayed.	FinsGateway is not started.	Start FinsGateway.
	The network address and node address set using CX-Process Tool are different from the network address and node address set using FinsGateway.	<ol style="list-style-type: none"> 1. Make sure the network address and node address set using CX-Process tool, and the actual node address agree. 2. Compile the monitor Tags using CX-Process Tool, and then reset the node PLC using the System Monitor Builder Screen.
Block Execution Error is displayed in the System Monitor Messages.	An execution error has occurred in the Function Block data downloaded to the Loop Control Unit.	<ol style="list-style-type: none"> 3. Click the E Button on the Loop Control Unit in the System Monitor Screen. 4. Click the Execution Error Button in the Function Block Error Dialog Box. 5. Check the Execution error's Function Block using the Details Of Function Block Error Dialog Box. 6. Correct the settings for the relevant Function Block using CX-Process Tool.
Unit Address Setting Disagrees With Actual Unit Number is displayed in the System Monitor Messages.	The actual Loop Control Unit's address and the node PLC's Unit address in the System Monitor Builder Screen do not agree.	Make sure the actual Loop Control Unit's address and the System Monitor Builder's node PLC Unit's address agree.
ERROR CODE: is displayed during Loop Control Unit Run/stop in the System Monitor Screen.	The FinsGateway setting or the network setting is incorrect.	Correct the FinsGateway setting and the network settings.

Appendix A

Reading/Writing Function Block ITEMS

The following tables show which Tag ITEMS of Function Blocks that are specified as sources using either 1-Block or 4-Block Send Terminal to Computer can be monitored/set with CX-Process Monitor.

For each of the Function Blocks, it is necessary to have specified CX-Process Monitor as the send destination using 1-Block or 4-Block Send Terminal to Computer as shown below.

O: Specification possible; –: Specification not possible

Function Blocks	1-Block Send Terminal to Computer (Block Model 403)	4-Block Send Terminal to Computer (Block Model 404)
Basic PID (Block Model 011)	O	O
Advanced PID (Block Model 012)	O	O
2-position ON/OFF (Block Model 001)	O	O
3-position ON/OFF (Block Model 002)	O	O
Blended PID (Block Model 013)	O	–
Batch Flowrate Capture (Block Model 014)	O	–
Indication and Setting (Block Model 031)	O	O
Indication and Operation (Block Model 032)	O	O
Ratio Setting (Block Model 033)	O	O
Indicator (Block Model 034)	O	O
High/Low Alarm (Block Model 111)	–	O
Segment Program 2 (Block Model 157)	–	O
ON/OFF Valve Manipulator (Block Model 221)	–	O
Motor Manipulator (Block Model 222)	–	O
Reversible Motor Manipulator (Block Model 223)	–	O
Motor Opening Manipulator (Block Model 224)	–	O
Timer (Block Model 205)	–	O
Counter (Block Model 208)	–	O

Basic PID (Block Model 011)

ITEM type	ITEM	Tag ITEM	Data description	Data range	CX-Process Monitor screen (R:Read W:Write)						
					Overview Screen	Control Screens	Tuning Screens	Trend Screens	Graphic Screens	Annunciator Screens	Alarm Log Screens
Contact input	000	MT_ST	Stop block operation command(0: Cancel stop, 1: Stop)	0 or 1	R (Color)	R (Color)	R/W	R	R	R	
Analog input	007	PV	PV input	–15.00 to +115.00%		R	R	R	R		
Parameter	008	HH_SP	High/high alarm setting	–15.00 to +115.00%		R (– only)	R/W	R	R/W		
	009	H_SP	High alarm setting	–15.00 to +115.00%		R (– only)	R/W	R	R/W		
	010	L_SP	Low alarm setting	–15.00 to +115.00%		R (– only)	R/W	R	R/W		
	011	LL_SP	Low/low alarm setting	–15.00 to +115.00%		R (– only)	R/W	R	R/W		
Contact output	013	HH	High/high alarm output	0 or 1	R (Color)	R	R	R	R	R	R
	014	H	High alarm output	0 or 1	R (Color)	R	R	R	R	R	R
	015	L	Low alarm output	0 or 1	R (Color)	R	R	R	R	R	R

ITEM type	ITEM	Tag ITEM	Data description	Data range	CX-Process Monitor screen (R:Read W:Write)						
					Overview Screen	Control Screens	Tuning Screens	Trend Screens	Graphic Screens	Annun- ciator Screens	Alarm Log Screens
Contact output	016	LL	Low/low alarm output	0 or 1	R (Color)	R	R	R	R	R	R
	017	ALM_OFF	Alarm stop switch 0: Alarm, 1: Stop	0 or 1	R (Color)	R	R/W	R	R/W	R	
Parameter	019	PV_ABN	PV execution error display 0: Normal, 1: Error → MANUAL mod	0 or 1		R	R	R	R	R	R
	023	SP	Local Set Point setting	-15.00 to +115.00%		W	W		W		
	024	CAS_SET	Set Point setting mode 0: Local only 1: Remote/Local	0 or 1		R	R	R	R		
	026	R/L_SW	Remote/Local switch 0: Local 1: Remote Note: Valid only when ITEM024 is 1	0 or 1		R/W	R/W	R	R/W	R	
Analog output	029	SP	Current Set Point output	-15.00 to +115.00%		R	R	R	R		
Parameter	035	AT	AT command/AT Executing	0.1			R/W	R	R/W	R	R
	041	DVA_SP	Deviation alarm setting (Hysteresis is set at ITEM012.)	0 to 115.00%		R	R/W	R	R/W		
Contact output	042	DVA	Deviation alarm output	0 or 1		R	R	R	R	R	R
Parameter	054	P	Proportional band	0.1 to 999.9%			R/W	R	R/W		
	055	I	Integral time (0: No integral action)	0 to 9999 s			R/W	R	R/W		
	056	D	Differential time (0: No differential action)	0 to 9999 s			R/W	R	R/W		
	076	MH_LMT	High MV limit	±320.00%		R	R/W	R	R/W		
	077	ML_LMT	Low MV limit	±320.00%		R	R/W	R	R/W		
Contact output	078	MHA	MV upper limit output value 1: Upper limit or more 0: Less than upper limit	0 or 1	R		R	R	R	R	
	079	MLA	MV lower limit output value 1: Lower limit or less 0: Greater than lower limit	0 or 1	R		R	R	R	R	
Contact input	086	A/M_SW	Auto/Manual switch 0: Manual, 1: Auto	0 or 1		R/W	R/W	R	R/W	R	
Parameter	089	MV	Host display of MV	±320.00%		R/W	R/W	R	R/W		
	091	MV_ABN	MV execution error display 0: Normal, 1: Error	0 or 1				R	R	R	R
	098	MV_IDX	MV execution error display 0: Normal, 1: Error	-15.00 to +115.00%		R	R/W	R	R/W		
	099	OP_MK	Label	0 to 15		R/W	R/W	R	R/W		

Advanced PID (Block Model 012)

ITEM type	ITEM	Tag ITEM	Data description	Data range	CX-Process Monitor screen (R:Read W:Write)						
					Overview Screen	Control Screens	Tuning Screens	Trend Screens	Graphic Screens	Annun- ciator Screens	Alarm Log Screens
Contact input	000	MT_ST	Stop block operation command(0: Cancel stop, 1: Stop)	0 or 1	R (Color)	R (Color)	R/W	R	R	R	
Analog input	007	PV	PV input	-15.00 to +115.00%		R	R	R	R		
Parameter	008	HH_SP	High/high alarm setting	-15.00 to +115.00%		R (- only)	R/W	R	R/W		
	009	H_SP	High alarm setting	-15.00 to +115.00%		R (- only)	R/W	R	R/W		
	010	L_SP	Low alarm setting	-15.00 to +115.00%		R (- only)	R/W	R	R/W		
	011	LL_SP	Low/low alarm setting	-15.00 to +115.00%		R (- only)	R/W	R	R/W		
Contact output	013	HH	High/high alarm output	0 or 1	R (Color)	R	R	R	R	R	R
	014	H	High alarm output	0 or 1	R (Color)	R	R	R	R	R	R
	015	L	Low alarm output	0 or 1	R (Color)	R	R	R	R	R	R
	016	LL	Low/low alarm output	0 or 1	R (Color)	R	R	R	R	R	R
Contact input	017	ALM_OF F	Alarm stop switch 0: Alarm, 1: Stop	0 or 1		R (Color)	R/W	R	R/W	R	
Parameter	019	PV_ABN	PV execution error display 0: Normal, 1: Error → MANUAL mode	0 or 1			R	R	R	R	R
	023	SP	Local Set Point setting	-15.00 to +115.00%		W	W		W		
	024	CAS_SE T	Set Point setting mode (default)0: Local only1: Remote/Local Note: Setting to 0 invalidates ITEM026.	0 or 1		R	R	R	R		
	026	R/L_SW	Remote/Local switch 0: Local, 1: Remote Note: Valid only when ITEM024 is 1	0 or 1		R/W	R/W		R/W	R	
Analog output	029	SP	Current Set Point output	-15.00 to +115.00%		R	R	R	R		
Parameter	035	AT	AT command/AT Executing	0.1			R/W	R	R/W	R	R
	041	DVA_SP	Deviation alarm setting (Hysteresis is set at ITEM012.)	0 to 115.00%			R/W	R	R/W		
Contact output	042	DVA	Deviation alarm output	0 or 1	R	R	R	R	R	R	R
Parameter	054	P	Proportional band	0.1 to 999.9%			R/W	R	R/W		
	055	I	Integral time (0: No integral action)	0 to 9999 s			R/W	R	R/W		
	056	D	Differential time (0: No differential action)	0 to 9999 s			R/W	R	R/W		
	076	MH_LMT	High MV limit	±320.00%		R	R/W	R	R/W		
	077	ML_LMT	Low MV limit	±320.00%		R	R/W	R	R/W		

ITEM type	ITEM	Tag ITEM	Data description	Data range	CX-Process Monitor screen (R:Read W:Write)						
					Overview Screen	Control Screens	Tuning Screens	Trend Screens	Graphic Screens	Annun- ciator Screens	Alarm Log Screens
Contact output	078	MHA	High MV limit arrival output 1: Limit or more, 0: Less than limit	0 or 1	R		R	R	R	R	
Contact output	079	MLA	Low MV limit arrival output 1: Limit or less, 0: Not limit or less	0 or 1	R		R	R	R	R	
Contact input/parameter	086	A/M_SW	Auto/Manual switch 0: Manual, 1: Auto	0 or 1		R/W	R/W	R	R/W	R	
Parameter	089	MV	Host display of MV	±320.00%		R/W	R/W	R	R/W		
	091	MV_ABN	MV execution error display 0: Normal, 1: Error	0 or 1		R	R	R	R	R	R
	098	MV_IDX	MV index position	-15.00 to +115.00%		R	R/W	R	R/W		
	099	OP_MK	Label	0 to 15		R/W	R/W	R	R/W		

2-position ON/OFF (Block Model 001)

ITEM type	ITEM	Tag ITEM	Data description	Data range	CX-Process Monitor screen (R:Read W:Write)						
					Overview Screen	Control Screens	Tuning Screens	Trend Screens	Graphic Screens	Annunciator Screens	Alarm Log Screens
Contact input	000	MT_ST	Stop block operation command(0: Cancel stop, 1: Stop)	0 or 1	R (Color)	R (Color)	R/W	R	R	R	
Analog input	007	PV	PV input	-15.00 to +115.00%		R	R	R	R		
Parameter	008	HH_SP	High/high alarm setting	-15.00 to +115.00%		R	R/W	R	R/W		
	009	H_SP	High alarm setting	-15.00 to +115.00%		R	R/W	R	R/W		
	010	L_SP	Low alarm setting	-15.00 to +115.00%		R	R/W	R	R/W		
	011	LL_SP	Low/low alarm setting	-15.00 to +115.00%		R	R/W	R	R/W		
	041	DVA_SP	Deviation alarm setting	0 to 115.00%		R	R/W	R	W		
Contact output	013	HH	High/high alarm output	0 or 1	R (Color)	R (Color)	R (Color)	R	R	R	R
	014	H	High alarm output	0 or 1	R (Color)	R (Color)	R (Color)	R	R	R	R
	015	L	Low alarm output	0 or 1	R (Color)	R (Color)	R (Color)	R	R	R	R
	016	LL	Low/low alarm output	0 or 1	R (Color)	R (Color)	R (Color)	R	R	R	R
	042	DVA	Deviation alarm output	0 or 1	R (Color)	R (Color)	R (Color)	R	R	R	R
Contact input	017	ALM_OFF	Alarm stop switch	0 or 1	R (Color)		R/W				
Parameter	019	PV_ABN	PV execution error display	0 or 1			R	R	R	R	R
	023	SP	Local Set Point setting	-15.00 to +115.00%		W	W		W		
	024	CAS_SET	Set Point setting mode	0 or 1		R	R	R	R		
	026	R/L_SW	Remote/Local switch	0 or 1		R/W	R/W	R	R/W	R	
Analog output	029	SP	Current Set Point output	-15.00 to +115.00%		R	R	R	R		
Parameter	093	MV	Host display of MV	0 or 1		R/W	R/W	R	R/W		
	099	OP_MK	Label	0 to 15		R/W	R/W	R	R/W		

3-position ON/OFF (Block Model 002)

ITEM type	ITEM	Tag ITEM	Data description	Data range	CX-Process Monitor screen (R:Read W:Write)						
					Overview Screen	Control Screens	Tuning Screens	Trend Screens	Graphic Screens	Annun- ciator Screens	Alarm Log Screens
Contact input	000	MT_ST	Stop block operation command(0: Cancel stop, 1: Stop)	0 or 1	R (Color)	R (Color)	R/W	R	R	R	
Analog input	007	PV	PV input	-15.00 to +115.00%		R	R	R	R		
Parameter	008	HH_SP	High/high alarm setting	-15.00 to +115.00%		R	R/W	R	R/W		
	009	H_SP	High alarm setting	-15.00 to +115.00%		R	R/W	R	R/W		
	010	L_SP	Low alarm setting	-15.00 to +115.00%		R	R/W	R	R/W		
	011	LL_SP	Low/low alarm setting	-15.00 to +115.00%		R	R/W	R	R/W		
	041	DVA_SP	Deviation alarm setting	0 to 115.00%		R	R/W	R	R/W		
Contact output	013	HH	High/high alarm output	0 or 1	R (Color)	R (Color)	R (Color)	R	R	R	R
	014	H	High alarm output	0 or 1	R (Color)	R (Color)	R (Color)	R	R	R	R
	015	L	Low alarm output	0 or 1	R (Color)	R (Color)	R (Color)	R	R	R	R
	016	LL	Low/low alarm output	0 or 1	R (Color)	R (Color)	R (Color)	R	R	R	R
	042	DVA	Deviation alarm output	0 or 1	R (Color)	R (Color)	R (Color)	R	R	R	R
Contact input	017	ALM_OF F	Alarm stop switch	0 or 1	R (Color)	R (Color)	R/W	R	R/W		
Parameter	019	PV_ABN	PV execution error display	0 or 1				R	R	R	R
	023	SP	Local Set Point setting	-15.00 to +115.00%		W	W		W		
	024	CAS_SE T	Set Point setting mode	0 or 1		R	R	R	R		
	026	R/L_SW	Remote/Local switch	0 or 1		R/W	R/W	R	R/W	R	
Analog output	029	SP	Current Set Point output	-15.00 to +115.00%		R	R	R	R		
	093	MVH	Host display of MVH	0 or 1		R/W	R/W	R	R/W		
	095	MVL	Host display of MVL	0 or 1		R/W	R/W	R	R/W		
Parameter	099	OP_MK	Label	0 to 15		R/W	R/W	R	R/W		

Blended PID (Block Model 013)

ITEM type	ITEM	Tag ITEM	Data description	Data range	CX-Process Monitor screen (R:Read W:Write)						
					Overview Screen	Control Screens	Tuning Screens	Trend Screens	Graphic Screens	Annun- ciator Screens	Alarm Log Screens
Contact input	000	MT_ST	Stop block operation command(0: Cancel stop, 1: Stop)	0 or 1	R (Color)	R (Color)	R	R	R		
Analog input	007	PV	PV input	0 to 9999		R	R	R	R		
Parameter	027	K1	Ratio	0 to 3.2000			R/W	R	R/W		
Accumulated value output	012	Q1	Accumulated value	0 to 9999			R	R	R		
	013	Q2	Accumulated value	0 to 9999			R	R	R		
Analog output	016	Y1	Instantaneous value output	0 to 320.00%		R	R	R	R		
	029	Y2	Current Set Point instantaneous value output	0 to 320.00%		R	R	R	R		
Parameter	031		Cumulative deviation High/high alarm output	±320.00%			R/W	R	R/W		
	032		Cumulative deviation High alarm setting	±320.00%			R/W	R	R/W		
	033		Cumulative deviation Low alarm setting	±320.00%			R/W	R	R/W		
	034		Cumulative deviation Low/low alarm setting	±320.00%			R/W	R	R/W		
Contact output	036	DHH	Cumulative deviation High/high alarm output	0 or 1	R (Color)	R (Color)	R (Color)	R	R	R	R
	037	DH	Cumulative deviation High alarm output	0 or 1	R (Color)	R (Color)	R (Color)	R	R	R	R
	038	DL	Cumulative deviation Low alarm output	0 or 1	R (Color)	R (Color)	R (Color)	R	R	R	R
	039	DLL	Cumulative deviation Low/low alarm output	0 or 1	R (Color)	R (Color)	R (Color)	R	R	R	R
Contact input	017	ALM_OF F	Alarm stop switch	0 or 1	R (Color)	R (Color)	R/W	R	R/W		
	014	S1	Counter reset	0 or 1			R/W	R	R/W		
Parameter	054	P	Proportional band	0.1 to 999.9%			R/W	R	R/W		
	055	I	Integral time	0 to 9999 s			R/W	R	R/W		
	056	D	Differential time	0 to 9999 s			R/W	R	R/W		
	076	MH_LMT	High MV limit	±320.00%			R/W	R	R/W		
	077	ML_LMT	Low MV limit	±320.00%			R/W	R	R/W		
Contact input	086	A/M_SW	Auto/Manual switch	0 or 1		R/W	R/W	R	R/W		
Parameter	089	MV	Host display of MV	±320.00%		R/W	R/W	R	R/W		
	091	MV_ABN	MV error display 0: Normal, 1: Error	0 or 1				R	R	R	R
	098	MV_IDX	MV index position	-15.00 to +115.00%		R	R/W	R	R/W		
	099	OP_MK	Label	0 to 15		R/W	R/W	R	R/W		

Batch Flowrate Capture (Block Model 014)

ITEM type	ITEM	Tag ITEM	Data description	Data range	CX-Process Monitor screen (R:Read W:Write)							
					Overview Screen	Control Screens	Tuning Screens	Trend Screens	Graphic Screens	Annun- ciator Screens	Alarm Log Screens	
Contact input	000	MT_ST	Stop block operation command(0: Cancel stop, 1: Stop)	0 or 1	R (Color)	R (Color)	R/W	R	R	R		
Accumulated value input	007	P1	PV input	0 to 9999				R	R			
Accumulated value output	012	Q1	Accumulated value (lower 4 digits)	0000 to 9999			R	R	R			
	013	Q2	Accumulated value (upper 4 digits)	0000 to 9999			R	R	R			
Contact input	014	S3	Accumulation counter reset switch (1: Reset)	0 or 1			R/W	R	R/W			
Analog output	016	Y1	Instantaneous value output	0 to 320.00%		R	R	R	R			
Parameter	023	SP	Local SP setting	0 to 9999		W	W		W			
Contact input/parameter	026	R/L_SW	Remote/Local switching 0: Local, 1: Remote	0 or 1		R/W	R/W	R	R/W	R		
Accumulated value output	029	SP	Current Set Point output	0 to 9999		R	R	R	R			
	032	B0	Overrun setting (value subtracted from BM)	0 to 9999			R/W	R	R/W			
	033	BP	Pre-batch setting (value subtracted from BM)	0 to 9999			R/W	R	R/W			
	034	B1	Flowrate limitation	0 to 9999			R/W	R	R/W			
Analog output	035	SM	Batch accumulated value (lower 4 digits) Fixed value	0000 to 9999		R	R	R	R/W			
Contact input	036	S1	Run switch (0: Reset, 1: Run)	0 or 1		R/W	R/W	R	R/W	R		
	037	S2	Control interrupt switch (1: Interrupt)	0 or 1		R/W	R/W	R	R/W	R		
Contact output	038	U1	Main batch output	0 or 1		R	R	R	R/W	R		
	039	U2	Pre-batch output	0 or 1		R	R	R	R/W	R		
Contact input/parameter	086	A/M_SW	SW 0: Manual, 1: Auto	0 or 1		R/W	R/W	R	R/W	R		
Parameter	089	MV	Host display of MV	±320.00%		R/W	R/W	R	R/W			
	091	MV_ABN	MV error display 0: Normal, 1: Error	0 or 1		R	R	R	R	R	R	
	098	MV_IDX	MV index position	-15 to 115.00%		R	R/W	R	R/W			
	099	OP_MK	Label	0 to 15		R/W	R/W	R	R/W			

Indication and Setting (Block Model 031)

ITEM type	ITEM	Tag ITEM	Data description	Data range	CX-Process Monitor screen (R:Read W:Write)						
					Overview Screen	Control Screens	Tuning Screens	Trend Screens	Graphic Screens	Annunciator Screens	Alarm Log Screens
Contact input	000	MT_ST	Stop block operation command(0: Cancel stop, 1: Stop)	0 or 1	R (Color)	R (Color)	R/W	R	R	R	
Analog input	007	PV	PV input	-15.00 to +115.00%		R	R	R	R		
Parameter	008	HH_SP	High/high alarm setting	-15.00 to +115.00%		R (- only)	R/W	R	R/W		
	009	H_SP	High alarm setting	-15.00 to +115.00%		R (- only)	R/W	R	R/W		
	010	L_SP	Low alarm setting	-15.00 to +115.00%		R (- only)	R/W	R	R/W		
	011	LL_SP	Low/low alarm setting	-15.00 to +115.00%		R (- only)	R/W	R	R/W		
Contact output	013	HH	High/high alarm output	0 or 1	R (Color)	R	R	R	R	R	R
	014	H	High alarm output	0 or 1	R (Color)	R	R	R	R	R	R
	015	L	Low alarm output	0 or 1	R (Color)	R	R	R	R	R	R
	016	LL	Low/low alarm output	0 or 1	R (Color)	R	R	R	R	R	R
Contact input	017	ALM_OF F	Alarm stop switch 0: Alarm, 1: Stop	0 or 1	R (Color)		R/W	R	R/W	R	
Parameter	019	PV_ABN	PV error display 0: Normal, 1: Error	0 or 1			R	R	R	R	R
	023	SP	Local Set Point setting	-15.00 to +115.00%		W	W		W		
	024	CAS_SE T	Set Point setting mode	0 or 1		R/W	R	R	R	R	
Contact input/parameter	026	R/L_SW	Remote/Local switch	0 or 1			R/W	R	R/W	R	
Analog output	029	SP	Current Set Point output	-15.00 to +115.00%		R	R	R	R		
Parameter	099	OP_MK	Label	0 to 15		R/W	R/W	R	R/W		

Indication and Operation (Block Model 032)

ITEM type	ITEM	Tag ITEM	Data description	Data range	CX-Process Monitor screen (R:Read W:Write)						
					Overview Screen	Control Screens	Tuning Screens	Trend Screens	Graphic Screens	Annun- ciator Screens	Alarm Log Screens
Contact input	000	MT_ST	Stop block operation command(0: Cancel stop, 1: Stop)	0 or 1	R (Color)	R (Color)	R/W	R	R	R	
Analog input	007	PV	PV input	-15.00 to +115.00%		R	R	R	R/W		
Parameter	008	HH_SP	High/high alarm setting	-15.00 to +115.00%		R (- only)	R/W	R	R/W		
	009	H_SP	High alarm setting	-15.00 to +115.00%		R (- only)	R/W	R	R/W		
	010	L_SP	Low alarm setting	-15.00 to +115.00%		R (- only)	R/W	R	R/W		
	011	LL_SP	Low/low alarm setting	-15.00 to +115.00%		R (- only)	R/W	R	R/W		
Contact output	013	HH	High/high alarm output	0 or 1	R (Color)	R	R	R	R	R	R
	014	H	High alarm output	0 or 1	R (Color)	R	R	R	R	R	R
	015	L	Low alarm output	0 or 1	R (Color)	R	R	R	R	R	R
	016	LL	Low/low alarm output	0 or 1	R (Color)	R	R	R	R	R	R
Contact input	017	ALM_OF F	Alarm stop switch 0: Alarm, 1: Stop	0 or 1	R (Color)		R/W	R	R/W	R	
Parameter	019	PV_ABN	PV error display 0: Normal, 1: Error	0 or 1			R	R	R	R	R
Parameter	076	MH_LMT	High MV limit	±320.00%		R	R/W	R	R/W		
	077	ML_LMT	Low MV limit	±320.00%		R	R/W	R	R/W		
	078	MHA	MV upper limit output value 1: Upper limit or more 0: Less than upper limit	0 or 1	R		R	R	R	R	
	079	MLA	MV lower limit output value 1: Lower limit or less 0: Greater than lower limit	0 or 1	R		R	R	R	R	
Analog input	084	X1	Auto input	±320.00%		R	R	R	R		
Contact input	086	A/M_SW	Auto/Manual switch 0: Manual, 1: Auto	0 or 1		R/W	R/W	R	R/W	R	
Parameter	089	MV	Inversion of host display of MV	±320.00%		R/W	R/W	R	R/W		
	091	MV_ABN	MV execution error display 0: Normal, 1: Error	0 or 1		R	R	R	R	R	R
	098	MV_IDX	MV index position	-15.00 to +115.00%		R	R/W	R	R/W		
	099	OP_MK	Label	0 to 15		R/W	R/W	R	R/W		

Ratio Setting (Block Model 033)

ITEM type	ITEM	Tag ITEM	Data description	Data range	CX-Process Monitor screen (R:Read W:Write)						
					Overview Screen	Control Screens	Tuning Screens	Trend Screens	Graphic Screens	Annunciator Screens	Alarm Log Screens
Contact input	000	MT_ST	Stop block operation command(0: Cancel stop, 1: Stop)	0 or 1	R (Color)	R (Color)	R/W	R	R	R	
Analog input	007	PV	Reference input	-15.00 to +115.00%		R	R	R	R		
Parameter	019	PV_ABN	PV error display 0: Normal, 1: Error	0 or 1			R	R	R	R	R
	023	SP	Local ratio setting	-15.00 to +115.00%		R/W	R/W	R	R		
Contact input	024	CAS_SE T	Ratio setting mode 0: Local only 1: Remote/Local	0 or 1			R	R	R	R	
	026	R/L_SW	Remote/Local switch 0: Local, 1: Remote	0 or 1		R/W	R/W	R	R/W	R	
Parameter	054	K1	Ratio range (sets signal ratio range corresponding to Set Point=100%)	±10.000			R/W	R	R/W		
	055	A1	Input bias	±320.00%			R/W	R	R/W		
	056	B1	Output bias	±320.00%			R/W	R	R/W		
	076	MH_LMT	High MV limit	±320.00%		R	R/W	R	R/W		
	077	ML_LMT	Low MV limit	±320.00%		R	R/W	R	R/W		
Contact input	086	A/M_SW	Auto/Manual switch 0: Manual, 1: Auto	0 or 1		R/W	R/W	R	R/W	R	
Parameter	089	MV	Host display of MV	±320.00%		R/W	R/W	R	R/W		
	091	MV_ABN	MV error display 0: Normal, 1: Error	0 or 1		R	R	R	R	R	R
	098	MV_IDX	MV index position	-15.00 to +115.00%		R	R/W	R	R/W		
	099	OP_MK	Label	0 to 15		R/W	R/W	R	R/W		

Indicator (Block Model 034)

ITEM type	ITEM	Tag ITEM	Data description	Data range	CX-Process Monitor screen (R:Read W:Write)						
					Overview Screen	Control Screens	Tuning Screens	Trend Screens	Graphic Screens	Annun- ciator Screens	Alarm Log Screens
Contact input	000	MT_ST	Stop block operation command(0: Cancel stop, 1: Stop)	0 or 1	R (Color)	R (Color)	R/W	R	R	R	
Analog input	007	PV	PV input	-15.00 to +115.00%		R	R	R	R		
Parameter	008	HH_SP	High/high alarm setting	-15.00 to +115.00%		R (- only)	R/W	R	R/W		
	009	H_SP	High alarm setting	-15.00 to +115.00%		R (- only)	R/W	R	R/W		
	010	L_SP	Low alarm setting	-15.00 to +115.00%		R (- only)	R/W	R	R/W		
	011	LL_SP	Low/low alarm setting	-15.00 to +115.00%		R (- only)	R/W	R	R/W		
Contact output	013	HH	High/high alarm output	0 or 1	R (Color)	R	R	R	R	R	R
	014	H	High alarm output	0 or 1	R (Color)	R	R	R	R	R	R
	015	L	Low alarm output	0 or 1	R (Color)	R	R	R	R	R	R
	016	LL	Low/low alarm output	0 or 1	R (Color)	R	R	R	R	R	R
Contact input	017	ALM_OF F	Alarm stop switch 0: Alarm, 1: Stop	0 or 1	R (Color)	R (Color)	R/W	R	R/W	R	
Parameter	019	PV_ABN	PV error display 0: Normal, 1: Error	0 or 1			R	R	R	R	R
	099	OP_MK	Label	0 to 15		R/W	R/W	R	R/W		

High/Low Alarm (Block Model 111)

ITEM type	ITEM	Tag ITEM	Data description	Data range	CX-Process Monitor screen (R:Read W:Write)						
					Overview Screen	Control Screens	Tuning Screens	Trend Screens	Graphic Screens	Annun- ciator Screens	Alarm Log Screens
Analog input	008	PV	PV input	±320.00%		R		R	R		
Parameter	009	H_SP	High setting	±320.00%		R/W		R	R/W		
	010	L_SP	Low setting	±320.00%		R/W		R	R/W		
Contact output	012	H	High alarm output	0 or 1	R (Color)	R		R	R	R	R
	013	L	Low alarm output	0 or 1	R (Color)	R		R	R	R	R

Segment Program 2 (Block Model 157)

ITEM type	ITEM	Tag ITEM	Data description	Data range	CX-Process Monitor screen (R:Read W:Write)						
					Overview Screen	Control Screens	Tuning Screens	Trend Screens	Graphic Screens	Annunciator Screens	Alarm Log Screens
Contact input	000	MT_SW	Stop block operation command(0: Cancel stop, 1: Stop)	0 or 1	R	R	R/W	R	R		
Analog input	007	X1	Reference input	±320.00%		R	R	R	R		
Analog output	008	Y1	Program output	±320.00%		R/W	R	R	R/W		
Analog output	009	Y2	Elapsed time unit	0 to 3200.0							
	011	Y3	Step output	0 to 30		R	R	R	R		
Contact input	013	S1	Run/stop command	0 or 1	R (Color)	R/W	R/W	R	R		
	014	S2	Hold switch	0 or 1	R (Color)	R/W	R/W	R	R/W		
Contact output	015	U1	X1 input error	0 or 1				R	R	R	R/W
	016	U2	Arrival at final segment	0 or 1							
Contact input	017	S3	Move to next wait command	0 or 1		R/W	R/W	R	R		
	018	S4	Move to next step command	0 or 1		R/W	R/W	R	R		
	019	U10	Waiting	0 or 1		R	R	R	R		

ITEM type	ITEM	Tag ITEM	Data description	Data range	CX-Process Monitor screen (R:Read W:Write)							
					Overview Screen	Control Screens	Tuning Screens	Trend Screens	Graphic Screens	Annun- ciator Screens	Alarm Log Screens	
Parameter	022	B0	Default	±320.00%		R	R					
	023		Step1 Time width	0 to 3200.0			R/W for each step					
	024		Step1 Output value	±320.00%								
	025		Step1 Time unit	0 to 2								
	026		Step2 Time width	0 to 3200.0								
	027		Step2 Output value	±320.00%								
	028		Step2 Time unit	0 to 2								
	029		Step3 Time width	0 to 3200.0								
	030		Step3 Output value	±320.00%								
	031		Step3 Time unit	0 to 2								
	032		Step4 Time width	0 to 3200.0								
	033		Step4 Output value	±320.00%								
	034		Step4 Time unit	0 to 2								
	035		Step5 Time width	0 to 3200.0								
	036		Step5 Output value	±320.00%								
	037		Step5 Time unit	0 to 2								
	038		Step6 Time width	0 to 2								
	039		Step6 Output value	±320.00%								
	040		Step6 Time unit	0 to 2								
	041		Step7 Time width	0 to 3200.0								
	042		Step7 Output value	±320.00%								
	043		Step7 Time unit	0 to 2								
	044		Step8 Time width	0 to 3200.0								
	045		Step8 Output value	±320.00%								
	046		Step8 Time unit	0 to 2								
	047		Step9 Time width	0 to 3200.0								
	048		Step9 Output value	±320.00%								
	049		Step9 Time unit	0 to 2								
	050		Step10 Time width	0 to 3200.0								
	051		Step10 Output value	±320.00%								
	052		Step11 Time unit	0 to 2								
	053		Step11 Time width	0 to 3200.0								
	054		Step11 Output value	±320.00%								
055		Step11 Time unit	0 to 2									
056		Step12 Time width	0 to 3200.0									
057		Step12 Output value	±320.00%									
058		Step12 Time unit	0 to 2									
059		Step13 Time width	0 to 3200.0									
060		Step13 Output value	±320.00%									
061		Step13 Time unit	0 to 2									
062		Step14 Time width	0 to 3200.0									
063		Step14 Output value	±320.00%									
064		Step14 Time unit	0 to 2									
065		Step15 Time width	0 to 3200.0									
066		Step15 Output value	±320.00%									
067		Step15 Time unit	0 to 2									
068		Step16 Time width	0 to 3200.0									
069		Step16 Output value	±320.00%									
070		Step16 Time unit	0 to 2									
071		Step17 Time width	0 to 3200.0									
072		Step17 Output value	±320.00%									
073		Step17 Time unit	0 to 2									
074		Step18 Time width	0 to 3200.0									
075		Step18 Output value	±320.00%									
076		Step18 Time unit	0 to 2									
077		Step19 Time width	0 to 3200.0									

ITEM type	ITEM	Tag ITEM	Data description	Data range	CX-Process Monitor screen (R:Read W:Write)						
					Overview Screen	Control Screens	Tuning Screens	Trend Screens	Graphic Screens	Annunciator Screens	Alarm Log Screens
Parameter	078		Step19 Output value	±320.00%			R/W for each step				
	079		Step19 Time unit	0 to 2							
	080		Step20 Time width	0 to 3200.0							
	081		Step20 Output value	±320.00%							
	082		Step20 Time unit	0 to 2							
	083		Step21 Time width	0 to 3200.0							
	084		Step21 Output value	±320.00%							
	085		Step21 Time unit	0 to 2							
	086		Step22 Time width	0 to 3200.0							
	087		Step22 Output value	±320.00%							
	088		Step22 Time unit	0 to 2							
	089		Step23 Time width	0 to 3200.0							
	090		Step23 Output value	±320.00%							
	091		Step23 Time unit	0 to 2							
	092		Step24 Time width	0 to 3200.0							
	093		Step24 Output value	±320.00%							
	094		Step24 Time unit	0 to 2							
	095		Step25 Time width	0 to 3200.0							
	096		Step25 Output value	±320.00%							
	097		Step25 Time unit	0 to 2							
	098		Step26 Time width	0 to 3200.0							
	099		Step26 Output value	±320.00%							
	100		Step26 Time unit	0 to 2							
	101		Step27 Time width	0 to 3200.0							
	102		Step27 Output value	±320.00%							
	103		Step27 Time unit	0 to 2							
	104		Step28 Time width	0 to 3200.0							
	105		Step28 Output value	±320.00%							
	106		Step28 Time unit	0 to 2							
	107		Step29 Time width	0 to 3200.0							
	108		Step29 Output value	±320.00%							
	109		Step29 Time unit	0 to 2							
	110		Step30 Time width	0 to 3200.0							
	111		Step30 Output value	±320.00%							
112		Step30 Time unit	0 to 2								

ITEM type	ITEM	Tag ITEM	Data description	Data range	CX-Process Monitor screen (R:Read W:Write)							
					Overview Screen	Control Screens	Tuning Screens	Trend Screens	Graphic Screens	Annun- ciator Screens	Alarm Log Screens	
● Wait setting												
Parameter	121		Step1 Wait width	0 to 320.00%			R/W for each step					
	122		Step1 Wait time	0 to 3200.0								
	123		Step2 Wait width	0 to 320.00%								
	124		Step2 Wait time	0 to 3200.0								
	125		Step3 Wait width	0 to 320.00%								
	126		Step3 Wait time	0 to 3200.0								
	127		Step4 Wait width	0 to 320.00%								
	128		Step4 Wait time	0 to 3200.0								
	129		Step5 Wait width	0 to 320.00%								
	130		Step5 Wait time	0 to 3200.0								
	131		Step6 Wait width	0 to 320.00%								
	132		Step6 Wait time	0 to 3200.0								
	133		Step7 Wait width	0 to 320.00%								
	134		Step7 Wait time	0 to 3200.0								
	135		Step8 Wait width	0 to 320.00%								
	136		Step8 Wait time	0 to 3200.0								
	137		Step9 Wait width	0 to 320.00%								
	138		Step9 Wait time	0 to 320.0								
	139		Step10 Wait width	0 to 320.00%								
	140		Step10 Wait time	0 to 3200.0								
	141		Step11 Wait width	0 to 320.00%								
	142		Step11 Wait time	0 to 3200.0								
	143		Step12 Wait width	0 to 320.00%								
	144		Step12 Wait time	0 to 3200.0								
	145		Step13 Wait width	0 to 320.00%								
146		Step13 Wait time	0 to 3200.0									
147		Step14 Wait width	0 to 320.00%									
148		Step14 Wait time	0 to 3200.0									
149		Step15 Wait width	0 to 320.00%									
150		Step15 Wait time	0 to 3200.0									
151		Step16 Wait width	0 to 320.00%									
152		Step16 Wait time	0 to 3200.0									
153		Step17 Wait width	0 to 320.00%									
154		Step17 Wait time	0 to 3200.0									
155		Step18 Wait width	0 to 320.00%									
156		Step18 Wait time	0 to 3200.0									
157		Step19 Wait width	0 to 320.00%									
158		Step19 Wait time	0 to 3200.0									
159		Step20 Wait width	0 to 320.00%									
160		Step20 Wait time	0 to 3200.0									
161		Step21 Wait width	0 to 320.00%									
162		Step21 Wait time	0 to 3200.0									
163		Step22 Wait width	0 to 320.00%									
164		Step22 Wait time	0 to 3200.0									
165		Step23 Wait width	0 to 320.00%									
166		Step23 Wait time	0 to 3200.0									
167		Step24 Wait width	0 to 320.00%									
168		Step24 Wait time	0 to 3200.0									
169		Step25 Wait width	0 to 320.00%									
170		Step25 Wait time	0 to 3200.0									

ITEM type	ITEM	Tag ITEM	Data description	Data range	CX-Process Monitor screen (R:Read W:Write)						
					Overview Screen	Control Screens	Tuning Screens	Trend Screens	Graphic Screens	Annunciator Screens	Alarm Log Screens
Parameter	171		Step26 Wait width	0 to 320.00%			R/W for each step				
	172		Step26 Wait time	0 to 3200.0							
	173		Step27 Wait width	0 to 320.00%							
	174		Step27 Wait time	0 to 3200.0							
	175		Step28 Wait width	0 to 320.00%							
	176		Step28 Wait time	0 to 3200.0							
	177		Step29 Wait width	0 to 320.00%							
	178		Step29 Wait time	0 to 3200.0							
	179		Step30 Wait width	0 to 320.00%							
	180		Step30 Wait time	0 to 3200.0							
● Step Executing flag											
Contact output	221	U11	Step1 Executing flag	0 or 1							
	222	U12	Step2 Executing flag	0 or 1							
	223	U13	Step3 Executing flag	0 or 1							
	224	U14	Step4 Executing flag	0 or 1							
	225	U15	Step5 Executing flag	0 or 1							
	226	U16	Step6 Executing flag	0 or 1							
	227	U17	Step7 Executing flag	0 or 1							
	228	U18	Step8 Executing flag	0 or 1							
	229	U19	Step9 Executing flag	0 or 1							
	230	U20	Step10 Executing flag	0 or 1							
	231	U21	Step11 Executing flag	0 or 1							
	232	U22	Step12 Executing flag	0 or 1							
	233	U23	Step13 Executing flag	0 or 1							
	234	U24	Step14 Executing flag	0 or 1							
	235	U25	Step15 Executing flag	0 or 1							
	236	U26	Step16 Executing flag	0 or 1							
	237	U27	Step17 Executing flag	0 or 1							
	238	U28	Step18 Executing flag	0 or 1							
	239	U29	Step19 Executing flag	0 or 1							
	240	U30	Step20 Executing flag	0 or 1							
	241	U31	Step21 Executing flag	0 or 1							
	242	U32	Step22 Executing flag	0 or 1							
	243	U33	Step23 Executing flag	0 or 1							
	244	U34	Step24 Executing flag	0 or 1							
	245	U35	Step25 Executing flag	0 or 1							
	246	U36	Step26 Executing flag	0 or 1							
	247	U37	Step27 Executing flag	0 or 1							
	248	U38	Step28 Executing flag	0 or 1							
	249	U39	Step29 Executing flag	0 or 1							
	250	U40	Step30 Executing flag	0 or 1							

ON/OFF Valve Manipulator (Block Model 221)

ITEM type	ITEM	Tag ITEM	Data description	Data range	CX-Process Monitor screen (R:Read W:Write)						
					Overview Screen	Control Screens	Tuning Screens	Trend Screens	Graphic Screens	Annunciator Screens	Alarm Log Screens
Contact input	000	MT_SW	Stop block operation command(0: Cancel stop, 1: Stop)	0 or 1				R	R	R	
	012	S2	Auto input 0:OFF; 1:ON	0 or 1		R		R	R	R	
	013	S3	Manual input 0:OFF; 1:ON	0 or 1		R/W		R	R	R	
	015	S5	Open limit switch input	0 or 1		R		R	R	R	
	016	S6	Close limit switch input	0 or 1		R		R	R	R	
	022	U2	Valve action time error (1:error)	0 or 1		R (Color)		R	R	R	R
	023	U3	Valve open midway (1: Open midway)	0 or 1		R		R	R	R	
	085	S4	Site manipulation switch input (0:Central; 1:Site)	0 or 1		R (Color)		R	R	R	
Parameter	086	A/M_S W	Auto/Manual switching 0: Manual, 1: Auto	0 or 1		R/W		R	R/W	R	
	099	OP_MK	Label	0 to 15		R/W		R	R/W		

Motor Manipulator (Block Model 222)

ITEM type	ITEM	Tag ITEM	Data description	Data range	CX-Process Monitor screen (R:Read W:Write)						
					Overview Screen	Control Screens	Tuning Screens	Trend Screens	Graphic Screens	Annunciator Screens	Alarm Log Screens
Contact input	000	MT_SW	Stop block operation command(0: Cancel stop, 1: Stop)	0 or 1				R	R	R	
	012	S2	Auto input 0:OFF; 1:ON	0 or 1		R		R	R	R	
	013	S3	Manual input 0:OFF; 1:ON	0 or 1		R/W		R	R	R	
	015	S5	Answer input	0 or 1		R		R	R	R	
	022	U2	Answer error (1:error)	0 or 1		R (Color)		R	R	R	R
Analog input	032	X1	CT input	-320.00 to +320.00%		R		R	R		
Parameter	033	H_SP	CT input high alarm setting	-320.00 to +320.00%		R (-)		R	R/W		
Contact output	036	H	CT input high alarm output	0 or 1		R		R	R	R	R
Contact input	085	S4	Site manipulation switch input (0:Central; 1:Site)	0 or 1		R (Color)		R	R	R	
Parameter	086	A/M_S W	Auto/Manual switching 0: Manual, 1: Auto	0 or 1		R/W		R	R/W	R	
	099	OP_MK	Label	0 to 15		R/W		R	R/W		

Reversible Motor Manipulator (Block Model 223)

ITEM type	ITEM	Tag ITEM	Data description	Data range	CX-Process Monitor screen (R:Read W:Write)						
					Overview Screen	Control Screens	Tuning Screens	Trend Screens	Graphic Screens	Annun- ciator Screens	Alarm Log Screens
Contact input	000	MT_SW	Stop block operation command(0: Cancel stop, 1: Stop)	0 or 1				R	R	R	
	012	S2	AUTO-FWD input 0:OFF; 1:ON	0 or 1		R		R	R	R	
	013	S3	AUTO-REV input 0:OFF; 1:ON	0 or 1		R		R	R	R	
	014	S4	MAN-FWD input 0:OFF; 1:ON	0 or 1		R/W		R	R/W	R	
	016	S6	MAN-REV input 0:OFF; 1:ON	0 or 1		R/W		R	R/W		
	018	S8	FWD answer input 0:OFF; 1:ON	0 or 1		R		R	R		
	019	S9	REV answer input 0:OFF; 1:ON	0 or 1		R		R	R		
	023	U3	Answer error (1:error)	0 or 1		R (Color)		R	R	R	R
Analog input	032	X1	CT input	-320.00 to +320.00%		R		R	R		
Parameter	033	H_SP	CT input high alarm setting	-320.00 to +320.00%		R (-)		R	R/W		
Contact output	036	H	CT input high alarm output	0 or 1		R		R	R	R	R
Contact input	085	S4	Site manipulation switch input (0:Central; 1:Site)	0 or 1		R (Color)		R	R	R	
	086	A/M_S W	Auto/Manual switching 0: Manual, 1: Auto	0 or 1		R/W		R	R/W	R	
Parameter	099	OP_MK	Label	0 to 15		R/W		R	R/W		

Motor Opening Manipulator (Block Model 224)

ITEM type	ITEM	Tag ITEM	Data description	Data range	CX-Process Monitor screen (R:Read W:Write)						
					Overview Screen	Control Screens	Tuning Screens	Trend Screens	Graphic Screens	Annun- ciator Screens	Alarm Log Screens
Contact input	000	MT_SW	Stop block operation command(0: Cancel stop, 1: Stop)	0 or 1				R	R	R	
Analog input	012	X2	Auto input	-320.00 to +320.00%		R		R	R	R	
Parameter	013		Manual input target opening setting	-320.00 to +320.00%		R/W		R	R	R	
Contact input	019	S3	Open monitor switch thermal relay operation 0:OFF; 1:ON	0 or 1		R (Color)		R	R	R	R
	020	S4	Close monitor switch thermal relay operation 0:OFF; 1:ON	0 or 1		R (Color)		R	R	R	R
Contact output	021	U1	Open manipulation output 0:OFF; 1:ON	0 or 1		R		R	R	R	
	022	U2	Close manipulation output 0:OFF; 1:ON	0 or 1		R		R	R	R	
Analog input	032	X1	Opening input	-320.00 to +320.00%		R		R	R		

ITEM type	ITEM	Tag ITEM	Data description	Data range	CX-Process Monitor screen (R:Read W:Write)						
					Overview Screen	Control Screens	Tuning Screens	Trend Screens	Graphic Screens	Annun- ciator Screens	Alarm Log Screens
Parameter	033	H_SP	Opening input high limit alarm setting	-320.00 to +320.00%		R (-)		R			
	034	L_SP	Opening input low limit alarm setting	-320.00 to +320.00%		R (-)		R			
Contact output	036	H	Opening input high limit alarm output	0 or 1	R (Color)	R (Color)		R	R	R	R
	037	L	Opening input low limit alarm output	0 or 1	R (Color)	R (Color)		R	R	R	R
Contact input	085	S2	Site manipulation switch input (1: Site, 1: Central)	0 or 1		R (Color)		R	R	R	
	086	A/M_SW	Auto/Manual switching 0: Manual, 1: Auto	0 or 1		R/W		R	R/W	R	
Parameter	099	OP_MK	Label	0 to 15		R/W		R	R/W		

Timer (Block Model 205)

ITEM type	ITEM	Tag ITEM	Data description	Data range	CX-Process Monitor screen (R:Read W:Write)						
					Overview Screen	Control Screens	Tuning Screens	Trend Screens	Graphic Screens	Annun- ciator Screens	Alarm Log Screens
Parameter	007	SP	Setting	0 to 3200.0		R/W		R	R/W		
	008	PRE-SET	Prediction (subtracted from setting)	0 to 3200.0		R/W		R	R/W		
Analog output	009	PV	Time elapsed	0 to 3200.0		R		R	R		
Contact input	011	S1	Run switch	0 or 1		R/W		R	R	R	
	012	S2	Interrupt switch	0 or 1		R/W		R	R	R	
Contact output	013	U1	Arrival at setting	0 or 1		R		R	R	R	
	014	U2	Arrival at prediction	0 or 1		R		R	R	R	

Counter (Block Model 208)

ITEM type	ITEM	Tag ITEM	Data description	Data range	CX-Process Monitor screen (R:Read W:Write)						
					Overview Screen	Control Screens	Tuning Screens	Trend Screens	Graphic Screens	Annun- ciator Screens	Alarm Log Screens
Parameter	007	SP	Setting	0 to 9999		R/W		R	R/W		
	008	PRE-SET	Prediction (subtracted from setting)	0 to 9999		R/W		R	R/W		
80 Analog output	009	PV	Count	0 to 9999		R		R	R		
Contact input	010	S1	Run switch	0 or 1		R/W		R	R	R	
Contact output	012	U1	Arrival at setting	0 or 1		R		R	R	R	
	013	U2	Arrival at prediction	0 or 1		R		R	R	R	

Appendix B

FinsGateway Settings when Connected Using Controller Link

If connecting CX-Process Monitor over a Controller Link network, and sending and receiving data with the Loop Control Unit on a PLC via the Controller Link network, you must create a Controller Link data link table, and register all the nodes.

Make the settings using the following procedure.

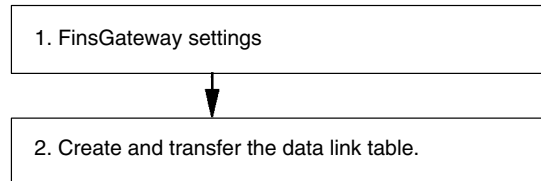

Each procedure is shown in detail below.

1. FinsGateway Settings

An outline of the setting procedure is as follows:

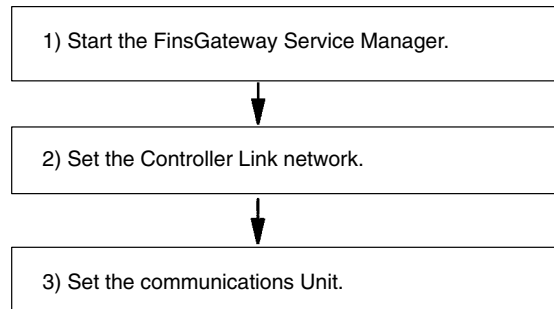

1) Start the FinsGateway Settings Manager

Select **FinsGateway**, and then select **FinsGateway Settings** to start the FinsGateway Settings.

The following dialog box will be displayed.

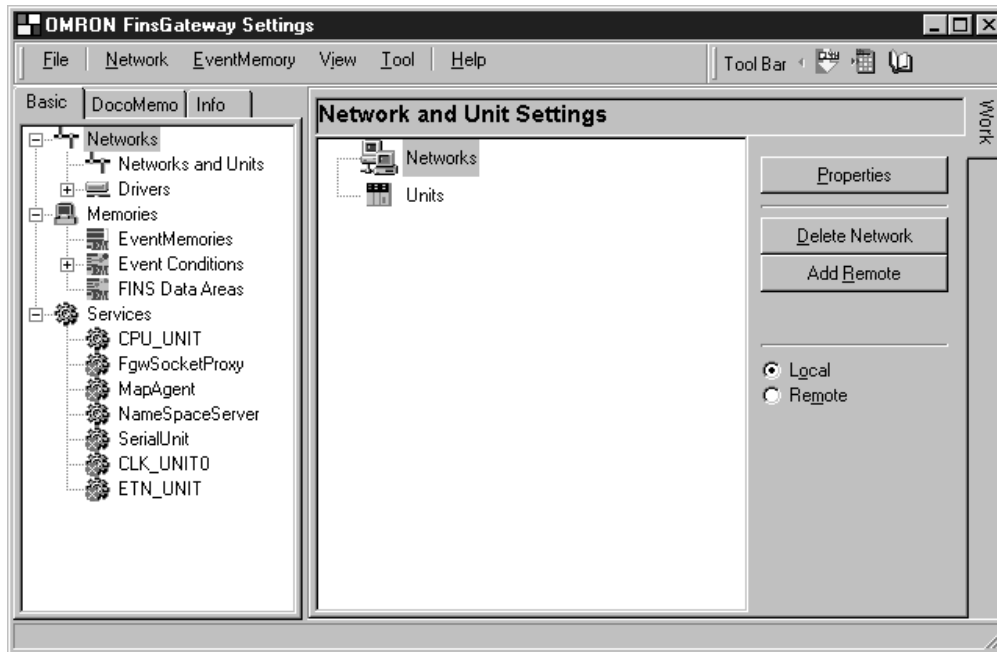

- 1, 2, 3... 1. Select **CLK_UNIT0** and **CPU_UNIT** as shown in 1 above, and then click the **Start** Button to start the communications service.
2. Next, click the button marked 2 in the above diagram. The FinsGateway Network Navigator Dialog Box will be displayed as shown below.

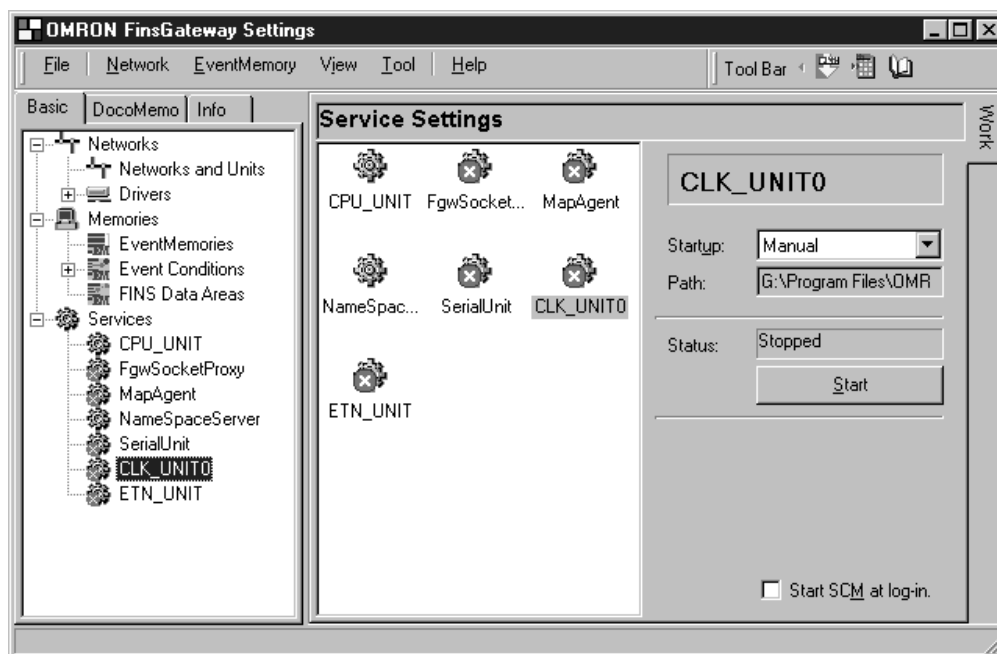

3. Click the **Start** Button.

2) Controller Link Network Settings

- 1, 2, 3... 1. Select **CLK (PCI)** or **Controller Link** in the Network and Unit Settings, and click the **Property** Button. The CLK (PCI) or Controller Link Properties Dialog Box will be displayed.

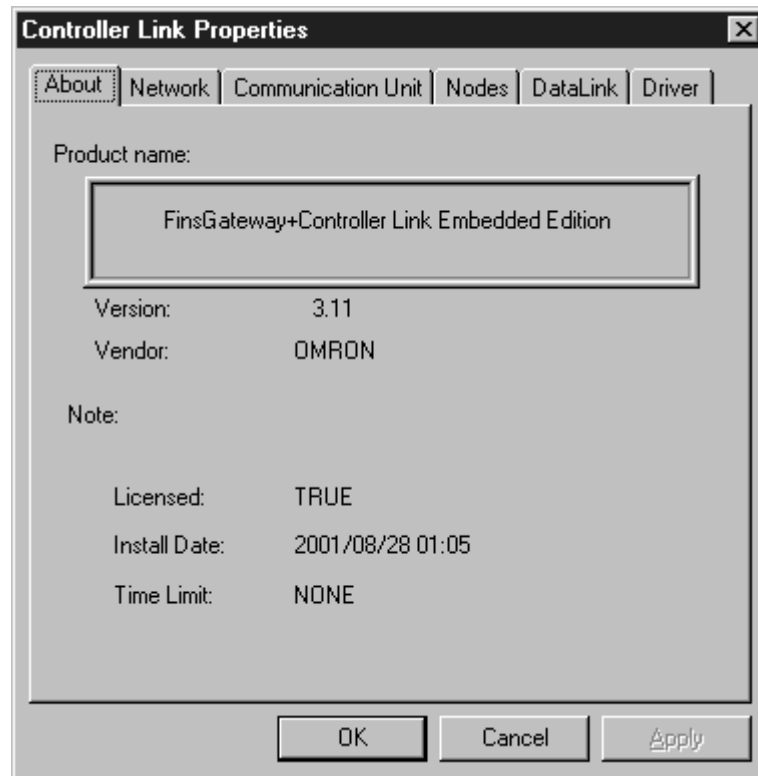

2. Select the Network Tab.

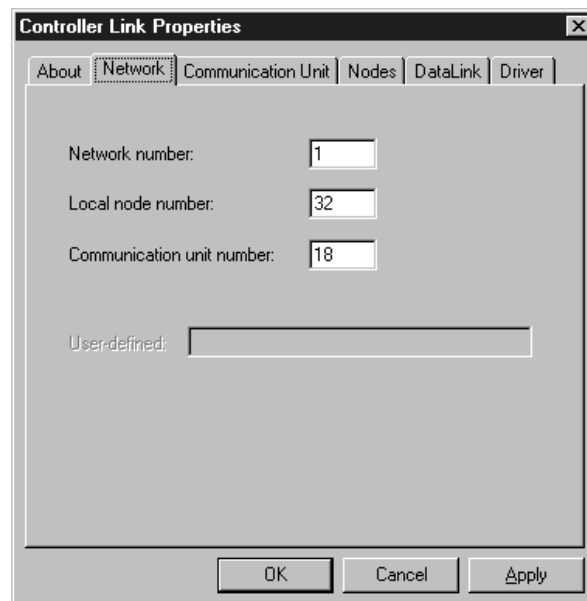

3. Set the parameters as follows:
Network number: 1
Local node number: 32
Communication unit number: 18

Communication Unit Settings

Select the Communication Unit Tab.

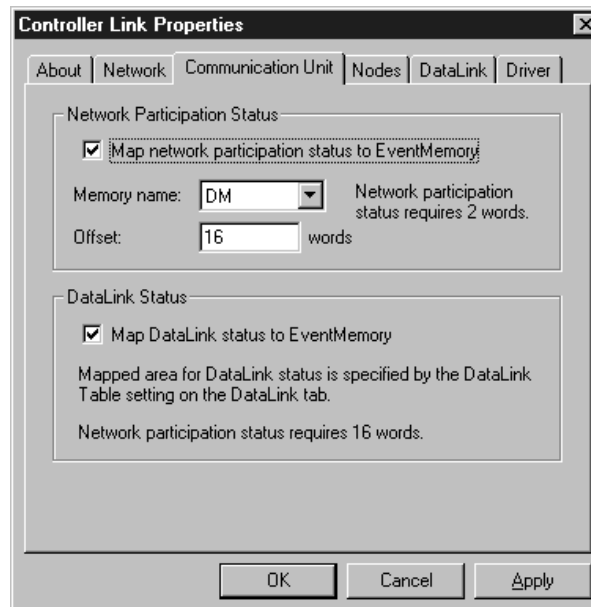

Make the following settings in the Network Participation Status Field:

- Select the **Map Network Participation Status To Event Memory** Button.
- Set Memory Name to DM.
- Set Offset to 16 Words.

Make the following settings in the Data Link Status Field:

- Select the **Map Data Link Status To Event Memory** Button.

This completes the FinsGateway settings.

Creating and Transferring the Data Link Table

The flowchart outline for creating and transferring the data link table is as follows:

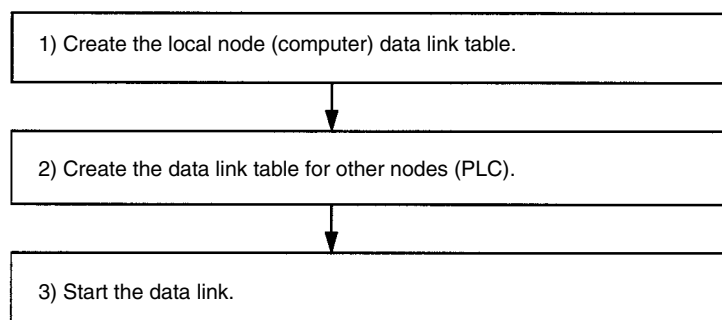

The data link table setting procedure is different when the number of other nodes (i.e., the number of PLCs connected to the network) is one, and when it is two or more. This section shows the data link setting procedure when the number of other nodes is one, and when the number of other nodes is two.

Example 1: Number of Other Nodes is 1 (There is Only 1 PLC)

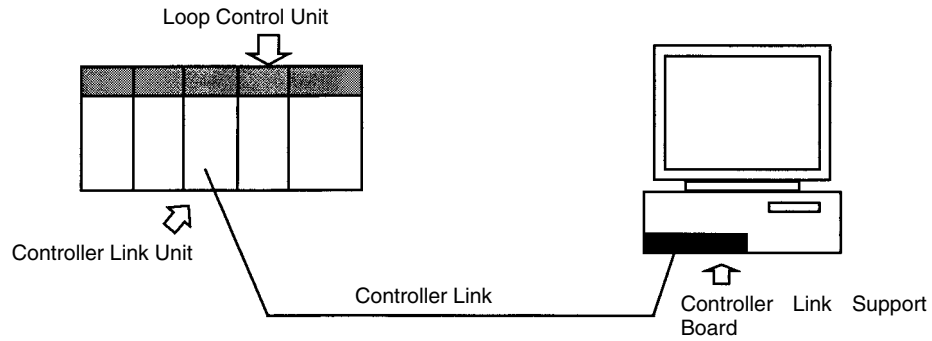

In the above configuration, one PLC is connected to the network. The Controller Link Unit's node address is set to 1 using the rotary switch on the front of the Unit.

Creating the Local Node's Data Link Table

- 1, 2, 3... 1. Select **FinsGateway**, and then select **FinsGateway Settings**, and then select **Controller Link Properties**.
2. Click the **Data Link**. The following dialog box will be displayed.

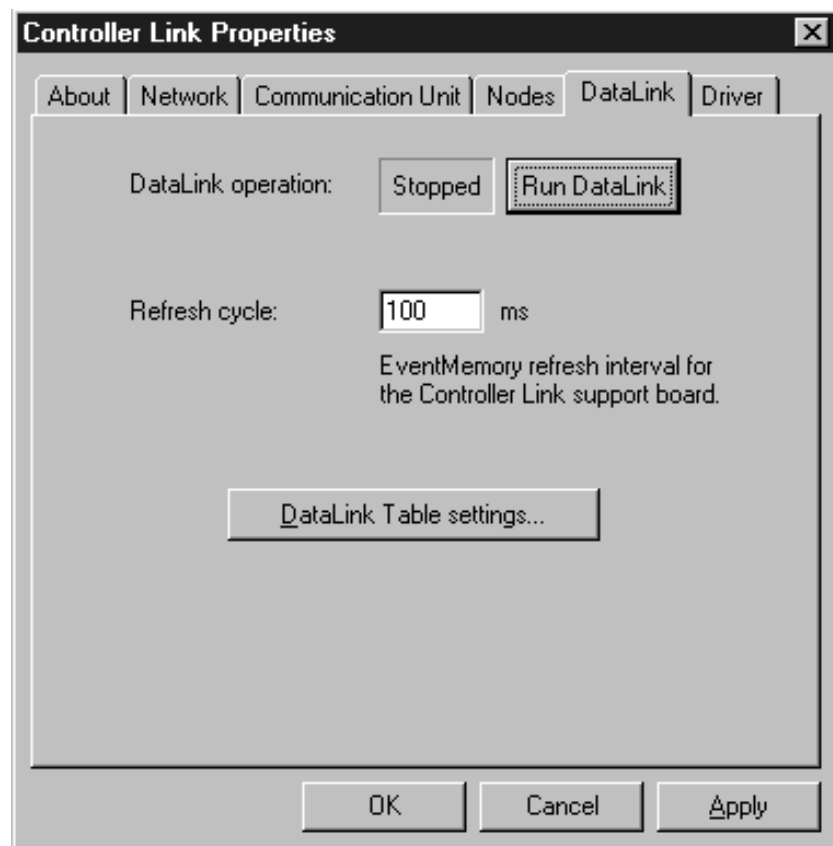

3. Click the **Data Link Table Settings** Button.

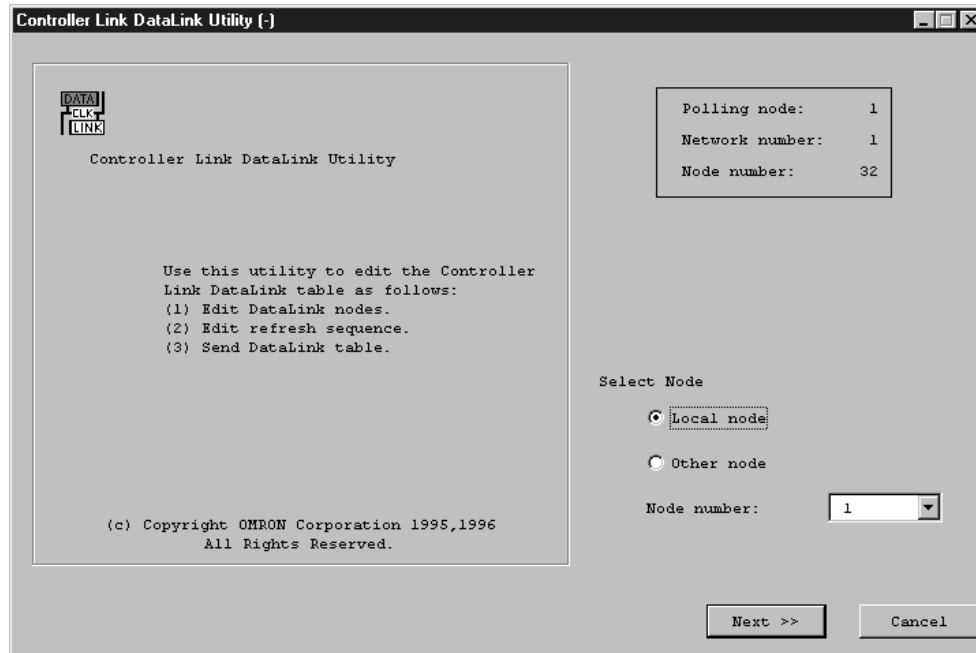

4. Click the **Local Node** Button, and then click the **Next** Button.

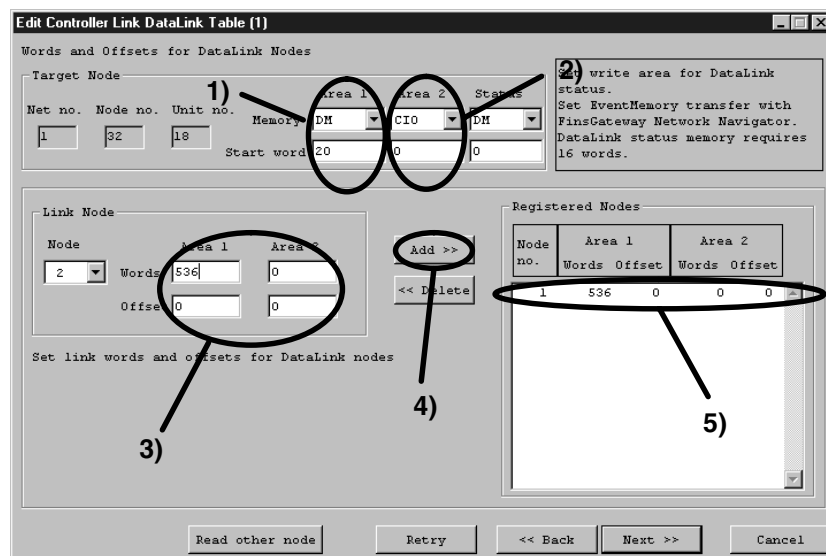

Enter fields (1) to (5) as shown above. The procedure is shown below.

Before making the settings, check that nothing is entered in column (5). If there is an entry in the column, make sure to click the **Delete** Button and delete everything.

- 1) Set the Area 1 type to DM. Set the Start Word to 20.
- 2) Set the Area 2 type to CIO. Area 2 is not used in monitoring, but make sure that the settings for Area 1 and Area 2 are different.
- 3) Enter the node to be refreshed.
Set the number of words in Area 1 to 536, and set the Offset to 0. (Set the number of words to 636 when using a Terminal to All Nodes function block.)
Set the number of words in Area 2 to 0, and set the Offset to 0.
- 4) Click the **Add** Button.
- 5) Check that in Node 1's Area 1, the number of words is set to 536 and the Offset is set to 0.

5. Click the **Next** Button to proceed to the next step.
6. Proceed to Edit Controller Link Data Link Table (2). Normally, use this screen to set the data link refresh order, but here click the **Next** Button to proceed to the next step.

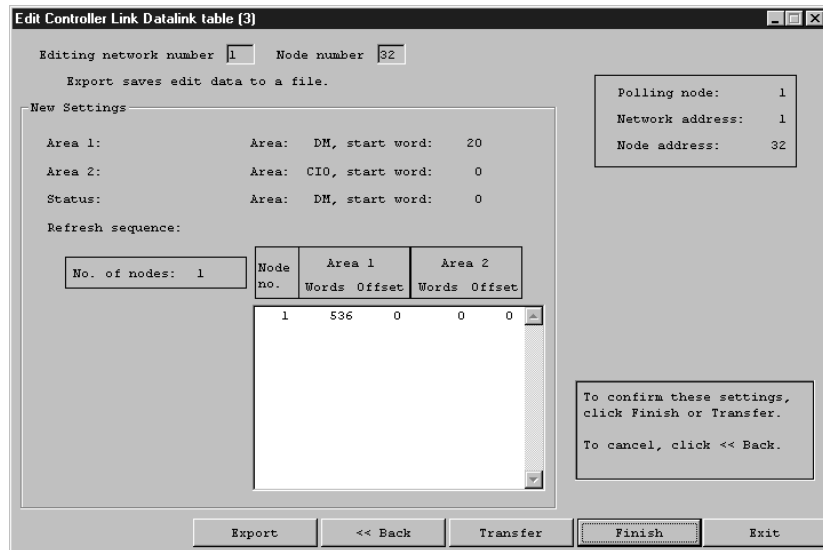

7. Click the **Finish** Button. The verification dialog box will be displayed. Click the **Start** Button.

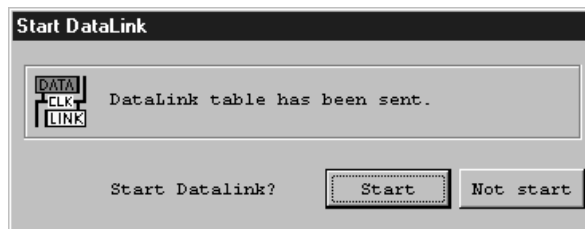

This completes the local node's data link table settings. When you click the **Start** Button, the data link will start immediately. Other node settings have not yet been completed, however, so stop the data link using the Controller Link Properties Screen.

2) Creating Data Link Tables for Other Nodes

- 1, 2, 3... 1. Select *FinsGateway*, and then select *Service Manager*, and then select *Controller Link Properties*.

2. Click the **Data Link** Tab. The following dialog box will be displayed.

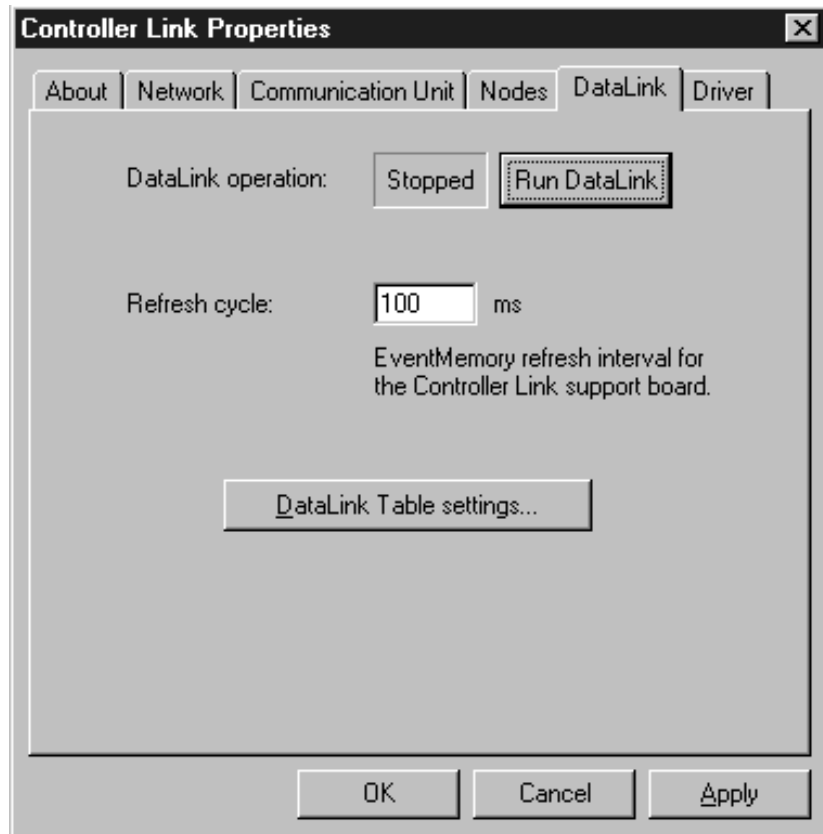

3. Click the **Data Link Table Settings** Button.

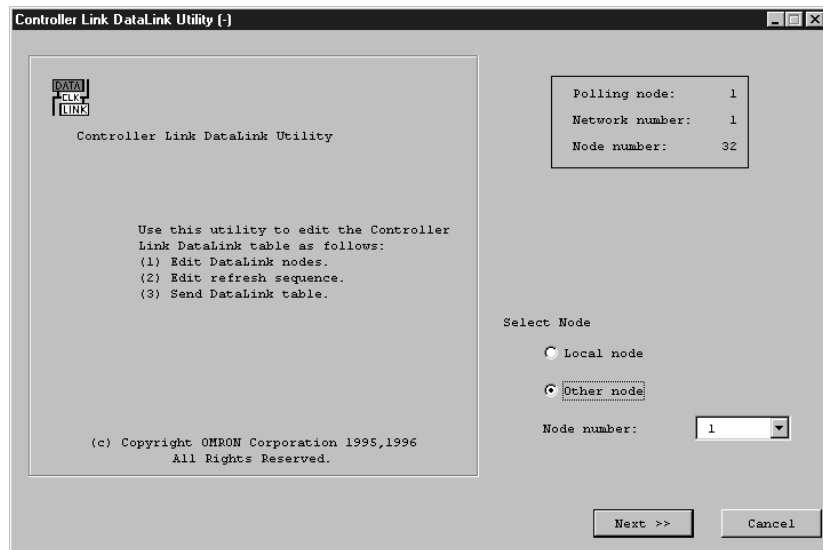

4. Select the **Other Node** Button, and set the node number to 1. Refer to the above diagram.

5. Click the **Next** Button to proceed to the next step.

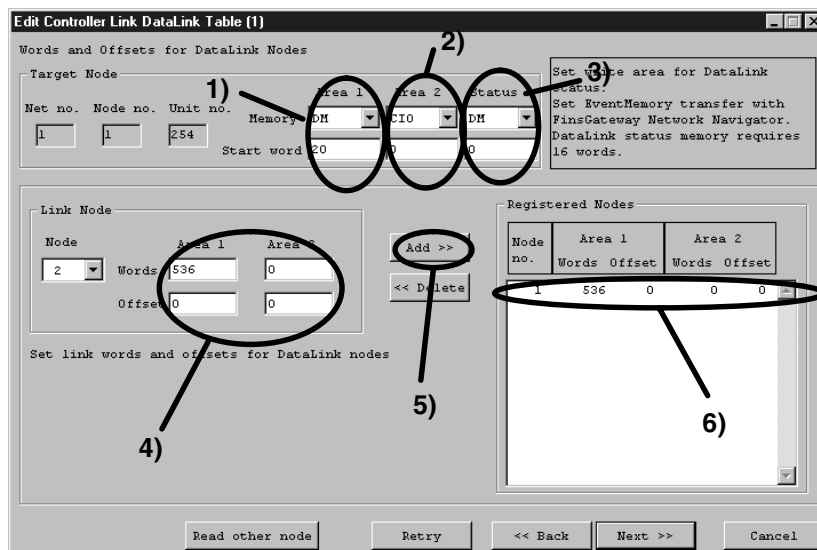

Enter fields (1) to (6) as shown above. The procedure is shown below.

Before making the settings, check that nothing is entered in column (5). If there is an entry in the column, make sure to click the **Delete** Button and delete everything.

- 1) Set the Area 1 type to DM. Set the Start Word to 16020.
 - 2) Set the Area 2 type to CIO. Area 2 is not used in monitoring, but make sure that the settings for Area 1 and Area 2 are different.
 - 3) Set the Status Area type to DM. Set the Start Word to 16000.
 - 4) Enter the node to be refreshed.
 - Set the number of words in Area 1 to 536, and set the Offset to 0. (Set the number of words to 636 when using a Terminal to All Nodes function block.)
 - Set the number of words in Area 2 to 0, and set the Offset to 0.
 - 5) Click the **Add** Button.
 - 6) Check that in Node 1's Area 1, the number of words is set to 536 and the Offset is set to 0. (Set the number of words to 636 when using a Terminal to All Nodes function block.)
6. Click the **Next** Button to proceed to the next step.
7. Proceed to Edit Controller Link Data Link Table (2). Normally, use this screen to set the data link refresh order, but here click the **Next** Button to proceed to the next step.

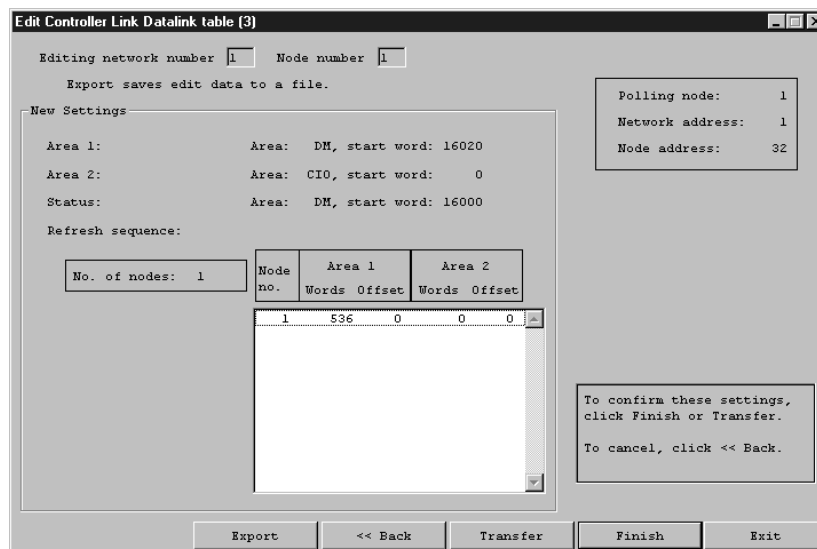

8. Click the **Finish** Button. The verification dialog box will be displayed. Click the **Start** Button.

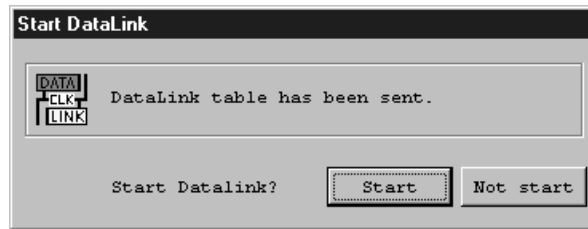

This completes the local node's data link table settings. When you click the **Start** Button, the data link will start.

Note Check that the Controller Link Unit's indicator shows that the data link is operating. If there is an error, check for troubleshooting procedures using the *Controller Link Unit Operation Manual*.

Example 2: Number of Other Nodes is 2 (There are 2 PLCs)

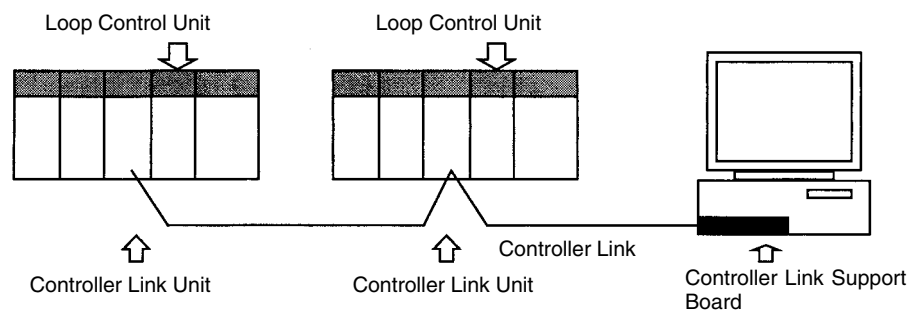

In the above configuration, one PLC is connected to the network. The Controller Link Unit's node addresses are set to 1 and 2 respectively, using the rotary switch on the front of each Unit.

Creating the Local Node's Data Link Table

- 1, 2, 3... 1. Select **FinsGateway**, and then select **FinsGateway Settings**, and then select **Controller Link Properties**.

2. Double click the **Data Link** Tab. The following dialog box will be displayed.

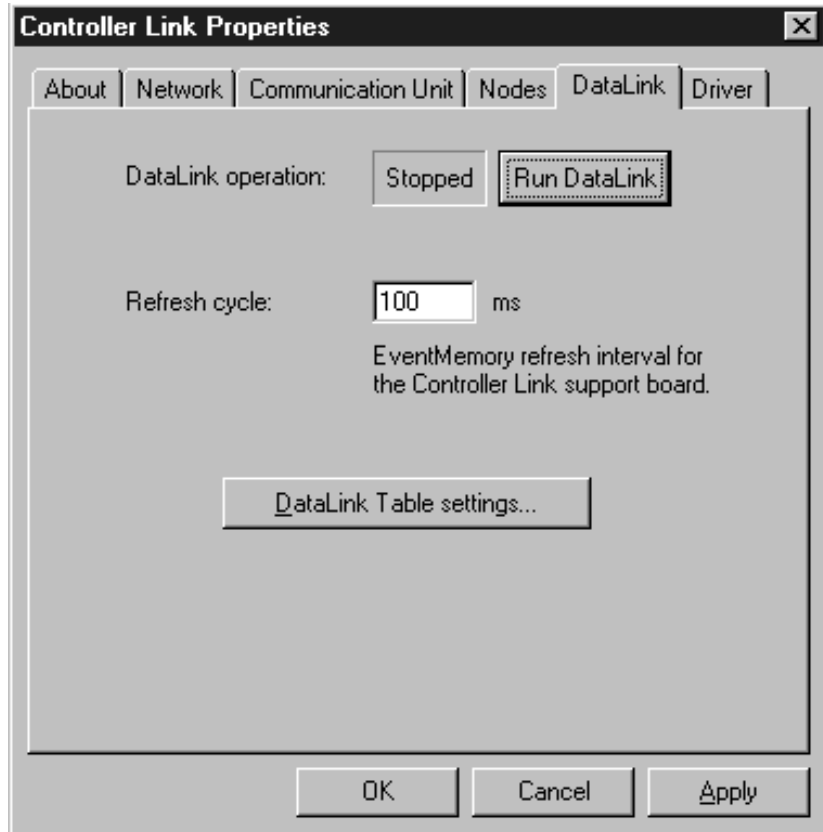

3. Click the **Data Link Table Settings** Button.

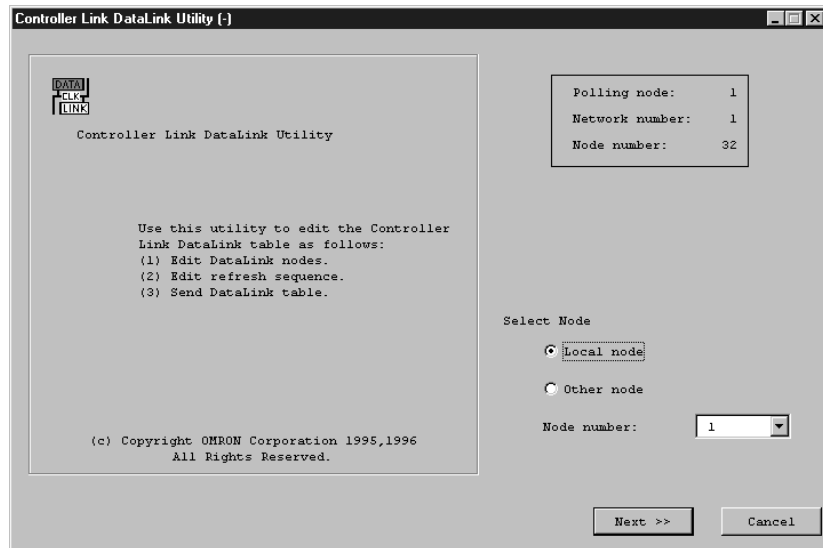

4. Click the **Local Node** Button, and then click the **Next** Button.

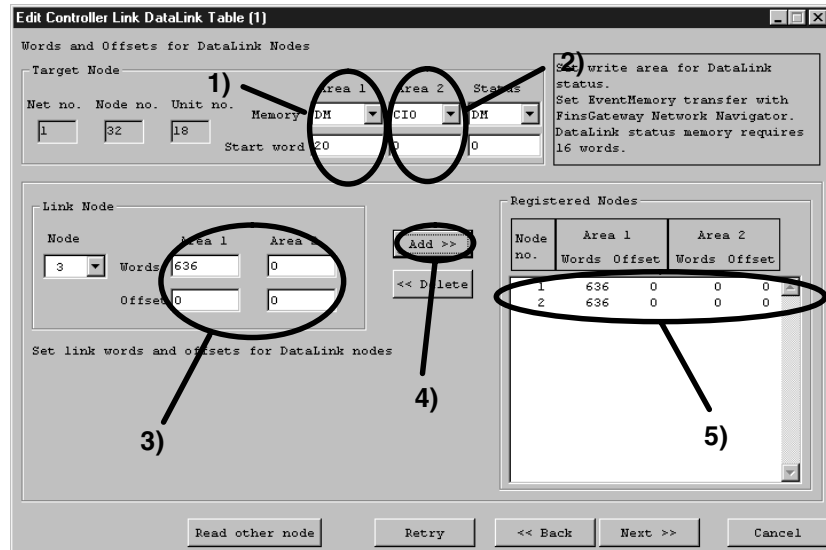

Enter fields (1) to (5) as shown above. The procedure is shown below.

Before making the settings, check that nothing is entered in column (5). If there is an entry in the column, make sure to click the **Delete** Button and delete everything.

- 1) Set the Area 1 type to DM. Set the Start Word to 20.
 - 2) Set the Area 2 type to CIO. Area 2 is not used in monitoring, but make sure that the settings for Area 1 and Area 2 are different.
 - 3) Enter the node to be refreshed.
 - 4) Enter the node to be refreshed.
 - Set the number of words in Area 1 to 636, and set the Offset to 0.
 - Set the number of words in Area 2 to 0, and set the Offset to 0.
 - Click the **Add** Button. This will add Node 1 to the list. To continue, add Node 2 to the list.
 - Set the number of words in Area 1 to 636, and set the Offset to 0.
 - Set the number of words in Area 2 to 0, and set the Offset to 0.
 - Click the **Add** Button. This will add Node 2 to the list.
 - 5) Check that in Node 1 and Node 2's Area 1, the number of words is set to 636 and the Offset is set to 0.
5. Click the **Next** Button to proceed to the next step.

- Proceed to Edit Controller Link Data Link Table (2). Normally, use this screen to set the data link refresh order, but here click the **Next** Button to proceed to the next step.

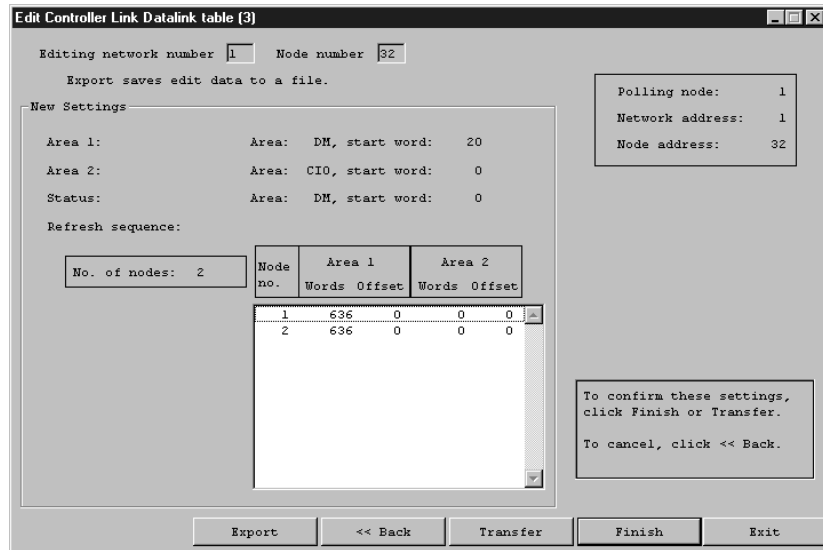

- Click the **Finish** Button. The verification dialog box will be displayed. Click the **Start** Button.

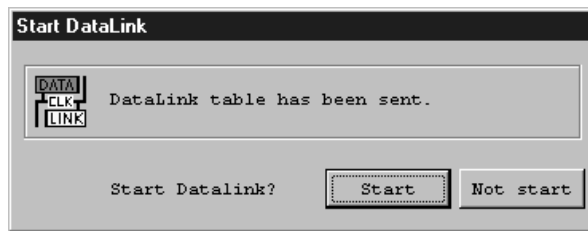

This completes the local node's data link table settings. When you click the **Start** Button, the data link will start immediately. Other node settings have not yet been completed, however, so stop the data link using the Controller Link Properties Screen.

2) Creating Data Link Tables for Other Nodes

Setting Node 1's Data Link Table

- 1, 2, 3... 1. Select **FinsGateway**, and then select **FinsGateway Settings**, and then select **Controller Link Properties**.

2. Click the **Data Link** Tab. The following dialog box will be displayed.

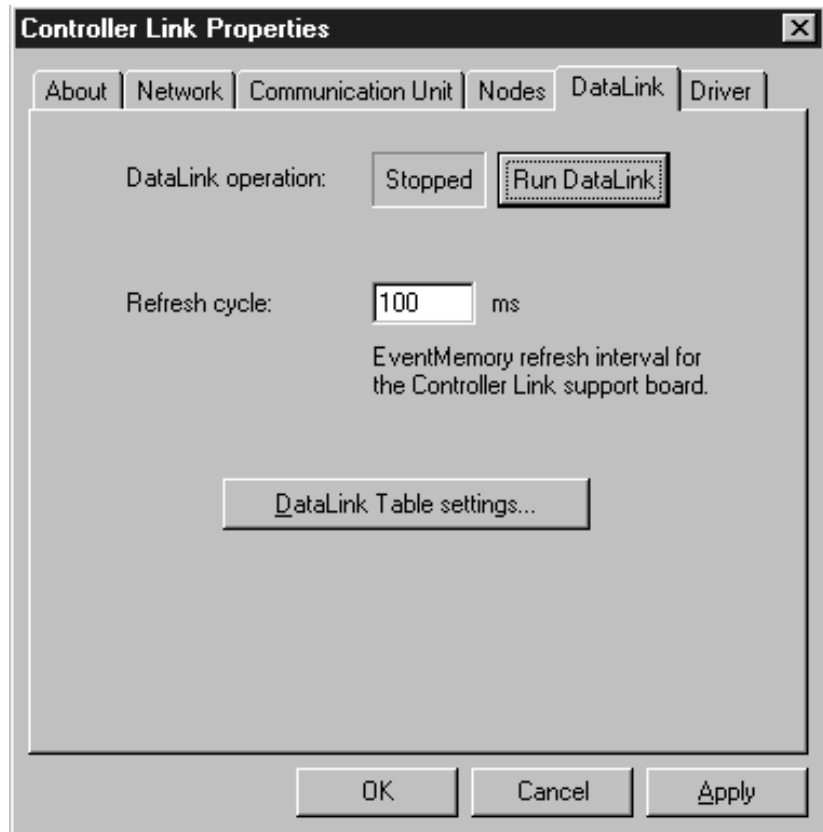

3. Click the **Data Link Table Settings** Button.

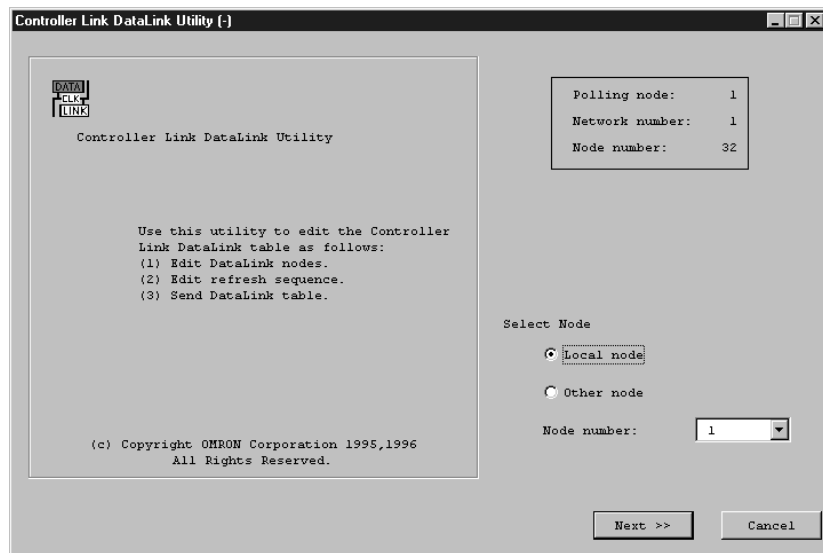

4. Select the **Other Node** Button, and set the node number to 1. Refer to the above diagram.

5. Click the **Next** Button to proceed to the next step.

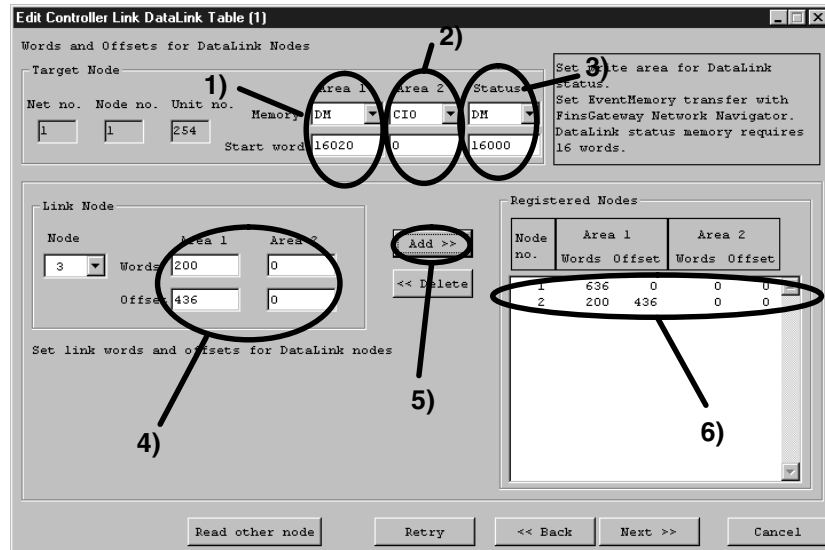

Enter fields (1) to (6) as shown above. The procedure is shown below.

Before making the settings, check that nothing is entered in column (5). If there is an entry in the column, make sure to click the **Delete** Button and delete everything.

- 1) Set the Area 1 type to DM. Set the Start Word to 16020.
 - 2) Set the Area 2 type to CIO. Area 2 is not used in monitoring, but make sure that the settings for Area 1 and Area 2 are different.
 - 3) Set the Status Area type to DM. Set the Start Word to 16000.
 - 4) Enter the node to be refreshed.
 - 5) Enter the node to be refreshed.
 - Set the number of words in Area 1 to 636, and set the Offset to 0.
 - Set the number of words in Area 2 to 0, and set the Offset to 0.
 - Click the **Add** Button. This will add Node 1 to the list. To continue, add Node 2 to the list.
 - Set the number of words in Area 1 to 200, and set the Offset to 436.
 - Set the number of words in Area 2 to 0, and set the Offset to 0.
 - Click the **Add** Button. This will add Node 2 to the list.
 - 6) Check that in Node 1's Area 1, the number of words is set to 636 and the Offset is set to 0, and that in Node 2's Area 1, the number of words is set to 200 and the Offset is set to 436.
6. Click the **Next** Button to proceed to the next step.

- Proceed to Edit Controller Link Data Link Table (2). Normally, use this screen to set the data link refresh order, but here click the **Next** Button to proceed to the next step.

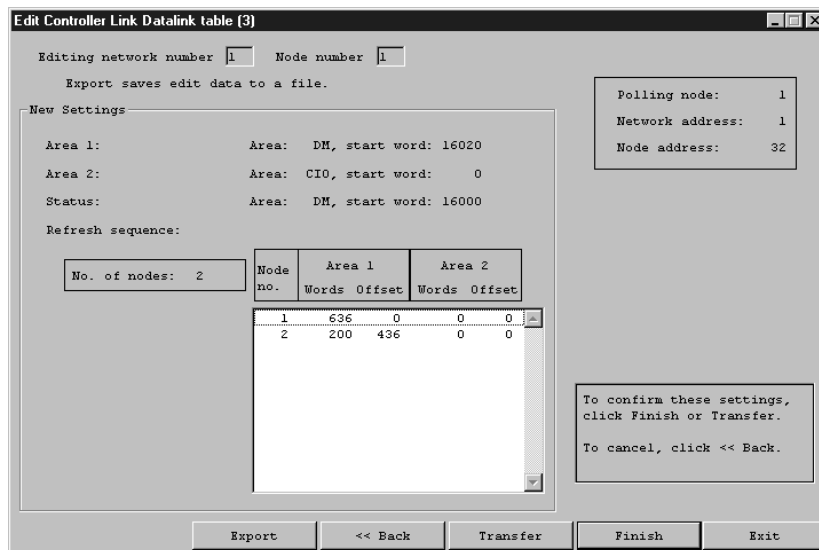

- Click the **Finish** Button. The verification dialog box will be displayed. Click the **Start** Button.



This completes Node 1's data link table settings. When you click the **Start** Button, the data link will start immediately. Node 2's settings have not yet been completed, however, so stop the data link using the Controller Link Properties Screen.

Setting Node 2's Data Link Table

- 1, 2, 3...** 1. Select **FinsGateway**, and then select **FinsGateway Settings**, and then select **Controller Link Properties**.

2. Click the **Data Link** Tab. The following dialog box will be displayed.

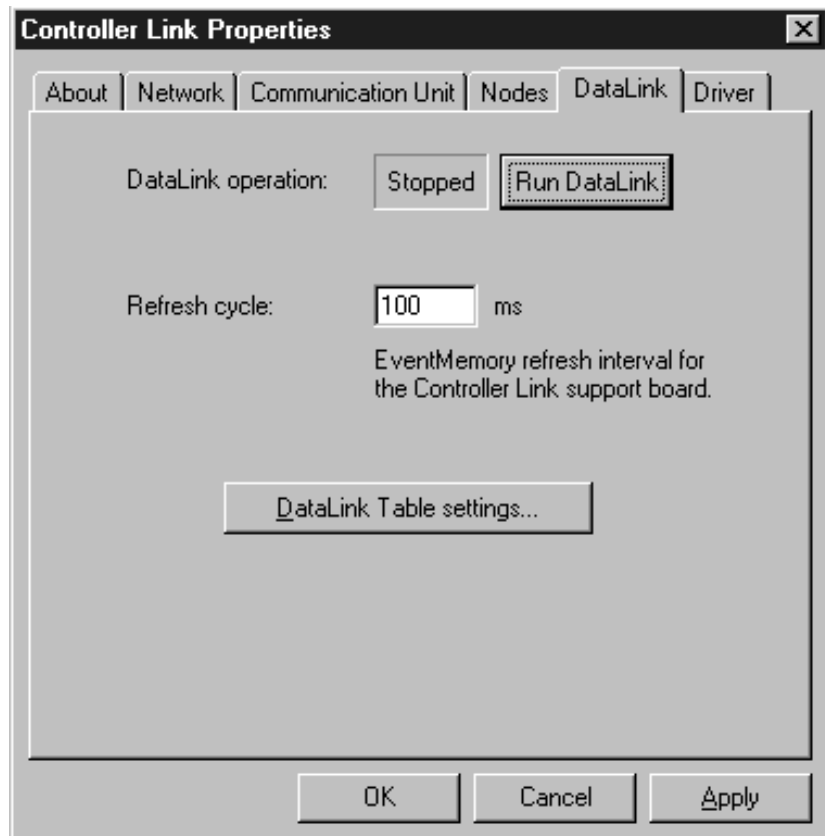

3. Click the **Data Link Table Settings** Button.

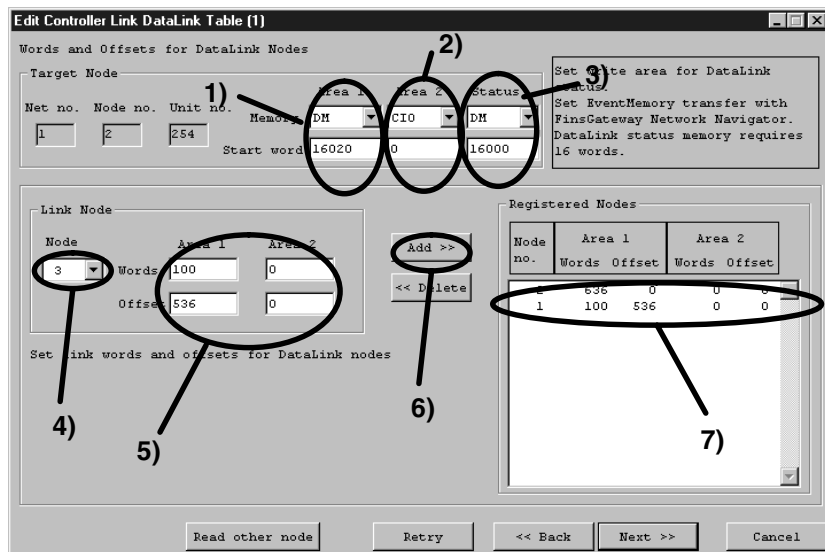

Enter fields (1) to (6) as shown above. The procedure is shown below.

Before making the settings, check that nothing is entered in column (5). If there is an entry in the column, make sure to click the **Delete** Button and delete everything.

- 1) Set the Area 1 type to DM. Set the Start Word to 16020.
- 2) Set the Area 2 type to CIO. Area 2 is not used in monitoring, but make sure that the settings for Area 1 and Area 2 are different.
- 3) Set the Status Area type to DM. Set the Start Word to 16000.

- 4) Set the Node to 2.
- 5) Enter the node to be refreshed.
- 6) Enter the node to be refreshed.
 - Set the number of words in Area 1 to 636, and set the Offset to 0.
 - Set the number of words in Area 2 to 0, and set the Offset to 0.
 - Click the **Add** Button. This will add Node 2 to the list. To continue, add Node 2 to the list.
 - Check that the Node in Step (4) is set to 1.
 - Set the number of words in Area 1 to 100, and set the Offset to 536.
 - Set the number of words in Area 2 to 0, and set the Offset to 0.
 - Click the **Add** Button. This will add Node 1 to the list.
- 7) Check that in Node 2's Area 1, the number of words is set to 636 and the Offset is set to 0, and that in Node 1's Area 1, the number of words is set to 100 and the Offset is set to 536.
4. Click the **Next** Button to proceed to the next step.
5. Proceed to Edit Controller Link Data Link Table (2). Normally, use this screen to set the data link refresh order, but here click the **Next** Button to proceed to the next step.

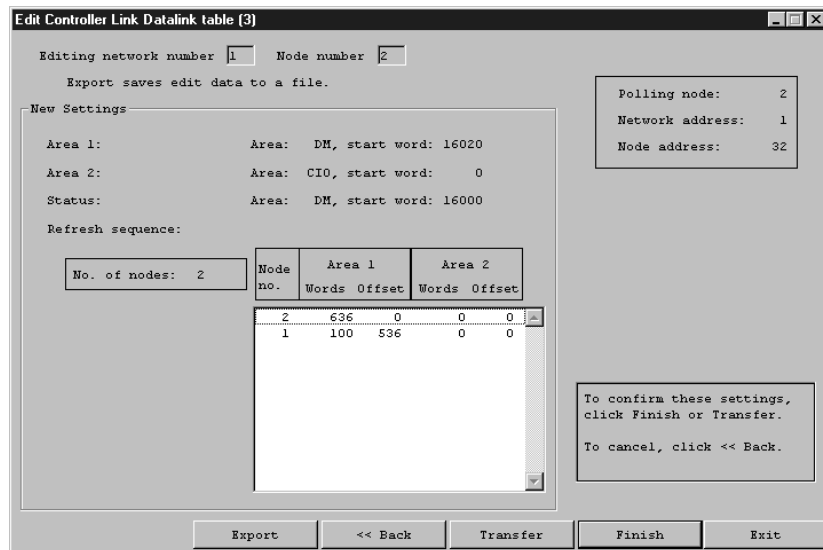

6. Click the **Finish** Button. The verification dialog box will be displayed. Click the **Start** Button.



This completes the data link settings. When you click the **Start** Button, the data link will start.

Note Check that the Controller Link Unit's indicator shows that the data link is operating. If there is an error, check for troubleshooting procedures using the *Controller Link Unit Operation Manual*.

Revision History

A manual revision code appears as a suffix to the catalog number on the front cover of the manual.

Cat. No. W373-E1-04

↑
Revision code

The following table outlines the changes made to the manual during each revision. Page numbers refer to the previous version.

Revision code	Date	Revised content
01	May 2000	Original production
02	December 2000	CX-Process Monitor version changed from 1.50 to 2.00. The manual has been updated for this version change as summarized in section 1-1-8.
03	September 2001	CX-Process Monitor version changed from 2.00 to 2.50. The manual has been updated for this version change as summarized in section 1-1-8.
04	December 2003	CX-Process Monitor version changed from 2.50 to 2.60. The manual has been updated for this version change as summarized in section 1-1-8.

OMRON Corporation

FA Systems Division H.Q.

66 Matsumoto

Mishima-city, Shizuoka 411-8511

Japan

Tel: (81)55-977-9181/Fax: (81)55-977-9045

Regional Headquarters

OMRON EUROPE B.V.

Wegalaan 67-69, NL-2132 JD Hoofddorp

The Netherlands

Tel: (31)2356-81-300/Fax: (31)2356-81-388

OMRON ELECTRONICS LLC

1 East Commerce Drive, Schaumburg, IL 60173

U.S.A.

Tel: (1)847-843-7900/Fax: (1)847-843-8568

OMRON ASIA PACIFIC PTE. LTD.

83 Clemenceau Avenue,

#11-01, UE Square,

Singapore 239920

Tel: (65)6835-3011/Fax: (65)6835-2711

OMRON

Authorized Distributor:

Cat. No. W373-E1-04

CS Series WS02-LCTC1-E CX-Process Monitor (Ver. 2.60)

OPERATION MANUAL

OMRON