

OMRON

PET Bottle Detection with Stainless Steel Housing

Compact, Photoelectric Sensor with
Built-in Amplifier and Teaching Function

E3ZM-B

Excellent PET Bottle Detection Washable with High-temperature, High-pressure Water

(IP69K Degree of Protection, Ambient Temperature Range: -40 to 60°C)

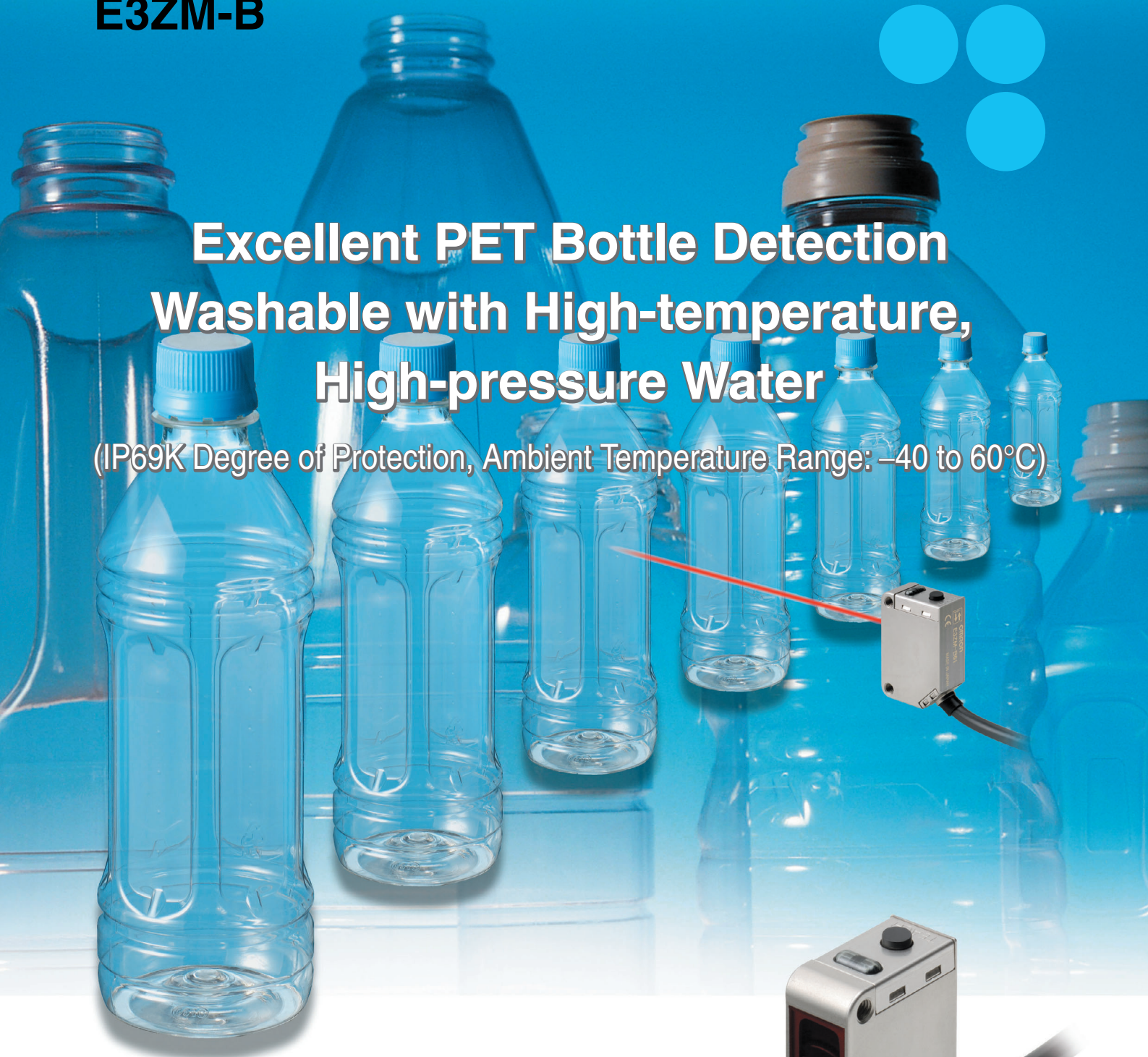

realizing

Another Advance for the E3ZM Series
in the Food and Packaging Industries.

Technology Redefines and Further Innovates PET Bottle Detection.

PET bottles are becoming more transparent and are formed in increasingly diverse shapes. The E3ZM-B Debuts as the Ultimate PET Bottle Sensor, Representing a Breakthrough in Detection Stability in the Field.

P-opaquin and a Coaxial Optical System Eliminate Dependence on the Bottle's Shape, Position, Transparency, and Contents.

P-opaquin: Polarization opaquin

Patent pending (Refer to page 10 for a technical description.)

The E3ZM-B more than triples conventional detection performance, with outstanding stability.

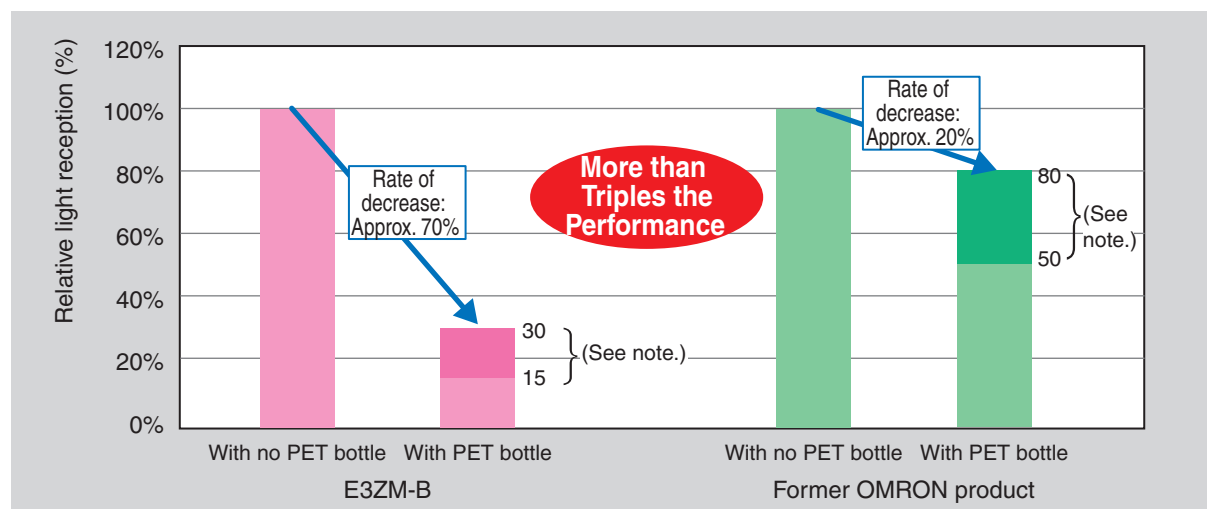

Note: Depending on the shape and position of the PET bottle.

AC³ Function Automatically Compensates Effects of Soiling and Temperature

AC³ (AC Cube): Auto Compensation Control for Contamination

Patent pending (Refer to page 10 for a technical description.)

Parameters require resetting when static electricity causes dust to adhere to the surface of the Sensor or Reflector, or when the light emission power drops due to temperature- or time-related changes. Original OMRON light emission control technology greatly reduces the resetting work involved.



Initial Condition ... Contamination ... Auto Compensation

Teaching with No Workpiece Required -- Quick and Easy Setting

There is no need for delicate sensitivity adjustments. Simply adjust the optical axes of the Sensor and Reflector, then press the Teaching button twice. This high-reliability design eliminates worries about variations in the sensitivity settings of different operators.



IP69K Degree of Protection with an SUS316L Housing

The housing is constructed of corrosion-resistant SUS316L, and the display cover is PES (polyethersulfone). Both materials are highly resistant to the effects of detergents and disinfectants. IP69K degree of protection also allows the E3ZM-B to withstand washing with high-temperature, high-pressure water. This makes the E3ZM-B well suited to use in sites requiring a high level of hygiene.



A Wide Ambient Temperature Range of -40 to 60°C

This wide temperature range meets the needs of the many and diverse applications in the beverage industry.

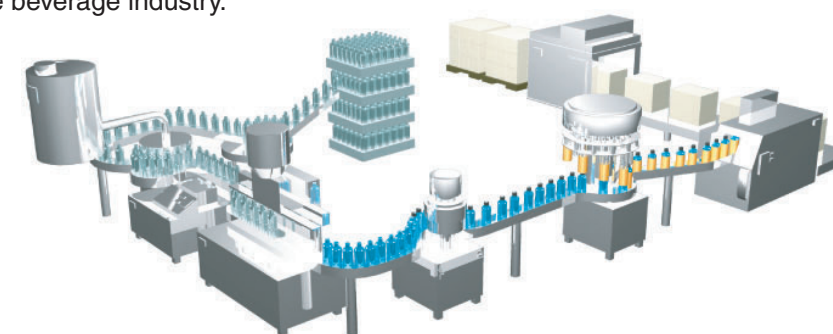

Safety Precautions

The E3ZM-B□1/-B□6 are not applicable for detecting transparent objects that exhibit no birefringence, such as glass bottles. Transparent objects made of resin also exhibit little birefringence, and cannot be detected with complete stability. Check the detection stability of objects such as these prior to actual operation.

E3ZM-B

Excellent PET Bottle Detection

- New detection method that is completely independent of the bottle shape, position, transparency, and contents.
- Automatic compensation for the effects of contamination and temperature.
- Teaching with no workpiece required for quick and easy setting.
- IP69K degree of protection from SUS316L housing.
- Wide ambient temperature range of -40 to 60°C.



Ordering Information

Sensors

Red light

Sensing method	Appearance	Connection method	Sensing distance	Model		
				Special reflector	NPN output	PNP output
Retroreflective with MSR function		Pre-wired (2 m) *2	 500 mm [100 mm] *1	Purchased separately	E3ZM-B61	E3ZM-B81
		Connector (M8, 4 pins)			E3ZM-B66	E3ZM-B86
		Pre-wired (2 m) *2		Included	E3ZM-B61-C	E3ZM-B81-C
		Connector (M8, 4 pins)			E3ZM-B66-C	E3ZM-B86-C

*1. Values in parentheses indicate the minimum required distance between the Sensor and Reflector.

*2. Models with a 5-m pre-wired cable are also available. When ordering, add the cable length to the end of the model number (e.g., E3ZM-B61 5M).

Accessories









Special Retroreflective Reflector

Name	Model	Sensing distance (rated)	Quantity	Remarks
		E3ZM-B□1/-B□6		
Special Polarizing Reflector	E39-RP1	 500 mm [100 mm] *	1	A Reflector is provided with the E3ZM-B□□-C. A Reflector is not provided with the E3ZM-B□□. The MSR function is enabled.

Note: Conventional OMRON Retroreflective Reflectors (E39-R1/-R1S/-R2/-R3/-R9/-R10/-R1K/-RS1/-RS2/-RS3, etc.) cannot be used with the E3ZM-B.



* Values in parentheses indicate the minimum required distance between the Sensor and Reflector.

Mounting Brackets

Appearance	Model (Material)	Quantity	Remarks	Appearance	Model (Material)	Quantity	Remarks
	E39-L153 (SUS304)	1	Mounting Brackets		E39-L98 (SUS304)	1	Metal Protective Cover Bracket *
	E39-L104 (SUS304)	1			E39-L150 (SUS304)	1 set	(Sensor adjuster)
	E39-L43 (SUS304)	1	Horizontal Mounting Bracket *		E39-L151 (SUS304)	1 set	Easily mounted to the aluminum frame rails of conveyors and easily adjusted. For vertical angle adjustment
	E39-L142 (SUS304)	1	Horizontal Protective Cover Bracket *				
	E39-L44 (SUS304)	1	Rear Mounting Bracket		E39-L144 (SUS304)	1	Compact Protective Cover Bracket *

* Cannot be used for Standard Connector models.

Sensor I/O Connectors

Size	Cable	Appearance	Cable type		Model
M8 (4 pins)	Standard	Straight 	2 m	4-wire	XS3F-M421-402-A
			5 m		XS3F-M421-405-A
		L-shaped 	2 m		XS3F-M422-402-A
			5 m		XS3F-M422-405-A

Note: The outer cover of the cable is made of PVC (polyvinyl chloride), the degree of protection is IP67 (IEC 60529). When high-pressure washing will be used, select an I/O Connector that has IP69K degree of protection.

E3ZM-B

Ratings and Specifications

Sensing method		Retroreflective with P-opaqing (*1) and MSR functions
Model	NPN output	E3ZM-B61(-C)/-B66(-C)
Item	PNP output	E3ZM-B81(-C)/-B86(-C)
Sensing distance	100 to 500 mm (Using E39-RP1)	
Standard sensing object	500-ml, transparent, round PET bottle (65-mm dia.)	
Directional angle	Sensor: 3° to 10° Reflector: 30°	
Light source (wavelength)	Red LED (650 nm)	
Power supply voltage	10 to 30 VDC, including 10% ripple (p-p)	
Current consumption	450 mW max. (current consumption for a 30-V power supply voltage: 15 mA max.)	
Control output	Load power supply voltage: 30 VDC max., Load current: 100 mA max. (Residual voltage: 2 V max.) Open-collector output (NPN/PNP output depending on model)	
Operating modes	Light-ON/Dark-ON cable switch selectable	
Protection circuits	Reversed power supply polarity, Load short-circuit protection, Mutual interference prevention, and Reversed output polarity protection	
Response time	Operate or reset: 1 ms max.	
Sensitivity adjustment	Teaching method	
Ambient illumination	Incandescent lamp: 3,000 lx max., Sunlight: 10,000 lx max.	
Ambient temperature range	Operating: -40 to 60°C (*2), Storage: -40 to 70°C (with no icing or condensation)	
Ambient humidity range	Operating: 35% to 85%, Storage: 35% to 95% (with no condensation)	
Insulation resistance	20 MΩ min. at 500 VDC	
Dielectric strength	1,000 VAC, 50/60 Hz for 1 min	
Vibration resistance	Destruction: 10 to 55 Hz, 1.5-mm double amplitude for 2 hours each in X, Y, and Z directions	
Shock resistance	Destruction: 500 m/s ² 3 times each in X, Y, and Z directions	
Degree of protection	IEC 60529: IP67, DIN 40050-9: IP69K (*3)	
Connection method	Pre-wired cable (standard length: 2 m) or M8 4-pin connector	
Indicator	Operating indicator (yellow), Stability indicator (green), and Teaching indicator (red)	
Weight (packed state)	Pre-wired models: Approx. 85 g Connector models: Approx. 35 g	
Materials	Housing	SUS316L
	Lens	PMMA (polymethylmethacrylate)
	Indication	PES (polyethersulfone)
	Buttons	Fluoro rubber
	Cable	PVC (polyvinyl chloride)
Accessories *4	Instruction sheet, Special Reflector (E3ZM-B□□-C only)	

*1. For information on the P-opaqing function, refer to pages →2 and 10.

*2. Do not bend the cable in temperatures of -25°C or lower.

*3. IP69K Degree of Protection Specification

IP69K is a protection standard against high temperature and high-pressure water defined in the German standard DIN 40050, Part 9. The test piece is sprayed with water at 80°C at a water pressure of 80 to 100 BAR using a specified nozzle shape at a rate of 14 to 16 liters/min.

The distance between the test piece and nozzle is 10 to 15 cm, and water is sprayed horizontally for 30 seconds each at 0°, 30°, 60°, and 90° while rotating the test piece on a horizontal plane.

*4. Mounting Brackets are purchased separately.

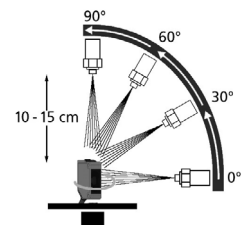

Engineering Data (Typical)

Parallel Operating Range (Horizontal)

E3ZM-B□1/B□6 +

E39-RP1 (Special Reflector)

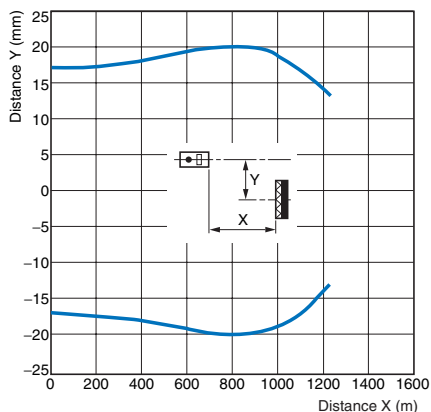

Parallel Operating Range (Vertical)

E3ZM-B□1/B□6 +

E39-RP1 (Special Reflector)

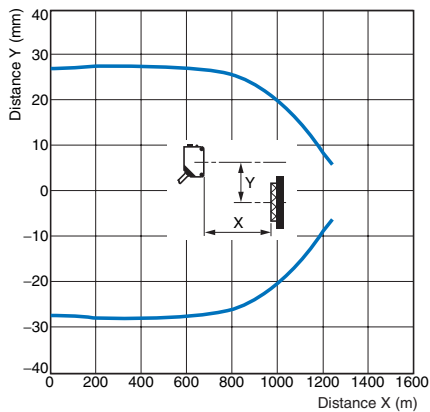

Excess Gain vs. Distance

E3ZM-B□1/B□6 +

E39-RP1 (Special Reflector)

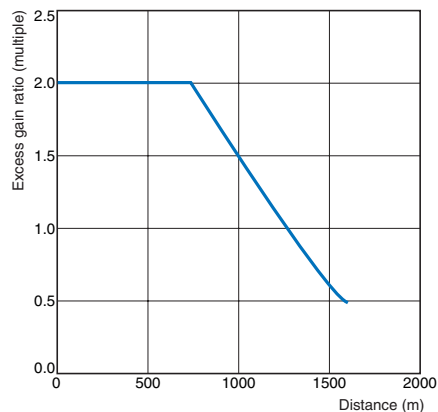

Note: The AC³ function controls the excess gain ratio to be a constant multiple of 2.

Dark Excess Gain vs. Sensing Object Characteristics

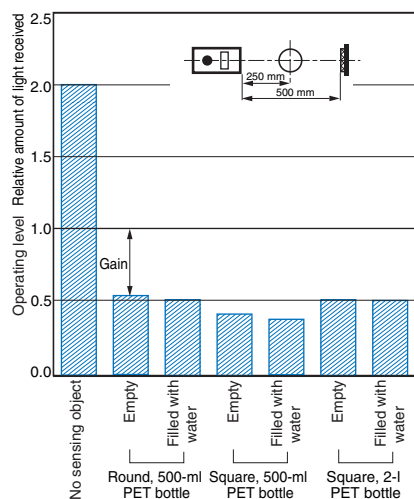

Dark Excess Gain vs. Position

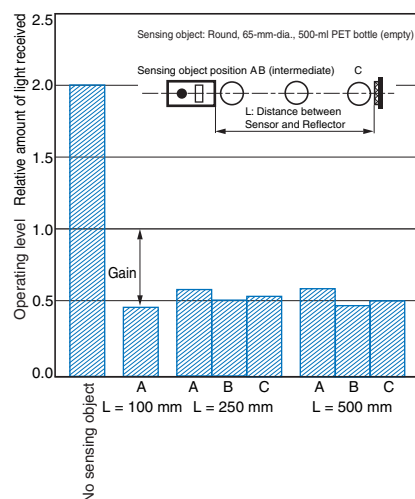

E3ZM-B

I/O Circuit Diagrams

NPN Output

Model	Operation mode	Timing charts	Operation selector	Output circuit
E3ZM-B61 E3ZM-B66	Light-ON		Connect pink lead (2) to brown lead (1).	
	Dark-ON		Connect pink lead (2) to blue lead (3) or leave open.	

PNP Output

Model	Operation mode	Timing charts	Operation selector	Output circuit
E3ZM-B81 E3ZM-B86	Light-ON		Connect pink lead (2) to brown lead (1).	
	Dark-ON		Connect pink lead (2) to blue lead (3) or leave open.	

Plugs (Sensor I/O Connectors)

M8 4-pin Connectors

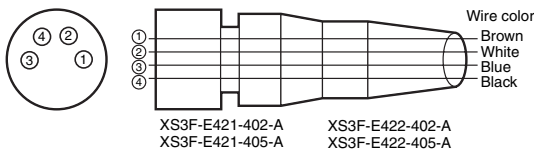

Classification	Wire color	Connector pin No.	Application
DC	Brown	1	Power supply (+V)
	White	2	Operation selection
	Blue	3	Power supply (0 V)
	Black	4	Output

Note: The above M8 Connectors made by OMRON are IP67. Do not use them in an environment where IP69K is required.

Nomenclature

Teaching Models

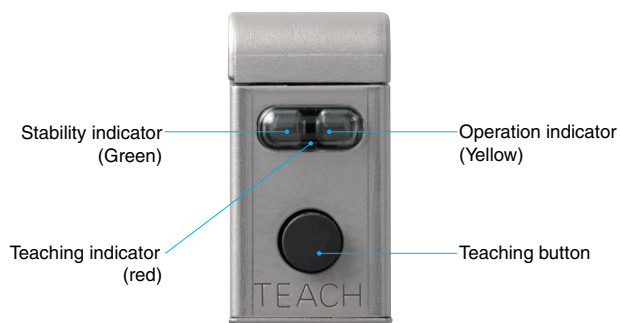

Note: When the Sensor is first unpacked and used, the teaching indicator (red) will flash slowly to show that teaching has not yet been done. This does not indicate a malfunction. Use the following procedure to conduct teaching.

Teaching Method

- 1. Install the Sensor and Reflector and adjust the optical axis (without placing a PET bottle between them). Then press and hold the teaching button for at least 2 seconds.**

The teaching indicator (red) will start flashing quickly. Perform the following operation within 7 seconds after first starting to press the teaching button. (After 7 seconds, the Unit will return to its initial condition.)



- 2. Press the teaching button again.**
Teaching will then begin.
The teaching indicator will remain lit during the teaching operation.



When Teaching Is Successful

The teaching indicator (red) will go out. The Unit will then enter normal operating condition.

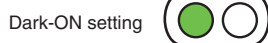

When Teaching Is Not Successful

The teaching indicator (red) will flash slowly or quickly.

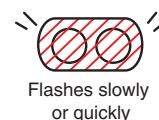

The teaching indicator (red) will then begin flashing even more slowly, indicating that the teaching operation should begin.

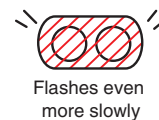

Repeat the operation starting with step 1.

Note: Depending on the amount of light received, the operation indicator and stability indicator may also change during the teaching operation.

E3ZM-B

Technical Descriptions

New Technology for Detecting Transparent Objects Exhibiting Birefringence **Patent Pending** **P-opaquing (Polarization-opaquing)**

Conventional photoelectric sensors for detecting PET bottles depend on refraction due to the bottle's shape or on the attenuation of light intensity caused by surface reflection. However, it is difficult to attain a sufficient level of excess gain with these methods.

The E3ZM-B utilizes the birefringent (double refraction) property of PET bottles to dramatically increase the level of excess gain. The polarization component that is disturbed by the PET bottles as they pass along the line is cut by a special and unique OMRON polarization filter. This greatly lowers the intensity of the light received to provide stable detection with simple sensitivity adjustment.

"P-opaquing" is a word that was coined to refer to the process of applying polarization in order to opaque transparent objects that exhibit the property of birefringence.

The excess gain of the E3ZM-B is doubled for both light-ON and dark-ON applications.

The excellent stability of the E3ZM-B prevents malfunctions from occurring even if something causes the intensity of light received to fluctuate by $\pm 50\%$.

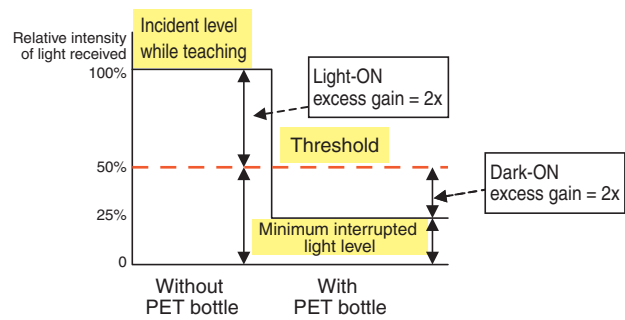
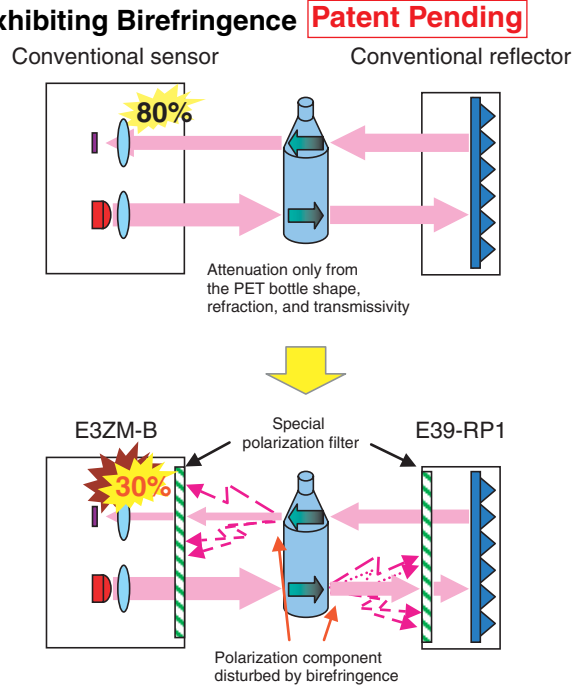

New Technology for Achieving Long-term Stability **Patent Pending** **AC³ (AC cube: Auto Compensation Control for Contamination)**

Conventional photoelectric sensors with built-in amplifiers are not equipped with functions to compensate for changes in the intensity of light received caused by dust and other lens-soiling matter, ambient temperature, and changes that occur in the LED over time. This makes it comparatively difficult to achieve long-term, stable detection of objects that exhibit little change in the intensity of light received, such as transparent objects.

The AC³ (AC cube) function provided on the E3ZM-B periodically feeds the intensity of light received during light-ON operation back to the light-emitting circuit, to keep the intensity equal to the value set by teaching.

This allows the E3ZM-B to attain long-term, stable detection while helping to cut down on maintenance requirements and improve the equipment operating ratio.

Note: The AC³ function cannot be used for dark-ON operation.

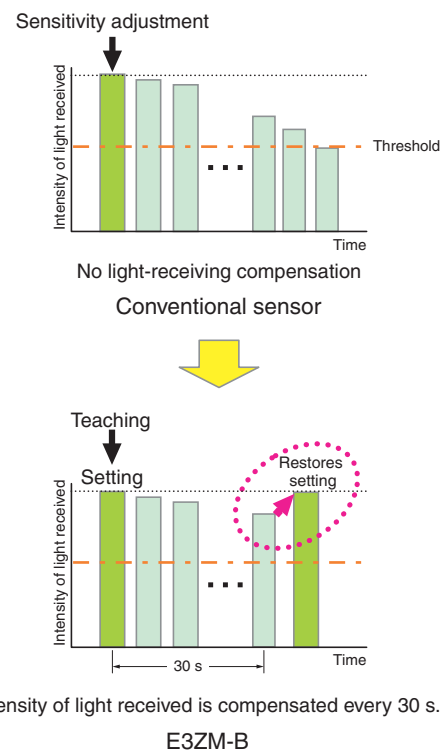

Safety Precautions

Refer to Warranty and Limitations of Liability on page 15.

WARNING

This product is not designed or rated for directly or indirectly ensuring safety of persons. Do not use it for such a purpose.



CAUTION

Do not use the product with voltage in excess of the rated voltage. Excess voltage may result in malfunction or fire.



Never use the product with an AC power supply. Otherwise, explosion may result.



When cleaning the product, do not apply a high-pressure spray of water to one part of the product. Otherwise, parts may become damaged and the degree of protection may be degraded.



Precautions for Safe Use

The following precautions must be observed to ensure safe operation of the Sensor.

Operating Environment

Do not use the Sensor in an environment where explosive or flammable gas is present.

Connecting Connectors

Be sure to hold the connector cover when inserting or removing the connector.

When using an XS3F Connector, be sure to tighten the connector lock by hand; do not use pliers or other tools.

If the tightening is insufficient, the degree of protection will not be maintained and the Sensor may become loose due to vibration. The appropriate tightening torque is 0.3 to 0.4 N·m.

When using another, commercially available connector, follow the usage and tightening torque instructions provided by the manufacturer.

Load

Do not use a load that exceeds the rated load.

Low-temperature Environments

Do not touch the metal surface with your bare hands when the temperature is low. Touching the surface may result in a cold burn.

Oily Environments

Do not use the Sensor in oily environments. They may damage parts and reduce the degree of protection.

Modifications

Do not attempt to disassemble, repair, or modify the Sensor.

Outdoor Use

Do not use the Sensor in locations subject to direct sunlight.

Cleaning

Do not use thinner, alcohol, or other organic solvents. Otherwise, the optical properties and degree of protection may be degraded.

Cleaning

Do not use highly concentrated cleaning agents. Otherwise, malfunction may result. Also, do not use high-pressure water with a level of pressure that exceeds the stipulated level. Otherwise, the degree of protection may be reduced.

Surface Temperature

Burn injury may occur. The Sensor surface temperature rises depending on application conditions, such as the ambient temperature and the power supply voltage. Use caution when operating or performing maintenance on the Sensor.

Cable Bending

Do not bend the cable in temperatures of -25°C or below. Otherwise, the cable may be damaged.

Precautions for Correct Use

Do not use the Sensor in any atmosphere or environment that exceeds the ratings.

Do not install the Sensor in the following locations.

- (1) Locations subject to direct sunlight
- (2) Locations subject to condensation due to high humidity
- (3) Locations subject to corrosive gas
- (4) Locations where the Sensor may receive direct vibration or shock

Connecting and Mounting

- (1) The maximum power supply voltage is 30 VDC. Before turning the power ON, make sure that the power supply voltage does not exceed the maximum voltage.
- (2) Laying Sensor wiring in the same conduit or duct as high-voltage wires or power lines may result in malfunction or damage due to induction. As a general rule, wire the Sensor in a separate conduit or use shielded cable.
- (3) Use an extension cable with a minimum thickness of 0.3 mm² and less than 100 m long.
- (4) Do not pull on the cable with excessive force.
- (5) Pounding the Photoelectric Sensor with a hammer or other tool during mounting will impair water resistance. Also, use M3 screws.
- (6) Mount the Sensor either using the bracket (sold separately) or on a flat surface.
- (7) Be sure to turn OFF the power supply before inserting or removing the connector.

Power Supply

If a commercial switching regulator is used, ground the FG (frame ground) terminal.

Power Supply Reset Time

The Sensor will be able to detect objects 100 ms after the power supply is tuned ON. Start using the Sensor 100 ms or more after turning ON the power supply. If the load and the Sensor are connected to separate power supplies, be sure to turn ON the Sensor first.

Turning OFF the Power Supply

Output pulses may be generated even when the power supply is OFF.

Therefore, it is recommended to first turn OFF the power supply for the load or the load line.

Load Short-circuit Protection

This Sensor is equipped with load short-circuit protection, but be sure to not short circuit the load. Be sure to not use an output current flow that exceeds the rated current. If a load short circuit occurs, the output will turn OFF, so check the wiring before turning ON the power supply again. The short-circuit protection circuit will be reset. The load shortcircuit protection will operate when the current flow reaches 1.8 times the rated load current. When using a capacitive load, use an inrush current of 1.8 times the rated load current or lower.

Water Resistance

Do not use the Sensor in water, rainfall, or outdoors.

When disposing of the Sensor, treat it as industrial waste.

Mounting Diagram

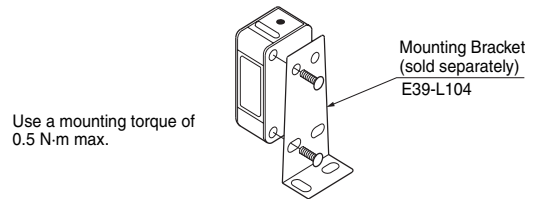

Resistance to Detergents, Disinfectants, and Chemicals

- The Sensor will maintain sufficient performance in typical detergents and disinfectants, but performance may suffer in some types of detergents, disinfectants, and chemicals. Refer to the following table prior to use.
- The E3ZM has passed detergent and disinfectant resistance testing for the substances listed in the following table. Use this table as a guide when considering detergents and disinfectants.

Type	Product name	Concentration	Temperature	Time
Chemicals	Sodium hydroxide, NaOH	1.5%	70°C	240 h
	Potassium hydroxide, KOH	1.5%	70°C	240 h
	Phosphoric acid, H ₃ PO ₄	2.5%	70°C	240 h
	Sodium hypochlorite, NaClO	0.3%	25°C	240 h
	Hydrogen peroxide, H ₂ O ₂	6.5%	25°C	240 h
Alkaline foaming cleansers	Topax 66s (Ecolab)	3.0%	70°C	240 h
Acidic foaming cleansers	Topax 56 (Ecolab)	5.0%	70°C	240 h
Disinfectants	Oxonia Active 90 (Ecolab)	1.0%	25°C	240 h
	TEK121 (ABC Compounding)	1.1%	25°C	240 h

Note: The Sensor was immersed in the above chemicals, detergents, and disinfectants for 240 h at the temperatures given, and then passed an insulation resistance test at 100 MΩ min.

Dimensions

Note: All units are in millimeters unless otherwise indicated.

Sensors

Retro-reflective Models

Pre-wired Models

E3ZM-B61

E3ZM-B81

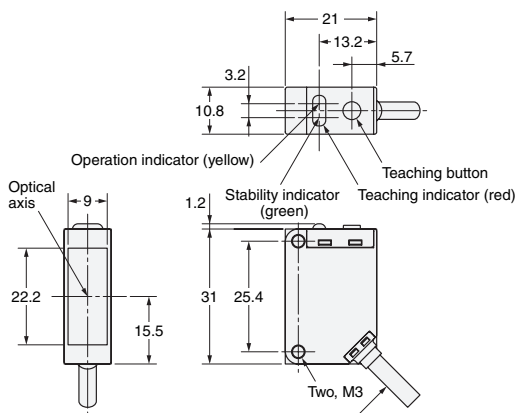

4-dia. Vinyl-insulated round cable with 4 conductors
(Conductor cross section: 0.2 mm² (AWG.24), Insulator diameter: 1.1 mm), Standard length: 2 m

Retro-reflective Models

M8 Connector

E3ZM-B66

E3ZM-B86

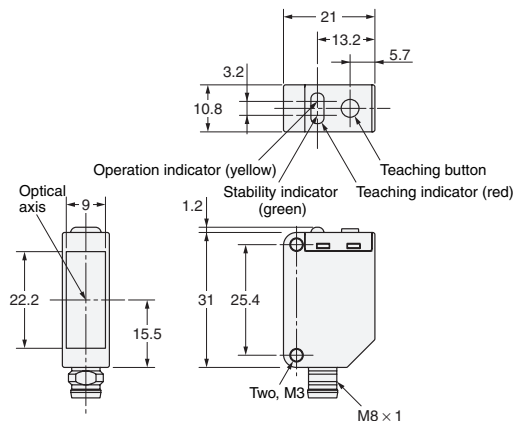

Terminal No.	Specifications
1	+V
2	Operation selection
3	0 V
4	Output

Accessory

Special Retroreflective Reflector

E39-RP1

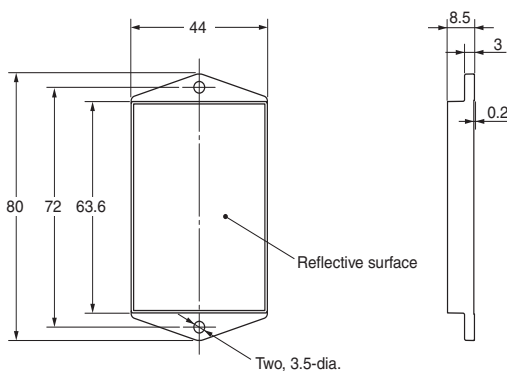

E3ZM-B

E3ZM Family

Ideal for the Food Industry. E3ZM Standard Model

Sensing method	Through-beam	Retro-reflective with MSR function	Diffuse-reflective	BGS reflective (fixed distance)
Appearance				

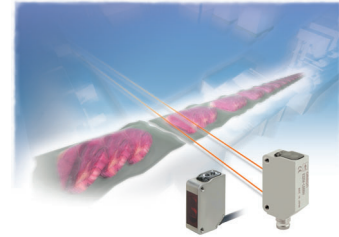

Ratings and Specifications

Sensing method		Through-beam		Retro-reflective with MSR function	Diffuse-reflective Models	
Model	NPN output	Pre-wire (2 m)	E3ZM-T61	E3ZM-T63	E3ZM-R61	E3ZM-D62
		Connector (M8, 4Pins)	E3ZM-T66	E3ZM-T68	E3ZM-R66	E3ZM-D67
Item	PNP output	Pre-wire (2 m)	E3ZM-T81	E3ZM-T83	E3ZM-R81	E3ZM-D82
		Connector (M8, 4Pins)	E3ZM-T86	E3ZM-T88	E3ZM-R86	E3ZM-D87
Sensing distance		15 m	0.8 m	4 m [100 mm] (Using E39-R1S) 3 m [100 mm] (Using E39-R1)	1 m (White paper 300 × 300 mm)	
Spot diameter (typical)		---				
Standard sensing object		Opaque: 12-mm dia. min.	Opaque: 2-mm dia. min.	Opaque: 75-mm dia. min.	---	
Differential travel		---			20% of sensing distance max.	
Black/white error		---				
Directional angle		Emitter, Receiver: 3° to 15°		Sensor: 3° to 10° Reflector: 30°	---	
Light source (wavelength)		Infrared LED (870 nm)		Red LED (660 nm)	Infrared LED (860 nm)	
Power supply voltage		10 to 30 VDC, including 10% ripple (p-p)				
Current consumption		Emitter, Receiver: 20 mA max. each		25 mA max.		
Control output		Load power supply voltage: 30 VDC max., Load current: 100 mA max. (Residual voltage: 2 V max.) Open-collector output (NPN/PNP output depending on model) Light-ON/Dark-ON switch selectable				
Protection circuits		Reversed power supply polarity protection, Output short-circuit protection, and Reversed output polarity protection		Reversed power supply polarity protection, Output short-circuit protection, Mutual interference prevention, and Reversed output polarity protection		
Response time		Operate or reset: 1 ms max.				
Sensitivity adjustment		One-turn adjuster				
Ambient temperature range*		Operating: -25 to 55°C, Storage: -40 to 70°C (with no icing or condensation)				

Sensing method		BGS Reflective Models			
Model	NPN output	Pre-wire (2 m)	E3ZM-LS61H	E3ZM-LS62H	E3ZM-LS64H
		Connector (M8, 4Pins)	E3ZM-LS66H	E3ZM-LS67H	E3ZM-LS69H
Item	PNP output	Pre-wire (2 m)	E3ZM-LS81H	E3ZM-LS82H	E3ZM-LS84H
		Connector (M8, 4Pins)	E3ZM-LS86H	E3ZM-LS87H	E3ZM-LS89H
Sensing distance		10 to 100 mm (White paper 100 × 100 mm)	10 to 150 mm (White paper 100 × 100 mm)	10 to 200 mm (White paper 100 × 100 mm)	
Spot diameter (typical)		4-mm dia. at sensing distance of 100 mm	12-mm dia. at sensing distance of 150 mm	18-mm dia. at sensing distance of 200 mm	
Standard sensing object		---			
Differential travel		3% of sensing distance max.	15% of sensing distance max.	20% of sensing distance max.	
Black/white error		5% of sensing distance max.	10% of sensing distance max.	20% of sensing distance max.	
Directional angle		---			
Light source (wavelength)		Red LED (650 nm)	Red LED (660 nm)		
Power supply voltage		10 to 30 VDC, including 10% ripple (p-p)			
Current consumption		25 mA max.			
Control output		Load power supply voltage: 30 VDC max., Load current: 100 mA max. (Residual voltage: 2 V max.) Open-collector output (NPN/PNP output depending on model) Light-ON/Dark-ON cable connection selectable			
Protection circuits		Reversed power supply polarity protection, Output short-circuit protection, Reversed output polarity protection, Mutual interference protection			
Response time		Operate or reset: 1 ms max.			
Ambient temperature range*		Operating: -25 to 55°C, Storage: -40 to 70°C (with no icing or condensation)			

* The ambient operating temperature range is different from that of the E3ZM-B, which is -40 to 60°C.

READ AND UNDERSTAND THIS DOCUMENT

Please read and understand this document before using the products. Please consult your OMRON representative if you have any questions or comments.

WARRANTY

OMRON's exclusive warranty is that the products are free from defects in materials and workmanship for a period of one year (or other period if specified) from date of sale by OMRON.

OMRON MAKES NO WARRANTY OR REPRESENTATION, EXPRESS OR IMPLIED, REGARDING NON-INFRINGEMENT, MERCHANTABILITY, OR FITNESS FOR PARTICULAR PURPOSE OF THE PRODUCTS. ANY BUYER OR USER ACKNOWLEDGES THAT THE BUYER OR USER ALONE HAS DETERMINED THAT THE PRODUCTS WILL SUITABLY MEET THE REQUIREMENTS OF THEIR INTENDED USE. OMRON DISCLAIMS ALL OTHER WARRANTIES, EXPRESS OR IMPLIED.

LIMITATIONS OF LIABILITY

OMRON SHALL NOT BE RESPONSIBLE FOR SPECIAL, INDIRECT, OR CONSEQUENTIAL DAMAGES, LOSS OF PROFITS OR COMMERCIAL LOSS IN ANY WAY CONNECTED WITH THE PRODUCTS, WHETHER SUCH CLAIM IS BASED ON CONTRACT, WARRANTY, NEGLIGENCE, OR STRICT LIABILITY.

In no event shall responsibility of OMRON for any act exceed the individual price of the product on which liability is asserted.

IN NO EVENT SHALL OMRON BE RESPONSIBLE FOR WARRANTY, REPAIR, OR OTHER CLAIMS REGARDING THE PRODUCTS UNLESS OMRON'S ANALYSIS CONFIRMS THAT THE PRODUCTS WERE PROPERLY HANDLED, STORED, INSTALLED, AND MAINTAINED AND NOT SUBJECT TO CONTAMINATION, ABUSE, MISUSE, OR INAPPROPRIATE MODIFICATION OR REPAIR.

SUITABILITY FOR USE

THE PRODUCTS CONTAINED IN THIS DOCUMENT ARE NOT SAFETY RATED. THEY ARE NOT DESIGNED OR RATED FOR ENSURING SAFETY OF PERSONS, AND SHOULD NOT BE RELIED UPON AS A SAFETY COMPONENT OR PROTECTIVE DEVICE FOR SUCH PURPOSES. Please refer to separate catalogs for OMRON's safety rated products.

OMRON shall not be responsible for conformity with any standards, codes, or regulations that apply to the combination of products in the customer's application or use of the product.

At the customer's request, OMRON will provide applicable third party certification documents identifying ratings and limitations of use that apply to the products. This information by itself is not sufficient for a complete determination of the suitability of the products in combination with the end product, machine, system, or other application or use.

The following are some examples of applications for which particular attention must be given. This is not intended to be an exhaustive list of all possible uses of the products, nor is it intended to imply that the uses listed may be suitable for the products:

- Outdoor use, uses involving potential chemical contamination or electrical interference, or conditions or uses not described in this document.
- Nuclear energy control systems, combustion systems, railroad systems, aviation systems, medical equipment, amusement machines, vehicles, safety equipment, and installations subject to separate industry or government regulations.
- Systems, machines, and equipment that could present a risk to life or property.

Please know and observe all prohibitions of use applicable to the products.

NEVER USE THE PRODUCTS FOR AN APPLICATION INVOLVING SERIOUS RISK TO LIFE OR PROPERTY WITHOUT ENSURING THAT THE SYSTEM AS A WHOLE HAS BEEN DESIGNED TO ADDRESS THE RISKS, AND THAT THE OMRON PRODUCT IS PROPERLY RATED AND INSTALLED FOR THE INTENDED USE WITHIN THE OVERALL EQUIPMENT OR SYSTEM.

PERFORMANCE DATA

Performance data given in this document is provided as a guide for the user in determining suitability and does not constitute a warranty. It may represent the result of OMRON's test conditions, and the users must correlate it to actual application requirements. Actual performance is subject to the OMRON Warranty and Limitations of Liability.

CHANGE IN SPECIFICATIONS

Product specifications and accessories may be changed at any time based on improvements and other reasons.

It is our practice to change model numbers when published ratings or features are changed, or when significant construction changes are made. However, some specifications of the product may be changed without any notice. When in doubt, special model numbers may be assigned to fix or establish key specifications for your application on your request. Please consult with your OMRON representative at any time to confirm actual specifications of purchased products.

DIMENSIONS AND WEIGHTS

Dimensions and weights are nominal and are not to be used for manufacturing purposes, even when tolerances are shown.

ERRORS AND OMISSIONS

The information in this document has been carefully checked and is believed to be accurate; however, no responsibility is assumed for clerical, typographical, or proofreading errors, or omissions.

PROGRAMMABLE PRODUCTS

OMRON shall not be responsible for the user's programming of a programmable product, or any consequence thereof.

COPYRIGHT AND COPY PERMISSION

This document shall not be copied for sales or promotions without permission.

This document is protected by copyright and is intended solely for use in conjunction with the product. Please notify us before copying or reproducing this document in any manner, for any other purpose. If copying or transmitting this document to another, please copy or transmit it in its entirety.

This document provides information mainly for selecting suitable models. Please read the Instruction sheet carefully for information that the user must understand and accept before purchase, including information on warranty, limitations of liability, and precautions.

OMRON Corporation
Industrial Automation Company

Sensing Devices Division H.Q.
Industrial Sensors Division
Shiokoji Horikawa, Shimogyo-ku,
Kyoto, 600-8530 Japan
Tel: (81)75-344-7022/Fax: (81)75-344-7107

Regional Headquarters

OMRON EUROPE B.V.
Sensor Business Unit
Carl-Benz-Str. 4, D-71154 Nufringen,
Germany
Tel: (49) 7032-811-0/Fax: (49) 7032-811-199

OMRON ELECTRONICS LLC
One Commerce Drive Schaumburg,
IL 60173-5302 U.S.A.
Tel: (1) 847-843-7900/Fax: (1) 847-843-7787

OMRON ASIA PACIFIC PTE. LTD.
No. 438A Alexandra Road # 05-05/08 (Lobby 2),
Alexandra Technopark, Singapore 119967
Tel: (65) 6835-3011/Fax: (65) 6835-2711

OMRON (CHINA) CO., LTD.
Room 2211, Bank of China Tower,
200 Yin Cheng Zhong Road,
Pu Dong New Area, Shanghai, 200120, China
Tel: (86) 21-5037-2222/Fax: (86) 21-5037-2200

Authorized Distributor:

Note: Specifications subject to change without notice.

Cat. No. E385-E1-01