

Safety Laser Scanner OS32C



OS32C Safety Laser Scanner

- Type 3 Safety Laser Scanner complies with IEC61496-1/-3.
- 70 sets of safety zone and warning zone combinations are available, supporting complicated changes in working environments.
- A safety radius up to 3 m and warning zone(s) radius up to 10 m can be set.
- Configurable minimum object resolution of 30, 40, 50 or 70 mm, for hand and arm detection applications
- 8 Individual Sector Indicators and various LED indications allow the user to determine scanner status at a glance.
- Reference Boundary Monitoring function prevents unauthorized changes in the scanner position.



Ordering information

OS32C (Power cable is sold separately.)

Appearance	Description	Model	Remarks
	OS32C with back location cable entry	OS32C-BP	CD-ROM (Configuration software) OS supported: - Windows 2000, - Windows XP, - Windows Vista, - Windows 7 Note: This laser scanner may not be sold or imported into or used in the Federal Republic of Germany prior to December 1, 2013.
	OS32C with side location cable entry ^{*1}	OS32C-SP1	

*1. For OS32C-SP1, each connector is located on the left as viewed from the back of the I/O block.

Power cable







Appearance	Description	Model	Remarks
	Cable length: 3 m	OS32C-CBL-03M	One cable is required per sensor.
	Cable length: 10 m	OS32C-CBL-10M	
	Cable length: 20 m	OS32C-CBL-20M	
	Cable length: 30 m	OS32C-CBL-30M	

Ethernet cable

Appearance	Description	Model	Remarks
	Cable length: 2 m	OS32C-ECBL-02M	Required for configuration and monitoring.
	Cable length: 5 m	OS32C-ECBL-05M	
	Cable length: 15 m	OS32C-ECBL-15M	

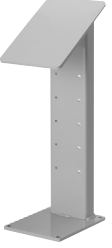

Note: An ethernet cable with an M12, 4-pin connector is required.

Mounting brackets

Appearance	Description	Model	Remarks
	Bottom/side mounting bracket	OS32C-BKT1	Bottom/side mounting bracket x 1, unit mounting screws x 4 sets
	XY axis rotation mounting bracket	OS32C-BKT2	XY axis rotation mounting bracket x 1, unit mounting screws x 6 sets, bracket mounting screws x 1 set (must be used with OS32C-BKT1)
	Simple mounting bracket	OS32C-BKT3	Simple mounting brackets x 2, unit mounting screws x 4 sets ^{*1}
	Protective cover for window	OS32C-BKT4	
	Mounting stand	OS32C-MT	When using a mounting stand, use an OS32C with side location cable entry (OS32C-SP1). The OS32C with back location cable entry (OS32C-BP) cannot be mounted. Use with mounting brackets (OS32C-BKT1 and OS32C-BKT2).
	Hardware kit for mounting stand	OS32C-HDT	Mounting screws x 3 sets Use this when mounting a bracket to the mounting stand.

*1. There are eight OS32C mounting screws: four screws for singular use, and four screws for protective cover for window.

Accessories

Appearance	Description		Model	Remarks
	Scan window		OS32C-WIN-KT	Spare for replacement
	Sensor block without I/O block		OS32C-SN	Spare for replacement
	I/O block	With cable access from the back	OS32C-CBBP	Spare for replacement
		With cable access from the left side	OS32C-CBSP1	Spare for replacement

Rating/Performance

Sensor Type	Type 3 Safety Laser Scanner	
Safety Category	Category 3, Performance Level d (ISO13849-1: 2006)	
Detection Capability	Configurable; Non-transparent with a diameter of 30, 40, 50 or 70 mm (1.8% reflectivity or greater)	
Monitoring Zone	Monitoring Zone Set Count: (Safety Zone + 2 Warning Zones) x 70 sets	
Operating Range	Safety Zone: 3.0 m (min. obj. resolution of 50 mm or 70 mm) 2.5 m (min. obj. resolution of 40 mm) 1.75 m (min. obj. resolution of 30 mm) Warning Zone: 10.0 m	
Maximum Measurement Error	100 mm ^{*1}	
Detection Angle	270°	
Angular Resolution	0.4°	
Laser Beam Diameter	6 mm at optics cover, 14 mm at 3 m.	
Response Time	Response time from ON to OFF: From 80 ms (2 scans) to 680 ms (up to 17 scans) Response time from OFF to ON: Response time from ON to OFF + 100 ms to 60 s (Configurable)	
Zone Switching Time	20 to 320 ms	
Line Voltage	24 VDC +25%/-30% (ripple p-p 2.5 V max.) ^{*2}	
Power Consumption	Normal operation: 5 W max., 4 W typical (without output load) ^{*3} Standby mode: 3.75 W (without output load)	
Emission Source (Wavelength)	Infrared Laser Diode (905 nm)	
Laser Protection Class	Class 1: IEC/EN60825-1 (2007) Class 1: JIS6802 (2005) Class I: CFR21 1040.10, 1040.11	
Safety Output (OSSD)	PNP transistor x 2, load current of 250mA max., residual voltage of 2 V max., load capacity of 2.2 µf max., leak current of 1 mA max. ^{*3,*4,*5}	
Auxiliary Output (Non-Safety)	NPN/PNP transistor x 1, load current of 100 mA max., residual voltage of 2 V max., leak current of 1 mA max. ^{*4,*5,*6}	
Warning Output (Non-Safety)	NPN/PNP transistor x 1, load current of 100 mA max., residual voltage of 2 V max., leak current of 1 mA max. ^{*4,*5,*6}	
Output Operation Mode	Auto Start, Start Interlock, Start/Restart Interlock	
Input	External Device Monitoring (EDM)	ON: 0 V short (input current of 50 mA), OFF: Open
	Start	ON: 0 V short (input current of 20 mA), OFF: Open
	Zone Select	ON: 24 V short (input current of 5 mA), OFF: Open
	Stand-by	ON: 24 V short (input current of 5 mA), OFF: Open
Connection Type	Power Cable: 18-pin mini-connector (pigtail) Communication Cable: M12, 4-pin connector	
Connection with PC ^{*7}	Communication: Ethernet OS Supported: Windows 2000, Windows XP, Windows Vista, Windows 7	
Indicators	RUN indicator: Green, STOP indicator: Red, Interlock Indicator: Yellow, Warning Output Indicator: Orange, Status/Diagnostic Display: 2 x 7-segment LEDs, Intrusion Indicators: Red LED x 8	
Ambient Temperature Operation	-10 to 50°C, Storage: -25 to 70°C	
Ambient Humidity Operation & Storage	95% RH max., non-condensing	
Protective Circuit	Protection against output load short and reverse power connection	
Enclosure Rating	IP65 (IEC60529)	
Enclosure	Sensor head: Die-cast aluminum, optical cover: Polycarbonate, I/O block: Die-cast aluminum	
Dimensions (WxHxD)	133.0 x 104.5 x 142.7 mm (except cable)	
Weight (Main Unit only)	1.3 kg	
Approvals	Certificated by: TÜV Rheinland, UL Major Standards: IEC61496-1/-3 (Type 3), IEC61508 (SIL2), ISO13849-1:2008 (Category 3, Performance Level d), UL508, UL1998	

^{*1}. An additional measurement error may need to be added due to reflective backgrounds.

^{*2}. For power source specification, refer to "Safety Precautions" on page 16.

^{*3}. Rated current of OS32C is 1.025 A max. (OS32C 210 mA + OSSD A load + OSSD B load + Auxiliary output load + Warning output load + Functional Inputs). Where functional inputs are: EDM input ... 50 mA Start input ... 20 mA Standby input ... 5 mA Zone X input ... 5 mA x 8 (eight zone set select inputs)

^{*4}. Output voltage is Input voltage - 2.0 VDC.

^{*5}. Total consumption current of 2 OSSDs, auxiliary output, and warning output must not exceed 700 mA.

^{*6}. Output polarity (NPN/PNP) is configurable via the configuration tool.

^{*7}. An ethernet cable with an M12, 4-pin connector is required.

Connection

Basic connection with single OS32C unit
 Category 3, Performance Level d (ISO13849-1)

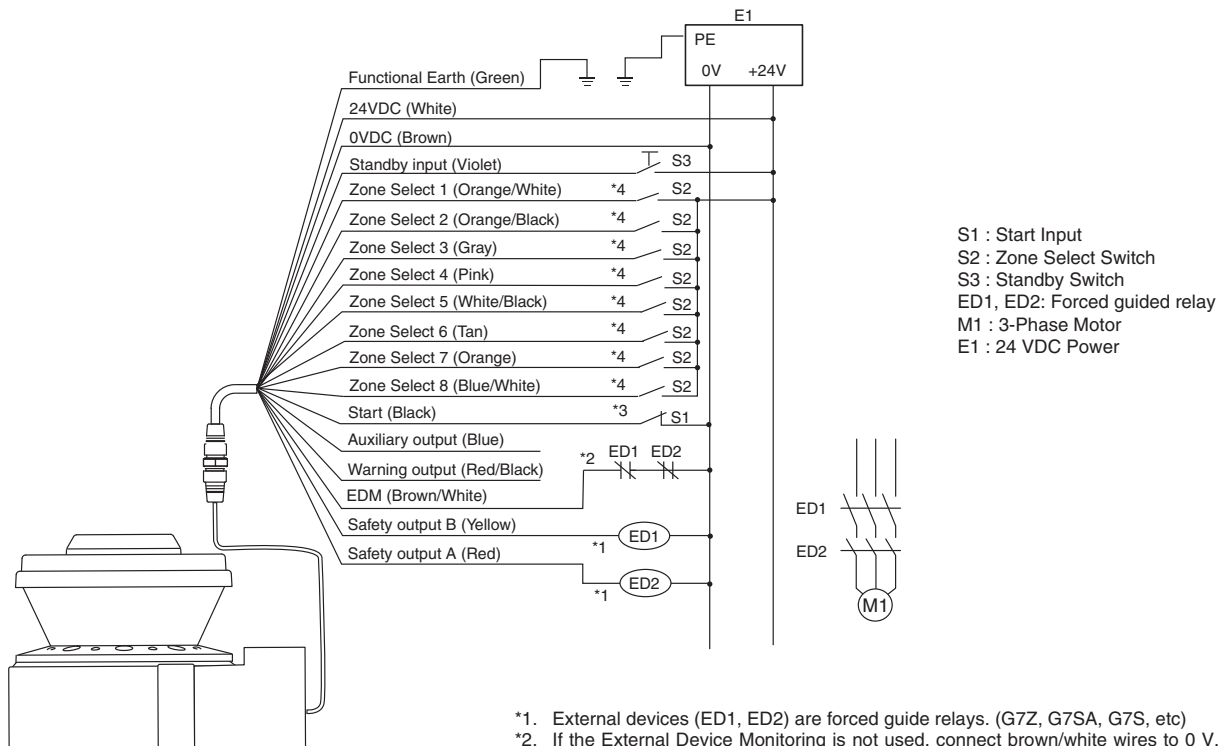

OS32C Configuration
 - External Device Monitoring Enabled
 - Start/Restart Interlock

- *1. External devices (ED1, ED2) are forced guide relays. (G7Z, G7SA, G7S, etc)
 - *2. If the External Device Monitoring is not used, connect brown/white wires to 0 V, and then turn OFF the External Device Monitoring with the configuration software.
 - *3. Use NC-contact for a start input.
 - *4. For zone select switch setting, refer to OS32C Series User's Manual.
- Note: This wiring example is for category 3.

Connecting to the Controller G9SA-301
 Category 3, Performance Level d (ISO13849-1)

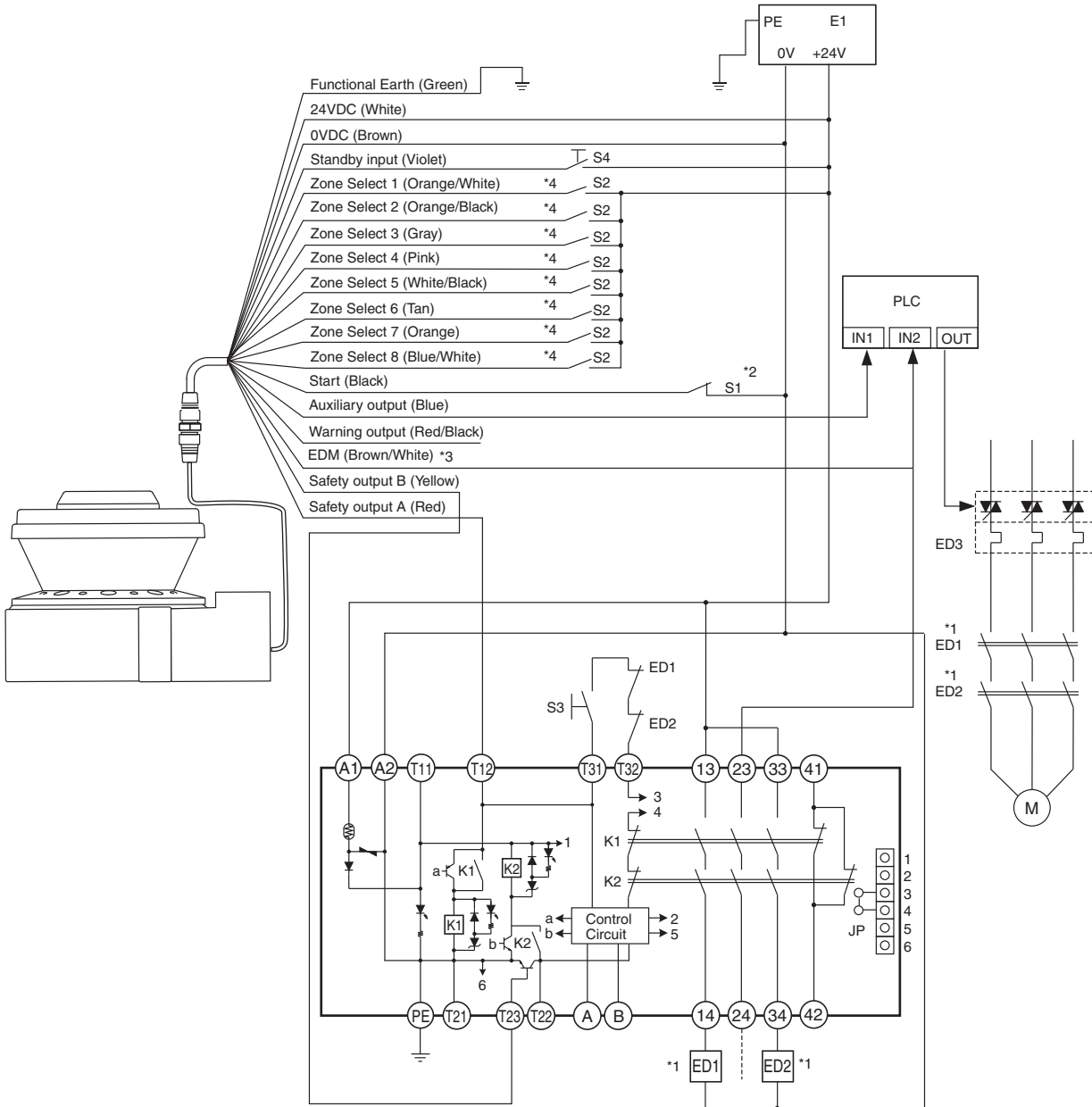

ED1, ED2: Forced guided relay
 ED3: Solid state contactor (G3J)
 M : 3-Phase Motor
 S1 : Start Input
 (use for releasing lockout)
 S2 : Zone Select Switch
 S3 : Reset Switch
 S4 : Standby Switch
 E1 : 24 VDC Power
 PLC: Programmable Controller
 (This is for monitoring only and
 unrelated to a safety system)

*1. External devices (ED1, ED2) are forced guide relays. (G7Z, G7SA, G7S, etc)

*2. Use NC-contact for a start input.

*3. If the External Device Monitoring is not used, connect brown/white wires to 0V, and then turn OFF the External Device Monitoring with the configuration software.

*4. For zone select switch setting, refer to OS32C Series User's Manual.

Note: This wiring example is for category 3.

Dimensions

OS32C with Back Location Cable Entry - OS32C-BP

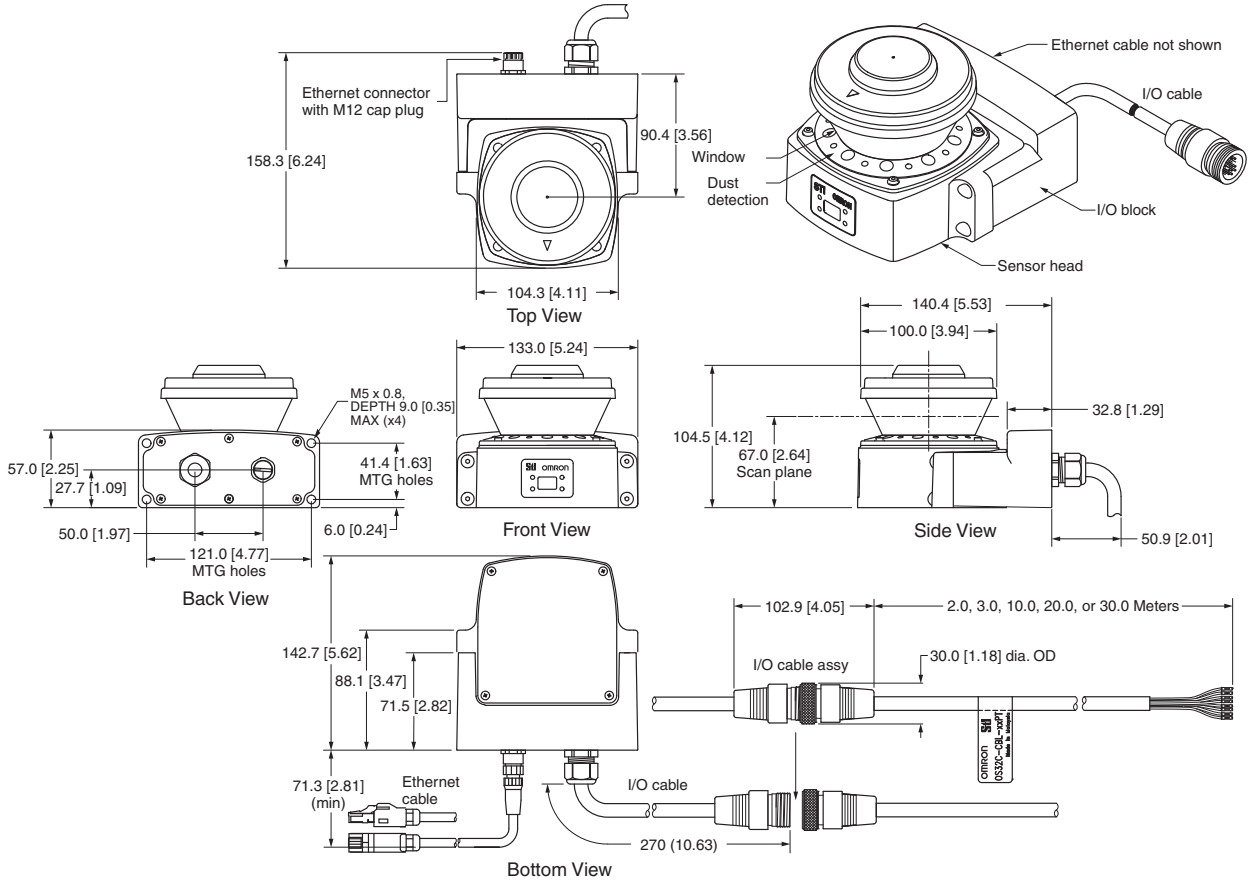

OS32C with Side Location Cable Entry - OS32C-SP1

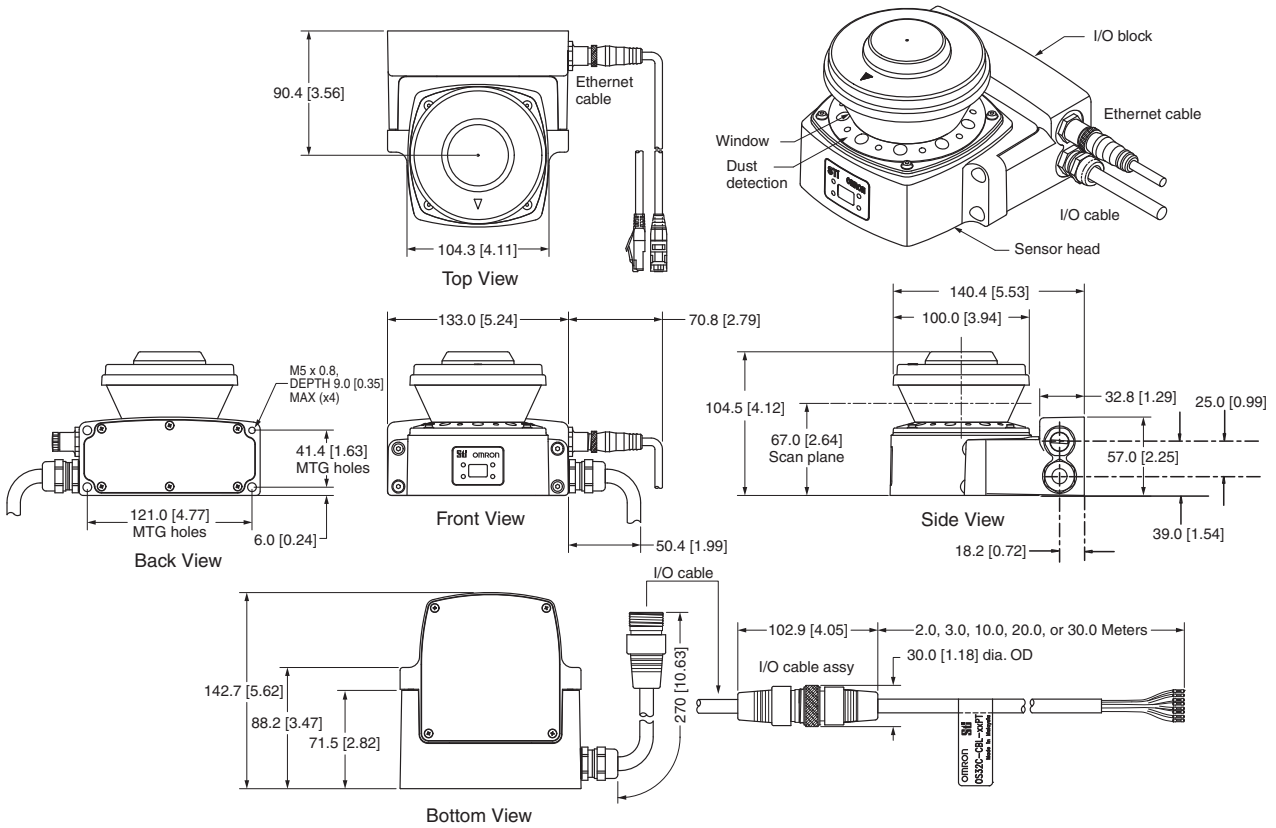

Cat. No. Z298-E1-02-X

In the interest of product improvement, specifications are subject to change without notice.

OMRON EUROPE B.V.

Wegalaan 67-69,
NL-2132 JD, Hoofddorp,
The Netherlands
Phone: +31 23 568 13 00
Fax: +31 23 568 13 88
www.industrial.omron.eu