

R7D-AP□, R7M-A□

SmartStep Series

A new concept in Servo Systems The Smart alternative to Stepper motors

- Easy to setup, easy to operate. SmartStep is as easy to use as a stepper motor
- Front-panel switches make settings easy and eliminate the need for time-consuming parameter settings
- Auto-tuning On-line mode, dynamic brake setting, alarm display, high torque performance
- Easy to wire with prebuilt cables
- Oscilloscope available via SigmaWin tool
- Windows based Configuration and commissioning software

Ratings

- 230VAC Single-phase 30 W to 750W (2.39 Nm)



AC Servo Systems

System Configuration

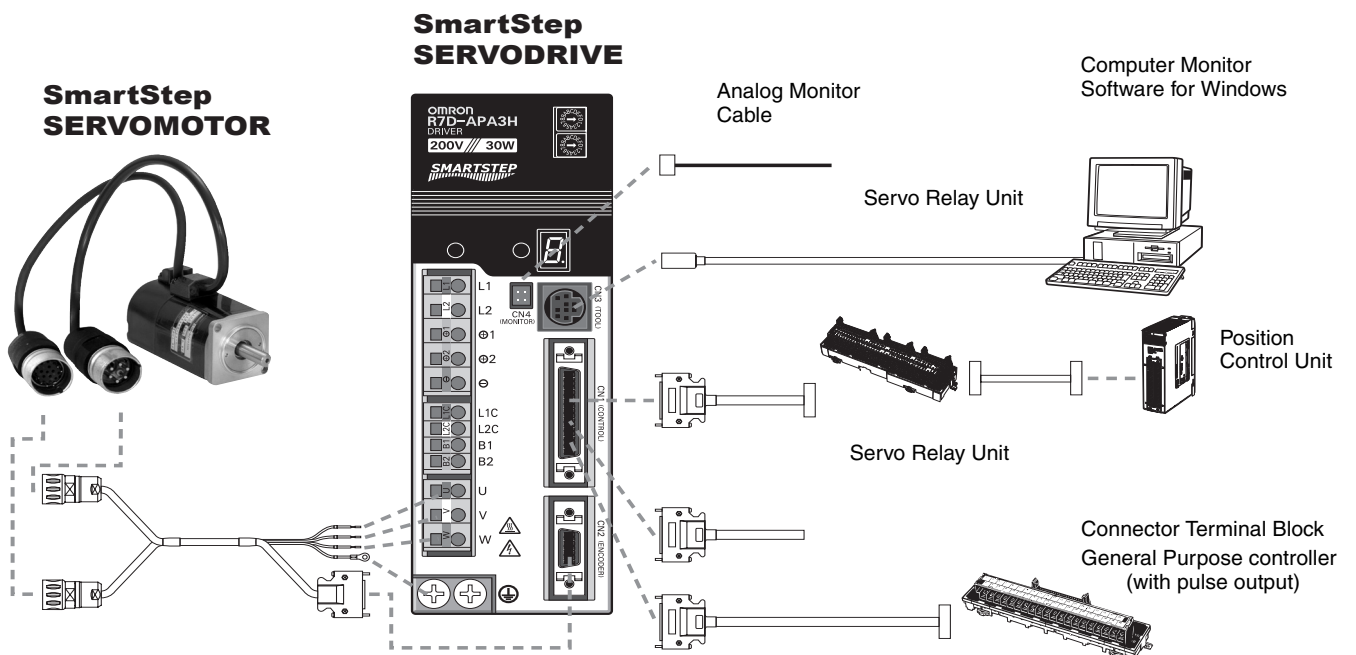

Servomotor Specifications

General Specifications

Item	Specification
Ambient operating temperature	0 to 40°C
Ambient operating humidity	20% to 80% (with no condensation)
Ambient storage temperature	-20 to 60°C
Ambient storage humidity	20% to 80% (with no condensation)
Storage/operating atmosphere	No corrosive gases.
Vibration resistance	10 to 2,500 Hz in X, Y, and Z directions with 0.2-mm double amplitude or acceleration of 24.5 m/s ² max., whichever is smaller
Impact resistance	Acceleration 98 m/s ² max., in a vertical direction, two times
Insulation resistance	Between power line terminals and FG: 10 MΩ min. (at 500 V DC)
Dielectric strength	Between power line terminals and FG: 1,500 V AC for 1 min at 50/60 Hz
Run position	Any direction
Insulation grade	Type B
Structure	Totally-enclosed self-cooling
Protective structure	IP55 for both the Cylindrical and Flat Servomotors
Vibration grade	V-15
Mounting method	Flange-mounting
International standards	Approval obtained for UL, cUL, and EN (EMC directive and low-voltage directive)

Performance Specifications

Flat Servomotors

Item		R7M-AP10030	R7M-AP20030	R7M-AP40030	R7M-AP75030
Rated output		100 W	200 W	400 W	750 W
Rated torque		0.318 N-m	0.637 N-m	1.27 N-m	2.39 N-m
Rated rotation speed		3,000 r/min	3,000 r/min	3,000 r/min	3,000 r/min
Momentary maximum rotation speed		4,500 r/min	4,500 r/min	4,500 r/min	4,500 r/min
Momentary maximum torque		0.96 N-m	1.91 N-m	3.82 N-m	7.1 N-m
Rated current		0.89 A (rms)	2.0 A (rms)	2.6 A (rms)	4.1 A (rms)
Momentary maximum current		2.8 A (rms)	6.0 A (rms)	8.0 A (rms)	13.9 A (rms)
Rotor inertia		6.5 × 10 ⁻⁶ kg-m ²	2.09 × 10 ⁻⁵ kg-m ²	3.47 × 10 ⁻⁵ kg-m ²	2.11 × 10 ⁻⁴ kg-m ²
Power rate		15.7 kW/s	19.4 kW/s	46.8 kW/s	26.9 kW/s
Allowable radial load		78 N	245 N	245 N	392 N
Allowable thrust load		49 N	68 N	68 N	147 N
Weight	Without brake	0.7 kg	1.4 kg	2.1 kg	4.2 kg
	With brake	0.9 kg	1.9 kg	2.6 kg	5.7 kg
Encoder resolution	2,000 pulses/revolution for phase-A and phase-B, 1 pulse/revolution for phase-Z				
Radiation shield dimensions	t6 × 250 mm square				t12 × 300 mm square
Brake Specifications	Brake inertia	3.1 × 10 ⁻⁶ kg-m ²	1.52 × 10 ⁻⁵ kg-m ²	1.52 × 10 ⁻⁵ kg-m ²	8.75 × 10 ⁻⁵ kg-m ²
	Excitation voltage	24 V DC ±10%			
	Power consumption (at 20°C)	7.5 W	7.6 W	8.2 W	7.5 W
	Current consumption (at 20°C)	0.31 A	0.32 A	0.34 A	0.31 A
	Static friction torque	0.4 N-m min.	0.9 N-m min.	1.9 N-m min.	3.5 N-m min.
	Attraction time	60 ms max.	40 ms max.	60 ms max.	20 ms max.
	Release time	20 ms max.	20 ms max.	20 ms max.	40 ms max.
	Backlash	1°	1°	1°	1°
	Rating	Continuous			
Insulation grade	Type F	Type F	Type F	Type F	
Applicable Servo Driver (R7D-)	AP01H	AP02H	AP04H	AP08H	

Cylindrical Servomotors

Item	R7M-A03030	R7M-A05030	R7M-A10030	R7M-A20030	R7M-A40030	R7M-A75030	
Rated output	30 W	50 W	100 W	200 W	400 W	750 W	
Rated torque	0.095 N·m	0.159 N·m	0.318 N·m	0.637 N·m	1.27 N·m	2.39 N·m	
Rated rotation speed	3,000 r/min	3,000 r/min	3,000 r/min	3,000 r/min	3,000 r/min	3,000 r/min	
Momentary maximum rotation speed	4,500 r/min	4,500 r/min	4,500 r/min	4,500 r/min	4,500 r/min	4,500 r/min	
Momentary maximum torque	0.29 N·m	0.48 N·m	0.96 N·m	1.91 N·m	3.82 N·m	7.1 N·m	
Rated current	0.42 A (rms)	0.6 A (rms)	0.87 A (rms)	2.0 A (rms)	2.6 A (rms)	4.4 A (rms)	
Momentary maximum current	1.3 A (rms)	1.9 A (rms)	2.8 A (rms)	6.0 A (rms)	8.0 A (rms)	13.9 A (rms)	
Rotor inertia	1.7×10^{-6} kg·m ²	2.2×10^{-6} kg·m ²	3.6×10^{-6} kg·m ²	1.19×10^{-5} kg·m ²	1.87×10^{-5} kg·m ²	6.67×10^{-5} kg·m ²	
Power rate	5.31 kW/s	11.5 kW/s	28.1 kW/s	34.1 kW/s	86.3 kW/s	85.6 kW/s	
Allowable radial load	68 N	68 N	78 N	245 N	245 N	392 N	
Allowable thrust load	54 N	54 N	54 N	74 N	74 N	147 N	
Weight	Without brake	0.3 kg	0.4 kg	0.5 kg	1.1 kg	1.7 kg	3.4 kg
	With brake	0.6 kg	0.7 kg	0.8 kg	1.6 kg	2.2 kg	4.3 kg
Encoder resolution	2,000 pulses/revolution for phase-A and phase-B, 1 pulse/revolution for phase-Z						
Radiation shield dimensions	t6 × 250 mm square						
Brake Specifications	Brake inertia	0.85×10^{-6} kg·m ²	0.85×10^{-6} kg·m ²	0.85×10^{-6} kg·m ²	6.4×10^{-6} kg·m ²	6.4×10^{-6} kg·m ²	1.7×10^{-5} kg·m ²
	Excitation voltage	24 V DC ±10% V					
	Power consumption (at 20°C)	6 W	6 W	6 W	7 W	7 W	7.7 W
	Current consumption (at 20°C)	0.25 A	0.25 A	0.25 A	0.29 A	0.29 A	0.32 A
	Static friction torque	0.2 N·m min.	0.2 N·m min.	0.34 N·m min.	1.47 N·m min.	1.47 N·m min.	2.45 N·m min.
	Attraction time	30 ms max.	30 ms max.	30 ms max.	60 ms max.	60 ms max.	60 ms max.
	Release time	60 ms max.	60 ms max.	60 ms max.	20 ms max.	20 ms max.	20 ms max.
	Backlash	1°	1°	1°	1°	1°	1°
	Rating	Continuous	Continuous	Continuous	Continuous	Continuous	Continuous
Insulation grade	Type F	Type F	Type F	Type F	Type F	Type F	
Applicable Servo Driver (R7D-)	APA3H	APA5H	AP01H	AP02H	AP04H	AP08H	

AC Servo Systems

Torque and Rotation Speed Characteristics

Flat Servomotors

The following graphs show the characteristics with a 3-m standard cable and R7D-AP@H Servo Driver (200-V AC input)

R7M-AP10030 (100 W)

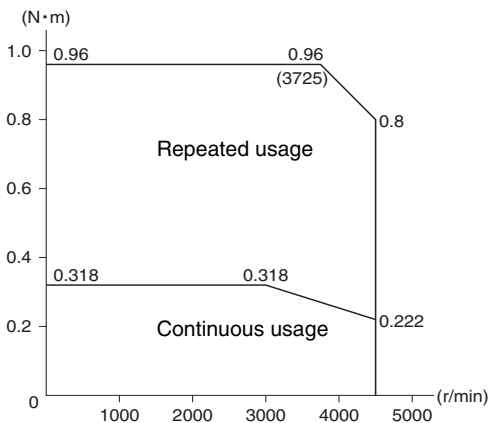

R7M-AP20030 (200 W)

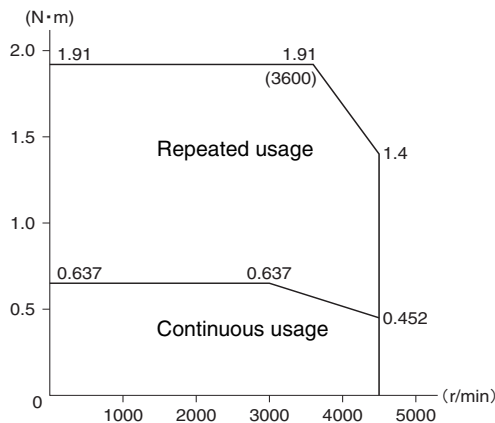

R7M-AP40030 (400 W)

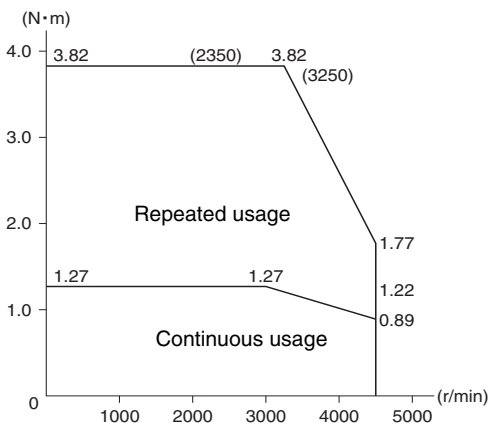

R7M-AP75030 (750 W)

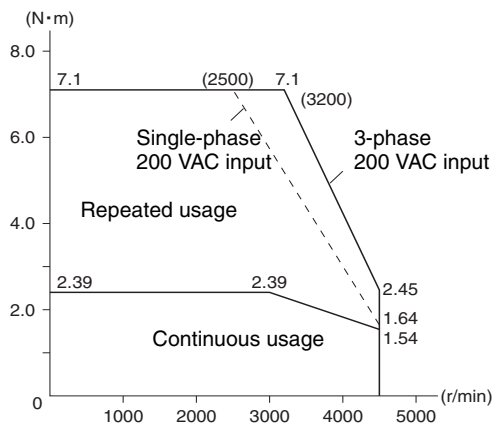

Torque and Rotation Speed Characteristics

Cylindrical Servomotors

The following graphs show the characteristics with a 3-m standard cable and an R7D-AP□H Servo Driver (200-V AC input.)

R7M-A03030 (30 W)

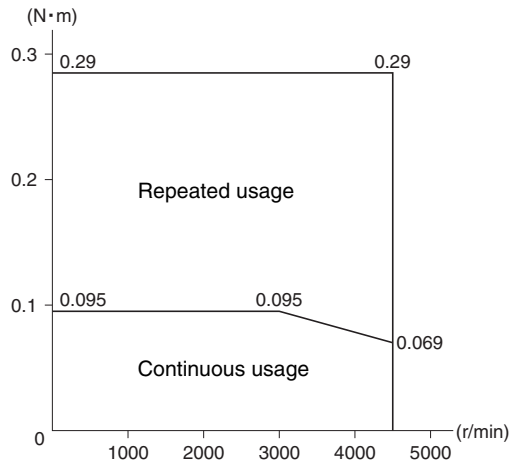

R7M-A05030 (50 W)

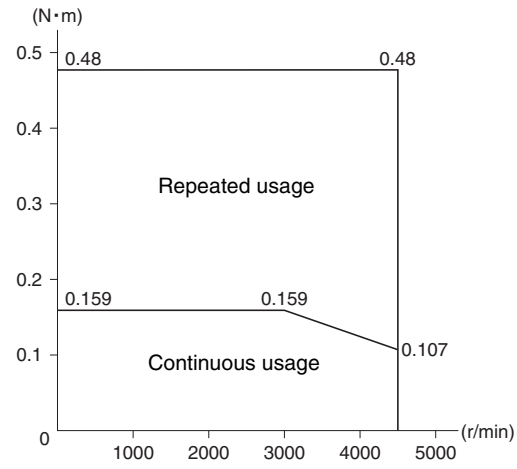

R7M-A10030 (100 W)

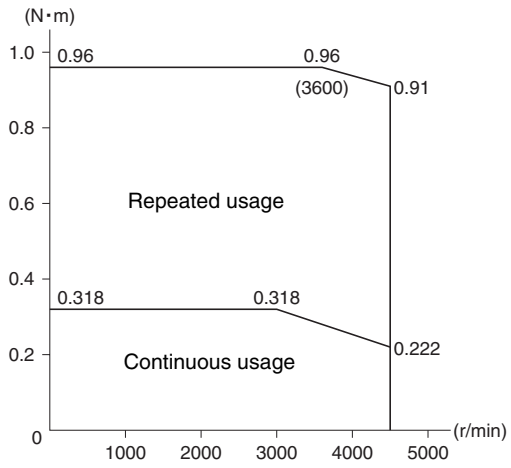

R7M-A20030 (200 W)

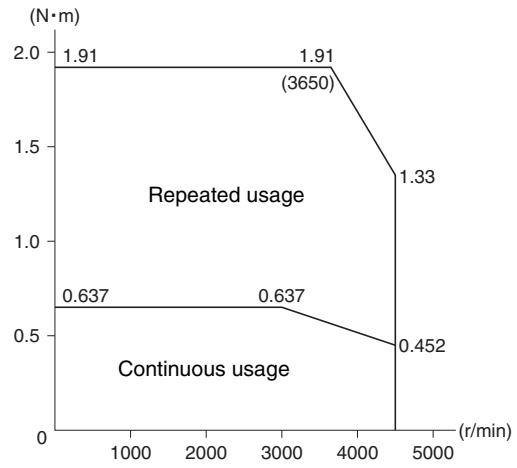

R7M-A40030 (400 W)

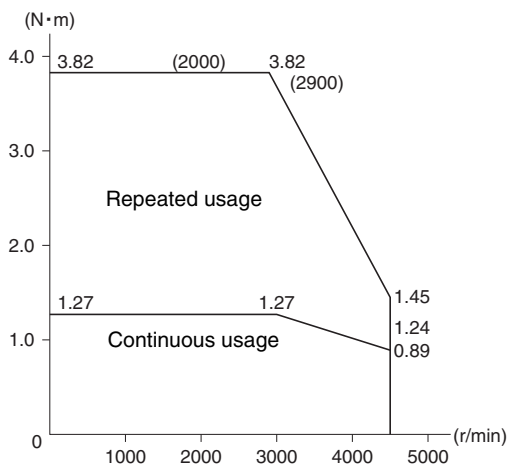

R7M-A75030 (750 W)

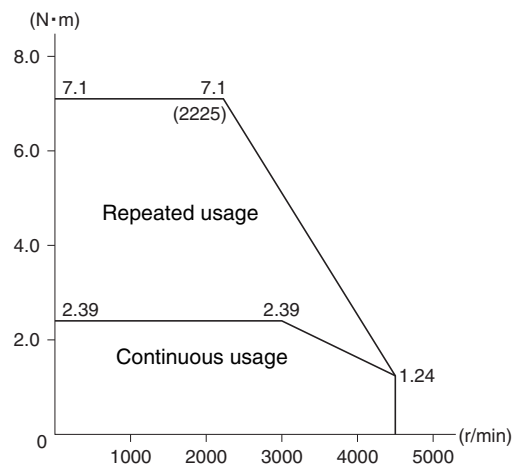

Servo Drive Specifications

General Specifications

Item	Specification
Ambient operating temperature	0 to 55°C
Ambient operating humidity	90% max. (with no condensation)
Ambient storage temperature	-20 to 85°C
Ambient storage humidity	90% max. (with no condensation)
Storage/operating atmosphere	No corrosive gases.
Vibration resistance	10 to 55 Hz in X, Y, and Z directions with 0.1-mm double amplitude or acceleration of 4.9 m/s ² max., whichever is smaller
Impact resistance	Acceleration 19.6 m/s ² max., in X, Y, and Z directions, three times
Insulation resistance	Between power line terminals and case: 0.5 MΩ min. (at 500 V DC)
Dielectric strength	Between power line terminals and case: 1,500 V AC for 1 min at 50/60 Hz Between each control signal and case: 500 V AC for 1 min
Protective structure	Built into panel (IP10).
International standards	Approval obtained for UL, cUL, and EN (EMC directive and low-voltage directive)

Performance Specifications

Item	200 VAC Input Type					
	30 W	50 W	100 W	200 W	400 W	750 W
	R7D-APA3H	R7D-APA5H	R7D-AP01H	R7D-AP02H	R7D-AP04H	R7D-AP08H
Continuous output current (rms)	0.42	0.6	0.89	2.0	2.6	4.4
Momentary maximum output current (rms)	1.3	1.9	2.8	6.0	8.0	13.9
Control power supply	Single-phase 200/230 V AC (170 to 253 V) 50/60 Hz					
Main-circuit power supply	Single-phase 200/230 V AC (170 to 253 V) 50/60 Hz (Three-phase 200/230 V AC can be used with the 750-W model.)					
Control method	All-digital servo					
Speed feedback	2,000 pulses/revolution Incremental Encoder					
Inverter method	PWM method based on IGBT					
PWM frequency	11.7 kHz					
Weight	0.8	0.8	0.8	0.8	1.1	1.7
Compatible motor voltage	200 V					
Compatible motor capacity	30 W	50 W	100 W	200 W	400 W	750 W
Command pulse response	250 kHz					
Applicable Servomotor (R7M-)	A03030	A05030	A10030 AP10030	A20030 AP20030	A40030 AP40030	A75030 AP75030

I/O Specifications

Terminal Specifications

Symbol	Name	Function
L1 and L2 or L1, L2, and L3	Main-circuit Power Supply Terminals	These are the input terminals for the main-circuit power supply.
⊕1	DC Reactor Terminals	Normally short-circuit between +1 and +2. If harmonic control measures are required, connect a DC Reactor between +1 and +2.
⊕2		
⊖	Main-circuit DC Output	Do not connect anything to this terminal.
L1C L2C	Control Circuit Power Supply Terminals	These are the input terminals for the control power supply.
B1 and B2 or B1, B2, and B3	External Regeneration Resistance Terminals	Connect an External Regeneration Resistor to these terminals if the regenerative capacity of the internal capacitor is exceeded. (An External Regeneration Resistor cannot be connected to the 30 to 200-W models.)
U	Servomotor Terminals	Red
V		White
W		Blue
⊕	Frame ground	This is the ground terminal.

Control I/O (CN1) Specifications

Pin	Symbol	Name	Function
1	+PULS/CW/A	Feed pulses, reverse pulses, or 90° phase difference pulses (A phase)	Line-driver input: 7 mA at 3 V Open-collector input
2	-PULS/CW/A		Input impedance: 200 Ω
3	+SIGN/CCW/B	Direction signal, forward pulses, or 90° phase difference pulses (B phase)	Maximum response frequency: 250 kpps
4	-SIGN/CCW/B		Position control is performed based on the pulses that have been input.
5	+ECRST	Deviation counter reset	Line-driver input: 7 mA at 3 V
6	-ECRST		Open-collector input: 16 mA at 5 V Input impedance: 200 Ω ON: Resets deviation counter.
7	BKIR	Brake interlock output	Outputs holding brake timing signals.
8	INP	Positioning completed output	ON when the position error is within the positioning completed range.
10	OGND	Output ground common	Ground common for output signals (pins 7 and 8).
13	+24V	+24V DC power input for control	Power supply input (+24 V DC) for pins 14 and 18.
14	RUN	RUN command input	ON: Servo ON (Starts power to Servomotor.)
18	RESET	Alarm reset input	ON: Servo alarm status is reset.
19	GND	RS-422A ground	Ground for RS-422A
20	RXD+	RS-422A reception data	Interface for RS-422A data transfers
21	RXD-		
22	TXD+	RS-422A transmission data	
23	TXD-		
24	RT	Termination resistance terminal	Connect to RXD- (pin 21) in the Unit at the end of the line.
32	Z	Encoder phase-Z open-collector output	Output goes ON when the encoder's phase-Z signal (1 pulse/revolution) is detected.
33	ZCOM		Open-collector output: 20 mA max. at 30 V DC
34	ALM	Alarm output	Output goes OFF when alarm is detected.
35	ALMCOM		Open-collector output: 50 mA max. at 30 V DC
Shell	FG	Cable shield ground	Ground for cable's shield wire.

Encoder Connector (CN2) Specifications

Pin	Symbol	Name	Function
1, 2, 3	E0V	Encoder power supply GND	Power supply outlet for encoder
4, 5, 6	E5V	Encoder power supply +5 V	
8	S+	Encoder + phase-S input	Line driver input (conforms to EIA-RS422A)
9	S-	Encoder - phase-S input	(Input impedance: 220 Ω ± 5%)
10	A+	Encoder + phase-A input	Line driver input (conforms to EIA-RS422A)
11	A-	Encoder - phase-A input	(Input impedance: 220 Ω ± 5%)
12	B+	Encoder + phase-B input	Line driver input (conforms to EIA-RS422A)
13	B-	Encoder - phase-B input	(Input impedance: 220 Ω ± 5%)
Shell	FG	Cable shield ground	Ground for cable's shield wire.

Communications Connector (CN3) Specifications

Pin	Symbol	Name	Function
1	/TXD	Transmission data	Transmission data: RS-232C output
2	/RXD	Reception data	Reception data: RS-232C input
3	PRMU	Unit switching	Switching terminal for a Parameter Unit
7	+5V	+5 V output	This is the +5 V power supply output to the Parameter Unit.
8	GND	Ground	
Shell	FG	Cable shield ground	Ground for cable's shield wire.

Monitor Output (CN4) Specifications

Pin	Symbol	Name	Function
1	NM	Speed monitor	Speed monitor output: 1 V per 1,000 r/min
2	AM	Current monitor	Current monitor: 1 V / rated torque
3	GND	Ground	Grounds for monitor output
4	GND	Ground	

Digital Operator Specifications

General Specifications

Item	Specification
Ambient operating temperature	0 to 55°C
Ambient operating humidity	90% max. (with no condensation)
Ambient storage temperature	-20 to 85°C
Ambient storage humidity	90% max. (with no condensation)
Storage/operating atmosphere	No corrosive gases.
Vibration resistance	10 to 55 Hz in X, Y, and Z directions with 0.1-mm double amplitude or acceleration of 9.8 m/s ² max., whichever is smaller
Impact resistance	Acceleration 19.6 m/s ² max., in X, Y, and Z directions, three times

Function Specifications

Item	Function
Setting mode	Display or change parameter settings.
Monitor mode	Display monitor values.
Execute Function mode	Execute each function mode.
Display Alarms	Display alarms that have occurred.
Copy Parameters	Read or save parameters from the Servo Driver. Write parameters to the Servo Driver. Compare parameters in the Servo Driver with parameters in the Parameter Unit.

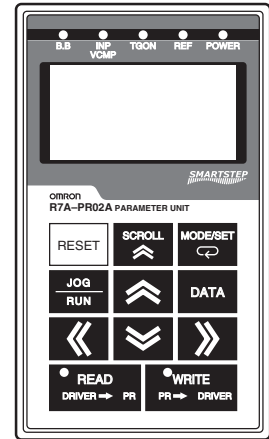

R7A-PR02A

Mode Change Specifications

Power ON

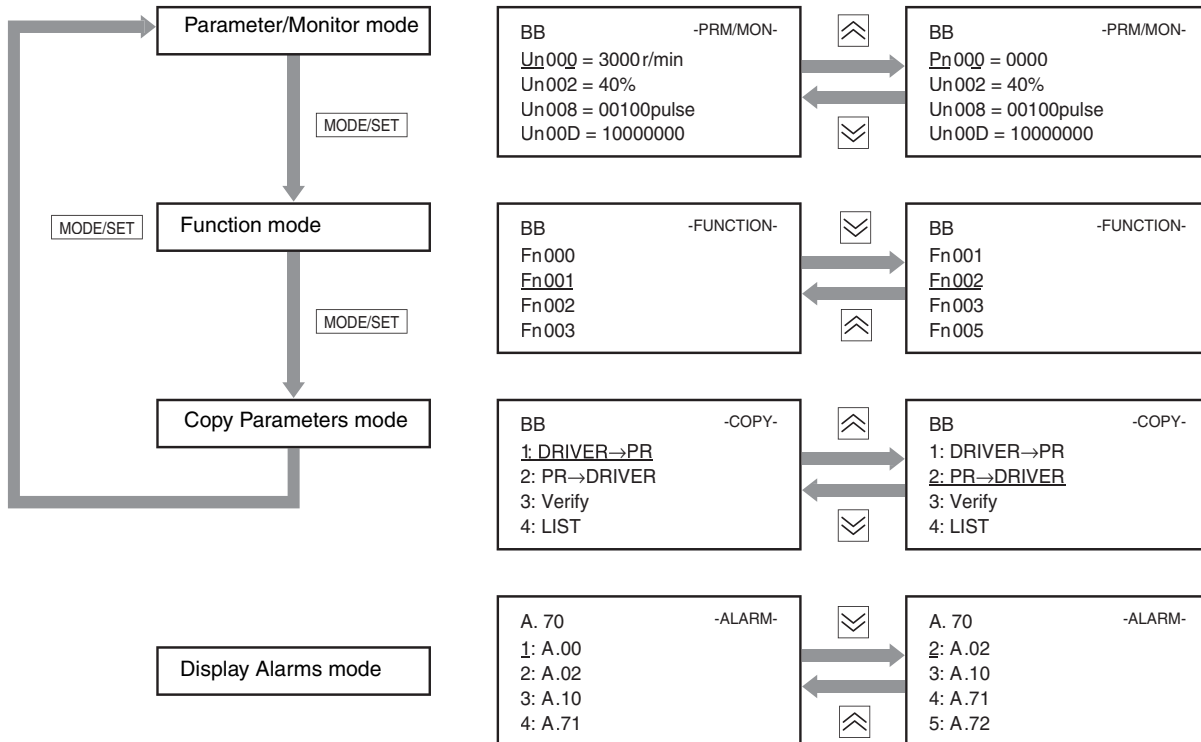

Enable Switch/Parameter Setting

Pin 6 of the DIP switch selects whether the Servo Driver operates according to the DIP switch settings or parameter settings.

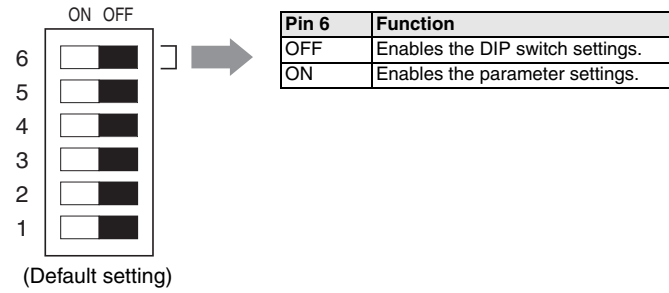

Command Pulse Input Setting

Pin 3 selects the command pulse mode. Select “Forward pulse/Reverse pulse: positive logic” or “Feed pulses/Direction signal: positive logic.”

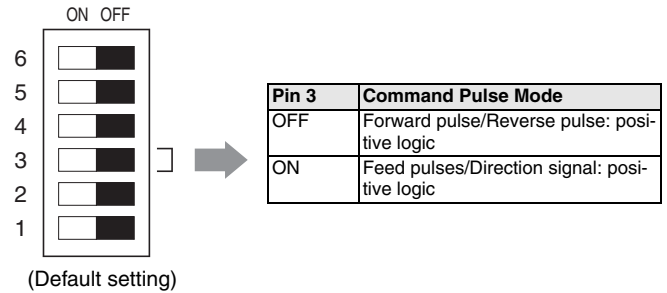

Online Autotuning Setting

The Autotuning Switch selects whether the gain will be adjusted automatically during operation.

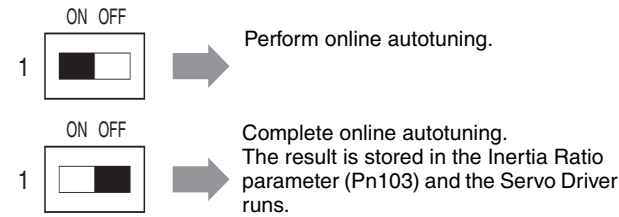

Dynamic Brake Setting

Pin 2 enables or disables dynamic brake operation. If the dynamic brake is enabled, the motor can be brought to an emergency stop when the RUN command goes OFF or an alarm occurs.

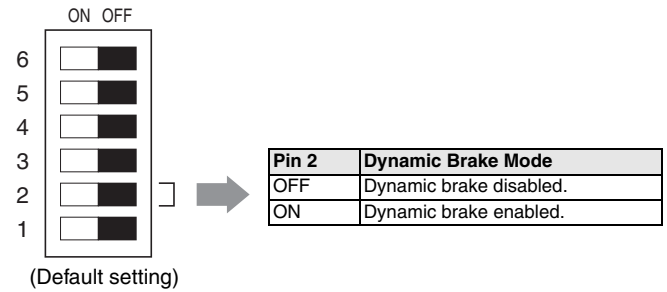

Resolution Setting

Pins 4 and 5 select the positioning resolution. If the resolution is set to 1,000 (the default setting), the motor makes one revolution for every 1,000 pulses input.

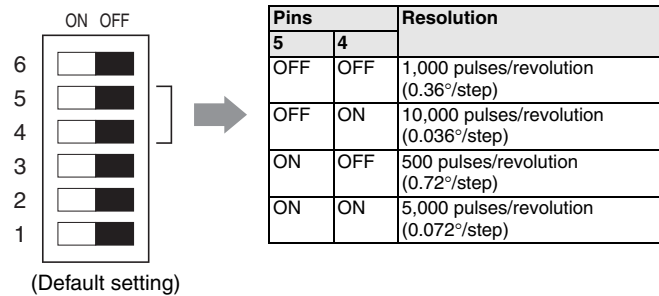

Alarm Table

Display	ALM output	Error detection function
A.04*	OFF	Parameter setting error
A.10*	OFF	Overcurrent
A.30	OFF	Regeneration error
A.32	OFF	Regeneration overload
A.40	OFF	Overvoltage/Undervoltage
A.51	OFF	Overspeed
A.70	OFF	Overload
A.73	OFF	Dynamic brake overload
A.74	OFF	Inrush resistance overload

Display	ALM output	Error detection function
A.7A	OFF	Overheat
A.bF*	OFF	System error
A.C1	OFF	Runaway detected
A.C2*	OFF	Phase not detected
A.C3*	OFF	Encoder disconnect detected
A.d0	OFF	Deviation counter overflow
CPF00	---	Parameter Unit transmission error 1
CPF01	---	Parameter Unit transmission error 2
A.91	---	Overload warning
A.92	---	Regeneration overload warning

Parameters

Parameter Details

Parameter number	Parameter name	Digit	Name	Setting	Explanation	Default setting	Unit	Setting range
Pn000	Function selection basic switch 1 (See note 1.)	0	Reverse rotation	0	CCW direction is taken for positive command	0010	---	---
		1	Control mode	1	CW direction is taken for positive command			
		2 to 3	Not used.	---	---			
Pn001	Function selection basic switch 2 (See note 1.)	0	Select stop method if an alarm occurs when Servomotor is OFF	0	Servomotor stopped by dynamic brake.	1002	---	---
		1		Stop by dynamic brake and release brake after Servomotor stops.				
		2	Servomotor stopped with free run					
1 to 3	Not used.	---	---					
Pn100	Speed loop gain	Adjusts speed loop's responsiveness.			80	Hz	1 to 2,000	
Pn101	Speed loop integral constant	Speed loop integral time constant			2,000	0.01 ms	15 to 51,200	
Pn102	Position loop gain	Adjusts position loop's responsiveness.			40	1/s	1 to 2,000	
Pn103	Inertia ratio	Set using the ratio between the machine system inertia and the Servomotor rotor inertia.			300	%	0 to 10,000	
Pn109	Feed-forward amount	Position control feed-forward compensation value			0	%	0 to 100	
Pn10A	Feed-forward command filter	Sets position control feed-forward command filter.			0	0.01 ms	0 to 6,400	
Pn110	Online autotuning setting (See note 1.)	0	Selects online autotuning	0	Auto-tunes initial operations only after power is turned ON.	0012	---	---
				1	Always auto-tunes.			
				2	No auto-tuning			
		1	Not used.	---	---			
		2	Selects adhesive friction compensation function	0	Friction compensation: OFF			
				1	Friction compensation: rated torque ratio small			
				2	Friction compensation: rated torque ratio large			
		3	Not used.	---	---			
		Pn200	Position control setting 1 (See note 1.)	0	Command pulse mode			
1	Forward pulse/Reverse pulse: Positive logic							
2	90° phase difference (A/B phase) signal (x1): Positive logic							
3	90° phase difference (A/B phase) signal (x2): Positive logic							
4	90° phase difference (A/B phase) signal (x4): Positive logic							
5	Feed pulses/Direction signal: Negative logic							
6	Forward pulse/Reverse pulse: Negative logic							
7	90° phase difference (A/B phase) signal (x1): Negative logic							
8	90° phase difference (A/B phase) signal (x2): Negative logic							
9	90° phase difference (A/B phase) signal (x4): Negative logic							
1	Deviation counter reset			0	High level signal			
				1	Rising signal (low to high)			
				2	Low level signal			
3	Falling signal (high to low)							
2	Deviation counter reset if an alarm occurs when the Servomotor is OFF			0	Deviation counter reset if an alarm occurs when Servomotor is OFF.			
		1	Deviation counter not reset if an alarm occurs when Servomotor is OFF.					
		2	Deviation counter reset only if alarm occurs.					
3	Not used.	---	---					
Pn202	Electronic gear ratio G1 (numerator) (See note 1.)	Sets the pulse rate for the command pulses and Servo Servomotor travel distance.			4	---	1 to 65,535	
Pn203	Electronic gear ratio G2 (denominator) (See note 1.)	Setting range: 0.01 £ G1/G2 £ 100			1	---	1 to 65,535	
Pn204	Position command filter time constant 1 (primary filter)	Sets soft start for command pulse. (Soft start characteristics are for the primary filter.)			0	0.01 ms	0 to 6,400	
Pn207	Position control setting 2 (See note 1.)	0	Selects position command filter.	0	Primary filter (Pn204)	0000	---	---
				1	Linear acceleration and deceleration (Pn208)			
		1 to 3	Not used.	---	---			
Pn208	Position command filter time constant 2 (linear acceleration and deceleration) (See note 1.)	Sets soft start for command pulse. (soft start characteristics are for the linear acceleration and deceleration.)			0	0.01 ms	0 to 6,400	
Pn304	Jog speed	Sets rotation speed during jog operation.			500	r/min	0 to 10,000	

Parameter number	Parameter name	Digit	Name	Setting	Explanation	Default setting	Unit	Setting range
Pn401	Torque command filter time constant				Sets the constant when filtering the internal torque command.	40	0.01 ms	0 to 65,535
Pn402	Forward torque limit				Forward rotation output torque limit (percentage of rated torque ratio).	350	%	0 to 800
Pn403	Reverse torque limit				Reverse rotation output torque limit (percentage of rated torque ratio).	350	%	0 to 800
Pn500	Positioning completion range				Sets the range of positioning completed output signal	3	Command units	0 to 250
Pn505	Deviation counter overflow level				Sets the detection level for the deviation counter over alarm.	1,024	×256 command units	1 to 32767
Pn600	Regeneration resistor capacity (See note 2).				Setting for regeneration resistance load ratio monitoring calculations.	0	10 W	See model specs.

- Note:**
1. These parameters are read when the power is turned ON. Parameter Pn110.2 is valid when online.
 2. When using a Regeneration Resistor, set the resistor's capacity when the temperature has risen to 120°C. Set this parameter to 0 if a Regeneration Resistor is not being used.

Function Mode Details

Number	Name	Explanation
Fn000	Alarm history display	Displays up to 10 alarm entries.
Fn001	Rigidity setting during online auto-tuning	Sets the control target during online auto-tuning.
Fn002	Jog operation	Makes the Servomotor rotate using key operations from the Parameter Unit.
Fn003	Servomotor origin search	Makes the Servomotor rotate using key operations from the Parameter Unit and fixes the position of phase Z after phase Z is detected.
Fn005	User parameter initialization	Restores user parameters to their default settings.
Fn006	Alarm history data clear	Clears the data stored in the alarm history.
Fn007	Store online auto-tuning results	Writes the load data calculated using online auto-tuning to Pn103 (inertia ratio).
Fn00C	Analog monitor output offset manual adjustment	Manually adjusts the analog output monitor offset.
Fn00D	Analog monitor output scaling	Changes the analog monitor output scaling (output voltage adjustment).
Fn00E	Servomotor current detection offset automatic adjustment	Automatically adjusts the offset for Servomotor current detection.
Fn00F	Servomotor current detection offset manual adjustment	Manually adjusts the offset for Servomotor current detection.
Fn010	Password setting	You can permit or prohibit writing to user parameters.
Fn012	Version check	Check the Servo Driver's version information.

Monitor Mode Details

Number	Contents	Units	Explanation
Un000	Speed feedback	r/min	Displays actual rotation speed of Servomotor.
Un002	Torque command	%	Displays command values to current loop (rated torque = 100%).
Un003	Number of pulses from phase-Z edge	Pulses	Displays rotation position from phase-Z edge (4X calculation).
Un004	Electrical angle	×	Displays the electrical angle of the Servomotor.
Un005	Input signal monitor	---	Displays the control input signal (CN1) status using ON/OFF bits.
Un006	Output signal monitor	---	Displays the control output signal (CN1) status using ON/OFF bits.
Un007	Command pulse speed display	r/min	Calculates and displays command pulse frequency in r/min.
Un008	Position deviation (deviation counter)	Command units	Displays number of residual pulses in deviation counter (input pulse standard).
Un009	Cumulative load ratio	%	Displays effective torque (rated torque = 100%, 10-s cycle)
Un00A	Regeneration load ratio	%	Displays regeneration absorption power due to regeneration resistance (calculates internal resistance capacity or Pn600 setting as 100% in 10-s cycles).
Un00B	Dynamic brake resistance load ratio	%	Displays power consumption during dynamic brake operation (calculates tolerance power consumption as 100% in 10-s cycles).
Un00C	Input pulse counter	Command units	Counts and displays input pulses (displayed in hexadecimal).
Un00D	Feedback pulse counter	Pulses	Counts and displays feedback pulses (4X calculation, displayed in hexadecimal).

Dimensions

Servo Drivers

200 V AC: 30 W/50 W/100 W/200 W
(R7D-APA3H/APA5H/AP01H/AP02H)

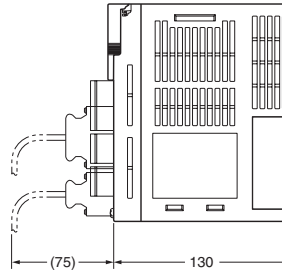
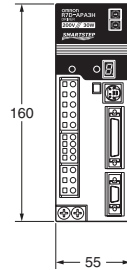

Mounting dimensions

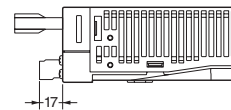
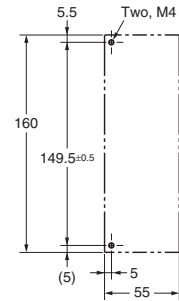

200 V AC: 400 W
(R7D-AP04H)

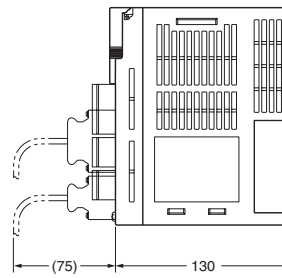
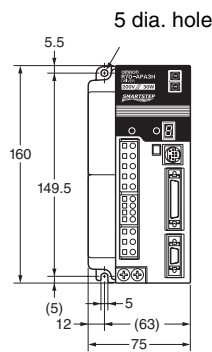

Mounting dimensions

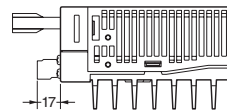
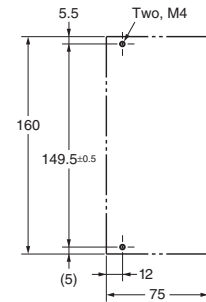

200 V AC: 750 W
(R7D-AP08H)

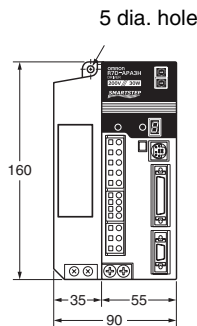
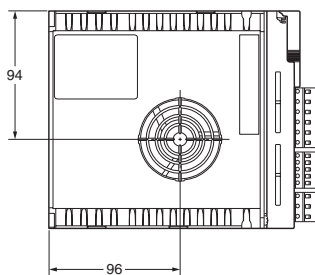

Mounting dimensions

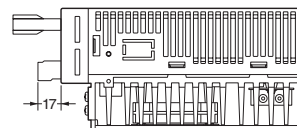
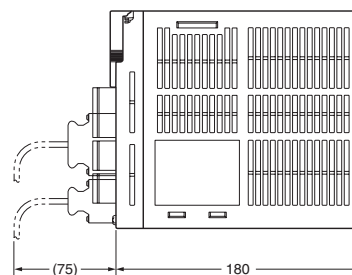
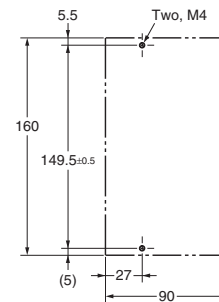

Servomotors

Cylindrical Servomotors (3,000 r/min)
200 V AC: 30 W/50 W/100 W/200 W/400 W/750 W

Without Brake: R7M-A03030-S1-D/A05030-S1-D/A10030-S1-D/A20030-S1-D/A40030-S1-D/A75030-S1-D
With Brake: R7M-A03030-BS1-D/A05030-BS1-D/A10030-BS1-D/A20030-BS1-D/A40030-BS1-D/A75030-BS1-D

Model	Dimensions (mm)																
	LL		LR	Flange surface						Axis end							
	Without Brake	With Brake		C	D1	D2	F	G	Z	S	QK	b	h	t1			
R7M-A03030□	69.5	101	25	40	46	30h7	2.5	5	Two, 4.3 dia.	6h6	14	2	2	1.2			
R7M-A05030□	77	108.5								8h6					3	3	1.8
R7M-A10030□	94.5	135								3					3	1.8	
R7M-A20030□	96.5	136	30	60	70	50h7	3	6	Four, 5.5 dia.	14h6	20	5	5	3			
R7M-A40030□	124.5	164								16h6					30		
R7M-A75030□	145	189.5								40					80	90	70h7

R7M-A□□□30-S1-D (Without Brake)

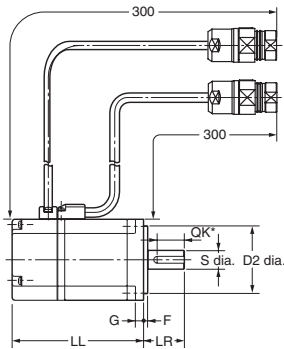

R7M-A□□□30-BS1-D (With Brake)

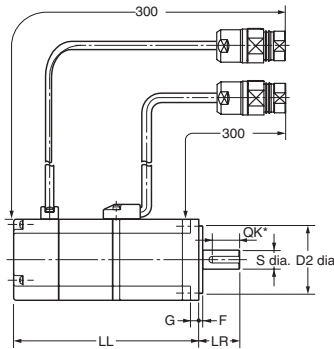

Axis end dimensions

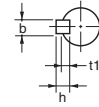

Hole with "Z" mark

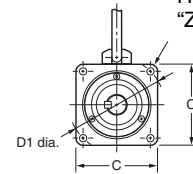

Flat Servomotors (3,000 r/min)
200 V AC: 100 W/200 W/400 W/750 W

Without Brake: R7M-AP10030-S1-D/AP20030-S1-D/AP40030-S1-D/AP75030-S1-D
With Brake: R7M-AP10030-BS1-D/AP20030-BS1-D/AP40030-BS1-D/AP75030-BS1-D

Model	Dimensions (mm)													
	LL		LR	Flange surface						Axis end				
	Without Brake	With Brake		C	D1	D2	F	G	Z	S	QK	b	h	t1
R7M-AP10030□	62	91	25	60	70	50h7	3	6	5.5	8h6	14	3	3	1.8
R7M-AP20030□	67	98.5	30	80	90	70h7	3	8	7	14h6	16	5	5	3
R7M-AP40030□	87	118.5								16h6				
R7M-AP75030□	86.5	120	40	120	145	110h7	3.5	10	10	16h6	22			

R7M-AP□□□30-S1-D (Without Brake)

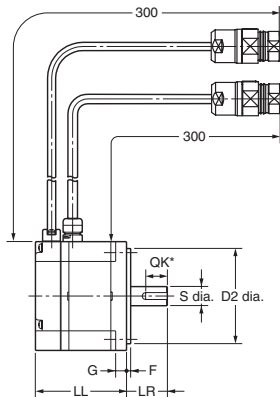

R7M-AP□□□30-BS1-D (With Brake)

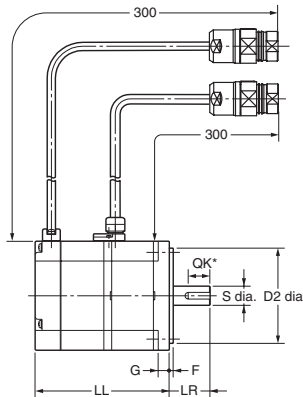

Axis end dimensions

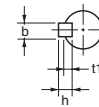

Four, Z-dia. mounting holes

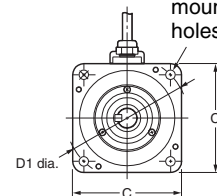

Filters

R88A-FIW104-SE

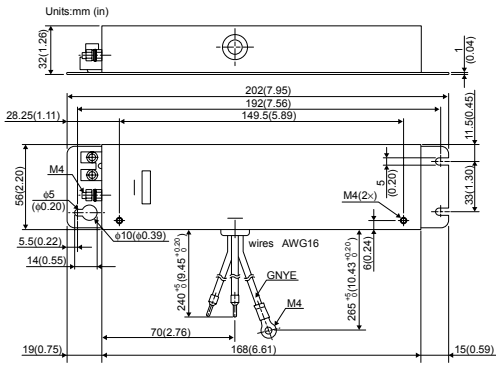

R88A-FIW107-SE, R88A-FIW115-SE

Model	R88A-FIW107-SE	R88A-FIW115-SE
Dimensions in mm	A 75	90
	B 240 ^{+b}	300 ^{+b}
	C 50	60
	D 12	15
	E 1	1.2

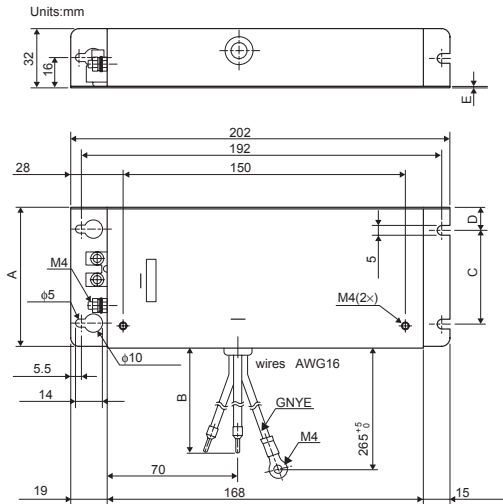

Ordering Information

System Configuration

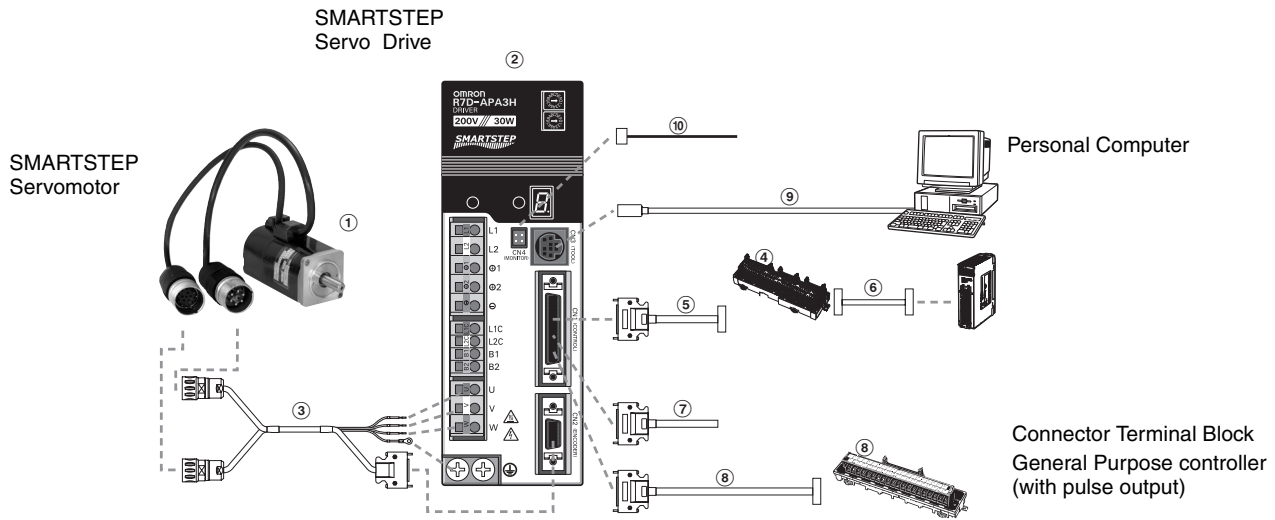

Servomotors

Symbol	Specifications		Model		
①	Cylindrical Servomotors (3,000-r/min)	Without brake	0.095 Nm	30 W	R7M-A03030-S1-D
			0.159 Nm	50 W	R7M-A05030-S1-D
			0.318 Nm	100 W	R7M-A10030-S1-D
			0.637 Nm	200 W	R7M-A20030-S1-D
			1.27 Nm	400 W	R7M-A40030-S1-D
			2.39 Nm	750 W	R7M-A75030-S1-D
			2.39 Nm	750 W	R7M-A75030-S1-D
		With brake	0.095 Nm	30 W	R7M-A03030-BS1-D
			0.159 Nm	50 W	R7M-A05030-BS1-D
			0.318 Nm	100 W	R7M-A10030-BS1-D
			0.637 Nm	200 W	R7M-A20030-BS1-D
			1.27 Nm	400 W	R7M-A40030-BS1-D
			2.39 Nm	750 W	R7M-A75030-BS1-D
			2.39 Nm	750 W	R7M-A75030-BS1-D
Flat Servomotors (3,000-r/min)	Without brake	0.318 Nm	100 W	R7M-AP10030-S1-D	
		0.637 Nm	200 W	R7M-AP20030-S1-D	
		1.27 Nm	400 W	R7M-AP40030-S1-D	
		2.39 Nm	750 W	R7M-AP75030-S1-D	
	With brake	0.318 Nm	100 W	R7M-AP10030-BS1-D	
		0.637 Nm	200 W	R7M-AP20030-BS1-D	
		1.27 Nm	400 W	R7M-AP40030-BS1-D	
		2.39 Nm	750 W	R7M-AP75030-BS1-D	

Servo Drives

Symbol	Specifications		Model
②	200 V AC	30 W	R7D-APA3H
		50 W	R7D-APA5H
		100 W	R7D-AP01H
		200 W	R7D-AP02H
		400 W	R7D-AP04H
		750 W	R7D-AP08H

Servomotor Cables (For CN2)

Symbol	Specifications		Power Cable Model	Encoder Cable Model	Appearance			
③	Standard Cables	For Servomotors without brake R7M-A(P)□□□30-S1-D	3 m	R7A-CEA003S-DE				
			5 m	R7A-CEA005S-DE				
			10 m	R7A-CEA010S-DE				
			15 m	R7A-CEA015S-DE				
			20 m	R7A-CEA020S-DE				
			For Servomotors with brake R7M-A(P)□□□30-BS1-D	3 m		R7A-CEA003B-DE		
				5 m		R7A-CEA005B-DE		
		10 m		R7A-CEA010B-DE				
		15 m		R7A-CEA015B-DE				
		20 m		R7A-CEA020B-DE				
		Flexible cables for applications where cable is frequently in motion		For Servomotors without brake R7M-A(P)□□□30-S1-D		3 m	R88A-CAWA003S-DE	R7A-CRA003-FDE
						5 m	R88A-CAWA005S-DE	R7A-CRA005-FDE
			10 m			R88A-CAWA010S-DE	R7A-CRA010-FDE	
			15 m			R88A-CAWA015S-DE	R7A-CRA015-FDE	
For Servomotors with brake R7M-A(P)□□□30-BS1-D	3 m		R88A-CAWA003B-DE	R7A-CRA003-FDE				
	5 m		R88A-CAWA005B-DE	R7A-CRA005-FDE				
	10 m		R88A-CAWA010B-DE	R7A-CRA010-FDE				
	15 m		R88A-CAWA015B-DE	R7A-CRA015-FDE				
20 m	R88A-CAWA020B-DE	R7A-CRA020-FDE						

Control Cables (For CN1)

Symbol	Name	Compatible Units	Model	Available lengths
④	Servo Relay Unit	Use with Position Control Units (Doesn't support communications functions.) Units: CS1W-NC113/133, CJ1W-NC113/133, C200HW-NC113, and C200H-NC112	XW2B-20J6-1B (1 axis)	---
		Use with Position Control Units (Doesn't support communications functions.) Units: CS1W-NC213/233/413/433, CJ1W-NC213/233/413/433, C200HW-NC213/413, C500-NC113/211, and C200H-NC211	XW2B-40J6-2B (2 axes)	
		Use with Position Control Units (Doesn't support communications functions.) Units: CQM1H-PLB21, and CQM1-CPU43-V1	XW2B-20J6-3B (1 axis)	
		Use with Position Control Units (Supports communications functions.) Units: CS1W-NC213/233/413/433, CJ1W-NC213/233/413/433	XW2B-40J6-4B (2 axes)	
		Use with CJ1M-CPU22/23 (Doesn't support communications functions.)	XW2B-20J6-8A (1 axis) XW2B-40J6-9A (2 axes)	
⑤	Cable to Servo Drive	Doesn't support communications functions. (For the XW2B-□□J6-□B)	XW2Z-□□□J-B5	1 m or 2 m (The cable length goes in the empty boxes.)
		Supports communications functions. (For the XW2B-□□J6-4B)	XW2Z-□□□J-B7	
⑥	Cable to Position Control Unit	CQM1H-PLB21 and CQM1-CPU43-V1	XW2Z-□□□J-A3	0.5 m or 1 m (The cable length goes in the empty boxes.)
		C200H-NC112	XW2Z-□□□J-A4	
		C200H-NC211 and C500-NC113/211	XW2Z-□□□J-A5	
		CS1W-NC113 and C200HW-NC113	XW2Z-□□□J-A8	
		CS1W-NC213/413 and C200HW-NC213/413	XW2Z-□□□J-A9	
		CS1W-NC133	XW2Z-□□□J-A12	
		CS1W-NC233/433	XW2Z-□□□J-A13	
		CJ1W-NC113	XW2Z-□□□J-A16	
		CJ1W-NC213/413	XW2Z-□□□J-A17	
		CJ1W-NC133	XW2Z-□□□J-A20	
		CS1W-NC233/433	XW2Z-□□□J-A21	
		CJ1M-CPU22/23	XW2Z-□□□J-A26	
⑦	Control Cable	For general-purpose Controllers	R88A-CPU□□□S	1 m or 2 m (The cable length goes in the empty boxes.)
⑧	Connector Terminal Block Cable	For general-purpose Controllers	R88A-CTU□□□N	---
	Connector Terminal Block		XW2B-40F5-P	

Cable for CN3

Symbol	Name	Model
⑨	Computer Monitor Cable	R7A-CCA002P2

Cable for CN4

Symbol	Name	Model
⑩	Analog Monitor Cable	R88A-CMW001S

Connectors

Specifications	Model
Control I/O Connector (For CN1)	R88A-CNU01C
SmartStep Connectors Kit.	Models Included in kit
SmartStep Encoder Connector (For CN2)	R7A-CNA01R
Hypertac Power Connector female	SPOC-06K-FSDN169
Hypertac Encoder Connector female	SPOC-17H-FRON169
Hypertac Power Connector male (Used in the motor)	SRUC-06J-MSCN236
Hypertac Encoder Connector male (Used in the motor)	SRUC-17G-MRWN087

External Regeneration Resistor

Specification	Model
220 W, 47 Ω	R88A-RR22047S

Filters

Specifications (applicable Servo Drive)	Model	Rated Current	Rated Voltage
R7D-APA3H, R7D-APA5H R7D-AP01H, R7D-AP02H	R88A-FIW104-E	4A	250 VAC Single Phase
R7D-AP04H	R88A-FIW107-E	7A	
R7D-AP08H	R88A-FIW115-E	15A	

Parameter Unit & Computer Software

Specifications	Model
Parameter Copy Unit (with cable)	R7A-PR02A
Sigma Win	MOTION TOOLS CD
WMON Win Version 2.0	

ALL DIMENSIONS SHOWN ARE IN MILLIMETERS.

To convert millimeters into inches, multiply by 0.03937. To convert grams into ounces, multiply by 0.03527.