

Programmable Controller
SYSMAC CJ-series
CJ1W-MCH72

Motion Control Unit

trajexia

OPERATION MANUAL

OMRON

Notice

OMRON products are manufactured for use by a trained operator and only for the purposes described in this manual.

The following conventions are used to classify and explain the precautions in this manual. Always heed the information provided with them.

 **WARNING** Indicates information that, if not heeded, could possibly result in serious injury or loss of life.

 **Caution** Indicates information that, if not heeded, could possibly result in minor or relatively serious injury, damage to the product or faulty operation.

OMRON product references

All OMRON products are capitalized in this manual.

The first letter of the word *Unit* is also capitalized when it refers to an OMRON product, regardless of whether it appears in the proper name of the product.

The abbreviation PLC means Programmable Logic Controller.

Visual aids

The following headings appear in the left column of the manual to help you locate different types of information.

Note Indicates information of particular interest for efficient and convenient operation of the product.

Trademarks and copyrights

MECHATROLINK is a registered trademark of Yaskawa Corporation.

Trajexia is a registered trademark of OMRON.

All other product names, company names, logos or other designations mentioned herein are trademarks of their respective owners.

Copyright

Copyright © 2009 OMRON

All rights reserved. No part of this publication may be reproduced, stored in a retrieval system, or transmitted, in any form, or by any means, mechanical, electronic, photocopying, recording, or otherwise, without the prior written permission of OMRON.

No patent liability is assumed with respect to the use of the information contained herein. Moreover, because OMRON is constantly striving to improve its high-quality products, the information contained in this manual is subject to change without notice. Every precaution has been taken in the preparation of this manual. Nevertheless, OMRON assumes no responsibility for errors or omissions. Neither is any liability assumed for damages resulting from the use of the information contained in this publication.

TABLE OF CONTENTS

Precautions	vii
1 Intended audience	vii
2 General precautions	vii
3 Safety precautions	vii
4 Operating environment precautions	viii
5 Application precautions	ix
6 Conformance to EC Directives	xi

SECTION 1

Introduction	1
1-1 Overview	1
1-2 System philosophy	2
1-3 Motion control concepts	4
1-4 Servo system principles	13
1-5 Trajexia system architecture	16
1-6 Cycle time	17
1-7 Program control and multi-tasking	22
1-8 Motion sequence and axes	23
1-9 Motion buffers	31
1-10 Mechanical system	33
1-11 Axis numbers	34

SECTION 2

Installation and wiring	35
2-1 Unit components	35
2-2 Wiring	40
2-3 Installation	50
2-4 Specifications	55

SECTION 3

Data exchange	59
3-1 Introduction	59
3-2 Memory areas	60
3-3 Data	62
3-4 FINS commands	65

SECTION 4

BASIC commands	73
4-1 Categories	73
4-2 All BASIC commands	84

SECTION 5

Examples	267
5-1 How-to's	268
5-2 Practical examples	320

TABLE OF CONTENTS

SECTION 6

Troubleshooting	347
6-1 Items to Check First.....	348
6-2 Error Indicators.....	349
6-3 Troubleshooting Errors.....	350
6-4 Miscellaneous.....	356
Revision history	361

Precautions

1 Intended audience

This manual is intended for the following personnel, who must also have knowledge of electrical systems (an electrical engineer or the equivalent).

- Personnel in charge of installing FA systems.
- Personnel in charge of designing FA systems.
- Personnel in charge of managing FA systems and facilities.

2 General precautions

The user must operate the product according to the performance specifications described in the operation manuals.

Before using the product under conditions which are not described in the manual or applying the product to nuclear control systems, railroad systems, aviation systems, vehicles, combustion systems, medical equipment, amusement machines, safety equipment, and other systems, machines, and equipment that may have a serious influence on lives and property if used improperly, consult your OMRON representative.

Make sure that the ratings and performance characteristics of the product are sufficient for the systems, machines, and equipment, and be sure to provide the systems, machines, and equipment with double safety mechanisms.

This manual provides information for using the CJ1W-MCH72. Be sure to read this manual before attempting to use the Unit and keep this manual close at hand for reference during operation.

 **WARNING** It is extremely important that the CJ1W-MCH72 and related devices be used for the specified purpose and under the specified conditions, especially in applications that can directly or indirectly affect human life. You must consult with your OMRON representative before applying the CJ1W-MCH72 and related devices to the above mentioned applications.

3 Safety precautions

 **WARNING** Never short-circuit the positive and negative terminals of the batteries, charge the batteries, disassemble them, deform them by applying pressure, or throw them into a fire.
The batteries may explode, combust or leak liquid.







 **WARNING** The CJ1W-MCH72 outputs will go off due to overload of the output transistors (protection). As a countermeasure for such problems, external safety measures must be provided to ensure safety in the system.

 **WARNING** The CJ1W-MCH72 will turn off the WDOG when its self-diagnosis function detects any error. As a countermeasure for such errors, external safety measures must be provided to ensure safety in the system.



 **WARNING** Never attempt to disassemble any Units while power is being supplied. Doing so may result in serious electric shock.

 **WARNING** Do not attempt to disassemble, repair, or modify any Units. Any attempt to do so may result in malfunction, fire, or electric shock.

 **WARNING** Never touch any of the terminals while power is being supplied. Doing so may result in serious electric shock.

-  **WARNING** Provide safety measures in external circuits (i.e., not in the Programmable Controller) to ensure safety in the system if an abnormality occurs due to malfunction of the PLC, malfunction of the CJ1W-MCH72, or external factors affecting the operation of the PLC or CJ1W-MCH72. Not providing sufficient safety measures may result in serious accidents.
- Emergency stop circuits, interlock circuits, limit circuits, and similar safety measures must be provided in external control circuits.
 - The PLC will turn OFF all outputs when its self-diagnosis function detects any error or when a severe failure alarm (FALS) instruction is executed. As a countermeasure for such errors, external safety measures must be provided to ensure safety in the system.
 - The PLC or CJ1W-MCH72 outputs may remain ON or OFF due to deposits on or burning of the output relays, or destruction of the output transistors. As a countermeasure for such problems, external safety measures must be provided to ensure safety in the system.
 - When the 24 V DC output (service power supply to the PLC) is overloaded or short-circuited, the voltage may drop and result in the outputs being turned OFF. As a countermeasure for such problems, external safety measures must be provided to ensure safety in the system.
 - External safety measures must also be taken to ensure safety in the event of unexpected operation when connecting or disconnecting the connectors of the CJ1W-MCH72.
-  **Caution** User programs written to the CJ1W-MCH72 will not be automatically backed up in the CJ1W-MCH72 flash memory (flash memory function).
-  **Caution** Tighten the screws on the terminal block of the Power Supply Unit to the torque specified in this manual. Loose screws may result in burning or malfunction.
-  **Caution** When positioning to a position determined using the teaching function, set the position designation setting in the positioning sequence to absolute positioning. If it is set to relative positioning, positioning will be performed to a position other than the one obtained with the teaching function.
-  **Caution** Execute online edit only after confirming that no adverse effects will be caused by extending the cycle time. Otherwise, the input signals may not be readable.
-  **Caution** Confirm the safety of the destination node before transferring a program to the node or changing the contents of I/O memory. Doing either of these without confirming safety may result in injury.
-  **Caution** Do not save data into the flash memory during memory operation or while the motor is running. Otherwise, unexpected operation may be caused.

4 Operating environment precautions

-  **Caution** Do not operate the control system in the following locations:
- Locations subject to direct sunlight.
 - Locations subject to temperatures or humidity outside the range specified in the specifications.
 - Locations subject to condensation as the result of severe changes in temperature.
 - Locations subject to corrosive or flammable gases.
 - Locations subject to dust (especially iron dust) or salts.
 - Locations subject to exposure to water, oil, or chemicals.
 - Locations subject to shock or vibration.
-  **Caution** Take appropriate and sufficient countermeasures when installing systems in the following locations:
- Locations subject to static electricity or other forms of noise.
 - Locations subject to strong electromagnetic fields.

- Locations subject to possible exposure to radioactivity.
- Locations close to power supplies.

 **Caution** The operating environment of the PLC System can have a large effect on the longevity and reliability of the system. Improper operating environments can lead to malfunction, failure, and other unforeseeable problems with the PLC System. Be sure that the operating environment is within the specified conditions at installation and remains within the specified conditions during the life of the system.

5 Application precautions

 **WARNING** Do not start the system until you check that the axes are present and of the correct type. The numbers of the axis will change if MECHATROLINK-II network errors occur during start-up or if the MECHATROLINK-II network configuration changes.

 **WARNING** Check the user program for proper execution before actually running it in the Unit. Not checking the program may result in an unexpected operation.

 **WARNING** Observe the following precautions when using the CJ1W-MCH72 or the PLC. Failure to abide by the following precautions could lead to serious or possibly fatal injury. Always heed these precautions.

- Always connect to a ground of 100 Ω or less when installing the Units. Not connecting to a ground of 100 Ω or less may result in electric shock.
- Always turn OFF the power supply to the PLC before attempting any of the following. Not turning OFF the power supply may result in malfunction or electric shock.
 - Mounting or dismounting Power Supply Units, I/O Units, CPU Units, Memory Cassettes, or any other Units.
 - Assembling the Units.
 - Setting DIP switches or rotary switches.
 - Connecting cables or wiring the system.
 - Connecting or disconnecting the connectors.

 **Caution** Be sure that all mounting screws, terminal screws, and cable connector screws are tightened to the torque specified in this manual. Incorrect tightening torque may result in malfunction.

 **Caution** Wire correctly. Incorrect wiring may result in burning.

 **Caution** Mount the Unit only after checking the terminal block completely.

 **Caution** Resume operation only after transferring to the new CJ1W-MCH72 Unit the contents of the VR and table memory required for operation. Not doing so may result in an unexpected operation.

 **Caution** When replacing parts, be sure to confirm that the rating of a new part is correct. Not doing so may result in malfunction or burning.

 **Caution** Use the dedicated connecting cables specified in operation manuals to connect the Units. Using commercially available RS-232C computer cables may cause failures in external devices or the Unit.

 **Caution** Outputs may remain on due to a malfunction in the built-in transistor outputs or other internal circuits. As a countermeasure for such problems, external safety measures must be provided to ensure the safety of the system.

 **Caution** Failure to abide by the following precautions may lead to faulty operation of the PLC, the CJ1W-MCH72 or the system, or could damage the PLC or CJ1W-MCH72. Always heed these precautions.

- Fail-safe measures must be taken by the customer to ensure safety in the event of incorrect, missing, or abnormal signals caused by broken signal lines, momentary power interruptions, or other causes.
- Interlock circuits, limit circuits, and similar safety measures in external circuits (i.e., not in the Programmable Controller) must be provided by the customer.
- Install external breakers and take other safety measures against short-circuiting in external wiring. Insufficient safety measures against short-circuiting may result in burning.
- Install the PLC Unit as far as possible from sources of strong harmonic noise.
- Lock the sliders securely until they click into place when connecting the Power Supply Unit, CPU Unit, I/O Units, Special I/O Units, or CPU Bus Units. Functions may not work correctly if the sliders are not locked properly.
- Always attach the End Cover provided with the CPU Unit to the Unit on the right end of the PLC. The CJ-series PLC will not operate properly if the End Cover is not attached.
- Always use the power supply voltages specified in the operation manuals. An incorrect voltage may result in malfunction or burning.
- Take appropriate measures to ensure that the specified power with the rated voltage and frequency is supplied in places where the power supply is unstable. An incorrect power supply may result in malfunction.
- Use crimp terminals for wiring. Do not connect bare stranded wires directly to terminals. Connection of bare stranded wires may result in burning.
- Leave the label attached to the Unit when wiring. Removing the label may result in malfunction if foreign matter enters the Unit.
- Remove the label after the completion of wiring to ensure proper heat dissipation. Leaving the label attached may result in malfunction.
- Do not apply voltages to the Input Units in excess of the rated input voltage. Excess voltages may result in burning.
- Do not apply voltages or connect loads to the Output Units in excess of the maximum switching capacity. Excess voltage or loads may result in burning.
- Check the user program for proper execution before actually running it on the Unit. Not checking the program may result in an unexpected operation.
- Be sure that the terminal blocks, Memory Units, expansion cables, and other items with locking devices are properly locked into place. Improper locking may result in malfunction.
- Double-check all wiring and switch settings before turning ON the power supply. Incorrect wiring may result in burning.
- Disconnect the LR and GR terminals when performing insulation resistance or withstand voltage tests. Not disconnecting the functional ground terminal may result in burning.

 **Caution** Confirm that no adverse effect will occur in the system before attempting any of the following. Not doing so may result in an unexpected operation.

- Changing the operating mode of the PLC (including the operating mode at power up).
- Force-setting/force-resetting any bit in memory.
- Changing the present value of any word or any set value in memory.





 **Caution** Do not pull on the cables or bend the cables beyond their natural limit. Doing either of these may break the cables.

 **Caution** Do not place objects on top of the cables or other wiring lines. Doing so may break the cables.

 **Caution** Resume operation only after transferring the system parameter data to the CJ1W-MCH72 and saving the data to flash memory. Not doing so may result in an unexpected operation.

 **Caution** Confirm that set parameters and data operate properly.

 **Caution** Check the pin numbers before wiring the connectors.

-  **Caution** Perform wiring according to specified procedures.
-  **Caution** Before touching a Unit, be sure to first touch a grounded metallic object in order to discharge any static build-up. Not doing so may result in malfunction or damage.
-  **Caution** Do not drop the Unit or subject it to abnormal shock or vibration.
-  **Caution** Confirm the safety of the destination node before transferring a program to the node or changing the contents of I/O memory. Doing either of these without confirming safety may result in injury.

6 Conformance to EC Directives

6-1 Applicable directives

- EMC Directives

6-2 Concepts

OMRON devices that comply with EC Directives also conform to the related EMC standards so that they can be more easily built into other devices or machines. The actual products have been checked for conformity to EMC standards (see the following note). Whether the products conform to the standards in the system used by the customer, however, must be checked by the customer.

EMC-related performance of the OMRON devices that comply with EC Directives will vary depending on the configuration, wiring, and other conditions of the equipment or control panel in which the OMRON devices are installed. The customer must, therefore, perform final checks to confirm that devices and the overall machine conform to EMC standards.

- Note** Applicable EMC (Electromagnetic Compatibility) standards are as follows:
- EMS (Electromagnetic Susceptibility): EN61000-6-2
 - EMI (Electromagnetic Interference): EN61000-6-4
(Radiated emission: 10-m regulations)

6-3 Conformance to EC Directives

The CJ1W-MCH72 complies with EC Directives. To ensure that the machine or device in which a CJ1W-MCH72 is used complies with EC Directives, the CJ1W-MCH72 must be installed as follows:

- 1 The CJ1W-MCH72 must be installed within a control panel.
- 2 Reinforced insulation or double insulation must be used for the DC power supplies used for the communications and I/O power supplies.
- 3 Units complying with EC Directives also conform to the Common Emission Standard (EN61000-6-4). With regard to the radiated emission (10-m regulations), countermeasures will vary depending on the devices connected to the control panel, wiring, the configuration of the system, and other conditions. The customer must, therefore, perform final checks to confirm that devices and the overall machine conform to EC Directives.

6-4 Installation within Control Panel

Unnecessary clearance in cable inlet or outlet ports, operation panel mounting holes, or in the control panel door may cause electromagnetic wave leakage or interference. In this case, the product may fail to meet EC Directives. In order to prevent such interference, fill clearances in the control panel with conductive packing. (In places where conductive packing comes in contact with the control panel, ensure electrical conductivity by removing the paint coating or masking these parts when painting.)

SECTION 1 Introduction

1-1 Overview

The CJ1W-MCH72 is a Trajexia-style motion control unit that can be connected to a CJ1-series PLC. It acts as an interface between PLC systems and Trajexia-style motion control systems.

Trajexia is the OMRON motion platform that offers you the performance and the ease of use of a dedicated motion system. It maximum flexibility and scalability. At the heart of Trajexia lies the TJ1 multi-tasking motion coordinator. Powered by a 32-bit DSP, it can do motion tasks such as e-cam, e-gearbox, registration control and interpolation, all using simple motion commands.

The CJ1W-MCH72 has the following features:

- A MECHATROLINK-II connection for a MECHATROLINK-II network with up to 30 axes. The motion cycle time is selectable: 0.5 ms, 1 ms, 2 ms or 4 ms.
- An Encoder Interface connection. It supports the main absolute encoder protocols allowing the connection of an external encoder to the system.
- The possibility to exchange analogue and digital input and output data with the PLC CPU.
- A wide choice of rotary, linear and direct-drive servos as well as Inverters are available to fit your needs in compactness, performance and reliability. The Inverters connected to the MECHATROLINK-II are driven at the same update cycle time as the Servo Drivers.

Note The Trajexia system supports 3 kinds of MECHATROLINK-II slaves: Servo Drivers, Inverters and I/Os.
The CJ1W-MCH72 only supports 2 kinds of MECHATROLINK-II slaves: Servo Drivers and Inverters. It does not support I/Os.

1-2 System philosophy

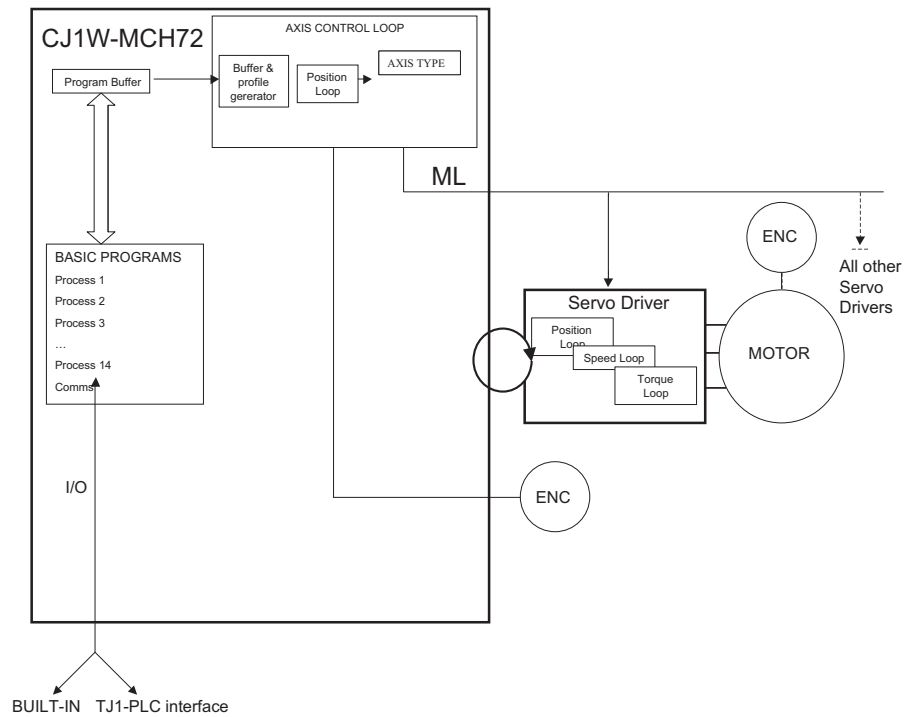

The system philosophy is centred around the relationship between:

- System architecture
- Cycle time
- Program control and multi-tasking
- Motion sequence and axes
- Motion buffers

A clear understanding of the relationship between these concepts is necessary to obtain the best results for the Trajexia system.

1-2-1 Glossary

1-2-1-1 Motion sequence

The Motion Sequence is responsible for controlling the position of the axes.

1-2-1-2 Servo period

Defines the frequency at which the Motion Sequence is executed. The servo period must be set according to the configuration of the physical axes. The available settings are 0.5 ms, 1 ms, 2 ms or 4 ms.

1-2-1-3 Cycle time

Is the time needed to execute one complete cycle of operations in the CJ1W-MCH72. The cycle time is divided in 4 time slices of equal time length, called "CPU Tasks". The cycle time is 1ms if **SERVO_PERIOD** = 0.5 ms or **SERVO_PERIOD** = 1 ms, 2 ms if the **SERVO_PERIOD** = 2 ms and 4 ms if the **SERVO_PERIOD** = 4 ms

1-2-1-4 CPU tasks

The operations executed in each CPU task are:

CPU task	Operation
First CPU task	Motion Sequence Low priority process
Second CPU task	High priority process
Third CPU task	Motion Sequence (only if SERVO_PERIOD = 0.5 ms) LED Update High priority process
Fourth CPU task	External Communications

1-2-1-5 Program

A program is a piece of BASIC code.

1-2-1-6 Process

Is a program in execution with a certain priority assigned. Process 0 to 12 are Low priority processes and Process 13 and 14 are High priority processes. First the process priority, High or Low, and then the process number, from high to low, will define to which CPU task the process will be assigned.

1-3 Motion control concepts

The CJ1W-MCH72 offers these types of positioning control operations:

- 1 Point-to-Point (PTP) control
- 2 Continuous Path (CP) control
- 3 Electronic Gearing (EG) control.

This section introduces some of the commands and parameters used in the BASIC programming of the motion control application.

Coordinate system

Positioning operations performed by the CJ1W-MCH72 are based on an axis coordinate system. The CJ1W-MCH72 converts the position data from either the connected Servo Driver or the connected encoder into an internal absolute coordinate system.

The engineering unit that specifies the distances of travelling can be freely defined for each axis separately. The conversion is performed through the use of the unit conversion factor, which is defined by the **UNITS** axis parameter. The origin point of the coordinate system can be determined using the **DEFPOS** command. This command re-defines the current position to zero or any other value.

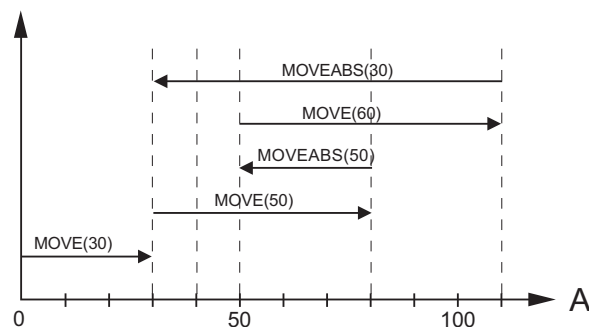

A move is defined in either absolute or relative terms. An absolute move takes the axis (A) to a specific predefined position with respect to the origin point. A relative move takes the axis from the current position to a position that is defined relative to this current position. The figure shows an example of relative (command **MOVE**) and absolute (command **MOVEABS**) linear moves.

1-3-1 PTP control

In point-to-point positioning, each axis is moved independently of the other axis. The CJ1W-MCH72 supports the following operations:

- Relative move
- Absolute move
- Continuous move forward
- Continuous move reverse.

1-3-1-1 Relative and absolute moves

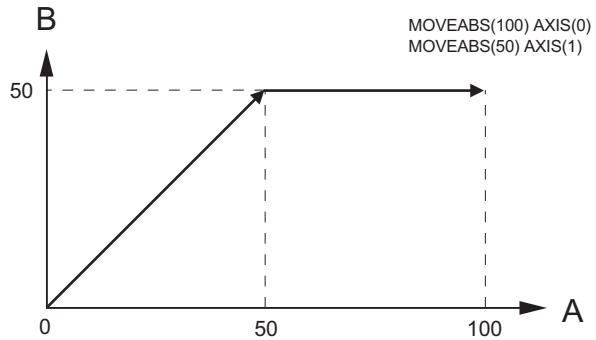

To move a single axis either the command **MOVE** for a relative move or the command **MOVEABS** for an absolute move is used. Each axis has its own move characteristics, which are defined by the axis parameters.

Suppose a control program is executed to move from the origin to an axis no. 0 (A) coordinate of 100 and axis no. 1 (B) coordinate of 50. If the speed parameter is set to be the same for both axes and the acceleration and deceleration rate are set sufficiently high, the movements for axis 0 and axis 1 will be as shown in the figure.

At start, both the axis 0 and axis 1 moves to a coordinate of 50 over the same duration of time. At this point, axis 1 stops and axis 0 continues to move to a coordinate of 100.

The move of a certain axis is determined by the axis parameters. Some relevant parameters are:

Parameter	Description
UNITS	Unit conversion factor
ACCEL	Acceleration rate of an axis in units/s ²
DECEL	Deceleration rate of an axis in units/s ²
SPEED	Demand speed of an axis in units/s

Defining moves

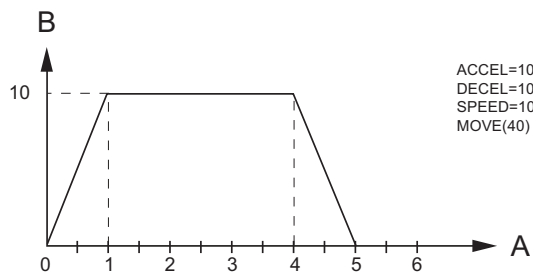

The speed profile in this figure shows a simple **MOVE** operation. Axis A is the time, axis B is the speed. The **UNITS** parameter for this axis has been defined for example as meters. The required maximum speed has been set to 10 m/s. In order to reach this speed in one second and also to decelerate to zero speed again in one second, both the acceleration as the deceleration rate have been set to 10 m/s². The total distance travelled is the sum of distances travelled during the acceleration, constant speed and deceleration segments. Suppose the distance moved by the **MOVE** command is 40 m, the speed profile is given by the figure.

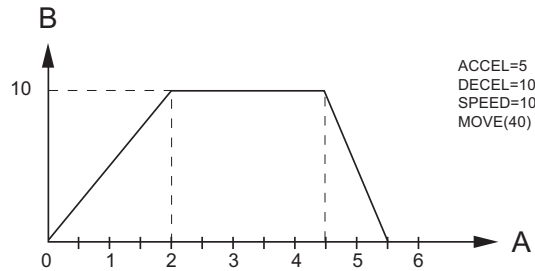

The two speed profiles in these figures show the same movement with an acceleration time respectively a deceleration time of 2 seconds. Again, Axis A is the time, axis B is the speed.

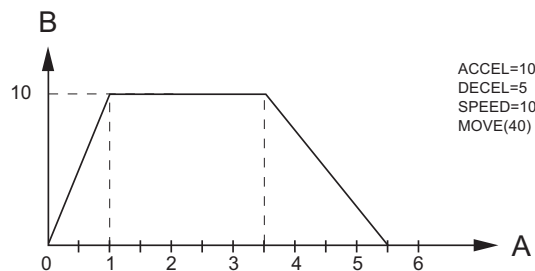

Move calculations

The following equations are used to calculate the total time for the motion of the axes.

- The moved distance for the **MOVE** command is *D*.
- The demand speed is *V*.
- The acceleration rate is *a*.
- The deceleration rate is *d*.

$$\text{Acceleration time} = \frac{V}{a}$$

$$\text{Acceleration distance} = \frac{V^2}{2a}$$

$$\text{Deceleration time} = \frac{V}{d}$$

$$\begin{aligned} \text{Deceleration distance} &= \frac{V^2}{2d} \\ \text{Constant speed distance} &= D - \frac{V^2(a+d)}{2ad} \\ \text{Total time} &= \frac{D}{V} + \frac{V(a+d)}{2ad} \end{aligned}$$

1-3-1-2 Continuous moves

The **FORWARD** and **REVERSE** commands can be used to start a continuous movement with constant speed on a certain axis. The **FORWARD** command moves the axis in positive direction and the **REVERSE** command in negative direction. For these commands also the axis parameters **ACCEL** and **SPEED** apply to specify the acceleration rate and demand speed.

Both movements can be cancelled by using either the **CANCEL** or **RAPIDSTOP** command. The **CANCEL** command cancels the move for one axis and **RAPIDSTOP** cancels moves on all axes. The deceleration rate is set by **DECEL**.

1-3-2 CP control

Continuous Path control enables to control a specified path between the start and end position of a movement for one or multiple axes. The CJ1W-MCH72 supports the following operations:

- Linear interpolation
- Circular interpolation
- CAM control.

1-3-2-1 Linear interpolation

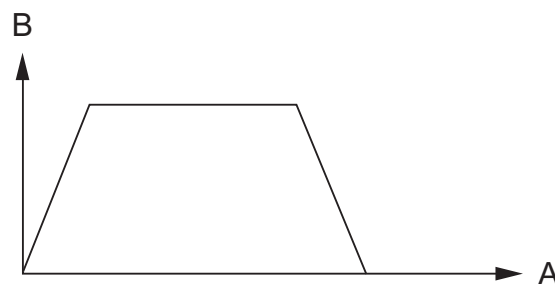
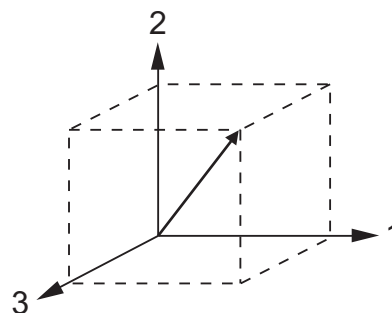

In applications it can be required for a set of motors to perform a move operation from one position to another in a straight line. Linearly interpolated moves can take place among several axes. The commands **MOVE** and **MOVEABS** are also used for the linear interpolation. In this case the commands will have multiple arguments to specify the relative or absolute move for each axis.

Consider the three axis move in a 3-dimensional plane in the figure. It corresponds to the **MOVE(50,50,50)** command. The speed profile of the motion along the path is given in the diagram. The three parameters **SPEED**, **ACCEL** and **DECEL** that determine the multi axis movement are taken from the corresponding parameters of the base axis. The **MOVE** command computes the various components of speed demand per axis. A is the time axis, B is the speed axis.

1-3-2-2 Circular interpolation

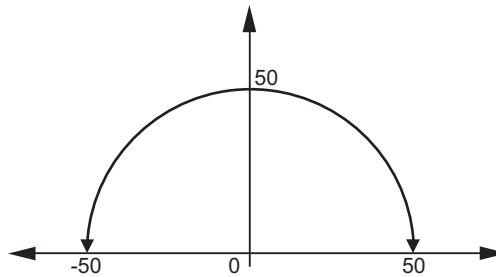

It may be required that a tool travels from the starting point to the end point in an arc of a circle. In this instance the motion of two axes is related via a circular interpolated move using the **MOVECIRC** command. Consider the diagram in the figure. It corresponds to the **MOVECIRC(-100,0,-50,0,0)** command. The centre point and desired end point of the trajectory relative to the start point and the direction of movement are specified. The **MOVECIRC** command computes the radius and the angle of rotation. Like the linearly interpolated **MOVE** command, the **ACCEL**, **DECEL** and **SPEED** variables associated with the base axis determine the speed profile along the circular move.

1-3-2-3 CAM control

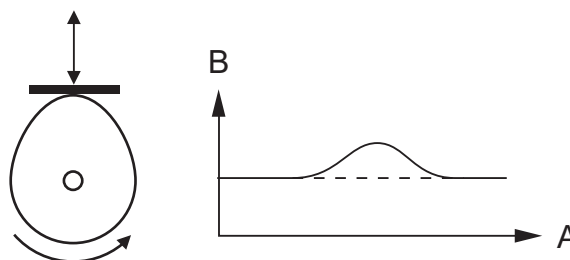

Additional to the standard move profiles the CJ1W-MCH72 also provides a way to define a position profile for the axis to move. The **CAM** command moves an axis according to position values stored in the CJ1W-MCH72 Table array. The speed of travelling through the profile is determined by the axis parameters of the axis.

The figure corresponds to the command **CAM(0,99,100,20)**. A is the time axis, B is the position axis.

1-3-3 EG control

Electronic Gearing control allows you to create a direct gearbox link or a linked move between two axes. The MC Unit supports the following operations.

- Electronic gearbox
- Linked CAM
- Linked move
- Adding axes

1-3-3-1 Electronic gearbox

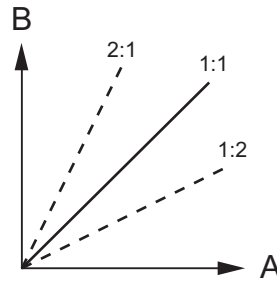

The CJ1W-MCH72 is able to have a gearbox link from one axis to another as if there is a physical gearbox connecting them. This can be done using the **CONNECT** command in the program. In the command the ratio and the axis to link to are specified.

In the figure, A is the Master axis, and B is the **CONNECT** axis.

Axes		Ratio	CONNECT command
0	1		
		1:1	CONNECT(1,0) AXIS(1)
		2:1	CONNECT(2,0) AXIS(1)
		1:2	CONNECT(0.5,0) AXIS(1)

1-3-3-2 Linked CAM control

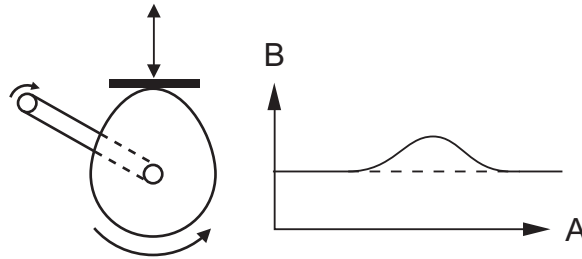

Next to the standard CAM profiling tool the CJ1W-MCH72 also provides a tool to link the CAM profile to another axis. The command to create the link is called **CAMBOX**. The travelling speed through the profile is not determined by the axis parameters of the axis but by the position of the linked axis. This is like connecting two axes through a cam. In the figure, A is the Master axis (0) position, and B is the **CAMBOX** Axis (1) position.

1-3-3-3 Linked move

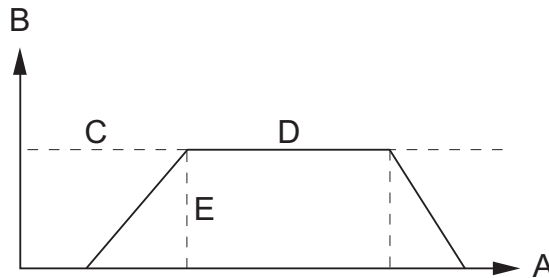

The **MOVELINK** command provides a way to link a specified move to a master axis. The move is divided into an acceleration, deceleration and constant speed part and they are specified in master link distances. This can be particularly useful for synchronizing two axes for a fixed period.

The labels in the figure are:

- A Time axis.
- B Speed axis.
- C Master axis (1).
- D Synchronized.
- E **MOVELINK** axis (0).

1-3-3-4 Adding axes

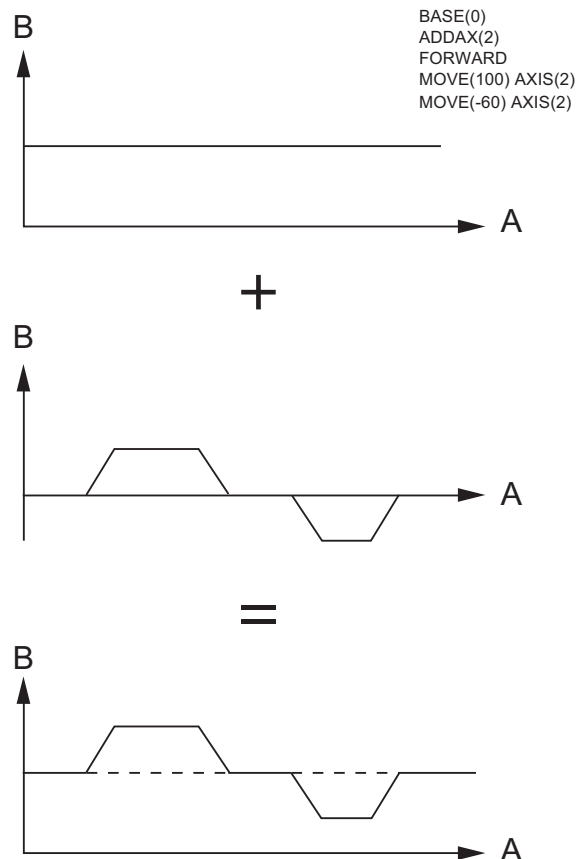

It is very useful to be able to add all movements of one axis to another. One possible application is for instance changing the offset between two axes linked by an electronic gearbox. The CJ1W-MCH72 provides this possibility by using the **ADDAX** command. The movements of the linked axis will consist of all movements of the actual axis plus the additional movements of the master axis.

In the figure, A is the time axis and B is the speed axis.

1-3-4 Other operations

1-3-4-1 Cancelling moves

In normal operation or in case of emergency it can be necessary to cancel the current movement from the buffers. When the **CANCEL** or **RAPIDSTOP** commands are given, the selected axis respectively all axes will cancel their current move.

1-3-4-2 Origin search

The encoder feedback for controlling the position of the motor is incremental. This means that all movement must be defined with respect to an origin point. The **DATUM** command is used to set up a procedure whereby the CJ1W-MCH72 goes through a sequence and searches for the origin based on digital inputs and/or Z-marker from the encoder signal.

1-3-4-3 Print registration

The CJ1W-MCH72 can capture the position of an axis in a register when an event occurs. The event is referred to as the print registration input. On the rising or falling edge of an input signal, which is either the Z-marker or an input, the CJ1W-MCH72 captures the position of an axis in hardware. This position can then be used to correct possible error between the actual position and the desired position. The print registration is set up by using the **REGIST** command.

The position is captured in hardware, and therefore there is no software overhead and no interrupt service routines, eliminating the need to deal with the associated timing issues.

1-3-4-4 Merging moves

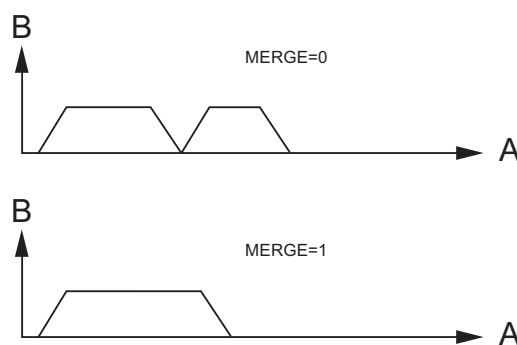

If the **MERGE** axis parameter is set to 1, a movement is always followed by a subsequent movement without stopping. The figures show the transitions of two moves with **MERGE** value 0 and value 1.

In the figure, A is the time axis and B is the speed axis.

1-3-4-5 Jogging

Jogging moves the axes at a constant speed forward or reverse by manual operation of the digital inputs. Different speeds are also selectable by input. Refer to the **FWD_JOG**, **REV_JOG** and **FAST_JOG** axis parameters.

1-4 Servo system principles

The servo system used by and the internal operation of the CJ1W-MCH72 are briefly described in this section.

1-4-1 Semi-closed loop system

The servo system of the CJ1W-MCH72 uses a semi-closed or inferred closed loop system. This system detects actual machine movements by the rotation of the motor in relation to a target value. It calculates the error between the target value and actual movement, and reduces the error through feedback.

1-4-2 Internal operation of the CJ1W-MCH72

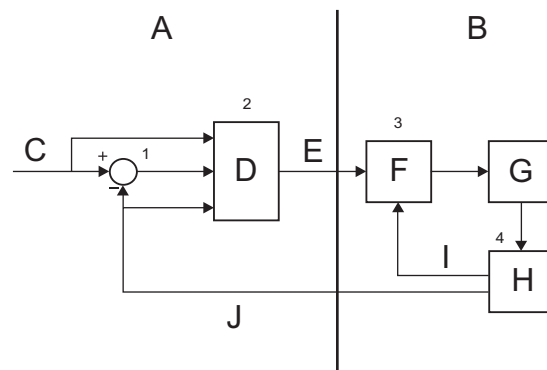

Inferred closed loop systems occupy the mainstream in modern servo systems applied to positioning devices for industrial applications. The figure shows the basic principle of the servo system as used in the CJ1W-MCH72.

- 1 The CJ1W-MCH72 performs actual position control. The main input of the controller is the Following Error, which is the calculated difference between the demand position and the actual measured position.
- 2 The Position Controller calculates the required speed reference output determined by the Following Error and possibly the demanded position and the measured position. The speed reference is provided to the Servo Driver.
- 3 The Servo Driver controls the rotational speed of the servo motor corresponding to the speed reference. The rotational speed is proportional to the speed reference.
- 4 The rotary encoder generates the feedback pulses for both the speed feedback within the Servo Driver speed loop and the position feedback within the CJ1W-MCH72 position loop.

The labels in the figure are:

- A CJ1W-MCH72.
- B Servo system.
- C Demand position.
- D Position control.
- E Speed reference.
- F Speed control.
- G Motor.
- H Encoder.
- I Measured speed.
- J Measured position.

1-4-3 Motion control algorithm

The servo system controls the motor by continuously adjusting the speed reference to the Servo Driver. The speed reference is calculated by the motion control algorithm of the CJ1W-MCH72, which is explained in this section.

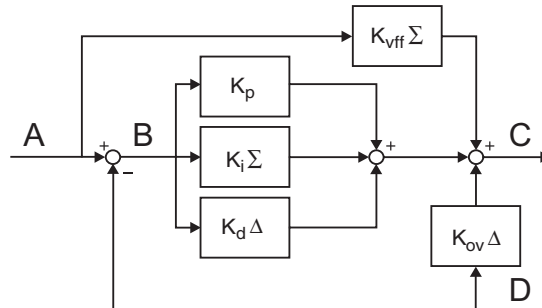

The motion control algorithm uses the demand position (A), the measured position (D) and the Following Error (B) to determine the speed reference. The Following Error is the difference between the demanded and measured position. The demand position, the measured position and the Following Error are represented by the axis parameters **MPOS**, **DPOS** and **FE**. Five gain values have been implemented for the user to be able to configure the correct control operation for each application.

C is the output signal.

- Proportional gain
The proportional gain K_p creates an output O_p that is proportional to the Following Error E.
 $O_p = K_p \cdot E$
All practical systems use proportional gain. For many just using this gain parameter alone is sufficient. The proportional gain axis parameter is called **P_GAIN**.
- Integral gain
The integral gain K_i creates an output O_i that is proportional to the sum of the Following Errors that have occurred during the system operation.
 $O_i = K_i \cdot \Sigma E$
Integral gain can cause overshoot and so is usually used only on systems working at constant speed or with slow accelerations. The integral gain axis parameter is called **I_GAIN**.
- Derivative gain
The derivative gain K_d produces an output O_d that is proportional to the change in the Following Error E and speeds up the response to changes in error while maintaining the same relative stability.
 $O_d = K_d \cdot \Delta E$
Derivative gain may create a smoother response. High values may lead to oscillation. The derivative gain axis parameter is called **D_GAIN**.
- Output speed gain
The output speed gain K_{ov} produces an output O_{ov} that is proportional to the change in the measured position P_m and increases system damping.
 $O_{ov} = K_{ov} \cdot \Delta P_m$

The output speed gain can be useful for smoothing motions but will generate high Following Errors. The output speed gain axis parameter is called **OV_GAIN**.

- Speed feed forward gain

The speed feedforward gain K_{Vff} produces an output O_{Vff} that is proportional to the change in demand position P_d and minimizes the Following Error at high speed.

$$O_{Vff} = K_{Vff} \cdot \Delta P_d$$

The parameter can be set to minimise the Following Error at a constant machine speed after other gains have been set. The speed feed forward gain axis parameter is called **VFF_GAIN**.

The default settings are given in the table along with the resulting profiles. Fractional values are allowed for gain settings.

Gain	Default value
Proportional gain	0.1
Integral gain	0.0
Derivative gain	0.0
Output speed gain	0.0
Speed feedforward gain	0.0

1-5 Trajexia system architecture

The system architecture of the Trajexia is dependant upon these concepts:

- Program control
- Motion Sequence
- Motion buffers
- Communication
- Peripherals

These concepts depend upon the value set in the **SERVO_PERIOD** parameter. The relationship between the value of **SERVO_PERIOD** and the different concepts of the system architecture are describes as follows.

1-5-1 Program control

Programs make the system work in a defined way. The programs are written in a language similar to BASIC and control the application of the axes and modules. 14 Programs can be executed in parallel. The programs can be set to run at system power-up, started and stopped from other programs and executed from Trajexia Studio.

Programs execute commands to move the axes, control inputs and outputs and make communication via BASIC commands.

1-5-2 Motion sequence

The motion sequence controls the position of all 32 axes with the actions as follows:

- Reading the Motion buffer
- Reading the current Measured Position (MPOS)
- Calculating the next Demanded Position (DPOS)
- Executing the Position loop
- Sending the Axis reference
- Error handling

1-5-3 Motion buffers

Motion buffers are the link between the BASIC commands and the Axis control loop. When a BASIC motion command is executed, the command is stored in one of the buffers. During the next motion sequence, the profile generator executes the movement according to the information in the buffer.

When the movement is finished, the motion command is removed from the buffer.

1-5-4 Communication

The CJ1W-MCH72 can exchange data with memory areas in the PLC. This enables the CJ1W-MCH72 to use the inputs and outputs connected to the PLC. Also, programs in the CJ1W-MCH72 and PLC programs can exchange control and status data.

For more information on communication and data exchange, refer to chapter 3.

1-5-5 Peripherals

All inputs and outputs are used with the set of parameters (**IN**, **OP**, **AIN**, **AOUT**). The inputs and outputs are automatically detected and mapped in Trajexia. Inverters are considered a peripheral device and have a set of BASIC commands to control them.

1-6 Cycle time

All processes in the Trajexia system are based on the cycle time. The cycle time is divided into four CPU tasks:

- 250 μs time intervals for a **SERVO_PERIOD** of 0.5 and 1.0 ms

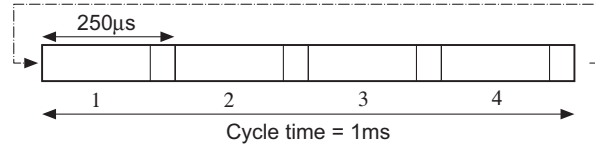

- 500 μs time intervals for a **SERVO_PERIOD** of 2.0 ms

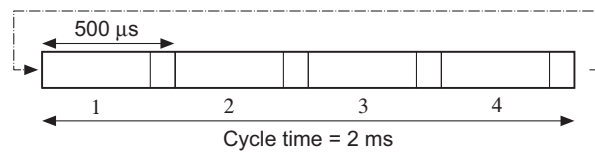

- 1 ms time intervals for a **SERVO_PERIOD** of 4.0 ms

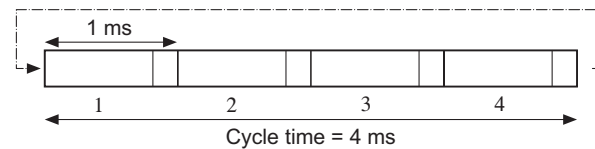

The processes that can be carried out in each time interval depends on the **SERVO_PERIOD** that is set.

The operations executed in each CPU task are:

CPU task	Operation
First CPU task	Motion Sequence Low priority process
Second CPU task	High priority process
Third CPU task	Motion Sequence (only if SERVO_PERIOD =0.5ms) LED Update. High priority process
Fourth CPU task	External Communications

Note The Motion sequence execution depends on setting of the **SERVO_PERIOD** parameter.

1-6-1 Servo period

The **SERVO_PERIOD** can be set at 0.5, 1, 2 or 4 ms. The processes that take place within the cycle time depend on the setting of the **SERVO_PERIOD** parameter. The **SERVO_PERIOD** parameter is a Trajexia parameter that must be set according to the system configuration.

The factory setting is 1ms (**SERVO_PERIOD**=1000). A change is set only after a restart of the CJ1W-MCH72.

Note Only the Sigma-III Servo Driver and the Sigma-V Servo Driver support the 0.5 ms transmission cycle.

1-6-1-1 Servo period 0.5 ms

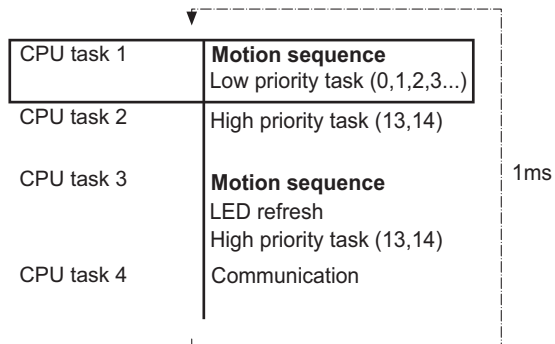

The **SERVO_PERIOD** has a value of 0.5ms and the motion sequence is executed every 0.5ms.

1-6-1-2 Servo period 1 ms

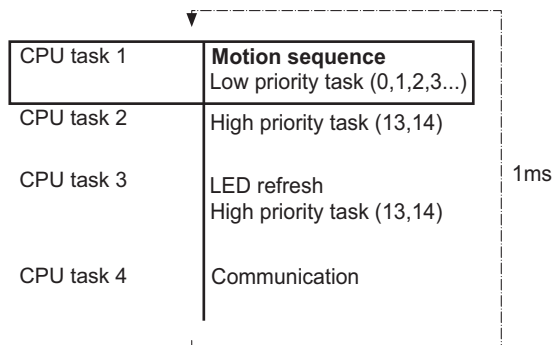

The **SERVO_PERIOD** has a value of 1ms and the motion sequence is executed every 1ms. As the motion sequence is not executed during CPU task 3, there is more time for the program execution. High priority programs run faster.

1-6-1-3 Servo period 2 ms

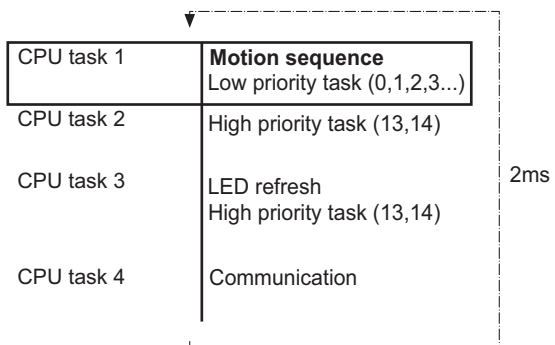

The **SERVO_PERIOD** has a value of 2ms and the motion sequence is executed every 2.0ms.

1-6-1-4 Servo period 4 ms

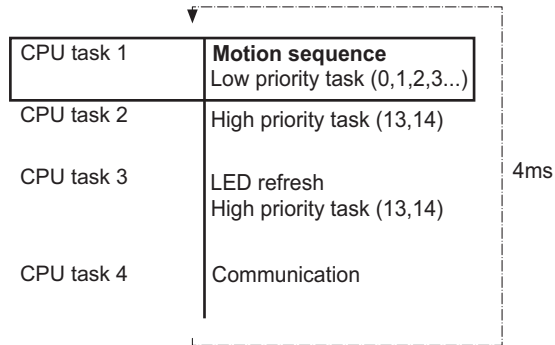

The **SERVO_PERIOD** has a value of 4ms and the motion sequence is executed every 4.0ms.

1-6-1-5 Servo period rules

The number of axes and MECHATROLINK-II slaves in the Trajexia system determines the value of the **SERVO_PERIOD** system parameter. There are 2 types of MECHATROLINK-II slaves that are supported by the CJ1W-MCH72 units:

- Servo Drivers
The CJ1W-MCH72 considers Servo Drivers as axes.
- Inverters
The CJ1W-MCH72 does not consider Inverters as axes.

You should comply with the most restrictive rules when you set the **SERVO_PERIOD** parameter. An incorrect value of the **SERVO_PERIOD** parameter results in an incorrect detection of the MECHATROLINK-II slaves. The most restrictive rules are given in the tables below. For each unit the table lists the maximum number of slaves the unit can control at the given **SERVO_PERIOD** setting.

SERVO_PERIOD	Total number of axes	Number of MECHATROLINK-II stations		Total number of MECHATROLINK-II stations
		axes	inverters	
0.5 ms	8	4	4	4
1.0 ms	16	8	8	8
2.0 ms	16	16	8	16
4.0 ms	32	30	8	30

1-6-1-6 Configuration examples

Example 1

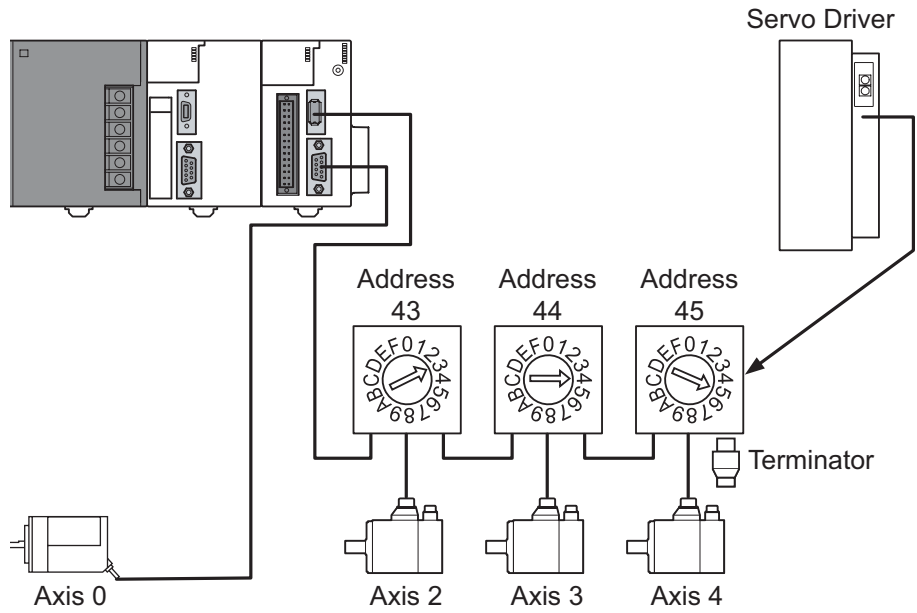

- 1x CJ1W-MCH72
- 3x Sigma-V Servo Driver
- 1x Encoder (Axis 0)
- **SERVO_PERIOD** = 0.5ms

The CJ1W-MCH72 supports 0.5ms **SERVO_PERIOD** with 4 axes. If Sigma-II Servo Drivers were used in this example, the **SERVO_PERIOD** would be 1.0ms, since Sigma-II servo Drivers do not support the **SERVO_PERIOD** of 0.5ms.

Example 2

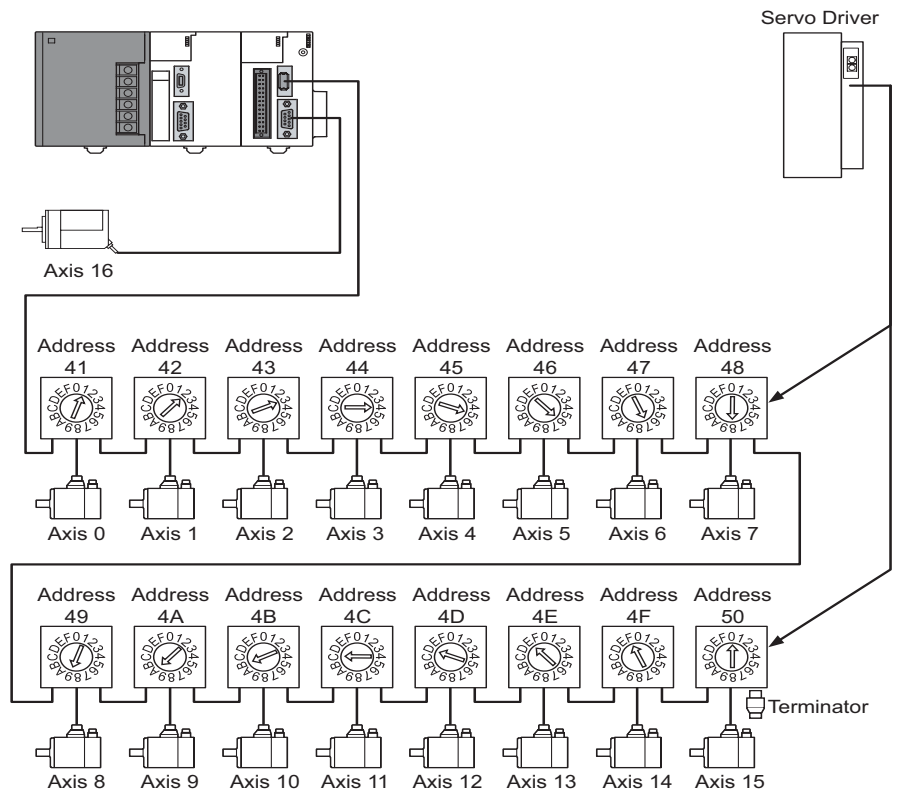

- 1x CJ1W-MCH72
- 16x Sigma-II Servo Driver
- 1x Encoder (Axis 16)
- **SERVO_PERIOD = 4ms**

The CJ1W-MCH72 supports 4ms **SERVO_PERIOD** with 17 axes.

1-7 Program control and multi-tasking

The Trajexia system has program, processes and multi tasking control.

1-7-1 Program control

The Trajexia system can control 14 processes that are written as BASIC programs. When the program is set to run, the program is executed. Processes 1 to 12 are low priority, 13 and 14 are high priority.

1-7-2 Processes

The low-priority process 0 is reserved for the Terminal window of Trajexia Studio. This terminal window is used to write direct BASIC commands to the CJ1W-MCH72 independent to other programs. These commands are executed after you press the Enter button.

1-7-3 Multi-tasking

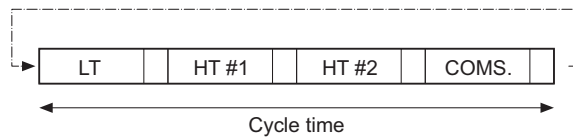

Each cycle time is divided into 4 time slices called CPU tasks. Processes run in the first 3 CPU tasks according to the priority of the process. Motion sequence and low-priority processes (A) are executed in the Low Task (LT) period. High priority processes (B) are executed in the high Task (HT) periods.

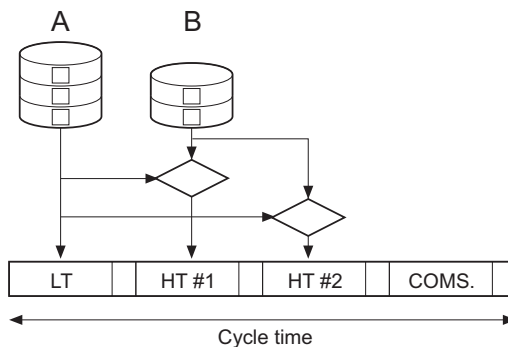

External communication that are not related to the motion network are updated in the communications (COMS) period in the fourth CPU task. Trajexia can control up to 14 programs at the same time. In contrast to low priority processes, a high priority process is always available for execution during two of the four CPU tasks. The high-priority tasks are executed faster than the low-priority tasks, it is that they have more time available for their execution. All the low-priority tasks must share one slot of time and the high-priority task have their own two slots of time.

1-7-4 Multi-tasking example

1	1ms				1ms				1ms				1ms			
	3	14	13	COMS.	2	14	13	COMS.	1	14	13	COMS.	0 (c/l)	14	13	COMS.
2	1ms				1ms				1ms				1ms			
	3	14	COMS.	2	14	COMS.	1	14	COMS.	0 (c/l)	14	COMS.				
3	1ms				1ms				1ms				1ms			
	3	2	1	COMS.	0 (c/l)	3	2	COMS.	1	0 (c/l)	3	COMS.	2	1	0 (c/l)	COMS.

In the example 1, there are two high-priority processes, 13 and 14. The two HT periods are reserved for these processes, one for processes 13 and one for processes 14. The low-priority processes 3, 2, 1 and 0 are executed in the LT period, one process per Cycle time here set to 1.0ms.

In the middle example, there is only one high-priority process, 14. Both HT periods are reserved for this process. The low-priority processes, 3, 2, 1 and 0 are executed in the LT period, one process per cycle time.

In the lower example, there are no high-priority processes. Therefore, the HT periods can be used for the low-priority processes. The LT period is also used for the low-priority processes.

1-8 Motion sequence and axes

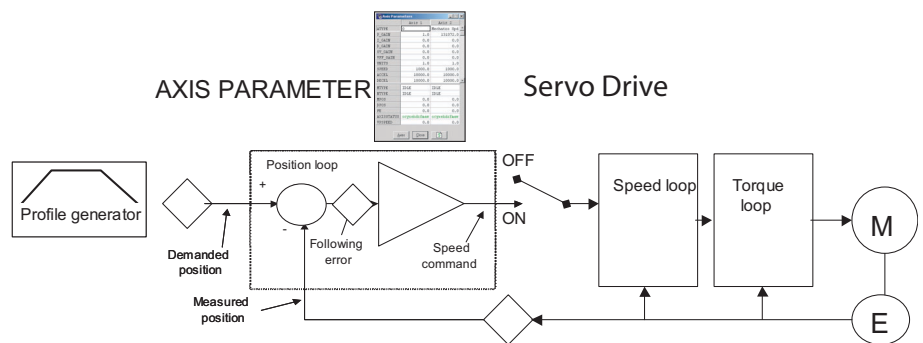

Motion sequence is the part of the CJ1W-MCH72 that controls the axes. The actual way that the motion sequence operates depends on the axis type. The axis type can be set and read by the parameter **ATYPE**. At start-up the Trajexia system automatically detects the configuration of the axes.

- The default value for the parameter **ATYPE** for MECHATROLINK-II axes is 40 (MECHATROLINK-II position).
- The default value for the parameter **ATYPE** for the Encoder Interface is 44 (incremental encoder).

All non allocated axes are set as a virtual axis. The value for the parameter **ATYPE** is 0.
 Every axis has the general structure as shown in the illustration above .

The motion sequence which will be executed at the beginning of each servo period will contain the following elements:

- 1 Transfer any moves from BASIC process buffers to motion buffers (see section 1-9).
- 2 Read digital inputs.
- 3 Load moves. (See note.)
- 4 Calculate speed profile. (See note.)
- 5 Calculate axis positions. (See note.)
- 6 Execute position servo. For axis 0 this also includes the Servo Driver communications. (See note.)
- 7 Update outputs.

Note Each of these items will be performed for each axis in turn before moving on to the next item.

1-8-1 Profile generator

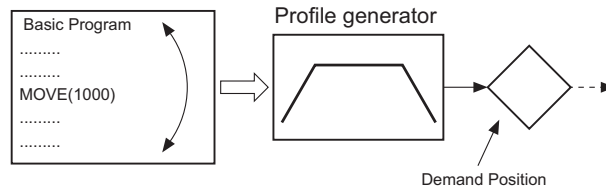

The profile generator is the algorithm that calculates the demanded position for each axis. The calculation is made every motion sequence.
 The profile is generated according to the motion instructions from the BASIC programs.

1-8-2 Position loop

The position loop is the algorithm that makes sure that there is a minimal deviation between the measured position (**MPOS**) and the demand position (**DPOS**) of the same axis.

1-8-3 Axis sequence

- The motion controller applies motion commands to an axis array that is defined with the **BASE** command. If the motion command concerns one axis, it is applied to the first axis in the **BASE** array. If the motion command concerns more than one axis, and makes an orthogonal move, the axes are taken from the array in the order defined by the **BASE** command. For

more information on the **BASE** command and the definition of the axis sequence in an axis array, refer to the Trajexia Programming Manual, chapter 3 (BASIC commands).

- If **SERVO=OFF** for one axis, the motion commands for that axis are ignored.
- If the Following Error (**FE**) in one axis exceeds the parameter value **FELIMIT**, the next action occurs:
 - **WDOG** is set to **OFF** and all axes stop.
 - **SERVO** for the axis that causes the error goes to **OFF**.
 - The current move is cancelled and removed from the buffer.

1-8-4 Type of axis

ATYPE	Applicable to	Name	Description
0	All axes	Virtual axis	Internal axis with no physical output. It is the only valid setting for non-allocated axes. That is, those that are not MECHATROLINK-II Servo Drivers.
40	MECHATROLINK-II Servo Drivers	MECHATROLINK-II Position (default)	Position loop in the Servo Driver. CJ1W-MCH72 sends position reference to the Servo Driver via MECHATROLINK-II.
41		MECHATROLINK-II Speed	Position loop in the Trajexia. CJ1W-MCH72 sends speed reference to the Servo Driver via MECHATROLINK-II.
42		MECHATROLINK-II Torque	Position loop in the Trajexia. CJ1W-MCH72 sends torque reference to the Servo Driver via MECHATROLINK-II.
43	External driver connected to encoder input	Stepper output	Pulse and direction outputs. Position loop is in the driver. CJ1W-MCH72 sends pulses and receives no feed back.
44		Servo axis (Default) Encoder	CJ1W-MCH72 receives position from an incremental encoder.
45		Encoder output	The same as stepper, but with the phase differential outputs emulating an incremental encoder.
47		Absolute EnDat	Feedback is received from an EnDat absolute encoder.
48		Absolute SSI	Feedback is received from an SSI absolute encoder.
49	MECHATROLINK-II Inverters	Inverter as axis	Inverters (with built-in encoder interface) are controlled on the MECHATROLINK-II bus as servo axes.

1-8-4-1 Virtual axis ATYPE=0

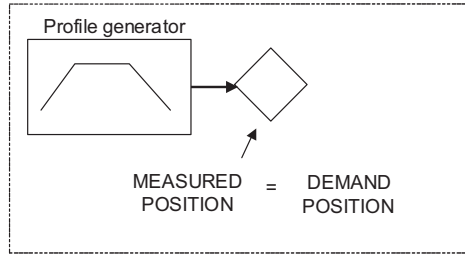

You can split a complex profile into two or more simple movements, each assigned to a virtual axis. These movements can be added together with the BASIC command **ADDAX** then assigned to a real axis.

1-8-4-2 MECHATROLINK-II position ATYPE=40

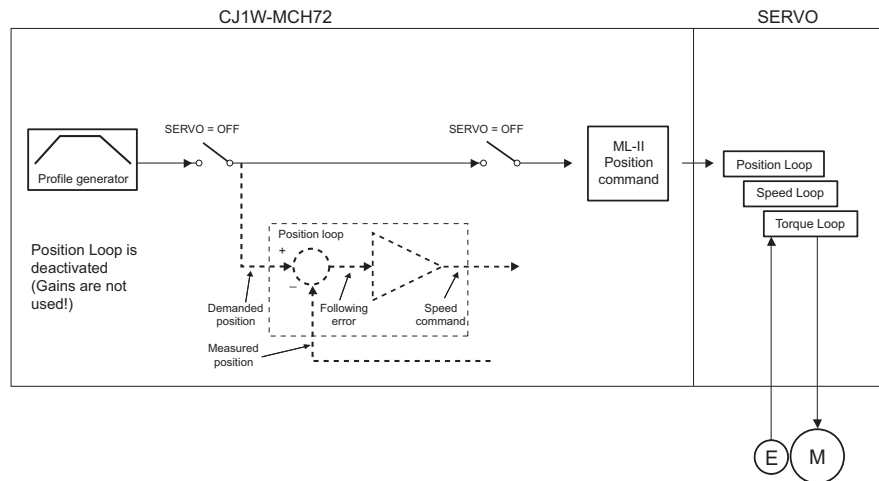

With **SERVO = ON**, the position loop is closed in the Servo Driver. Gain settings in the CJ1W-MCH72 have no effect. The position reference is sent to the Servo Driver.

Note Although **MPOS** and **FE** are updated, the real value is the value in the Servo Driver. The real Following Error can be monitored by the **DRIVE_MONITOR** parameter by setting **DRIVE_CONTROL = 2**.

Note The MECHATROLINK-II position **ATYPE = 40** is the recommended setting to obtain a higher performance of the servo motor.

1-8-4-3 MECHATROLINK-II speed ATYPE=41

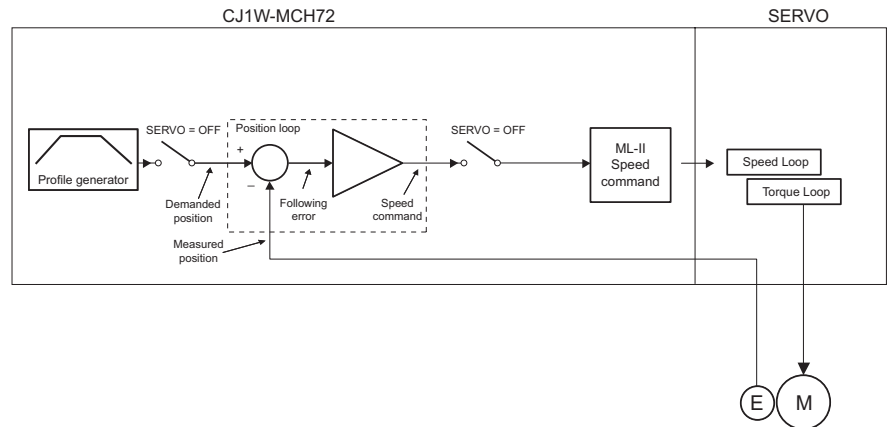

With **SERVO = ON**, the position loop is closed in the CJ1W-MCH72. Speed reference is sent to the Servo Driver. For Mechatrolink Servo Drivers, this axis type is not recommended, since there is one cycle delay in the loop (DPOS(n) is compared with MPOS(n-1)).
 With **SERVO = OFF**, the speed reference is sent via **S_REF** command. 0x40000000 means maximum speed of the servo motor. This is the recommended setting.

1-8-4-4 MECHATROLINK-II torque ATYPE=42

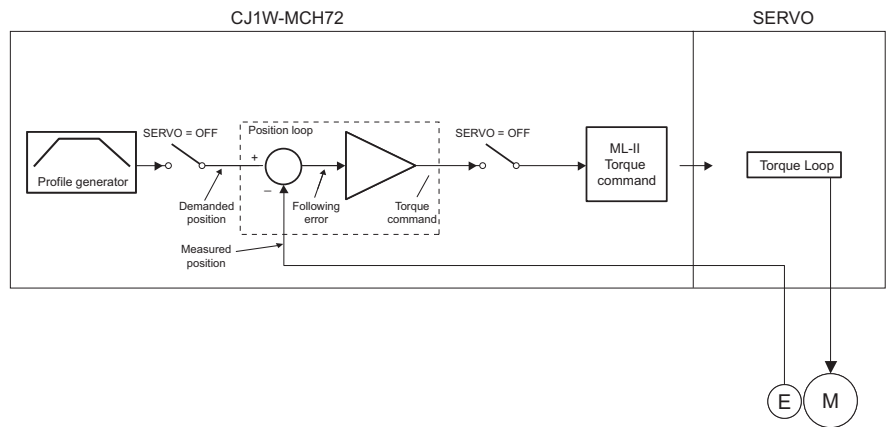

With **SERVO = ON**, only the torque loop is closed in the Servo Driver. The torque reference in the Servo Driver depends on the **FE** and the gain.
 With **SERVO = OFF**, the torque reference is sent directly via the **T_REF** command. 0x40000000 is the maximum torque of the servo motor.

Note To monitor the torque in the servo in **DRIVE_MONITOR**, set **DRIVE_CONTROL=11**.

1-8-4-5 Stepper output ATYPE=43

The position profile is generated and the output from the system is a pulse train and direction signal. This is useful to control a motor via pulses or as a position reference for another motion controller.

1-8-4-6 Servo axis ATYPE=44

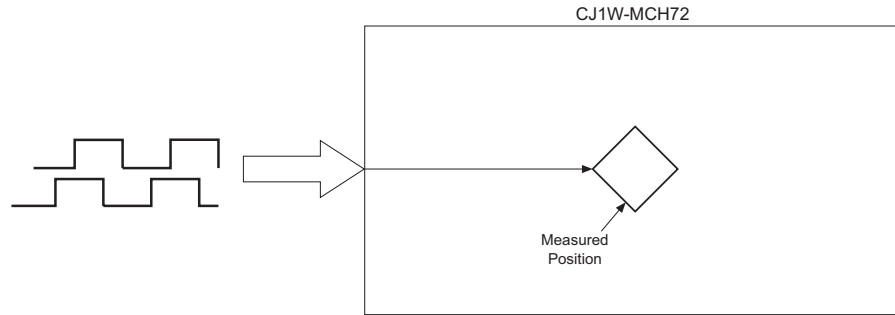

With **SERVO = OFF**, the position of the external incremental encoder is read.

1-8-4-7 Encoder output ATYPE=45

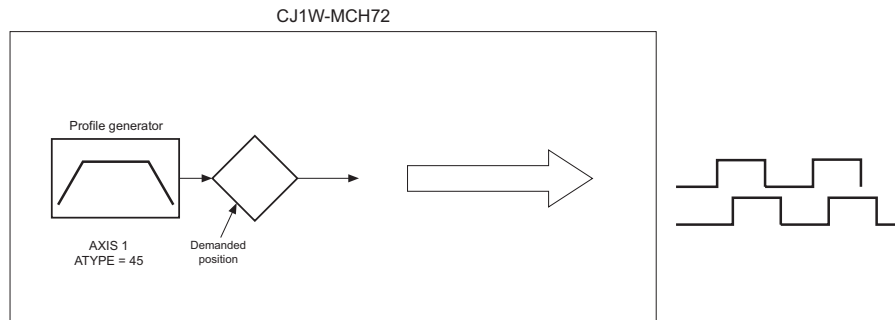

The position profile is generated and the output from the system is an incremental encoder pulse. This is useful to control a motor via pulses or as a position reference for another motion controller.

1-8-4-8 Absolute EnDat encoder ATYPE=47

With **SERVO = OFF**, the position of the external absolute EnDat encoder is read.

1-8-4-9 Absolute SSI encoder ATYPE=48

With **SERVO = OFF**, the position of the external absolute SSI encoder is read.

1-8-4-10 Inverter axis ATYPE=49

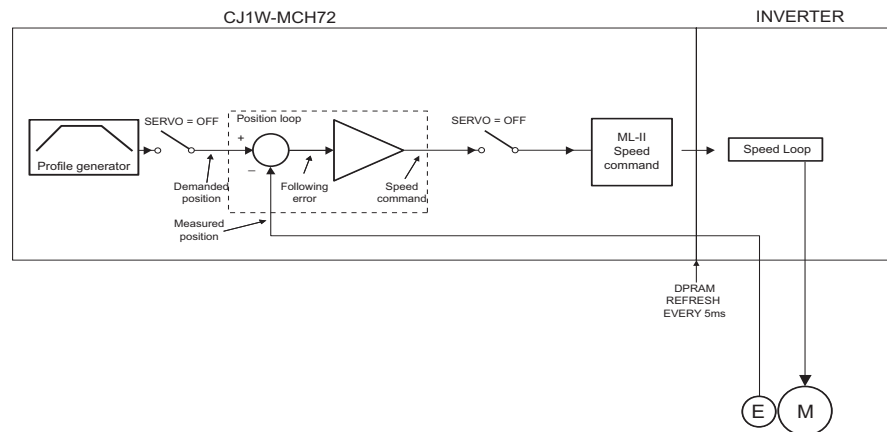

This type allows Inverters (with built-in encoder interface) to be controlled on the MECHATROLINK-II bus as servo axes. From the controller point of view, Inverter axes are handled the same as servo axes in MECHATROLINK-II Speed Mode (**ATYPE=44**). Unlike the other axis types, this Inverter axis must be defined programmatically with function 8 of the command **INVERTER_COMMAND**.

The Speed command to the Inverter and the feedback from the encoder is refreshed in the Inverter with a few milliseconds delay. This is an inverter limitation. This means that the use of the Inverter is similar to the use of a Servo Driver, but the performance is lower.

1-8-4-11 Summary of axis types and control modes

The following table lists the axis types and their recommended modes for speed control, position control and torque control.

ATYPE	SERVO	Mode	Comment
40	OFF	Position (MECHATROLINK-II)	The position loop is closed in the Servo Driver. No new motion command is allowed.
40	ON	Position (MECHATROLINK-II)	Recommended mode for position control with MECHATROLINK-II axes.
41	OFF	Speed (MECHATROLINK-II)	Recommended mode for speed control with MECHATROLINK-II axes. Set the speed with S_REF .
41	ON	Position (MECHATROLINK-II)	The position loop is closed in Trajexia. This gives lower performance than closing the position loop in the Servo Driver.
42	OFF	Torque (MECHATROLINK-II)	Recommended mode for torque control with MECHATROLINK-II axes. Set the torque with T_REF .
42	ON	Position via torque (MECHATROLINK-II)	The position loop is closed in Trajexia. The output of the position loop is sent as the torque reference to the Servo Driver.

ATYPE	SERVO	Mode	Comment
49	OFF	Speed	Inverter (with built-in encoder interface) controlled on the MECHATROLINK-II bus as a servo axis. Set the speed with S_REF .
49	ON	Position	Inverter (with built-in encoder interface) controlled on the MECHATROLINK-II bus as a servo axis. The position loop is closed in Trajexia.

1-9 Motion buffers

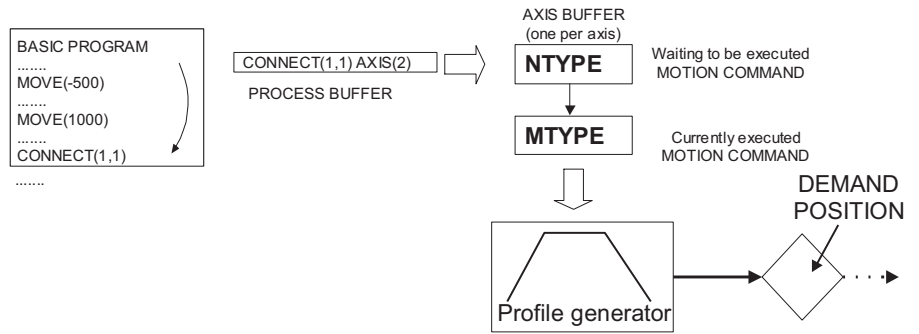

The motion buffer is a temporary store of the motion instruction from the BASIC program to the profile generator.

The BASIC program continues while the instruction waits in the buffer.

There are three types of buffer:

- **MTYPE**. The current movement that is being executed. **MTYPE** relates to the axis and not to the process.
- **NTYPE**. The new movement that waits for execution. **NTYPE** relates to the axis and not to the process.
- Process Buffer. The third buffered movement cannot be monitored. The process buffer relates to the process and not to the axis.

It is possible to check if the process buffer is full by checking the **PMOVE** process parameter.

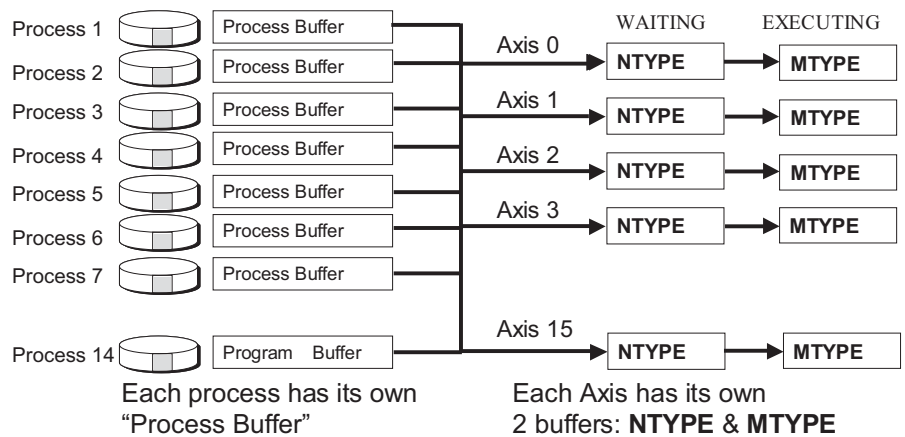

When a motion instruction is executed in the BASIC program, the instruction is loaded into the process buffer and distributed to the corresponding axis buffer in the next motion sequence.

If a fourth motion instruction is executed and the three buffers are full, the BASIC program stops execution until a process buffer is free for use.

EXAMPLE:

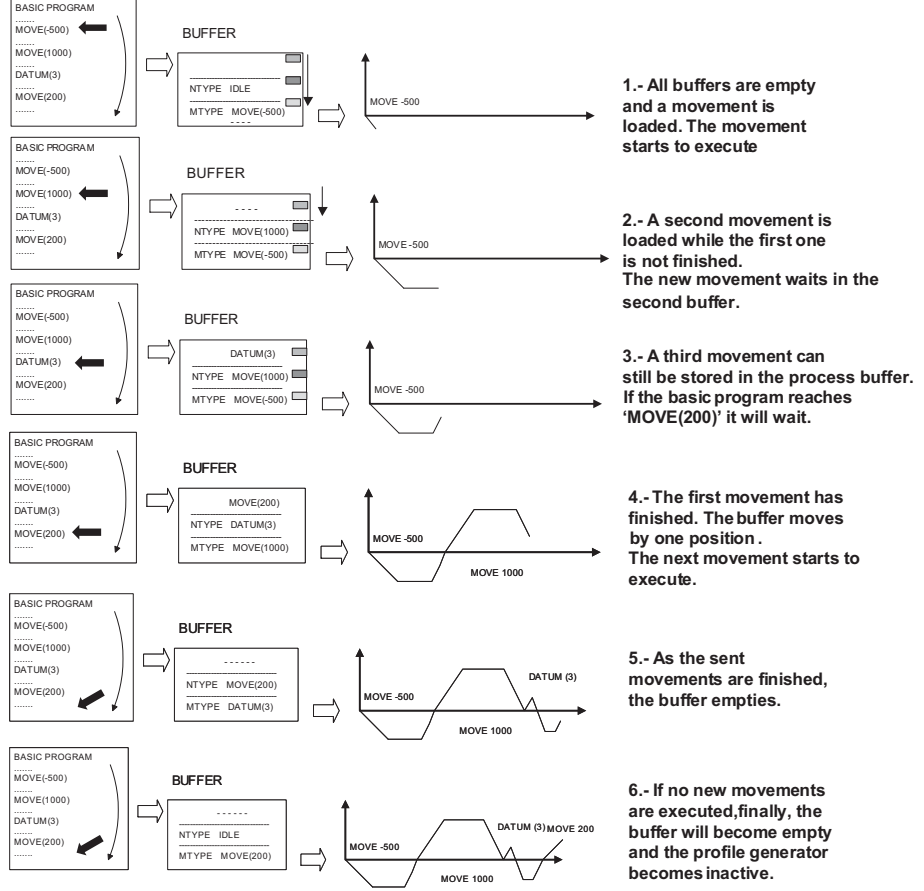

Example of buffered instructions:

1-10 Mechanical system

1-10-1 Inertia ratio

The inertia ratio is a stability criterion. The higher the inertia of the load in relation to the inertia of the motor, the lower the gains you can set in your system before you reach oscillation, and the lower the performance you can reach.

With a ratio of 1:30 for small Servo Drivers and a ratio of 1:5 for big Servo Drivers you can reach the maximum dynamic of the motor-driver combination.

1-10-2 Rigidity

If a machine is more rigid and less elastic, you can set higher gains without vibration, and you can reach higher dynamic and lower Following Error.

1-10-3 Resonant frequency

A mechanical system has at least one resonant frequency. If you excite your mechanical system to the resonant frequency, it starts oscillating. For motion systems, it is best to have mechanical systems with a very high resonant frequency, that is, with low inertia and high rigidity.

The resonant frequency of the mechanical system is the limit for the gain settings.

1-11 Axis numbers

The CJ1W-MCH72 has a maximum of 31 non-virtual axes:

- 30 MECHATROLINK-II axes
- 1 Flexible axis (on the Encoder Interface)

MECHATROLINK-II slaves can have a station address that ranges from 41 hex to 5F hex. These station addresses correspond to axis numbers 0 to 29. The first non-assigned axis number, that is, the first axis number that is not assigned to a MECHATROLINK-II station address, is used for the flexible axis on the CJ1W-MCH72 encoder interface.

SECTION 2 Installation and wiring

2-1 Unit components

The CJ1W-MCH72 Motion Control Unit has the following components:

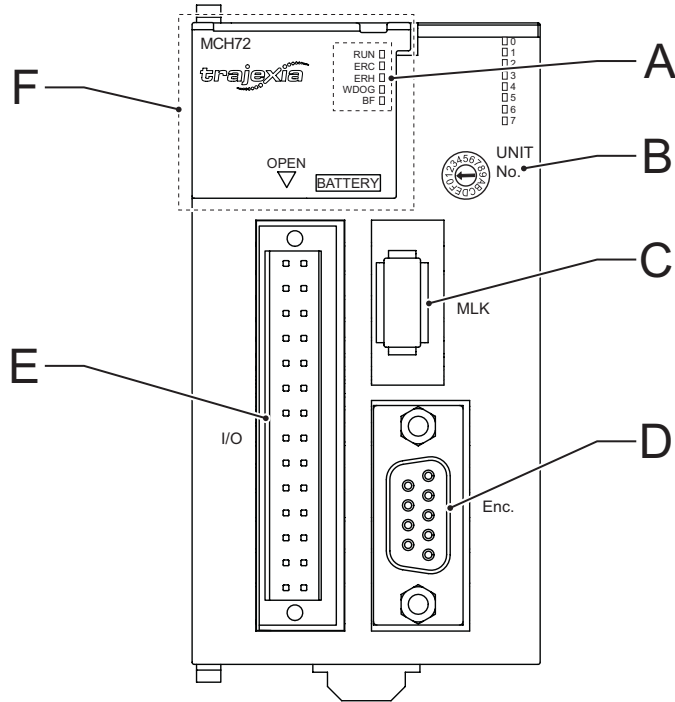

CJ1W-MCH72 Motion Control Unit

Label	Description
A	Status LED indicators
B	Unit number selector switch
C	MECHATROLINK-II connector
D	Encoder connector
E	I/O connector
F	Battery compartment

2-1-1 Status LED indicators

The CJ1W-MCH72 has 5 status LEDs. They indicate the operational mode and the status of the CJ1W-MCH72. The status LEDs are given in the table below.

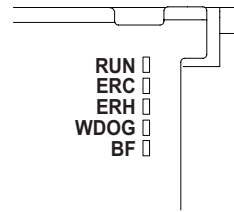

Status LEDs

LED	Color	Status	Description
RUN	Green	OFF	<ul style="list-style-type: none"> Startup test failed, unit not operational Fatal error, operation stopped
		Flashing	Detection of MECHATROLINK-II slaves and assignment of axes in progress
		ON	Unit is ready to execute BASIC commands
ERC	Red	OFF	Unit is in normal operation
		Flashing during startup	Hardware error
		Flashing during execution	Low battery
		ON	Error log access error
ERH	Red	OFF	CPU in normal operation
		ON	Communication error with PLC CPU
WDOG	Green	OFF	Unit does not operate a Servo Driver
		ON	Unit operates a Servo Driver
BF	Red	OFF	Normal operation
		ON	MECHATROLINK-II bus fault

Also, the CJ1W-MCH72 has 8 general-purpose LEDs. The function of the general-purpose LEDs can be controlled with the **DISPLAY** system parameter. The table below lists the configuration for the LEDs and the **DISPLAY=n** command where **n** ranges from 0 to 7.

LED	n=0	n=1	n=2	n=3	n=4	n=5	n=6	n=7
0	IN0	IN8	IN16	IN24	OUT0	OUT8	OUT16	OUT24
1	IN1	IN9	IN17	IN25	OUT1	OUT9	OUT17	OUT25
2	IN2	IN10	IN18	IN26	OUT2	OUT10	OUT18	OUT26
3	IN3	IN11	IN19	IN27	OUT3	OUT11	OUT19	OUT27
4	IN4	IN12	IN20	IN28	OUT4	OUT12	OUT20	OUT28
5	IN5	IN13	IN21	IN29	OUT5	OUT13	OUT21	OUT29
6	IN6	IN14	IN22	IN30	OUT6	OUT14	OUT22	OUT30
7	IN7	IN15	IN23	IN31	OUT7	OUT15	OUT23	OUT31

For example: if the command **DISPLAY=1** is executed, LED 5 reflects the activity of input IN13 (pin 16) of the 28-pin I/O connector.

2-1-2 Unit number selector switch

The unit number identifies each individual CPU bus unit when more than one CPU bus unit is connected to the same PLC. The unit number must be unique for each CPU bus unit. If the unit number is not unique, the PLC system cannot start correctly.



Unit number selector switch

The unit number can range from 0 hex to F hex.

2-1-2-1 Word allocations for CPU bus units

Words are automatically allocated in the CIO area of CJ-series PLC systems. The CJ1W-MCH72 uses these words to receive control data from the CPU and to notify the CPU of its status and the status of the communication. The word addresses in the allocated areas depend on the unit number. Because the word addresses are hard-coded in user programs, a user program becomes invalid when the unit number is changed. The table below gives the relation between the unit number and the allocated CIO area words.

Unit number	Allocated words	Unit number	Allocated words
0 hex (0)	CIO1500..CIO1524	8 hex (8)	CIO1700..CIO1724
1 hex (1)	CIO1525..CIO1549	9 hex (9)	CIO1725..CIO1749
2 hex (2)	CIO1550..CIO1574	A hex (10)	CIO1750..CIO1774
3 hex (3)	CIO1575..CIO1599	B hex (11)	CIO1775..CIO1799
4 hex (4)	CIO1600..CIO1624	C hex (12)	CIO1800..CIO1824
5 hex (5)	CIO1625..CIO1649	D hex (13)	CIO1825..CIO1849
6 hex (6)	CIO1650..CIO1674	E hex (14)	CIO1850..CIO1874
7 hex (7)	CIO1675..CIO1699	F hex (15)	CIO1875..CIO1899

2-1-3 Battery

The battery makes sure that the following RAM data is preserved when the power supply is off:

- User programs
- VR variables
- Table memory

If the battery is not installed, or the battery voltage is too low, the RAM data is lost when the power supply is off.

User programs, VR variables and TABLE memory can be stored into flash memory, which do not need battery back up, on user request using the BASIC commands EPROM and FLASHVR.

2-1-3-1 Battery lifetime

The maximum lifetime of a battery is 5 years when the ambient temperature is 25°C. The lifetime of the battery is shorter when the ambient temperature is higher. The lifetime of the battery is also shorter when there is no power supply to the unit for long periods.

2-1-3-2 Low-battery indicator

If a low-battery error occurs, the ERC LED flashes, the **BATTERY_LOW** parameter is **ON**, and bit 3 of status word $n+2$ is set (see section 3-3-1-2). If this occurs, perform the following steps:

- 1 Check if the battery is installed correctly.
- 2 If the battery is installed correctly, replace it.

When a low-battery error occurs, the battery can continue to function for 5 days if the ambient temperature is 25°C and if power is supplied to the PLC system at least one time per day. If the power is not turned off until the battery is replaced, the battery failure and the resulting loss of RAM data can be delayed.

If the ambient temperature is more than 25°C, the battery can only continue for less than 5 days. If the ambient temperature is 40°C, the battery can continue for 4 days. If the ambient temperature is 55°C, the battery can continue for 2 days.

2-1-3-3 Replacing the battery

When replacing the battery, make sure that the following is adhered to:

- Use the CJ1W-BAT01 as a replacement battery.
- Do not use a replacement battery that is older than 2 years. The production date of the battery is shown on the label, in the format *yy-mm*, where *yy* is the year and *mm* is the month.



Production date of the battery: March 2008.

- Make sure that the sensitive internal components of the CJ1W-MCH72 cannot be damaged by static electricity when the battery is replaced. This can be done in two ways:
 - 1 Turn the power off. (This is the recommended way.)
 - 2 Leave the power on, and touch a grounded piece of metal to discharge static electricity before replacing the battery.
- Make sure that an experienced technician is in charge when the battery is replaced. This is required by UL standards.

To replace the battery, perform the following steps:

- 1 Make sure that the power to the unit is on for at least 5 minutes.
- 2 Turn the power to the unit off.

Note You must perform the following steps within 5 minutes. If you do not perform the steps within 5 minutes, the RAM can be deleted.

- 3 Open the battery compartment.
- 4 Remove the old battery (A) from the battery compartment.

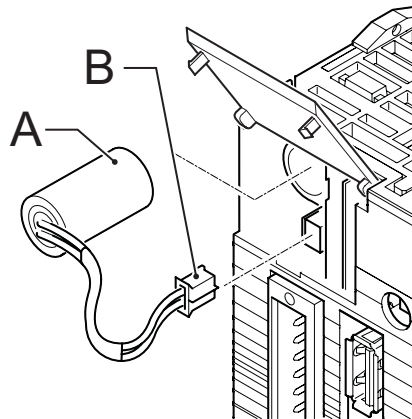

Battery (A) and battery connector (B)

- 5 Remove the battery connector (B) of the old battery.
- 6 Connect the battery connector (B) of the new battery.
- 7 Install the new battery (A) in the battery compartment.
- 8 Close the battery compartment.

When the new battery is installed, the low-battery error is cleared.

- ⚠ WARNING** These actions can cause the battery to leak, burn or rupture, which can lead to fire, injury, loss of property and death.
- Do not short-circuit the battery terminals.
 - Do not charge the battery.
 - Do not disassemble the battery.
 - Do not heat the battery or set fire to the battery.

- ⚠ WARNING** Do not use a battery that is dropped on the floor or that is subjected to a shock. The battery can leak.

2-1-4 I/O connector

The I/O connector is a 28-pin connector used to wire to an external I/O. All I/Os are general-purpose I/Os. Functions like limit inputs and origin proximity inputs can be allocated.

The recommended connector is the Weidmuller B2L 3.5/28 LH connector.

2-1-5 MECHATROLINK-II connector

The MECHATROLINK-II connector is used to connect the CJ1W-MCH72 unit to a MECHATROLINK-II network.

2-1-6 Encoder connector

The encoder connector of the MCH72 supports different types of encoders. It can also act as a reference output. It supports the following:

- Incremental encoder input, for line-driver type encoders
- Two different absolute encoder standards: SSI and EnDat
- Incremental encoder output, to simulate a line-driver type encoder
- Stepper output, to control stepper drivers

2-2 Wiring

2-2-1 I/O connector

The I/O connector is a 28-pin connector. Input 0 and input 1 can also be used as registration inputs.

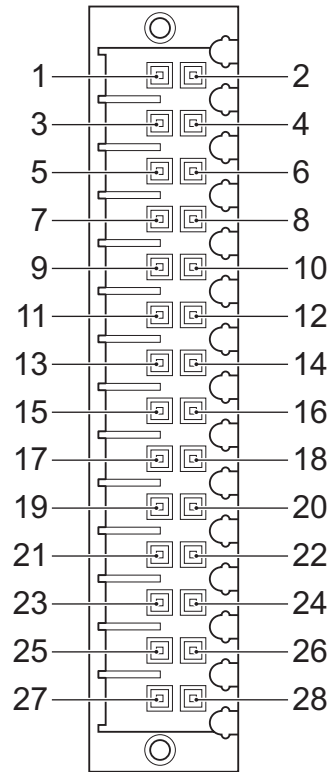

I/O connector pins

The connections of the pins are given in the table below.

Pin	Connection	Pin	Connection
1	Input common	2	Input common
3	Registration input 0	4	Registration input 1
5	Input 2	6	Input 3
7	Input 4	8	Input 5
9	Input 6	10	Input 7
11	Input 8	12	Input 9
13	Input 10	14	Input 11
15	Input 12	16	Input 13
17	Input 14	18	Input 15
19	Output 8 (PSWITCH)	20	Output 9
21	Output 10	22	Output 11
23	Output 12	24	Output 13
25	Output 14	26	Output 15

Pin	Connection	Pin	Connection
27	0 V Output common	28	24 V Power supply input for the outputs

2-2-1-1 Specifications

The table below shows the digital input specifications of input 0 to input 3 for the I/O.

Item	Specification
Type	NPN/PNP
Maximum voltage	24 VDC +10% See footnote ¹
Input current	8 mA at 24 VDC
ON voltage	17 VDC min.
OFF voltage	5 VDC max.
Maximum response time	1250 μ s if the servo period equals 0.5 ms or 1.0 ms 2500 μ s if the servo period equals 2.0 ms
Registration response time (Inputs 0 and 1)	1 μ s typical
Ambient operating temperature	0°C to 55°C When all digital inputs are on: max. 45°C When max. 8 digital inputs are on: max. 55°C

1. For UL certified applications always use, for external power supply, a Class 2 power supply.

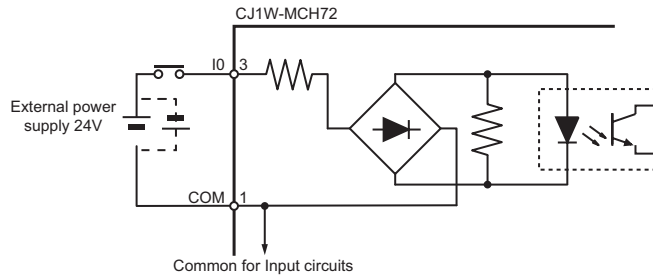

Circuit configuration for input 0 to input 3

The table below shows the digital input specifications of input 4 to input 15 for the I/O.

Item	Specification
Type	NPN/PNP
Maximum voltage	24 VDC +10% See footnote ¹
Input current	3.2 mA at 24 VDC
ON voltage	12 VDC min.
OFF voltage	5 VDC max.
Maximum response time	1250 μ s if the servo period equals 0.5 ms or 1.0 ms 2500 μ s if the servo period equals 2.0 ms

Item	Specification
Ambient operating temperature	0°C to 55°C When all digital inputs are on: max. 45°C When max. 8 digital inputs are on: max. 55°C

- For UL certified applications always use, for external power supply, a Class 2 power supply.

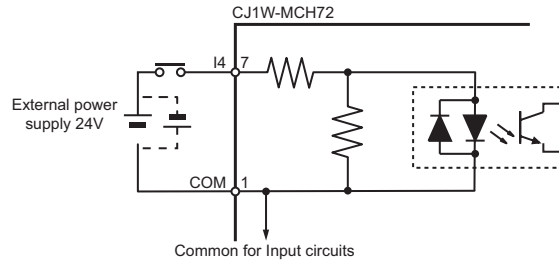

Circuit configuration for input 4 to input 15

The table below shows the digital output specifications of output 8 to output 15 for the I/O.

Item	Specification
Type	PNP
Maximum voltage	24 VDC +10% See footnote ¹
Current capacity	100 mA for each output 800 mA in total for the group of 8 outputs
Protection	Over current Over temperature 2 A fuse on common
Maximum response time	250 μs for ON, 350 μs for OFF, if the servo period equals 0.5 ms or 1.0 ms 500 μs for ON, 600 μs for OFF, if the servo period equals 2.0 ms 150 μs when the HW_PSWITCH is used

- For UL certified applications always use, for external power supply, a Class 2 power supply.

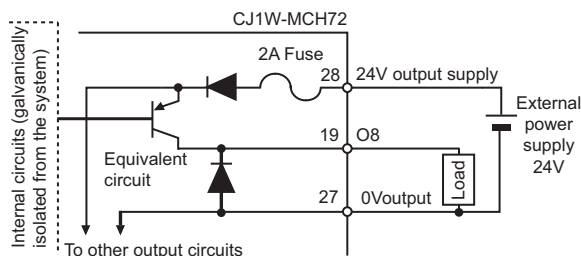

Circuit configuration for output 4 to output 15

2-2-2 Encoder connector

The connections of the pins are given in the table below.

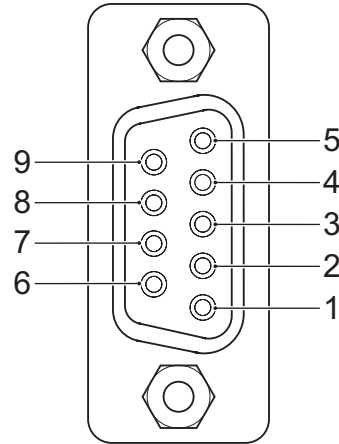

Encoder connector pins

Pin	Incremental encoder input	Incremental encoder output	Stepper output	SSI, EnDat
1	NC			
2	A+	A+	Step+	Clock+
3	A-	A-	Step-	Clock-
4	B+	B+	Dir+	
5	B-	B-	Dir-	
6	5 V Encoder power supply			
7	Z+	Enable+	Enable+	Data+
8	Z-	Enable-	Enable-	Data-
9	0 V Encoder ground			
Shell	FG			

2-2-2-1 Specifications

The table below shows the specifications.

Item	Specification
Signal level	EIA RS-422A Standards
Input impedance	48 kΩ min.
Current capacity	20 mA
Termination	None
Maximum response time registration	0.5 μs

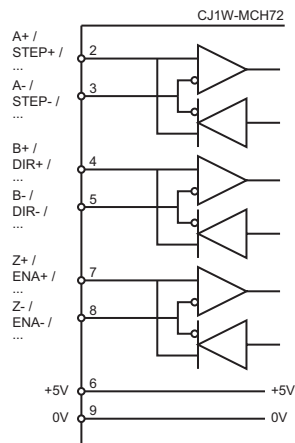

Circuit configuration for the encoder interface

2-2-3 Incremental encoder

An incremental encoder has the following phase definition:

- An advanced phase A for forward rotation.
- An advanced phase B for reverse rotation.

By monitoring the relative phase of the 2 signals, you can easily detect the rotation direction. If signal A leads signal B, the movement is clockwise and the counter increments. If channel B leads channel A, the movement is counterclockwise and the counter decrements.

Most rotary encodes also provide an additional Z marker. This Z marker is a reference pulse within each revolution. With these 3 signals, you can determine the direction, the speed and the relative position.

2-2-3-1 Encoder input

The pulse ratio of the CJ1W-MCH72 is 1: every encoder edge (i.e., a pulse edge for either phase A or B) is equal to one internal count.

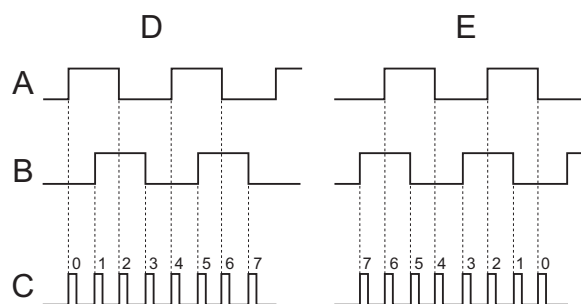

Encoder edges

The figure shows phase A (A), phase B (B) and the number of counts (C) for forward or clockwise rotation (D) and reverse or counterclockwise rotation (E). The signals A, B and Z appear physically as A+ and A-, B+ and B- and Z+ and Z-. They appear as differential signals on twisted-pair wire inputs. This makes sure that common mode noise is rejected. When you use an encoder from other manufacturers, check the encoder specification for the phase

advancement carefully. If the phase definition is different from the phase definition of the standard OMRON equipment, reverse the B-phase wiring between the CJ1W-MCH72 and the encoder.

Note The encoder interface of the CJ1W-MCH72 does not have termination inside. In case of long distances or disturbed communication, add external termination to the interface.

2-2-3-2 Registration

When using the incremental encoder interface of the CJ1W-MCH72, the CJ1W-MCH72 can capture the position of the Flexible Axis in a register when an event occurs. The event is called the print registration input. On the rising or falling edge of an input signal (either the Z marker or one of the first 2 digital inputs), the CJ1W-MCH72 captures the position of the axis in the hardware. You can use this position to correct possible errors between the actual position and the desired position.

To set up the print registration, you can use the **REGIST** command. The position is captured in the hardware, which means that there is no software overhead. Therefore, you do not have to deal with timing issues.

For more information on how to use the registration inputs, refer to the **REGIST** command in section 4-2-200.

2-2-3-3 Hardware PSWITCH

The MCH72 has one output (output 8) that can be used as a hardware position switch. This output goes on when the measured position of the Flexible Axis is reached. It goes off when another measured position is reached.

The output is driven by hardware only. This means that the response times do not have software delays. For more information on using the position switch, refer to section 4-2-130 on the **HW_PSWITCH** command.

2-2-3-4 Connection example

The table below and the figure give an example of the OMRON E6B2-CWZ1Z encoder connected to the CJ1W-MCH72.

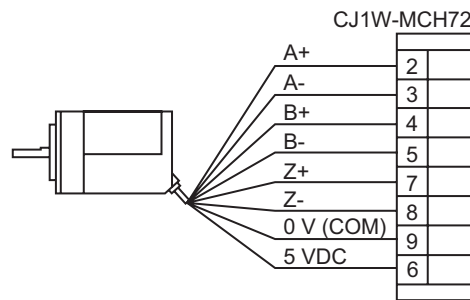

Encoder input connection

E6B2-CWZ1Z encoder		CJ1W-MCH72 encoder interface	
Signal	Wire color	Pin	Signal
A+	Black	2	A+
A-	Black/red	3	A-
B+	White	4	B+
B-	White/red	5	B-

E6B2-CWZ1Z encoder		CJ1W-MCH72 encoder interface	
Signal	Wire color	Pin	Signal
Z+	Orange	7	Z+
Z-	Orange/red	8	Z-
0 V (COM)	Blue	9	0 V Encoder ground
5 VDC	Brown	6	5 V

2-2-3-5 Encoder output

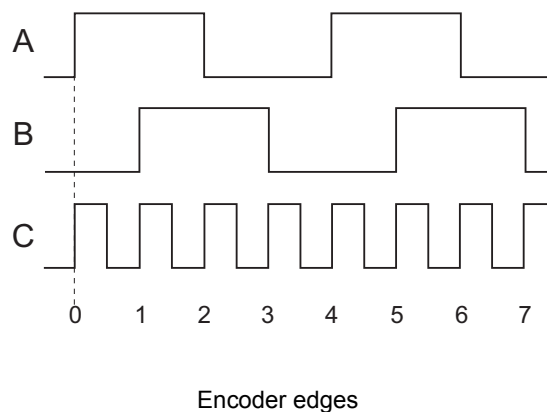

The CJ1W-MCH72 can generate encoder-type pulses. For each internal count (C), the CJ1W-MCH72 produces one encoder edge for phase A (A) or phase B (B).

2-2-4 Absolute encoder

2-2-4-1 SSI

SSI (Synchronous Serial Interface) is a digital system for transferring data in serial form. SSI is the most widely used serial interface between absolute sensors and controllers. SSI uses a pulse train from the controller to clock out the data from the sensor. The SSI interface of the CJ1W-MCH72 accepts absolute values from an encoder if the data is in Gray Code format or in binary format and if the resolution is 25 bits or less. The number of bits, and therefore the number of clock pulses sent to the encoder in each frame, is programmable. You set this number with the BASIC command **ENCODER_BITS = n**.

When you have initialized the CJ1W-MCH72 with the **ENCODER_BITS** command, the CJ1W-MCH72 continuously sends clock pulses to the encoder. These clock pulses are sent in frames of $n+2$ pulses, where n is the bit count set. The clock rate is fixed at 200 kHz. The clock interval between frames is 32 μ s. The resulting maximum cable length between the controller and the sensor is 200 m.

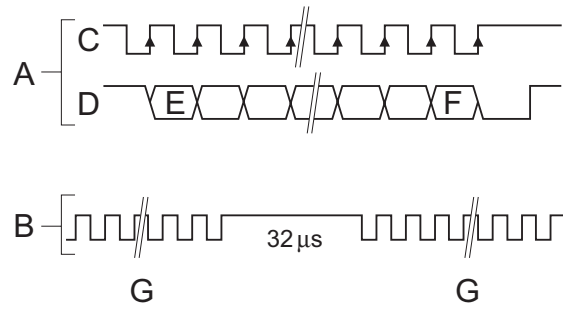

SSI pulses

The labels in the figure are:

- A Timing diagram
- B Clock sequence
- C Clock
- D Data
- E MSB (Most Significant Bit)
- F LSB (Least Significant Bit)
- G Clock frame

When the data is clocked into the CJ1W-MCH72, the position value is interpreted. With this position value, it produces a value for **MPOS** and a position error that is used to close the control loop.

The connections for SSI are:

Pin	Signal
2	Clock+
3	Clock-
6	5 V
7	Data+
8	Data-
9	0 V

Note

The CJ1W-MCH72 encoder interface does not have a termination inside. In case of long distances or disturbed communication, add an external termination to the interface.

The table below and the figure give an example of how to connect the Stegmann ATM 60-A encoder to the CJ1W-MCH72.

Encoder			CJ1W-MCH72 encoder interface	
Pin	Signal	Wire color	Pin	Signal
2	Data+	White	7	Data+
10	Data-	Brown	8	Data-
3	Clock+	Yellow	2	Clock+
11	Clock-	Lilac	3	Clock-

Encoder			CJ1W-MCH72 encoder interface	
Pin	Signal	Wire color	Pin	Signal
1	GND	Blue	9	0 V Encoder ground
8	Us	Red	See footnote ¹	

1. Use an external power supply

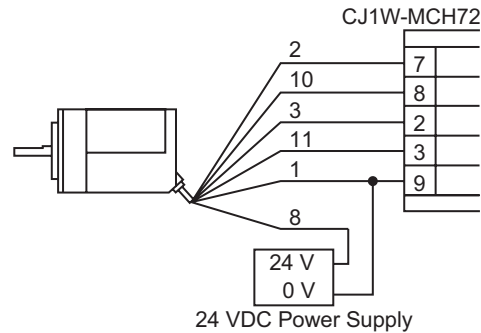

Stegmann ATM 60-A connection

2-2-4-2 EnDat

You can configure the CJ1W-MCH72 to interface directly to EnDat absolute encoders. EnDat absolute encoders respond on a dedicated Clock and Data 1 MHz RS485 serial interface when their position is requested by the controller. When you set the encoder to the relevant encoder mode, the axis transmits an information request to the encoder on a fixed 250 μs cycle.

The connections for EnDat are:

Pin	Signal
2	Clock+
3	Clock-
6	5 V
7	Data+
8	Data-
9	0 V

Note The CJ1W-MCH72 encoder interface does not have a termination inside. In case of long distances or disturbed communication, add an external termination to the interface.

The table below and the figure give an example of the connection of the Heidenhain ROC 425 2048 5XS08-C4 encoder to the CJ1W-MCH72.

Encoder			CJ1W-MCH72 encoder interface	
Pin	Signal	Wire color	Pin	Signal
3	Data	Grey	7	Data+
4	/Data	Pink	8	Data-
7	Clock	Violet	2	Clock+

Encoder			CJ1W-MCH72 encoder interface	
Pin	Signal	Wire color	Pin	Signal
6	/Clock	Yellow	3	Clock-
5	GND	White/green	9	0 V Encoder ground
2	0 V	White	See footnote ¹	
1	Up	Blue		

1. Use an external power supply

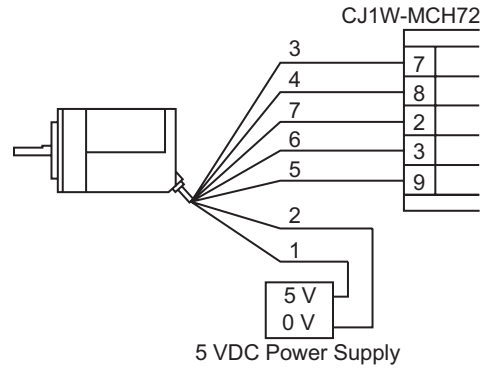

Heidenhain ROC 425 2048 5XS08-C4 connection

2-2-4-3 Stepper

The CJ1W-MCH72 can generate pulses to drive an external stepper motor amplifier. You can use single step, half step and microstepping drivers with this interface. The applicable signals are:

- Enable
- Step
- Direction

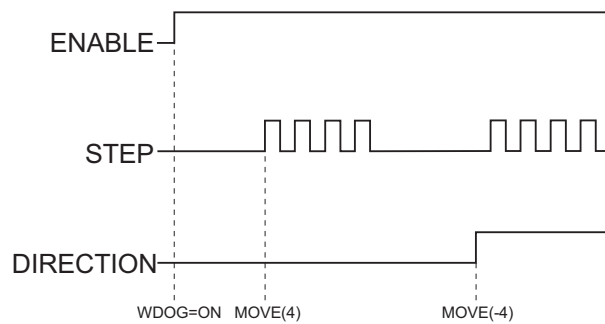

The applicable signals when a **MOVE** operation is performed

2-3 Installation

2-3-1 Hardware installation

- ⚠ Caution** Obey the following precautions when you install the CJ1W-MCH72 in a PLC system:
- Turn off the power supply to the PLC before the installation or connection of the CJ1W-MCH72.
 - Use separate conduits or ducts for the I/O lines. This prevents noise from high-tension lines or power lines.
 - Do not remove the label on top of the CJ1W-MCH72 during the installation and wiring. The label makes sure that no foreign matter can enter the unit.
 - Remove the label on top of the CJ1W-MCH72 after the installation and wiring of the unit. This makes sure that the unit cannot become overheated.

The CJ1W-MCH72 can be installed in any slot in a CJ-series CPU rack or in a CJ-series expansion CPU rack. The CJ-series PLC supports up to 4 expansion CPU racks.

Up to 16 CPU bus units can be connected to one PLC. Also, the maximum number of CJ1W-MCH72 units that can be connected to one PLC is 16.

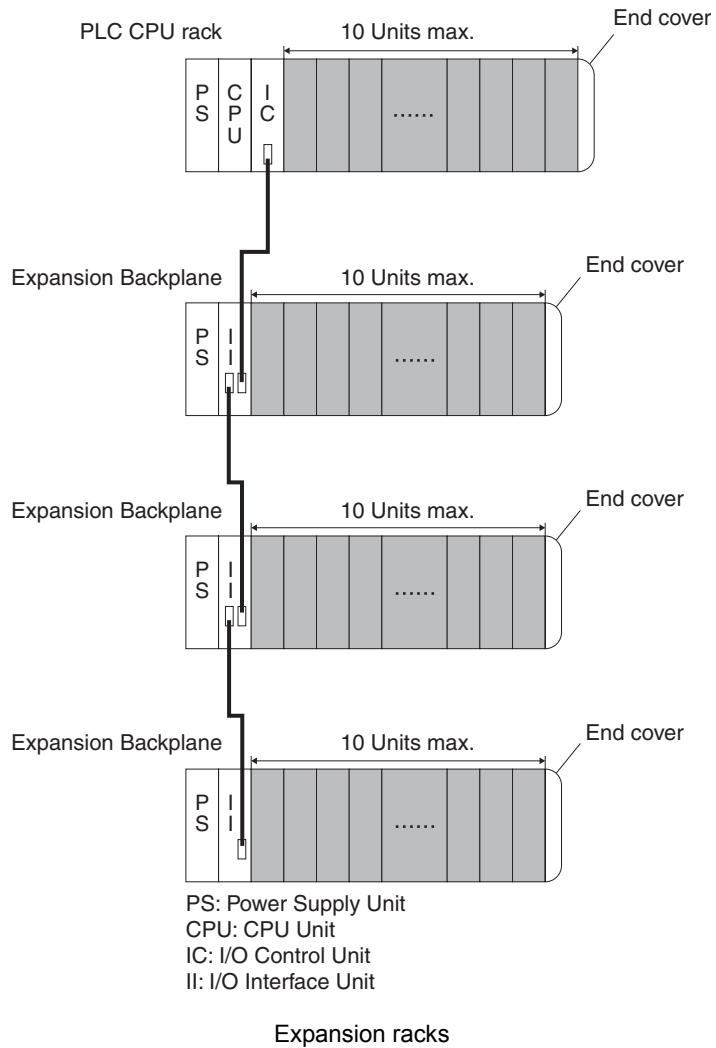

Note The maximum current consumption of the CJ1W-MCH72 is 680 mA. Make sure that the total current consumption of all units connected to the same CPU backplane or expansion backplane is not greater than the output capacity of the Power Supply Unit.

To connect the CJ1W-MCH72 to the PLC, perform the following steps:

- 1 Align the connectors of the units.

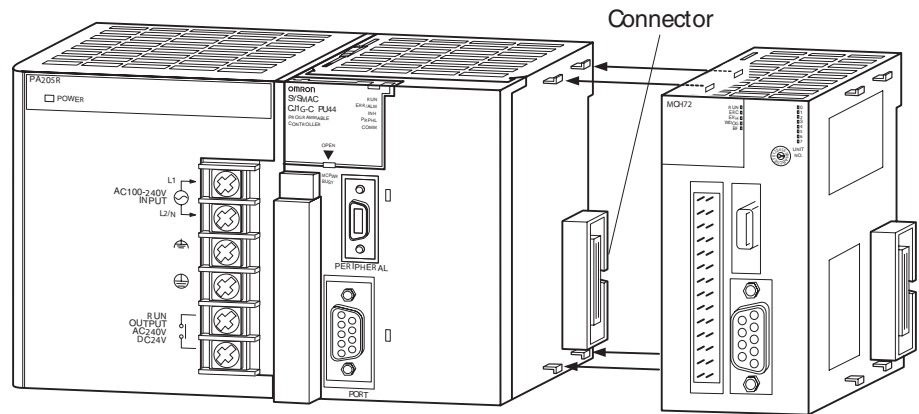

CJ1W-MCH72 hardware installation

- 2 Move the yellow sliders at the top and bottom of the unit to the front.
- 3 Attach the CJ1W-MCH72 to the PLC.
- 4 Push the yellow sliders at the top and bottom of the unit to the rear to lock them.

Note If the sliders are not properly locked, it is possible that the unit does not operate correctly.

Note Communication errors can occur in the Encoder Interface when Contact Output Units are installed close to the CJ1W-MCH72. This is caused by noise generated by the Contact Outputs.

If Contact Output Units and a CJ1W-MCH72 are installed on the same rack and communication errors occur, do one of the following:

- Install the Contact Output Units at maximum distance from the CJ1W-MCH72.
- Use surge absorbers for the Contact Outputs.

2-3-2 Setup

After the installation of the unit in a PLC system, the following initial setup procedure must be executed:

- A unique unit number must be set. Refer to section 2-3-2-1.
- An I/O table must be created in the PLC, to register the unit on the PLC CPU. Refer to section 2-3-2-2.

This initial setup procedure makes sure that the unit can start up properly and can be configured for operation.

2-3-2-1 Setting the unit number

To set the unit number, perform the following steps:

- 1 Turn off the power supply to the PLC system.
- 2 Use a small screwdriver to set the unit number selector switch to the new unit number.

 **Caution** Do not damage the unit number selector switch.

Note The factory setting of the unit number selector switch is 0.
3 Turn on the power supply to the PLC system.

Note The unit reads the unit number during the initialization after a power up. It does not read the unit number after a software reset. Thus, the power must always be turned off before the unit number is set.

Note If the unit number is set for the first time, or if the unit number is changed, an I/O table must be created for the PLC system.

2-3-2-2 Creating an I/O table

The I/O table identifies the units connected to the PLC and allocates I/O to these units. The I/O table is stored in the PLC CPU. It is loaded at start-up.

If the configuration of a unit connected to the PLC is changed, the I/O table must be created again to register the units to the CPU.

To create the I/O table, connect a programming device (such as a programming console or the CX-Programmer software) to the PLC. The following programming console can be used:

- Model number: C2090H-PRO27-E
- Key sheet (required): CS1W-KS001-E
- Recommended cable (required):
 - CS1W-CN224 (2 m)
 - CS1W-CN624 (6 m)

For CX-Programmer, refer to the CX-Programmer User Manual.

Below is given the procedure to create an I/O table with a programming console.

- 1 Attach a key sheet to the programming console.
- 2 Connect the programming console to the peripheral port of the CPU. Do not connect it to the RS-232C port.
- 3 Follow the steps on the programming console given in the figure.

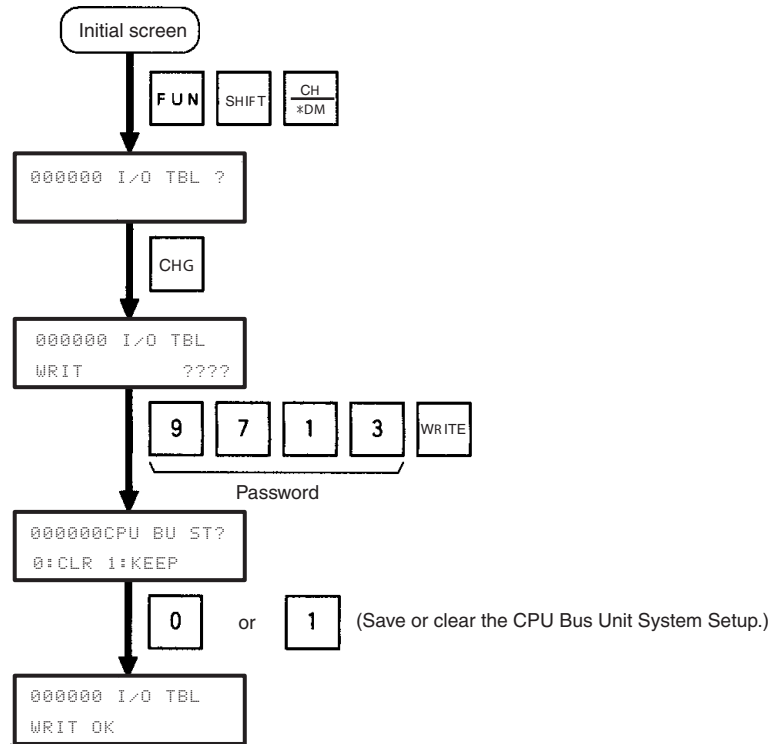

Create I/O table

2-3-3 Connecting MECHATROLINK-II slaves

Note The Trajexia system supports 3 kinds of MECHATROLINK-II slaves: Servo Drivers, Inverters and I/Os. The CJ1W-MCH72 only supports 2 kinds of MECHATROLINK-II slaves: Servo Drivers and Inverters. It does not support I/Os.

To connect MECHATROLINK-II slaves, use a MECHATROLINK-II cable for W-series with ring core and USB connector on both ends. These cables are not included.

The table below lists the MECHATROLINK-II cables.

OMRON model	Yaskawa model	Cable length
FNY-W6003-A5	JEPMC-W6003-A5	0.5 m
FNY-W6003-01	JEPMC-W6003-01	1 m
FNY-W6003-03	JEPMC-W6003-03	3 m
FNY-W6003-05	JEPMC-W6003-05	5 m
FNY-W6003-10	JEPMC-W6003-10	10 m
FNY-W6003-20	JEPMC-W6003-20	20 m
FNY-W6003-30	JEPMC-W6003-30	30 m

To terminate the MECHATROLINK-II slaves, connect an OMRON FNY-W6022 terminator or a Yaskawa JEPMC-W6022 terminator to the MECHATROLINK-II connector of the last MECHATROLINK-II slave.

When the MECHATROLINK-II slaves are connected up to 16 nodes (within 30 m) or up to 15 nodes (within 50 m), no repeater unit is required. For more nodes or longer distances, a repeater unit is required. You can use the OMRON FNY-REP2000 repeater or the Yaskawa JEPMC-REP2000 repeater.

Note For more details, refer to the Yaskawa Sigma-II Series SGDH MECHATROLINK-II Application Module User Manual for model JUSP-NS115 (manual number SIEPC71080001).

MECHATROLINK-II slaves can have a station address that ranges from 41 hex to 5F hex. These station addresses correspond to axis numbers 0 to 29.

2-4 Specifications

2-4-1 Unit dimensions

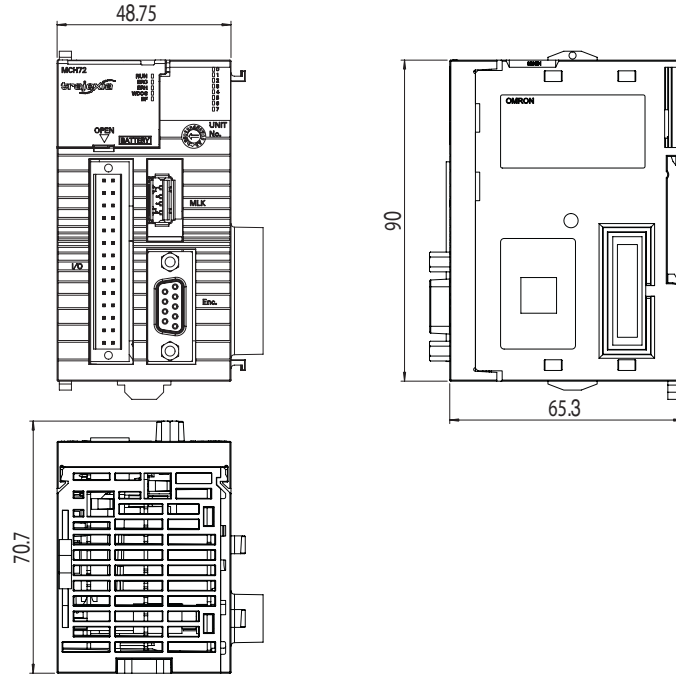

Dimensions of the CJ1W-MCH72

2-4-2 Unit specifications

Item	Specification
Ambient operating temperature	0°C to 55°C When all digital inputs are on: max. 45°C When max. 8 digital inputs are on: max. 55°C
Ambient storage temperature	-20°C to 70°C
Ambient operating humidity	10% to 90%RH
Ambient storage humidity	90% max. (without condensation)
Atmosphere	No corrosive gases
Vibration resistance	10 to 57 Hz (0.075 mm amplitude) 57 to 100 Hz (Acceleration: 9,8 m/s ² , in X, Y and Z directions for 80 minutes)
Shock resistance	143 m/s ² , 3 times each, X, Y and Z directions
Insulation resistance	20 MΩ
Dielectric strength	500 V
Protective structure	IP20
International standards	CE, EN61131-2, RoHS compliant
Power supply	5 V (Supplied via PLC bus)
Current consumption	450 mA max. without external load 680 mA max. with maximum external load

Item	Specification
Maximum current ratings Encoder Interface 5 V output	Incremental: 150 mA SSI: 100 mA EnDat: 80 mA Stepper: 80 mA
Weight	180 gr

2-4-3 System specifications

Item	Specification
Number of axes	32
Number of inverters	Max. 8
Cycle time	Selectable: 0.5 ms, 1 ms, 2 ms, 4 ms
Programming language	BASIC-like motion language
Multi-tasking	Max. 14 tasks running simultaneously
Built-in digital I/O	16 Inputs, 2 with registration functionality 8 Outputs, 1 with hardware position switch functionality
Measurement units	User-definable
Available memory for user programs	756 - 1006 KB ¹
Data storage capacity	RAM memory: 1024 KB minus the size of the user programs VR memory: 4 KB
Saving program data (unit)	SRAM with battery backup and Flash-ROM
Saving program data (PC)	Trajexia Studio manages a backup on the hard disk of the PC
Firmware update	Via Trajexia Studio

1. The available memory for user programs depends on the size of the Table memory, which is minimum 0 KB and maximum 250 KB.

2-4-4 MECHATROLINK-II specifications

Item	Specification
Electrical characteristics	Conforms to the MECHATROLINK standard
Communication ports	1 MECHATROLINK-II master port
Transmission speed	10 Mbps
Communication cycle	0.5 ms, 1 ms, 2 ms, 4 ms
Slave types	Servo Drivers Frequency Inverters
Number of slaves per master (Cycle time)	Max. 30 slaves (4 ms) Max. 16 slaves (2 ms) Max. 8 slaves (1 ms) Max. 4 slaves (0.5 ms)
Transmission distance	Max. 50 m

2-4-5 Encoder interface specifications

Item	Specification
Number of axes	1
Electrical characteristics	EIA RS-422-A Standards (line-driver)
Control method	Pulse Train output (open loop only)
Encoder position/speed feedback	Incremental and absolute
Absolute encoder standards supported	SSI 200 kHz EnDat 1 MHz
Encoder input maximum edge rate	6 M-edges/s
Encoder/pulse output maximum edge rate	2 M-edges/s
Maximum cable length	SSI 100 m max. EnDat 40 m max. Encoder input 100 m max. Encoder/stepper output 100 m max.

SECTION 3

Data exchange

3-1 Introduction

The CJ1W-MCH72 can exchange data with memory areas in the PLC. This enables the CJ1W-MCH72 to use the inputs and outputs connected to the PLC. Also, programs in the CJ1W-MCH72 and PLC programs can exchange control and status data.

Because the CJ1W-MCH72 can only access the input and output data via the PLC, the data exchange requires an extra PLC cycle.

This section describes the issues related to cyclic data exchange.

3-2 Memory areas

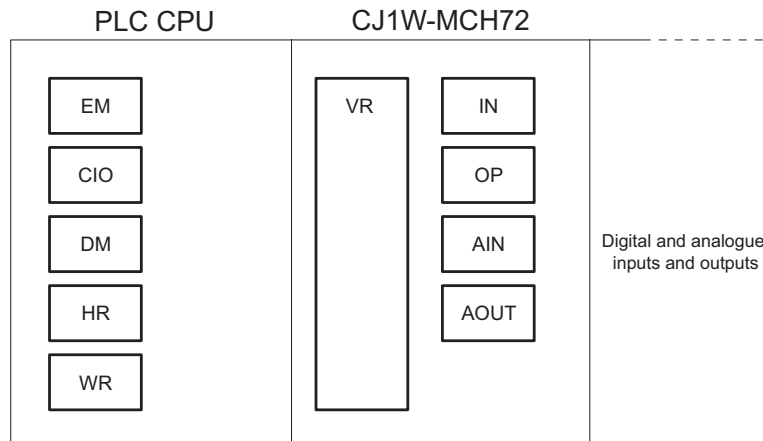

Data exchange memory areas

The PLC CPU uses the following memory areas for data exchange with the CJ1W-MCH72:

- EM (Expanded Memory)
- CIO (Common I/O memory)
- DM (Data Memory)
- WR memory
- HR memory

The CJ1W-MCH72 uses the following memory areas to exchange data with the PLC CPU:

- VR memory
- IN array (for digital inputs)
- OP array (for digital outputs)
- AIN array (for analogue inputs)
- AOOUT array (for analogue outputs)
- Axis Status array (see section 3-3-2-1)

The mapping of memory areas for cyclic data exchange in the PLC CPU to memory areas in the CJ1W-MCH72 can be freely configured. This can be done in the PLC program or in the CJ1W-MCH72. It is recommended to configure the memory mapping either in the startup program of the PLC or in the startup program of the CJ1W-MCH72.

The memory mapping is not stored permanently and will be lost after a restart of the CJ1W-MCH72 or a power cycle of the PLC system.

It is possible to configure the mapping of memory areas both in the PLC program and in the CJ1W-MCH72. This is not practical, because the last configuration overwrites the first.

Note Data exchange with the Table memory of the CJ1W-MCH72 is not possible. However, with the FINS Write command you can write the Table memory of the CJ1W-MCH72.

3-2-1 Configuration of memory areas in the PLC program

To configure the memory areas for cyclic data exchange in the PLC, you must use the FINS Parameter Area Write command. For more information on this FINS command, refer to section 3-4-4.

3-2-2 Configuration of memory areas in the CJ1W-MCH72

To configure the memory areas for cyclic data exchange in the CJ1W-MCH72, you must use the **PLC_EXCHANGE** BASIC command. For more information on this BASIC command, refer to section 4-2-184.

3-3 Data

Two types of data are exchanged during a data exchange:

- Control and status data
- Configurable data

3-3-1 Control and status data

The CJ1W-MCH72 has 13 control and status words.

The control and status data is in the PLC CIO memory at word location n , where n is equal to $1500 + 25 \times \text{unit_number}$.

3-3-1-1 Control data

The PLC program can directly control the CJ1W-MCH72 with control word n . It can execute the following functions:

Word	Bit	Description	Value	Function
n	0	Enable execution	0	No BASIC programs can be executed
			0	Allow BASIC programs to be executed
			1 to 0	Stop BASIC programs, switches off the axes watchdog, stop all movement, clear movement buffers and clear the digital outputs.
			0 to 1	Executes the programs that are configured to run at power-up
	1	Enable watchdog	0	Forces the watchdog to be off
			1	Enables BASIC programs to control the axes watchdog
			1 to 0	Switches off the axes watchdog, stop all movement and clear movement buffers
			0 to 1	Clear movement buffers
	2	Deceleration stop	0 to 1	Stop BASIC programs and start deceleration (RAPIDSTOP)
	3	Enable outputs	0	Forces digital outputs to be OFF
			1	Digital outputs reflect the state of OP(8..15)
	4-15	Reserved	0	-

- Note**
- Setting bit 2 to 0 has no function.

3-3-1-2 Status data

Status words $n+1$ and $n+2$ return the status of the CJ1W-MCH72. The table below lists the layout of these status words.

Word	Bit	Description	Value	Function
$n+1$	0	Unit operational	0	Unit not operational
			1	Unit operational
	1	Watchdog on	0	Axes watchdog off
			1	Axes watchdog on
	2..7	N/A	Always 0	
	8	Program execution enabled		Feedback of word n , bit 0
	9	Axes watchdog enabled		Feedback of word n , bit 1
	10	Deceleration active		Feedback of word n , bit 2
	11	Outputs enabled		Feedback of word n , bit 3
12..15	N/A	Always 0		
$n+2$	0	MECHATROLINK-II error	0	No MECHATROLINK-II error
			1	Error on MECHATROLINK-II bus
	1	Axes error	0	No axes error
			1	Axes error (See control and status words $n+7$ and $n+8$)
	2	BASIC error	0	No BASIC error
			1	BASIC error for a running process
	3	Battery error	0	Battery OK
			1	Battery low or empty
4..15	N/A	Always 0		

Status words $n+3$.. $n+13$ return the status of the axes and processes of the CJ1W-MCH72.

Word	Bit	Description
$n+3$	0..15	Servo On flags for axes 0..15
$n+4$	0..15	Servo On flags for axes 16..31
$n+5$	0..15	Axis Enable flags for axes 0..15
$n+6$	0..15	Axis Enable flags for axes 16..31
$n+7$	0..15	Axis Error flags for axes 0..15
$n+8$	0..15	Axis Error flags for axes 16..31
$n+9$	0..15	Axis In Commissioning Mode flags for axes 0..15
$n+10$	0..15	Axis In Commissioning Mode flags for axes 16..31
$n+11$	0..13	Process Running flags for processes 1..14
	14,15	Always 0

Word	Bit	Description
n+12	0..13	Process Error flags for processes 1..14
	14,15	Always 0
n+13	0..7	Configurable data block transfer error Each bit corresponds to a block transferred from PLC CPU to CJW-MCH72. A bit being on indicates a transfer error. See 3-3-2.
	8..15	Configurable data block transfer error Each bit corresponds to a block transferred from CJW-MCH72 to PLC CPU. A bit being on indicates a transfer error. See 3-3-2.

3-3-2 Configurable data

The amount of configurable data that is exchanged between the PLC CPU and the CJ1W-MCH72 each PLC cycle is 8 blocks from the PLC CPU to the CJ1W-MCH72 and 8 blocks vice versa. Thus, 16 blocks of data are exchanged in one PLC cycle. A block is a continuous memory area or array area. The total size of all 16 blocks must be less than or equal to 2000 words. The configurable data can be exchanged between the VR, IN, OP, AIN, AOUT and Axis Status memory areas of the CJ1W-MCH72 and the CIO, DM and EM memory areas of the PLC CPU.

Because the PLC CPU and the CJ1W-MCH72 use different numeric formats, the data that is exchanged must be cast. The table below lists the casting of numeric data per memory area.

PLC data format	CJ1W-MCH72	
	Memory area	Data format
32-bit IEEE float	VR	floating point
16-bit word	VR	floating point
	IN	bit array
	OP	bit array
	AIN	floating point
	AOUT	floating point

Digital and analogue inputs and outputs may not be physically present, which makes them virtual and as such they can still be used in cyclic data exchange.

3-3-2-1 Axis Status array

The Axis Status array is a special array that exists of 4 fields. The table below lists the Axis Status fields and the corresponding PLC data type.

Axis Status field	Description	PLC data type
Status	BASIC command AXISSTATUS	16-bit word
Position	Measured position in encoder units (if divided by UNITS axis parameter gives MPOS axis parameter)	32-bit integer
Monitor	BASIC command DRIVE_MONITOR	16-bit word
Drive status	Status of the drive	16-bit word

3-4 FINS commands

FINS (Factory Intelligent Network Services) commands are message service communications commands developed by OMRON for Factory Automation control devices. They do not depend on a particular transmission path, and can be used to:

- Read from and write to the PLC memory or the CJ1W-MCH72 memory.
- Control various operations.

The FINS communications can be issued from a PLC CPU or a host computer, and they can also be sent to any of these. The specific commands that can be sent depend on the destination.

A FINS command is defined by its command code and its response code. A command code is a 2-byte hexadecimal code. FINS commands always begin with a 2-byte command code. The required parameters come after the command code.

The response code is a 2-byte hexadecimal code that indicates the results of the command execution. The first byte provides the main response code (MRES), which classifies the results. The table below lists the MRES codes. The second byte provides the sub-response code (SRES), which contains details about the results.

MRES	Execution result
00	Normal completion
01	Master unit error
02	Slave device error
04	Service not supported
10	Command format error
11	Parameter error
20	Read not possible
22	Status error

Note

If the FINS command was not completed normally, the 2-byte response code is not equal to 0000. Also, the response frame does not contain any additional data. Data can only be returned - depending on the command - when the response code is 0000.

The CJ1W-MCH72 supports the following FINS commands:

- Read (0101)
- Write (0102)
- Parameter Area Read (0201)
- Parameter Area Write (0202)
- Run (0401)
- Stop (0402)

For more information on FINS, refer to the Communication Commands Reference manual (W342-E1).

3-4-1 Read (0101)

The FINS Read command has this format:

01 01	00
command_code	var_type	start_address	fixed	element_count

The parameters can have the following values:

Parameter	Values (hex)
command_code	01 01
var_type	<ul style="list-style-type: none"> 82 (Table memory in 16-bit integer format) C2 (Table memory in 32-bit IEEE floating-point format) B0 (VR memory in 16-bit integer format) F0 (VR memory in 32-bit IEEE floating-point format)
start_address	$0 \leq \text{start_address} \leq \text{memory size} - 1 \leq \text{FFFF}$
element_count	$1 \leq \text{element_count} \leq \text{memory size} - \text{start_address}$

The CJ1W-MCH72 responds with these codes:

Condition	Response code (hex)	Description
All elements valid	0000	OK
var_type invalid	1101	No area type
start_address invalid	1103	Address range designation error
Number of elements invalid	1104	Address out of range

If **var_type** is 82 or B0, and the response code is 0000, the CJ1W-MCH72 responds with:

01 01	00 00			
command_code	response_code	word_1	word_2	...

If **var_type** is C2 or F0, and the response code is 0000, the CJ1W-MCH72 responds with:

01 01	00 00		
command_code	response_code	dword_1	...

Note The returned words and dwords are in big-endian format.

3-4-2 Write (0102)

The FINS Write command has these formats:

- If **var_type** is 82 or B0:

01	02	00
command_code	var_type	start_address	fixed	total_words	word 1	..	

- If **var_type** is C2 or F0:

01	02	00
command_code	var_type	start_address	fixed	total_dwords	dword 1	..	

- If **var_type** is 30:

01	02	30	00
command_code	var_type	start_address	bit_num	total_bits	bit	..	

The parameters can have the following values:

Parameter	Values
command_code	01 02
var_type	<ul style="list-style-type: none"> • 82 (Table memory in 16-bit integer format) • C2 (Table memory in 32-bit IEEE floating-point format) • B0 (VR memory in 16-bit integer format) • F0 (VR memory in 32-bit IEEE floating-point format) • 30 (VR memory in bit format)
start_address	$0 \leq \text{start_address} \leq \text{memory size} - 1 \leq \text{FFFF}$
total_words	$1 \leq \text{total_words} \leq \text{memory size} - \text{start_address} + 1$
total_dwords	$1 \leq \text{total_dwords} \leq \text{memory size} - \text{start_address} + 1$
total_bits	1
bit	00 or 01

The CJ1W-MCH72 responds with these codes:

Condition	Response code (hex)	Description
All elements valid	0000	OK
var_type invalid	1101	No area type
start_address invalid	1103	Address range designation error
bit_number invalid	1103	Address range designation error
Number of elements invalid (totals)	1104	Address out of range

3-4-3 Parameter Area Read (0201)

The FINS Parameter Area Read command reads the memory-mapping configuration that is written with the FINS Parameter Area Write command (see section 3-4-4).

The Parameter Area Read command has this format:

02 01	00 00	00 08
command_code	area_code	start_address	byte_count

The parameters can have the following values:

Parameter	Values (hex)
command_code	02 01
area_code	<ul style="list-style-type: none"> 0100..0107 for PLC output area (8 areas available) 8100..8107 for PLC input area (8 areas available)
start_address	0000
byte_count	0008

The CJ1W-MCH72 responds with these codes:

Condition	Response code (hex)	Description
All elements valid	0000	OK
area_code invalid	1101	No area type
start_address invalid	1103	Address range designation error
byte_count invalid	1104	Address out of range
area_code not configured	2003	The registered table does not exist

If the response code is 0000, the CJ1W-MCH72 responds with the data configured previously:

02 01	00 00	00 00	00 08
command_code	response_code	area_code	start_address	byte_count	plc_area	plc_start	tj_area	tj_start	total_items

Refer to section 3-4-4 for more information on the fields **plc_area**, **plc_start**, **tj_area**, **tj_start** and **total_items**.

3-4-4 Parameter Area Write (0202)

The FINS Parameter Area Write command sets the memory-mapping configuration. It has this format:

02 02	00 00	00 00	00 08
command_code	response_code	area_code	start_address	byte_count	plc_area	plc_start	tj_area	tj_start	total_items

The parameters can have the following values:

Parameter	Values (hex)
command_code	02 02

Parameter	Values (hex)
area_code	<ul style="list-style-type: none"> • 0100..0107 for PLC output area (8 areas available) • 8100..8107 for PLC input area (8 areas available)
start_address	0000
byte_count	0008
plc_area	<ul style="list-style-type: none"> • 01 (CIO) • 03 (DM) • 04 (WR) • 05 (HR) • 08..14 (EM bank 0..C)
plc_start	Start address in PLC memory (Validity depends on plc_area)
tj_area	<ul style="list-style-type: none"> • 00 (VR 16-bit signed integer) • 01 (VR 32-bit floating point) • 02 (IN or OP array, depending on direction) • 03 (AIN or AOUT array, depending on direction) • 04 (Axis Status array, only valid if direction is PLC input)
tj_start	Start address in CJ1W-MCH72 memory (Validity depends on tj_area)
total_items	Total items (words and dwords) to transfer (Validity depends on plc_area and tj_area)

The CJ1W-MCH72 responds with these codes:

Condition	Response code (hex)	Description
All elements valid	0000	OK
area_code invalid	1101	No area type
start_address invalid	1103	Address range designation error
byte_count invalid	1104	Address out of range
plc_area , plc_start , tj_area or tj_start invalid	110C	Other parameter error
total_items greater than 2000 words	2103	Data has not been registered

If the response code is 0000, the cyclic area number specified in **area_code** is configured to exchange data between the PLC CPU and the CJ1W-MCH72.

Note The first 16 entries in the IN array cannot be addressed in the memory mapping. These first 16 entries map to the inputs available on the I/O connector.

3-4-5 Run (0401)

The FINS Run command starts or stops a BASIC program.

The FINS Run command has these formats:

- To start a BASIC program:

04	01	00	..	01
command_code		process		mode	program_name	

- To stop a BASIC program:

04	01	00	..	00
command_code		process		mode

The parameters can have the following values:

Parameter	Values
mode	<ul style="list-style-type: none"> 00 (Stop) 01 (Start)
process	01..0E (Process number)
program_name	A string that represents the program name (The string does not have zero termination)

The CJ1W-MCH72 responds with these codes:

Condition	Response code (hex)	Description
All elements valid	0000	OK
process invalid	1106	Process number does not exist or invalid mode
mode invalid		
program_name invalid	2402	Program name does not exist
Start BASIC program that is already running	2201	Wrong mode (executing)
Stop BASIC program that is not running	2202	Wrong mode (stopped)

If the response code is 0000, the program is started or stopped.

3-4-6 Stop (0402)

The FINS Stop command stops a BASIC program. It has this format:

04	02	00	..
command_code		process	

The parameters can have the following values:

Parameter	Values
process	01..0E (Process number)

The CJ1W-MCH72 responds with these codes:

Condition	Response code (hex)	Description
All elements valid	0000	OK
process invalid	1106	Process number does not exist
Stop BASIC program that is not running	2202	Wrong mode (stopped)

Note The FINS Stop command (0402) is equal to the FINS Run command (0401) where **mode** is equal to 00.

3-4-7 Error Data Read (2110)

The FINS Error Data Read command reads the error data (error line and error code) of a process. It has this format:

21	10	00	..
command_code		process	

The parameters can have the following values:

Parameter	Values
process	01..0E (Process number)

The CJ1W-MCH72 responds with these codes:

Condition	Response code (hex)	Description
All elements valid	0000	OK

If the response code is 0000, the CJ1W-MCH72 responds with the error data:

21	01	00	00
command_code		response_code		error_line		error_code	

error_line is equal to the return value of the BASIC command **ERROR_LINE PROC(process)**.

error_code is equal to the return value of the BASIC command **RUN_ERROR PROC(process)**.

SECTION 4 BASIC commands

4-1 Categories

This section lists all BASIC commands divided by categories. The categories are:

- Axis commands.
- Axis parameters.
- Communication commands and parameters.
- Constants.
- I/O commands, functions and parameters.
- Mathematical functions and operations.
- Program commands.
- Program control commands.
- Slot parameters and modifiers.
- System commands and functions.
- System parameters.
- Task commands and parameters.

The lists are quick reference guides only. A complete description of the commands is given in alphabetical order in the next section.

4-1-1 Axis commands

Name	Description
ACC	Changes the ACCEL and DECEL at the same time.
ADD_DAC	Sum to the S_REF value of one axis to the analogue output of the base axis.
ADDAX	Sets a link to a superimposed axis. All demand position movements for the superimposed axis will be added to any moves that are currently being executed.
B_SPLINE	Expands the profile stored in TABLE memory using the B-Spline mathematical function.
BACKLASH	Allows the backlash compensation to be loaded.
BASE	Used to set the base axis to which the commands and parameters are applied.
CAM	Moves an axis according to values of a movement profile stored in the TABLE variable array.
CAMBOX	Moves an axis according to values of a movement profile stored in the TABLE variable array. The motion is linked to the measured motion of another axis to form a continuously variable software gearbox.
CANCEL	Cancels the move on an axis.
CONNECT	Connects the demand position of an axis to the measured movements of the axis specified for driving_axis to produce an electronic gearbox.
DATUM	Performs one of 7 origin search sequences to position an axis to an absolute position or reset a motion error.
DEFPOS	Defines the current position as a new absolute position.

Name	Description
DISABLE_GROUP	Groups axes together for error disabling.
DRIVE_ALARM	Monitors the current alarm.
DRIVE_CLEAR	Clears the alarm status of the Servo Driver.
DRIVE_READ	Reads the specified parameter of the Servo Driver.
DRIVE_RESET	Resets the Servo Driver.
DRIVE_WRITE	Writes a specific value to the specified parameter of the Servo Driver.
ENCODER_READ	Reads a parameter of the EnDat absolute encoder.
ENCODER_WRITE	Writes to a parameter of the EnDat absolute encoder.
FORWARD	Moves an axis continuously forward at the speed set in the SPEED parameter.
HW_PSWITCH	Sets on and off the hardware switch on output 0 of the Encoder Interface when predefined positions are reached.
MECHATROLINK	Initializes MECHATROLINK-II bus and performs various operations on MECHATROLINK-II stations connected to the bus.
MHELICAL	Interpolates 3 orthogonal axes in a helical move.
MOVE	Moves one or more axes at the demand speed, acceleration and deceleration to the position specified as increment from the current position.
MOVEABS	Moves one or more axes at the demand speed, acceleration and deceleration to the position specified as absolute position.
MOVECIRC	Interpolates 2 orthogonal axes in a circular arc.
MOVELINK	Creates a linear move on the base axis linked via a software gearbox to the measured position of a link axis.
MOVEMODIFY	Changes the absolute end position of the current single-axis linear move (MOVE or MOVEABS).
RAPIDSTOP	Cancels the current move on all axes.
REGIST	Captures an axis position when a registration input or the Z mark on the encoder is detected.
REVERSE	Moves an axis continuously in reverse at the speed set in the SPEED parameter.
STEP_RATIO	Sets the ratio for the axis stepper output.

4-1-2 Axis parameters

Name	Description
ACCEL	Contains the axis acceleration rate.
ADDAX_AXIS	Contains the number of the axis to which the base axis is currently linked to by ADDAX .
ATYPE	Contains the axis type.
AXIS_ENABLE	Enables and disables particular axis independently of other axis.

Name	Description
AXISSTATUS	Contains the axis status.
BACKLASH_DIST	Defines the amount of backlash compensation.
CLOSE_WIN	Defines the end of the window in which a registration mark is expected.
CLUTCH_RATE	Defines the change in connection ratio when using the CONNECT command.
CREEP	Contains the creep speed.
D_GAIN	Contains the derivative control gain.
DATUM_IN	Contains the input number to be used as the origin input.
DECEL	Contains the axis deceleration rate.
DEMAND_EDGES	Contains the current value of the DPOS axis parameter in encoder edges.
DPOS	Contains the demand position generated by the move commands.
DRIVE_CONTROL	Selects data to be monitored using DRIVE_MONITOR for axes connected via the MECHATROLINK-II bus. For axes connected via the Encoder Interface, DRIVE_CONTROL sets outputs of the Encoder Interface.
DRIVE_INPUTS	Holds I/O data of the driver connected to MECHATROLINK-II bus. Data is updated every servo cycle.
DRIVE_MONITOR	Monitors data of the Servo Driver connected to MECHATROLINK-II bus. Data are updated every servo cycle.
DRIVE_STATUS	Contains the current status of the Servo Driver.
ENCODER	Contains a raw copy of the encoder hardware register.
ENCODER_BITS	Sets the number of bits for the absolute encoder connected to the Encoder Interface.
ENCODER_CONTROL	Controls operating mode of the EnDat absolute encoder.
ENCODER_RATIO	Sets scaling value for incoming encoder counts.
ENCODER_TURNS	Returns the multi-turn count of the absolute encoder.
ENDMOVE	Holds the position of the end of the current move.
ERRORMASK	Contains the mask value that determines if MOTION_ERROR occurs depending on the axis status.
FAST_JOG	Contains the input number to be used as the fast jog input.
FASTDEC	Defines ramp to zero deceleration ratio when an axis limit switch or position is reached.
FE	Contains the Following Error.
FE_LATCH	Contains the FE value which caused the axis to put controller in MOTION_ERROR state.
FE_LIMIT	Contains the maximum allowable Following Error.
FE_LIMIT_MODE	Defines how FE influences MOTION_ERROR state.
FE_RANGE	Contains the Following Error warning range limit.
FHOLD_IN	Contains the input number to be used as the feedhold input.

Name	Description
FHSPEED	Contains the feedhold speed.
FS_LIMIT	Contains the absolute position of the forward software limit.
FWD_IN	Contains the input number to be used as a forward limit input.
FWD_JOG	Contains the input number to be used as a jog forward input.
I_GAIN	Contains the integral control gain.
INVERT_STEP	Switches a hardware Inverter into the stepper output circuit.
JOGSPEED	Sets the jog speed.
LINKAX	Contains the axis number of the link axis during any linked move.
MARK	Detects the primary registration event on a registration input.
MARKB	Detects the secondary registration event on a registration input.
MERGE	Is a software switch that can be used to enable or disable the merging of consecutive moves.
MPOS	Is the position of the axis as measured by the encoder.
MSPEED	Represents the change in the measured position in the last servo period.
MTYPE	Contains the type of move currently being executed.
NTYPE	Contains the type of the move in the Next Move buffer.
OFFPOS	Contains an offset that will be applied to the demand position without affecting the move in any other way.
OPEN_WIN	Defines the beginning of the window in which a registration mark is expected.
OUTLIMIT	Contains the limit that restricts the speed reference output from the CJ1W-MCH72.
OV_GAIN	Contains the output velocity control gain.
P_GAIN	Contains the proportional control gain.
REG_POS	Contains the position at which a registration event occurred.
REG_POSB	Contains the position at which the secondary registration event occurred.
REMAIN	Is the distance remaining to the end of the current move.
REMOTE_ERROR	Returns number of errors on MECHATROLINK-II connection of the Servo Driver.
REP_DIST	Contains or sets the repeat distance.
REP_OPTION	Controls the application of the REP_DIST axis parameter.
REV_IN	Contains the input number to be used as a reverse limit input.

Name	Description
REV_JOG	Contains the input number to be used as a jog reverse input.
RS_LIMIT	Contains the absolute position of the reverse software limit.
S_REF	Contains the speed reference value which is applied when the axis is in open loop.
S_REF_OUT	Contains the speed reference value being applied to the Servo Driver for both open as closed loop.
SERVO	Determines whether the axis runs under servo control or open loop.
SPEED	Contains the demand speed in units/s.
SPEED_SIGN	Configures the voltage range of the analogue speed reference output of the Encoder Interface.
SRAMP	Contains the S-curve factor.
T_REF	Contains the torque reference value which is applied to the servo motor.
TRANS_DPOS	Contains axis demand position at output of frame transformation.
UNITS	Contains the unit conversion factor.
VERIFY	Selects different modes of operation on a stepper output axis.
VFF_GAIN	Contains the speed feed forward control gain.
VP_SPEED	Contains the speed profile speed.

4-1-3 Communication commands and parameters

Name	Description
FINS_COMMS	Sends FINS Read Memory and Write Memory to a designated FINS server unit.

4-1-4 Constants

Name	Description
FALSE	Equal to the numerical value 0.
OFF	Equal to the numerical value 0.
ON	Equal to the numerical value 1.
PI	Equal to the numerical value 3.1416.
TRUE	Equal to the numerical value -1.

4-1-5 I/O commands, functions and parameters

Name	Description
AIN	Holds the value of the analogue channel.
AOUT	Holds the value of the analogue channel.
GET	Waits for the arrival of a single character and assigns the ASCII code of the character to variable.
IN	Returns the value of digital inputs.
OP	Sets one or more outputs or returns the state of the first 24 outputs.
PRINT	Outputs a series of characters to a serial port.
PSWITCH	Turns on an output when a predefined position is reached, and turns off the output when a second position is reached.
READ_OP	Returns the value of the digital outputs.

4-1-6 Mathematical functions and operands

Name	Description
+ (ADDITION)	Adds two expressions.
- (SUBTRACTION)	Subtracts two expressions.
* (MULTIPLICATION)	Multiplies two expressions.
/ (DIVISION)	Divides two expressions.
^ (POWER)	Takes the power of one expression to the other expression.
= (IS EQUAL TO)	Checks two expressions to see if they are equal.
= (ASSIGNMENT)	Assigns an expression to a variable.
<> (IS NOT EQUAL TO)	Checks two expressions to see if they are different.
> (IS GREATER THAN)	Checks two expressions to see if the expression on the left is greater than the expression on the right.
>= (IS GREATER THAN OR EQUAL TO)	Checks two expressions to see if the expression on the left is greater than or equal to the expression on the right.
< (IS LESS THAN)	Checks two expressions to see if the expression on the left is less than the expression on the right.
<= (IS LESS THAN OR EQUAL TO)	Checks two expressions to see if the expression on the left is less than or equal to the expression on the right.
ABS	Returns the absolute value of an expression.
ACOS	Returns the arc-cosine of an expression.
AND	Performs an AND operation on corresponding bits of the integer parts of two expressions.
ASIN	Returns the arc-sine of an expression.
ATAN	Returns the arc-tangent of an expression.
ATAN2	Returns the arc-tangent of the non-zero complex number made by two expressions.

Name	Description
COS	Returns the cosine of an expression.
EXP	Returns the exponential value of an expression.
FRAC	Returns the fractional part of an expression.
IEEE_IN	Returns floating point number in IEEE format, represented by 4 bytes.
IEEE_OUT	Returns single byte extracted from the floating point number in IEEE format.
INT	Returns the integer part of an expression.
LN	Returns the natural logarithm of an expression.
MOD	Returns the modulus of two expressions.
NOT	Performs a NOT operation on corresponding bits of the integer part of the expression.
OR	Performs an OR operation between corresponding bits of the integer parts of two expressions.
SGN	Returns the sign of an expression.
SIN	Returns the sine of an expression.
SQR	Returns the square root of an expression.
TAN	Returns the tangent of an expression.
XOR	Performs an XOR function between corresponding bits of the integer parts of two expressions.

4-1-7 Program commands

Name	Description
' (COMMENT FIELD)	Enables a line not to be executed.
: (STATEMENT SEPARATOR)	Enables more statements on one line.
AUTORUN	Starts all the programs that have been set to run at start-up.
COMPILE	Compiles the current program.
COPY	Copies an existing program in the motion controller to a new program.
DEL	Deletes a program from the motion controller.
DIR	Displays a list of the programs in the motion controller, their size and their RUNTYPE on the standard output.
EDIT	Allows a program to be modified using a VT100 Terminal.
EPROM	Stores a program in the flash memory.
LIST	Prints the program on the standard output.
NEW	Deletes all lines of the program in the motion controller.
PROCESS	Returns the running status and task number for each current task.

Name	Description
RENAME	Changes the name of a program in the motion controller.
RUN	Executes a program.
RUNTYPE	Determines if a program is run at start-up, and which task it is to run on.
SELECT	Specifies the current program.
STEPLINE	Executes a single line in a program.
STOP	Halts program execution.
TROFF	Suspends a trace at the current line and resumes normal program execution.
TRON	Creates a breakpoint in a program.

4-1-8 Program control commands

Name	Description
FOR..TO..STEP..NEXT	Loop allows a program segment to be repeated with increasing/decreasing variable.
GOSUB..RETURN	Jumps to a subroutine at the line just after label. The program execution returns to the next instruction after a "RETURN" on page 235 is given.
GOTO	Jumps to the line containing the label.
IF..THEN..ELSE..ENDIF	Controls the flow of the program base on the results of the condition.
ON.. GOSUB or ON.. GOTO	Enables a conditional jump to one of several labels.
REPEAT..UNTIL	Loop allows the program segment to be repeated until the condition becomes "TRUE" on page 257.
WHILE..WEND	Loop allows the program segment to be repeated until the condition becomes FALSE .

4-1-9 Slot parameters and modifiers

Name	Description
ALL	Is a modifier that specifies that all items in the controller are concerned.
FPGA_VERSION	Returns the FPGA version.

4-1-10 System commands and functions

Name	Description
\$ (HEXADECIMAL INPUT)	Assigns a hexadecimal number to a variable.
AXIS	Sets the axis for a command, axis parameter read, or assignment to a particular axis.
BASICERROR	Is used to run a specific routine when an error occurs in a BASIC command.
CLEAR	Clears all global variables and the local variables on the current task.
CLEAR_BIT	Clears the specified bit of the specified VR variable.
CLEAR_PARAMS	Clears all parameter sand variables stored in flash EPROM to their default values.
CONSTANT	Declares a constant for use in BASIC program.
DATE\$	Prints the current date as a string.
EX	Resets the controller.
FLAG	Sets and reads a bank of 32 bits.
FLAGS	Read and sets FLAGS as a block.
FLASHVR	Stores TABLE variable data in the flash memory.
FREE	Returns the amount of available memory.
GLOBAL	Declares a reference to one of VR variables.
HALT	Stops execution of all programs currently running.
INITIALISE	Sets all axes and parameters to their default values.
INTEGER_READ	Splits a 32 bit variable in 2 16 bit values and copies these values to 2 other variables.
INVERT_IN	Inverts input channels 0 - 31 in the software.
INVERTER_COMMAND	Reads I/O and clears alarm of the Inverter.
INVERTER_READ	Reads parameter, alarm, speed and torque reference of the Inverter.
INVERTER_WRITE	Writes to parameter, speed and torque reference of the Inverter.
LIST_GLOBAL	Shows all GLOBAL and CONSTANT variables.
LOCK	Prevents the programs from being viewed or modified.
PLC_EXCHANGE	Reads or sets the mapping of PLC memory to CJ1W-MCH72 memory.
READ_BIT	Returns the value of the specified bit in the specified VR variable.
RESET	Resets all local variables on a task.
SCOPE	Programs the system to automatically store up to 4 parameters every sample period to the TABLE variable array.
SET_BIT	Sets the specified bit in the specified VR variable to one.

Name	Description
TABLE	Writes and reads data to and from the TABLE variable array.
TABLEVALUES	Returns list of values from the TABLE memory.
TIME\$	Prints the current time as a string.
TRIGGER	Starts a previously set SCOPE command.
VR	Writes and reads data to and from the global (VR) variables.
VRSTRING	Combines VR memory values so they can be printed as a string.
WA	Holds program execution for the number of milliseconds specified.
WAIT IDLE	Suspends program execution until the base axis has finished executing its current move and any buffered move.
WAIT LOADED	Suspends program execution until the base axis has no moves buffered ahead other than the currently executing move.
WAIT UNTIL	Repeatedly evaluates the condition until it is TRUE .

4-1-11 System parameters

Name	Description
BATTERY_LOW	Returns the current status of the battery condition.
CHECKSUM	Contains the checksum for the programs in RAM.
CONTROL	Contains the type of controller in the system.
D_ZONE_MAX	Controls the S_REF output in conjunction with the Following Error value.
D_ZONE_MIN	Controls the S_REF output in conjunction with the Following Error value.
DATE	Sets or returns the current date held by the real time clock.
ERROR_AXIS	Contains the number of the axis which caused the motion error.
FRAME	Specifies operating frame for frame transformations.
LAST_AXIS	Contains the number of the last axis processed by the system.
MOTION_ERROR	Contains an error flag for axis motion errors.
NEG_OFFSET	Applies a negative offset to the S_REF signal from the servo loop.
PLC_STATUS	Contains the PLC status.
POWER_UP	Determines whether programs should be read from flash EPROM on power up or reset.
POS_OFFSET	Applies a positive offset to the S_REF signal from the servo loop.

Name	Description
SCOPE_POS	Contains the current TABLE position at which the SCOPE command is currently storing its first parameter.
SERVO_PERIOD	Sets the servo cycle period of the CJ1W-MCH72.
SYSTEM_ERROR	Contains the system errors since the last initialization.
TIME	Returns the current time held by the real time clock.
TSIZE	Returns the size of the currently defined Table.
VERSION	Returns the version number of the controller firmware.
WDOG	The software switch that enables Servo Drivers.

4-1-12 Task commands and parameters

Name	Description
ERROR_LINE	Contains the number of the line which caused the last BASIC program error.
PMOVE	Contains the status of the task buffers.
PROC	Lets a process parameter from a particular process to be accessed.
PROC_STATUS	Returns the status of the process specified.
PROCNUMBER	Contains the number of the task in which the currently selected program is running.
RUN_ERROR	Contains the number of the last BASIC error that occurred on the specified task.
TICKS	Contains the current count of the task clock pulses.

4-2 All BASIC commands

4-2-1 + (Addition)

Type	Mathematical function
Syntax	expression1 + expression2
Description	The operator + adds two expressions.
Arguments	<ul style="list-style-type: none">• expression1 Any valid BASIC expression.• expression2 Any valid BASIC expression.
Example	result = 4 + 3 Assigns the value 7 to the variable result .
See also	N/A

4-2-2 - (Subtraction)

Type	Mathematical function
Syntax	expression1 - expression2
Description	The operator - subtracts expression2 from expression1 .
Arguments	<ul style="list-style-type: none">• expression1 Any valid BASIC expression.• expression2 Any valid BASIC expression.
Example	result = 10 - 2 Assigns the value 8 to the variable result .
See also	N/A

4-2-3 * (Multiplication)

Type	Mathematical function
Syntax	expression1 * expression2
Description	The operator * multiplies two expressions.
Arguments	<ul style="list-style-type: none">• expression1 Any valid BASIC expression.• expression2 Any valid BASIC expression.
Example	result = 3 * 7 Assigns the value 21 to the variable result .
See also	N/A

4-2-4 / (Division)

Type	Mathematical function
Syntax	expression1 / expression2
Description	The operator / divides expression1 by expression2 .
Arguments	<ul style="list-style-type: none">• expression1 Any valid BASIC expression.• expression2 Any valid BASIC expression.
Example	result = 11 / 4 Assigns the value 2.75 to the variable result .
See also	N/A

4-2-5 ^ (Power)

Type	Mathematical function
Syntax	expression1 ^ expression2
Description	The power operator ^ raises expression1 to the power of expression2 . This operation uses floating point algorithms and may give small deviations for integer calculations.
Arguments	<ul style="list-style-type: none">• expression1 Any valid BASIC expression.• expression2 Any valid BASIC expression.
Example	result = 2^5 Assigns the value 32 to the variable result .
See also	N/A

4-2-6 = (Is equal to)

Type	Mathematical function
Syntax	expression1 = expression2
Description	The operator = returns TRUE if expression1 is equal to expression2 , otherwise it returns FALSE .
Arguments	<ul style="list-style-type: none">• expression1 Any valid BASIC expression.• expression2 Any valid BASIC expression.
Example	IF a = 10 THEN GOTO label1 If variable a contains a value equal to 10, program execution continues at label label1 . Otherwise, program execution continues with the next statement.
See also	N/A

4-2-7 = (Assignment)

Type	Mathematical function
Syntax	variable = expression
Description	The operator = assigns the value of the expression to the variable.
Arguments	<ul style="list-style-type: none">• variable A variable name.• expression Any valid BASIC expression.
Example	var = 18 Assigns the value 18 to the variable var .
See also	N/A

4-2-8 <> (Is not equal to)

Type	Mathematical function
Syntax	expression1 <> expression2
Description	The operator <> returns TRUE if expression1 is not equal to expression2 , otherwise it returns FALSE .
Arguments	<ul style="list-style-type: none">• expression1 Any valid BASIC expression.• expression2 Any valid BASIC expression.
Example	IF a <> 10 THEN GOTO label1 If variable a contains a value not equal to 10, program execution continues at label label1 . Otherwise, program execution continues with the next statement.
See also	N/A

4-2-9 > (Is greater than)

Type	Mathematical function
Syntax	expression1 > expression2
Description	The operator > returns TRUE if expression1 is greater than expression2 , otherwise it returns FALSE .
Arguments	<ul style="list-style-type: none">• expression1 Any valid BASIC expression.• expression2 Any valid BASIC expression.
Example	IF a > 10 THEN GOTO label1 If variable a contains a value greater than 10, program execution continues at label label1 . Otherwise, program execution continues with the next statement.
See also	N/A

4-2-10 >= (Is greater than or equal to)

Type	Mathematical function
Syntax	expression1 >= expression2
Description	The operator >= returns TRUE if expression1 is greater than or equal to expression2 , otherwise it returns FALSE .
Arguments	<ul style="list-style-type: none">• expression1 Any valid BASIC expression.• expression2 Any valid BASIC expression.
Example	IF a >=10 THEN GOTO label1 If variable a contains a value greater than or equal to 10, program execution continues at label label1 . Otherwise, program execution continues with the next statement.
See also	N/A

4-2-11 < (Is less than)

Type	Mathematical function
Syntax	expression1 < expression2
Description	The operator < returns TRUE if expression1 is less than expression2 , otherwise it returns FALSE .
Arguments	<ul style="list-style-type: none">• expression1 Any valid BASIC expression.• expression2 Any valid BASIC expression.
Example	IF a < 10 THEN GOTO label1 If variable a contains a value less than 10, program execution continues at label label1 . Otherwise, program execution continues with the next statement.
See also	N/A

4-2-12 <= (Is less than or equal to)

Type	Mathematical function
Syntax	expression1 <= expression2
Description	The operator <= returns TRUE if expression1 is less than or equal to expression2 , otherwise it returns FALSE .
Arguments	<ul style="list-style-type: none">• expression1 Any valid BASIC expression.• expression2 Any valid BASIC expression.
Example	IF a <= 10 THEN GOTO label1 If variable a contains a value less than or equal to 10, program execution continues at label label1 . Otherwise, program execution continues with the next statement.
See also	N/A

4-2-13 \$ (Hexadecimal input)

Type	System command
Syntax	\$hex_num
Description	The \$ command makes the number that follows a hexadecimal number.
Arguments	<ul style="list-style-type: none"> • hex_num A hexadecimal number (consisting of the characters 0 - 9 and A - F). hex_num ranges from 0 to FFFFFFFF.
Example	<pre>>>TABLE(0, \$F, \$ABCD) >>print TABLE(0), TABLE(1) 15.0000 43981.0000</pre>
See also	HEX (PRINT)

4-2-14 ' (Comment field)

Type	Program command
Syntax	'
Description	' marks all that follows it on a line as comment and not program code. Comment is not executed when the program is run. You can use ' at the beginning of a line or after a valid statement.
Arguments	N/A
Example	<pre>' This line is not printed PRINT "Start"</pre>
See also	N/A

4-2-15 : (Statement separator)

Type	Program command
Syntax	:
Description	The statement separator : separates multiple BASIC statements on one line. You can use it on the command line and in programs.
Arguments	N/A
Example	PRINT "THIS LINE": GET low : PRINT "DOES THREE THINGS"
See also	N/A

4-2-16 #

Type	Special character
Syntax	#
Description	The # symbol is used to specify a communications channel to be used for serial input/output commands. Note: Communications Channels greater than 3 will only be used when running the Trajexia Studio software.
Arguments	N/A
Example	PRINT #5, "Communication port 1"
See also	N/A

4-2-17 ABS

Type	Mathematical function
Syntax	ABS(expression)
Description	The ABS function returns the absolute value of an expression.
Arguments	<ul style="list-style-type: none">• expression Any valid BASIC expression.
Example	IF ABS(A) > 100 THEN PRINT "A is outside range -100 ... 100"
See also	N/A

4-2-18 ACC

Type	Axis command
Syntax	ACC(rate)
Description	Sets the acceleration and deceleration at the same time. This command gives a quick method to set both ACCEL and DECEL . Acceleration and deceleration rates are recommended to be set with the ACCEL and DECEL axis parameters.
Arguments	<ul style="list-style-type: none">• rate The acceleration/deceleration rate in units/s². You can define the units with the UNITS axis parameter.
Example	ACC(100) Sets ACCEL and DECEL to 100 units/s ² .
See also	ACCEL, DECEL, UNITS

4-2-19 ACCEL

Type	Axis parameter
Syntax	ACCEL = expression
Description	The ACCEL axis parameter contains the axis acceleration rate. The rate is set in units/s ² . The parameter can have any positive value including zero.
Arguments	N/A
Example	BASE(0) ACCEL = 100 ' Set acceleration rate PRINT "Acceleration rate: "; ACCEL; " mm/s/s" ACCEL AXIS(2) = 100 ' Sets acceleration rate for axis (2)
See also	ACCEL, DECEL, UNITS

4-2-20 ACOS

Type	Mathematical function
Syntax	ACOS(expression)
Description	The ACOS function returns the arc-cosine of the expression. The expression value must be between -1 and 1. The result in radians is between 0 and PI. Input values outside the range will return 0.
Arguments	• expression Any valid BASIC expression.
Example	>> PRINT ACOS(-1) 3.1416
See also	N/A

4-2-21 ADD_DAC

Type	Axis command
Syntax	ADD_DAC(axis)

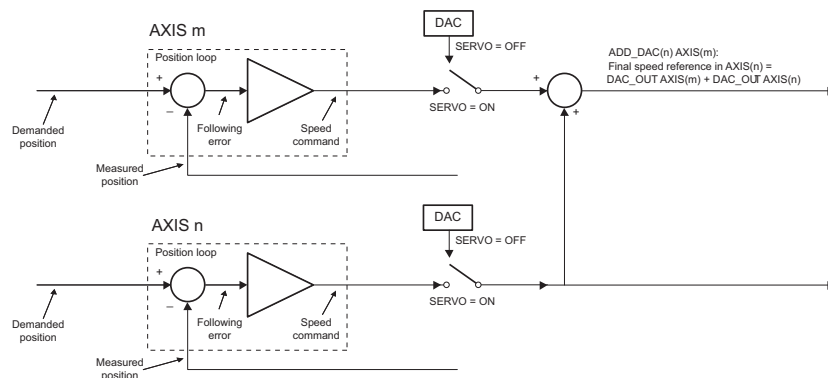

Description	<p>The ADD_DAC command adds the S_REF_OUT value of axis to the S_REF_OUT value of the base axis. Use ADD_DAC(-1) to cancel the sum.</p> <p>ADD_DAC works on the default basis axis (set with BASE) unless AXIS is used to specify a temporary base axis.</p> <p>Note:</p> <ol style="list-style-type: none"> 1 Be aware that the control loop gains for both axes need to be determined with care. As different encoders with different resolutions are used, the gains are not identical. 2 Set the OUTLIMIT parameter to the same value for both linked axes. 3 This command has no meaning for a MECHATROLINK-II axis in position mode (ATYPE=40), because the value of S_REF_OUT is ignored.
Arguments	<ul style="list-style-type: none"> • axis The axis from which to sum the speed reference output to the base axis. Set the argument to -1 to cancel the link and return to normal operation.
Example	No example.
See also	AXIS, S_REF_OUT, OUTLIMIT

4-2-22 ADDAX

Type	Axis command
Syntax	ADDAX(axis)
Description	<p>The ADDAX command is used to superimpose two or more movements to build up a more complex movement profile.</p> <p>The ADDAX command takes the demand position changes from the superimposed axis as specified by the axis argument and adds them to any movement running on the axis to which the command is issued. The axis specified by the parameter can be any axis and does not have to physically exist in the system.</p> <p>The ADDAX command therefore allows an axis to perform the moves specified on two axes added together. When the axis parameter is set to OFF on an axis with an encoder interface the measured position MPOS is copied into the demanded position DPOS. This allows ADDAX to be used to sum encoder inputs.</p> <p>After the ADDAX command has been issued the link between the two axes remains until broken. Use ADDAX(-1) to cancel the axis link. ADDAX allows an axis to perform the moves specified for 2 axes added together. Combinations of more than two axes can be made by applying ADDAX to the superimposed axis as well.</p> <p>ADDAX works on the default basis axis (set with BASE) unless AXIS is used to specify a temporary base axis.</p> <p>Note: The ADDAX command sums the movements in encoder edge units.</p>
Arguments	<ul style="list-style-type: none"> • axis The axis to be set as a superimposed axis. Set the argument to -1 to cancel the link and return to normal operation.

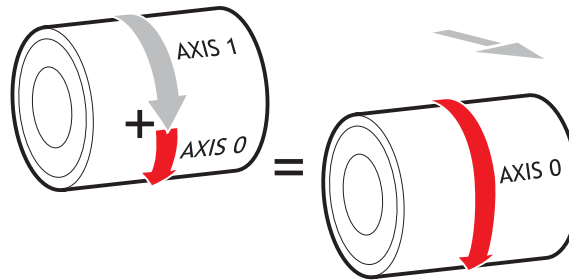

Example

UNITS AXIS(0)=1000

UNITS AXIS(1)=20

' Superimpose axis 1 on axis 0

ADDAX(1) AXIS(0)

MOVE(1) AXIS(0)

MOVE(2) AXIS(1)

'Axis 0 will move $1*1000+2*20=1040$ edges

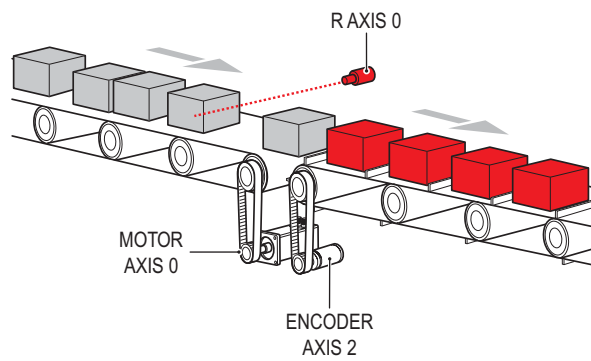

Example Pieces are placed randomly onto a belt that moves continuously. Further along the line they are transferred to a second flighted belt. A detection system indicates if a piece is in front of or behind its nominal position, and how far.

expected=2000 ' sets expected position

BASE(0)

ADDAX(1)

CONNECT(1,2) ' continuous geared connection to flighted belt

REPEAT

GOSUB getoffset ' get offset to apply

MOVE(offset) AXIS(1) ' make correcting move on virtual axis

UNTIL IN(2)=OFF ' repeat until stop signal on input 2

RAPIDSTOP

ADDAX(-1) ' clear ADDAX connection

STOP

**getoffset: ' sub routine to register the position of the
' piece and calculate the offset**

BASE(0)

REGIST(3)

WAIT UNTIL MARK

seenat=REG_POS

offset=expected-seenat

RETURN

Axis 0 in this example is connected to the encoder of the second conveyor. A superimposed **MOVE** on axis 1 is used to apply offsets.

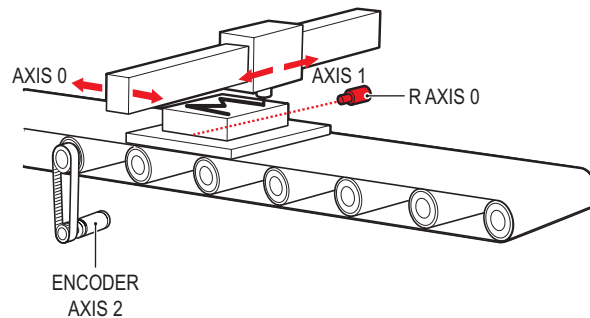

Example An X-Y marking machine must mark boxes as they move along a conveyor. Using CONNECT enables the X marking axis to follow the conveyor. A virtual axis is used to program the marking absolute positions; this is then superimposed onto the X axis using ADDAX.

```

ATYPE AXIS(3)=0 'set axis 3 as virtual axis
SERVO AXIS(3)=ON
DEFPOS(0) AXIS(3)
ADDAX (3)AXIS(0) 'connect axis 3 requirement to axis 0
WHILE IN(2)=ON
  REGIST(3) 'registration input detects a box on the conveyor
  WAIT UNTIL MARK OR IN(2)=OFF
  IF MARK THEN
    CONNECT(1,2) AXIS(0)'connect axis 0 to the moving belt
    BASE(3,1) 'set the drawing motion to axis 3 and 1
    'Draw the M
    MOVEABS(1200,0)'move A > B
    MOVEABS(600,1500)'move B > C
    MOVEABS(1200,3000)' move C > D
    MOVEABS(0,0)'move D > E
    WAIT IDLE
    BASE(0)
    CANCEL 'stop axis 0 from following the belt
    WAIT IDLE
    MOVEABS(0) 'move axis 0 to home position
  ENDIF
WEND
CANCEL

```

See also **ADDAX_AXIS**, **AXIS**, **OUTLIMIT**

 **WARNING** Beware that giving several **ADDAX** commands in a system can create a dangerous loop when for instance one axis is linked to another and vice versa. This may cause instability in the system.

4-2-23 ADDAX_AXIS

Type	Axis parameter (read-only)
Syntax	ADDAX_AXIS
Description	The ADDAX_AXIS axis parameter returns the number of the axis to which the base axis is currently linked to by ADDAX . If the base axis is not linked to any other axis, the ADDAX_AXIS parameter returns -1.
Arguments	N/A
Example	<pre> >> BASE(0) >> ADDAX(2) >> PRINT ADDAX_AXIS 2.0000 >> ADDAX(-1) >> PRINT ADDAX_AXIS -1.0000 </pre>
See also	ADDAX , AXIS

4-2-24 AIN

Type	I/O command
Syntax	AIN(analogue_chan)
Description	The AIN reads a value from the AIN array. The CJ1W-MCH72 does not provide any analogue input. The contents of the AIN array may be mapped to PLC memory to get values from e.g. PLC analogue input units.
Arguments	analogue_chan. Analogue input channel number 0..31
Example	MOVE(-5000) REPEAT a=AIN(1) IF a<0 THEN a=0 SPEED=a*0.25 UNTIL MTYPE=0 The speed of a production line is governed by the rate at which material is fed onto it. The material feed is via a lazy loop arrangement which is fitted with an ultra-sonic height sensing device. The output of the ultra-sonic sensor is in the range 0V to 4V where the output is at 4V when the loop is at its longest. Note: The analogue input value is checked to ensure it is above zero even though it always should be positive. This is to allow for any noise on the incoming signal which could make the value negative and cause an error because a negative speed is not valid for any move type except FORWARD or REVERSE .
See also	N/A

4-2-25 ALL

Type	Slot modifier
Syntax	ALL
Description	The ALL modifier is used with the commands DEL and NEW . It indicates that these commands are applied to all items in the directory structure of the controller.
Arguments	N/A
Example	DEL ALL This deletes all programs of the controller.
See also	DEL, NEW.

4-2-26 AND

Type	Mathematical operation
Syntax	expression1 AND expression2
Description	The AND operator performs the logical AND function on the corresponding bits of the integer parts of two valid BASIC expressions. The logical AND function between two bits is defined as follows: 0 AND 0 = 0 0 AND 1 = 0 1 AND 0 = 0 1 AND 1 = 1
Arguments	<ul style="list-style-type: none"> • expression1 Any valid BASIC expression. • expression2 Any valid BASIC expression.
Example	VR(0) = 10 AND (2.1*9) The parentheses are evaluated first, but only the integer part of the result, 18, is used for the AND operation. Therefore, this expression is equivalent to the following: VR(0) = 10 AND 18 The AND is a bit operator and so the binary action is as follows: 01010 AND 10010 = 00010 Therefore, VR(0) will contain the value 2.
Example	IF MPOS AXIS(0) > 0 AND MPOS AXIS(1) > 0 THEN GOTO cycle1 If measured positions MPOS of both axis 1 and axis 2 are greater than zero, program execution continues at label cycle1 . Otherwise, program execution continues with the next statement.
See also	N/A

4-2-27 AOUT

Type	I/O command
Syntax	AOUT(analogue_chan)
Description	The AOUT reads a value from the AOUT array. The CJ1W-MCH72 does not provide any analogue output. The contents of the AOUT array may be mapped to PLC memory to transfer values to e.g. PLC analogue output units.
Arguments	<ul style="list-style-type: none"> • analogue_chan. Analogue output channel number 0.31
Example	No example.
See also	N/A

4-2-28 ASIN

Type	Mathematical function
Syntax	ASIN(expression)
Description	The ASIN function returns the arc-sine of the argument. The argument must have a value between -1 and 1. The result in radians is between $-\pi/2$ and $\pi/2$. Input values outside this range return 0.
Arguments	<ul style="list-style-type: none">• expression Any valid BASIC expression.
Example	<pre>>> PRINT ASIN(-1) -1.5708</pre>
See also	N/A

4-2-29 ATAN

Type	Mathematical function
Syntax	ATAN(expression)
Description	The ATAN function returns the arc-tangent of the argument. expression can have any value. The result is in radians and is between $-\pi/2$ and $\pi/2$.
Arguments	<ul style="list-style-type: none">• expression Any valid BASIC expression.
Example	<pre>>> PRINT ATAN(1) 0.7854</pre>
See also	N/A

4-2-30 ATAN2

Type	Mathematical function
Syntax	ATAN2(expression1, expression2)
Description	The ATAN2 function returns the arc-tangent of the non-zero complex number (expression1, expression2), which is equivalent to the angle between a point with coordinate (expression1, expression2) and the x-axis. If expression2 ≥ 0 , the result is equal to the value of ATAN(expression1 / expression2) . The result in radians will be between $-\pi$ and π .
Arguments	<ul style="list-style-type: none">• expression1 Any valid BASIC expression.• expression2 Any valid BASIC expression.
Example	<pre>>> PRINT ATAN2(0,1) 0.0000</pre>
See also	N/A

4-2-31 ATYPE

Type	Axis parameter
Syntax	ATYPE = value
Description	The ATYPE axis parameter indicates the axis type for the axis. The valid values depend on the port the Servo Driver controlling the axis is connected to. See the table below.

AXIS type	ATYPE value
Virtual	0
MECHATROLINK-II Position	40
MECHATROLINK-II Speed	41
MECHATROLINK-II Torque	42
Flexible axis Stepper Out	43
Encoder Interface In	44
Flexible axis Encoder Out	45
Flexible axis Absolute EnDat	47
Flexible axis Absolute SSI	48
MECHATROLINK-II Inverter	49

The **ATYPE** parameters are set by the system at start-up. For axes controlled by the Servo Drivers connected to the system via MECHATROLINK-II bus, the default **ATYPE** value is 40 (MECHATROLINK-II Position) for all Servo Driver types. For axes controlled by the Servo Drivers connected to the system via the Encoder Interface, the default **ATYPE** value is 44 (Encoder Interface In).

Arguments	N/A
Example	ATYPE AXIS(1) = 45 This command will set axis 1 as Flexible axis encoder output axis.
See also	AXIS

4-2-32 AUTORUN

Type	Program command
Syntax	AUTORUN
Description	The AUTORUN command starts all the programs that have been set to run at start-up. Note: This command should only be used on the Command Line Terminal.
Arguments	N/A
Example	No example.
See also	RUNTYPE

4-2-33 AXIS

Type	System command
Syntax	AXIS(axis_number)
Description	The AXIS modifier sets the axis for a single motion command or a single axis parameter read/write to a particular axis. AXIS is effective only for the command or axis parameter operation. If it is required to change the axis used to a particular axis in every subsequent command, use the BASE command instead.
Arguments	<ul style="list-style-type: none">• axis_number Any valid BASIC expression specifying the axis number.
Example	BASE(0) PRINT VP_SPEED AXIS(2)
Example	MOVE(300) AXIS(0)
Example	REP_DIST AXIS(1) = 100
See also	BACKLASH

4-2-34 AXIS_ENABLE

Type	Axis parameter
Syntax	AXIS_ENABLE = ON/OFF
Description	The AXIS_ENABLE axis parameter is used to enable or disable particular axis independently of others. This parameter can be set ON or OFF for each axis individually. The default value on start-up is ON or all axes. The axis will be enables if both AXIS_ENABLE for that axis is ON and WDOG is on. For MECHATROLINK-II axes setting AXIS_ENABLE to OFF will disable Servo Driver output to the motor. For Flexible axis Servo axis setting AXIS_ENABLE to OFF will force both voltage outputs to 0. For Flexible axis Stepper Out and Encoder Out axes, setting AXIS_ENABLE to OFF will block pulses generation on the outputs.
Arguments	N/A
Example	AXIS_ENABLE AXIS(3) = OFF This command will disable axis 3 independently of other axes in the system.
See also	AXIS, DISABLE_GROUP

4-2-35 AXISSTATUS

Type Axis parameter (read-only)

Syntax **AXISSTATUS**

Description The **AXISSTATUS** axis parameter contains the axis status and is used for the motion error handling of the controller. The axis status consists of status bits, which definitions are shown in the table below.

Bit number	Description	Value	Character
0	-	1	-
1	Following error warning range	2	w
2	Servo Driver communication error	4	a
3	Servo Driver alarm	8	m
4	In forward limit	16	f
5	In reverse limit	32	r
6	Datuming	64	d
7	Feed hold input	128	h
8	Following error exceeds limit	256	e
9	In forward software limit	512	x
10	In reverse software limit	1024	y
11	Cancelling move	2048	c
12	Encoder out overspeed	4096	o

Arguments N/A

Example **IF (AXISSTATUS AND 16)>0 THEN PRINT "In forward limit"**

See also **AXIS, ERRORMASK**

4-2-36 B_SPLINE

Type	Axis command
Syntax	B_SPLINE(type, data_in, number_in, data_out, #expand)
Description	Expands an existing profile stored in the TABLE using the B-Spline mathematical function. The expansion factor is configurable and the B_SPLINE stores expanded profile to another area in the TABLE. This is ideally used where the source CAM profile is too course and needs to be extrapolated into a greater number of points.
Arguments	<ul style="list-style-type: none">• type Reserved for future expansion. Always set this to 1.• data_in Location in the TABLE where the source profile is stored.• number_in Number of points in the source profile.• data_out Location in the TABLE where the expanded profile will be stored.• expansion_ratio The expansion ratio, i.e., if the source profile is 100 points and expansion_ratio is set to 10 the resulting profile will be 1000 point (100 * 10).
Example	BASE(1) B_SPLINE(1, 0, 10, 200, 10) This command expands a 10 point profile in TABLE locations 0 to 9 to a larger 100 points profile starting at TABLE location 200.
See also	N/A

4-2-37 BACKLASH

Type	Axis command
Syntax	BACKLASH(on/off, distance, speed, accel)
Description	<p>The BACKLASH command allows the parameters for the backlash compensation to be loaded. The backlash compensation is achieved as follows:</p> <ul style="list-style-type: none"> • An offset move is applied when the motor demand is in one direction. • The offset move is reversed when the motor demand is in the opposite direction. <p>These moves are superimposed on the command axis movements. The backlash compensation is applied after a change in the direction of the DPOS parameter. The backlash compensation can be seen in the TRANS_DPOS parameter, which is equal to DPOS + backlash compensation.</p>
Arguments	<ul style="list-style-type: none"> • on/off Either ON or OFF. • distance The offset distance, expressed in user units. • speed The speed of the compensation move, expressed in user units. • accel The acceleration or deceleration rate of the compensation move, expressed in user units.
Example	<p>BACKLASH(ON,0.5,10,50) AXIS(0) BACKLASH(ON,0.4,8,50) AXIS(1) This applies backlash compensation on axes 0 and 1.</p>
See also	DPOS, TRANS_DPOS.

4-2-38 BACKLASH_DIST

Type	Axis parameter
Syntax	BACKLASH_DIST
Description	BACKLASH_DIST is the amount of backlash compensation that is applied to the axis when BACKLASH = ON .
Arguments	N/A
Example	<pre>IF BACKLASH_DIST>100 THEN OP (10, ON) ' show that backlash compensation reached this value ELSE OP (10, OFF) END IF</pre>
See also	BACKLASH

4-2-39 BASE

Type	Axis command
Syntax	BASE BASE(axis_1 [,axis_2 [, axis_3 [, axis_4 [, axis_...]]]]) BA BA(axis_1 [,axis_2 [, axis_3 [, axis_4 [, axis_...]]]])
Description	<p>The BASE command is used to set the default base axis or to set a specified axis sequence group. All subsequent motion commands and axis parameters will apply to the base axis or the specified axis group unless the AXIS command is used to specify a temporary base axis. The base axis or axis group is effective until it is changed again with BASE.</p> <p>Each BASIC process can have its own axis group and each program can set its own axis group independently. Use the PROC modifier to access the parameters for a certain task.</p> <p>The BASE order grouping can be set by explicitly assigning the order of axes. This order is used for interpolation purposes in multi-axes linear and circular moves. The default for the base axis group is (0,1,2,...31) at start-up or when a program starts running on a task. The BASE command without any arguments returns the current base order grouping. This should be used</p> <p>Note: If the BASE command does not specify all the axes, the BASE command will “fill in” the remaining values automatically. Firstly it will fill in any remaining axes above the last declared value, then it will fill in any remaining axes in sequence.</p> <p>So BASE(2,6,10) sets the internal array of 32 axes to: 2,6,10,11,12,13,14,15,16,17,18,19,20,21,22,23,24,25,26,27,28,29,30, 31,0,1,3,4,5,7,8,9.</p> <p>Note: The BASE command without any arguments should only be used on the Command Line Terminal.</p>
Arguments	<p>The command can take up to 32 arguments.</p> <ul style="list-style-type: none"> • axis_i The number of the axis set as the base axis and any subsequent axes in the group order for multi-axis moves.
Example	BASE(1) UNITS = 2000 ' Set unit conversion factor for axis 1 SPEED = 100 ' Set speed for axis 1 ACCEL = 5000 ' Set acceleration rate for axis 1 BASE(2) UNITS = 2000 ' Set unit conversion factor for axis 2 SPEED = 125 ' Set speed for axis 2 ACCEL = 10000 ' Set acceleration rate for axis 2 It is possible to program each axis with its own speed, acceleration and other parameters.
Example	BASE(0) MOVE(100,-23.1,1250) In this example, axes 0, 1 and 2 will move to the specified positions at the speed and acceleration set for axis 0. BASE(0) sets the base axis to axis 0, which determines the three axes used by MOVE and the speed and acceleration rate.

Example	>> BASE(0,1,2) On the command line the base group order can be shown by typing BASE .
Example	>> RUN "PROGRAM", 3 >> BASE PROC(3)(0,2,1) Use the PROC modifier to show the base group order of a certain task.
Example	>> BASE(2) >> PRINT BASE 2.0000 Printing BASE will return the current selected base axis.
See also	AXIS

4-2-40 BASICERROR

Type	System command
Syntax	BASICERROR
Description	The BASICERROR command can be used to run a routine when a run-time error occurs in a program. BASICERROR can only be used as part of an ON ... GOSUB or ON ... GOTO command. This command is required to be executed once in the BASIC program. If several commands are used only the one executed last is effective.
Arguments	N/A
Example	ON BASICERROR GOTO error_routine ... no_error = 1 STOP error_routine: IF no_error = 0 THEN PRINT "The error "; RUN_ERROR[0]; PRINT " occurred in line "; ERROR_LINE[0] ENDIF STOP If an error occurs in a BASIC program in this example, the error routine will be executed. The IF statement is present to prevent the program going into error routine when it is stopped normally.
See also	ERROR_LINE, ON, RUN_ERROR.

4-2-41 BATTERY_LOW

Type	System parameter (read-only)
Syntax	BATTERY_LOW
Description	This parameter returns the current state of the battery condition. If BATTERY_LOW=ON then the battery needs to be changed. If BATTERY_LOW=OFF then battery condition is ok.
Arguments	N/A
Example	No example.
See also	N/A

4-2-42 BREAK_RESET

Type	System command
Syntax	BREAK_RESET "program_name"
Description	Used by Trajexia Studio to remove all break points from the specified program.
Arguments	<ul style="list-style-type: none">• program_name The name of the program from which you want to remove all break points.
Example	BREAK_RESET "simpletest" Will remove all break points from program simpletest .
See also	N/A

4-2-43 CAM

Type	Axis command
Syntax	CAM(start_point, end_point, table_multiplier, distance)
Description	<p>The CAM command is used to generate movement of an axis following a position profile which is stored in the TABLE variable array. The TABLE values are absolute positions relative to the starting point and are specified in encoder edges. The TABLE array is specified with the TABLE command.</p> <p>The movement can be defined with any number of points from 3 to the maximum table size available (64000). The CJ1W-MCH72 moves continuously between the values in the TABLE to allow a number of points to define a smooth profile. Two or more CAM commands can be executed simultaneously using the same or overlapping values in the TABLE array. The TABLE profile is traversed once.</p> <p>CAM requires that the start element in the TABLE array has value zero. The distance argument together with the SPEED and ACCEL parameters determine the speed moving through the TABLE array. Note that in order to follow the CAM profile exactly the ACCEL parameter of the axis must be at least 1000 times larger than the SPEED parameter.</p> <p>CAM works on the default basis axis (set with BASE) unless AXIS is used to specify a temporary base axis.</p>

- Arguments
- **start_point**
The address of the first element in the TABLE array to be used. Being able to specify the start point allows the TABLE array to hold more than one profile and/or other information.
 - **end_point**
The address of the end element in the TABLE array.
 - **table_multiplier**
The Table multiplier value used to scale the values stored in the TABLE. As the Table values are specified in encoder edges, use this argument to set the values for instance to the unit conversion factor (set by **UNITS** parameter).
 - **distance**
A factor given in user units that controls the speed of movement through the Table. The time taken to execute **CAM** depends on the current axis speed and this distance. For example, assume the system is being programmed in mm and the speed is set to 10 mm/s and the acceleration sufficiently high. If a distance of 100 mm is specified, **CAM** will take 10 seconds to execute.
The **SPEED** parameter in the base axis allows modification of the speed of movement when using the **CAM** move.

Note: When the **CAM** command is executing, the **ENDMOVE** parameter is set to the end of the previous move.

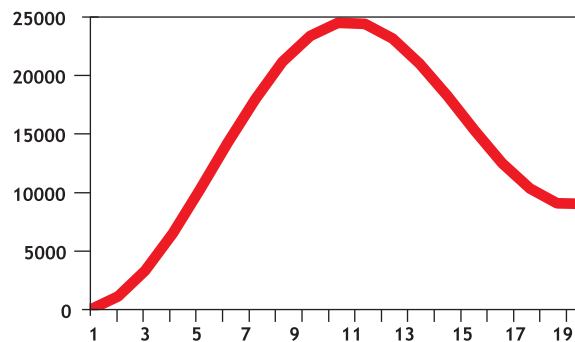

Example Motion is required to follow the POSITION equation:
 $t(x) = x*25 + 10000(1-\cos(x))$, where x is in degrees. This example table provides a simple oscillation superimposed with a constant speed. To load the table and cycle it continuously the program would be:

```
FOR deg=0 TO 360 STEP 20 'loop to fill in the table
  rad = deg * 2 * PI/360 'convert degrees to radians
  x = deg * 25 + 10000 * (1-COS(rad))
  TABLE(deg/20,x) 'place value of x in table
NEXT deg
WHILE IN(2)=ON 'repeat cam motion while input 2 is on
  CAM(0,18,1,200)
  WAIT IDLE
WEND
```

Note: The subroutine **camtable** loads the data into the cam TABLE, as shown in the figure and in the table below.

TABLE position	Degree	Value
1	0	0
2	20	1103
3	40	3340
4	60	6500
5	80	10263
6	100	14236
7	120	18000
8	140	21160
9	160	23396
10	180	24500
11	200	24396
12	220	23160
13	240	21000
14	260	18236
15	280	15263
16	300	12500
17	320	10340
18	340	9103
19	360	9000

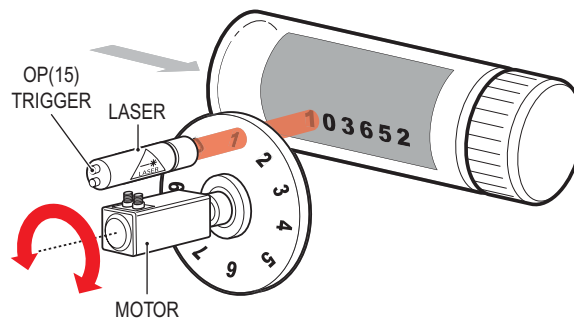

Example A masked wheel is used to create a stencil for a laser to shine through for use in a printing system for the ten numerical digits. The required digits are transmitted through port 1 serial port to the controller as ASCII text.

The encoder used has 4000 edges per revolution and so must move 400 between each position. The cam table goes from 0 to 1, which means that the **CAM** multiplier needs to be a multiple of 400 to move between the positions.

The wheel is required to move to the pre-set positions every 0.25 seconds. The speed is set to 10000 edges/second, and we want the profile to be complete in 0.25 seconds. So multiplying the axis speed by the required completion time (10000 x 0.25) gives the distance parameter equals 2500.

GOSUB profile_gen

WHILE IN(2)=ON

WAIT UNTIL KEY#1 'Waits for character on port 1

GET#1,k

IF k>47 AND k<58 THEN 'check for valid ASCII character

position=(k-48)*400 'convert to absolute position

multiplier=position-offset 'calculate relative movement

'check if it is shorter to move in reverse direction

IF multiplier>2000 THEN

multiplier=multiplier-4000

ELSEIF multiplier<-2000 THEN

multiplier=multiplier+4000

ENDIF

CAM(0,200,multiplier,2500) 'set the CAM movement

WAIT IDLE

OP(15,ON) 'trigger the laser flash

WA(20)

OP(15,OFF)

offset=(k-48)*400 'calculates current absolute position

ENDIF

WEND

```

profile_gen:
  num_p=201
  scale=1.0
  FOR p=0 TO num_p-1
    TABLE(p,((-SIN(PI*2*p/num_p))/(PI*2))+p/num_p)*scale)
  NEXT p
RETURN

```

Example A suction pick and place system must vary its speed depending on the load carried. The mechanism has a load cell which inputs to the controller on the analogue channel (**AIN**).

The move profile is fixed, but the time taken to complete this move must be varied depending on the **AIN**. The **AIN** value varies from 100 to 800, which must result in a move time of 1 to 8 seconds. If the speed is set to 10000 units per second and the required time is 1 to 8 seconds, then the distance parameter must range from 10000 to 80000. (distance = speed x time).

The return trip can be completed in 0.5 seconds and so the distance value of 5000 is fixed for the return movement. The Multiplier is set to -1 to reverse the motion.

```

GOSUB profile_gen 'loads the cam profile into the table
SPEED=10000:ACCEL=SPEED*1000:DECEL=SPEED*1000
WHILE IN(2)=ON
  OP(15,ON) 'turn on suction
  load=AIN(0) 'capture load value
  distance = 100*load 'calculate the distance parameter
  CAM(0,200,50,distance) 'move 50mm forward in time calculated
  WAIT IDLE
  OP(15,OFF) 'turn off suction
  WA(100)
  CAM(0,200,-50,5000) 'move back to pick up position
WEND

```

```

profile_gen:
  num_p=201
  scale=400 'set scale so that multiplier is in mm
  FOR p=0 TO num_p-1
    TABLE(p,((-SIN(PI*2*p/num_p))/(PI*2))+p/num_p)*scale)
  NEXT p
RETURN

```

See also **ACCEL, AXIS, CAMBOX, SPEED, TABLE.**

4-2-44 CAMBOX

Type Axis command

Syntax **CAMBOX(start_point, end_point, table_multiplier, link_distance, link_axis [, link_option [, link_position]])**

Description The **CAMBOX** command is used to generate movement of an axis following a position profile in the TABLE variable array. The motion is linked to the measured motion of another axis to form a continuously variable software gearbox. The TABLE values are absolute position relative to the starting point and are specified in encoder edges. The TABLE array is specified with the **TABLE** command. The movement can be defined with any number of points from 3 to the maximum table size available (64000). Being able to specify the start point allows the TABLE array to be used to hold more than one profile and/or other information. The CJ1W-MCH72 moves continuously between the values in the TABLE to allow a number of points to define a smooth profile. Two or more **CAMBOX** commands can be executed simultaneously using the same or overlapping values in the TABLE array. The **CAMBOX** command requires the start element of the TABLE to have value zero. Note also that **CAMBOX** command allows traversing the TABLE backwards as well as forwards depending on the Master axis direction. The **link_option** argument can be used to specify different options to start the command and to specify a continuous **CAM**. For example, if the **link_option** is set to 4 then the **CAMBOX** operates like a "physical" **CAM**. **CAMBOX** works on the default basis axis (set with **BASE**) unless **AXIS** is used to specify a temporary base axis. Note: While **CAMBOX** is being executed, the **ENDMOVE** parameter will be set to the end of the previous move. The **REMAIN** axis parameter will hold the remainder of the distance on the link axis.

Arguments

- **start_point**
The address of the first element in the TABLE array to be used.
- **end_point**
The address of the end element in the TABLE array.
- **table_multiplier**
The Table multiplier value used to scale the values stored in the TABLE. As the TABLE values are specified in encoder edges, use this argument to set the values for instance to the unit conversion factor (set by UNITS parameter).
- **link_distance**
The distance in user units the link axis must move to complete the specified output movement. The link distance must be specified as a positive distance.
- **link_axis**
The axis to link to.
- **link_option**
See the table below.

link_option value	Description
1	Link starts when registration event occurs on link axis.
2	Link starts at an absolute position on link axis (see link_position).

link_option value	Description
4	CAMBOX repeats automatically and bidirectionally. This option is cancelled by setting bit 1 of REP_OPTION parameter (REP_OPTION = REP_OPTION OR 2).
5	Combination of options 1 and 4.
6	Combination of options 2 and 4.

- **link_position**

The absolute position where **CAMBOX** will start when **link_option** is set to 2.

Note: When the **CAMBOX** command is executing, the **ENDMOVE** parameter is set to the end of the previous move. The **REMAIN** axis parameter holds the remainder of the distance on the link axis.

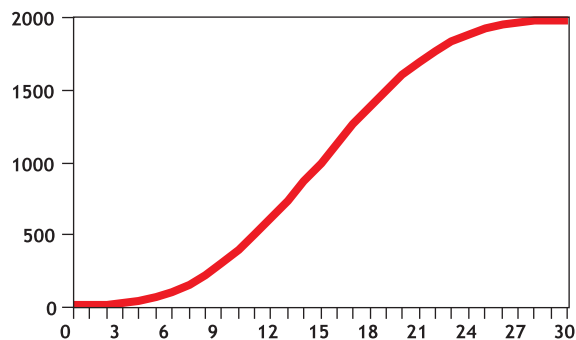

Example ' Subroutine to generate a SIN shape speed profile
 ' Uses: p is loop counter
 ' num_p is number of points stored in tables pos 0..num_p
 ' scale is distance travelled scale factor
 profile_gen:
 num_p=30
 scale=2000
 FOR p=0 TO num_p
 TABLE(p,((-SIN(PI*2*p/num_p)/(PI*2))+p/num_p)*scale)
 NEXT p
 RETURN

This graph plots TABLE contents against table array position. This corresponds to motor POSITION against link POSITION when called using **CAMBOX**. The **SPEED** of the motor will correspond to the derivative of the position curve above.

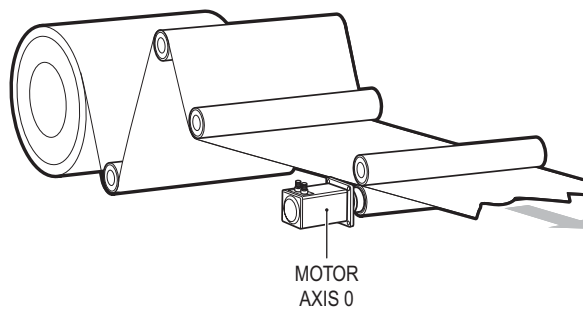
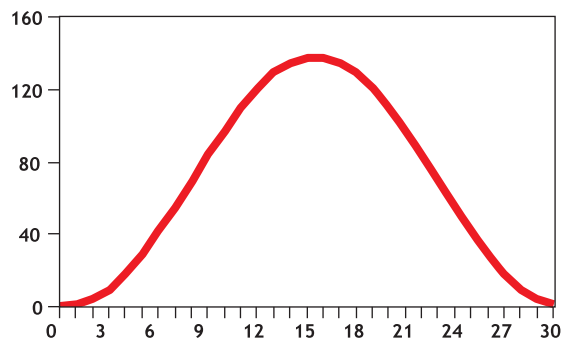

Example

A pair of rollers feeds plastic film into a machine. The feed is synchronised to a master encoder and is activated when the master reaches a position held in the variable **start**. This example uses the table points 0...30 generated in the example above:

```

start=1000
FORWARD AXIS(1)
WHILE IN(2)=OFF
  CAMBOX(0,30,800,80,15,2,start)
  WA(10)
WAIT UNTIL MTYPE=0 OR IN(2)=ON
WEND
CANCEL
CANCEL AXIS(1)
WAIT IDLE

```

The arguments of the **CAMBOX** command are:

- 0 is the start of the profile shape in the TABLE
- 30 is the end of the profile shape in the TABLE
- 800 scales the TABLE values. Each **CAMBOX** motion therefore totals 800*2000 encoder edges steps.
- 80 is the distance on the product conveyor to link the motion to. The units for this parameter are the programmed distance units on the link axis.
- 15 specifies the axis to link to.
- 2 is the link option setting. It means: Start at absolute position on the link axis.
- The variable **start** holds a position. The motion will execute when this position is reached on axis 15.

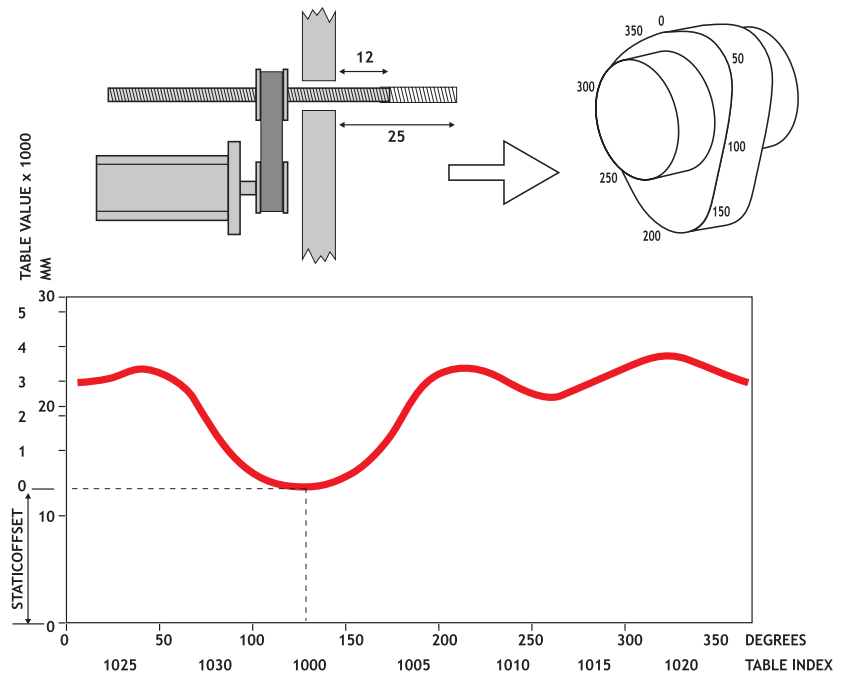

Example

A motor on Axis 0 is required to emulate a rotating mechanical CAM. The position is linked to motion on axis 3. The “shape” of the motion profile is held in TABLE values 1000..1035. The table values represent the mechanical cam but are scaled to range from 0-4000.

```

TABLE(1000,0,0,167,500,999,1665,2664,3330,3497,3497)
TABLE(1010,3164,2914,2830,2831,2997,3164,3596,3830,3996,3996)
TABLE(1020,3830,3497,3330,3164,3164,3164,3330,3467,3467,3164)
TABLE(1030,2831,1998,1166,666,333,0)
BASE(3)
MOVEABS(130)
WAIT IDLE
'start the continuously repeating cambox
CAMBOX(1000,1035,1,360,3,4) AXIS(0)
FORWARD start camshaft axis
WAIT UNTIL IN(2)=OFF
REP_OPTION = 2 'cancel repeating mode by setting bit 1
WAIT IDLE AXIS(0) waits for cam cycle to finish
CANCEL 'stop camshaft axis
WAIT IDLE
    
```

Note: The system software resets bit 1 of **REP_OPTION** after the repeating mode has been cancelled.

Setting bit 3 (value 8) of the link options parameter enables the **CAMBOX** pattern mode. This mode enables a sequence of scale values to be cycled automatically. This is normally combined with the automatic repeat mode, so the options parameter must be set to 12. This diagram shows a typical repeating pattern which can be automated with the **CAMBOX** pattern mode.

The parameters for this mode are treated differently to the standard **CAMBOX** function:

CAMBOX(start, end, control block pointer, link dist, link axis,options)

The start and end parameters specify the basic shape profile ONLY. The pattern sequence is specified in a separate section of the TABLE memory. There is a new TABLE block defined: The "Control Block". This block of seven TABLE values defines the pattern position, repeat controls etc. The block is fixed at 7 values long.

Therefore in this mode only there are 3 independently positioned TABLE blocks used to define the required motion:

- **SHAPE BLOCK:** This is directly pointed to by the **CAMBOX** command as in any **CAMBOX**.
- **CONTROL BLOCK:** This is pointed to by the third **CAMBOX** parameter in this options mode only. It is of fixed length (7 table values). It is important to note that the control block is modified during the **CAMBOX** operation. It must therefore be re-initialised prior to each use.
- **PATTERN BLOCK:** The start and end of this are pointed to by 2 of the CONTROL BLOCK values. The pattern sequence is a sequence of scale factors for the SHAPE.

The table below gives the CONTROL BLOCK parameters

Note: READ/WRITE values can be written to by the user program during the pattern **CAMBOX** execution.

Value	Parameter	R/W	Description
0	CURRENT POSITION	R	The current position within the TABLE of the pattern sequence. This value should be initialised to the START PATTERN number.
1	FORCE POSITION	R/W	Normally this value is -1. If at the end of a SHAPE the user program has written a value into this TABLE position the pattern will continue at this position. The system software will then write -1 into this position. The value written must be inside the pattern such that the value: $CB(2) \leq CB(1) \leq CB(3)$
2	START PATTERN	R	The position in the TABLE of the first pattern value.
3	END PATTERN	R	The position in the TABLE of the final pattern value.
4	REPEAT POSITION	R/W	The current pattern repeat number. Initialise this number to 0. The number will increment when the pattern repeats if the link axis motion is in a positive direction. The number will decrement when the pattern repeats if the link axis motion is in a negative direction. Note that the counter runs starting at zero: 0,1,2,3...

Value	Parameter	R/W	Description
5	REPEAT COUNT	R/W	<p>Required number of pattern repeats. If -1 the pattern repeats endlessly. The number should be positive. When the ABSOLUTE value of CB(4) reaches CB(5) the CAMBOX finishes if CB(6)=-1. The value can be set to 0 to terminate the CAMBOX at the end of the current pattern.</p> <p>The axis the CAMBOX is linked to can run in a positive or negative direction. In the case of a negative direction link the pattern will execute in reverse. In the case where a certain number of pattern repeats is specified with a negative direction link, the first control block will produce one repeat less than expected. This is because the CAMBOX loads a zero link position which immediately goes negative on the next servo cycle triggering a REPEAT COUNT. This effect only occurs when the CAMBOX is loaded, not on transitions from CONTROL BLOCK to CONTROL BLOCK. This effect can easily be compensated for either by increasing the required number of repeats, or setting the initial value of REPEAT POSITION to 1.</p>
6	NEXT CONTROL BLOCK	R/W	<p>If set to -1 the pattern will finish when the required number of repeats are done. Alternatively a new control block pointer can be used to point to a further control block.</p>

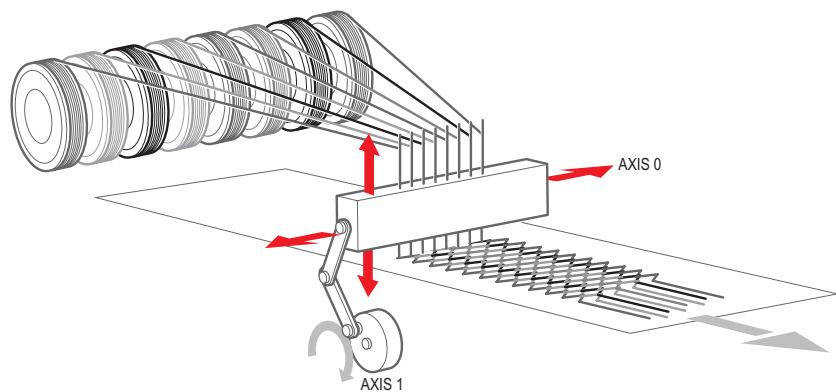

Example A quilt stitching machine runs a feed cycle that stitches a plain pattern before it starts a patterned stitch. The plain pattern must run for 1000 cycles. Then, it must run a pattern continuously, until requested to stop at the end of the pattern. The cam profile controls the motion of the needle bar between moves. The pattern table controls the distance of the move to make the pattern.

The same shape is used for the initialisation cycles and the pattern. This shape is held in TABLE values 100..150. The running pattern sequence is held in TABLE values 1000..4999. The initialisation pattern is a single value held in TABLE(160). The initialisation control block is held in TABLE(200)..TABLE(206). The running control block is held in TABLE(300)..TABLE(306).

' Set up Initialisation control block:

TABLE(200,160,-1,160,160,0,1000,300)

' Set up running control block:

TABLE(300,1000,-1,1000,4999,0,-1,-1)

' Run whole lot with single CAMBOX:

' Third parameter is pointer to first control block

CAMBOX(100,150,200,5000,1,20)

WAIT UNTIL IN(7)=OFF

TABLE(305,0) ' Set zero repeats: This will stop at end of pattern

Note: The axis to which the CAMBOX is linked can run in a positive or negative direction. In the case of a negative direction link, the pattern executes in reverse. In the case where a certain number of pattern repeats is specified with a negative direction link, the first control block produces one repeat less than expected. This is because the CAMBOX loads a zero link position which immediately goes negative on the next servo cycle triggering a REPEAT COUNT. This effect only occurs when the CAMBOX is loaded, not on transitions from CONTROL BLOCK to CONTROL BLOCK. This effect can easily be compensated for: either increase the required number of repeats, or set the initial value of REPEAT POSITION to 1.

See also **AXIS, CAM, REP_OPTION, TABLE**

4-2-45 CANCEL

Type	Axis command
Syntax	CANCEL[(1)] CA[(1)]
Description	<p>The CANCEL command cancels the move on an axis or an interpolating axis group. Speed-profiled moves (FORWARD, REVERSE, MOVE, MOVEABS, MOVECIRC, MHELICAL and MOVEMODIFY) will be decelerated at the deceleration rate as set by the DECCEL parameter and then stopped. Other moves will be immediately stopped.</p> <p>The CANCEL command cancels the contents of the current move buffer (MTYPE). The command CANCEL(1) cancels the contents of the next move buffer (NMTYPE) without affecting the current move in the MTYPE buffer.</p> <p>CANCEL works on the default basis axis (set with BASE) unless AXIS is used to specify a temporary base axis.</p> <p>Note:</p> <ul style="list-style-type: none"> • CANCEL cancels only the presently executing move. If further moves are buffered they will then be loaded. • During the deceleration of the current move additional CANCELs will be ignored. • CANCEL(1) cancels only the presently buffered move. Any moves stored in the task buffers indicated by the PMOVE variable can be loaded into the buffer as soon as the buffered move is cancelled.
Arguments	N/A

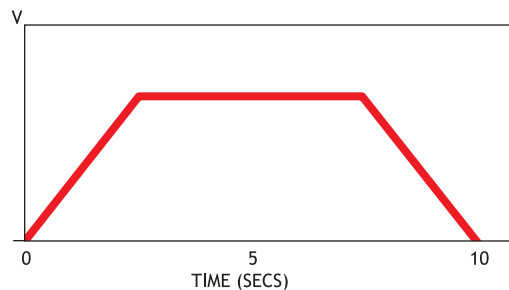

Example	FORWARD WA(10000) CANCEL ' Stop movement after 10 seconds
Example	MOVE(1000) MOVEABS(3000) CANCEL ' Cancel the move to 3000 and move to 4000 instead. MOVEABS(4000) <p>Note that the command MOVEMODIFY is a better solution for modifying end points of moves in this case.</p>

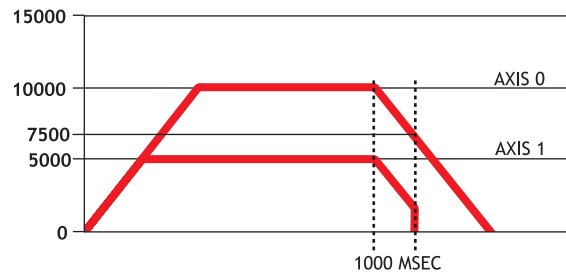

Example Two axes are connected with a ratio of 1:2. Axis 0 is cancelled after 1 second, then axis 1 is cancelled when the speed drops to a specified level. After the first cancel axis 1 decelerates at the **DECEL** rate. When the **CONNECT** of axis 1 is cancelled, axis 1 stops instantly.

```
BASE(0)
SPEED=10000
FORWARD
CONNECT(0.5,0) AXIS(1)
WA(1000)
CANCEL
WAIT UNTIL VP_SPEED<=7500
CANCEL AXIS(1)
```

See also **AXIS, MTYPE, NTYPE, PMOVE, RAPIDSTOP**

4-2-46 CHECKSUM

Type System parameter (read-only)

Syntax **CHECKSUM**

Description The **CHECKSUM** parameter contains the checksum for the programs in RAM. At start-up, the checksum is recalculated and compared with the previously held value. If the checksum is incorrect the program will not run.

Arguments N/A

Example No example.

See also N/A

4-2-47 CHR

Type	I/O command
Syntax	CHR(x)
Description	The CHR command is used to send individual ASCII characters which are referred to by number. PRINT CHR(x) ; is equivalent to PUT(x) in some other versions of BASIC.
Arguments	<ul style="list-style-type: none"> • x A BASIC expression.
Example	>>PRINT CHR(65); A
See also	N/A

4-2-48 CLEAR

Type	System command
Syntax	CLEAR
Description	The CLEAR command resets all global VR variables to 0 and sets local variables on the process on which the command is run to 0. When you use it in a program it resets all local variables defined to 0.
Arguments	N/A
Example	>>VR(0)=22: VR(20)=44.3158: VR(300)=-12 >>PRINT VR(0), VR(20), VR(300) 22.0000 44.3158 -12.0000 >>CLEAR >>PRINT VR(0), VR(20), VR(300) 0.0000 0.0000 0.0000
See also	• RESET, VR

4-2-49 CLEAR_BIT

Type	System command
Syntax	CLEAR_BIT(bit_number, vr_number)
Description	The CLEAR_BIT command resets the specified bit in the specified VR variable. Other bits in the variable keep their values.
Arguments	<ul style="list-style-type: none"> • bit_number The number of the bit to be reset. Range: 0 - 23. • vr_number The number of the VR variable for which the bit will be reset. Range: 0 - 1023.
Example	>>PRINT VR(17) 112.0000 >>CLEAR_BIT(5, 17) >>PRINT VR(17) 80.0000
See also	READ_BIT, SET_BIT, VR.

4-2-50 CLEAR_PARAMS

Type	System command
Syntax	CLEAR_PARAMS
Description	Clears all variables and parameters stored in flash EPROM to their default values. The CLEAR_PARAM will erase (set to 0) all the VRs stored using FLASHVR command. This command cannot be performed if the controller is locked.
Arguments	N/A
Example	No example.
See also	N/A

4-2-51 CLOSE_WIN

Type	Axis parameter
Syntax	CLOSE_WIN CW
Description	The CLOSE_WIN axis parameter defines the end of the window inside or outside which a registration mark is expected. The value is in user units.
Arguments	N/A
Example	CLOSE_WIN=10
See also	AXIS, OPEN_WIN, REGIST, UNITS.

4-2-52 CLUTCH_RATE

Type	Axis parameter
Syntax	CLUTCH_RATE
Description	The CLUTCH_RATE axis parameter defines the change in connection ratio when using the CONNECT command. The rate is defined as amount of ratio per second. The default value is set to a high value (1000000) in order to ensure compatibility with other units. Note: The operation using CLUTCH_RATE is not deterministic in position. If required, use the MOVELINK command instead to avoid unnecessary phase difference between base axis and linked axis.
Arguments	N/A
Example	CLUTCH_RATE = 4 This setting will imply that when giving CONNECT(4,1) , it will take one second to reach the full connection.
See also	AXIS, CONNECT, MOVELINK.

4-2-53 COMPILE

Type	Program command
Syntax	COMPILE
Description	The COMPILE command forces the compilation of the currently selected program to intermediate code. Program are compiled automatically by the system software prior to program execution or when another program is selected. This command is not therefore normally required.
Arguments	N/A
Example	No example.
See also	N/A

4-2-54 CONNECT

Type	Axis command
Syntax	CONNECT(ratio, driving_axis) CO(ratio, driving_axis)
Description	The CONNECT command connects the demand position of the base axis to the measured movements of the axis specified by driving_axis to achieve an electronic gearbox. The ratio can be changed at any time by executing another CONNECT command on the same axis. To change the driving axis the CONNECT command needs to be cancelled first. CONNECT with different driving axis will be ignored. The CONNECT command can be cancelled with a CANCEL or RAPIDSTOP command. The CLUTCH_RATE axis parameter can be used to set a specified connection change rate. CONNECT works on the default basis axis (set with BASE) unless AXIS is used to specify a temporary base axis.

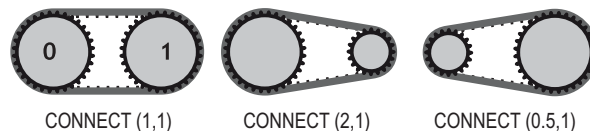

Arguments	<ul style="list-style-type: none"> • ratio The connection ratio of the gearbox. The ratio is specified as the encoder edge ratio (not units). It holds the number of edges the base axis is required to move per edge increment of the driving axis. The ratio value can be either positive or negative and has sixteen bit fractional resolution. • driving_axis The Master axis which will drive the base axis. Note: To achieve an exact connection of fractional ratio's of values such as 1024/3072 the MOVELINK command can be used with the continuous repeat link option set to ON.
-----------	--

Example In a press feed, a roller is required to rotate at a speed that is equal to one quarter of the measured rate from an encoder installed on the incoming conveyor. The roller is wired to the master axis 0. The reference encoder is connected to axis 1.

```
BASE(0)  
SERVO=ON  
CONNECT(0.25,1)
```

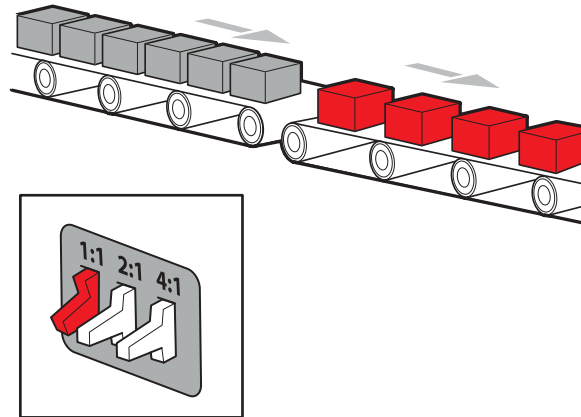

Example A machine has an automatic feed on axis 1 that must move at a set ratio to axis 0. This ratio is selected using inputs 0-2 to select a particular “gear”. This ratio can be updated every 100 ms. Combinations of inputs select the intermediate gear ratios. For example, 1 ON and 2 ON gives a ratio of 6:1.

```
BASE(1)  
FORWARD AXIS(0)  
WHILE IN(3)=ON  
  WA(100)  
  gear = IN(0,2)  
  CONNECT(gear,0)  
WEND  
RAPIDSTOP cancel the FORWARD and the CONNECT
```

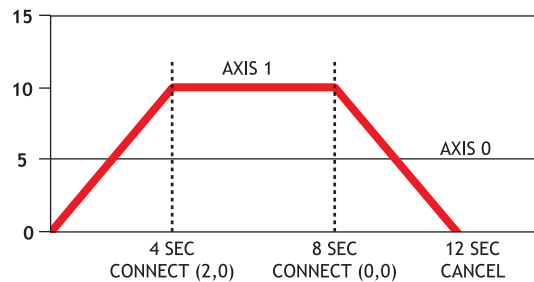

Example Axis 0 is required to run a continuous forward. Axis 1 must connect to axis 0. If **CONNECT** is called, it results in a step change. Therefore, **CLUTCH_RATE** is used, together with an initial and final connect ratio of zero, to get the required motion.

```
FORWARD AXIS(0)
BASE(1)
CONNECT(0,0) 'set initial ratio to zero
CLUTCH_RATE=0.5 'set clutch rate
CONNECT(2,0) 'apply the required connect ratio
WA(8000)
CONNECT(0,0) 'apply zero ratio to disconnect
WA(4000) 'wait for deceleration to complete
CANCEL 'cancel connect
```

See also **AXIS, CANCEL, CLUTCH_RATE, CONNECT, RAPIDSTOP.**

4-2-55 CONSTANT

Type System command

Syntax **CONSTANT "name", value**

Description Declares the name as a constant for use both within the program containing the **CONSTANT** definition and all other programs in the Trajexia Studio solution.

Note: The program containing the **CONSTANT** definition must be run before the name is used in other programs. In addition, only that program should be running at the time the **CONSTANT** is executed, otherwise the program error will appear and the program will stop when trying to execute this command. For fast startup the program should also be the only process running at power-up.

When the **CONSTANT** is declared, the declaration remains active until the next CJ1W-MCH72 reset by switching the power off and back on, or by executing the EX command.

A maximum of 128 **CONSTANTS** can be declared.

Arguments	<ul style="list-style-type: none"> • name Any user-defined name containing lower case alpha, numerical or underscore characters. • value The value assigned to name.
Example	<pre> CONSTANT "nak", \$15 CONSTANT "start_button", 5 IF IN(start_button)=ON THEN OP(led1, ON) IF key_char=nak THEN GOSUB no_ack_received</pre>
See also	N/A

4-2-56 CONTROL

Type	System parameter (read-only)
Syntax	CONTROL
Description	<p>The CONTROL parameter returns the type of controller in the system. The value of this system parameter for the CJ1W-MCH72 is 264.</p> <p>Note: When the Motion Controller is locked, 1000 is added to the value, so a locked CJ1W-MCH72 will return 1264.</p>
Arguments	N/A
Example	No example.
See also	N/A

4-2-57 COPY

Type	Program command
Syntax	COPY program_name new_program_name
Description	<p>The COPY command copies an existing program in the controller to a new program with the specified name. The program name can be specified without quotes.</p> <p>Note: This command is implemented for the Command Line Terminal.</p>
Arguments	<ul style="list-style-type: none"> • program_name Name of the program to be copied. • new_program_name Name to use for the new program.
Example	>> COPY "prog" "newprog"
See also	DEL, NEW, RENAME.

4-2-58 COS

Type	Mathematical function
Syntax	COS(expression)
Description	<p>The COS function returns the cosine of the expression. Input values are in radians and may have any value. The result value will be in the range from -1 to 1.</p>

Arguments	<ul style="list-style-type: none"> expression Any valid BASIC expression.
Example	>> PRINT COS(0) 1.0000
See also	N/A

4-2-59 CREEP

Type	Axis parameter
Syntax	CREEP
Description	<p>The CREEP axis parameter contains the creep speed for the axis. The creep speed is used for the slow part of an origin search sequence. CREEP can have any positive value, including 0.</p> <p>The creep speed is entered in units/sec with the unit conversion factor UNITS. For example, if the unit conversion factor is set to the number of encoder edges/inch, the speed is set in inches/sec.</p>
Arguments	N/A
Example	BASE(2) CREEP=10 SPEED=500 DATUM(4) CREEP AXIS(1)=10 SPEED AXIS(1)=500 DATUM(4) AXIS(1)
See also	AXIS, DATUM, UNITS.

4-2-60 D_GAIN

Type	Axis parameter
Syntax	D_GAIN
Description	<p>The D_GAIN axis parameter contains the derivative gain for the axis. The derivative output contribution is calculated by multiplying the change in Following Error with D_GAIN. The default value is 0.</p> <p>Add the derivative gain to a system to produce a smoother response and to allow the use of a higher proportional gain that could not be used otherwise. High values can cause oscillation.</p> <p>Note: The servo gain must only be changed when the SERVO is off.</p> <p>Note: Servo gains have no affect on stepper output axis, ATYPE=46.</p>
Arguments	N/A
Example	D_GAIN=0.25
See also	<ul style="list-style-type: none"> AXIS, I_GAIN, OV_GAIN, P_GAIN, VFF_GAIN.

4-2-61 D_ZONE_MAX

Type	System parameter
Syntax	D_ZONE_MAX=value

Description	This parameter works in conjunction with D_ZONE_MIN to clamp the S_REF output to zero when the demand movement is complete and the magnitude of the Following Error is less than the D_ZONE_MIN value. The servo loop will be reactivated when either the Following Error rises above the D_ZONE_MAX value, or a fresh movement is started.
Arguments	N/A
Example	D_ZONE_MIN=3 D_ZONE_MAX=10 With these 2 parameters set as above, the S_REF output will be clamped at zero when the movement is complete and the Following Error falls below 3. When a movement is restarted or if the Following Error rises above a value of 10, the servo loop will be reactivated.
See also	D_ZONE_MIN .

4-2-62 D_ZONE_MIN

Type	System parameter
Syntax	D_ZONE_MIN=value
Description	This parameter works in conjunction with D_ZONE_MAX to clamp the S_REF output to zero when the demand movement is complete and the magnitude of the Following Error is less than the D_ZONE_MIN value. The servo loop will be reactivated when either the Following Error rises above the D_ZONE_MAX value, or a fresh movement is started.
Arguments	N/A
Example	D_ZONE_MIN=3 D_ZONE_MAX=10 With these 2 parameters set as above, the S_REF output will be clamped at zero when the movement is complete and the Following Error falls below 3. When a movement is restarted or if the Following Error rises above a value of 10, the servo loop will be reactivated.
See also	D_ZONE_MAX .

4-2-63 DATE

Type	System parameter (read-only)
Syntax	DATE
Description	Returns the current date held by the real time clock of the PLC.
Arguments	N/A
Example	>>PRINT DATE 36956 This prints the number representing the current day. This number is the number of days since 1st January 1900, with 1 Jan. 1900 represented as 1.
See also	N/A

4-2-64 DATE\$

Type	System command
Syntax	DATE\$
Description	Prints the current date DD/MM/YY as a string to the communication port. A 2-digit year description is given.
Arguments	N/A
Example	PRINT, DATE\$ This will print the date in format for example: 20/10/05
See also	N/A

4-2-65 DATUM

Type	Axis command
Syntax	DATUM(sequence)
Description	<p>The DATUM command performs one of 6 origin search sequences to position an axis to an absolute position and also reset the error bits in AXISSTATUS axis parameter.</p> <p>DATUM uses both the creep and demand speed for the origin search. The creep speed in the sequences is set with the CREEP axis parameter and the demand speed is set with the SPEED axis parameter. The datum switch input number, used for sequences 3 to 6, is set by the DATUM_IN parameter.</p> <p>DATUM works on the default basis axis (set with BASE) unless AXIS is used to specify a temporary base axis.</p> <p>Note: The origin input set with the DATUM_IN parameter is active low, i.e., the origin switch is set when the input is OFF. The feedhold, reverse jog, forward jog, forward and reverse limit inputs are also active low. Active low inputs are used to enable fail-safe wiring.</p>
Arguments	<ul style="list-style-type: none"> • sequence See the table below.

sequence value	Description
0	<p>The DATUM(0) command will clear the motion error. The currently measured position is set as the demand position (this is especially useful on stepper axes with position verification). DATUM(0) also clears the Following Error that exceeded the FE_LIMIT condition in the AXISSTATUS register for ALL axes. It sets these bits in AXISSTATUS to zero:</p> <p>Bit 1 : Following Error Warning. Bit 2 : Remote Driver Comms Error. Bit 3 : Remote Driver Error. Bit 8 : Following Error Limit Exceeded. Bit 11 : Cancelling Move.</p> <p>Note that the status can not be cleared if the cause of the problem is still present. DATUM(0) must only be used after the WDOG is set to OFF, otherwise there will be unpredictable errors on the motion.</p>

sequence value	Description
1	The axis moves at creep speed forward until the Z marker is encountered. The demand position is then reset to 0 and the measured position corrected so as to maintain the Following Error.
2	The axis moves at creep speed in reverse until the Z marker is encountered. The demand position is then reset to 0 and the measured position corrected so as to maintain the Following Error.
3	The axis moves at the demand speed forward until the datum switch is reached. The axis then moves reverse at creep speed until the datum switch is reset. The demand position is then reset to 0 and the measured position corrected so as to maintain the Following Error.
4	The axis moves at the demand speed in reverse until the datum switch is reached. The axis then moves forward at creep speed until the datum switch is reset. The demand position is then reset to 0 and the measured position corrected so as to maintain the Following Error.
5	The axis moves at demand speed forward until the datum switch is reached. The axis then reverses at creep speed until the datum switch is reset. The axis continues in reverse at creep speed until the Z marker of the encoder is encountered. The demand position is then reset to 0 and the measured position corrected so as to maintain the Following Error.
6	The axis moves at demand speed reverse until the datum switch is reached. The axis then moves forward at creep speed until the datum switch is reset. The axis continues forward at creep speed until the Z marker of the encoder is encountered. The demand position is then reset to 0 and the measured position corrected so as to maintain the Following Error.

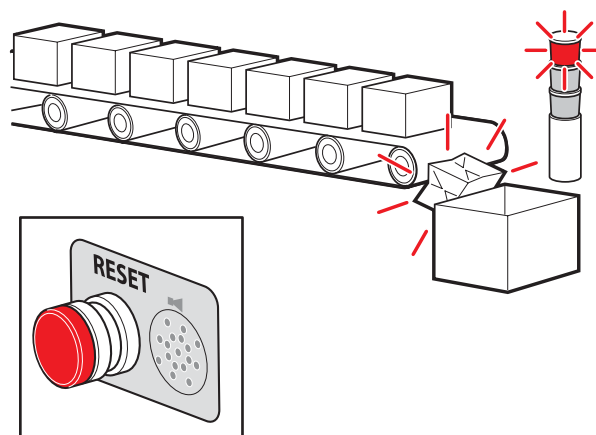

Example A production line must stop if something blocks the product belt, which causes a motion error. The obstacle must be removed, and a reset button must be pressed to restart the line.

```

FORWARD 'start production line
WHILE IN(2)=ON
  IF MOTION_ERROR=0 THEN
    OP(8,ON) 'green light on; line is in motion
  ELSE
    OP(8, OFF)
    GOSUB error_correct
  ENDIF
WEND
CANCEL
STOP

```

error_correct:

```

REPEAT
  OP(10,ON)
  WA(250)
  OP(10,OFF) 'flash red light to show crash
  WA(250)
UNTIL IN(1)=OFF
DATUM(0) 'reset axis status errors
SERVO=ON 'turn the servo back on
WDOG=ON 'turn on the watchdog
OP(9,ON) 'sound siren that line will restart
WA(1000)
OP(9,OFF)
FORWARD 'restart motion
RETURN

```

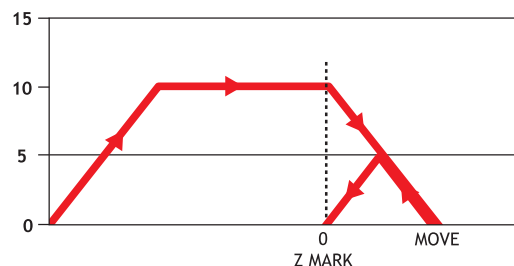

Example The position of an axis must be defined by the Z marker. This position must be set to zero. Then the axis must move to this position. Using the datum 1 the zero point is set on the Z mark. But the axis starts to decelerate at this point, and therefore it stops after the mark. A move is used to bring it back to the Z position.

```

SERVO=ON
WDOG=ON
CREEP=1000 'set the search speed
SPEED=5000 'set the return speed
DATUM(1) 'register on Z mark and sets this to datum
WAIT IDLE
MOVEABS (0) 'moves to datum position

```

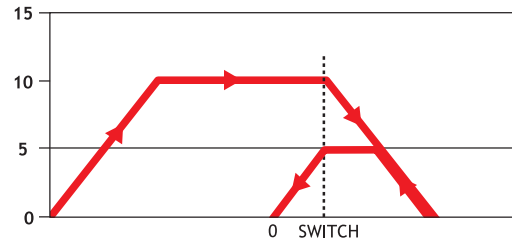

Example A machine must return to its home position defined by the limit switch which is found at the rear of the move before operation. This can be achieved through using **DATUM(4)** which moves in reverse to find the switch.

SERVO=ON

WDOG=ON

REV_IN=-1 'temporarily turn off the limit switch function

DATUM_IN=5 'sets input 5 for registration

SPEED=5000 'set speed, for quick location of limit switch

CREEP=500 'set creep speed for slow move to find edge of switch

DATUM(4) 'find edge at creep speed and stop

WAIT IDLE

DATUM_IN=-1

REV_IN=5 'restore input 5 as a limit switch again

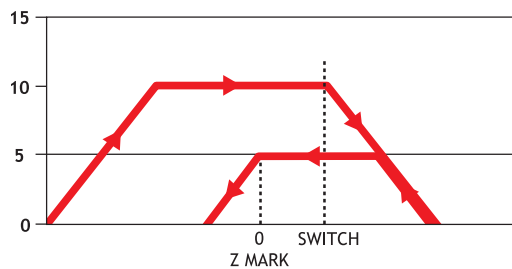

Example	<p>A machine similar to the machine in the example above must locate a home switch, which is at the forward end of the move. The machine then moves backwards to the next Z marker, and set this Z marker as the datum. This is done with DATUM(5), which moves forward at SPEED to locate the switch, then reverses at CREEP to the Z marker. If required, a move is made to the datum Z marker.</p> <p>SERVO=ON WDOG=ON DATUM_IN=7 'sets input 7 as home switch SPEED=5000 'set speed, for quick location of switch CREEP=500 'set creep speed for slow move to find edge of switch DATUM(5) 'start the homing sequence WAIT IDLE</p>
See also	ACCEL, AXIS, AXISSTATUS, CREEP, DATUM_IN, DECEL, MOTION_ERROR, SPEED.

4-2-66 DATUM_IN

Type	Axis parameter
Syntax	DATUM_IN DAT_IN
Description	<p>The DATUM_IN axis parameter contains the input number to be used as the datum switch input for the DATUM command. The valid input range is given by 0 to 31. Values 0 to 15 represent physically present inputs of CJ1W-MCH72 I/O connector and are common for all axes. Values 16 to 31 are mapped directly to driver inputs that are present on the CN1 connector. They are unique for each axis. It depends on the type of Servo Driver which Servo Driver inputs are mapped into inputs 16 to 31. For more information on Servo Driver I/O mapping into the Trajexia I/O space, refer to section 5-1-4.</p> <p>Note: The origin input is active low, i.e., the origin switch is set when the input is OFF. The feedhold, reverse jog, forward jog, forward and reverse limit inputs are also active low. Active low inputs are used to enable fail-safe wiring.</p>
Arguments	N/A
Example	DATUM_IN AXIS(0)=5
See also	AXIS, DATUM.

4-2-67 DECEL

Type	Axis parameter
Syntax	DECEL
Description	The DECEL axis parameter contains the axis deceleration rate. The rate is set in units/s ² . The parameter can have any positive value including 0.
Arguments	N/A
Example	DECEL = 100 ' Set deceleration rate PRINT " Deceleration rate is ";DECEL;" mm/s/s"
See also	ACCEL, AXIS, UNITS.

4-2-68 DEFPOS

Type	Axis command
Syntax	DEFPOS(pos_1 [, pos_2 [, pos_3 [, pos_4 [, ...]]]]) DP(pos_1 [, pos_2 [, pos_3 [, pos_4 [, ...]]]])
Description	<p>The DEFPOS command defines the current demand position (DPOS) as a new absolute position. The measured position (MPOS) will be changed accordingly in order to keep the Following Error. DEFPOS is typically used after an origin search sequence (see DATUM command), as this sets the current position to 0. DEFPOS can be used at any time. As an alternative also the OFFPOS axis parameter can be used. This parameter can be used to perform a relative adjustment of the current position.</p> <p>DEFPOS works on the default basis axis or axis sequence group (set with BASE) unless AXIS is used to specify a temporary base axis.</p> <p>Note: The changes to the axis position made using DEFPOS or OFFPOS are made on the next servo update. This can potentially cause problems when a move is initiated in the same servo period as the DEFPOS or OFFPOS.</p> <p>The following example shows how the OFFPOS parameter can be used to avoid this problem. DEFPOS commands are internally converted into OFFPOS position offsets, which provides an easy way to avoid the problem by programming as follows:</p> <p>DEFPOS(100): WAIT UNTIL OFFPOS = 0: MOVEABS(0)</p>
Arguments	<p>The command can take up to 32 arguments.</p> <ul style="list-style-type: none"> pos_i The absolute position for (base+i) axis in user units. Refer to the BASE command for the grouping of the axes.

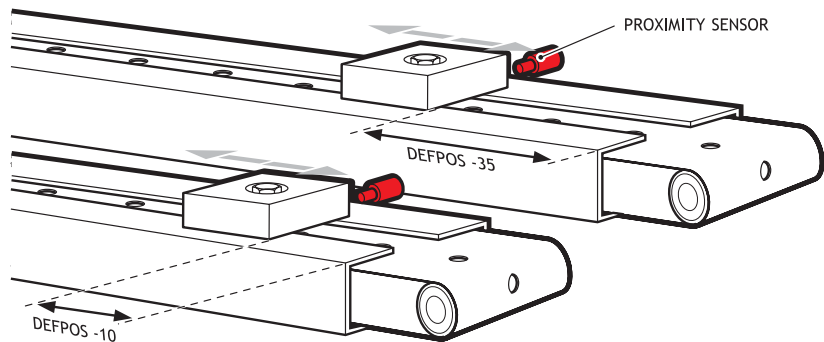

Example After 2 axes returned to their homing positions, it is required to change the **DPOS** values so that the home positions are not zero, but some defined positions instead.

DATUM(5) AXIS(1) ' home both axes. At the end of the DATUM

DATUM(4) AXIS(3) ' procedure, the positions are 0,0.

WAIT IDLE AXIS(1)

WAIT IDLE AXIS(3)

BASE(1,3) ' set up the BASE array

DEFPOS(-10,-35) ' define positions of the axes to be -10 and -35

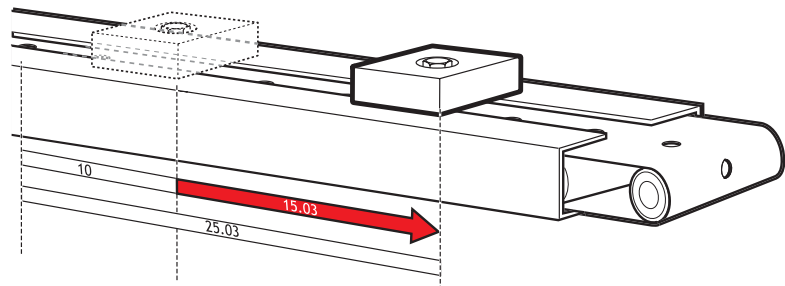

Example Set the axis position to 10, then start an absolute move, but make sure the

axis has updated the position before loading the **MOVEABS**.

DEFPOS(10.0)

WAIT UNTIL OFFPOS=0

' Makes sure that DEFPOS is complete before next line

MOVEABS(25.03)

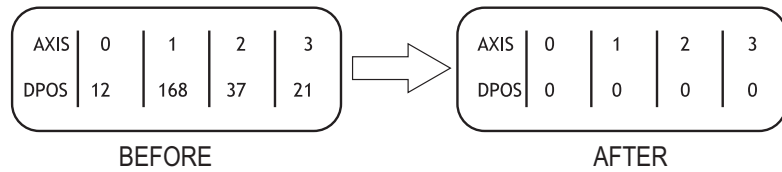

Example From the Command Line of the Terminal window, quickly set the **DPOS** values of the first four axes to 0.

```
>>BASE(0)
>>DP(0,0,0,0)
```

See also **AXIS, DATUM, DPOS, OFFPOS, MPOS, UNITS.**

4-2-69 DEL

Type Program command

Syntax **DEL [program_name]**
RM [program_name]

Description The **DEL** command deletes a program from the controller. **DEL** without a program name can be used to delete the currently selected program (using **SELECT**). The program name can also be specified without quotes. **DEL ALL** will delete all programs.

DEL can also be used to delete the Table: **DEL "TABLE"**. The name **"TABLE"** must be in quotes.

Note: This command is implemented for the Command Line Terminal.

Arguments

- **program_name**
Name of the program to be deleted.

Example **>> DEL oldprog**

See also **COPY, NEW, RENAME, SELECT, TABLE.**

4-2-70 DEMAND_EDGES

Type Axis parameter (read-only)

Syntax **DEMAND_EDGES**

Description The **DEMAND_EDGES** axis parameter contains the current value of the **DPOS** axis parameter in encoder edge units.

Arguments N/A

Example No example.

See also **AXIS, DPOS.**

4-2-71 DIR

Type	Program command
Syntax	DIR LS
Description	The DIR command shows a list of the programs held in the controller, the memory size and the RUNTYPE . DIR also shows the available memory size, power up mode and current selected program of the controller. Note: This command is implemented for the Command Line Terminal only.
Arguments	N/A
Example	No example.
See also	FREE, POWER_UP, PROCESS, RUNTYPE, SELECT.

4-2-72 DISABLE_GROUP

Type	Axis command
Syntax	DISABLE_GROUP(-1) DISABLE_GROUP(axis_1 [, axis_2 [, ...]])
Description	The AXIS_ENABLE is used to create a group of axes which will be disabled if there is a motion error in any or more axes in the group. After the group is made, when an error occurs on one they will all have their AXIS_ENABLE set OFF and SERVO set OFF. Multiple groups can be made, although an axis cannot belong to more than one group. All groupings can be cleared using DISABLE_GROUP(-1) . Note: For use with MECHATROLINK-II only.
Arguments	• axis_i A BASIC expression that evaluates to an axis number.
Example	A machine has 2 functionally separate parts, which have their own emergency stop and operator protection guarding. If there is an error on one part of the machine, the other part can continue to run while the cause of the error is removed and the axis group restarted. For this, 2 separate axis groupings must be set up. DISABLE_GROUP(-1) ' remove any previous axis groupings DISABLE_GROUP(0,1,2,6) ' group axes 0 to 2 and 6 DISABLE_GROUP(3,4,5,7) ' group axes 3 to 5 and 7 WDOG=ON ' turn on the enable relay and the remote drive enable FOR ax=0 TO 7 AXIS_ENABLE AXIS(ax)=ON ' enable the 8 axes SERVO AXIS(ax)=ON ' start position loop servo for each axis NEXT ax

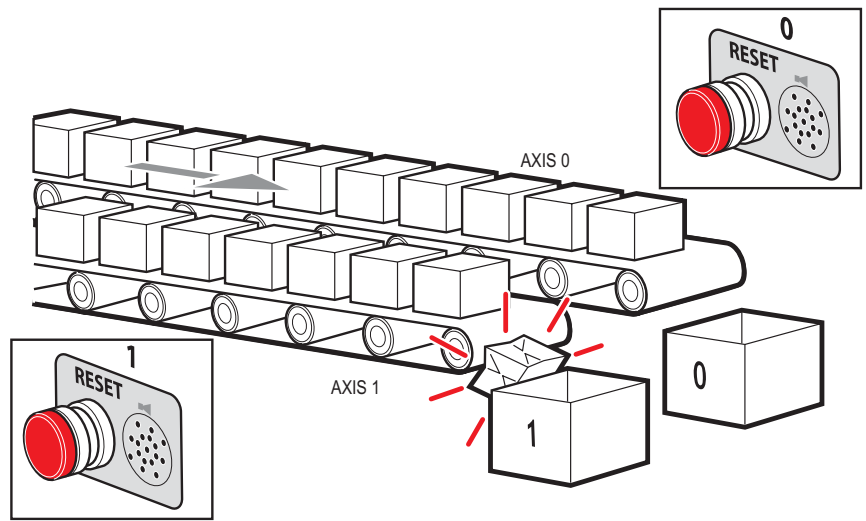

Example Two conveyors operated by the same Motion Coordinator are required to run independently, to make sure that the second conveyor does not stop if the first conveyor is blocked.

```
DISABLE_GROUP(0) 'put axis 0 in its own group
DISABLE_GROUP(1) 'put axis 1 in another group
GOSUB group_enable0
GOSUB group_enable1
WDOG=ON
FORWARD AXIS(0)
FORWARD AXIS(1)
WHILE TRUE
  IF AXIS_ENABLE AXIS(0)=0 THEN
    PRINT "motion error axis 0"
    reset_0_flag=1
  ENDIF
  IF AXIS_ENABLE AXIS(1)=0 THEN
    PRINT "motion error axis 1"
    reset_1_flag=1
  ENDIF
  IF reset_0_flag=1 AND IN(0)=ON THEN
    GOSUB group_enable0
    FORWARD AXIS(0)
    reset_0_flag=0
  ENDIF
  IF reset_1_flag=1 AND IN(1)=ON THEN
    GOSUB group_enable1
    FORWARD AXIS(1)
    reset_1_flag=0
  ENDIF
WEND
group_enable0:
  BASE(0)
  DATUM(0) ' clear motion error on axis 0
  WA(10)
  AXIS_ENABLE=ON
RETURN
group_enable1:
  BASE(1)

  DATUM(0) ' clear motion error on axis 0
  WA(10)
  AXIS_ENABLE=ON
  SERVO=ON
RETURN
```

Example	<p>One group of axes in a machine must be reset if a motion error occurs, without affecting the remaining axes. This must be done manually by clearing the cause of the error, pressing a button to clear the error flags of the controllers and re-enabling the motion.</p> <pre> DISABLE_GROUP(-1) 'remove any previous axis groupings DISABLE_GROUP(0,1,2) 'group axes 0 to 2 GOSUB group_enable 'enable the axes and clear errors WDOG=ON SPEED=1000 FORWARD WHILE IN(2)=ON check axis 0, but all axes in the group will disable together IF AXIS_ENABLE =0 THEN PRINT "Motion error in group 0" PRINT "Press input 0 to reset" IF IN(0)=0 THEN 'checks if reset button is pressed GOSUB group_enable 'clear errors and enable axis FORWARD 'restarts the motion ENDIF ENDIF WEND STOP 'stop program running into sub routine group_enable: 'Clear group errors and enable axes DATUM(0) 'clear any motion errors WA(10) FOR axis_no=0 TO 2 AXIS_ENABLE AXIS(axis_no)=ON 'enable axes SERVO AXIS(axis_no)=ON 'start position loop servo NEXT axis_no RETURN </pre>
See also	N/A

4-2-73 DPOS

Type	Axis parameter (read-only)
Syntax	DPOS
Description	<p>The DPOS axis parameter contains the demand position in user units, which is generated by the move commands in servo control. When the controller is in open loop (SERVO=OFF), the measured position (MPOS) will be copied to the DPOS in order to maintain a 0 Following Error.</p> <p>The range of the demand position is controlled with the REP_DIST and REP_OPTION axis parameters. The value can be adjusted without doing a move by using the DEFPOS command or OFFPOS axis parameter. DPOS is reset to 0 at start-up or controller reset.</p>
Arguments	N/A
Example	<pre>>> PRINT DPOS AXIS(0)</pre> <p>34.0000</p> <p>The above line will return the demand position in user units.</p>
See also	AXIS, DPOS, DEFPOS, DEMAND_EDGES, FE, MPOS, REP_DIST, REP_OPTION, OFFPOS, UNITS.

4-2-74 DRIVE_ALARM

Type	Axis command
Syntax	DRIVE_ALARM(VR [,alarm_number])
Description	<p>The DRIVE_ALARM function reads the current alarm of the Servo Driver that is connected to the Trajexia system via MECHATROLINK-II. Upon successful execution, the command returns -1 and stores the value in the VR memory location specified by the VR parameter. If the command cannot be executed, the value 0 is returned. The command is executed on the driver for the base axis set by BASE. The base axis can be changed with the AXIS modifier, as with all the other axis commands and parameters.</p> <p>This command waits for the response from the axis, The execution of the command can be slow and variable in time. If you require a quick response do not use this command.</p>
Arguments	<ul style="list-style-type: none"> • VR The alarm value is stored on the VR address on successful execution. • alarm_number Optional parameter to set which alarm to read. 0 means the last alarm (default), 1 means the penultimate alarm, etc. alarm_number ranges from 0 to 9.
Example	<pre>IF NOT DRIVE_ALARM(10) AXIS(2)THEN PRINT "Failed to readalarm for Servo Driver" ELSE IF VR(10) = 0THEN PRINT "ServoDriver healthy" ELSE PRINT "Servoalarm code: "; VR(10) ENDIF ENDIF</pre> <p>This example reads an alarm of the Servo Driver driving axis 2 and present that information to the user.</p>
See also	N/A

4-2-75 DRIVE_CLEAR

Type	Axis command
Syntax	DRIVE_CLEAR
Description	<p>The DRIVE_CLEAR command clears the alarm status of the Servo Driver connected via the MECHATROLINK-II bus. This command is not capable of clearing all the possible alarm states. Some alarms can only be cancelled by turning off the power supply (both the CJ1W-MCH72 and the Servo Driver), and then turning it on again. Also, an alarm will not be cleared if the cause of the alarm is still present. The command is executed on the driver for the base axis set by BASE. The base axis can be changed with the AXIS modifier, as with all the other axis commands and parameters.</p>
Arguments	N/A
Example	No example.
See also	DRIVE_STATUS.

 **Caution** Be sure that no Parameter Unit or Personal Computer Software is connected to the Servo Driver when executing this command. Otherwise the program task will be paused until the connection of the other device to the Servo Driver is removed.

4-2-76 DRIVE_CONTROL

Type Axis parameter
 Syntax **DRIVE_CONTROL**
 Description When applied to an axis driven by the Servo Driver connected to the system via the MECHATROLINK-II bus, this parameter selects the data to be monitored by **DRIVE_MONITOR** according to the table below.

Code	Description
2	Following error (this is the real FE when ATYPE=40 is used)
8	Feedback speed (With ATYPE=41 Units=Max Speed/40000000H, with other ATYPE Units= reference units/s)
9	Command speed (units same as in Feedback Speed)
10	Target speed (units same as in Feedback Speed)
11	Torque (Force) reference (With ATYPE=42 Units=Max Torque/40000000H, with other ATYPE Units= % over nominal Torque)
14	Monitor selected with Pn813.0 Useful to monitor servo monitors (Unxxx)
15	Monitor selected with Pn813.1 Useful to monitor servo monitors (Unxxx)

When applied to an axis driven by the Servo Driver connected to the system via the Encoder Interface, this parameter sets outputs of the Encoder Interface. Set bit 8 of this parameter to switch on OUT 0 for an axis. Set bit 9 of this parameter to switch on OUT 1 for an axis. Keep in mind that the same outputs are used by the **HW_PSWITCH** command. The command is executed on the driver for the base axis set by BASE. The base axis can be changed with the AXIS modifier, as with all the other axis commands and parameters.

Arguments N/A
 Example **DRIVE_CONTROL AXIS(2) = 256**
 In this example, OUT 0 is switched on for axis 2, connected using the Encoder Interface.
 See also N/A

4-2-77 DRIVE_INPUTS

Type Axis parameter
 Syntax **DRIVE_INPUTS**
 Description This parameter monitors the status of the inputs of the Servo Driver connected via the MECHATROLINK-II bus. The parameter value is updated each **SERVO_PERIOD** cycle. It is a bit-wise word with the bits as listed in the table below.

Bit number	Servo Driver input signal				Description
	Sigma-II	Sigma-V	Junma	G-Series	
0	P_OT	P_OT	P_OT	P_OT	Forward limit switch
1	N_OT	N_OT	N_OT	N_OT	Reverse limit switch
2	DEC	DEC	/DEC	DEC	Zero point return deceleration
3	PA	PA	Not used	Not used	Encoder A phase signal
4	PB	PB	Not used	Not used	Encoder B phase signal
5	PC	PC	Not used	PC	Encoder Z phase signal
6	EXT1	EXT1	/EXT1	EXT1	First external latch signal
7	EXT2	EXT2	Not used	EXT2	Second external latch signal
8	EXT3	EXT3	Not used	EXT3	Third external latch signal
9	BRK	BRK	/BRK	BRK	Brake output
10	Reserved	HBB	E-STP	E-STP	Emergency stop switch
11	Reserved	Reserved	Not used	SI2	General input 2
12	IO12	IO12	Not used	PCL	General input 12 (Sigma-II and Sigma-V), Torque limit input in positive direction (GN)
13	IO13	IO13	Not used	NCL	General input 13 (Sigma-II and Sigma-V), Torque limit input in negative direction (GN)
14	IO14	IO14	Not used	SI0	General input 14 (Sigma-II and Sigma-V), General input 0 (GN)
15	IO15	IO15	Not used	SI1	General input 15 (Sigma-II and Sigma-V), General input 1 (GN)

The recommended setting is for Sigma-II type Servo Driver: Pn81E=4321 & Pn511=654x. Refer to section 5-1-4 for more information about mapping Servo Driver inputs and outputs.

The command is executed on the driver for the base axis set by BASE. The base axis can be changed with the AXIS modifier, as with all the other axis commands and parameters.

Arguments N/A

Example	No example.
See also	N/A

4-2-78 DRIVE_MONITOR

Type	Axis parameter
Syntax	DRIVE_MONITOR
Description	This parameter contains the monitored data of the Servo Driver connected to the system via the MECHATROLINK-II bus. The data to be monitored is selected using DRIVE_CONTROL and can be displayed in the Trajexia Studio scope or used inside a program. The monitored data is updated each SERVO_PERIOD . The command is executed on the driver for the base axis set by BASE . The base axis can be changed with the AXIS modifier, as with all the other axis commands and parameters.
Arguments	N/A
Example	No example.
See also	N/A

4-2-79 DRIVE_READ

Type	Axis command
Syntax	DRIVE_READ(parameter, size, VR)
Description	<p>The DRIVE_READ function reads the specified parameter of the Servo Driver connected to the Trajexia system via the MECHATROLINK-II bus. Upon successful execution, this command returns -1 and puts the read value in the VR memory location specified by the VR parameter. If the command cannot be executed, the value 0 is returned. The command is executed on the driver for the base axis set with BASE. It can be changed using the AXIS modifier, like with all the other axis commands and parameters.</p> <p>Note: This command waits for the response of the axis, therefore its execution is slow and the time variable. Do not use this command together with other commands that require quick execution.</p> <p>Note: Executing a DRIVE_READ will temporarily disable the Servo Driver Front Panel display.</p> <p>Note: DRIVE_READ returns -1 on success. It also returns -1 with no parameter read if the parameter number does not exist or has the wrong size.</p>
Arguments	<ul style="list-style-type: none"> • parameter The number of the parameter to be read. Note that the parameter numbers are hexadecimal. The format of the data can be found in the Servo Driver manual. • size Size of the parameter is specified in bytes. For most parameters the size is normally 2 bytes. Some special parameters may be 4 bytes long. Sizes for each parameter can be found in the Servo Driver manual. • VR The VR address where the read parameter is stored upon successful execution.

Example **IF DRIVE_READ(\$100,2,1) THEN**
 PRINT "The Speed loop gain is: ";VR(1)
 ELSE
 PRINT "The speed loop gain could not be read"
 ENDIF

See also **DRIVE_WRITE, HEX, \$ (HEXADECIMAL INPUT).**

 **Caution** Be sure that no Parameter Unit or Personal Computer Software is connected to the Servo Driver when executing this command. Otherwise the program task will be paused until the connection of the other device to the Servo Driver is removed.

4-2-80 DRIVE_RESET

Type Axis command

Syntax **DRIVE_RESET**

Description The **DRIVE_RESET** command resets the Servo Driver connected via the MECHATROLINK-II bus. The command is executed on the driver for the base axis set by BASE. The base axis can be changed with the AXIS modifier, as with all the other axis commands and parameters.

Arguments N/A

Example No example.

See also N/A

 **Caution** Be sure that no Parameter Unit or Personal Computer Software is connected to the Servo Driver when executing this command. Otherwise the program task will be paused until the connection of the other device to the Servo Driver is removed.

4-2-81 DRIVE_STATUS

Type Axis parameter (read-only)

Syntax **DRIVE_STATUS**

Description For MECHATROLINK-II axes, this parameter is set from the STATUS field in the MECHATROLINK-II communication frame and is updated every servo period. Those bits can be seen in the drive configuration window in Trajexia Studio, and can be used in programs. The explanation of each bit is given in the table below. (Note: Only bits relevant to MECHATROLINK-II axes are listed.) For the detailed explanation for these status bits, see the MECHATROLINK-II manual.

Bit	Description (MECHATROLINK-II)
0	Alarm
1	Warning
2	Ready
3	Servo on
4	Power on
5	Machine Lock
6	Home Position
7	At Position/Speed

Bit	Description (MECHATROLINK-II)
8	Output Completed
9	Torque Limit
10	Latch Completed
11	In Range/Speed Limit

For Flexible Axis axes, this parameter holds the status of registration and auxiliary inputs, as well as registration selection. The explanation of each bit is given in the second table below. (Note: Only bits relevant to Flexible axis are listed.)

Bit	Description (Flexible Axis)
0	MARK
1	MARKB
2	REG 0 selected current value
3	REG 1 selected current value
5	REG 0 current value
6	REG 1 current value

Arguments N/A

Example **PRINT DRIVE_STATUS AXIS(4)**

This command will print the current value of **DRIVE_STATUS** for axis(4).

Example **BASE(3)**

ATYPE = 44

IF (DRIVE_STATUS AND 32)= 32 THEN

PRINT "REG 0 input is ON for axis(3)"

ENDIF

See also **AXIS, MARK, MARKB, REGIST.**

4-2-82 DRIVE_WRITE

Type	Axis command
Syntax	DRIVE_WRITE(parameter, size, value [,mode])
Description	<p>The DRIVE_WRITE function writes to the specified parameter of the Servo Driver via the MECHATROLINK-II bus. Upon successful execution, this command returns -1. If the command cannot be executed, the value 0 is returned. The command is executed on the driver for the base axis set with BASE. It can be changed using the AXIS modifier, as with all other axis commands and parameters. For some parameters to be written the driver needs to be powered off and on again. The DRIVE_RESET command can be used for that purpose.</p> <p>Note: This command waits for the response of the axis so, its execution is slow and the time variable. Do not use this command together with other commands that require quick execution.</p> <p>Note: Executing a DRIVE_WRITE will temporarily disable the Servo Driver Front Panel display.</p> <p>Note: DRIVE_WRITE returns -1 on success. It also returns -1 with no parameter read if the parameter number does not exist or has the wrong size.</p>
Arguments	<ul style="list-style-type: none"> • parameter The number of the parameter to write to. Note that the parameter numbers are hexadecimal. The format of the data can be found in the Refer to the Servo Driver manual for the format of the data. • size Size of the parameter is specified in bytes. For most parameters the size is normally 2 bytes. Some special parameters may be 4 bytes long. Sizes for each parameter can be found in the Servo Driver manual. • value The value to be written into driver parameter. • mode The write mode. Possible values: 0 (or omitted) - write and store in RAM; 1 - write and store in EPROM.
Example	<pre>IF DRIVE_WRITE(\$100,2,90) THEN PRINT "The new speed loop gain is: 90" ELSE PRINT "The speed loop gain could not be written in RAM" ENDIF</pre>
See also	<ul style="list-style-type: none"> • DRIVE_READ, DRIVE_RESET, \$ (HEXADECIMAL INPUT)

 **Caution** Be sure that no Parameter Unit or Personal Computer Software is connected to the Servo Driver when executing this command. Otherwise the program task will be paused until the connection of the other device to the Servo Driver is removed.

4-2-83 EDIT

Type	Program command
Syntax	EDIT [line_number] ED [line_number]
Description	The EDIT command starts the built in screen editor allowing a program in the controller to be modified using a Command Line Terminal. The currently selected program will be edited. The editor commands are as follows: <ul style="list-style-type: none"> • Quit Editor: [CTRL] K and D • Delete Line: [CTRL] Y This command is implemented for a Command Line Terminal.
Arguments	<ul style="list-style-type: none"> • line_number The number of the line at which to start editing.
Example	No example.
See also	SELECT.

4-2-84 ELSE

See **IF..THEN..ELSE..ENDIF.**

4-2-85 ELSEIF

See **IF..THEN..ELSE..ENDIF.**

4-2-86 ENCODER

Type	Axis parameter (read-only)
Syntax	ENCODER
Description	The ENCODER axis parameter contains a raw copy of the encoder hardware register or the raw data received from the drive via MECHATROLINK-II. On axes with absolute encoders, the ENCODER parameter contains a value using a number of bits programmed with ENCODER_BITS. The MPOS axis parameter contains the measured position calculated from the ENCODER value automatically, allowing for overflows and offsets.
Arguments	N/A
Example	No example.
See also	AXIS, MPOS.

4-2-87 ENCODER_BITS

Type	Axis parameter
Syntax	ENCODER_BITS = value
Description	<p>This axis parameter configures the interface for the number of encoder bits for Flexible axis SSI and EnDat absolute encoder axes. The parameter is applicable only to axes of ATYPE values 47 and 48.</p> <p>When applied to Flexible axis EnDat absolute encoder axis, bits 0 - 7 of the parameter should be set to the total number of encoder bits. Bits 8 - 14 should be set to the number of multi-turn bits to be used.</p> <p>When applied to Flexible axis SSI absolute encoder axis, bits 0 - 5 of the parameter should be set to the number of encoder bits. Bit 6 should be 1 for binary operation, or 0 for Gray code.</p> <p>For SSI encoders of the "Balluff" brand bits 8..10 allow an additional hardware shift to be specified. Normally bits 8..10 are 0.</p> <p>Note: If using Flexible axis absolute encoder axis, it is essential to set this parameter for the axis before setting the ATYPE.</p>
Arguments	N/A
Example	<p>ENCODER_BITS = 25 + (256 * 12) ATYPE = 47</p> <p>In this example a 25 bit EnDat encoder is used, that has 12 bits for multi-turn value and 13 bits per one revolution.</p>
Example	<p>ENCODER_BITS = 12 + (64 * 1) ATYPE = 48</p> <p>In this example a 12 bit (4096 positions per revolution) SSI encoder is used, with binary output type.</p>
See also	AXIS .

4-2-88 ENCODER_CONTROL

Type	Axis parameter
Syntax	ENCODER_CONTROL = value
Description	<p>The ENCODER_CONTROL parameter is applicable only to Flexible axis absolute EnDat axis with ATYPE value 47. The parameter controls the mode in which EnDat encoder return its position. The encoder can be set to either cyclically return its position, or it can be set to a parameter read/write mode. The default after initialization is cyclic position return mode. For more information see EnDat absolute encoder interface specification.</p>
Arguments	N/A
Example	<p>ENCODER_CONTROL AXIS(1) = 0</p> <p>This command sets cyclic position return mode.</p>
Example	<p>ENCODER_CONTROL AXIS(1) = 1</p> <p>This command sets parameter read/write mode.</p>
See also	AXIS, ENCODER, ENCODER_BITS .

4-2-89 ENCODER_RATIO

Type	Axis parameter
Syntax	ENCODER_RATIO(denominator, numerator)
Description	<p>This command allows the incoming encoder count to be scaled by a non integer number, using the equation:</p> $\mathbf{MPOS = (numerator / demoninator) \times encoder_edges_input}$ <p>Unlike the UNITS parameters, ENCODER_RATIO affects commands like MOVECIRC and CAMBOX, since it affects the number of encoder edges within the servo loop at the low level. It is necessary to change the position loop gains after changing encoder ratio in order to maintain performance and stability.</p> <p>Note: Large ratios should be avoided as they will lead to either loss of resolution or much reduced smoothness in the motion. The actual physical encoder count is the basic resolution of the axis and the use of this command may reduce the ability of the Motion Controller to accurately achieve all positions.</p> <p>Note: ENCODER_RATIO does not replace UNITS. Only use ENCODER_RATIO where absolutely necessary. For all other axis scaling use UNITS.</p>
Arguments	<ul style="list-style-type: none"> • denominator A number between 0 and 16777215 that is used to define the denominator in the above equation. • numerator A number between 0 and 16777215 that is used to define the numerator in the above equation.
Example	<p>' 7200 is the closest to the encoder resolution that can be devided by an integer to give degrees. (7200/20=360)</p> <p>ENCODER_RATIO(8192,7200)</p> <p>UNITS=20 ' axis calibrated in degrees, resolution is 0.05 deg.</p> <p>A rotary table has a servo motor connected directly to its centre of rotation. An encoder is mounted to the rear of the servo motor and returns a value of 8192 counts per revolution. The application requires the table to be calibrated in degrees, but so that one degree is an integer number of counts.</p>
See also	N/A

4-2-90 ENCODER_READ

Type	Axis command
Syntax	ENCODER_READ(address)
Description	The ENCODER_READ command is applicable only to Flexible axis absolute EnDat axis with ATYPE value 47. The parameter returns a 16-bit encoder parameter stored at specified address. Bits 8 -15 of the address are the EnDat MRS field settings and bits 0 - 7 are the offset within the EnDat MRS block. If a CRC error occurs, this command will return -1. For more information see EnDat absolute encoder interface specification.
Arguments	<ul style="list-style-type: none">• address Specifies the EnDat MRS field to read.
Example	VR(100) = ENCODER_READ(\$A10D) AXIS(7) This command will read the number of encoder bits and put that value in VR(100) memory location.
See also	AXIS, ENCODER, ENCODER_BITS.

4-2-91 ENCODER_TURNS

Type	Axis parameter (read-only)
Syntax	ENCODER_TURNS
Description	The ENCODER_TURNS parameter returns the number of multi-turn count from the encoder. This is applicable only to Flexible axis absolute EnDat axis with ATYPE value 47. The multi-turn data is not automatically applied to the axis MPOS parameter after initialization. The application programmer must apply this from the program using OFFPOS or DEFPOS commands as required. If applied to axis of ATYPE value other than 47, the parameter returns 0.
Arguments	N/A
Example	PRINT ENCODER_TURNS AXIS (1) This command will print absolute encoder multi-turn counts for axis 1.
See also	AXIS, ENCODER, ENCODER_BITS.

4-2-92 ENCODER_WRITE

Type	Axis command
Syntax	ENCODER_WRITE(address, value)
Description	The ENCODER_WRITE command is applicable only to Flexible axis absolute EnDat axis with ATYPE value 47. The command writes to an encoder parameter specified by the address. Bits 8 -15 of the address are the EnDat MRS field settings and bits 0 - 7 are the offset within the EnDat MRS block. If a CRC error occurs, this command will return 0. Writing to address 0 performs an encoder reset function. For more information see EnDat absolute encoder interface specification. In order to successfully write an encoder parameter with this command, the ENCODER_CONTROL parameter must be set to 1, encoder parameter read/write mode.
Arguments	<ul style="list-style-type: none"> • address Specifies the EnDat MRS field to write to. • value Any valid BASIC expression.
Example	No example.
See also	AXIS, ENCODER, ENCODER_BITS, ENCODER_CONTROL.

4-2-93 ENDIF

See **IF..THEN..ELSE..ENDIF.**

4-2-94 ENDMOVE

Type	Axis parameter
Syntax	ENDMOVE
Description	<p>The ENDMOVE axis parameter holds the position of the end of the current move in user units. If the SERVO axis parameter is ON, the ENDMOVE parameter can be written to produce a step change in the demand position (DPOS).</p> <p>Note: As the measured position is not changed initially, the Following Error limit (FE_LIMIT) should be considered when writing to ENDMOVE to produce a step change. If the change of demanded position is too big, the limit will be exceeded.</p>
Arguments	N/A
Example	No example.
See also	AXIS, DPOS, FE_LIMIT, UNITS.

4-2-95 EPROM

Type	Program command
Syntax	EPROM
Description	The EPROM command stores the BASIC programs in the CJ1W-MCH72 battery backed up RAM memory in the flash EPROM memory. Whether the programs stored in the flash EPROM memory are copied to RAM at start-up is controlled by the POWER_UP system parameter. Note: Trajexia Studio offers this command as a command on the Online menu.
Arguments	N/A
Example	No example.
See also	POWER_UP, RUNTYPE.

4-2-96 ERROR_AXIS

Type	System parameter (read-only)
Syntax	ERROR_AXIS
Description	The ERROR_AXIS axis parameter contains the number of the axis which has caused the motion error. A motion error occurs when the AXISSTATUS state for one of the axes matches the ERRORMASK setting. In this case the enable switch (WDOG) will be turned off, the MOTION_ERROR parameter will have value different than 0 and the ERROR_AXIS parameter will contain the number of the first axis to have the error. Note: The value of ERROR_AXIS is not cleared when the error condition is fixed. It is only changed when a new error occurs.
Arguments	N/A
Example	No example.
See also	AXISSTATUS, ERRORMASK, MOTION_ERROR, WDOG.

4-2-97 ERROR_LINE

Type	Task parameter (read-only)
Syntax	ERROR_LINE
Description	The ERROR_LINE parameter contains the number of the line which caused the last BASIC run-time error in the program task. This value is only valid when the BASICERROR parameter is TRUE . Each task has its own ERROR_LINE parameter. Use the PROC modifier to access the parameter for a certain task. Without PROC , the current task will be assumed.
Arguments	N/A
Example	>> PRINT ERROR_LINE PROC(4) 23.0000
See also	BASICERROR, PROC, RUN_ERROR.

4-2-98 ERRORMASK

Type	Axis parameter
Syntax	ERRORMASK
Description	<p>The ERRORMASK axis parameter contains a mask value that is ANDed bit by bit with the AXISSTATUS axis parameter on every servo cycle to determine if a motion error has occurred. If the result of the AND operation is not zero, the motion error has occurred.</p> <p>When a motion error occurs the enable switch (WDOG) will be turned off, the MOTION_ERROR parameter will have value different than 0 and the ERROR_AXIS parameter will contain the number of the first axis to have the error.</p> <p>Check the AXISVALUES parameter for the status bit allocations. The default setting of ERRORMASK is 268.</p>
Arguments	N/A
Example	No example.
See also	AXIS, AXISSTATUS, MOTION_ERROR, WDOG.

 **Caution** It is up to the user to define in which cases a motion error is generated. For safe operation it is strongly recommended to generate a motion error when the Following Error has exceeded its limit in all cases. This is done by setting bit 8 of **ERRORMASK**

4-2-99 EX

Type	System command
Syntax	EX[(option)]
Description	<p>Resets the controller as if it were being powered up again.</p> <p>There are two types of reset performed by the EX command. EX without the argument, or EX(0) does the software reset of the controller. EX(1) does the hardware reset of the controller</p>
Arguments	N/A
Example	No example.
See also	N/A

4-2-100 EXP

Type	Mathematical function
Syntax	EXP(expression)
Description	The EXP function returns the exponential value of the expression.
Arguments	<ul style="list-style-type: none"> • expression Any valid BASIC expression.
Example	<pre>>>PRINT EXP(1.0) 2.7183</pre>
See also	N/A

4-2-101 FALSE

Type	Constant (read-only)
Syntax	FALSE
Description	The FALSE constant returns the numerical value 0.
Arguments	N/A
Example	test: res = IN(0) OR IN(2) IF res = FALSE THEN PRINT "Inputs are off" ENDIF
See also	N/A

4-2-102 FAST_JOG

Type	Axis parameter
Syntax	FAST_JOG
Description	The FAST_JOG axis parameter contains the input number to be used as the fast jog input. The number can be from 0 to 31. As default the parameter is set to -1, no input is used for the fast jog. The fast jog input controls the jog speed between two speeds. If the fast jog input is set, the speed as given by the SPEED axis parameter will be used for jogging. If the input is not set, the speed given by the JOGSPEED axis parameter will be used. Note: This input is active low.
Arguments	N/A
Example	No example.
See also	AXIS, FWD_JOG, JOGSPEED, REV_JOG, SPEED.

4-2-103 FASTDEC

Type	Axis parameter
Syntax	FASTDEC
Description	The FASTDEC axis parameter contains fast deceleration ration. Its default value is zero. If a non-zero FASTDEC is specified, the axis will ramp to zero at this deceleration rate when an axis limit switch or position is reached.
Arguments	N/A
Example	No example.
See also	N/A

4-2-104 FE

Type	Axis parameter (read-only)
Syntax	FE
Description	The FE axis parameter contains the position error in user units. This is calculated by the demand position (DPOS axis parameter) minus the measured position (MPOS axis parameter). The value of the Following Error can be checked by using the axis parameters FE_LIMIT and FE_RANGE .
Arguments	N/A
Example	No example.
See also	AXIS, DPOS, FE_LIMIT, FE_RANGE, MPOS, UNITS.

4-2-105 FE_LATCH

Type	Axis parameter (read-only)
Syntax	FE_LATCH
Description	Contains the initial FE value which caused the axis to put the controller into MOTION_ERROR. This value is only set when the FE exceeds the FE_LIMIT and the SERVO parameter has been set to OFF. FE_LATCH is reset to 0 when the SERVO parameter of the axis is set back to ON.
Arguments	N/A
Example	No example.
See also	N/A

4-2-106 FE_LIMIT

Type	Axis parameter
Syntax	FE_LIMIT FELIMIT
Description	The FE_LIMIT axis parameter contains the maximum allowed Following Error in user units. When exceeded, bit 8 of the AXISSTATUS parameter of the axis will be set. If the ERRORMASK parameter has been properly set, a motion error will be generated and WDOG enable relay will be reset to 0. This limit is used to guard against fault conditions, such as mechanical lock-up, loss of encoder feedback, etc.
Arguments	N/A
Example	No example.
See also	AXIS, AXISSTATUS, ERRORMASK, FE, FE_RANGE, UNITS.

4-2-107 FE_LIMIT_MODE

Type	Axis parameter
Syntax	FE_LIMIT_MODE=value
Description	<p>When this parameter is set to 0, the axis will cause a MOTION_ERROR immediately when the FE exceeds the FE_LIMIT value.</p> <p>If FE_LIMIT_MODE is set to 1, the axis will only generate a MOTION_ERROR when the FE exceeds FE_LIMIT during 2 consecutive servo periods. This means that if FE_LIMIT is exceeded for one servo period only, it will be ignored.</p> <p>The default value for FE_LIMIT_MODE is 0.</p>
Arguments	N/A
Example	No example.
See also	N/A

4-2-108 FE_RANGE

Type	Axis parameter
Syntax	FE_RANGE
Description	<p>The FE_RANGE axis parameter contains the limit for the Following Error warning range in user units. When the Following Error exceeds this value on a servo axis, bit 1 in the AXISSTATUS axis parameter will be turned on.</p> <p>This range is used as a first indication for fault conditions in the application (compare FE_LIMIT).</p>
Arguments	N/A
Example	No example.
See also	AXIS, AXISSTATUS, ERRORMASK, FE, UNITS.

4-2-109 FHOLD_IN

Type	Axis parameter
Syntax	FHOLD_IN FH_IN
Description	<p>The FHOLD_IN axis parameter contains the input number to be used as the feedhold input. The valid input range is 0 to 31. Values 0 to 15 represent physically present inputs of CJ1W-MCH72 I/O connector and are common for all axes.</p> <p>Values 16 to 31 are mapped directly to driver inputs that are present on the CN1 connector. They are unique for each axis. It depends on the type of Servo Driver which Servo Driver inputs are mapped into inputs 16 to 31. For more information on Servo Driver I/O mapping into the Trajexia I/O space, refer to section 5-1-4.</p> <p>As default the parameter is set to -1, no input is used for feedhold.</p> <p>Note: This input is active low.</p> <p>If an input number is set and the feedhold input turns set, the speed of the move on the axis is changed to the value set in the FHSPEED axis parameter. The current move is not cancelled. Furthermore, bit 7 of the AXISSTATUS parameter is set. When the input turns reset again, any move in progress when the input was set will return to the programmed speed.</p> <p>Note: This feature only works on speed controlled moves. Moves which are not speed controlled (CAMBOX, CONNECT and MOVELINK) are not affected.</p>
Arguments	N/A
Example	No example.
See also	AXIS , AXISSTATUS , FHSPEED , UNITS .

4-2-110 FHSPEED

Type	Axis parameter
Syntax	FHSPEED
Description	<p>The FHSPEED axis parameter contains the feedhold speed. This parameter can be set to a value in user units/s and defines at which speed the axis will move when the feedhold input turns on. The current move is not cancelled. FHSPEED can have any positive value including 0. The default value is 0. This default value is applicable to most applications as motion is usually ramped down to zero speed when the freehold input is set. In some cases it may be desirable for the axis to ramp to a known constant speed when the freehold input is set.</p> <p>Note: This feature only works on speed controlled moves. Moves which are not speed controlled (CAMBOX, CONNECT and MOVELINK) are not affected.</p>
Arguments	N/A
Example	No example.
See also	AXIS , AXISSTATUS , FHOLD_IN , UNITS .

4-2-111 FINS_COMMS

Type	Communication command
Syntax	FINS_COMMS (type, network, node, unit, remote_area, remote_offset, length, local_area, local_offset, timeout)
Description	<p>FINS (Factory Interface Network Service) is a Proprietary OMRON communication protocol. A subset of this protocol has been implemented in Trajexia. The FINS protocol has been implemented with the intention of enabling seamless communication with other OMRON devices (PLCs, HMIs, etc.) and software (CX-Drive, CX-Server, etc.). For more information on FINS communication protocol, see the Communication Commands Reference Manual, cat. num. W342-E1, Sections 3 and 5.</p> <p>Trajexia has built in FINS client capabilities, so it can initiate the FINS communications with FINS slave devices using FINS_COMMS. Only FINS 0101 (Read Memory) and FINS 0102 (Write Memory) commands are implemented. With FINS 0101, memory can be read from other devices with FINS server capability. FINS 0102 can be used to write data to devices with FINS server capability.</p> <p>This command returns one of the following values, depending on outcome of the execution:</p> <ul style="list-style-type: none">-1: The command executed successfully.0: The command failed.1: Request not sent because the client or the FINS protocol is busy.2: One or more of the request parameters are invalid.3: Invalid source memory area.4: Request was sent, but no response from remote server received within timeout period.5: Error response code received from remote server.

- Arguments
- **type**
The type of the FINS command. 0 means FINS 0101, read memory from remote FINS server. 1 means FINS 0102, write memory to the remote server.
 - **network**
The destination network. For more details, see the Communication Commands Reference Manual, cat. num. W342-E1, Section 3.
 - **node**
The node of the destination FINS server. For more details, see the Communication Commands Reference Manual, cat. num. W342-E1, Section 3.
 - **unit**
The unit number of the destination FINS server. For more details, see the Communication Commands Reference Manual, cat. num. W342-E1, Section 3.
 - **remote_area**
The area of memory accessed on the destination FINS server. Range: 128..255. Note that this area must be one of the following values if the destination is another Trajexia system: 0xB0: Integer VR value; 0xF0: float VR value; 0x82: Integer TABLE value; 0xC2: float TABLE value.
 - **remote_offset**
The memory offset on the destination FINS server. Range: 0..65535. Note that this range will be more limited to the maximum TABLE or VR addresses if the destination is another Trajexia system.
 - **length**
The number of items to be transferred. The range will depend upon the FINS frame length and the capabilities of the client and remote servers. The range for a Trajexia system is from 1 to 700 integer values, or 1 to 350 floating point values.
 - **local_area**
The local (source) memory area. Note that this area must be one of the following values: 0x00: Integer VR value; 0x01: Integer TABLE value; 0x02 : float TABLE value.
 - **local_offset**
The offset of the first value in the local (source) memory area. The range depends upon the VR or TABLE array size and value for the length argument.
 - **timeout**
The number of milliseconds to wait for a response from the destination FINS server, before timing out.

Note: Be aware that data types from both **remote_area** and **local_area** have to match (both floating point or both integers).

- Example **FINS_COMMS(0, 0, 0, 0, \$82, 1000, 20, 0, 500, 5000)**
This command reads 20 words (**length=20**) of DM PLC memory area (**remote_area=\$82**), starting from DM1000 (**remote_offset=1000**), and writes it in the CJ1W-MCH72 VR memory in integer format (**local_area=0**), starting from VR(500) (**local_offset=500**). Thus, values in PLC memory range DM1000 to DM1019 are placed in CJ1W-MCH72 memory VR(500) to VR(519). The timeout is set to 5 seconds.

Example	FINS_COMMS(1, 0, 0, 0, \$80, 50, 10, 0, 300, 3000) This command writes 10 words (length=10) of CJ1W-MCH72 VR memory as integers (local_area=0), starting from VR(300) (local_offset=300) to the CIO area of the PLC (remote_area=\$80), starting from CIO50 (remote_offset=50). Thus, the values in the CJ1W-MCH72 memory range VR(300) to VR(309) are placed in memory CIO50 to CIO59 of the PLC. The timeout is set to 3 seconds.
See also	N/A

4-2-112 FLAG

Type	System command
Syntax	FLAG(flag_number [,value])
Description	The FLAG command is used to set and read a bank of 24 flag bits. The FLAG command can be used with one or two parameters. With one parameter specified the status of the given flag bit is returned. With two parameters specified the given flag is set to the value of the second parameter. The FLAG command is provided to aid compatibility with earlier controllers and is not recommended for new programs.
Arguments	<ul style="list-style-type: none"> • flag_number The flag number is a value from 0..23. • value If specified this is the state to set the given flag to i.e. ON or OFF. This can also be written as 1 or 0.
Example	FLAG(21,ON) Set flag bit 21 on.
See also	N/A

4-2-113 FLAGS

Type	System command
Syntax	FLAGS([value])
Description	Read and set the FLAGS as a block. The FLAGS command is provided to aid compatibility with earlier controllers and is not recommended for new programs. The 24 flag bits can be read with FLAGS and set with FLAGS(value) .
Arguments	<ul style="list-style-type: none"> • value The decimal equivalent of the bit pattern to which the flags must be set. See the table below.

Bit number	Decimal value
0	1
1	2
2	4
3	8
4	16
5	32

Bit number	Decimal value
6	64
7	128

Example **FLAGS(146) ' 2 + 16 + 128**
Set Flags 1,4 and 7 on, all others off.

Example **IF (FLAGS and 8) <>0 then GOSUB somewhere**
Test if Flag 3 is set.

See also N/A

4-2-114 FLASHVR

Type System command

Syntax **FLASHVR(option [, flashpage, tablepage])**

Description The **FLASHVR** command is used to store **TABLE** variable data in the flash memory. After the data has been stored, at each power up the **TABLE** data will be restored to the values held in flash memory. The command will write either the entire **TABLE** array or a part (page) of it, depending on the value of the argument option.

Normally, **TABLE** data are preserved in battery backed RAM memory. However, data can be lost if this battery is empty, or if the battery replacement takes too long (longer than 5 minutes). In such cases it is advised to store **TABLE** memory to flash memory, since it is not affected by battery failure.

- Arguments
- **option**
Depending of the value of this argument, either the whole, or just a part of the **TABLE** memory is stored. The valid values for the argument are:
 - 1: The whole **TABLE** memory content is written to flash memory. On power-up the RAM **TABLE** data are replaced by the data saved in flash memory.
 - 2: Stop using data stored in flash to replace RAM **TABLE** data during start-up.
 - 3: Write a page of **TABLE** data into flash memory.
 - 4: Read a page of flash memory into **TABLE** data.
 - **flashpage**
The index number in range [0...31] of a 16k page (512k in total) of the flash memory where the table data is to be stored (option = -3) or retrieved from (option = -4)
 - **tablepage**
The index number in range [0...3] of a 16k page it **TABLE** memory where the table data is to be copied from (option = -3) or restored to (option = -4).

Note: When the **FLASHVR(-1)** is executed, the whole range (all 64000 slots) of the **TABLE** memory is written to the flash memory and restored from flash memory on start-up. If, for example, only 1000 **TABLE** memory in range [0...999] are defined, in which case an attempt to read **TABLE(1000)** would result in "Index range error", executing **FLASHVR(-1)** would write already defined values of **TABLE** memory in range [0...999] into the flash memory, but also all other **TABLE** memory slots in range [1000...63999] will be written to the flash memory with undefined values. On start-up, the whole range of **TABLE** memory [0...63999] would be restored from flash memory, so for example an attempt to read previously undefined slot **TABLE(1000)** would succeed, but the value is undefined. The similar behaviour applies to executing **FLASHVR(-4, flashpage, tablepage)**. If the current defined range of the **TABLE** memory is narrower than the one of the retrieved data, the range of **TABLE** memory will be extended automatically.

Note: **FLASHVR(-1)** writes the whole range (all 64000 slots) of the **TABLE** memory in flash memory starting from flashpage 0. Once **FLASHVR(-2)** is executed, the RAM **TABLE** data are not replaced on start-up by the data saved in flash memory, but that data is still available in flash memory, and can be retrieved in any tablepage by using **FLASHVR(-3, flashpage, tablepage)** command.

Note: Each **FLASHVR** command generates a write to a block of the Flash memory. Although this memory allows numerous writes and erases, it has a limited life cycle. Programmers should be aware of this fact and use the command as limited as possible.

	TABLE	FLASH
0 - 15999	tablepage 0	tablepage 0
16000 - 31999	tablepage 1	tablepage 1
32000 - 47999	tablepage 2	tablepage 2
48000 - 63999	tablepage 3	· · ·
		tablepage 3

Example **FLASHVR(-1)**
Store whole **TABLE** memory to flash memory.

Example **FLASHVR(-3,20,3)**
Store table page 3 (**TABLE(48000) - TABLE(63999)**) into flash page 20.
FLASHVR(-4,20,3)
Restore table page 0 (**TABLE(0) - TABLE(15999)**) from flash page 20. This effectively copies data in range **TABLE(48000) - TABLE(63999)** into range **TABLE(0) - TABLE(15999)**.

See also **TABLE**

4-2-115 FOR..TO..STEP..NEXT

Type Program control command

Syntax **FOR variable = start TO end [STEP increment] commands NEXT variable**

Description The **FOR ... NEXT** loop allows the program segment between the **FOR** and the **NEXT** statement to be repeated a number of times. On entering this loop, the variable is initialized to the value of start and the block of commands is then executed. Upon reaching the **NEXT** command, the variable is increased by the increment specified after **STEP**. The **STEP** value can be positive or negative, if omitted the value is assumed to be 1. While variable is less than or equal to end, the block of commands is repeatedly executed until variable is greater than end, at which time program execution will continue after **NEXT**. Note: **FOR ... NEXT** statements can be nested up to 8 levels deep in a BASIC program.

Arguments

- **variable**
Any valid BASIC expression.
- **start**
Any valid BASIC expression.
- **end**
Any valid BASIC expression.
- **increment**
Any valid BASIC expression.
- **commands**
One or more BASIC commands.

Example	<pre>FOR opnum = 8 TO 13 OP(opnum,ON) NEXT opnum</pre> <p>This loop turns on outputs 8 to 13.</p>
Example	<pre>loop: FOR dist = 5 TO -5 STEP -0.25 MOVEABS(dist) GOSUB pick_up NEXT dist</pre> <p>The STEP increment can be positive or negative.</p>
Example	<pre>loop1: FOR I1 = 1 TO 8 loop2: FOR I2 = 1 TO 6 MOVEABS(I1*100,I2*100) GOSUB 1000 NEXT I2 NEXT I1</pre> <p>FOR..TO..STEP..NEXT statements can be nested (up to 8 levels deep) provided the inner FOR and NEXT commands are both within the outer FOR..TO..STEP..NEXT loop.</p>
See also	REPEAT..UNTIL, WHILE..WEND.

4-2-116 FORWARD

Type	Axis command
Syntax	<pre>FORWARD FO</pre>
Description	<p>The FORWARD command moves an axis continuously forward at the speed set in the SPEED axis parameter. The acceleration rate is defined by the ACCEL axis parameter.</p> <p>FORWARD works on the default basis axis (set with BASE) unless AXIS is used to specify a temporary base axis.</p> <p>Note: The forward motion can be stopped by executing the CANCEL or RAPIDSTOP command, or by reaching the forward limit. If stopped by execution of the CANCEL or RAPIDSTOP command, the axis decelerates to a stop at the programmed DECEL rate.</p>
Arguments	N/A

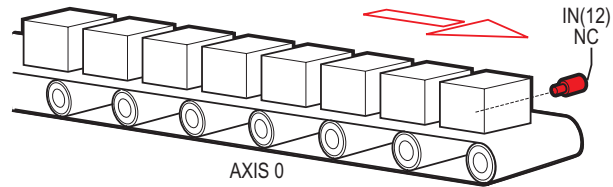

Example Run an axis forwards. When an input signal is detected on input 12, bring the axis to a stop.

```

FORWARD
' wait for stop signal
WAIT UNTIL IN(12)=ON
CANCEL
WAIT IDLE
  
```

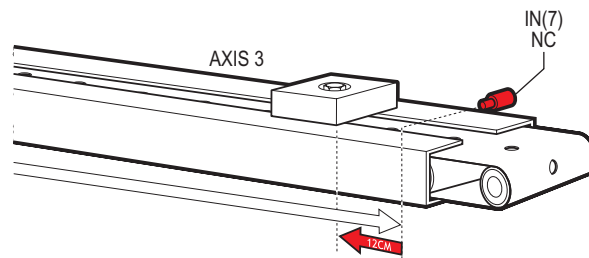

Example Move an axis forward until it hits the end limit switch, then move it in the reverse direction for 25 cm.

```

BASE(3)
FWD_IN=7 limit switch connected to input 7
FORWARD
WAIT IDLE ' wait for motion to stop on the switch
MOVE(-25.0)
WAIT IDLE
  
```

Example A machine that applies lids to cartons uses a simulated line shaft. This example sets up a virtual axis running forward to simulate the line shaft. Axis 0 is then connected, with the **CONNECT** command, to this virtual axis to run the conveyor. Axis 1 controls a vacuum roller that feeds the lids on to the cartons using the **MOVELINK** control.

```

BASE(4)
ATYPE=0 'Set axis 4 to virtual axis
REP_OPTION=1
SERVO=ON
FORWARD 'starts line shaft
BASE(0)
CONNECT(-1,4) 'Connects base 0 to virtual axis in reverse
WHILE IN(2)=ON
  BASE(1)
  'Links axis 1 to the shaft in reverse direction
  MOVELINK(-4000,2000,0,0,4,2,1000)
  WAIT IDLE
WEND
RAPIDSTOP

```

See also **AXIS, CANCEL, RAPIDSTOP, REVERSE, UNITS.**

4-2-117 FPGA_VERSION

Type	Slot parameter
Syntax	FPGA_VERSION
Description	This parameter returns the FPGA version of the CJ1W-MCH72.
Arguments	N/A
Example	N/A
See also	N/A

4-2-118 FRAC

Type	Mathematical function
Syntax	FRAC(expression)
Description	The FRAC function returns the fractional part of the expression.
Arguments	<ul style="list-style-type: none"> expression Any valid BASIC expression.
Example	>> PRINT FRAC(1.234) 0.2340
See also	N/A

4-2-119 FRAME

Type	System parameter
Syntax	FRAME=value
Description	<p>Used to specify which frame to operate within when employing frame transformations. Frame transformations are used to allow movements to be specified in a multi-axis coordinate frame of reference which do not correspond one-to-one with the axes. An example is a SCARA robot arm with jointed axes. For the end tip of the robot arm to perform straight line movements in X-Y the motors need to move in a pattern determined by the robots geometry.</p> <p>Frame transformations to perform functions such as these need to be compiled from C language source and loaded into the controller system software. Contact OMRON if you need to do this.</p> <p>A machine system can be specified with several different frames. The currently active "frame" is specified with the FRAME System parameter. The default FRAME is 0 which corresponds to a one-to-one transformation.</p>
Arguments	N/A
Example	FRAME=1
See also	N/A

4-2-120 FREE

Type	System function
Syntax	FREE
Description	<p>The FREE function returns the remaining amount of memory available for user programs and TABLE array elements.</p> <p>Note: Each line takes a minimum of 4 characters (bytes) in memory. This is for the length of this line, the length of the previous line, number of spaces at the beginning of the line and a single command token. Additional commands need one byte per token; most other data is held as ASCII.</p> <p>The CJ1W-MCH72 compiles programs before they are executed, this means that a little under twice the memory is required to be able to execute a program.</p>
Arguments	N/A
Example	>> PRINT FREE 47104.0000
See also	DIR, TABLE

4-2-121 FS_LIMIT

Type	Axis parameter
Syntax	FS_LIMIT FSLIMIT
Description	<p>The FS_LIMIT axis parameter contains the absolute position of the forward software limit in user units.</p> <p>A software limit for forward movement can be set from the program to control the working range of the machine. When the limit is reached, the CJ1W-MCH72 will ramp down the speed of an axis to 0, and then cancel the move. Bit 9 of the AXISSTATUS axis parameter will be turned on while the axis position is greater than FS_LIMIT.</p> <p>FS_LIMIT is disabled when it has a value greater than REP_DIST.</p>
Arguments	N/A
Example	No example.
See also	AXIS, AXISSTATUS, REP_DIST, UNITS.

4-2-122 FWD_IN

Type	Axis parameter
Syntax	FWD_IN
Description	<p>The FWD_IN axis parameter contains the input number to be used as a forward limit input. The valid input range is 0 to 31. Values 0 to 15 represent physically present inputs of CJ1W-MCH72 I/O connector and are common for all axes.</p> <p>Values 16 to 31 are mapped directly to driver inputs that are present on the CN1 connector. They are unique for each axis. It depends on the type of Servo Driver which Servo Driver inputs are mapped into inputs 16 to 31. For more information on Servo Driver I/O mapping into the Trajexia I/O space, refer to section 5-1-4.</p> <p>For more information on setting driver parameter Pn81E, see Servo Driver manual. As default the parameter is set to -1, no inputs selected. If an input number is set and the limit is reached, any forward motion on that axis will be stopped. Bit 4 of the AXISSTATUS will also be set.</p> <p>Note: This input is active low.</p>
Arguments	N/A
Example	No example.
See also	AXIS, AXISSTATUS, REV_IN.

4-2-123 FWD_JOG

Type	Axis parameter
Syntax	FWD_JOG
Description	<p>The FWD_JOG axis parameter contains the input number to be used as a jog forward input. The input can be set from 0 to 31. As default the parameter is set to -1, no input is selected.</p> <p>Note: This input is active low.</p>
Arguments	N/A

Example No example.
See also **AXIS, FAST_JOG, JOGSPEED, REV_JOG.**

4-2-124 GET

Type I/O command
Syntax **GET [#n,] variable**
Description The **GET** command assigns the ASCII code of a received character to a variable. If the serial port buffer is empty, program execution will be paused until a character has been received. Channels 5 to 7 are logical channels that are superimposed on the programming port 0 when using Trajexia Studio.
Note: Channel 0 is reserved for the connection to Trajexia Studio and/or the command line interface. Please be aware that this channel may give problems for this function.
Arguments

- n**
The specified input device. When this argument is omitted, the port is 0 (Terminal window). See the table below.

Input device number	Description
0	Programming port 0
5	Trajexia Studio port 0 user channel 5
6	Trajexia Studio port 0 user channel 6
7	Trajexia Studio port 0 user channel 7

- variable**
The name of the variable to receive the ASCII code.

Example **GET#5, k**
This line stores the ASCII character received on the Trajexia Studio port channel 5 in **k**.

See also N/A

4-2-125 GLOBAL

Type	System command
Syntax	GLOBAL "name", vr_number
Description	<p>Declares the name as a reference to one of the global VR variables. The name can then be used both within the program containing the GLOBAL definition and all other programs in the Trajexia Studio solution.</p> <p>Note: The program containing the GLOBAL definition must be run before the name is used in other programs. In addition, only that program should be running at the time the GLOBAL is executed, otherwise the program error will appear and the program will stop when trying to execute this command. For fast startup the program should also be the only process running at power-up.</p> <p>When the GLOBAL is declared, the declaration remains active until the next CJ1W-MCH72 reset by switching the power off and back on, or by executing the EX command.</p> <p>In programs that use the defined GLOBAL, name has the same meaning as VR(vr_number). Do not use the syntax: VR(name). A maximum of 128 GLOBALs can be declared.</p>
Arguments	<ul style="list-style-type: none"> • name Any user-defined name containing lower case alpha, numerical or underscore characters. • vr_number The number of the VR to be associated with name.
Example	<pre>GLOBAL "srew_pitch",12 GLOBAL "ratio1",534 ratio1 = 3.56 screw_pitch = 23.0 PRINT screw_pitch, ratio1</pre>
See also	N/A

4-2-126 GOSUB..RETURN

Type	Program control command
Syntax	GOSUB label ... RETURN
Description	<p>The GOSUB structure enables a subroutine jump. GOSUB stores the position of the line after the GOSUB command and then jumps to the specified label. Upon reaching the RETURN statement, program execution is returned to the stored position.</p> <p>Note: Subroutines on each task can be nested up to 8 levels deep.</p>
Arguments	<ul style="list-style-type: none"> • label A valid label that occurs in the program. An invalid label will give a compilation error before execution. Labels can be character strings of any length, but only the first 15 characters are significant. Alternatively line numbers may be used as labels.

Example	<pre> main: GOSUB routine GOTO main routine: PRINT "Measured position=";MPOS;CHR(13); RETURN </pre>
See also	GOTO

4-2-127 GOTO

Type	Program control command
Syntax	GOTO label
Description	The GOTO structure enables a jump of program execution. GOTO jumps program execution to the line of the program containing the label.
Arguments	<ul style="list-style-type: none"> • label A valid label that occurs in the program. An invalid label will give a compilation error before execution. Labels can be character strings of any length, but only the first 15 characters are significant. Alternatively line numbers may be used as labels.
Example	<pre> loop: PRINT "Measured position = ";MPOS;CHR(13); WA(1000) GOTO loop </pre>
See also	GOSUB..RETURN

4-2-128 HALT

Type	System command
Syntax	HALT
Description	<p>The HALT command stops execution of all program tasks currently running. The command can be used both on Command Line Terminal as in programs. The STOP command can be used to stop a single program task.</p> <p>Note: HALT doesn't stop any motion. Currently executing, or buffered moves will continue unless they are terminated with a CANCEL or RAP-IDSTOP command.</p>
Arguments	N/A
Example	No example.
See also	PROCESS, STOP.

4-2-129 HEX

Type	I/O command
Syntax	HEX
Description	This command is used in a print statement to output a number in hexadecimal format.
Arguments	N/A

Example **PRINT#5,HEX(IN(8,16))**
 See also N/A

4-2-130 HW_PSWITCH

Type Axis command

Syntax **HW_PSWITCH(mode, direction, opstate, table_start, table_end)**

Description The **HW_PSWITCH** command turns on digital output 8 for the axis when the predefined axis measured position is reached, and turns the output off when another measured position is reached. Positions are defined as sequence in the TABLE memory in range from **table_start**, to **table_end**, and on execution of the **HW_PSWITCH** command are stored in FIFO queue.
 This command is applicable only to Flexible axis axes with **ATYPE** values 43, 44 and 45.
 The command can be used with either 1 or 5 parameters. Only 1 parameter is needed to disable the switch or clear FIFO queue. All five parameters are needed to enable switch.
 After loading FIFO and going through the sequence of positions in it, if the same sequence has to be executed again, FIFO must be cleared before executing **HW_PSWITCH** command with the same parameters.

Arguments

- **mode**
0 = disable switch; 1 = on and load FIFO; 2 = clear FIFO.
- **direction**
0 = decreasing; 1 = increasing.
- **opstate**
Output state to set in the first position in the FIFO; ON or OFF.
- **table_start**
Starting TABLE address of the sequence.
- **table_end**
Ending TABLE address of the sequence.

Example **HW_PSWITCH(1, 1, ON, 21, 50)**
 This command will load FIFO with 30 positions, stored in TABLE memory starting from **TABLE(21)** in increasing direction. When the position stored in **TABLE(21)** is reached, output 8 will be set ON and then alternatively OFF and ON on reaching following positions in the sequence, until the position stored in **TABLE(50)** reached.

Example **HW_PSWITCH(0)**
 This command will disable switch if it was enabled previously, but will not clear the FIFO queue.

Example **HW_PSWITCH(2)**
 This command will clear FIFO queue if loaded previously.

See also **AXIS**

4-2-131 I_GAIN

Type	Axis parameter
Syntax	I_GAIN
Description	<p>The I_GAIN parameter contains the integral gain for the axis. The integral output contribution is calculated by multiplying the sums of the Following Errors with the value of the I_GAIN parameter. The default value is 0.</p> <p>Adding integral gain to a servo system reduces positioning error when at rest or moving steadily, but it can produce or increase overshooting and oscillation and is therefore only suitable for systems working on constant speed and with slow accelerations.</p> <p>Note: In order to avoid any instability the servo gains should be changed only when the SERVO is off.</p> <p>Note: Servo gains have no affect on stepper output axis, ATYPE=46.</p>
Arguments	N/A
Example	No example.
See also	D_GAIN, OV_GAIN, P_GAIN, VFF_GAIN.

4-2-132 IDLE

See **WAIT IDLE**.

4-2-133 IEEE_IN

Type	Mathematical function
Syntax	IEEE_IN(byte0,byte1,byte2,byte3)
Description	<p>The IEEE_IN function returns the floating point number represented by 4 bytes which typically have been received over a communications link, such as ModbusTCP or FINS.</p> <p>Note: byte0 is the high byte of the 32 bit IEEE floating point format.</p>
Arguments	<ul style="list-style-type: none"> • byte0 - byte3 Any combination of 8 bit values that represents a valid IEEE floating point number.
Example	VR(20) = IEEE_IN(b0,b1,b2,b3)
See also	N/A

4-2-134 IEEE_OUT

Type	Mathematical function
Syntax	byte_n = IEEE_OUT(value, n)
Description	<p>The IEEE_OUT function returns a single byte in IEEE format extracted from the floating point value for transmission over a communications link. The function will typically be called 4 times to extract each byte in turn.</p> <p>Note: Byte 0 is the high byte of the 32 bit IEEE floating point format.</p>

Arguments	<ul style="list-style-type: none"> • value Any BASIC floating point variable or parameter. • n The byte number (0 - 3) to be extracted.
Example	<pre>a=MPOS AXIS(2) byte0 = IEEE_OUT(a, 0) byte1 = IEEE_OUT(a, 1) byte2 = IEEE_OUT(a, 2) byte3 = IEEE_OUT(a, 3)</pre>
See also	N/A

4-2-135 IF..THEN..ELSE..ENDIF

Type	Program control command
Syntax	<pre>IF condition_1 THEN commands {ELSEIF condition_i THEN commands} [ELSE commands] ENDIF IF condition_1 THEN commands</pre>
Description	<p>This structure controls the flow of the program based on the results of the condition. If the condition is TRUE the commands following THEN up to ELSEIF, ELSE or ENDIF are executed. If the condition is FALSE and the command of a subsequent ELSEIF substructure is TRUE, the commands of this substructure are executed. If all conditions are FALSE the commands following ELSE will be executed or the program will resume at the line after ENDIF in case no ELSE is included. The ENDIF is used to mark the end of the conditional block.</p> <p>Note: IF..THEN..ELSE..ENDIF sequences can be nested without limit. For a multi-line IF..THEN construction, there must not be any statement after THEN. A single-line construction must not use ENDIF.</p>
Arguments	<ul style="list-style-type: none"> • condition_i A logical expression. • commands One or more BASIC commands.
Example	<pre>IF MPOS > (0.22 * VR(0)) THEN GOTO exceeds_length</pre>
Example	<pre>IF IN(0) = ON THEN count = count + 1 PRINT "COUNTS = ";count fail = 0 ELSE fail = fail + 1 ENDIF</pre>
Example	<pre>IF IN(stop)=ON THEN OP(8,ON) VR(cycle_flag)=0 ELSEIF IN(start_cycle)=ON THEN VR(cycle_flag)=1 ELSEIF IN(step1)=ON THEN VR(cycle_flag)=99 ENDIF</pre>

Example **IF key_char=\$31 THEN**
 GOSUB char_1
 ELSEIF key_char=\$32 THEN
 GOSUB char_2
 ELSEIF key_char=\$33 THEN
 GOSUB char_3
 ELSE
 PRINT "Character unknown"
 ENDIF

See also N/A

4-2-136 IN

Type I/O function

Syntax **IN(input_number [,final_input_number])**
IN

Description The **IN** function returns the value of digital inputs.

- **IN(input_number, final_input_number)** will return the binary sum of the group of inputs in range **[input_number, final_input_number]**. The two arguments must be less than 24 apart.
- **IN(input_number)** will return the value of the particular input specified by the parameter **input_number**.

Arguments • **input_number**
 The number of the input for which to return a value. The range for this parameter is 0..255.

- **final_input_number**
 The number of the last input for which to return a value. The range for this parameter is 0..255.

Example The following lines can be used to move to the position set on a thumb wheel multiplied by a factor. The thumb wheel is connected to inputs 4, 5, 6 and 7, and gives output in BCD.

```

moveloop:
MOVEABS(IN(4,7)*1.5467)
WAIT IDLE
GOTO moveloop

```

The **MOVEABS** command is constructed as follows:
 Step 1: **IN(4,7)** will get a number between 0 and 15.
 Step 2: The number is multiplied by 1.5467 to get required distance.
 Step 3: An absolute move is made to this position.

Example In this example a single input is tested:

```

test:
WAIT UNTIL IN(4)=ON ' Conveyor is in position when ON
GOSUB place

```

See also **OP**.

4-2-137 INITIALISE

Type	System command
Syntax	INITIALISE
Description	Sets all axes, system and process parameters to their default values. The parameters are also reset each time the controller is powered up, or when an EX (software reset) command is performed. In Trajexia Studio the menu Reset Device on the Online menu performs the equivalent of an EX command.
Arguments	N/A
Example	No example.
See also	• EX

4-2-138 INT

Type	Mathematical function
Syntax	INT(expression)
Description	The INT function returns the integer part of the expression. Note: To round a positive number to the nearest integer value take the INT function of the value added by 0.5. Similarly, to round for a negative value subtract 0.5 to the value before applying INT .
Arguments	• expression Any valid BASIC expression.
Example	>> PRINT INT(1.79) 1.0000
See also	N/A

4-2-139 INTEGER_READ

Type	System command
Syntax	INTEGER_READ(source variable, destination variable low, destination variable high)
Description	The INTEGER_READ command splits a 32 bit variable in 2 16 bit values and copies these values to 2 other variables. The source and destination variables can be any valid system, named, TABLE memory or VR variable.
Arguments	• source variable Variable containing the 32 bit value to read. • destination variable low Variable to copy the lower 16 bits of the source variable to. • destination variable high Variable to copy the upper 16 bits of the source variable to.
Example	>> INTEGER_READ(MOTION_ERROR,VR(100),VR(101)) This example will copy the first 16 bits of MOTION_ERROR to VR(100) and the rest to VR(101).
See also	N/A

4-2-140 INVERT_IN

Type	System command
Syntax	INVERT_IN(input, on/off)
Description	The INVERT_IN command allows the input channels 0..31 to be individually inverted in software. This is important as these input channels can be assigned to activate functions such as feedhold. The INVERT_IN function sets the inversion for one channel ON or OFF. It can only be applied to inputs 0..31.
Arguments	<ul style="list-style-type: none"> input Any valid BASIC expression
Example	<pre>>>? IN(3) 0.0000 >>INVERT_IN(3,ON) >>? IN(3) 1.0000</pre>
See also	N/A

4-2-141 INVERT_STEP

Type	Axis parameter
Syntax	INVERT_STEP
Description	<p>INVERT_STEP is used to switch a hardware Inverter into the stepper pulse output circuit. This can be necessary for connecting to some stepper drivers. The electronic logic inside the Trajexia stepper pulse generator assumes that the FALLING edge of the step output is the active edge which results in motor movement. This is suitable for the majority of stepper drivers. Setting INVERT_STEP=ON effectively makes the RISING edge of the step signal the active edge. INVERT_STEP should be set if required prior to enabling the controller with WDOG=ON. Default is off.</p> <p>Note: If the setting is incorrect a stepper motor may lose position by one step when changing direction.</p> <p>Note: This parameter is applicable only to Flexible axis stepper output axes with ATYPE=46. With other types of axes, this parameter has no effect.</p>
Arguments	N/A
Example	No example.
See also	N/A

4-2-142 INVERTER_COMMAND

Type	System command
Syntax	INVERTER_COMMAND(0, station, 1, alarm_number) INVERTER_COMMAND(0, station, 8, mode) INVERTER_COMMAND(0, station, 7, operation_signals)
Description	INVERTER_COMMAND controls inputs and clears alarm of the Inverter connected to the system via the MECHATROLINK-II bus. There are three INVERTER_COMMAND functions: <ul style="list-style-type: none"> • 1: Clears an alarm. • 7: Controls operation signals. • 8: Set an Inverter to Servo Driver mode, so it acts as a servo axis. This is possible only for Inverters with an encoder feedback option card connected.

To use an Inverter via MECHATROLINK-II you must put the command and the reference via communication option:

- Inverter MV/V7: N3=3; N4=9
- Inverter F7/G7/V1000: B1-01=3; B1-02=3.

Make sure that the Inverter firmware supports the MECHATROLINK-II board.

The command returns -1 if successfully executed and 0 if failed.

The command sent to the Inverter corresponds with the bits given in the table below.

Bit	Value	Command	Description
0	Hex	1	Run forward
1	Hex	2	Run reverse
2	Hex	4	Inverter multifunction Input 3
3	Hex	8	Inverter multifunction Input 4
4	Hex	10	Inverter multifunction Input 5
5	Hex	20	Inverter multifunction Input 6
6	Hex	40	Inverter multifunction Input 7
7	Hex	80	Inverter multifunction Input 8 (Only G7)
8	Hex	100	External fault
9	Hex	200	Fault reset
10	Hex	400	Inverter multifunction Input 9 (only G7)
11	Hex	800	Inverter multifunction Input 10 (only G7)
12	Hex	1000	Inverter multifunction Input 11 (only G7)
13	Hex	2000	Inverter multifunction Input 12 (only G7)
14	Hex	4000	Fault history data clear
15	Hex	8000	External BB command

If with function 8 the mode parameter is set to 1, the Inverter is set into servo axis mode. The corresponding axis number is assigned by the CJ1W-MCH72 using the formula:

$$\text{AxisNo} = \text{MECHATROLINK-II Station Number} - 0x21$$

Therefore the calculated AxisNo must not be occupied by another axis connected.

If with function 8 the mode parameter is set to 0, which is the default value at power-up, the Inverter is set into normal Inverter mode.

Arguments	<ul style="list-style-type: none"> • station The MECHATROLINK-II station number of the Inverter. • alarm_number The number of the alarm. See the Inverter manual. • operation_signals A bitwise value to control the operation signals. See the table below. • mode The mode to set the Inverter to: 0 = Inverter mode. This is the default value at power-up. 1 = Servo Driver mode.
Example	<pre>>>INVERTER_WRITE(0,\$23,2,4500) >>INVERTER_COMMAND(0,\$23,7,2) >>WA(10000) >>INVERTER_COMMAND(0,\$23,7,0)</pre> <p>The sequence above controls an Inverter connected via MECHATROLINK-II bus to station number 23 (hex), using following steps: Step 1: Speed reference is set to 45.00 Hz. Step 2: The Inverter is set to run in reverse direction for 10 seconds with speed reference defined in previous step. Step 3: The Inverter is stopped.</p>
See also	N/A

4-2-143 INVERTER_READ

Type	System command
Syntax	INVERTER_READ(0, station, 0, param_number, param_size, VR) INVERTER_READ(0, station, 1, alarm_number, VR) INVERTER_READ(0, station, 2, VR) INVERTER_READ(0, station, 3, VR) INVERTER_READ(0, station, 4, from, length, VR)
Description	<p>INVERTER_READ reads the parameter, speed reference, torque reference or alarm from the Inverter connected to the system via the MECHATROLINK-II bus.</p> <p>There are five INVERTER_READ functions:</p> <ul style="list-style-type: none"> • 0: Reads an Inverter parameter. • 1: Reads the Inverter alarm. • 2: Reads the speed reference. • 3: Reads the torque reference. • 4: Reads the Inverter inputs. <p>To use an Inverter via MECHATROLINK-II you must put the command and the reference via communication option:</p> <ul style="list-style-type: none"> • Inverter MV/V7: N3=3; N4=9 • Inverter F7/G7/V1000: B1-01=3; B1-02=3. <p>Make you sure that the Inverter firmware supports the MECHATROLINK-II board.</p> <p>The command returns -1 if successfully executed and 0 if failed. The result (if any) is returned in the selected VR.</p>
Arguments	<ul style="list-style-type: none"> • station The MECHATROLINK-II station number of the Inverter. • param_number The number of the parameter to read. See the Inverter manual. • param_size The size of the parameter to read, 2 or 4 bytes. Most of the Inverter parameters are 2 bytes long. See the Inverter manual. • VR The address in the VR memory of the CJ1W-MCH72 where the read information is put. When the function is 4, the result is returned as a bitwise value. See the table below.

Bit	Value	Command	Description
0	Hex	1	Run forward
1	Hex	2	Run reverse
2	Hex	4	Inverter multifunction Input 3
3	Hex	8	Inverter multifunction Input 4
4	Hex	10	Inverter multifunction Input 5
5	Hex	20	Inverter multifunction Input 6
6	Hex	40	Inverter multifunction Input 7
8	Hex	100	External fault
9	Hex	200	Fault reset
14	Hex	4000	Fault history data clear

Bit	Value	Command	Description
15	Hex	8000	External BB command

- **alarm_number**
The number of the alarm to read. See the Inverter manual.
- **from**
The start address of the input to read.
- **length**
The length of the input to read.

Example No example.

See also N/A

4-2-144 INVERTER_WRITE

Type	System command
Syntax	INVERTER_WRITE(0, station, 0, param_number, param_size, VR, mode) INVERTER_WRITE(0, station, 2, value) INVERTER_WRITE(0, station, 3, value)
Description	<p>INVERTER_WRITE writes the parameter, speed reference or torque reference from the Inverter connected to the system via the MECHATROLINK-II bus.</p> <p>There are three INVERTER_WRITE functions:</p> <ul style="list-style-type: none"> • 0: Writes an Inverter parameter. • 2: Writes the speed reference. • 3: Writes the torque reference. <p>To use an Inverter via MECHATROLINK-II you should put the command and the reference via communication option:</p> <ul style="list-style-type: none"> • Inverter MV/V7: N3=3; N4=9 • Inverter F7/G7/V1000: B1-01=3; B1-02=3. <p>Make you sure that the Inverter firmware supports the MECHATROLINK-II board.</p> <p>The command returns -1 if successfully executed and 0 if failed. The result (if any) is returned in the selected VR.</p>
Arguments	<ul style="list-style-type: none"> • station The MECHATROLINK-II station number of the Inverter • param_number The number of the parameter to write. See the Inverter manual. • param_size The size of the parameter to write, 2 or 4 bytes. Most of the Inverter parameters are 2 bytes long. See the Inverter manual. • VR The address in the VR memory of the CJ1W-MCH72 where the new value for the parameter is. • mode 0 = just write; 1= write and enter; 2 = write and config. • value The new value that is written.

Example >>INVERTER_WRITE(1,\$23,2,3500)
 >>INVERTER_READ(1,\$23,2,100)
 >>PRINT VR(100)
 3500.0000

See also N/A

Note If you have to transfer many parameters at the same time, the most efficient way is to use MODE 0 for all but the last parameter, and MODE 1 for the last parameter. MODE 0 is executed faster than MODE 1.

4-2-145 JOGSPEED

Type Axis parameter

Syntax **JOGSPEED**

Description The **JOGSPEED** parameter sets the jog speed in user units for an axis. A jog will be performed when a jog input for an axis has been declared and that input is low. A forward jog input and a reverse jog input are available for each axis, respectively set by **FWD_JOG** and **REV_JOG**. The speed of the jog can be controlled with the **FAST_JOG** input.

Arguments N/A

Example No example.

See also **AXIS AXIS, FAST_JOG, FWD_JOG, REV_JOG, UNITS.**

4-2-146 LAST_AXIS

Type System parameter (read-only)

Syntax **LAST_AXIS**

Description The **LAST_AXIS** parameter contains the number of the last axis processed by the system.
 Most systems do not use all the available axes. It would therefore be a waste of time to task the idle moves on all axes that are not in use. To avoid this to some extent, the CJ1W-MCH72 will task moves on the axes from 0 to **LAST_AXIS**, where **LAST_AXIS** is the number of the highest axis for which an **AXIS** or **BASE** command has been processed, whichever of the two is larger.

Arguments N/A

Example No example.

See also **AXIS.**

4-2-147 LINKAX

Type Axis parameter (read-only)

Syntax **LINKAX**

Description Returns the axis number that the axis is linked to during any linked moves. Linked moves are where the demand position is a function of another axis, e.g. **CONNECT**, **CAMBOX** and **MOVELINK**.

Arguments N/A

Example No example.
 See also **CONNECT, CAMBOX, MOVELINK.**

4-2-148 LIST

Type Program command (Trajexia Studio command line only)
 Syntax **LIST ["program_name"]**
TYPE ["program_name"]
 Description For use only with the Command Line Terminal interface. **LIST** is used as an immediate (command line) command only and must not be used in programs.
 The **LIST** command prints the current selected program or the program specified by **program_name**. The program name can also be specified without quotes. If the program name is omitted, the current selected program will be listed.
 Note: This command is implemented for an offline Command Line Terminal. Within Trajexia Studio users can use the terminal window.
 Arguments • **program_name**
 The program to be printed.
 Example No example.
 See also **SELECT.**

4-2-149 LIST_GLOBAL

Type System command (terminal only)
 Syntax **LIST_GLOBAL**
 Description When executed from the Command Line Terminal interface (channel 0), all the currently set **GLOBAL** and **CONSTANT** parameters will be printed to the terminal.
 Arguments N/A
 Example In an application where the following GLOBAL and CONSTANT have been set:
CONSTANT "cutter", 23
GLOBAL "conveyor",5

>>LIST_GLOBAL
Global VR
----- ----
conveyor 5
Constant Value
----- ----
cutter 23.0000
 See also N/A

4-2-150 LN

Type	Mathematical function
Syntax	LN(expression)
Description	The LN function returns the natural logarithm of the expression. The input expression value must be greater than 0.
Arguments	<ul style="list-style-type: none"> • expression Any valid BASIC expression.
Example	>> PRINT LN(10) 2.3026
See also	N/A

4-2-151 LOCK

Type	System command
Syntax	LOCK(code) UNLOCK(code)
Description	The LOCK command prevents the program from being viewed, modified or deleted by personnel unaware of the security code. The lock code number is stored in the flash EPROM. The UNLOCK command allows the locked state to be unlocked. The code number can be any integer and is held in encoded form. LOCK is always an immediate command and can be issued only when the system is UNLOCKED . LOCK is available from within Trajexia Studio, users can lock the device from the Online menu.
Arguments	<ul style="list-style-type: none"> • code Any valid integer with maximum 7 digits.
Example	>> LOCK(561234) The programs cannot be modified or seen. >> UNLOCK(561234) The system is now unlocked.
See also	N/A

 **Caution** The security code must be remembered; it will be required to unlock the system. Without the security code the system can not be recovered.

4-2-152 MARK

Type	Axis parameter (read-only)
Syntax	MARK
Description	The MARK is set to FALSE when the REGIST command has been executed and is set to TRUE when the primary registration event occurs. Only when this parameter is TRUE , the REG_POS value is correct.
Arguments	N/A

Example **loop:**
 WAIT UNTIL IN(punch_clr)=ON
 MOVE(index_length)
 REGIST(3)
 WAIT UNTIL(MARK)
 MOVEMODIFY(REG_POS + offset)
 WAIT IDLE
 GOTO loop

See also **AXIS, REGIST, REG_POS.**

4-2-153 MARKB

Type Axis parameter (read-only)

Syntax **MARKB**

Description The **MARKB** is set to **FALSE** when the **REGIST** command has been executed and is set to **TRUE** when the primary registration event occurs. Only when this parameter is **TRUE**, the **REG_POSB** value is correct.

Arguments N/A

Example **IF MARKB AXIS(2) THEN**
 PRINT "Secondary registration event for axis 2 occurred"
 ENDIF

See also **AXIS, REGIST, REG_POSB.**

4-2-154 MECHATROLINK

Type	System command
Syntax	<p>MECHATROLINK(0,0) Detects and connects slaves on the MECHATROLINK-II connection. It is necessary to use it to reset the network from a communication problem and to re-detect servos that have been not detected (EG: when the A letter in the AXISSTATUS word becomes capital red).</p> <p>MECHATROLINK(0,3,VR) Returns the number of detected MECHATROLINK-II slaves after a MECHATROLINK(0,0). It is used by the STARTUP program to check that the number of detected MECHATROLINK-II stations corresponds with the expected.</p> <p>MECHATROLINK(0,4,station,VR) Returns the address of MECHATROLINK-II slave at that "station" number. The station numbers are a sequence 0..x for all the attached slaves. -1 is returned if no slave is allocated to that station. It is used by the STARTUP program to check that the number of detected MECHATROLINK-II stations corresponds with the expected.</p> <p>MECHATROLINK(0,5,station,VR) Reads and clears missed message count. A Non-Axis MECHATROLINK-II slave does not report automatically a network problem so, use this command to poll the Inverter for checking that the network is alive.</p> <p>Note:</p> <ul style="list-style-type: none"> • You can use the command MECHATROLINK(0,5,station,VR) to monitor the status of a slave during a program execution. If the contents of the VR address is greater than 0 a communication error with the slave occurs and the slave can malfunction. You can use this command to stop your program when the slave has an error.
Description	<p>Note: This command has two forms, depending upon the function required: Master and Station Functions.</p> <p>All MECHATROLINK functions return TRUE (-1) if the command was successful or FALSE (0) if the command failed.</p> <p>The functions are separated out into 2 types, Master functions that work on a unit, and Station functions that work on a specific station_address of a given unit.</p> <p>All functions that retrieve a value store it in the VR variable indicated in the last parameter. If this parameter has the value -1 then the value is printed to the command line port.</p>
Arguments	N/A
Example	No example.
See also	N/A

4-2-155 MERGE

Type	Axis parameter
Syntax	MERGE
Description	<p>The MERGE parameter is a software switch that can be used to enable or disable the merging of consecutive moves. When MERGE is ON and the next move already in the next move buffer (NTYPE), the axis will not ramp down to 0 speed but will load up the following move enabling a seamless merge. The default setting of MERGE is OFF.</p> <p>It is up to the programmer to ensure that merging is sensible. For example, merging a forward move with a reverse move will cause an attempted instantaneous change of direction.</p> <p>MERGE will only function if the following are all true:</p> <ol style="list-style-type: none"> 1 Only the speed profiled moves MOVE, MOVEABS, MOVECIRC, MHELICAL, REVERSE, FORWARD and MOVEMODIFY can be merged with each other. They cannot be merged with linked moves CONNECT, MOVELINK and CAMBOX. 2 There is a move in the next move buffer (NTYPE). 3 The axis group does not change for multi-axis moves. <p>When merging multi-axis moves, only the base axis MERGE axis parameter needs to be set.</p> <p>Note: If the moves are short, a high deceleration rate must be set to avoid the CJ1W-MCH72 decelerating in anticipation of the end of the buffered move.</p>
Arguments	N/A
Example	<p>MERGE = OFF ' Decelerate at the end of each move MERGE = ON ' Moves will be merged if possible</p>
See also	AXIS .

4-2-156 MHELICAL

Type	Axis command
Syntax	<p>MHELICAL(end1, end2, centre1, centre2, direction, distance3 [,mode])) MH(end1, end2, centre1, centre2, direction, distance3 [,mode])</p>
Description	<p>Performs a helical move, that is, moves 2 orthogonal axes in such a way as to produce a circular arc at the tool point with a simultaneous linear move on a third axis. The first 5 parameters are similar to those of a MOVECIRC command. The sixth parameter defines the simultaneous linear move.</p> <p>Finish 1 and centre 1 are on the current BASE axis. Finish 2 and centre 2 are on the following axis.</p> <p>The first 4 distance parameters are scaled according to the current unit conversion factor for the BASE axis. The sixth parameter uses its own axis units.</p>

- Arguments
- **end1**
Position on **BASE** axis to finish at.
 - **end2**
Position on next axis in **BASE** array to finish at.
 - **centre1**
Position on **BASE** axis about which to move.
 - **centre2**
Position on next axis in **BASE** array about which to move.
 - **direction**
The **direction** is a software switch which determines whether the arc is interpolated in a clockwise or anti- clockwise direction. The parameter is set to 0 or 1. See **MOVECIRC**.
 - **distance3**
The distance to move on the third axis in the **BASE** array axis in user units.
 - **mode**
0 = Interpolate the third axis with the main two axis when calculating path speed (true helical path).
1 = Interpolate only the first two axes for path speed, but move the third axis in coordination with the other 2 axes (circular path with following third axis).

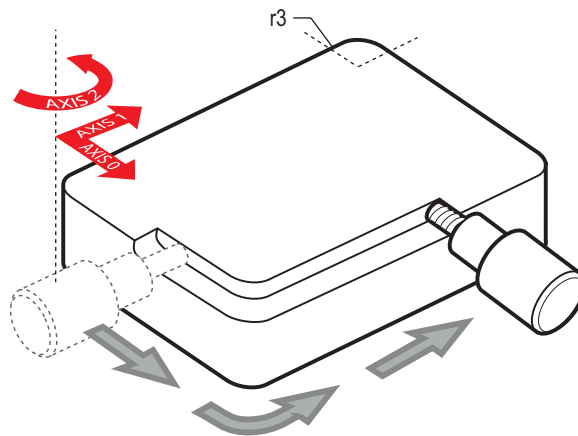

Example The command sequence follows a rounded rectangle path with axis 1 and 2. Axis 3 is the tool rotation so that the tool is always perpendicular to the product. The **UNITS** for axis 3 are set such that the axis is calibrated in degrees.

REP_DIST AXIS(3)=360

REP_OPTION AXIS(3)=ON

' all 3 axes must be homed before starting

MERGE=ON

MOVEABS(360) AXIS(3) point axis 3 in correct starting direction

WAIT IDLE AXIS(3)

MOVE(0,12)

MHELICAL(3,3,3,0,1,90)

MOVE(16,0)

MHELICAL(3,-3,0,-3,1,90)

MOVE(0,-6)

MHELICAL(-3,-3,-3,0,1,90)

MOVE(-2,0)

MHELICAL(-3,3,0,3,1,90)

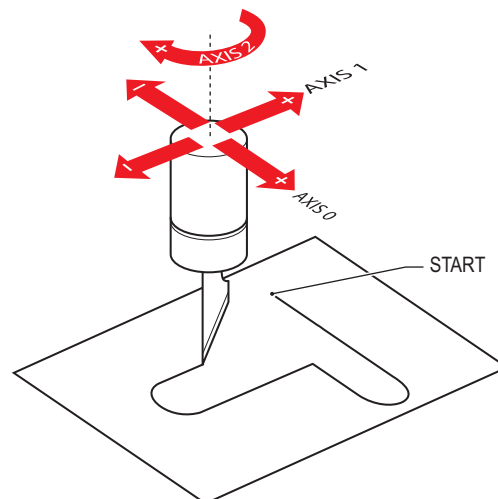

Example	<p>A PVC cutter uses 2 axes similar to a X-Y plotter. The third axis is used to control the cutting angle of the knife. To keep the resultant cutting speed for the x and y axis equal when cutting curves, mode 1 is applied to the helical command.</p> <p>BASE(0,1,2) : MERGE=ON 'merge moves into one continuous movement MOVE(50,0) MHELICAL(0,-6,0,-3,1,180,1) MOVE(-22,0) WAIT IDLE MOVE(-90) AXIS(2) 'rotate the knife after stopping at corner WAIT IDLE AXIS(2) MOVE(0,-50) MHELICAL(-6,0,-3,0,1,180,1) MOVE(0,50) WAIT IDLE 'pause again to rotate the knife MOVE(-90) AXIS(2) WAIT IDLE AXIS(2) MOVE(-22,0) MHELICAL(0,6,0,3,1,180,1) WAIT IDLE</p>
See also	MOVECIRC.

4-2-157 MOD

Type	Mathematical function
Syntax	expression1 MOD expression2
Description	The MOD function returns the expression2 modulus of expression1 . This function will take the integer part of any non-integer input.
Arguments	<ul style="list-style-type: none"> • expression1 Any valid BASIC expression. • expression2 Any valid BASIC expression.
Example	>> PRINT 122 MOD 13 5.0000
See also	N/A

4-2-158 MOTION_ERROR

Type	System parameter (read-only)
Syntax	MOTION_ERROR
Description	<p>The MOTION_ERROR parameter contains a bit pattern showing the axes which have a motion error. For example, if axis 2 and 6 have the motion error the MOTION_ERROR value would be 68 (4+64).</p> <p>A motion error occurs when the AXISSTATUS state for one of the axes matches the ERRORMASK setting. In this case the enable switch (WDOG) will be turned off, and MOTION_ERROR contains a bit pattern showing all axes which have the motion error. The ERROR_AXIS parameter will contain the number of the first axis to have the error.</p> <p>Due to technical limitations MOTION_ERROR can return an invalid bit pattern when multiple axes have a motion error. To obtain the correct value use the INTEGER_READ command to get the bit pattern in 2 parts.</p> <p>A motion error can be cleared executing a DATUM(0) command or resetting the controller with an EX command.</p>
Arguments	N/A
Example	INTEGER_READ(MOTION_ERROR,VR(100),VR(101)) This example will copy the first 16 bits of MOTION_ERROR to VR(100) and the rest to VR(101) .
See also	AXIS, AXISSTATUS, DATUM, ERROR_AXIS, ERRORMASK, WDOG, INTEGER_READ

4-2-159 MOVE

Type	Axis command
Syntax	MOVE (distance_1 [, distance_2 [, distance_3 [, distance_4 [, ...]]]]) MO (distance_1 [, distance_2 [, distance_3 [, distance_4 [, ...]]]])
Description	<p>The MOVE command moves with one or more axes at the demand speed and acceleration and deceleration to a position specified as increment from the current position. In multi-axis moves the movement is interpolated and the speed, acceleration and deceleration are taken from the base axis.</p> <p>The specified distances are scaled using the unit conversion factor in the UNITS axis parameter. If, for example, an axis has 4,000 encoder edges/mm, then the number of units for that axis would be set to 4000, and MOVE(12.5) would move 12.5 mm.</p> <p>MOVE works on the default basis axis group (set with BASE) unless AXIS is used to specify a temporary base axis. Argument distance_1 is applied to the base axis, distance_2 is applied to the next axis, etc. By changing the axis between individual MOVE commands, uninterpolated, unsynchronised multi-axis motion can be achieved. Incremental moves can be merged for profiled continuous path movements by turning on the MERGE axis parameter.</p> <p>Considering a 2-axis movement, the individual speeds are calculated using the equations below. Given command MOVE(x_1, x_2) and the profiled speed v_p as calculated from the SPEED, ACCEL and DECEL parameters from the base axis and the total multi-axes distance $L = \text{SQR}(x_1^2 + x_2^2)$.</p> <p>The individual speed v_i for axis i at any time of the movement is calculated as: $v_i = (x_i * v_p) / L$.</p>
Arguments	<p>The command can take up to 32 arguments.</p> <ul style="list-style-type: none"> • distance_i The distance to move for every axis in user units starting with the base axis.
Example	<p>A system works with a unit conversion factor of 1 and has a 1000 line encoder. Note that a 1000 line encoder gives 4000 edges/turn.</p> <p>MOVE(40000) ' move 10 turns on the motor.</p>

Example Axes 3, 4 and 5 must move independently, that is, without interpolation. Each axis moves at its own programmed **SPEED**, **ACCEL** and **DECEL** etc.

```
'setup axis speed and enable
BASE(3)
SPEED=5000
ACCEL=100000
DECEL=150000
SERVO=ON
BASE(4)
SPEED=5000
ACCEL=150000
DECEL=560000
SERVO=ON
BASE(5)
SPEED=2000
ACCEL=320000
DECEL=352000
SERVO=ON
WDOG=ON
MOVE(10) AXIS(5) 'start moves
MOVE(10) AXIS(4)
MOVE(10) AXIS(3)
WAIT IDLE AXIS(5) 'wait for moves to finish
WAIT IDLE AXIS(4)
WAIT IDLE AXIS(3)
```

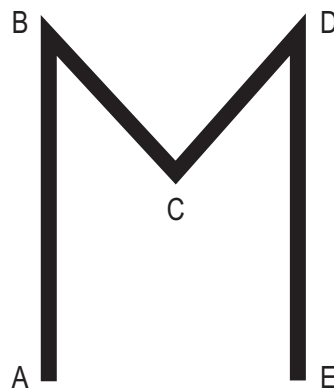

Example An X-Y plotter can write text at any position within its working envelope. Individual characters are defined as a sequence of moves relative to a start point. Therefore, the same commands can be used regardless of the plot origin. The command subroutine for the letter M is:

```
write_m:
MOVE(0,12) 'move A > B
MOVE(3,-6) 'move B > C
MOVE(3,6) 'move C > D
MOVE(0,-12)'move D > E
RETURN
```

See also **AXIS, MOVEABS, UNITS.**

4-2-160 MOVEABS

Type	Axis command
Syntax	MOVEABS (distance_1 [, distance_2 [, distance_3 [, distance_4 [, ...]]]]) MA (distance_1 [, distance_2 [, distance_3 [, distance_4 [, ...]]]])
Description	<p>The MOVEABS command moves one or more axes at the demand speed, acceleration and deceleration to a position specified as absolute position, i.e., in reference to the origin. In multi-axis moves the movement is interpolated and the speed, acceleration and deceleration are taken from the base axis.</p> <p>The specified distances are scaled using the unit conversion factor in the UNITS axis parameter. If, for example, an axis has 4,000 encoder edges/mm, then the number of units for that axis would be set to 4000, and MOVEABS(12.5) would move to a position 12.5 mm from the origin. MOVEABS works on the default basis axis group (set with BASE) unless AXIS is used to specify a temporary base axis. Argument distance_1 is applied to the base axis, distance_2 is applied to the next axis, etc. By changing the axis between individual MOVE commands, uninterpolated, unsynchronised multi-axis motion can be achieved. Absolute moves can be merged for profiled continuous path movements by turning on the MERGE axis parameter.</p> <p>Considering a 2-axis movement, the individual speeds are calculated using the equations below. Given command MOVE(ax₁,ax₂), the current position (ay₁,ay₂) and the profiled speed v_p as calculated from the SPEED, ACCEL and DECEL parameters from the base axis and the total multi-axes distance $L = \text{SQR}(x_1^2 + x_2^2)$, where $x_1 = ax_i - ay_i$.</p> <p>The individual speed for axis at any time of the movement is calculated as $v_i = (x_i \times v_p) / L$.</p>
Arguments	<p>The command can take up to 32 arguments.</p> <ul style="list-style-type: none"> • distance_i The position to move every axis <i>i</i> to in user units starting with the base axis.

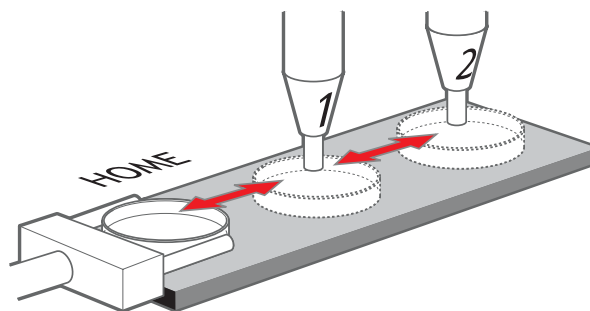

Example A machine must move to one of 3 positions depending on the selection made by 2 switches. The options are home (if both switches are off), position 1 (if the first switch is on and the second switch is off) and position 2 (if the first switch is off and the second switch is on). Position 2 has priority over position 1.

```
'define absolute positions
home=1000
position_1=2000
position_2=3000
WHILE IN(run_switch)=ON
  IF IN(6)=ON THEN 'switch 6 selects position 2
    MOVEABS(position_2)
    WAIT IDLE
  ELSEIF IN(7)=ON THEN 'switch 7 selects position 1
    MOVEABS(position_1)
    WAIT IDLE
  ELSE
    MOVEABS(home)
    WAIT IDLE
  ENDIF
WEND
```

Example An X-Y plotter has a pen carousel. The position of this carousel is fixed relative to the absolute zero position of the plotter. To change pens, an absolute move to the carousel position finds the target irrespective of the plot position.

```
MOVEABS(28.5,350) ' move to just outside the pen holder area
WAIT IDLE
SPEED = pen_pickup_speed
MOVEABS(20.5,350) ' move in to pick up the pen
```

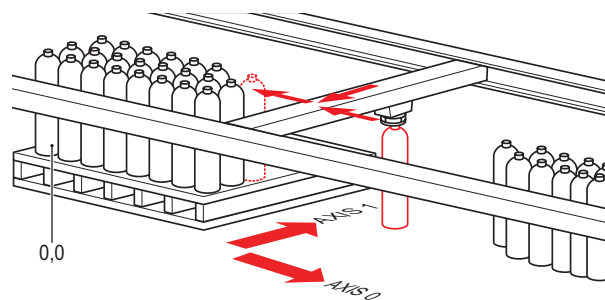

Example A pallet consists of a 6 by 8 grid in which gas canisters are inserted 185 mm apart by a packaging machine. The canisters are picked up from a fixed point. The first position in the pallet is defined as position 0,0 with the **DEFPOS** command. The part of the program to position the canisters in the pallet is:

```

FOR x=0 TO 5
  FOR y=0 TO 7
    MOVEABS(-340,-516.5) 'move to pick-up point
    WAIT IDLE
    GOSUB pick 'call pick up subroutine
    PRINT Move to Position: ;x*6+y+1
    MOVEABS(x*185,y*185) 'move to position in grid
    WAIT IDLE
    GOSUB place 'call place down subroutine
  NEXT y
NEXT x

```

See also **AXIS, MOVE, MOVEABS, UNITS.**

4-2-161 MOVECIRC

Type Axis command

Syntax **MOVECIRC(end_1,end_2,centre_1,centre_2,direction)**
MC(end_1,end_2,centre_1,centre_2,direction)

Description The **MOVECIRC** command interpolates 2 orthogonal axes in a circular arc at the tool point. The path of the movement is determined by the 5 arguments, which are incremental from the current position. The arguments **end_1** and **centre_1** apply to the **BASE** axis and **end_2** and **centre_2** apply to the following axis. All arguments are given in user units of each axis. The speed of movement along the circular arc is set by the **SPEED, ACCEL** and **DECEL** parameters of the **BASE** axis. The first four distance parameters are scaled according to the current unit conversion factor for the **BASE** axis. **MOVECIRC** works on the default basis axis group (set with **BASE**) unless **AXIS** is used to specify a temporary base axis. For **MOVECIRC** to be correctly executed, the two axes moving in the circular arc must have the same number of encoder pulses per linear axis distance. If they do not, it is possible to adjust the encoder scales in many cases by adjusting with **ENCODER_RATIO** axis parameters for the axis.

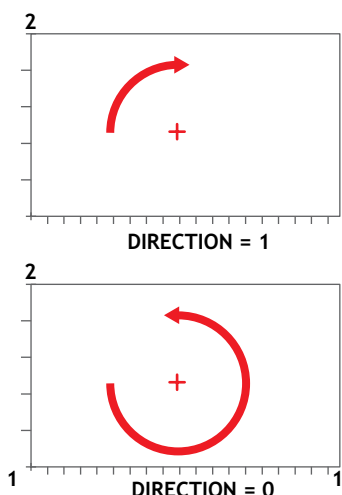

- Arguments
- **end_1**
The end position for the **BASE** axis.
 - **end_2**
The end position for the next axis.
 - **centre_1**
The position around which the **BASE** axis is to move.
 - **centre_2**
The position around which the next axis is to move.
 - **direction**
A software switch that determines whether the arc is interpolated in a clockwise or counterclockwise direction. Value: 0 or 1.
If the two axes involved in the movement form a right-hand axis, set direction to 0 to produce positive motion about the third (possibly imaginary) orthogonal axis. If the two axes involved in the movement form a left-hand axis, set direction to 0 to produce negative motion about the third (possibly imaginary) orthogonal axis. See the table below.

Direction	Right-hand axis	Left-hand axis
0	Positive	Negative
1	Negative	Positive

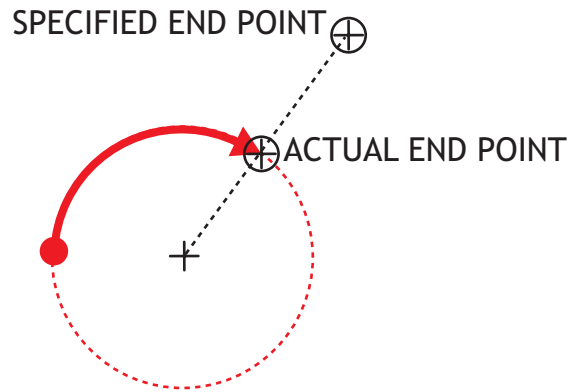

Note: In order for the **MOVECIRC** to be correctly executed, the two axes generating the circular arc must have the same number of encoder pulses versus linear axis distance. If this is not the case it is possible to adjust the encoder scales in many cases by using **ENCODER_RATIO** parameter.

Note: The **MOVECIRC** computes the radius and the total angle of rotation from the centre, and end-point. If the end point is not on the calculated path, the move simply ends at the computed end and not the specified end point. It is the responsibility of the programmer to ensure that the two points correspond to correct points on a circle.

Note: Neither axis may cross the set absolute repeat distance **REP_DIST** during a **MOVECIRC**. **Doing so may cause one or both axis to jump or for their FE value to exceed FE_LIMIT.**

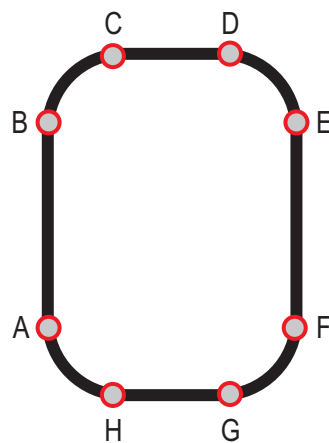

Example The following command sequence plots the letter O:

```

MOVE(0,6) ' Move A -> B
MOVECIRC(3,3,3,0,1) ' Move B -> C
MOVE(2,0) ' Move C -> D
MOVECIRC(3,-3,0,-3,1) ' Move D -> E
MOVE(0,-6) ' Move E -> F
MOVECIRC(-3,-3,-3,0,1) ' Move F -> G
MOVE(-2,0) ' Move G -> H
MOVECIRC(-3,3,0,3,1) ' Move H -> A

```

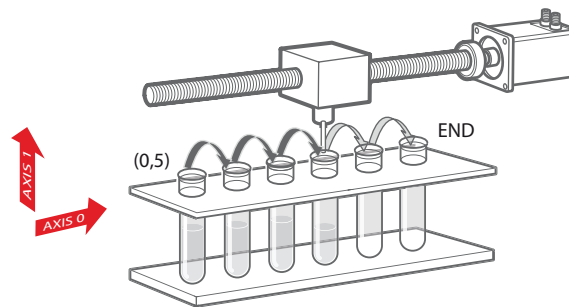

Example A machine is required to drop chemicals into test tubes. The nozzle can move up and down and also along its rail. The most efficient motion for the nozzle is to move in an arc between the test tubes.

```

BASE(0,1)
MOVEABS(0,5) 'move to position above first tube
MOVEABS(0,0) 'lower for first drop
WAIT IDLE
OP(15,ON) 'apply dropper
WA(20)
OP(15,OFF)
FOR x=0 TO 5
MOVECIRC(5,0,2.5,0,1) 'arc between the test tubes
WAIT IDLE
OP(15,ON) 'Apply dropper
WA(20)
OP(15,OFF)
NEXT x
MOVECIRC(5,5,5,0,1) 'move to rest position

```

See also **AXIS, ENCODER_RATIO, UNITS**

4-2-162 MOVELINK

Type	Axis command
Syntax	MOVELINK (distance, link_distance, link_acceleration, link_deceleration, link_axis [, link_option [, link_position]]) ML (distance, link_distance, link_acceleration, link_deceleration, link_axis [, link_option [, link_position]])
Description	<p>The MOVELINK command creates a linear move on the base axis linked via a software gearbox to the measured position of a link axis. The link axis can move in either direction to drive the output motion. The parameters show the distance the BASE axis moves for a certain distance of the link axis (link_distance). The link axis distance is divided into three phases that apply to the movement of the base axis. These parts are the acceleration, the constant speed and the deceleration. The link acceleration and deceleration distances are specified by the link_acceleration and link_deceleration parameters. The constant speed link distance is derived from the total link distance and these two parameters.</p> <p>The three phases can be divided into separate MOVELINK commands or can be added up together into one.</p> <p>Consider the following two rules when setting up the MOVELINK command.</p> <p>Rule 1: In an acceleration and deceleration phase with matching speed, the link_distance must be twice the distance. See the figure.</p> <p>Rule 2: In a constant speed phase with matching speeds, the two axes travel the same distance so the distance to move must equal the link_distance.</p> <p>MOVELINK works on the default basis axis group (set with BASE) unless AXIS is used to specify a temporary base axis. The axis set for link_axis drives the base axis.</p> <p>MOVELINK is designed for controlling movements such as:</p> <ul style="list-style-type: none"> • Synchronization to conveyors • Flying shears • Thread chasing, tapping etc. • Coil winding <p>Note: If the sum of link_acceleration and link_deceleration is greater than link_distance, they are both reduced in proportion in order to equal the sum to link_distance.</p>

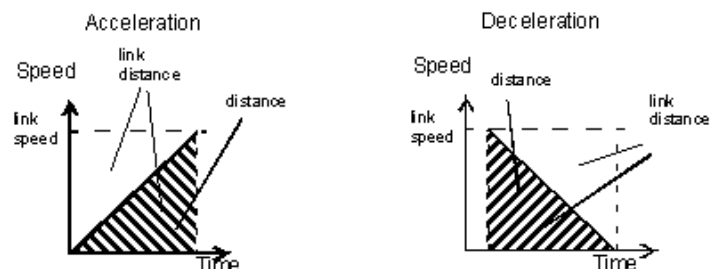

- Arguments
- **distance**
The incremental distance in user units to move the BASE axis, as a result of the measured **link_distance** movement on the link axis.
 - **link_distance**
The positive incremental distance in user units that is required to be measured on the link axis to result in the distance motion on the BASE axis.
 - **link_acceleration**
The positive incremental distance in user units on the link axis over which the base axis will accelerate.
 - **link_deceleration**
The positive incremental distance in user units on the link axis over which the base axis will decelerate.
Note: If the sum of parameter 3 and parameter 4 is greater than parameter 2, they are both reduced in proportion until their sum equals parameter 2.
 - **link_axis**
The axis to link to.
 - **link_option**
See the table below.

link_option	Description
1	Link starts when registration event occurs on link axis.
2	Link starts at an absolute position on link axis (see link_position).
4	MOVELINK repeats automatically and bidirectionally. This option is cancelled by setting bit 1 of REP_OPTION parameter (that is, REP_OPTION = REP_OPTION OR 2).
5	Combination of options 1 and 4.
6	Combination of options 2 and 4.

- **link_position**
The absolute position where **MOVELINK** will start when **link_option** is set to 2

Note: The command uses the BASE and AXIS, and unit conversion factors in a similar way to other MOVE commands.

Note: The “link” axis may move in either direction to drive the output motion. The link distances specified are always positive.

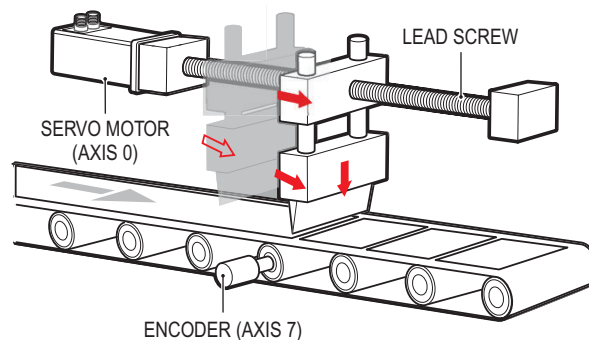

Example

A flying shear that moves at the speed of the material cuts a long sheet of paper into cards every 160 m. The shear can move up to 1.2 metres, of which 1m is used in this example. The paper distance is measured by an encoder. The unit conversion factor is set to give units of metres on both axes. Note that axis 7 is the link axis.

WHILE IN(2)=ON

MOVELINK(0,150,0,0,7) ' dwell (no movement) for 150m

MOVELINK(0.3,0.6,0.6,0,7) ' accelerate to paper speed

MOVELINK(0.7,1.0,0,0.6,7) ' track the paper then decelerate

WAIT LOADED ' wait until acceleration movelink is finished

OP(8,ON) ' activate cutter

MOVELINK(-1.0,8.4,0.5,0.5,7) retract cutter back to start

WAIT LOADED

OP(8,OFF) ' deactivate cutter at end of outward stroke

WEND

In this program, the controller waits for the roll to feed out 150 m in the first

line. After this distance the shear accelerates to match the speed of the paper, moves at the same speed, and then decelerates to a stop within the 1 m stroke. This movement is specified using two separate **MOVELINK** commands. This allows the program to wait for the next move buffer to be clear, **NTYPE=0**, which indicates that the acceleration phase is complete. Note that the distances on the measurement axis (the link distance in each **MOVELINK** command), 150, 0.8, 1.0 and 8.2, add up to 160 m. To make sure that the speed and the positions of the cutter and paper match during the cut process, the parameters of the **MOVELINK** command must be correct. The easiest way to do this is to consider the acceleration, constant speed and deceleration phases separately, and then combine them as required, according to these 2 rules:

Rule 1: In an acceleration phase to a matching speed, the link distance must be twice the movement distance. Therefore, the acceleration phase can be specified alone as:

MOVELINK(0.3,0.6,0.6,0,1)' move is all accel

Rule 2: In a constant speed phase with matching speed, the two axes move the same distance. Therefore, the distance to move must be equal the link distance. Therefore, the constant speed phase can be specified as:

MOVELINK(0.4,0.4,0,0,1)' all constant speed

The deceleration phase is set in this case to match the acceleration:

MOVELINK(0.3,0.6,0,0.6,1)' all decel

The movements of each phase can be added to give the total movement.

MOVELINK(1,1.6,0.6,0.6,1)' Same as 3 moves above

But in the example above, the acceleration phase is kept separate:

MOVELINK(0.3,0.6,0.6,0,1)

MOVELINK(0.7,1.0,0,0.6,1)

This allows the output to be switched on at the end of the acceleration phase.

Example

MOVELINK can be used to create an exact ratio gearbox between two axes. Suppose it is required to create a gearbox link of 4000/3072. This ratio is inexact (1.30208333). If this ratio is entered into a **CONNECT** command, the axes will slowly creep out of synchronisation. To prevent this problem, set the "link option" to 4 to make **MOVELINK** repeat continuously.

MOVELINK(4000,3072,0,0,linkaxis,4)

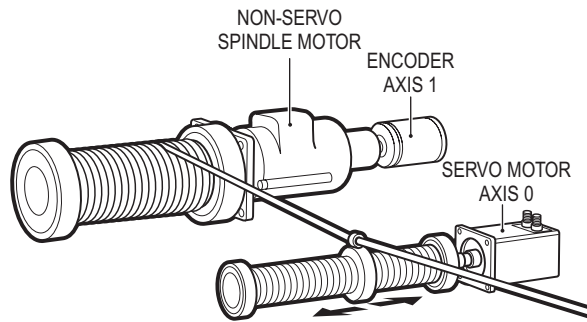

- Example In this example on coil winding the unit conversion factors **UNITS** are set so that the payout movements are in mm and the spindle position is measured in revolutions. The payout eye therefore moves 50 mm over 25 revolutions of the spindle with the command **MOVELINK(50,25,0,0,linkax)**. To accelerate over the first spindle revolution and decelerate over the final 3 use the command **MOVELINK(50,25,1,3,linkax)**.
- ```

OP(motor,ON) ' Switch spindle motor on
FOR layer=1 TO 10
 MOVELINK(50,25,0,0,1)
 MOVELINK(-50,25,0,0,1)
NEXT layer
WAIT IDLE
OP(motor,OFF)

```
- See also **AXIS, UNITS, REP\_OPTION.**

## 4-2-163 MOVEMODIFY

- Type Axis command
- Syntax **MOVEMODIFY(position)**  
**MM(position)**
- Description The **MOVEMODIFY** command changes the absolute end position of the current single-axis linear move (**MOVE, MOVEABS**). If there is no current move or the current move is not a linear move, then **MOVEMODIFY** is treated as a **MOVEABS** command. The **ENDMOVE** parameter will contain the position of the end of the current move in user units. **MOVEMODIFY** works on the default basis axis (set with **BASE**) unless **AXIS** is used to specify a temporary base axis.
- Arguments
- position**  
The absolute position to be set as the new end of move.

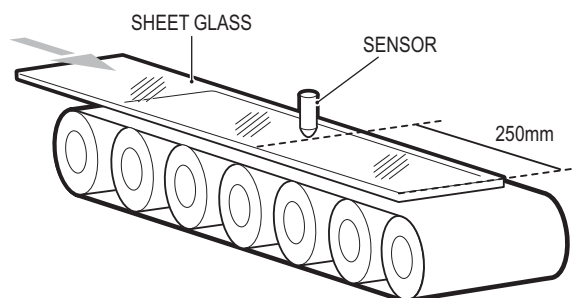

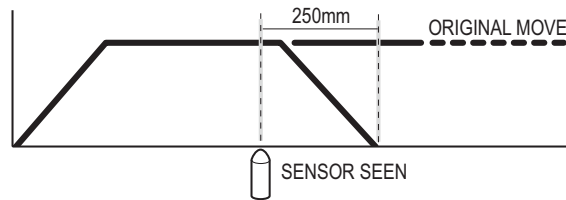

Example A sheet of glass is fed on a conveyor and is required to stop 250 mm after the leading edge is sensed by a proximity switch. The proximity switch is connected to the registration input:

```

MOVE(10000) 'Start a long move on conveyor
REGIST(3) 'set up registration
WAIT UNTIL MARK
'MARK becomes TRUE when sensor detects glass edge
OFFPOS = -REG_POS 'set position where mark was seen to 0
WAIT UNTIL OFFPOS=0 'wait for OFFPOS to take effect
MOVEMODIFY(250) 'change move to stop at 250mm

```

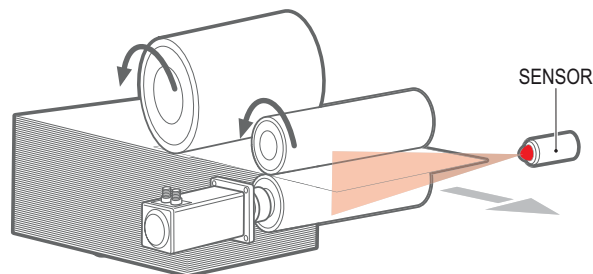

Example A paper feed system slips. To counteract this, a proximity sensor is positioned one third of the way into the movement. This detects at which position the paper passes, and thus how much slip has occurred. The move is then modified to account for this variation.

```

paper_length=4000
DEFPOS(0)
REGIST(3)
MOVE(paper_length)
WAIT UNTIL MARK
slip=REG_POS-(paper_length/3)
offset=slip*3
MOVEMODIFY(paper_length+offset)

```

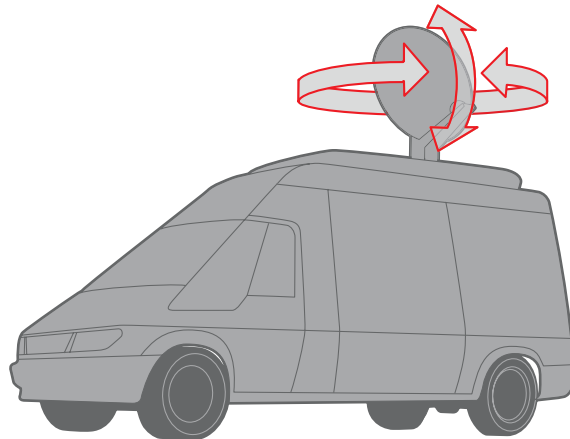

**Example** A satellite receiver sits on top of a van. It must align correctly to the satellite from data processed in a computer. This information is sent to the controller through the serial link and sets VR(0) and VR(1). This information is used to control the two axes.

**MOVEMODIFY** is used so that the position can be continuously changed even if the previous set position is not achieved.

**bearing=0 'set lables for VRs**

**elevation=1**

**UNITS AXIS(0)=360/counts\_per\_rev0**

**UNITS AXIS(1)=360/counts\_per\_rev1**

**WHILE IN(2)=ON**

**MOVEMODIFY(VR(bearing))AXIS(0) 'adjust bearing to match VR0**

**MOVEMODIFY(VR(elevation))AXIS(1)'adjust elevation to match**

**VR1**

**WA(250)**

**WEND**

**RAPIDSTOP 'stop movement**

**WAIT IDLE AXIS(0)**

**MOVEABS(0) AXIS(0) 'return to transport position**

**WAIT IDLE AXIS(1)**

**MOVEABS(0) AXIS (1)**

## 4-2-164 MPOS

|             |                                                                                                                                                                                                                                                                                                                                                                                                                                                                |
|-------------|----------------------------------------------------------------------------------------------------------------------------------------------------------------------------------------------------------------------------------------------------------------------------------------------------------------------------------------------------------------------------------------------------------------------------------------------------------------|
| Type        | Axis parameter (read-only)                                                                                                                                                                                                                                                                                                                                                                                                                                     |
| Syntax      | <b>MPOS</b>                                                                                                                                                                                                                                                                                                                                                                                                                                                    |
| Description | <p>The <b>MPOS</b> parameter is the measured position of the axis in user units as derived from the encoder. This parameter can be set using the <b>DEFPOS</b> command. The <b>OFFPOS</b> axis parameter can also be used to shift the origin point. <b>MPOS</b> is reset to 0 at start-up or after the controller has been reset.</p> <p>The range of the measured position is controlled with the <b>REP_DIST</b> and <b>REP_OPTION</b> axis parameters.</p> |
| Arguments   | N/A                                                                                                                                                                                                                                                                                                                                                                                                                                                            |



- Example     **WAIT UNTIL MPOS >= 1250**  
               **SPEED = 2.5**
- See also     **UNITS, AXIS, DEFPOS, ENCODER, FE, OFFPOS, REP\_DIST,**  
               **REP\_OPTION, UNITS.**

## 4-2-165 MSPEED

- Type         Axis parameter (read-only)
- Syntax       **MSPEED**
- Description   The **MSPEED** parameter contains the measured speed in units/s. It is calculated by taking the change in the measured position in user units in the last servo period and divide it by the servo period (in seconds). The servo period is set with the **SERVO\_PERIOD** parameter. **MSPEED** represents a snapshot of the speed and significant fluctuations, which can occur, particularly at low speeds. It can be worthwhile to average several readings if a stable value is required at low speeds.
- Arguments    N/A
- Example       No example.
- See also       **AXIS, SERVO\_PERIOD, VP\_SPEED, UNITS.**

## 4-2-166 MTYPE

- Type         Axis parameter (read-only)
- Syntax       **MTYPE**
- Description   The **MTYPE** parameter contains the type of move currently being executed. The possible values are given in the table below.

| Move number | Move type                           |
|-------------|-------------------------------------|
| 0           | <b>IDLE</b> (no move)               |
| 1           | <b>MOVE</b>                         |
| 2           | <b>MOVEABS</b>                      |
| 3           | <b>MHELICAL</b>                     |
| 4           | <b>MOVECIRC</b>                     |
| 5           | <b>MOVEMODIFY</b>                   |
| 10          | <b>FORWARD</b>                      |
| 11          | <b>REVERSE</b>                      |
| 12          | <b>DATUM</b>                        |
| 13          | <b>CAM</b>                          |
| 14          | JOG_FORWARD refer to <b>FWD_JOG</b> |
| 15          | JOG_REVERSE refer to <b>REV_JOG</b> |
| 20          | <b>CAMBOX</b>                       |
| 21          | <b>CONNECT</b>                      |
| 22          | <b>MOVELINK</b>                     |

**MTYPE** can be used to determine whether a move has finished or if a transition from one move type to another has taken place. A non-idle move type does not necessarily mean that the axis is actually moving. It can be at 0 speed part way along a move or interpolating with another axis without moving itself.

|           |                     |
|-----------|---------------------|
| Arguments | N/A                 |
| Example   | No example.         |
| See also  | <b>AXIS, NTYPE.</b> |

### 4-2-167 NEG\_OFFSET

|             |                                                                                                                                                                                                                                                                                                              |
|-------------|--------------------------------------------------------------------------------------------------------------------------------------------------------------------------------------------------------------------------------------------------------------------------------------------------------------|
| Type        | System parameter                                                                                                                                                                                                                                                                                             |
| Syntax      | <b>NEG_OFFSET=value</b>                                                                                                                                                                                                                                                                                      |
| Description | For Piezo Operation. This allows a negative offset to be applied to the output <b>S_REF</b> signal from the servo loop. An offset of 327 will represent an offset of 0.1 volts. It is suggested that as offset of 65% to 70% of the value required to make the stage move in an open loop situation is used. |
| Arguments   | <ul style="list-style-type: none"> <li>• <b>value</b><br/>A BASIC expression.</li> </ul>                                                                                                                                                                                                                     |
| Example     | No example.                                                                                                                                                                                                                                                                                                  |
| See also    | N/A                                                                                                                                                                                                                                                                                                          |

### 4-2-168 NEW

|             |                                                                                                                                                                                                                                                                                                                                                                                                                                                                                           |
|-------------|-------------------------------------------------------------------------------------------------------------------------------------------------------------------------------------------------------------------------------------------------------------------------------------------------------------------------------------------------------------------------------------------------------------------------------------------------------------------------------------------|
| Type        | Program command                                                                                                                                                                                                                                                                                                                                                                                                                                                                           |
| Syntax      | <b>NEW [ "program_name" ]</b>                                                                                                                                                                                                                                                                                                                                                                                                                                                             |
| Description | The <b>NEW</b> command deletes all program lines of the program in the controller. <b>NEW</b> without a program name can be used to delete the currently selected program (using <b>SELECT</b> ). The program name can also be specified without quotes. <b>NEW ALL</b> will delete all programs. The command can also be used to delete the TABLE memory. <b>NEW "TABLE"</b> The name " <b>TABLE</b> " must be in quotes. Note: This command is implemented for a Command Line Terminal. |
| Arguments   | N/A                                                                                                                                                                                                                                                                                                                                                                                                                                                                                       |
| Example     | No example.                                                                                                                                                                                                                                                                                                                                                                                                                                                                               |
| See also    | <b>COPY, DEL, RENAME, SELECT, TABLE</b>                                                                                                                                                                                                                                                                                                                                                                                                                                                   |

### 4-2-169 NEXT

See **FOR..TO..STEP..NEXT.**

**4-2-170 NOT**

Type Mathematical operation

Syntax **NOT expression**

Description The **NOT** operator performs the logical **NOT** function on all bits of the integer part of the expression.  
The logical **NOT** function is defined as in the table below.

| Bit | Result |
|-----|--------|
| 0   | 1      |
| 1   | 0      |

Arguments • **expression.**  
Any valid BASIC expression.

Example **>> PRINT 7 AND NOT 1**  
**6.0000**

See also N/A

**4-2-171 NTYPE**

Type Axis parameter (read-only)

Syntax **NTYPE**

Description The **NTYPE** parameter contains the type of the move in the next move buffer. Once the current move has finished, the move present in the **NTYPE** buffer will be executed. The values are the same as those for the **MTYPE** axis parameter.  
**NTYPE** is cleared by the **CANCEL(1)** command.

Arguments N/A

Example No example.

See also **AXIS, MTYPE.**

**4-2-172 OFF**

Type Constant (read-only)

Syntax **OFF**

Description The **OFF** constant returns the numerical value 0.

Arguments N/A

Example **OP (lever,OFF)**  
The above line sets the output named lever to OFF.

See also N/A

## 4-2-173 OFFPOS

|             |                                                                                                                                                                                                                                                                                                                                                                                                                                                                                                                                                                                                                                                                                                                              |
|-------------|------------------------------------------------------------------------------------------------------------------------------------------------------------------------------------------------------------------------------------------------------------------------------------------------------------------------------------------------------------------------------------------------------------------------------------------------------------------------------------------------------------------------------------------------------------------------------------------------------------------------------------------------------------------------------------------------------------------------------|
| Type        | Axis parameter                                                                                                                                                                                                                                                                                                                                                                                                                                                                                                                                                                                                                                                                                                               |
| Syntax      | <b>OFFPOS</b>                                                                                                                                                                                                                                                                                                                                                                                                                                                                                                                                                                                                                                                                                                                |
| Description | <p>The <b>OFFPOS</b> parameter contains an offset that will be applied to the demand position (<b>DPOS</b>) without affecting the move which is in progress in any other way. The measured position will be changed accordingly in order to keep the Following Error. OFFPOS can therefore be used to effectively datum a system at full speed. The value set in <b>OFFPOS</b> will be reset to 0 by the system as the offset is loaded.</p> <p>Note: The offset is applied on the next servo period. Other commands may be executed prior to the next servo period. Be sure that these commands do not assume the position shift has occurred. This can be done by using the <b>WAIT UNTIL</b> statement (see example).</p> |
| Arguments   | N/A                                                                                                                                                                                                                                                                                                                                                                                                                                                                                                                                                                                                                                                                                                                          |
| Example     | <p>Change the current position by 125, with the Command Line Terminal:</p> <pre>&gt;&gt;?DPOS<br/>300.0000<br/>&gt;&gt;OFFPOS=125<br/>&gt;&gt;?DPOS<br/>425.0000</pre>                                                                                                                                                                                                                                                                                                                                                                                                                                                                                                                                                       |
| Example     | <p>Define the current demand position as 0</p> <pre>OFFPOS=-DPOS<br/>WAIT UNTIL OFFPOS=0 ' wait until applied</pre> <p>This is equivalent to <b>DEFPOS(0)</b>.</p>                                                                                                                                                                                                                                                                                                                                                                                                                                                                                                                                                           |

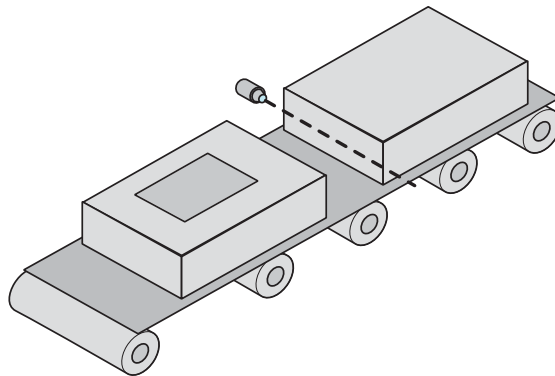

|          |                                                                                                                                                                                                                                                                                                                                                                                                                                                                                                                                                                                                                                                                                                                                            |
|----------|--------------------------------------------------------------------------------------------------------------------------------------------------------------------------------------------------------------------------------------------------------------------------------------------------------------------------------------------------------------------------------------------------------------------------------------------------------------------------------------------------------------------------------------------------------------------------------------------------------------------------------------------------------------------------------------------------------------------------------------------|
| Example  | A conveyor transports boxes. Labels must be applied onto these boxes. The <b>REGIST</b> function can capture the position at which the leading edge of the box is seen. Then, the <b>OFFPOS</b> command can adjust the measured position of the axis to make it 0 at that point. Thus, after the registration event has occurred, the measured position (seen in <b>MPOS</b> ) reflects the absolute distance from the start of the box. The mechanism that applies the label can take advantage of the absolute position start mode of the <b>MOVELINK</b> or <b>CAMBOX</b> commands to apply the label.<br><b>BASE(conv)</b><br><b>REGIST(3)</b><br><b>WAIT UNTIL MARK</b><br><b>OFFPOS = -REG_POS ' Leading edge of box is now zero</b> |
| See also | <b>AXIS, DEFPOS, DPOS, MPOS, UNITS.</b>                                                                                                                                                                                                                                                                                                                                                                                                                                                                                                                                                                                                                                                                                                    |

## 4-2-174 ON

|             |                                                                                   |
|-------------|-----------------------------------------------------------------------------------|
| Type        | Constant (read-only)                                                              |
| Syntax      | <b>ON</b>                                                                         |
| Description | The <b>ON</b> constant returns the numerical value 1.                             |
| Arguments   | N/A                                                                               |
| Example     | <b>OP (lever,ON)</b><br>The above line sets the output named lever to <b>ON</b> . |
| See also    | N/A                                                                               |

## 4-2-175 ON.. GOSUB

|             |                                                                                                                                                                                                                                                                                                                                                                                                                                                                                                                           |
|-------------|---------------------------------------------------------------------------------------------------------------------------------------------------------------------------------------------------------------------------------------------------------------------------------------------------------------------------------------------------------------------------------------------------------------------------------------------------------------------------------------------------------------------------|
| Type        | Program control command                                                                                                                                                                                                                                                                                                                                                                                                                                                                                                   |
| Syntax      | <b>ON expression GOSUB label [,label[,...]]</b>                                                                                                                                                                                                                                                                                                                                                                                                                                                                           |
| Description | The <b>ON..GOSUB</b> and <b>ON..GOTO</b> structures enable a conditional jump. The integer expression is used to select a label from the list. If the expression has value 1 the first label is used, for value 2 the second label is used, and so on. Once the label is selected, subroutine <b>GOSUB</b> jump to that label is performed.<br>Note: If the expression is not valid e.g. the result of the expression is less than 1 or greater than the number of available labels in the program, no jump is performed. |
| Arguments   | <ul style="list-style-type: none"> <li>• <b>expression</b><br/>Any valid BASIC expression.</li> <li>• <b>label</b><br/>Any valid label in the program.</li> </ul>                                                                                                                                                                                                                                                                                                                                                         |
| Example     | <b>REPEAT</b><br><b>GET#5,char</b><br><b>UNTIL 1&lt;=char and char&lt;=3</b><br><b>ON char GOSUB mover, stopper, change</b>                                                                                                                                                                                                                                                                                                                                                                                               |
| See also    | <b>GOSUB..RETURN, GOTO.</b>                                                                                                                                                                                                                                                                                                                                                                                                                                                                                               |

**4-2-176 ON.. GOTO**

|             |                                                                                                                                                                                                                                                                                                                                                                                                         |
|-------------|---------------------------------------------------------------------------------------------------------------------------------------------------------------------------------------------------------------------------------------------------------------------------------------------------------------------------------------------------------------------------------------------------------|
| Type        | Program control command                                                                                                                                                                                                                                                                                                                                                                                 |
| Syntax      | <b>ON expression GOTO label [,label[,...]]</b>                                                                                                                                                                                                                                                                                                                                                          |
| Description | The expression is evaluated and then the integer part is used to select a label from the list. If the expression has the value 1 then the first label is used, 2 then the second label is used, and so on. If the value of the expression is less than 1 or greater than the number of labels then an error occurs. Once the label is selected, subroutine <b>GOTO</b> jump to that label is performed. |
| Arguments   | <ul style="list-style-type: none"> <li>• <b>expression</b><br/>Any valid BASIC expression.</li> <li>• <b>label</b><br/>Any valid label in the program.</li> </ul>                                                                                                                                                                                                                                       |
| Example     | <b>REPEAT</b><br><b>GET #5,char</b><br><b>UNTIL 1&lt;=char and char&lt;=3</b><br><b>ON char GOTO mover,stopper,change</b>                                                                                                                                                                                                                                                                               |
| See also    | N/A                                                                                                                                                                                                                                                                                                                                                                                                     |

**4-2-177 OP**

|             |                                                                                                                                                                                                                                                                                                                                                                                                                                                                                                                                                                                                                                                                                                                                                                                                                                                                                                                                                            |
|-------------|------------------------------------------------------------------------------------------------------------------------------------------------------------------------------------------------------------------------------------------------------------------------------------------------------------------------------------------------------------------------------------------------------------------------------------------------------------------------------------------------------------------------------------------------------------------------------------------------------------------------------------------------------------------------------------------------------------------------------------------------------------------------------------------------------------------------------------------------------------------------------------------------------------------------------------------------------------|
| Type        | I/O command                                                                                                                                                                                                                                                                                                                                                                                                                                                                                                                                                                                                                                                                                                                                                                                                                                                                                                                                                |
| Syntax      | <b>OP(output_number, value)</b><br><b>OP(binary_pattern)</b><br><b>OP</b>                                                                                                                                                                                                                                                                                                                                                                                                                                                                                                                                                                                                                                                                                                                                                                                                                                                                                  |
| Description | <p>The <b>OP</b> command sets one or more outputs or returns the state of the first 24 outputs. <b>OP</b> has three different forms depending on the number of arguments.</p> <ul style="list-style-type: none"> <li>• Command <b>OP(output_number,value)</b> sets a single output channel. The range of <b>output_number</b> depends on the number of additional digital I/O connected to the PLC and <b>value</b> is the value to be output, either 0 or 1.</li> <li>• Command <b>OP(binary_pattern)</b> sets the binary pattern to the 24 outputs according to the value set by <b>binary_pattern</b>.</li> <li>• Function <b>OP (without arguments)</b> returns the status of the first 24 outputs. This allows multiple outputs to be set without corrupting others which are not to be changed.</li> </ul> <p>Note: The first 8 outputs (0 to 7) do not physically exist on the CJ1W-MCH72. They can not be written to and will always return 0.</p> |
| Arguments   | <ul style="list-style-type: none"> <li>• <b>output_number</b><br/>The number of the output to be set. The range for this parameter depends on the number of additional digital I/O connected to the PLC. If there are no digital I/O connected, the range for this parameter is 8..31</li> <li>• <b>value</b><br/>The value to be output, either OFF (0) or ON (1). All non-0 values are considered as ON.</li> <li>• <b>binary_pattern</b><br/>The integer equivalent of the binary pattern is to be output.</li> </ul>                                                                                                                                                                                                                                                                                                                                                                                                                                   |

|          |                                                                                                                                                                                                                                                                               |
|----------|-------------------------------------------------------------------------------------------------------------------------------------------------------------------------------------------------------------------------------------------------------------------------------|
| Example  | <b>OP(12,1)</b><br><b>OP(12,ON)</b><br>These two lines are equivalent.                                                                                                                                                                                                        |
| Example  | <b>OP(18*256)</b><br>This line sets the bit pattern 10010 on the first 5 physical outputs, outputs 13 to 17 would be cleared. The bit pattern is shifted 8 bits by multiplying by 256 to set the first available outputs as outputs 0 to 7 do not exist.                      |
| Example  | <b>VR(0) = OP</b><br><b>VR(0) = VR(0) OR \$FF00</b><br><b>OP(VR(0))</b><br>This routine sets outputs 8 to 15 <b>ON</b> and all others off.<br>The above programming can also be written as follows:<br><b>OP(OP OR \$FF00)</b>                                                |
| Example  | <b>val = 8 ' The value to set</b><br><b>mask = OP AND NOT(15*256) ' Get current status and mask</b><br><b>OP(mask OR val*256) ' Set val to OP(8) to OP(11)</b><br>This routine sets value <b>val</b> to outputs 8 to 11 without affecting the other outputs by using masking. |
| See also | <b>IN.</b>                                                                                                                                                                                                                                                                    |

## 4-2-178 OPEN\_WIN

|             |                                                                                                                                                                  |
|-------------|------------------------------------------------------------------------------------------------------------------------------------------------------------------|
| Type        | Axis parameter                                                                                                                                                   |
| Syntax      | <b>OPEN_WIN</b><br><b>OW</b>                                                                                                                                     |
| Description | The <b>OPEN_WIN</b> parameter defines the beginning of the window inside or outside which a registration event is expected. The value is in user units.          |
| Arguments   | N/A                                                                                                                                                              |
| Example     | <b>only look for registration marks between 170 and 230</b><br><b>OPEN_WIN = 170</b><br><b>CLOSE_WIN = 230</b><br><b>REGIST(256+3)</b><br><b>WAIT UNTIL MARK</b> |
| See also    | <b>CLOSE_WIN, REGIST, UNITS.</b>                                                                                                                                 |

**4-2-179 OR**

Type           Mathematical operation

Syntax         **expression1 OR expression2**

Description    The **OR** operator performs the logical **OR** function between corresponding bits of the integer parts of two valid BASIC expressions.  
The logical **OR** function between two bits is defined as in the table below.

| Bit 1 | Bit 2 | Result |
|-------|-------|--------|
| 0     | 0     | 0      |
| 0     | 1     | 1      |
| 1     | 0     | 1      |
| 1     | 1     | 1      |

Arguments     • **expression1**  
Any valid BASIC expression.

                 • **expression2**  
Any valid BASIC expression.

Example       **result = 10 OR (2.1\*9)**  
The parentheses are evaluated first, but only the integer part of the result, 18, is used for the operation. Therefore, this expression is equivalent to the following:  
**result = 10 OR 18**  
The **OR** is a bit operator and so the binary action taking place is:  
**01010 OR 10010 = 11010**  
Therefore, result will contain the value 26.

Example       **IF VR(0) = 1 OR VR(0) = 2 THEN GOTO label**

See also       N/A

**4-2-180 OUTLIMIT**

Type           Axis parameter

Syntax         **OUTLIMIT**

Description    The output limit restricts the demand output from a servo axis to a lower value than the maximum. For a MECHATROLINK-II speed axis the maximum demand output possible is the 32 bit value 2147483648.

Arguments     N/A

Example       **OUTLIMIT AXIS(1) = 1073741824**  
The above will limit the demand output to half of the maximum possible output. This will apply to the **S\_REF** command if **SERVO** is off, or to the output by the servo loop if **SERVO** is on.

See also       **AXIS, S\_REF, S\_REF\_OUT, SERVO.**



**4-2-181 OV\_GAIN**

|             |                                                                                                                                                                                                                                                                                                                                                                                                                                                                                                                                                                                                                                                                                                                                                                                             |
|-------------|---------------------------------------------------------------------------------------------------------------------------------------------------------------------------------------------------------------------------------------------------------------------------------------------------------------------------------------------------------------------------------------------------------------------------------------------------------------------------------------------------------------------------------------------------------------------------------------------------------------------------------------------------------------------------------------------------------------------------------------------------------------------------------------------|
| Type        | Axis parameter                                                                                                                                                                                                                                                                                                                                                                                                                                                                                                                                                                                                                                                                                                                                                                              |
| Syntax      | <b>OV_GAIN</b>                                                                                                                                                                                                                                                                                                                                                                                                                                                                                                                                                                                                                                                                                                                                                                              |
| Description | <p>The <b>OV_GAIN</b> parameter contains the output velocity gain. The output velocity output contribution is calculated by multiplying the change in measured position with the <b>OV_GAIN</b> parameter value. The default value is 0.</p> <p>Adding negative output velocity gain to a system is mechanically equivalent to adding damping. It is likely to produce a smoother response and allow the use of a higher proportional gain than could otherwise be used, but at the expense of higher Following Errors. High values may cause oscillation and produce high Following Errors.</p> <p>Note: Negative values are normally required for <b>OV_GAIN</b>.</p> <p>Note: In order to avoid any instability the servo gains should be changed only when the <b>SERVO</b> is off.</p> |
| Arguments   | N/A                                                                                                                                                                                                                                                                                                                                                                                                                                                                                                                                                                                                                                                                                                                                                                                         |
| Example     | No example.                                                                                                                                                                                                                                                                                                                                                                                                                                                                                                                                                                                                                                                                                                                                                                                 |
| See also    | <b>D_GAIN, I_GAIN, P_GAIN, VFF_GAIN.</b>                                                                                                                                                                                                                                                                                                                                                                                                                                                                                                                                                                                                                                                                                                                                                    |

**4-2-182 P\_GAIN**

|             |                                                                                                                                                                                                                                                                                                                                                                                                                                                                                                                                                                                                                                                                                 |
|-------------|---------------------------------------------------------------------------------------------------------------------------------------------------------------------------------------------------------------------------------------------------------------------------------------------------------------------------------------------------------------------------------------------------------------------------------------------------------------------------------------------------------------------------------------------------------------------------------------------------------------------------------------------------------------------------------|
| Type        | Axis parameter                                                                                                                                                                                                                                                                                                                                                                                                                                                                                                                                                                                                                                                                  |
| Syntax      | <b>P_GAIN</b>                                                                                                                                                                                                                                                                                                                                                                                                                                                                                                                                                                                                                                                                   |
| Description | <p>The <b>P_GAIN</b> parameter contains the proportional gain. The proportional output contribution is calculated by multiplying the Following Error with the <b>P_GAIN</b> parameter value. The default value of <b>P_GAIN</b> for MECHATROLINK-II Speed axis (<b>ATYPE = 41</b>) is 131072. The default value for Encoder Interface In (<b>ATYPE = 44</b>) is 1.0.</p> <p>The proportional gain sets the stiffness of the servo response. Values that are too high will cause oscillation. Values that are too low will cause large Following Errors.</p> <p>Note: In order to avoid any instability the servo gains should be changed only when the <b>SERVO</b> is off.</p> |
| Arguments   | N/A                                                                                                                                                                                                                                                                                                                                                                                                                                                                                                                                                                                                                                                                             |
| Example     | No example.                                                                                                                                                                                                                                                                                                                                                                                                                                                                                                                                                                                                                                                                     |
| See also    | <b>D_GAIN, I_GAIN, OV_GAIN, VFF_GAIN.</b>                                                                                                                                                                                                                                                                                                                                                                                                                                                                                                                                                                                                                                       |

**4-2-183 PI**

|             |                                                                                       |
|-------------|---------------------------------------------------------------------------------------|
| Type        | Constant (read-only)                                                                  |
| Syntax      | <b>PI</b>                                                                             |
| Description | The <b>PI</b> constant returns the numerical constant value of approximately 3.14159. |
| Arguments   | N/A                                                                                   |
| Example     | <b>circum = 100</b><br><b>PRINT "Radius = "; circum/(2*PI)</b>                        |
| See also    | N/A                                                                                   |

## 4-2-184 PLC\_EXCHANGE

|             |                                                                                                                                                                                                                                                                                                                                                                                                                                                                                                                                                                                                                                                                                                                                                                                                                                                                                                                                                                                                                                                                                                                                                                                                                                                                                                                                                                                                                                                                                                                                                                                                                              |
|-------------|------------------------------------------------------------------------------------------------------------------------------------------------------------------------------------------------------------------------------------------------------------------------------------------------------------------------------------------------------------------------------------------------------------------------------------------------------------------------------------------------------------------------------------------------------------------------------------------------------------------------------------------------------------------------------------------------------------------------------------------------------------------------------------------------------------------------------------------------------------------------------------------------------------------------------------------------------------------------------------------------------------------------------------------------------------------------------------------------------------------------------------------------------------------------------------------------------------------------------------------------------------------------------------------------------------------------------------------------------------------------------------------------------------------------------------------------------------------------------------------------------------------------------------------------------------------------------------------------------------------------------|
| Type        | System command                                                                                                                                                                                                                                                                                                                                                                                                                                                                                                                                                                                                                                                                                                                                                                                                                                                                                                                                                                                                                                                                                                                                                                                                                                                                                                                                                                                                                                                                                                                                                                                                               |
| Syntax      | <b>PLC_EXCHANGE(0, area_code)</b><br><b>PLC_EXCHANGE(1, area_code, plc_area, plc_start, tj_area, tj_start, total_items)</b>                                                                                                                                                                                                                                                                                                                                                                                                                                                                                                                                                                                                                                                                                                                                                                                                                                                                                                                                                                                                                                                                                                                                                                                                                                                                                                                                                                                                                                                                                                  |
| Description | <b>PLC_EXCHANGE(0, ...)</b> prints the mapping of the PLC memory area specified by <b>area_code</b> to the CJ1W-MCH72 memory. The output of this command is: <b>area_code, plc_area, plc_start, tj_area, tj_start, total_items</b> .<br><b>PLC_EXCHANGE(1, ...)</b> configures the mapping of the PLC memory to the CJ1W-MCH72 memory.                                                                                                                                                                                                                                                                                                                                                                                                                                                                                                                                                                                                                                                                                                                                                                                                                                                                                                                                                                                                                                                                                                                                                                                                                                                                                       |
| Arguments   | <ul style="list-style-type: none"> <li>• <b>area_code</b><br/>The PLC area. Possible values in hexadecimal are: <ul style="list-style-type: none"> <li>- 0100..0107 for PLC output area (8 areas available)</li> <li>- 8100..8107 for PLC input area (8 areas available)</li> </ul> </li> <li>• <b>plc_area</b><br/>The PLC memory area used for data exchange. Possible values in hexadecimal are: <ul style="list-style-type: none"> <li>- 01 : CIO</li> <li>- 03 : DM</li> <li>- 04 : WR</li> <li>- 05 : HR</li> <li>- 08..14 : EM bank 0..C</li> </ul> </li> <li>• <b>plc_start</b><br/>The start address in PLC memory.<br/>Note: The validity depends on <b>plc_area</b>.</li> <li>• <b>tj_area</b><br/>The CJ1W-MCH72 memory area used for data exchange. Possible values are: <ul style="list-style-type: none"> <li>- 00 : VR 16-bit signed integer</li> <li>- 01 : VR 32-bit floating point</li> <li>- 02 : IN or OP array, depending on direction</li> <li>- 03 : AIN or AOUT array, depending on direction</li> <li>- 04 : Axis Status array, only valid if direction is PLC input</li> </ul> </li> <li>• <b>tj_start</b><br/>The tart address in CJ1W-MCH72 memory.<br/>Note: The validity depends on <b>tj_area</b>.<br/>Note: The first 16 entries in the IN array are invalid start addresses.</li> <li>• <b>total_items</b><br/>The total number of items (words and dwords) to transfer<br/>Note: The validity depends on <b>plc_area</b> and <b>tj_area</b>.<br/>Note: The total number of words configured for all blocks may not exceed 2000. A floating point value corresponds to 2 words.</li> </ul> |
| Example     | No example.                                                                                                                                                                                                                                                                                                                                                                                                                                                                                                                                                                                                                                                                                                                                                                                                                                                                                                                                                                                                                                                                                                                                                                                                                                                                                                                                                                                                                                                                                                                                                                                                                  |
| See also    | <b>PLC_STATUS</b>                                                                                                                                                                                                                                                                                                                                                                                                                                                                                                                                                                                                                                                                                                                                                                                                                                                                                                                                                                                                                                                                                                                                                                                                                                                                                                                                                                                                                                                                                                                                                                                                            |

## 4-2-185 PLC\_STATUS

|             |                                                                                                                                                                               |
|-------------|-------------------------------------------------------------------------------------------------------------------------------------------------------------------------------|
| Type        | System parameter (read-only)                                                                                                                                                  |
| Syntax      | <b>PLC_STATUS(mode)</b>                                                                                                                                                       |
| Description | The <b>PLC_STATUS(0)</b> system parameter contains the monitored PLC CPU/PC21 bus status. The status consists of status bits, which definitions are shown in the table below. |

| Bit number | Description                                              |
|------------|----------------------------------------------------------|
| 8          | PLC Program Mode flag                                    |
| 9          | FALS (Severe Failure) PLC flag                           |
| 10         | FAL (Non-severe Failure) PLC flag                        |
| 11         | LOAD OFF PLC flag                                        |
| 12         | Axes watchdog enable monitor. See word n, bit 1 3-3-1-1. |
| 14         | Output enable monitor. See word n, bit 3 3-3-1-1.        |

**PLC\_STATUS(1)** returns the elapsed time in milliseconds since the last PLC cyclic service. This function allows you to monitor the PLC CPU using a shorter time than the default of 11 seconds.

|           |                                                                                                                                                       |
|-----------|-------------------------------------------------------------------------------------------------------------------------------------------------------|
| Arguments | <ul style="list-style-type: none"> <li><b>mode</b><br/>0 or 1, to return the status or the elapsed time since the last PLC cyclic service.</li> </ul> |
| Example   | No example.                                                                                                                                           |
| See also  | <b>PLC_EXCHANGE</b>                                                                                                                                   |

## 4-2-186 PMOVE

|             |                                                                                                                                                                                                                                                                                                                                                                                                                                                                                                                                                                                                                                                                                                                                                                                                                                                                                                                                                     |
|-------------|-----------------------------------------------------------------------------------------------------------------------------------------------------------------------------------------------------------------------------------------------------------------------------------------------------------------------------------------------------------------------------------------------------------------------------------------------------------------------------------------------------------------------------------------------------------------------------------------------------------------------------------------------------------------------------------------------------------------------------------------------------------------------------------------------------------------------------------------------------------------------------------------------------------------------------------------------------|
| Type        | Task parameter (read-only)                                                                                                                                                                                                                                                                                                                                                                                                                                                                                                                                                                                                                                                                                                                                                                                                                                                                                                                          |
| Syntax      | <b>PMOVE</b>                                                                                                                                                                                                                                                                                                                                                                                                                                                                                                                                                                                                                                                                                                                                                                                                                                                                                                                                        |
| Description | <p>The <b>PMOVE</b> parameter contains the status of the task buffers. The parameter returns <b>TRUE</b> if the task buffers are occupied, and <b>FALSE</b> if they are empty.</p> <p>When the task executes a movement command, the task loads the movement information into the task move buffers. The buffers can hold one movement instruction for any group of axes. <b>PMOVE</b> will be set to <b>TRUE</b> when loading of the buffers has been completed. When the next servo interrupt occurs, the motion generator loads the movement into the next move (<b>NTYPE</b>) buffer of the required axes if they are available. When this second transfer has been completed, <b>PMOVE</b> is cleared to 0 until another move is executed in the task.</p> <p>Each task has its own <b>PMOVE</b> parameter. Use the <b>PROC</b> modifier to access the parameter for a certain task. Without <b>PROC</b> the current task will be assumed.</p> |
| Arguments   | N/A                                                                                                                                                                                                                                                                                                                                                                                                                                                                                                                                                                                                                                                                                                                                                                                                                                                                                                                                                 |
| Example     | No example.                                                                                                                                                                                                                                                                                                                                                                                                                                                                                                                                                                                                                                                                                                                                                                                                                                                                                                                                         |
| See also    | <b>NTYPE, PROC.</b>                                                                                                                                                                                                                                                                                                                                                                                                                                                                                                                                                                                                                                                                                                                                                                                                                                                                                                                                 |

### 4-2-187 POS\_OFFSET

|             |                                                                                                                                                                                                                                                                                                                                                                             |
|-------------|-----------------------------------------------------------------------------------------------------------------------------------------------------------------------------------------------------------------------------------------------------------------------------------------------------------------------------------------------------------------------------|
| Type        | System parameter                                                                                                                                                                                                                                                                                                                                                            |
| Syntax      | <b>POS_OFFSET=value</b>                                                                                                                                                                                                                                                                                                                                                     |
| Description | For Piezo Operation. This keyword allows a positive offset to be applied to the output <b>S_REF</b> signal from the servo loop. An offset of 327 will represent an offset of 0.1 volts for axis with servo output generated by a 16 bit S_REF. It is suggested that as offset of 65% to 70% of the value required to make the stage move in an open loop situation is used. |
| Arguments   | N/A                                                                                                                                                                                                                                                                                                                                                                         |
| Example     | No example.                                                                                                                                                                                                                                                                                                                                                                 |
| See also    | N/A                                                                                                                                                                                                                                                                                                                                                                         |

### 4-2-188 POWER\_UP

|             |                                                                                                                                                                                                                                                                                                                                                                                                                                                                                                                                                                                              |
|-------------|----------------------------------------------------------------------------------------------------------------------------------------------------------------------------------------------------------------------------------------------------------------------------------------------------------------------------------------------------------------------------------------------------------------------------------------------------------------------------------------------------------------------------------------------------------------------------------------------|
| Type        | System parameter                                                                                                                                                                                                                                                                                                                                                                                                                                                                                                                                                                             |
| Syntax      | <b>POWER_UP</b>                                                                                                                                                                                                                                                                                                                                                                                                                                                                                                                                                                              |
| Description | This parameter is used to determine whether or not programs should be read from flash EPROM on power up or software reset ( <b>EX</b> ).<br>Two values are possible: 0: Use the programs in battery backed RAM;<br>1: Copy programs from the controllers flash EPROM into RAM.<br>Programs are individually selected to be run at power up with the <b>RUNTYPE</b> command<br>Notes: <ul style="list-style-type: none"><li>• <b>POWER_UP</b> is always an immediate command and therefore cannot be included in programs.</li><li>• This value is normally set by Trajexia Studio.</li></ul> |
| Arguments   | N/A                                                                                                                                                                                                                                                                                                                                                                                                                                                                                                                                                                                          |
| Example     | No example.                                                                                                                                                                                                                                                                                                                                                                                                                                                                                                                                                                                  |
| See also    | <b>EPROM</b>                                                                                                                                                                                                                                                                                                                                                                                                                                                                                                                                                                                 |

4-2-189 PRINT

- Type I/O command
- Syntax **PRINT [ #n, ] expression { , expression }  
? [ #n, ] expression { , expression }**
- Description The **PRINT** command outputs a series of characters to the communication ports. **PRINT** can output parameters, fixed ASCII strings, and single ASCII characters. By using **PRINT #n**, any port can be selected to output the information to.  
Multiple items to be printed can be put on the same line separated by a comma or a semi-colon. A comma separator in the print command places a tab between the printed items. The semi-colon separator prints the next item without any spaces between printed items.  
The width of the field in which a number is printed can be set with the use of [w,x] after the number to be printed. The width of the column is given by w and the number of decimal places is given by x. Using only one parameter [x] takes the default width and specifies the number of decimal places to be printed. The numbers are right aligned in the field with any unused leading characters being filled with spaces. If the number is too long, then the field will be filled with asterisks to signify that there was not sufficient space to display the number. The maximum field width allowable is 127 characters.  
The backslash \ command can be used to print a single ASCII character.
- Arguments
  - **n**  
The specified output device. When this argument is omitted, the port is 0 (Terminal window). See the table below.

| Value | Description                           |
|-------|---------------------------------------|
| 0     | Programming port 0 (default)          |
| 5     | Trajexia Studio port 0 user channel 5 |
| 6     | Trajexia Studio port 0 user channel 6 |
| 7     | Trajexia Studio port 0 user channel 7 |

- **expression**  
The expression to be printed.
- Example **PRINT "CAPITALS and lower case CAN BE PRINTED"**
- Example Consider VR(1) = 6 and **variab** = 1.5, the print output will be as follows:  
**PRINT 123.45, VR(1)-variab**  
**123.4500 4.5000**
- Example **length:**  
**PRINT "DISTANCE = ";mpos**  
**DISTANCE = 123.0000**  
In this example, the semi-colon separator is used. This does not tab into the next column, allowing the programmer more freedom in where the print items are placed.
- Example **PRINT VR(1)[ 4,1 ]; variab[ 6,2 ]**  
**6.0 1.50**

Example **params:**  
**PRINT "DISTANCE = ";mpos[ 0 ];"** **SPEED = ";v[ 2 ];**  
**DISTANCE = 123 SPEED = 12.34**

Example **PRINT "ITEM ";total" OF ";limit;CHR(13);**

Example **>> PRINT HEX(15),HEX(-2)**  
**F FFFFA**

See also **\$ (HEXADECIMAL INPUT)**

## 4-2-190 PROC

Type Task command

Syntax **PROC(task\_number)**

Description The **PROC** modifier allows a process parameter from a particular process to be read or written. If omitted, the current task will be assumed.

Arguments

- **task\_number**  
The number of the task to access.

Example **WAIT UNTIL PMOVE PROC(3)=0**

See also N/A

## 4-2-191 PROC\_STATUS

Type Task parameter

Syntax **PROC\_STATUS**

Description The **PROC\_STATUS** parameter returns the status of the process or task specified. The parameter is used with the **PROC** modifier and can return values listed in the table below.

| Value | Description      |
|-------|------------------|
| 0     | Process stopped  |
| 1     | Process running  |
| 2     | Process stepping |
| 3     | Process paused   |

Arguments N/A

Example **WAIT UNTIL PROC\_STATUS PROC(3)=0**

See also **PROCNUMBER, PROC.**

**4-2-192 PROCESS**

|             |                                                                                                     |
|-------------|-----------------------------------------------------------------------------------------------------|
| Type        | Program command                                                                                     |
| Syntax      | <b>PROCESS</b>                                                                                      |
| Description | The <b>PROCESS</b> command displays the running status of all current tasks with their task number. |
| Arguments   | N/A                                                                                                 |
| Example     | No example.                                                                                         |
| See also    | <b>HALT, RUN, STOP.</b>                                                                             |

**4-2-193 PROCNUMBER**

|             |                                                                                                                                                                                                                           |
|-------------|---------------------------------------------------------------------------------------------------------------------------------------------------------------------------------------------------------------------------|
| Type        | Task parameter (read-only)                                                                                                                                                                                                |
| Syntax      | <b>PROCNUMBER</b>                                                                                                                                                                                                         |
| Description | The <b>PROCNUMBER</b> parameter contains the number of the task in which the currently selected program is running. <b>PROCNUMBER</b> is often required when multiple copies of a program are running on different tasks. |
| Arguments   | N/A                                                                                                                                                                                                                       |
| Example     | <b>MOVE(length) AXIS(PROCNUMBER)</b>                                                                                                                                                                                      |
| See also    | <b>PROC_STATUS, PROC.</b>                                                                                                                                                                                                 |

**4-2-194 PSWITCH**

|             |                                                                                                                                                                                                                                                                                                                                                                                                                                                                                                                                                                                                                                                                                                                                                                                                                                                                                                                                                                                                                                                                                                                                                                                                                                                                          |
|-------------|--------------------------------------------------------------------------------------------------------------------------------------------------------------------------------------------------------------------------------------------------------------------------------------------------------------------------------------------------------------------------------------------------------------------------------------------------------------------------------------------------------------------------------------------------------------------------------------------------------------------------------------------------------------------------------------------------------------------------------------------------------------------------------------------------------------------------------------------------------------------------------------------------------------------------------------------------------------------------------------------------------------------------------------------------------------------------------------------------------------------------------------------------------------------------------------------------------------------------------------------------------------------------|
| Type        | I/O command                                                                                                                                                                                                                                                                                                                                                                                                                                                                                                                                                                                                                                                                                                                                                                                                                                                                                                                                                                                                                                                                                                                                                                                                                                                              |
| Syntax      | <b>PSWITCH(switch, enable [ , axis, output_number, output_state, set_position, reset_position ])</b>                                                                                                                                                                                                                                                                                                                                                                                                                                                                                                                                                                                                                                                                                                                                                                                                                                                                                                                                                                                                                                                                                                                                                                     |
| Description | <p>The <b>PSWITCH</b> command turns on an output when a predefined position is reached, and turns off the output when a second position is reached. The positions are specified as the measured absolute positions. There are 16 position switches each of which can be assigned to any axis. Each switch has assigned its own ON and OFF positions and output number.</p> <p>The command can be used with 2 or all 7 arguments. With only 2 arguments a given switch can be disabled.</p> <p><b>PSWITCHes</b> are calculated on each servo cycle and the output result applied to the hardware. The response time is therefore 1 servo cycle period approximately.</p> <p>Note: An output may remain ON if it was ON when the <b>PSWITCH</b> was disabled. In such cases the <b>OP</b> command can be used to turn off an output as follows:</p> <p><b>PSWITCH(2,OFF)</b><br/> <b>OP(14,OFF) ' Turn OFF pswitch controlling OP 14</b></p> <p>Note: The physical switches that are used with <b>PSWITCH</b> are not fast hardware switches, so switching is done by software, which can introduce some small delays in operation. Fast hardware switching can be used only with an axis connected via the Encoder Interface port. Use the <b>HW_PSWITCH</b> command.</p> |

- Arguments
- **switch**  
The switch number. Range: [0,15].
  - **enable**  
The switch enable. Range: [on, off].
  - **axis**  
The number of the axis providing the position input.
  - **output\_number**  
The physical output to set. Range: [8,31].
  - **output\_state**  
The state to output. Range: [on, off].
  - **set\_position**  
The absolute position in user units at which output is set.
  - **reset\_position**  
The absolute position in user units at which output is reset.

Example

A rotating shaft has a cam operated switch which has to be changed for different size work pieces. There is also a proximity switch on the shaft to indicate the TDC of the machine. With a mechanical cam, the change from job to job is time consuming. This can be eased by using **PSWITCH** as a software cam switch. The proximity switch is wired to input 7 and the output is output 11. The shaft is controlled by axis 0. The motor has a 900ppr encoder. The output must be on from 80 units. **PSWITCH** uses the unit conversion factor to allow the positions to be set in convenient units. First the unit conversion factor must be calculated and set. Each pulse on an encoder gives four edges for the CJ1W-MCH72 to count. There are thus 3,600 edges/rev or 10 edges/degree. If you set the unit conversion factor to 10, you can work in degrees. Next you have to determine a value for all the **PSWITCH** arguments. **sw**: The switch number can be any switch that is not in use. In this example, you will use number 0. **en**: The switch must be enabled to work; set the enable to 1. **axis**: The shaft is controlled by axis 0. **opno**: The output being controlled is output 11. **opst**: The output must be on so set to 1. **setpos**: The output is to produced at 80 units. **rspos**: The output is to be on for a period of 120 units. This can all be put together in the following lines of BASIC code:

**switch:**

```

UNITS AXIS(0) = 10 ' Set unit conversion factor
REP_DIST = 360
REP_OPTION = ON
PSWITCH(0,ON,0,11,ON,80,200)

```

This program uses the repeat distance set to 360 degrees and the repeat option on so that the axis position will be maintained between 0 and 360 degrees.

See also **HW\_PSWITCH, OP, UNITS.**



## 4-2-195 RAPIDSTOP

|             |                                                                                                                                                                                                                                                                                                                                                                                                                                                                                                                                                                                                                                                                                                                                                                                              |
|-------------|----------------------------------------------------------------------------------------------------------------------------------------------------------------------------------------------------------------------------------------------------------------------------------------------------------------------------------------------------------------------------------------------------------------------------------------------------------------------------------------------------------------------------------------------------------------------------------------------------------------------------------------------------------------------------------------------------------------------------------------------------------------------------------------------|
| Type        | Axis command                                                                                                                                                                                                                                                                                                                                                                                                                                                                                                                                                                                                                                                                                                                                                                                 |
| Syntax      | <b>RAPIDSTOP</b><br><b>RS</b>                                                                                                                                                                                                                                                                                                                                                                                                                                                                                                                                                                                                                                                                                                                                                                |
| Description | <p>The <b>RAPIDSTOP</b> command cancels the current move on all axes from the current move buffer (<b>MTYPE</b>). Moves for speed profiled move commands (<b>MOVE</b>, <b>MOVEABS</b>, <b>MOVEMODIFY</b>, <b>FORWARD</b>, <b>REVERSE</b>, <b>MOVECIRC</b> and <b>MHELICAL</b>) will decelerate to a stop with the deceleration rate as set by the <b>DECEL</b> parameter. Moves for other commands will be immediately stopped.</p> <p>Notes:</p> <ul style="list-style-type: none"> <li>• <b>RAPIDSTOP</b> cancels only the presently executing moves. If further moves are buffered in the next move buffers (<b>NTYPE</b>) or the task buffers they will then be loaded.</li> <li>• During the deceleration of the current moves additional <b>RAPIDSTOPs</b> will be ignored.</li> </ul> |
| Arguments   | N/A                                                                                                                                                                                                                                                                                                                                                                                                                                                                                                                                                                                                                                                                                                                                                                                          |

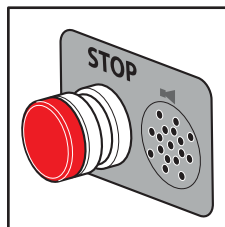
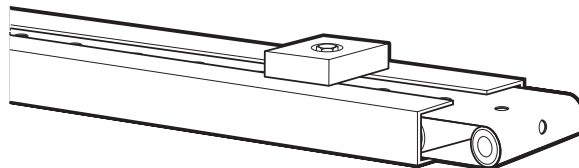

|         |                                                                                                                                                                                                                                                                                                                                                                                                                                       |
|---------|---------------------------------------------------------------------------------------------------------------------------------------------------------------------------------------------------------------------------------------------------------------------------------------------------------------------------------------------------------------------------------------------------------------------------------------|
| Example | <p>This example shows the implementation of a stop override button that cuts out all motion.</p> <pre> CONNECT (1,0) AXIS(1) 'axis 1 follows axis 0 BASE(0) REPAEAT MOVE(1000) AXIS (0) MOVE(-100000) AXIS (0) MOVE(100000) AXIS (0) UNTIL IN (2)=OFF 'stop button pressed? RAPIDSTOP WA(10) 'wait to allow running move to cancel RAPIDSTOP 'cancel the second buffered move WA(10) RAPIDSTOP 'cancel the third buffered move </pre> |
|---------|---------------------------------------------------------------------------------------------------------------------------------------------------------------------------------------------------------------------------------------------------------------------------------------------------------------------------------------------------------------------------------------------------------------------------------------|

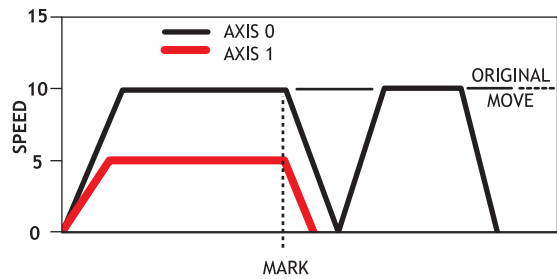

Example This example shows the use of **RAPIDSTOP** to cancel a **MOVE** on the main axis and a **FORWARD** on the second axis. When the axes have stopped, a **MOVEABS** is applied to re-position the main axis.

```

BASE(0)
REGIST(3)
FORWARD AXIS(1)
MOVE (100000) 'apply a long move
WAIT UNTIL MARK
RAPIDSTOP
WAIT IDLE 'for MOVEABS to be accurate, the axis must stop
MOVEABS(3000)

```

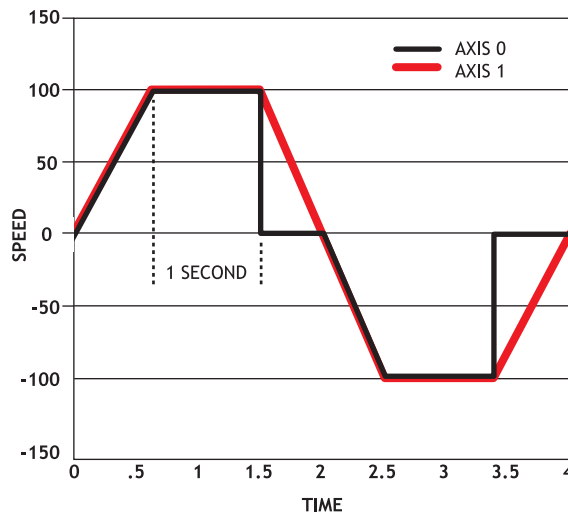

Example This example shows the use of **RAPIDSTOP** to break a **CONNECT** and stop the motion. The connected axis stops immediately on the **RAPIDSTOP** command. The forward axis decelerates at the **DECEL** value.

```

BASE(0)
CONNECT(1,1)
FORWARD AXIS(1)
WAIT UNTIL VPSPEED=SPEED 'let the axis get to full speed
WA(1000)
RAPIDSTOP
WAIT IDLE AXIS(1) 'wait for axis 1 to decel
CONNECT(1,1) 're-connect axis 0
REVERSE AXIS(1)
WAIT UNTIL VPSPEED=SPEED
WA(1000)
RAPIDSTOP
WAIT IDLE AXIS(1)

```

See also **CANCEL, MTYPE, NTYPE.**

## 4-2-196 READ\_BIT

Type System command

Syntax **READ\_BIT(bit\_number, vr\_number)**

Description The **READ\_BIT** command returns the value of the specified bit in the specified VR variable, either 0 or 1.

Arguments

- **bit\_number**  
The number of the bit to be read. Range: [0,23].
- **vr\_number**  
The number of the VR variable for which the bit is read. Range: [0,1023].

Example No example.

See also **CLEAR\_BIT, SET\_BIT.**

**4-2-197 READ\_OP**

|             |                                                                                                                                                                                                                                                                                                                                                                                                                                                                                                                                                                                                                                                                                                        |
|-------------|--------------------------------------------------------------------------------------------------------------------------------------------------------------------------------------------------------------------------------------------------------------------------------------------------------------------------------------------------------------------------------------------------------------------------------------------------------------------------------------------------------------------------------------------------------------------------------------------------------------------------------------------------------------------------------------------------------|
| Type        | I/O command                                                                                                                                                                                                                                                                                                                                                                                                                                                                                                                                                                                                                                                                                            |
| Syntax      | <b>READ_OP(output_no)</b><br><b>READ_OP(first_output_no, last_output_no)</b>                                                                                                                                                                                                                                                                                                                                                                                                                                                                                                                                                                                                                           |
| Description | <b>READ_OP(output_no)</b> , returns the binary value (0 or 1) of the digital output <b>output_no</b> .<br><b>READ_OP(first_output_no, last_output_no)</b> , returns the number that is the decimal representation of the concatenation of the binary values of the range <b>first_output_no</b> to <b>final_output_no</b> .<br>Note: The difference between <b>first_output_no</b> and <b>last_output_no</b> must be less than 24.<br>Note: Outputs 0 to 7 do not physically exist on the CJ1W-MCH72. They cannot be written. Their return value is always 0.<br>Note: <b>READ_OP</b> checks the state of the output logic. <b>READ_OP</b> can return the value 1 even if no actual output is present. |
| Arguments   | <ul style="list-style-type: none"><li>• <b>output_no</b><br/>The number of the output.</li><li>• <b>first_output_no</b><br/>The number of the first output of the output range.</li><li>• <b>last_output_no</b><br/>The number of the last output of the output range.</li></ul>                                                                                                                                                                                                                                                                                                                                                                                                                       |
| Example     | If output 11 has value 1, output 12 has value 1, output 13 has value 0, and output 14 has value 1, <b>READ_OP(11,14)</b> returns 13 (1101 bin).                                                                                                                                                                                                                                                                                                                                                                                                                                                                                                                                                        |
| Example     | In this example a single output is tested:<br><b>WAIT UNTIL READ_OP(12) = ON</b><br><b>GOSUB place</b>                                                                                                                                                                                                                                                                                                                                                                                                                                                                                                                                                                                                 |
| Example     | Check a range of 8 outputs and call a routine if one of them has value 1:<br><b>op_bits = READ_OP(16, 23)</b><br><b>IF op_bits &lt;&gt; 0 THEN</b><br><b>GOSUB check_outputs</b><br><b>ENDIF</b>                                                                                                                                                                                                                                                                                                                                                                                                                                                                                                       |
| See also    | N/A                                                                                                                                                                                                                                                                                                                                                                                                                                                                                                                                                                                                                                                                                                    |

**4-2-198 REG\_POS**

|             |                                                                                                                                                                                                                                                                                                                                                                                                                                                                                                                                                                                                                                                                                                                                                                                                                                                                                                                                                                                                                                                                                                                                                                                                                                                                                                                                                                                              |
|-------------|----------------------------------------------------------------------------------------------------------------------------------------------------------------------------------------------------------------------------------------------------------------------------------------------------------------------------------------------------------------------------------------------------------------------------------------------------------------------------------------------------------------------------------------------------------------------------------------------------------------------------------------------------------------------------------------------------------------------------------------------------------------------------------------------------------------------------------------------------------------------------------------------------------------------------------------------------------------------------------------------------------------------------------------------------------------------------------------------------------------------------------------------------------------------------------------------------------------------------------------------------------------------------------------------------------------------------------------------------------------------------------------------|
| Type        | Axis parameter (read-only)                                                                                                                                                                                                                                                                                                                                                                                                                                                                                                                                                                                                                                                                                                                                                                                                                                                                                                                                                                                                                                                                                                                                                                                                                                                                                                                                                                   |
| Syntax      | <b>REG_POS</b>                                                                                                                                                                                                                                                                                                                                                                                                                                                                                                                                                                                                                                                                                                                                                                                                                                                                                                                                                                                                                                                                                                                                                                                                                                                                                                                                                                               |
| Description | The <b>REG_POS</b> parameter stores the position in user units at which the primary registration event occurred.                                                                                                                                                                                                                                                                                                                                                                                                                                                                                                                                                                                                                                                                                                                                                                                                                                                                                                                                                                                                                                                                                                                                                                                                                                                                             |
| Arguments   | N/A                                                                                                                                                                                                                                                                                                                                                                                                                                                                                                                                                                                                                                                                                                                                                                                                                                                                                                                                                                                                                                                                                                                                                                                                                                                                                                                                                                                          |
| Example     | <p>A paper cutting machine uses a CAM profile shape to quickly draw paper through servo driven rollers, and stop the paper so it can be cut. The paper is printed with a registration mark. This mark is detected and the length of the next sheet is adjusted by scaling the CAM profile with the third parameter of the CAM command:</p> <p><b>' Example Registration Program using CAM stretching:</b><br/> <b>' Set window open and close:</b><br/> <b>length=200</b><br/> <b>OPEN_WIN=10</b><br/> <b>CLOSE_WIN=length-10</b><br/> <b>GOSUB Initial</b><br/> <b>Loop:</b><br/> <b>TICKS=0' Set millisecond counter to 0</b><br/> <b>IF MARK THEN</b><br/>     <b>offset=REG_POS</b><br/>     <b>' This next line makes offset -ve if at end of sheet:</b><br/>     <b>IF ABS(offset-length)&lt;offset THEN offset=offset-length</b><br/>     <b>PRINT "Mark seen at:"offset[5.1]</b><br/> <b>ELSE</b><br/>     <b>offset=0</b><br/>     <b>PRINT "Mark not seen"</b><br/> <b>ENDIF</b><br/> <b>' Reset registration prior to each move:</b><br/> <b>DEFPOS(0)</b><br/> <b>REGIST(3+768)' Allow mark at first 10mm/last 10mm of sheet</b><br/> <b>CAM(0,50,(length+offset*0.5)*cf,1000)</b><br/> <b>WAIT UNTIL TICKS&lt;-500</b><br/> <b>GOTO Loop</b></p> <p>Note: variable <b>cf</b> is a constant that is calculated depending on the draw length of the machine per encoder edge.</p> |
| See also    | <b>AXIS, MARK, REGIST.</b>                                                                                                                                                                                                                                                                                                                                                                                                                                                                                                                                                                                                                                                                                                                                                                                                                                                                                                                                                                                                                                                                                                                                                                                                                                                                                                                                                                   |

**4-2-199 REG\_POSB**

|             |                                                                                                                     |
|-------------|---------------------------------------------------------------------------------------------------------------------|
| Type        | Axis parameter (read-only)                                                                                          |
| Syntax      | <b>REG_POSB</b>                                                                                                     |
| Description | The <b>REG_POSB</b> parameter stores the position in user units at which the secondary registration event occurred. |
| Arguments   | N/A                                                                                                                 |
| Example     | No example.                                                                                                         |
| See also    | <b>AXIS, MARKB, REGIST.</b>                                                                                         |

## 4-2-200 REGIST

|             |                                                                                                                                                                                                                                                                                                                                                                                                                                                                                                                                                                                                                                                                                                                                                                                                                                                                                                                                                                                                                                                                                                                                                                                                                                                                                                                                                                                                                                                                                                                                                                                                                                                                                                                                                                                                                                                                                          |
|-------------|------------------------------------------------------------------------------------------------------------------------------------------------------------------------------------------------------------------------------------------------------------------------------------------------------------------------------------------------------------------------------------------------------------------------------------------------------------------------------------------------------------------------------------------------------------------------------------------------------------------------------------------------------------------------------------------------------------------------------------------------------------------------------------------------------------------------------------------------------------------------------------------------------------------------------------------------------------------------------------------------------------------------------------------------------------------------------------------------------------------------------------------------------------------------------------------------------------------------------------------------------------------------------------------------------------------------------------------------------------------------------------------------------------------------------------------------------------------------------------------------------------------------------------------------------------------------------------------------------------------------------------------------------------------------------------------------------------------------------------------------------------------------------------------------------------------------------------------------------------------------------------------|
| Type        | Axis command                                                                                                                                                                                                                                                                                                                                                                                                                                                                                                                                                                                                                                                                                                                                                                                                                                                                                                                                                                                                                                                                                                                                                                                                                                                                                                                                                                                                                                                                                                                                                                                                                                                                                                                                                                                                                                                                             |
| Syntax      | <b>REGIST(mode)</b>                                                                                                                                                                                                                                                                                                                                                                                                                                                                                                                                                                                                                                                                                                                                                                                                                                                                                                                                                                                                                                                                                                                                                                                                                                                                                                                                                                                                                                                                                                                                                                                                                                                                                                                                                                                                                                                                      |
| Description | <p>The <b>REGIST</b> command sets up the registration operation. The command captures an axis position when a registration signal is detected. With an Encoder Interface the capture is done by the hardware, so software delays do not affect the accuracy of the position that is captured. With a MECHATROLINK-II axis, the capture is done by the Servo Driver.</p> <p>With an Encoder Interface, a <b>REGIST</b> command can capture two registration positions using separate registration inputs. When a primary registration event has occurred, the <b>MARK</b> axis parameter is set to ON and the position is stored in the <b>REG_POS</b> axis parameter. For the secondary registration event, the <b>MARKB</b> axis parameter is set to ON and the position is stored in the <b>REG_POSB</b> axis parameter. <b>MARKB</b> and <b>REG_POSB</b> are applicable only to axes with <b>ATYPE</b> values 43, 44 and 45.</p> <p>MECHATROLINK-II registration can be performed using encoder Z-marker or external registration inputs EXT1, EXT2 or EXT3 on a Servo Driver. Unlike Flexible axis axes, only one registration position can be captured. When a registration event has occurred, the <b>MARK</b> axis parameter is set to ON and the position is stored in the <b>REG_POS</b> axis parameter.</p> <p>The registration signals EXT1, EXT2 and EXT3 must be allocated to CN1 inputs with the driver parameter Pn511. For example Pn511=654x sets the connections of EXT1 to CN1 pin44, EXT2 to CN1 pin45 and EXT3 to CN1 pin46 of the Sigma II Servo Driver.</p> <p>The table below shows how to configure the external inputs individually. Note: To configure EXT1, EXT2 and EXT3 registration signals parameter numbers Pn511.1, Pn511.2 and Pn511.3 are used respectively. Pn511.0 is not used. Refer to the user manual of the Servo Driver for more details.</p> |

| Registration signal | Parameter number | Parameter value | Description                          |
|---------------------|------------------|-----------------|--------------------------------------|
| EXT 1               | Pn511.1          | 0 to 3          | Not used                             |
|                     |                  | 4               | Input from CN1 pin44 (Rising edge)   |
|                     |                  | 5               | Input from CN1 pin45 (Rising edge).  |
|                     |                  | 6               | Input from CN1 pin46 (Rising edge).  |
|                     |                  | 7               | Signal always OFF.                   |
|                     |                  | 8               | Signal always ON.                    |
|                     |                  | 9 to C          | Not used                             |
|                     |                  | D               | Input from CN1 pin44 (Falling edge). |
|                     |                  | E               | Input from CN1 pin45 (Falling edge). |
|                     |                  | F               | Input from CN1 pin46 (Falling edge). |
| EXT 2               | Pn511.2          | As for EXT 1    | As for EXT 1                         |
| EXT 3               | Pn511.3          | As for EXT 1    | As for EXT 1                         |

**Note** The mapping of the registration signals in the table above applies to the Sigma-II Servo Driver. For the mapping of the registration signals of the Sigma-V, Junma and G-Series Servo Drivers, refer to section 5-1-6.

Inclusive windowing lets the registration to occur only within a specified window of axis positions. With this windowing function, registration events are ignored if the axis measured position is not greater than the **OPEN\_WIN** axis parameter, and less than the **CLOSE\_WIN** parameter. Exclusive windowing allows the registration to occur only outside of the specified window of axis positions. With this windowing function, the registration events are ignored if the axis measured position is not less than the **OPEN\_WIN** axis parameter, and greater than the **CLOSE\_WIN** parameter.

Arguments

- mode**  
 The mode parameter specifies the registration input and event for use and the signal edge the registration event occurs. The mode parameter also specifies the use of the windowing function and filtering.  
 The mode parameter differs between MECHATROLINK-II and Encoder Interface. The function of each bit in the mode parameter is explained in the tables below.

| Bit  | Function (MECHATROLINK-II)                                                                                                                                                                                                                                                                 |
|------|--------------------------------------------------------------------------------------------------------------------------------------------------------------------------------------------------------------------------------------------------------------------------------------------|
| 1, 0 | Primary registration occurs for: <ul style="list-style-type: none"> <li>00: Z-mark of the encoder</li> <li>01: EXT1 input (CN1 pin programmed with Pn511.1)</li> <li>10: EXT2 input (CN1 pin programmed with Pn511.2)</li> <li>11: EXT3 input (CN1 pin programmed with Pn511.3)</li> </ul> |
| 2 -7 | Not used                                                                                                                                                                                                                                                                                   |
| 9, 8 | Windowing function choice: <ul style="list-style-type: none"> <li>00: No windowing</li> <li>01: Inclusive windowing</li> <li>10: Inclusive windowing</li> <li>11: Exclusive windowing</li> </ul>                                                                                           |
| 10   | Not used                                                                                                                                                                                                                                                                                   |

| Bit  | Function (Encoder Interface)                                                                                                                                     |
|------|------------------------------------------------------------------------------------------------------------------------------------------------------------------|
| 1, 0 | Primary registration occurs for: <ul style="list-style-type: none"> <li>00: Z-mark of the encoder</li> <li>01: REG 0 input</li> <li>10: REG 1 input</li> </ul>   |
| 2    | Set this bit to use primary registration event                                                                                                                   |
| 3    | Primary registration event occurs on signal: <ul style="list-style-type: none"> <li>0: rising edge</li> <li>1: falling edge</li> </ul>                           |
| 5, 4 | Secondary registration occurs for: <ul style="list-style-type: none"> <li>00: Z-mark of the encoder</li> <li>01: REG 0 input</li> <li>10: REG 1 input</li> </ul> |

| Bit  | Function (Encoder Interface)                                                                                                                                                                             |
|------|----------------------------------------------------------------------------------------------------------------------------------------------------------------------------------------------------------|
| 6    | Set this bit to use secondary registration event                                                                                                                                                         |
| 7    | Secondary registration event occurs on signal: <ul style="list-style-type: none"> <li>• 0: rising edge</li> <li>• 1: falling edge</li> </ul>                                                             |
| 9, 8 | Windowing function choice: <ul style="list-style-type: none"> <li>• 00: No windowing</li> <li>• 01: Inclusive windowing</li> <li>• 10: Inclusive windowing</li> <li>• 11: Exclusive windowing</li> </ul> |
| 10   | Set this bit to use filtering function                                                                                                                                                                   |

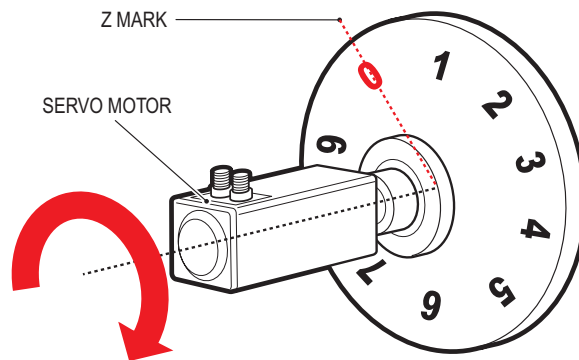

Example      A disc used in a laser printing process requires registration to the Z marker before it can start to print. The example code locates to the Z marker, and then sets it as the zero position.

```

REGIST(1) 'set registration point on Z mark
FORWARD 'start movement
WAIT UNTIL MARK
CANCEL 'stops movement after Z mark
WAIT IDLE
MOVEABS (REG_POS) 'relocate to Z mark
WAIT IDLE
DEFPOS(0) 'set zero position

```



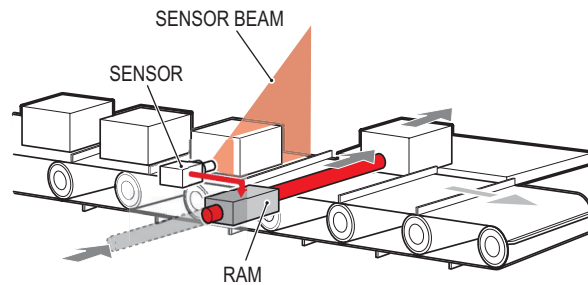

## Example

Components are placed on a flighted belt. The flights are 120 mm apart. The components are on the belt 30 mm from the flights. When a component is found, an actuator pushes it off the belt. To prevent that the sensor finds a flight instead of a component, registration with windowing is used.

**REP\_DIST=120** 'sets repeat distance to pitch of belt flights

**REP\_OPTION=ON**

**OPEN\_WIN=30** ' sets window open position

**CLOSE\_WIN=90** ' sets window close position

**REGIST(4+256)** ' R input registration with windowing

**FORWARD** ' start the belt

**box\_seen=0**

**REPEAT**

**WAIT UNTIL MPOS<60** ' wait for centre point between flights

**WAIT UNTIL MPOS>60** ' so that actuator is fired between flights

**IF box\_seen=1 THEN** ' was a box seen on the previous cycle?

**OP(8,ON)** ' fire actuator

**WA(100)**

**OP(8,OFF)** ' retract actuator

**box\_seen=0**

**ENDIF**

**IF MARK THEN box\_seen=1** ' set "box seen" flag

**REGIST(4+256)**

**UNTIL IN(2)=OFF**

**CANCEL** ' stop the belt

**WAIT IDLE**

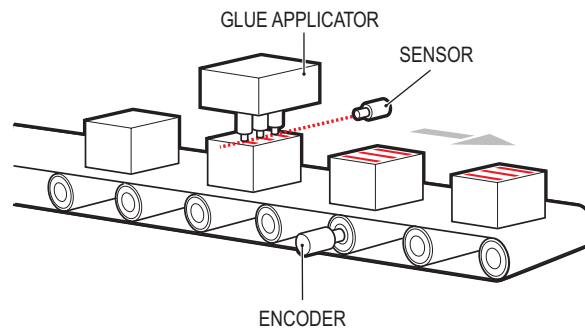

Example

A machine adds glue to the top of a box. To do this, it must switch output 8. It must detect the rising edge (appearance) and the falling edge (end) of a box. Also, the MPOS must be set to zero when the Z position is detected.

```

reg=6 'select registration mode 6 (rising edge R, rising edge Z)
REGIST(reg)
FORWARD
WHILE IN(2)=OFF
 IF MARKB THEN 'on a Z mark mpos is reset to zero
 OFFPOS=-REG_POSB
 REGIST(reg)
 ELSEIF MARK THEN 'on R input output 8 is toggled
 IF reg=6 THEN
 'select registration mode 8 (falling edge R, rising edge Z)
 reg=8
 OP(8,ON)
 ELSE
 reg=6
 OP(8,OFF)
 ENDIF
 REGIST(reg)
 ENDIF
WEND
CANCEL

```

See also

**AXIS, MARK, MARKB, REG\_POS, REG\_POSB, OPEN\_WIN, CLOSE\_WIN.**

**4-2-201 REMAIN**

|             |                                                                                                                                                                                                                                                                                                                                                                                                                                                                                                                                                                                                                                                                                                                                                                                                                                                                                                  |
|-------------|--------------------------------------------------------------------------------------------------------------------------------------------------------------------------------------------------------------------------------------------------------------------------------------------------------------------------------------------------------------------------------------------------------------------------------------------------------------------------------------------------------------------------------------------------------------------------------------------------------------------------------------------------------------------------------------------------------------------------------------------------------------------------------------------------------------------------------------------------------------------------------------------------|
| Type        | Axis parameter (read-only)                                                                                                                                                                                                                                                                                                                                                                                                                                                                                                                                                                                                                                                                                                                                                                                                                                                                       |
| Syntax      | <b>REMAIN</b>                                                                                                                                                                                                                                                                                                                                                                                                                                                                                                                                                                                                                                                                                                                                                                                                                                                                                    |
| Description | <p>The <b>REMAIN</b> parameter contains the distance remaining to the end of the current move. It can be checked to see how much of the move has been completed.</p> <p>The units in which <b>REMAIN</b> is expressed depends on the type of the motion command:</p> <ul style="list-style-type: none"> <li>• If a master axis is moved by <b>MOVELINK</b> or <b>CAMBOX</b>, <b>REMAIN</b> is expressed in user units set by <b>UNITS</b>.</li> <li>• If a slave axis is moved by <b>MOVELINK</b> or <b>CAMBOX</b>, <b>REMAIN</b> is expressed in encoder counts.</li> <li>• If a master or a slave axis is moved by a motion command that is not <b>MOVELINK</b> or <b>CAMBOX</b>, <b>REMAIN</b> is expressed in user units set by <b>UNITS</b>.</li> </ul> <p>The <b>CONNECT</b> command moves an axis without a defined end. For this command, <b>REMAIN</b> has the fixed value of 1000.</p> |
| Arguments   | N/A                                                                                                                                                                                                                                                                                                                                                                                                                                                                                                                                                                                                                                                                                                                                                                                                                                                                                              |
| Example     | <p>To change the speed to a slower value 5mm from the end of a move.</p> <pre>start: SPEED = 10 MOVE(45) WAIT UNTIL REMAIN &lt; 5 SPEED = 1 WAIT IDLE</pre>                                                                                                                                                                                                                                                                                                                                                                                                                                                                                                                                                                                                                                                                                                                                      |
| See also    | <b>AXIS, UNITS</b>                                                                                                                                                                                                                                                                                                                                                                                                                                                                                                                                                                                                                                                                                                                                                                                                                                                                               |

**4-2-202 REMOTE\_ERROR**

|             |                                                                                     |
|-------------|-------------------------------------------------------------------------------------|
| Type        | Axis parameter                                                                      |
| Syntax      | <b>REMOTE_ERROR</b>                                                                 |
| Description | Returns the number of errors on the MECHATROLINK-II communication link of a driver. |
| Arguments   | N/A                                                                                 |
| Example     | <pre>&gt;&gt;PRINT REMOTE_ERROR 1.0000</pre>                                        |
| See also    | N/A                                                                                 |

**4-2-203 RENAME**

|             |                                                                                                                                                                                                                                                                 |
|-------------|-----------------------------------------------------------------------------------------------------------------------------------------------------------------------------------------------------------------------------------------------------------------|
| Type        | Program command                                                                                                                                                                                                                                                 |
| Syntax      | <b>RENAME "old_program_name" "new_program_name"</b>                                                                                                                                                                                                             |
| Description | The <b>RENAME</b> command changes the name of a program in the CJ1W-MCH72 directory. The program names can also be specified without quotes.<br>Note: This command is implemented for a Command Line Terminal only and should not be used from within programs. |
| Arguments   | <ul style="list-style-type: none"> <li>• <b>old_program_name</b><br/>The current name of the program.</li> <li>• <b>new_program_name</b><br/>The new name of the program.</li> </ul>                                                                            |
| Example     | <b>RENAME "car" "voiture"</b>                                                                                                                                                                                                                                   |
| See also    | <b>COPY, DEL, NEW.</b>                                                                                                                                                                                                                                          |

**4-2-204 REP\_DIST**

|             |                                                                                                                                                                                                                                                                                                                                                                                                                                                                                                                                                                                                                                                                                                                                                                                                                                                                                                                                                                                                                                                                                                                                                                                                                     |
|-------------|---------------------------------------------------------------------------------------------------------------------------------------------------------------------------------------------------------------------------------------------------------------------------------------------------------------------------------------------------------------------------------------------------------------------------------------------------------------------------------------------------------------------------------------------------------------------------------------------------------------------------------------------------------------------------------------------------------------------------------------------------------------------------------------------------------------------------------------------------------------------------------------------------------------------------------------------------------------------------------------------------------------------------------------------------------------------------------------------------------------------------------------------------------------------------------------------------------------------|
| Type        | Axis parameter                                                                                                                                                                                                                                                                                                                                                                                                                                                                                                                                                                                                                                                                                                                                                                                                                                                                                                                                                                                                                                                                                                                                                                                                      |
| Syntax      | <b>REP_DIST</b>                                                                                                                                                                                                                                                                                                                                                                                                                                                                                                                                                                                                                                                                                                                                                                                                                                                                                                                                                                                                                                                                                                                                                                                                     |
| Description | The <b>REP_DIST</b> parameter contains the repeat distance, which is the allowable range of movement for an axis before the demand position ( <b>DPOS</b> ) and measured position ( <b>MPOS</b> ) are corrected. <b>REP_DIST</b> is defined in user units. The exact range is controlled by <b>REP_OPTION</b> . The <b>REP_DIST</b> can have any non-0 positive value.<br>When the measured position has reached its limit, the CJ1W-MCH72 will adjust the absolute positions without affecting the move in progress or the servo algorithm. Note that the demand position can be outside the range because the measured position is used to trigger the adjustment. When measured position reaches <b>REP_DIST</b> , twice that distance is subtracted to ensure that the axis always stays in the range [- <b>REP_DIST</b> , <b>REP_DIST</b> ], assuming that <b>REP_OPTION=OFF</b> , or in the range [0, <b>REP_OPTION</b> ], assuming that <b>REP_OPTION=ON</b> .<br>For every occurrence ( <b>DEFPOS</b> , <b>OFFPOS</b> , <b>MOVEABS</b> , <b>MOVEMODIFY</b> ) which defines a position outside the range, the end position will be redefined within the range.<br>The default value for all axes is 5000000. |
| Arguments   | N/A                                                                                                                                                                                                                                                                                                                                                                                                                                                                                                                                                                                                                                                                                                                                                                                                                                                                                                                                                                                                                                                                                                                                                                                                                 |
| Example     | No example.                                                                                                                                                                                                                                                                                                                                                                                                                                                                                                                                                                                                                                                                                                                                                                                                                                                                                                                                                                                                                                                                                                                                                                                                         |
| See also    | <b>AXIS, DPOS, MPOS, REP_OPTION, UNITS.</b>                                                                                                                                                                                                                                                                                                                                                                                                                                                                                                                                                                                                                                                                                                                                                                                                                                                                                                                                                                                                                                                                                                                                                                         |

## 4-2-205 REP\_OPTION

|             |                                                                                                                                                                                                                           |
|-------------|---------------------------------------------------------------------------------------------------------------------------------------------------------------------------------------------------------------------------|
| Type        | Axis parameter                                                                                                                                                                                                            |
| Syntax      | <b>REP_OPTION</b>                                                                                                                                                                                                         |
| Description | The <b>REP_OPTION</b> parameter controls the application of the <b>REP_DIST</b> axis parameter and the repeat option of the <b>CAMBOX</b> and <b>MOVELINK</b> Axis commands. The default value is 0. See the table below. |

| Bit | Description                                                                                                                                                                                                                                                                                                                                                                                                           |
|-----|-----------------------------------------------------------------------------------------------------------------------------------------------------------------------------------------------------------------------------------------------------------------------------------------------------------------------------------------------------------------------------------------------------------------------|
| 0   | The repeated distance range is controlled by bit 0 of the <b>REP_OPTION</b> parameter. <ul style="list-style-type: none"> <li>If <b>REP_OPTION</b> bit 0 is off, the range of the demanded and measured positions will be between <b>-REP_DIST</b> and <b>REP_DIST</b>.</li> <li>If <b>REP_OPTION</b> bit 0 is on, the range of the demanded and measured positions will be between 0 and <b>REP_DIST</b>.</li> </ul> |
| 1   | The automatic repeat option of the <b>CAMBOX</b> and <b>MOVELINK</b> commands are controlled by bit 1 of the <b>REP_OPTION</b> parameter. The bit is set on to request the system software to end the automatic repeat option. When the system software has set the option off it automatically clears bit 1 of <b>REP_OPTION</b> .                                                                                   |

|           |                                          |
|-----------|------------------------------------------|
| Arguments | N/A                                      |
| Example   | No example.                              |
| See also  | <b>AXIS, CAMBOX, MOVELINK, REP_DIST.</b> |

## 4-2-206 REPEAT..UNTIL

|             |                                                                                                                                                                                                                                                                                                      |
|-------------|------------------------------------------------------------------------------------------------------------------------------------------------------------------------------------------------------------------------------------------------------------------------------------------------------|
| Type        | Program control command                                                                                                                                                                                                                                                                              |
| Syntax      | <b>REPEAT</b><br><b>commands</b><br><b>UNTIL condition</b>                                                                                                                                                                                                                                           |
| Description | The <b>REPEAT ... UNTIL</b> structure allows the program segment between the <b>REPEAT</b> and the <b>UNTIL</b> statement to be repeated a number of times until the condition becomes <b>TRUE</b> .<br>Note: <b>REPEAT ... UNTIL</b> construct can be nested indefinitely.                          |
| Arguments   | <ul style="list-style-type: none"><li>• <b>commands</b><br/>Any valid set of BASIC commands</li><li>• <b>condition</b><br/>Any valid BASIC logical expression</li></ul>                                                                                                                              |
| Example     | A conveyor is to index 100mm at a speed of 1000mm/s, wait for 0.5s and then repeat the cycle until an external counter signals to stop by turning on input 4.<br>cycle:<br><b>SPEED = 1000</b><br><b>REPEAT</b><br><b>MOVE(100)</b><br><b>WAIT IDLE</b><br><b>WA(500)</b><br><b>UNTIL IN(4) = ON</b> |
| See also    | <b>FOR..TO..STEP..NEXT, WHILE..WEND.</b>                                                                                                                                                                                                                                                             |

## 4-2-207 RESET

|             |                                                                                                |
|-------------|------------------------------------------------------------------------------------------------|
| Type        | System command                                                                                 |
| Syntax      | <b>RESET</b>                                                                                   |
| Description | The <b>RESET</b> command sets the value of all local variables of the current BASIC task to 0. |
| Arguments   | N/A                                                                                            |
| Example     | No example.                                                                                    |
| See also    | <b>CLEAR.</b>                                                                                  |

## 4-2-208 RETURN

See **GOSUB..RETURN.**

**4-2-209 REV\_IN**

|             |                                                                                                                                                                                                                                                                                                                                                                                                                                                                                                                                                                                                                                                                                                                                                                                                                                                                                  |
|-------------|----------------------------------------------------------------------------------------------------------------------------------------------------------------------------------------------------------------------------------------------------------------------------------------------------------------------------------------------------------------------------------------------------------------------------------------------------------------------------------------------------------------------------------------------------------------------------------------------------------------------------------------------------------------------------------------------------------------------------------------------------------------------------------------------------------------------------------------------------------------------------------|
| Type        | Axis parameter                                                                                                                                                                                                                                                                                                                                                                                                                                                                                                                                                                                                                                                                                                                                                                                                                                                                   |
| Syntax      | <b>REV_IN</b>                                                                                                                                                                                                                                                                                                                                                                                                                                                                                                                                                                                                                                                                                                                                                                                                                                                                    |
| Description | <p>The <b>REV_IN</b> parameter contains the input number to be used as a reverse limit input. The valid input range is 0 to 31. Values 0 to 15 represent physically present inputs of CJ1W-MCH72 I/O connector and are common for all axes.</p> <p>Values 16 to 31 are mapped directly to driver inputs that are present on the CN1 connector. They are unique for each axis. It depends on the type of Servo Driver which Servo Driver inputs are mapped into inputs 16 to 31. For more information on Servo Driver I/O mapping into the Trajexia I/O space, refer to section 5-1-4.</p> <p>As default the parameter is set to -1, no input is selected.</p> <p>If an input number is set and the limit is reached, any reverse motion on that axis will be stopped. Bit 5 of the <b>AXISSTATUS</b> axis parameter will also be set.</p> <p>Note: This input is active low.</p> |
| Arguments   | N/A                                                                                                                                                                                                                                                                                                                                                                                                                                                                                                                                                                                                                                                                                                                                                                                                                                                                              |
| Example     | No example.                                                                                                                                                                                                                                                                                                                                                                                                                                                                                                                                                                                                                                                                                                                                                                                                                                                                      |
| See also    | <b>AXIS, AXISSTATUS, FWD_IN.</b>                                                                                                                                                                                                                                                                                                                                                                                                                                                                                                                                                                                                                                                                                                                                                                                                                                                 |

**4-2-210 REV\_JOG**

|             |                                                                                                                                                                                                                                     |
|-------------|-------------------------------------------------------------------------------------------------------------------------------------------------------------------------------------------------------------------------------------|
| Type        | Axis parameter                                                                                                                                                                                                                      |
| Syntax      | <b>REV_JOG</b>                                                                                                                                                                                                                      |
| Description | <p>The <b>REV_JOG</b> parameter contains the input number to be used as a jog reverse input. The input can be from 0 to 31. As default the parameter is set to -1, no input is selected.</p> <p>Note: This input is active low.</p> |
| Arguments   | N/A                                                                                                                                                                                                                                 |
| Example     | No example.                                                                                                                                                                                                                         |
| See also    | <b>AXIS, FAST_JOG, FWD_JOG, JOGSPEED, UNITS.</b>                                                                                                                                                                                    |

**4-2-211 REVERSE**

|             |                                                                                                                                                                                                                                                                                                                                                                                                                                                                                                                      |
|-------------|----------------------------------------------------------------------------------------------------------------------------------------------------------------------------------------------------------------------------------------------------------------------------------------------------------------------------------------------------------------------------------------------------------------------------------------------------------------------------------------------------------------------|
| Type        | Axis command                                                                                                                                                                                                                                                                                                                                                                                                                                                                                                         |
| Syntax      | <b>REVERSE</b><br><b>RE</b>                                                                                                                                                                                                                                                                                                                                                                                                                                                                                          |
| Description | <p>The <b>REVERSE</b> command moves an axis continuously in reverse at the speed set in the <b>SPEED</b> parameter. The acceleration rate is defined by the <b>ACCEL</b> axis parameter.</p> <p><b>REVERSE</b> works on the default basis axis (set with <b>BASE</b>) unless <b>AXIS</b> is used to specify a temporary base axis.</p> <p>Note: The reverse motion can be stopped by executing the <b>CANCEL</b> or <b>RAPIDSTOP</b> command, or by reaching the reverse limit, inhibit, or origin return limit.</p> |
| Arguments   | N/A                                                                                                                                                                                                                                                                                                                                                                                                                                                                                                                  |

Example Run an axis in reverse. When an input signal is detected on input 5, stop the axis.

```
back:
REVERSE
WAIT UNTIL IN(0) = ON ' Wait for stop signal
CANCEL
```

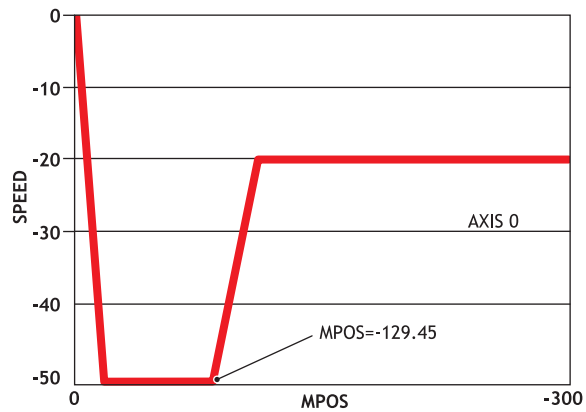

Example Run an axis in reverse. When it reaches a certain position, slow down.

```
DEFPOS(0) ' set starting position to zero
REVERSE
WAIT UNTIL MPOS<-129.45
SPEED=slow_speed
WAIT UNTIL VP_SPEED=slow_speed ' wait until the axis slows
OP(11,ON) ' turn on an output to show that speed is now slow
```

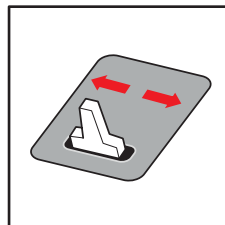
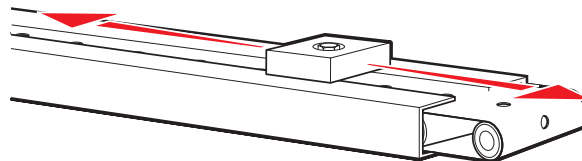



Example A joystick is used to control the speed of a platform. A deadband is required to prevent oscillations from the joystick midpoint. This is done with the **REVERSE** command, which sets the correct direction relative to the operator. Then, the joystick adjusts the speed through analogue input 0.

```

REVERSE
WHILE IN(2)=ON
 IF AIN(0)<50 AND AIN(0)>-50 THEN 'sets a deadband in the input
 SPEED=0
 ELSE
 SPEED=AIN(0)*100 'sets speed to a scale of AIN
 ENDIF
WEND
CANCEL

```

See also **AXIS, CANCEL, FORWARD, RAPIDSTOP.**

## 4-2-212 RS\_LIMIT

Type Axis parameter

Syntax **RS\_LIMIT**  
**RSLIMIT**

Description The **RS\_LIMIT** parameter contains the absolute position of the reverse software limit in user units.

A software limit for reverse movement can be set from the program to control the working range of the machine. When the limit is reached, the CJ1W-MCH72 will decelerate to 0, and then cancel the move. Bit 10 of the **AXISSTATUS** axis parameter will be turned on while the axis position is smaller than / below **RS\_LIMIT**.

Arguments N/A

Example No example.

See also **AXIS, FS\_LIMIT, UNITS.**

## 4-2-213 RUN

|             |                                                                                                                                                                                                                                                                                                                                                                                                                                                                                                                                                                                                                                                                                                                                                                                                                                                                                                                                                                                                                                                                                                                          |
|-------------|--------------------------------------------------------------------------------------------------------------------------------------------------------------------------------------------------------------------------------------------------------------------------------------------------------------------------------------------------------------------------------------------------------------------------------------------------------------------------------------------------------------------------------------------------------------------------------------------------------------------------------------------------------------------------------------------------------------------------------------------------------------------------------------------------------------------------------------------------------------------------------------------------------------------------------------------------------------------------------------------------------------------------------------------------------------------------------------------------------------------------|
| Type        | Program command                                                                                                                                                                                                                                                                                                                                                                                                                                                                                                                                                                                                                                                                                                                                                                                                                                                                                                                                                                                                                                                                                                          |
| Syntax      | <b>RUN [ "program_name" [, task_number ]]</b>                                                                                                                                                                                                                                                                                                                                                                                                                                                                                                                                                                                                                                                                                                                                                                                                                                                                                                                                                                                                                                                                            |
| Description | <p>The <b>RUN</b> command executes the program in the CJ1W-MCH72 as specified with <b>program_name</b>. <b>RUN</b> without the program name specified will run the current selected program. The program name can also be specified without quotes.</p> <p>To enable the commands to be executed, the Enable Execution bit (control word <i>n</i>, bit 0) must be set.</p> <p>The task number specifies the task number on which the program will be run. If the task number is omitted, the program will run on the highest available task. <b>RUN</b> can be included in a program to run another program.</p> <p>Note: Execution continues until one of the following occurs:</p> <ul style="list-style-type: none"><li>• There are no more lines to execute.</li><li>• <b>HALT</b> is typed at the command line to stop all programs.</li><li>• <b>STOP</b> is typed at the command line to stop a single program.</li><li>• The <b>STOP</b> command in the program is encountered.</li><li>• A run-time error is encountered.</li><li>• The Enable Execution bit (control word <i>n</i>, bit 0) is reset.</li></ul> |
| Arguments   | <ul style="list-style-type: none"><li>• <b>program_name</b><br/>Any valid program name.</li><li>• <b>task_number</b><br/>Any valid task number. Range: [1,14].</li></ul>                                                                                                                                                                                                                                                                                                                                                                                                                                                                                                                                                                                                                                                                                                                                                                                                                                                                                                                                                 |
| Example     | <pre>&gt;&gt; SELECT "PROGRAM"<br/>PROGRAM selected<br/>&gt;&gt; RUN</pre> <p>This example executes the currently selected program.</p>                                                                                                                                                                                                                                                                                                                                                                                                                                                                                                                                                                                                                                                                                                                                                                                                                                                                                                                                                                                  |
| Example     | <pre>RUN "sausage"</pre> <p>This example executes the program named <b>sausage</b>.</p>                                                                                                                                                                                                                                                                                                                                                                                                                                                                                                                                                                                                                                                                                                                                                                                                                                                                                                                                                                                                                                  |
| Example     | <pre>RUN "sausage",3</pre> <p>This example executes the program named <b>sausage</b> on task 3.</p>                                                                                                                                                                                                                                                                                                                                                                                                                                                                                                                                                                                                                                                                                                                                                                                                                                                                                                                                                                                                                      |
| See also    | <b>HALT, STOP.</b>                                                                                                                                                                                                                                                                                                                                                                                                                                                                                                                                                                                                                                                                                                                                                                                                                                                                                                                                                                                                                                                                                                       |

## 4-2-214 RUN\_ERROR

Type Task parameter (read-only)

Syntax **RUN\_ERROR**

Description The **RUN\_ERROR** parameter contains the number of the last BASIC run-time error that occurred on the specified task.  
 Each task has its own **RUN\_ERROR** parameter. Use the **PROC** modifier to access the parameter for a certain task. Without **PROC** the current task will be assumed.  
 The table below gives an overview of error numbers and the associated error messages.

| Number | Message                                      | Number | Message                                             |
|--------|----------------------------------------------|--------|-----------------------------------------------------|
| 1      | Command not recognized                       | 2      | Invalid transfer type                               |
| 3      | Error programming Flash                      | 4      | Operand expected                                    |
| 5      | Assignment expected                          | 6      | QUOTES expected                                     |
| 7      | Stack overflow                               | 8      | Too many variables                                  |
| 9      | Divide by zero                               | 10     | Extra characters at end of line                     |
| 11     | ] expected in <b>PRINT</b>                   | 12     | Cannot modify a special program                     |
| 13     | <b>THEN</b> expected in <b>IF/ELSEIF</b>     | 14     | Error erasing Flash                                 |
| 15     | Start of expression expected                 | 16     | ) expected                                          |
| 17     | , expected                                   | 18     | Command line broken by ESC                          |
| 19     | Parameter out of range                       | 20     | No process available                                |
| 21     | Value is read only                           | 22     | Modifier not allowed                                |
| 23     | Remote axis is in use                        | 24     | Command is command line only                        |
| 25     | Command is runtime only                      | 26     | LABEL expected                                      |
| 27     | Program not found                            | 28     | Duplicate label                                     |
| 29     | Program is locked                            | 30     | Program(s) running                                  |
| 31     | Program is stopped                           | 32     | Cannot select program                               |
| 33     | No program selected                          | 34     | No more programs available                          |
| 35     | Out of memory                                | 36     | No code available to run                            |
| 37     | Command out of context                       | 38     | Too many nested structures                          |
| 39     | Structure nesting error                      | 40     | <b>ELSE/ELSEIF/ENDIF</b> without previous <b>IF</b> |
| 41     | <b>WEND</b> without previous <b>WHILE</b>    | 42     | <b>UNTIL</b> without previous <b>REPEAT</b>         |
| 43     | Variable expected                            | 44     | <b>TO</b> expected after <b>FOR</b>                 |
| 45     | Too may nested <b>FOR/NEXT</b>               | 46     | <b>NEXT</b> without <b>FOR</b>                      |
| 47     | <b>UNTIL/IDLE</b> expected after <b>WAIT</b> | 48     | <b>GOTO/GOSUB</b> expected                          |
| 49     | Too many nested <b>GOSUB</b>                 | 50     | <b>RETURN</b> without <b>GOSUB</b>                  |

| Number | Message                                                    | Number | Message                                                          |
|--------|------------------------------------------------------------|--------|------------------------------------------------------------------|
| 51     | LABEL must be at start of line                             | 52     | Cannot nest one line <b>IF</b>                                   |
| 53     | LABEL not found                                            | 54     | LINE NUMBER cannot have decimal point                            |
| 55     | Cannot have multiple instances of REMOTE                   | 56     | Invalid use of \$                                                |
| 57     | <b>VR(x)</b> expected                                      | 58     | Program already exists                                           |
| 59     | Process already selected                                   | 60     | Duplicate axes not permitted                                     |
| 61     | PLC type is invalid                                        | 62     | Evaluation error                                                 |
| 63     | Reserved keyword not available on this controller          | 64     | VARIABLE not found                                               |
| 65     | Table index range error                                    | 66     | Features enabled do not allow <b>ATYPE</b> change                |
| 67     | Invalid line number                                        | 68     | String exceeds permitted length                                  |
| 69     | Scope period should exceed number of <b>AIN</b> parameters | 70     | Value is incorrect                                               |
| 71     | Invalid I/O channel                                        | 72     | Value cannot be set. Use <b>CLEAR_PARAMS</b> command             |
| 73     | Directory not locked                                       | 74     | Directory already locked                                         |
| 75     | Program not running on this process                        | 76     | Program not running                                              |
| 77     | Program not paused on this process                         | 78     | Program not paused                                               |
| 79     | Command not allowed when running Trajexia Studio           | 80     | Directory structure invalid                                      |
| 81     | Directory is locked                                        | 82     | Cannot edit program                                              |
| 83     | Too many nested OPERANDS                                   | 84     | Cannot reset when drive servo on                                 |
| 85     | Flash Stick blank                                          | 86     | Flash Stick not available on this controller                     |
| 87     | Slave error                                                | 88     | Master error                                                     |
| 89     | Network timeout                                            | 90     | Network protocol error                                           |
| 91     | Global definition is different                             | 92     | Invalid program name                                             |
| 93     | Program corrupt                                            | 94     | More than one program running when trying to set GLOBAL/CONSTANT |
| 95     | Program encrypted                                          | 96     | TOKEN definition incorrect                                       |
| 97     | Cannot change program type once it has been created        | 98     | Command expected                                                 |
| 99     | Invalid command                                            | 100    | Invalid parameter for command                                    |
| 101    | Too many tokens in block                                   | 102    | Invalid mix of modal groups                                      |
| 103    | Variable defined outside include file                      | 104    | Invalid program type                                             |

| Number | Message                                           | Number | Message                                                     |
|--------|---------------------------------------------------|--------|-------------------------------------------------------------|
| 105    | Variable not declared                             | 106    | ( expected                                                  |
| 107    | Number expected                                   | 108    | AS expected                                                 |
| 109    | STRING, VECTOR or ARRAY expected                  | 110    | String expected                                             |
| 111    | Invalid <b>MSPHERICAL</b> input                   | 112    | Too many labels                                             |
| 113    | Symbol table locked                               | 114    | Incorrect symbol type                                       |
| 115    | Invalid mix of data types                         | 116    | Command not allowed when running Trajexia Studio            |
| 117    | Parameter expected                                | 118    | Firmware error: Device in use                               |
| 119    | Device error: Timeout waiting for device          | 120    | Device error: Command not supported by device               |
| 121    | Device error: CRC error                           | 122    | Device error: Error writing to device                       |
| 123    | Device error: Invalid response from device        | 124    | Firmware error: Cannot reference data outside current block |
| 125    | Disk error: Invalid MBR                           | 126    | Disk error: Invalid boot sector                             |
| 127    | Disk error: Invalid sector/cluster reference      | 128    | File error: Disk full                                       |
| 129    | File error: File not found                        | 130    | File error: Filename already exists                         |
| 131    | File error: Invalid filename                      | 132    | File error: Directory full                                  |
| 133    | Command only allowed when running Trajexia Studio | 134    | # expected                                                  |
| 135    | <b>FOR</b> expected                               | 136    | INPUT/OUTPUT/APPEND expected                                |
| 137    | File not open                                     | 138    | End of file                                                 |

Arguments N/A

Example >> **PRINT RUN\_ERROR PROC(5)**  
**9.0000**

See also **BASICERROR, ERROR\_LINE, PROC.**

## 4-2-215 RUNTYPE

|             |                                                                                                                                                                                                                                                                                                                                                                                                                                                                                                                                                                        |
|-------------|------------------------------------------------------------------------------------------------------------------------------------------------------------------------------------------------------------------------------------------------------------------------------------------------------------------------------------------------------------------------------------------------------------------------------------------------------------------------------------------------------------------------------------------------------------------------|
| Type        | Program command                                                                                                                                                                                                                                                                                                                                                                                                                                                                                                                                                        |
| Syntax      | <b>RUNTYPE "program_name", auto_run [ , task_number ]</b>                                                                                                                                                                                                                                                                                                                                                                                                                                                                                                              |
| Description | <p>The <b>RUNTYPE</b> command determines whether the program, specified by <b>program_name</b>, is run automatically at start-up or not and which task it is to run on. The task number is optional, if omitted the program will run at the highest available task.</p> <p>The current <b>RUNTYPE</b> status of each programs is displayed when a <b>DIR</b> command is executed. If any program has compilation errors no programs will be started at power up. To set the <b>RUNTYPE</b> using Trajexia Studio, set the <b>Priority</b> property of the program.</p> |
| Arguments   | <ul style="list-style-type: none"> <li>• <b>program_name</b><br/>The name of the program whose <b>RUNTYPE</b> is being set.</li> <li>• <b>auto_run</b><br/>0 = Running manually on command; 1 = Automatically execute on power up. All non-zero values are considered as 1.</li> <li>• <b>task_number</b><br/>The number of the task on which to execute the program. Range: [1, 14].</li> </ul>                                                                                                                                                                       |
| Example     | <p><b>&gt;&gt; RUNTYPE progname,1,3</b><br/>This line sets the program <b>progname</b> to run automatically at start-up on task 3.</p>                                                                                                                                                                                                                                                                                                                                                                                                                                 |
| Example     | <p><b>&gt;&gt; RUNTYPE progname,0</b><br/>This line sets the program <b>progname</b> to manual running.</p>                                                                                                                                                                                                                                                                                                                                                                                                                                                            |
| See also    | <b>AUTORUN, EPROM, EX.</b>                                                                                                                                                                                                                                                                                                                                                                                                                                                                                                                                             |

## 4-2-216 S\_REF

|             |                                                                                                                                                                                                                                                                                                                                                                                                                                                                                                                             |
|-------------|-----------------------------------------------------------------------------------------------------------------------------------------------------------------------------------------------------------------------------------------------------------------------------------------------------------------------------------------------------------------------------------------------------------------------------------------------------------------------------------------------------------------------------|
| Type        | Axis parameter                                                                                                                                                                                                                                                                                                                                                                                                                                                                                                              |
| Syntax      | <b>S_REF</b>                                                                                                                                                                                                                                                                                                                                                                                                                                                                                                                |
| Description | <p>This parameter contains the speed reference value which is applied directly to the Servo Driver when the axis is in open loop (<b>SERVO=OFF</b>). The range of this parameter is defined by the number of available bits. For MECHATROLINK-II axes, <b>S_REF</b> takes 32 bits, so the available range is [-2147483648, 2147483648]. This range can be limited by using the <b>OUTLIMIT</b> parameter.</p> <p>The value currently being applied to the driver can be read using the <b>S_REF_OUT</b> axis parameter.</p> |
| Arguments   | N/A                                                                                                                                                                                                                                                                                                                                                                                                                                                                                                                         |
| Example     | <p><b>WDOG = ON</b><br/><b>SERVO = OFF</b><br/><b>square:</b><br/><b>S_REF AXIS(0) = 2000</b><br/><b>WA(250)</b><br/><b>S_REF AXIS(0) = -2000</b><br/><b>WA(250)</b><br/><b>GOTO square</b></p> <p>These lines can be used to force a square wave of positive and negative movement with a period of approximately 500ms on axis 0.</p>                                                                                                                                                                                     |

See also **AXIS, S\_REF\_OUT, OUTLIMIT, SERVO.**

## 4-2-217 S\_REF\_OUT

Type Axis parameter (read-only)

Syntax **S\_REF\_OUT**

Description The **S\_REF\_OUT** parameter contains the speed reference value being applied to the Servo Driver for both open and closed loop. In closed loop (**SERVO=ON**), the motion control algorithm will output a speed reference signal determined by the control gain settings and the Following Error. The position of the servo motor is determined using the Axis commands. In open loop (**SERVO=OFF**), the speed reference signal is determined by the **S\_REF** axis parameter.

Arguments N/A

Example **>> PRINT S\_REF\_OUT AXIS(0)**  
**288.0000**

See also **AXIS, S\_REF, OUTLIMIT, SERVO.**

## 4-2-218 SCOPE

Type System command

Syntax **SCOPE(control, period, table\_start, table\_stop, P0 [ , P1 [ , P2 [ , P3 ]])**

Description The **SCOPE** command programs the system to automatically store up to 4 parameters every sample period. The storing of data will start as soon as the **TRIGGER** command has been executed. The sample period can be any multiple of the servo period. The parameters are stored in the **TABLE** array and can then be read back to a computer and displayed on the Trajexia Studio data trace or written to a file for further analysis using the **Create Table file** option on the **File** menu. The current **TABLE** position for the first parameter which is written by **SCOPE** can be read from the **SCOPE\_POS** parameter.

Notes:

1. Trajexia Studio uses the **SCOPE** command when running the Oscilloscope function.
2. To minimize calculation time for writing the real-time data, the **SCOPE** command is writing raw data to the **TABLE** array. For example
  - a) The parameters are written in encoder edges (per second) and therefore not compensated for the **UNITS** conversion factor.
  - b) The **MSPEED** parameter is written as the change in encoder edges per servo period.
3. Applications like the **CAM** command, **CAMBOX** command and the **SCOPE** command all use the same **TABLE** as the data area.

|           |                                                                                                                                                                                                                                                                                                                                                                                                                                                                                                                                                                                                                                                                                                                                                                             |
|-----------|-----------------------------------------------------------------------------------------------------------------------------------------------------------------------------------------------------------------------------------------------------------------------------------------------------------------------------------------------------------------------------------------------------------------------------------------------------------------------------------------------------------------------------------------------------------------------------------------------------------------------------------------------------------------------------------------------------------------------------------------------------------------------------|
| Arguments | <ul style="list-style-type: none"> <li>• <b>control</b><br/>Set on or off to control <b>SCOPE</b> execution. If turned on the <b>SCOPE</b> is ready to run as soon as the <b>TRIGGER</b> command is executed.</li> <li>• <b>period</b><br/>The number of servo periods between data samples.</li> <li>• <b>table_start</b><br/>The address of the first element in the <b>TABLE</b> array to start storing data.</li> <li>• <b>table_stop</b><br/>The address of the last element in the <b>TABLE</b> array to be used.</li> <li>• <b>P0</b><br/>First parameter to store.</li> <li>• <b>P1</b><br/>Optional second parameter to store.</li> <li>• <b>P2</b><br/>Optional third parameter to store.</li> <li>• <b>P3</b><br/>Optional fourth parameter to store.</li> </ul> |
| Example   | <p><b>SCOPE(ON,10,0,1000,MPOS AXIS(1),DPOS AXIS(1))</b><br/>This example programs the <b>SCOPE</b> function to store the <b>MPOS</b> parameter for axis 1 and the <b>DPOS</b> parameter for axis 1 every 10 servo cycles. The <b>MPOS</b> parameter will be stored in <b>TABLE</b> locations 0 to 499; the <b>DPOS</b> parameters, in <b>TABLE</b> locations 500 to 999. The <b>SCOPE</b> function will wrap and start storing at the beginning again unless stopped. Sampling will not start until the <b>TRIGGER</b> command is executed.</p>                                                                                                                                                                                                                             |
| Example   | <p><b>SCOPE(OFF)</b><br/>This above line turns the scope function off.</p>                                                                                                                                                                                                                                                                                                                                                                                                                                                                                                                                                                                                                                                                                                  |
| See also  | <b>SCOPE_POS, TABLE, TRIGGER.</b>                                                                                                                                                                                                                                                                                                                                                                                                                                                                                                                                                                                                                                                                                                                                           |

## 4-2-219 SCOPE\_POS

|             |                                                                                                                                                  |
|-------------|--------------------------------------------------------------------------------------------------------------------------------------------------|
| Type        | System parameter (read-only)                                                                                                                     |
| Syntax      | <b>SCOPE_POS</b>                                                                                                                                 |
| Description | The <b>SCOPE_POS</b> parameter contains the current <b>TABLE</b> position at which the <b>SCOPE</b> command is currently storing its parameters. |
| Arguments   | N/A                                                                                                                                              |
| Example     | No example.                                                                                                                                      |
| See also    | <b>SCOPE.</b>                                                                                                                                    |



**4-2-220 SELECT**

|             |                                                                                                                                                                                                                                                                                                                                                                                                                                                                                                                                                                                                                                                                                                                                                                                                                                                                            |
|-------------|----------------------------------------------------------------------------------------------------------------------------------------------------------------------------------------------------------------------------------------------------------------------------------------------------------------------------------------------------------------------------------------------------------------------------------------------------------------------------------------------------------------------------------------------------------------------------------------------------------------------------------------------------------------------------------------------------------------------------------------------------------------------------------------------------------------------------------------------------------------------------|
| Type        | Program command                                                                                                                                                                                                                                                                                                                                                                                                                                                                                                                                                                                                                                                                                                                                                                                                                                                            |
| Syntax      | <b>SELECT "program_name"</b>                                                                                                                                                                                                                                                                                                                                                                                                                                                                                                                                                                                                                                                                                                                                                                                                                                               |
| Description | <p>The <b>SELECT</b> command specifies the current program for editing, running, listing, etc. <b>SELECT</b> makes a new program if a program with the name entered does not exist. The program name can also be specified without quotes.</p> <p>When a program is selected, the commands <b>COMPILE</b>, <b>DEL</b>, <b>EDIT</b>, <b>LIST</b>, <b>NEW</b>, <b>RUN</b>, <b>STEPLINE</b>, <b>STOP</b> and <b>TROFF</b> will apply to the currently selected program unless a program name is specified in the command line. When another program is selected, the previously selected program will be compiled. The selected program cannot be changed when a program is running.</p> <p>Note: This command is implemented for a Command Line Terminal. Trajexia Studio automatically selects programs when you click on their entry in the list in the control panel.</p> |
| Arguments   | N/A                                                                                                                                                                                                                                                                                                                                                                                                                                                                                                                                                                                                                                                                                                                                                                                                                                                                        |
| Example     | <pre>&gt;&gt; SELECT "PROGRAM" PROGRAM selected &gt;&gt; RUN</pre>                                                                                                                                                                                                                                                                                                                                                                                                                                                                                                                                                                                                                                                                                                                                                                                                         |
| See also    | <b>COMPILE, DEL, EDIT, LIST, NEW, RUN, STEPLINE, STOP, TROFF.</b>                                                                                                                                                                                                                                                                                                                                                                                                                                                                                                                                                                                                                                                                                                                                                                                                          |

**4-2-221 SERVO**

|             |                                                                                                                                                                                                                                                                                                                                                                                                                                                                                                   |
|-------------|---------------------------------------------------------------------------------------------------------------------------------------------------------------------------------------------------------------------------------------------------------------------------------------------------------------------------------------------------------------------------------------------------------------------------------------------------------------------------------------------------|
| Type        | Axis parameter                                                                                                                                                                                                                                                                                                                                                                                                                                                                                    |
| Syntax      | <b>SERVO</b>                                                                                                                                                                                                                                                                                                                                                                                                                                                                                      |
| Description | <p>The <b>SERVO</b> parameter determines whether the base axis runs under servo closed loop control (<b>SERVO=ON</b>) or open loop (<b>SERVO=OFF</b>). In closed loop, the motion control algorithm will output a speed reference signal determined by the control gain settings and the Following Error. The position of the servo motor is determined using the Axis commands.</p> <p>In open loop, the speed reference signal is completely determined by the <b>S_REF</b> axis parameter.</p> |
| Arguments   | N/A                                                                                                                                                                                                                                                                                                                                                                                                                                                                                               |
| Example     | <pre>SERVO AXIS(0) = ON ' Axis 0 is under servo control SERVO AXIS(1) = OFF ' Axis 1 is run open loop</pre>                                                                                                                                                                                                                                                                                                                                                                                       |
| See also    | <b>AXIS, FE_LIMIT, S_REF, S_REF_OUT, WDOG.</b>                                                                                                                                                                                                                                                                                                                                                                                                                                                    |

## 4-2-222 SERVO\_PERIOD

|             |                                                                                                                                                                                                                                                                                                                                                                                                                                                   |
|-------------|---------------------------------------------------------------------------------------------------------------------------------------------------------------------------------------------------------------------------------------------------------------------------------------------------------------------------------------------------------------------------------------------------------------------------------------------------|
| Type        | System parameter                                                                                                                                                                                                                                                                                                                                                                                                                                  |
| Syntax      | <b>SERVO_PERIOD</b>                                                                                                                                                                                                                                                                                                                                                                                                                               |
| Description | The <b>SERVO_PERIOD</b> parameter sets the servo cycle period of the CJ1W-MCH72. The timing of the execution of the program tasks and the refreshing of the control data and I/O of the Unit are all depending on this setting. The parameter is defined in microseconds. The CJ1W-MCH72 can be set in either 0.5, 1.0, 2.0 or 4.0 ms servo cycle. See the table below. The controller must be reset before the new servo period will be applied. |

| Value | Description |
|-------|-------------|
| 500   | 0.5 ms      |
| 1000  | 1.0 ms      |
| 2000  | 2.0 ms      |
| 4000  | 4.0 ms      |

|           |             |
|-----------|-------------|
| Arguments | N/A         |
| Example   | No example. |
| See also  | EX.         |

 **Caution** When the parameter has been set, a power down or software reset (using **EX**) must be performed for the complete system. Not doing so may result in undefined behaviour.

## 4-2-223 SET\_BIT

|             |                                                                                                                                                                                                                                    |
|-------------|------------------------------------------------------------------------------------------------------------------------------------------------------------------------------------------------------------------------------------|
| Type        | System command                                                                                                                                                                                                                     |
| Syntax      | <b>SET_BIT(bit_number, vr_number)</b>                                                                                                                                                                                              |
| Description | The <b>SET_BIT</b> command sets the specified bit in the specified VR variable to one. Other bits in the variable will keep their values.                                                                                          |
| Arguments   | <ul style="list-style-type: none"> <li>• <b>bit_number</b><br/>The number of the bit to be set. Range: [0,23].</li> <li>• <b>vr_number</b><br/>The number of the VR variable for which the bit is set. Range: [0,1023].</li> </ul> |
| Example     | No example.                                                                                                                                                                                                                        |
| See also    | <b>CLEAR_BIT, READ_BIT, VR.</b>                                                                                                                                                                                                    |

**4-2-224 SGN**

|             |                                                                                                                                              |
|-------------|----------------------------------------------------------------------------------------------------------------------------------------------|
| Type        | Mathematical function                                                                                                                        |
| Syntax      | <b>SGN(expression)</b>                                                                                                                       |
| Description | The <b>SGN</b> function returns the sign of a number. It returns value 1 for positive values (including 0) and value -1 for negative values. |
| Arguments   | <ul style="list-style-type: none"><li>• <b>expression</b><br/>Any valid BASIC expression.</li></ul>                                          |
| Example     | <pre>&gt;&gt; PRINT SGN(-1.2) -1.0000</pre>                                                                                                  |
| See also    | N/A                                                                                                                                          |

**4-2-225 SIN**

|             |                                                                                                                                                                     |
|-------------|---------------------------------------------------------------------------------------------------------------------------------------------------------------------|
| Type        | Mathematical function                                                                                                                                               |
| Syntax      | <b>SIN(expression)</b>                                                                                                                                              |
| Description | The <b>SIN</b> function returns the sine of the expression. Input values are in radians and may have any value. The result value will be in the range from -1 to 1. |
| Arguments   | <ul style="list-style-type: none"><li>• <b>expression</b><br/>Any valid BASIC expression.</li></ul>                                                                 |
| Example     | <pre>&gt;&gt; PRINT SIN(PI/2) 1.0000</pre>                                                                                                                          |
| See also    | N/A                                                                                                                                                                 |

**4-2-226 SPEED**

|             |                                                                                                                                                                                                          |
|-------------|----------------------------------------------------------------------------------------------------------------------------------------------------------------------------------------------------------|
| Type        | Axis parameter                                                                                                                                                                                           |
| Syntax      | <b>SPEED</b>                                                                                                                                                                                             |
| Description | The <b>SPEED</b> parameter contains the demand speed for an axis in units/s. It can have any positive value (including 0). The demand speed is the maximum speed for the speed profiled motion commands. |
| Arguments   | N/A                                                                                                                                                                                                      |
| Example     | <pre>SPEED = 1000 PRINT "Set speed = ";SPEED</pre>                                                                                                                                                       |
| See also    | <b>ACCEL, AXIS, DATUM, DECEL, FORWARD, MOVE, MOVEABS, MOVECIRC, MOVEMODIFY, REVERSE, UNITS.</b>                                                                                                          |

## 4-2-227 SPEED\_SIGN

|             |                                                                                                                                                                                                                                                                                                                                                                                                                                                                                                                                                                                                                                                                                                                                                                                                                                                                                                                                                                                                                                     |
|-------------|-------------------------------------------------------------------------------------------------------------------------------------------------------------------------------------------------------------------------------------------------------------------------------------------------------------------------------------------------------------------------------------------------------------------------------------------------------------------------------------------------------------------------------------------------------------------------------------------------------------------------------------------------------------------------------------------------------------------------------------------------------------------------------------------------------------------------------------------------------------------------------------------------------------------------------------------------------------------------------------------------------------------------------------|
| Type        | Axis parameter                                                                                                                                                                                                                                                                                                                                                                                                                                                                                                                                                                                                                                                                                                                                                                                                                                                                                                                                                                                                                      |
| Syntax      | <b>SPEED_SIGN</b>                                                                                                                                                                                                                                                                                                                                                                                                                                                                                                                                                                                                                                                                                                                                                                                                                                                                                                                                                                                                                   |
| Description | <p>The <b>SPEED_SIGN</b> parameter configures the voltage range of the analogue speed reference output of the Encoder Interface when the axis type <b>ATYPE</b> is set to 44.</p> <p>If <b>SPEED_SIGN = OFF</b>, the voltage range of the analogue speed reference output is [-10V, 10V]. The positive reference voltage corresponds to forward movements, in which case <b>DPOS</b> and <b>MPOS</b> increment. The negative reference voltage corresponds to reverse movements, in which case <b>DPOS</b> and <b>MPOS</b> decrement. OFF is the default setting at power-on.</p> <p>If <b>SPEED_SIGN = ON</b>, the voltage range of the analogue speed reference output is [0V, 10V]. The OUT1 signal of the Encoder Interface for the corresponding axis is used as a direction signal. During forward movements, the controller sets OUT1 to OFF. During reverse movements, the controller sets OUT1 to ON. This setting is to be used for Servo Drivers that require both speed and direction signals as a speed reference.</p> |
| Arguments   | N/A                                                                                                                                                                                                                                                                                                                                                                                                                                                                                                                                                                                                                                                                                                                                                                                                                                                                                                                                                                                                                                 |
| Example     | No example.                                                                                                                                                                                                                                                                                                                                                                                                                                                                                                                                                                                                                                                                                                                                                                                                                                                                                                                                                                                                                         |
| See also    | <b>ATYPE, S_REF, S_REF_OUT.</b>                                                                                                                                                                                                                                                                                                                                                                                                                                                                                                                                                                                                                                                                                                                                                                                                                                                                                                                                                                                                     |

## 4-2-228 SQR

|             |                                                                                                                           |
|-------------|---------------------------------------------------------------------------------------------------------------------------|
| Type        | Mathematical function                                                                                                     |
| Syntax      | <b>SQR(expression)</b>                                                                                                    |
| Description | The <b>SQR</b> function returns the square root of the expression. The expression must have positive (including 0) value. |
| Arguments   | <ul style="list-style-type: none"><li>• <b>expression</b><br/>Any valid BASIC expression.</li></ul>                       |
| Example     | <pre>&gt;&gt; PRINT SQR(4)<br/>2.0000</pre>                                                                               |
| See also    | N/A                                                                                                                       |

**4-2-229 SRAMP**

|             |                                                                                                                                                                                                                                                                                                                                                                                                                                                                                                                                                                                                                                            |
|-------------|--------------------------------------------------------------------------------------------------------------------------------------------------------------------------------------------------------------------------------------------------------------------------------------------------------------------------------------------------------------------------------------------------------------------------------------------------------------------------------------------------------------------------------------------------------------------------------------------------------------------------------------------|
| Type        | Axis parameter                                                                                                                                                                                                                                                                                                                                                                                                                                                                                                                                                                                                                             |
| Syntax      | <b>SRAMP</b>                                                                                                                                                                                                                                                                                                                                                                                                                                                                                                                                                                                                                               |
| Description | <p>The <b>SRAMP</b> parameter contains the S-curve factor. The S-curve factor controls the amount of rounding applied to the trapezoidal profiles. A value of 0 sets no rounding. A value of 10 sets maximum rounding. The default value of the parameter is 0.</p> <p><b>SRAMP</b> is applied to the <b>FORWARD</b>, <b>MOVE</b>, <b>MOVEABS</b>, <b>MOVECIRC</b>, <b>MHELICAL</b> and <b>REVERSE</b> commands.</p> <p>Notes:</p> <ul style="list-style-type: none"> <li>Using S-curves increases the time required for the movement to complete.</li> <li>The S-curve factor must not be changed while a move is in progress.</li> </ul> |
| Arguments   | N/A                                                                                                                                                                                                                                                                                                                                                                                                                                                                                                                                                                                                                                        |
| Example     | No example.                                                                                                                                                                                                                                                                                                                                                                                                                                                                                                                                                                                                                                |
| See also    | <b>AXIS</b> .                                                                                                                                                                                                                                                                                                                                                                                                                                                                                                                                                                                                                              |

**4-2-230 STEP**

See **FOR..TO..STEP..NEXT**.

**4-2-231 STEP\_RATIO**

|             |                                                                                                                                                                                                                                                                                                                                                                                                                                                                                                                                                                                                                                                                                                                                                                                                                                                                                                                                                                                                                            |
|-------------|----------------------------------------------------------------------------------------------------------------------------------------------------------------------------------------------------------------------------------------------------------------------------------------------------------------------------------------------------------------------------------------------------------------------------------------------------------------------------------------------------------------------------------------------------------------------------------------------------------------------------------------------------------------------------------------------------------------------------------------------------------------------------------------------------------------------------------------------------------------------------------------------------------------------------------------------------------------------------------------------------------------------------|
| Type        | Axis command                                                                                                                                                                                                                                                                                                                                                                                                                                                                                                                                                                                                                                                                                                                                                                                                                                                                                                                                                                                                               |
| Syntax      | <b>STEP_RATIO(output_count, dpos_count)</b>                                                                                                                                                                                                                                                                                                                                                                                                                                                                                                                                                                                                                                                                                                                                                                                                                                                                                                                                                                                |
| Description | <p>This command sets up a ratio for the output of the stepper axis. Every servo-period the number of steps is passed through the <b>STEP_RATIO</b> function before it goes to the step pulse output.</p> <p>Pulse Count Out = (numerator)/(denominator) * <b>MPOS</b>.</p> <p><b>STEP_RATIO</b> affects both <b>MOVECIRC</b> and <b>CAMBOX</b>.</p> <p>Notes:</p> <ul style="list-style-type: none"> <li>The <b>STEP_RATIO</b> function operates before the divide by 16 factor in the stepper axis.</li> <li>Large ratios should be avoided as they will lead to either loss of resolution or much reduced smoothness in the motion. The actual physical step size x 16 is the BASIC resolution of the axis and use of this command may reduce the ability of the Motion Controller to accurately achieve all positions.</li> <li><b>STEP_RATIO</b> does not replace <b>UNITS</b>. Do not use <b>STEP_RATIO</b> to remove the x16 factor on the stepper axis as this will lead to poor step frequency control.</li> </ul> |
| Arguments   | <ul style="list-style-type: none"> <li><b>denominator</b><br/>An integer number between 0 and 16777215 that is used to define the denominator in the above equation.</li> <li><b>numerator</b><br/>An integer number between 0 and 16777215 that is used to define the numerator in the above equation.</li> </ul>                                                                                                                                                                                                                                                                                                                                                                                                                                                                                                                                                                                                                                                                                                         |

|          |                                                                                                                                                                                                                                                                                                                                                                                                                                                                                                                                                                                                        |
|----------|--------------------------------------------------------------------------------------------------------------------------------------------------------------------------------------------------------------------------------------------------------------------------------------------------------------------------------------------------------------------------------------------------------------------------------------------------------------------------------------------------------------------------------------------------------------------------------------------------------|
| Example  | Two axes are set up as X and Y but the axes ' steps per mm are not the same. Interpolated moves require identical UNITS values on both axes in order to keep the path speed constant and for MOVECIRC to work correctly. The axis with the lower resolution is changed to match the higher step resolution axis so as to maintain the best accuracy for both axes.<br><b>' Axis 0: 500 counts per mm (31.25 steps per mm)</b><br><b>' Axis 1: 800 counts per mm (50.00 steps per mm)</b><br><b>BASE(0)</b><br><b>STEP_RATIO(500,800)</b><br><b>UNITS = 800</b><br><b>BASE(1)</b><br><b>UNITS = 800</b> |
| See also | N/A                                                                                                                                                                                                                                                                                                                                                                                                                                                                                                                                                                                                    |

## 4-2-232 STEPLINE

|             |                                                                                                                                                                                                                                                                                                                                                                                                                                                                                                                                                                                                                                                                                                                                                                              |
|-------------|------------------------------------------------------------------------------------------------------------------------------------------------------------------------------------------------------------------------------------------------------------------------------------------------------------------------------------------------------------------------------------------------------------------------------------------------------------------------------------------------------------------------------------------------------------------------------------------------------------------------------------------------------------------------------------------------------------------------------------------------------------------------------|
| Type        | Program command                                                                                                                                                                                                                                                                                                                                                                                                                                                                                                                                                                                                                                                                                                                                                              |
| Syntax      | <b>STEPLINE [ "program_name" [ , task_number ] ]</b>                                                                                                                                                                                                                                                                                                                                                                                                                                                                                                                                                                                                                                                                                                                         |
| Description | The <b>STEPLINE</b> command executes one line (i.e., "steps") in the program specified by <b>program_name</b> . The program name can also be specified without quotes. If <b>STEPLINE</b> is executed without program name on the command line the current selected program will be stepped. If <b>STEPLINE</b> is executed without program name in a program this program will be stepped.<br>If the program is specified then all occurrences of this program will be stepped. A new task will be started when there is no copy of the program running. If the task is specified as well then only the copy of the program running on the specified task will be stepped. If there is no copy of the program running on the specified task then one will be started on it. |
| Arguments   | <ul style="list-style-type: none"> <li>• <b>program_name</b><br/>The name of the program to be stepped.</li> <li>• <b>task_number</b><br/>The number of the task with the program to be stepped. Range: [1,14].</li> </ul>                                                                                                                                                                                                                                                                                                                                                                                                                                                                                                                                                   |
| Example     | >> <b>STEPLINE "conveyor"</b>                                                                                                                                                                                                                                                                                                                                                                                                                                                                                                                                                                                                                                                                                                                                                |
| Example     | >> <b>STEPLINE "maths",2</b>                                                                                                                                                                                                                                                                                                                                                                                                                                                                                                                                                                                                                                                                                                                                                 |
| See also    | <b>RUN, SELECT, STOP, TROFF, TRON.</b>                                                                                                                                                                                                                                                                                                                                                                                                                                                                                                                                                                                                                                                                                                                                       |

## 4-2-233 STOP

|             |                                                                                                                                                                                                                                                                                                                                                                                                    |
|-------------|----------------------------------------------------------------------------------------------------------------------------------------------------------------------------------------------------------------------------------------------------------------------------------------------------------------------------------------------------------------------------------------------------|
| Type        | Program command                                                                                                                                                                                                                                                                                                                                                                                    |
| Syntax      | <b>STOP [ "program_name" [ , task_number ] ]</b>                                                                                                                                                                                                                                                                                                                                                   |
| Description | The <b>STOP</b> command will halt execution of the program specified with <b>program_name</b> . If the program name is omitted, then the currently selected program will be halted. The program name can also be specified without quotes.<br>In case of multiple executions of a single program on different tasks the <b>task_number</b> can be used to specify the specific task to be stopped. |

|           |                                                                                                                                                                                                                            |
|-----------|----------------------------------------------------------------------------------------------------------------------------------------------------------------------------------------------------------------------------|
| Arguments | <ul style="list-style-type: none"> <li>• <b>program_name</b><br/>The name of the program to be stopped.</li> <li>• <b>task_number</b><br/>The number of the task with the program to be stopped. Range: [1,14].</li> </ul> |
| Example   | <b>&gt;&gt; STOP progname</b>                                                                                                                                                                                              |
| Example   | The lines from label on will not be executed in this example.<br><b>STOP</b><br><b>label:</b><br><b>PRINT var</b><br><b>RETURN</b>                                                                                         |
| See also  | <b>HALT, RUN, SELECT.</b>                                                                                                                                                                                                  |

### 4-2-234 SYSTEM\_ERROR

|             |                                                                                                                                                                                                                   |
|-------------|-------------------------------------------------------------------------------------------------------------------------------------------------------------------------------------------------------------------|
| Type        | System parameter (read only)                                                                                                                                                                                      |
| Syntax      | <b>SYSTEM_ERROR</b>                                                                                                                                                                                               |
| Description | The <b>SYSTEM_ERROR</b> parameter contains system errors that occurred in the Trajexia system since the last time it was initialized. The bits in the <b>SYSTEM_ERROR</b> parameter are given in the table below. |

| Bit    | Description                                                  |
|--------|--------------------------------------------------------------|
| 0      | BASIC error                                                  |
| 1      | Battery low error                                            |
| 2 - 17 | Reserved for future use                                      |
| 18     | MECHATROLINK-II device lost error (Any device in the system) |

|           |             |
|-----------|-------------|
| Arguments | N/A.        |
| Example   | No example. |
| See also  | N/A         |

### 4-2-235 T\_REF

|             |                                                                                                                                                                                                                                                                                                                                                                                                                               |
|-------------|-------------------------------------------------------------------------------------------------------------------------------------------------------------------------------------------------------------------------------------------------------------------------------------------------------------------------------------------------------------------------------------------------------------------------------|
| Type        | Axis parameter                                                                                                                                                                                                                                                                                                                                                                                                                |
| Syntax      | <b>T_REF</b>                                                                                                                                                                                                                                                                                                                                                                                                                  |
| Description | The <b>T_REF</b> parameter contains the torque reference value which will be applied to the servo motor. The range of this parameter is defined by the number of available bits. For MECHATROLINK-II axes, <b>T_REF</b> takes 32 bits, so the available range is [-2147483648, 2147483648]. This range can be limited by using the <b>OUTLIMIT</b> parameter.<br>The actual torque reference is depending on the servo motor. |
| Arguments   | N/A                                                                                                                                                                                                                                                                                                                                                                                                                           |
| Example     | <b>T_REF AXIS(0)=1000</b>                                                                                                                                                                                                                                                                                                                                                                                                     |
| See also    | <b>AXIS, S_REF.</b>                                                                                                                                                                                                                                                                                                                                                                                                           |

## 4-2-236 TABLE

|             |                                                                                                                                                                                                                                                                                                                                                                                                                                                                                                                                                                                                                                                                                           |
|-------------|-------------------------------------------------------------------------------------------------------------------------------------------------------------------------------------------------------------------------------------------------------------------------------------------------------------------------------------------------------------------------------------------------------------------------------------------------------------------------------------------------------------------------------------------------------------------------------------------------------------------------------------------------------------------------------------------|
| Type        | System command                                                                                                                                                                                                                                                                                                                                                                                                                                                                                                                                                                                                                                                                            |
| Syntax      | <b>TABLE(address, value {, value})</b><br><b>TABLE(address)</b>                                                                                                                                                                                                                                                                                                                                                                                                                                                                                                                                                                                                                           |
| Description | <p>The <b>TABLE</b> command loads data to and reads data from the TABLE array. The TABLE has a maximum length of 64000 elements. The TABLE values are floating-point numbers with fractions. The TABLE can also be used to hold information, as an alternative to variables. The <b>TABLE</b> command has two forms.</p> <ul style="list-style-type: none"> <li>• <b>TABLE(address, value{, value})</b> writes a sequence of values to the TABLE array. The location of the first element to write is specified by address. The sequence can have a maximum length of 20 elements.</li> <li>• <b>TABLE(address)</b> returns the TABLE value at the entry specified by address.</li> </ul> |

A value in the TABLE can be read-only if a value of that number or higher has been previously written to the TABLE. For example, printing **TABLE(1001)** will produce an error message if the highest TABLE location previously written to the TABLE is location 1000. The total TABLE size is indicated by the **TSIZE** parameter. Note that this value is one more than the highest defined element address. The TABLE can be deleted with by using **DEL "TABLE"** or **NEW "TABLE"** on the command line.

Notes:

- Applications like the **CAM** command, **CAMBOX** command and the **SCOPE** command in Trajexia Studio all use the same TABLE as the data area. Do not use the same data area range for different purposes.
- The TABLE and VR data can be accessed from all different running tasks. To avoid problems of two program tasks writing unexpectedly to one global variable, write the programs in such a way that only one program writes to the global variable at a time.

|           |                                                                                                                                                                                                                                             |
|-----------|---------------------------------------------------------------------------------------------------------------------------------------------------------------------------------------------------------------------------------------------|
| Arguments | <ul style="list-style-type: none"> <li>• <b>address</b><br/>The first location in the TABLE to read or write. Range: [0,63999]</li> <li>• <b>value</b><br/>The value to write at the given location and at subsequent locations.</li> </ul> |
|-----------|---------------------------------------------------------------------------------------------------------------------------------------------------------------------------------------------------------------------------------------------|

Example **TABLE(100,0,120,250,370,470,530,550)**  
The above line loads an internal table as below.

| Table entry | Value |
|-------------|-------|
| 100         | 0     |
| 101         | 120   |
| 102         | 250   |
| 103         | 370   |
| 104         | 470   |
| 105         | 530   |
| 106         | 550   |



Example      The following line will print the value at location 1000.  
                  >> **PRINT TABLE(1000)**

See also      **CAM, CAMBOX, DEL, NEW, SCOPE, TSIZE, VR.**

## 4-2-237 TABLEVALUES

Type            System command

Syntax          **TABLEVALUES(address, number\_of\_points, format)**

Description    Returns a list of TABLE points starting at the number specified. There is only one format supported at the moment, and that is comma delimited text.  
                  Note: **TABLEVALUES** is provided mainly for Trajexia Studio to allow for fast access to banks of TABLE values.

Arguments      • **address**  
                       Number of the first point to be returned

                  • **number\_of\_points**  
                       Total number of points to be returned

                  • **format**  
                       Format for the list

Example        No example.

See also        N/A

## 4-2-238 TAN

Type            Mathematical function

Syntax          **TAN(expression)**

Description    The **TAN** function returns the tangent of the expression. The expression is assumed to be in radians.

Arguments      • **expression**  
                       Any valid BASIC expression.

Example        >> **print TAN(PI/4)**  
                       **1.0000**

See also        N/A

## 4-2-239 THEN

See **IF..THEN..ELSE..ENDIF.**

**4-2-240 TICKS**

|             |                                                                                                                                                                                                                                                                                                                                                                                                                                               |
|-------------|-----------------------------------------------------------------------------------------------------------------------------------------------------------------------------------------------------------------------------------------------------------------------------------------------------------------------------------------------------------------------------------------------------------------------------------------------|
| Type        | Task parameter                                                                                                                                                                                                                                                                                                                                                                                                                                |
| Syntax      | <b>TICKS</b>                                                                                                                                                                                                                                                                                                                                                                                                                                  |
| Description | The <b>TICKS</b> parameter contains the current count of the task clock pulses. <b>TICKS</b> is a 32-bit counter that is decremented on each servo cycle. <b>TICKS</b> can be written and read. It can be used to measure cycles times, add time delays, etc.<br>Each task has its own <b>TICKS</b> parameter. Use the <b>PROC</b> modifier to access the parameter for a certain task. Without <b>PROC</b> the current task will be assumed. |
| Arguments   | N/A                                                                                                                                                                                                                                                                                                                                                                                                                                           |
| Example     | <b>delay:</b><br><b>TICKS = 3000</b><br><b>OP(9,ON)</b><br><b>test:</b><br><b>IF TICKS &lt;= 0 THEN</b><br><b>OP(9,OFF)</b><br><b>ELSE</b><br><b>GOTO test</b><br><b>ENDIF</b>                                                                                                                                                                                                                                                                |
| See also    | N/A                                                                                                                                                                                                                                                                                                                                                                                                                                           |

**4-2-241 TIME**

|             |                                                                                                                              |
|-------------|------------------------------------------------------------------------------------------------------------------------------|
| Type        | System parameter (read-only)                                                                                                 |
| Syntax      | <b>TIME</b>                                                                                                                  |
| Description | Returns the time from the real time clock. The time returned as an integer is the number of seconds since midnight 00:00:00. |
| Arguments   | N/A                                                                                                                          |
| Example     | <b>&gt;&gt; PRINT TIME</b><br><b>&gt;&gt; 48002.0000</b>                                                                     |
| See also    | N/A                                                                                                                          |

**4-2-242 TIME\$**

|             |                                                                                          |
|-------------|------------------------------------------------------------------------------------------|
| Type        | System command                                                                           |
| Syntax      | <b>TIME\$</b>                                                                            |
| Description | Prints the current time as defined by the real time clock as a string in 24-hour format. |
| Arguments   | N/A                                                                                      |
| Example     | When the time is 13:20:00<br><b>&gt;&gt; PRINT TIME\$</b><br><b>&gt;&gt; 13:20:00</b>    |
| See also    | N/A                                                                                      |

**4-2-243 TO**

See **FOR..TO..STEP..NEXT**.

**4-2-244 TRANS\_DPOS**

|             |                                                                                                                                                                                                                                                                                                                                                                                                                                                                                                                                                                                                  |
|-------------|--------------------------------------------------------------------------------------------------------------------------------------------------------------------------------------------------------------------------------------------------------------------------------------------------------------------------------------------------------------------------------------------------------------------------------------------------------------------------------------------------------------------------------------------------------------------------------------------------|
| Type        | Axis parameter (read-only)                                                                                                                                                                                                                                                                                                                                                                                                                                                                                                                                                                       |
| Syntax      | <b>TRANS_DPOS</b>                                                                                                                                                                                                                                                                                                                                                                                                                                                                                                                                                                                |
| Description | Axis demand position at output of frame transformation. <b>TRANS_DPOS</b> is normally equal to <b>DPOS</b> on each axis. The frame transformation is therefore equivalent to 1:1 for each axis. For some machinery configurations it can be useful to install a frame transformation which is not 1:1, these are typically machines such as robotic arms or machines with parasitic motions on the axes. Frame transformations have to be specially written in the C language and downloaded into the controller. It is essential to contact OMRON if you want to install frame transformations. |
| Arguments   | N/A                                                                                                                                                                                                                                                                                                                                                                                                                                                                                                                                                                                              |
| Example     | No example.                                                                                                                                                                                                                                                                                                                                                                                                                                                                                                                                                                                      |
| See also    | <b>FRAME</b> .                                                                                                                                                                                                                                                                                                                                                                                                                                                                                                                                                                                   |

**4-2-245 TRIGGER**

|             |                                                                                                                                                                    |
|-------------|--------------------------------------------------------------------------------------------------------------------------------------------------------------------|
| Type        | System command                                                                                                                                                     |
| Syntax      | <b>TRIGGER</b>                                                                                                                                                     |
| Description | The <b>TRIGGER</b> command starts a previously set up <b>SCOPE</b> command. Note: Trajexia Studio uses <b>TRIGGER</b> automatically for its oscilloscope function. |
| Arguments   | N/A                                                                                                                                                                |
| Example     | No example.                                                                                                                                                        |
| See also    | <b>SCOPE</b> .                                                                                                                                                     |

**4-2-246 TROFF**

|             |                                                                                                                                                                                                                                                                                      |
|-------------|--------------------------------------------------------------------------------------------------------------------------------------------------------------------------------------------------------------------------------------------------------------------------------------|
| Type        | Program command                                                                                                                                                                                                                                                                      |
| Syntax      | <b>TROFF [ "program_name" ]</b>                                                                                                                                                                                                                                                      |
| Description | The <b>TROFF</b> command suspends a trace at the current line and resumes normal program execution for the program specified with <b>program_name</b> . The program name can also be specified without quotes. If the program name is omitted, the selected program will be assumed. |
| Arguments   | <ul style="list-style-type: none"> <li>• <b>program_name</b><br/>The name of the program for which to suspend tracing.</li> </ul>                                                                                                                                                    |
| Example     | <b>&gt;&gt; TROFF "lines"</b>                                                                                                                                                                                                                                                        |
| See also    | <b>SELECT, TRON</b> .                                                                                                                                                                                                                                                                |

**4-2-247 TRON**

|             |                                                                                                                                                                                                                                                                                                                                                                                                                                                                                                                           |
|-------------|---------------------------------------------------------------------------------------------------------------------------------------------------------------------------------------------------------------------------------------------------------------------------------------------------------------------------------------------------------------------------------------------------------------------------------------------------------------------------------------------------------------------------|
| Type        | Program command                                                                                                                                                                                                                                                                                                                                                                                                                                                                                                           |
| Syntax      | <b>TRON</b>                                                                                                                                                                                                                                                                                                                                                                                                                                                                                                               |
| Description | The <b>TRON</b> command creates a breakpoint in a program that will suspend program execution at the line following the <b>TRON</b> command. The program can then for example be executed one line at a time using the <b>STEPLINE</b> command.<br>Notes: <ul style="list-style-type: none"> <li>• Program execution can be resumed without using the <b>STEPLINE</b> command by executing the <b>TROFF</b> command.</li> <li>• The trace mode can be stopped by issuing a <b>STOP</b> or <b>HALT</b> command.</li> </ul> |
| Arguments   | N/A                                                                                                                                                                                                                                                                                                                                                                                                                                                                                                                       |
| Example     | <b>TRON</b><br><b>MOVE(0,10)</b><br><b>MOVE(10,0)</b><br><b>TRON</b><br><b>MOVE(0,-10)</b><br><b>MOVE(-10,0)</b>                                                                                                                                                                                                                                                                                                                                                                                                          |
| See also    | <b>SELECT, TROFF.</b>                                                                                                                                                                                                                                                                                                                                                                                                                                                                                                     |

**4-2-248 TRUE**

|             |                                                                                                                       |
|-------------|-----------------------------------------------------------------------------------------------------------------------|
| Type        | Constant (read-only)                                                                                                  |
| Syntax      | <b>TRUE</b>                                                                                                           |
| Description | The <b>TRUE</b> constant returns the numerical value -1.                                                              |
| Arguments   | N/A                                                                                                                   |
| Example     | <b>test:</b><br><b>t = IN(0) AND IN(2)</b><br><b>IF t = TRUE THEN</b><br><b>PRINT "Inputs are ON"</b><br><b>ENDIF</b> |
| See also    | N/A                                                                                                                   |

**4-2-249 TSIZE**

|             |                                                                                                                                                                                                                                                                       |
|-------------|-----------------------------------------------------------------------------------------------------------------------------------------------------------------------------------------------------------------------------------------------------------------------|
| Type        | System parameter (read-only)                                                                                                                                                                                                                                          |
| Syntax      | <b>TSIZE</b>                                                                                                                                                                                                                                                          |
| Description | The <b>TSIZE</b> parameter returns the size of the TABLE array, which is one more than the currently highest defined TABLE element.<br><b>TSIZE</b> is reset to 0 when the TABLE array is deleted using <b>DEL "TABLE"</b> or <b>NEW "TABLE"</b> on the command line. |
| Arguments   | N/A                                                                                                                                                                                                                                                                   |

|          |                                                                                                                                                                             |
|----------|-----------------------------------------------------------------------------------------------------------------------------------------------------------------------------|
| Example  | The following example assumes that no location higher than 1000 has been written to the TABLE array.<br><pre>&gt;&gt; TABLE(1000,3400) &gt;&gt; PRINT TSIZE 1001.0000</pre> |
| See also | DEL, NEW, TABLE.                                                                                                                                                            |

## 4-2-250 UNITS

|             |                                                                                                                                                                                                                                                                                                                                                                                                                                                                                                                                                                                                                                                                                       |
|-------------|---------------------------------------------------------------------------------------------------------------------------------------------------------------------------------------------------------------------------------------------------------------------------------------------------------------------------------------------------------------------------------------------------------------------------------------------------------------------------------------------------------------------------------------------------------------------------------------------------------------------------------------------------------------------------------------|
| Type        | Axis parameter                                                                                                                                                                                                                                                                                                                                                                                                                                                                                                                                                                                                                                                                        |
| Syntax      | <b>UNITS</b>                                                                                                                                                                                                                                                                                                                                                                                                                                                                                                                                                                                                                                                                          |
| Description | The <b>UNITS</b> parameter contains the unit conversion factor. The unit conversion factor enables the user to define a more convenient user unit like m, mm or motor revolutions by specifying the amount of encoder edges to include in a user unit.<br>Axis parameters like speed, acceleration, deceleration and the Axis commands are specified in these user units.<br>Note: The <b>UNITS</b> parameter can be any non-zero value, but it is recommended to design systems with an integer number of encoder pulses per user unit. Changing <b>UNITS</b> will affect all axis parameters which are dependent on <b>UNITS</b> in order to keep the same dynamics for the system. |
| Arguments   | N/A                                                                                                                                                                                                                                                                                                                                                                                                                                                                                                                                                                                                                                                                                   |
| Example     | A leads crew arrangement has a 5mm pitch and a 1,000-pulse/rev encoder. The units must be set to allow moves to be specified in mm. The 1,000 pulses/rev will generate $1,000 \times 4 = 4,000$ edges/rev. One rev is equal to 5mm. Therefore, there are $4,000/5 = 800$ edges/mm. <b>UNITS</b> is thus set as following.<br><pre>&gt;&gt; UNITS = 1000*4/5</pre>                                                                                                                                                                                                                                                                                                                     |
| See also    | <b>AXIS, ENCODER_RATIO.</b>                                                                                                                                                                                                                                                                                                                                                                                                                                                                                                                                                                                                                                                           |

## 4-2-251 UNLOCK

See **LOCK.**

## 4-2-252 UNTIL

See **REPEAT..UNTIL.**

**4-2-253 VERIFY**

|             |                                                                                                                                                                                                                                                                                                                                                                                                                                                                                                                                                                                                                                                                                                                                                                                                                                                                                                              |
|-------------|--------------------------------------------------------------------------------------------------------------------------------------------------------------------------------------------------------------------------------------------------------------------------------------------------------------------------------------------------------------------------------------------------------------------------------------------------------------------------------------------------------------------------------------------------------------------------------------------------------------------------------------------------------------------------------------------------------------------------------------------------------------------------------------------------------------------------------------------------------------------------------------------------------------|
| Type        | Axis parameter                                                                                                                                                                                                                                                                                                                                                                                                                                                                                                                                                                                                                                                                                                                                                                                                                                                                                               |
| Syntax      | <b>VERIFY</b>                                                                                                                                                                                                                                                                                                                                                                                                                                                                                                                                                                                                                                                                                                                                                                                                                                                                                                |
| Description | <p>The verify axis parameter is used to select different modes of operation on a stepper encoder axis.</p> <ul style="list-style-type: none"> <li>• <b>VERIFY=OFF</b><br/>Encoder count circuit is connected to the <b>STEP</b> and <b>DIRECTION</b> hardware signals so that these are counted as if they were encoder signals. This is particularly useful for registration as the registration circuit can therefore function on a stepper axis.</li> <li>• <b>VERIFY=ON</b><br/>Encoder circuit is connected to external A,B, Z signal</li> </ul> <p>Note: On the Flexible Axis, when <b>VERIFY=OFF</b>, the encoder counting circuit is configured to accept <b>STEP</b> and <b>DIRECTION</b> signals hard wired to the encoder A and B inputs. If <b>VERIFY=ON</b>, the encoder circuit is configured for the usual quadrature input.<br/>Make sure that the encoder inputs do not exceed 5 volts.</p> |
| Arguments   | N/A                                                                                                                                                                                                                                                                                                                                                                                                                                                                                                                                                                                                                                                                                                                                                                                                                                                                                                          |
| Example     | <b>VERIFY AXIS(3)=ON</b>                                                                                                                                                                                                                                                                                                                                                                                                                                                                                                                                                                                                                                                                                                                                                                                                                                                                                     |
| See also    | N/A                                                                                                                                                                                                                                                                                                                                                                                                                                                                                                                                                                                                                                                                                                                                                                                                                                                                                                          |

**4-2-254 VERSION**

|             |                                                                                                                             |
|-------------|-----------------------------------------------------------------------------------------------------------------------------|
| Type        | System parameter (read-only)                                                                                                |
| Syntax      | <b>VERSION</b>                                                                                                              |
| Description | The <b>VERSION</b> parameter returns the current firmware version number of the current system installed in the CJ1W-MCH72. |
| Arguments   | N/A                                                                                                                         |
| Example     | <b>&gt;&gt; PRINT VERSION<br/>1.6100</b>                                                                                    |
| See also    | N/A                                                                                                                         |

**4-2-255 VFF\_GAIN**

|             |                                                                                                                                                                                                                                                                                                                                                                                                                                                                                                                              |
|-------------|------------------------------------------------------------------------------------------------------------------------------------------------------------------------------------------------------------------------------------------------------------------------------------------------------------------------------------------------------------------------------------------------------------------------------------------------------------------------------------------------------------------------------|
| Type        | Axis parameter                                                                                                                                                                                                                                                                                                                                                                                                                                                                                                               |
| Syntax      | <b>VFF_GAIN</b>                                                                                                                                                                                                                                                                                                                                                                                                                                                                                                              |
| Description | <p>The <b>VFF_GAIN</b> parameter contains the speed feed forward gain. The speed feed forward output contribution is calculated by multiplying the change in demand position with the <b>VFF_GAIN</b> parameter value. The default value is 0.</p> <p>Adding speed feed forward gain to a system decreases the Following Error during a move by increasing the output proportionally with the speed.</p> <p>Note: In order to avoid any instability the servo gains should be changed only when the <b>SERVO</b> is off.</p> |
| Arguments   | N/A                                                                                                                                                                                                                                                                                                                                                                                                                                                                                                                          |

Example No example.  
 See also **D\_GAIN, I\_GAIN, OV\_GAIN, P\_GAIN.**

### 4-2-256 VP\_SPEED

Type Axis parameter (read-only)  
 Syntax **VP\_SPEED**  
 Description The **VP\_SPEED** parameter contains the speed profile speed in user units/s. The speed profile speed is an internal speed which is accelerated and decelerated as the movement is profiled.  
 Arguments N/A  
 Example **' Wait until at command speed  
 MOVE(100)  
 WAIT UNTIL SPEED = VP\_SPEED**  
 See also **AXIS, MSPEED, UNITS.**

### 4-2-257 VR

Type System command  
 Syntax **VR(address)**  
 Description The VR command reads or writes the value of a global (VR) variable. These VR variables hold real numbers and can be easily used as an element or as an array of elements. The CJ1W-MCH72 has in total 1024 VR variables.  
 The VR variables can be used for several purposes in BASIC programming. The VR variables are globally shared between tasks and can be used for communications between tasks. VR variable memory area is battery backed, so all VR variables retain their values between power ups  
 Notes:  
 • The TABLE and VR data can be accessed from all different running tasks. To avoid problems of two program tasks writing unexpectedly to one global variable, write the programs in such a way that only one program writes to the global variable at a time.  
 Arguments • **address**  
 The address of the VR variable. Range: [0,1023].  
 Example In the following example, the value 1.2555 is placed into VR variable 15. The local variable **val** is used to name the global variable locally:  
**val = 15  
 VR(val) = 1.2555**

Example A transfer gantry has 10 put down positions in a row. Each position may at any time be full or empty. VR(101) to VR(110) are used to hold an array of ten 1's and 0's to signal that the positions are full (1) or empty (0). The gantry puts the load down in the first free position. Part of the program to achieve this would be as follows:

**movep:**

```
MOVEABS(115) ' Move to first put down position
FOR VR(0) = 101 TO 110
 IF (VR(VR(0)) = 0) THEN GOSUB load
 MOVE(200) ' 200 is spacing between positions
NEXT VR(0)
PRINT "All positions are full"
WAIT UNTIL IN(3) = ON
GOTO movep
```

**load: ' Put load in position and mark array**

```
OP(15,OFF)
VR(VR(0)) = 1
RETURN
```

The variables are backed up by a battery so the program here could be designed to store the state of the machine when the power is off. It would of course be necessary to provide a means of resetting completely following manual intervention.

Example **loop: ' Assign VR(65) to VR(0) multiplied by axis 1 measured position**

```
VR(65) = VR(0)*MPOS AXIS(1)
PRINT VR(65)
GOTO loop
```

See also **CLEAR\_BIT, READ\_BIT, SET\_BIT, TABLE.**

## 4-2-258 VRSTRING

|             |                                                                                                                                                                                                                                    |
|-------------|------------------------------------------------------------------------------------------------------------------------------------------------------------------------------------------------------------------------------------|
| Type        | System command                                                                                                                                                                                                                     |
| Syntax      | <b>VRSTRING(vr_start)</b>                                                                                                                                                                                                          |
| Description | Combines the contents of an array of VR() variables so that they can be printed as a text string. All printable characters will be output and the string will terminate at the first null character found. (i.e. VR(n) contains 0) |
| Arguments   | <ul style="list-style-type: none"> <li>• <b>vr_start</b><br/>number of first VR() in the character array.</li> </ul>                                                                                                               |
| Example     | <b>PRINT #5,VRSTRING(100)</b>                                                                                                                                                                                                      |
| See also    | N/A                                                                                                                                                                                                                                |



**4-2-259 WA**

|             |                                                                                                                                                       |
|-------------|-------------------------------------------------------------------------------------------------------------------------------------------------------|
| Type        | System command                                                                                                                                        |
| Syntax      | <b>WA(time)</b>                                                                                                                                       |
| Description | The <b>WA</b> command pauses program execution for the number of milliseconds specified for time. The command can only be used in a program.          |
| Arguments   | <ul style="list-style-type: none"> <li>• <b>time</b><br/>The number of milliseconds to hold program execution.</li> </ul>                             |
| Example     | <p>The following lines would turn ON output 7 two seconds after turning off output 1.</p> <pre><b>OP(1,OFF)</b> <b>WA(2000)</b> <b>OP(7,ON)</b></pre> |
| See also    | N/A                                                                                                                                                   |

**4-2-260 WAIT IDLE**

|             |                                                                                                                                                                                                                                                                                                                                                                                                                                                                      |
|-------------|----------------------------------------------------------------------------------------------------------------------------------------------------------------------------------------------------------------------------------------------------------------------------------------------------------------------------------------------------------------------------------------------------------------------------------------------------------------------|
| Type        | System command                                                                                                                                                                                                                                                                                                                                                                                                                                                       |
| Syntax      | <b>WAIT IDLE</b>                                                                                                                                                                                                                                                                                                                                                                                                                                                     |
| Description | <p>The <b>WAIT IDLE</b> command suspends program execution until the base axis has finished executing its current move and any buffered move. The command can only be used in a program. <b>WAIT IDLE</b> works on the default basis axis (set with <b>BASE</b>) unless <b>AXIS</b> is used to specify a temporary base axis.</p> <p>Note: The execution of <b>WAIT IDLE</b> does not necessarily mean that the axis will be stationary in a servo motor system.</p> |
| Arguments   | N/A                                                                                                                                                                                                                                                                                                                                                                                                                                                                  |
| Example     | <pre><b>MOVE(1000)</b> <b>WAIT IDLE</b> <b>PRINT "Move Done"</b></pre> <p>The print statement is printed at the end of the movement.</p>                                                                                                                                                                                                                                                                                                                             |
| Example     | <pre><b>MOVE(1000)</b> <b>WAIT UNTIL MTYPE=0</b> <b>PRINT "Movement finished"</b></pre> <p>The print statement is printed, most of the times BEFORE the movement starts, and sometimes, when the movement is finished.</p>                                                                                                                                                                                                                                           |
| Explanation | Motion programs and motion sequence work in parallel and unsynchronized. One complete cycle can occur before the movement is loaded into the buffer. The program executes <b>MOVE(1000)</b> but the movement is not loaded to the buffer until the start of the next "motion sequence" so when you check <b>MTYPE=0</b> , it is <b>0</b> because the movement HAS NOT STARTED YET, not because it has finished.                                                      |
| See also    | <b>AXIS, WAIT LOADED.</b>                                                                                                                                                                                                                                                                                                                                                                                                                                            |

**Note** **WAIT IDLE** is a command specifically designed to wait until the previous movement has been finished so, it handles the delay from when the previous command is executed in the program until the command is correctly loaded in the motion buffer.

**4-2-261 WAIT LOADED**

|             |                                                                                                                                                                                                                                                                                                                                                                                                                                                                 |
|-------------|-----------------------------------------------------------------------------------------------------------------------------------------------------------------------------------------------------------------------------------------------------------------------------------------------------------------------------------------------------------------------------------------------------------------------------------------------------------------|
| Type        | System command                                                                                                                                                                                                                                                                                                                                                                                                                                                  |
| Syntax      | <b>WAIT LOADED</b>                                                                                                                                                                                                                                                                                                                                                                                                                                              |
| Description | The <b>WAIT LOADED</b> command suspends program execution until the base axis has no moves buffered ahead other than the currently executing move. The command can only be used in a program. This is useful for activating events at the beginning of a move, or at the end when multiple moves are buffered together. <b>WAIT LOADED</b> works on the default basis axis (set with <b>BASE</b> ) unless <b>AXIS</b> is used to specify a temporary base axis. |
| Arguments   | N/A                                                                                                                                                                                                                                                                                                                                                                                                                                                             |
| Example     | ' <b>Switch output 8 ON at start of MOVE(500) and OFF at end</b><br><b>MOVE(800)</b><br><b>MOVE(500)</b><br><b>WAIT LOADED</b><br><b>OP(8,ON)</b><br><b>MOVE(400)</b><br><b>WAIT LOADED</b><br><b>OP(8,OFF)</b>                                                                                                                                                                                                                                                 |
| See also    | <b>AXIS, WAIT IDLE</b>                                                                                                                                                                                                                                                                                                                                                                                                                                          |

**4-2-262 WAIT UNTIL**

|             |                                                                                                                                                                                                                                                                               |
|-------------|-------------------------------------------------------------------------------------------------------------------------------------------------------------------------------------------------------------------------------------------------------------------------------|
| Type        | System command                                                                                                                                                                                                                                                                |
| Syntax      | <b>WAIT UNTIL condition</b>                                                                                                                                                                                                                                                   |
| Description | The <b>WAIT UNTIL</b> command repeatedly evaluates the condition until it is <b>TRUE</b> . After this program execution will continue. The command can only be used in a program.                                                                                             |
| Arguments   | • <b>condition</b><br>Any valid BASIC logical expression.                                                                                                                                                                                                                     |
| Example     | In this example, the program waits until the measured position on axis 0 exceeds 150, and then starts a movement on axis 1.<br><b>WAIT UNTIL MPOS AXIS(0)&gt;150</b><br><b>MOVE(100) AXIS(1)</b>                                                                              |
| Example     | The expressions evaluated can be as complex as you like provided they follow BASIC syntax, for example:<br><b>WAIT UNTIL DPOS AXIS(2) &lt;= 0 OR IN(1) = ON</b><br>The above line would wait until the demand position of axis 2 is less than or equal to 0 or input 1 is on. |
| See also    | N/A                                                                                                                                                                                                                                                                           |

**4-2-263 WDOG**

|             |                                                                                                                                                                                                                                                                                                                                                                                                                                                                                                                                                                                                                                                                                                                                                                                                                                                                                                                                                                                                                                                                                            |
|-------------|--------------------------------------------------------------------------------------------------------------------------------------------------------------------------------------------------------------------------------------------------------------------------------------------------------------------------------------------------------------------------------------------------------------------------------------------------------------------------------------------------------------------------------------------------------------------------------------------------------------------------------------------------------------------------------------------------------------------------------------------------------------------------------------------------------------------------------------------------------------------------------------------------------------------------------------------------------------------------------------------------------------------------------------------------------------------------------------------|
| Type        | System parameter                                                                                                                                                                                                                                                                                                                                                                                                                                                                                                                                                                                                                                                                                                                                                                                                                                                                                                                                                                                                                                                                           |
| Syntax      | <b>WDOG</b>                                                                                                                                                                                                                                                                                                                                                                                                                                                                                                                                                                                                                                                                                                                                                                                                                                                                                                                                                                                                                                                                                |
| Description | <p>The <b>WDOG</b> parameter contains the software switch which enables the Servo Driver using the <b>RUN</b> (Servo on) input signal. The enabled Servo Driver will control the servo motor depending on the speed and torque reference values. <b>WDOG</b> can be turned on and off under program control, on Command Line Terminal.</p> <p>The <b>WDOG</b> is also controlled by the PLC CPU. The <b>WDOG</b> can only be switched on when the Enable Watchdog bit (control word <i>n</i>, bit 1) is set.</p> <p>The Servo Driver will automatically be disabled when a <b>MOTION_ERROR</b> occurs. A motion error occurs when the <b>AXISSTATUS</b> state for one of the axes matches the <b>ERRORMASK</b> setting. In this case the software switch (<b>WDOG</b>) will be turned off, the <b>MOTION_ERROR</b> parameter will have value different than 0 and the <b>ERROR_AXIS</b> parameter will contain the number of the first axis to have the error.</p> <p>Also when the Enable Watchdog bit (control word <i>n</i>, bit 1) is reset, the <b>WDOG</b> will be switched off.</p> |
| Arguments   | N/A                                                                                                                                                                                                                                                                                                                                                                                                                                                                                                                                                                                                                                                                                                                                                                                                                                                                                                                                                                                                                                                                                        |
| Example     | No example.                                                                                                                                                                                                                                                                                                                                                                                                                                                                                                                                                                                                                                                                                                                                                                                                                                                                                                                                                                                                                                                                                |
| See also    | <b>AXISSTATUS, ERROR_AXIS, ERRORMASK, MOTION_ERROR, SERVO.</b>                                                                                                                                                                                                                                                                                                                                                                                                                                                                                                                                                                                                                                                                                                                                                                                                                                                                                                                                                                                                                             |

**4-2-264 WHILE..WEND**

|             |                                                                                                                                                                                                                                                                                                                                               |
|-------------|-----------------------------------------------------------------------------------------------------------------------------------------------------------------------------------------------------------------------------------------------------------------------------------------------------------------------------------------------|
| Type        | Program control command                                                                                                                                                                                                                                                                                                                       |
| Syntax      | <b>WHILE condition<br/>commands<br/>WEND</b>                                                                                                                                                                                                                                                                                                  |
| Description | <p>The <b>WHILE ... WEND</b> structure allows the program segment between the <b>WHILE</b> and the <b>WEND</b> statement to be repeated a number of times until the condition becomes <b>FALSE</b>. In that case program execution will continue after <b>WEND</b>.</p> <p>Note: <b>WHILE ... WEND</b> loops can be nested without limit.</p> |
| Arguments   | <ul style="list-style-type: none"> <li><b>condition</b><br/>Any valid logical BASIC expression.</li> </ul>                                                                                                                                                                                                                                    |
| Example     | <pre><b>WHILE IN(12) = OFF MOVE(200) WAIT IDLE OP(10,OFF) MOVE(-200) WAIT IDLE OP(10,ON) WEND</b></pre>                                                                                                                                                                                                                                       |
| See also    | <b>FOR..TO..STEP..NEXT, REPEAT..UNTIL</b>                                                                                                                                                                                                                                                                                                     |

**4-2-265 XOR**

Type           Mathematical operation

Syntax         **expression1 XOR expression2**

Description    The **XOR** (eXclusive OR) operator performs the logical **XOR** function between corresponding bits of the integer parts of two valid BASIC expressions.  
The logical **XOR** function between two bits is defined as in the table below.

| Bit 1 | Bit 2 | Result |
|-------|-------|--------|
| 0     | 0     | 0      |
| 0     | 1     | 1      |
| 1     | 0     | 1      |
| 1     | 1     | 0      |

Arguments    • **expression1**  
                  Any valid BASIC expression.  
                  • **expression2**  
                  Any valid BASIC expression.

Example       **VR(0)=10 XOR 18**  
The **XOR** is a bit operator and so the binary action taking place is as follows: **01010 XOR 10010 = 11000**. The result is therefore 24.

See also      N/A



---

---

## **SECTION 5**

### **Examples**

This chapter gives 2 categories of examples and tips:

- How-to's.
- Practical examples.

## 5-1 How-to's

### 5-1-1 Startup program

The purpose of this program is to compare the detected MECHATROLINK-II configuration with the expected one (the expected configuration is the configuration existing in the moment you create the program).

The STARTUP program does these actions:

- Checks the number of nodes in the system.
- Checks that the node numbers agrees.
- Checks if all slaves are connected and have power.
- Any non agreement, the program stops.
- Sets the correct **ATYPE** as selected in the intelligent axis window.
- Sets the mode, **Run** or **Commisioning**.

#### 5-1-1-1 How to set a startup program

When you add a new CJ1W-MCH72 device to the solution in Trajexia Studio, 2 programs are created by default: the SHELL program, and an application program called APPLICATION.



Default programs SHELL and APPLICATION

A CJ1W-MCH72 device can execute a program at startup: when the device is switched on, it executes the program.

You can set the startup priority for a program in Trajexia Studio with the **Priority** property in the **Properties** window. If you click the ellipsis button in the edit field of this property, the **StartUp Priority** window shows.

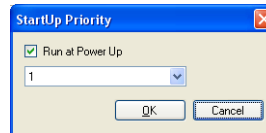

StartUp Priority window

To set the program to run at power up, select the **Run at Power Up** check box and select a priority in the list. Possible priority values are **Default** or 1 (lowest priority) to 14 (highest priority).

To set the program not to run at startup, clear the **Run at Power Up** check box.

**Note** The SHELL program by default runs at startup at priority 1.

**Note** OMRON recommends that the statement **RUN "your\_program"** is used at the end of the Startup program to start your application program. The application program starts when the startup program is executed successfully and without errors. If you set an application program to "Run at startup" there is a risk that the machine starts if there is an error on the MECHATROLINK-II bus.

## 5-1-1-2 Example

```

'=====
'THE FIRST PART OF THE PROGRAM
'CONSISTS OF A CHECK SEQUENCE TO
'VERIFY THAT THE DETECTED AXIS CONFIGURATION IS THE
'EXPECTED ONE.
'IF YES, THE PROGRAM FINISHES AND STARTS "APPLICATION".
'IF NOT, THE PROGRAM STOPS AND NO OTHER PROGRAM STARTS.
'THIS PROGRAM MUST BE SET TO RUN AT POWER UP IN 'A LOW
'PRIORITY TASK (1 IN THIS EXAMPLE)
'=====
'Start MECHATROLINK Section
' Check detected slaves
' Unit 0
IF NOT MECHATROLINK(0,3,0) THEN
 PRINT "Error getting slave count for unit 0"
 STOP
ELSE
 IF VR(0) <> 3 THEN
 PRINT "Incorrect slave count for unit 0"
 STOP
 ENDIF
ENDIF
IF NOT MECHATROLINK(0,4,0,0) THEN
 PRINT "Error getting address for unit 0, station 0"
 STOP
ELSE
 IF VR(0) <> 65 THEN
 PRINT "Incorrect address for unit 0, station 0"
 STOP
 ENDIF
ENDIF
IF NOT MECHATROLINK(0,4,1,0) THEN
 PRINT "Error getting address for unit 0, station 1"
 STOP
ELSE
 IF VR(0) <> 66 THEN
 PRINT "Incorrect address for unit 0, station 1"
 STOP
 ENDIF
ENDIF
IF NOT MECHATROLINK(0,4,2,0) THEN
 PRINT "Error getting address for unit 0, station 2"
 STOP
ELSE
 IF VR(0) <> 67 THEN
 PRINT "Incorrect address for unit 0, station 2"
 STOP
 ENDIF
ENDIF
' Set axis types
' Unit 0
ATYPE AXIS(0)=40
ATYPE AXIS(1)=40
ATYPE AXIS(2)=40
' Set drives into run mode

```



```
' Unit 0
MECHATROLINK(0,20,65)
MECHATROLINK(0,20,66)
MECHATROLINK(0,20,67)
'Stop MECHATROLINK Section
'=====
'THIS SECTION MUST BE MANUALLY SET BY THE USER
'ACCORDING TO THE APPLICATION. TYPICAL ACTIONS ARE
'VARIABLE INITIALIZATION, SERVO/AXIS SETTING, NAMING
'GLOBAL VARIABLES AND START THE "APPLICATION" PROGRAM.
'=====
'Define Names for global variables
GLOBAL "project_status",100
GLOBAL "alarm_status",101
GLOBAL "action",102
'Initialize variables
VR(0)=0
project_status=0
alarm_status=0
action=0
'Start APPLICATION program
RUN "APPLICATION",2
STOP
```

### 5-1-2 Gain settings

The gain setting is related to the mechanical system to which the motor is attached. There are three main concepts:

- Inertia ratio
- Rigidity
- Resonant frequency.

These concepts are described in section 1-10.

This section shows example parameter values for:

- Speed Loop Gain
- Proportional position gain
- Velocity Feed Forward gain.

The example values for the program and motion parameters in the Trajexia system are given below. Note that they are appropriate for 13-bit encoders and Sigma-II Servo Drivers.

| Drive Parameter value | Description            |
|-----------------------|------------------------|
| Pn103 = 716           | Inertia ratio          |
| Pn110 = 0012          | No autotuning          |
| Pn202=1               | Gear ratio numerator   |
| Pn203=1               | Gear ratio denominator |

| Motion Parameter values | Description               |
|-------------------------|---------------------------|
| UNITS =1                | Working in encoder counts |
| SPEED=200000            | Speed setting             |
| ACCEL=1000000           | Acceleration setting      |

| Motion Parameter values | Description          |
|-------------------------|----------------------|
| DECEL=1000000           | Deceleration setting |
| MOVEMENT=81920          | 10 Turns             |

5-1-2-1 Speed mode examples

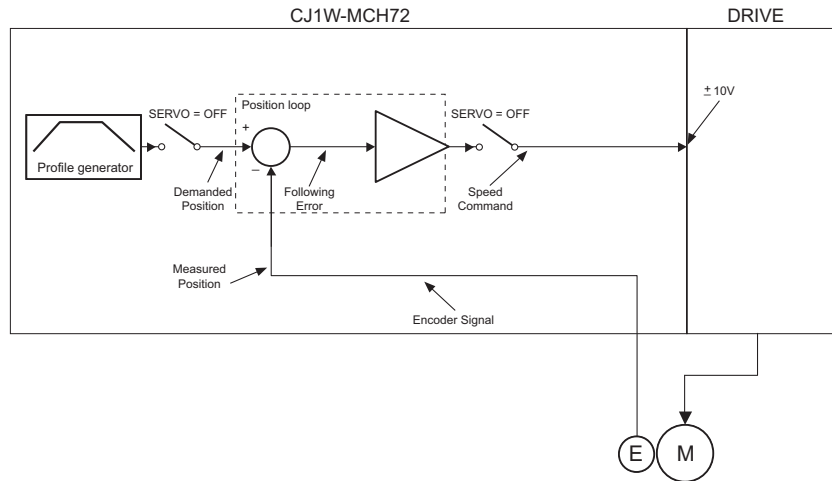

In this mode the position loop is closed in Trajexia and the Speed loop is closed in the Servo Driver. The **Speed** axis parameter is sent to the Servo Driver, and reads the position feedback.

```

BASE (0)
ATYPE=44 'Servo axis encoder mode
SERVO=1
WDOG=1
DEFPOS (0)
loop:
 MOVE (81920)
 WAIT IDLE
 WA (100)
 DEFPOS (0)
GOTO loop

```

Example 1

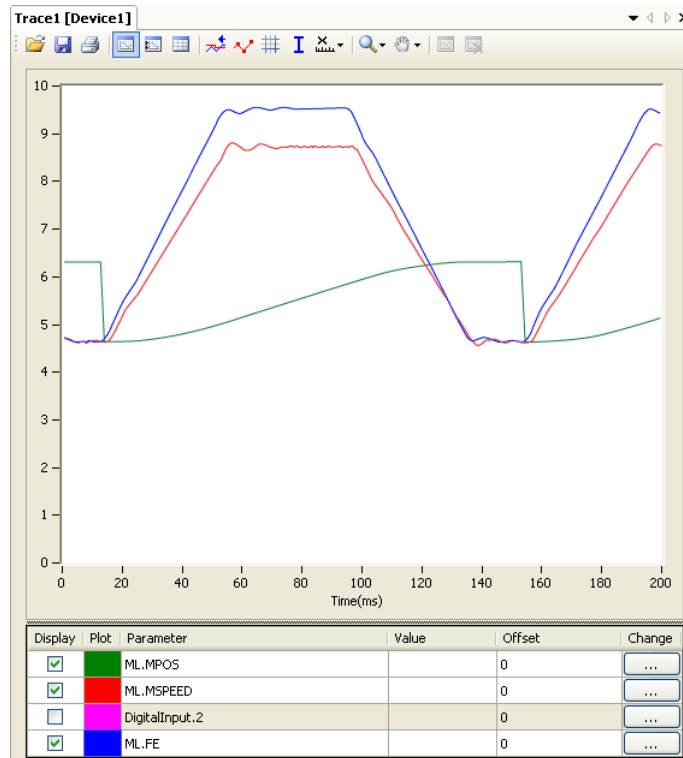

Only proportional gain has a set value, the Following Error is proportional to the speed.

The parameter values for the example are:

| Motion Parameter values |
|-------------------------|
| <b>P_Gain=131072</b>    |
| <b>VFF_GAIN=0</b>       |
| <b>Fn001=4</b>          |

**Note** The colours and scale of the oscilloscope for speed mode are as follows:  
 Red: MSPEED (Measured Axis speed). Units is 50 units/ms/division  
 Blue: FE (Following Error). Units is depending on the graph  
 Green: MPOS (Measured Axis position). 50000 units/division

Example 2

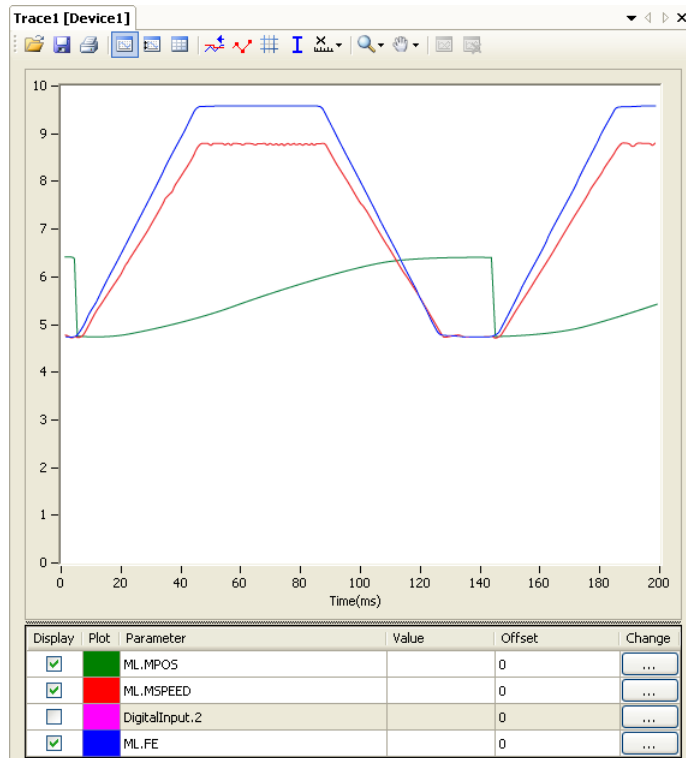

The value for rigidity is increased. The error magnitude remains the same but the ripple, the speed stability and overshoot are better.  
 The parameter values for the example are:

| Motion Parameter values |
|-------------------------|
| P_Gain=131072           |
| VFF_GAIN=0              |
| Fn001=6                 |

Example 3

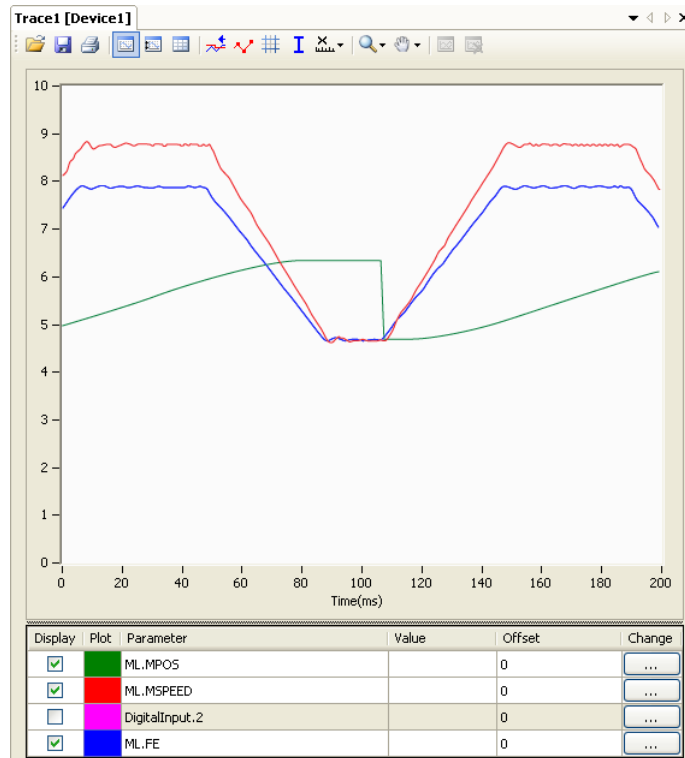

The parameter **P\_GAIN** is increased further. The Following Error decreases proportionally.

The parameter values for the example are:

| Motion Parameter values |
|-------------------------|
| <b>P_Gain=200000</b>    |
| <b>VFF_GAIN=0</b>       |
| <b>Fn001=6</b>          |

Example 4

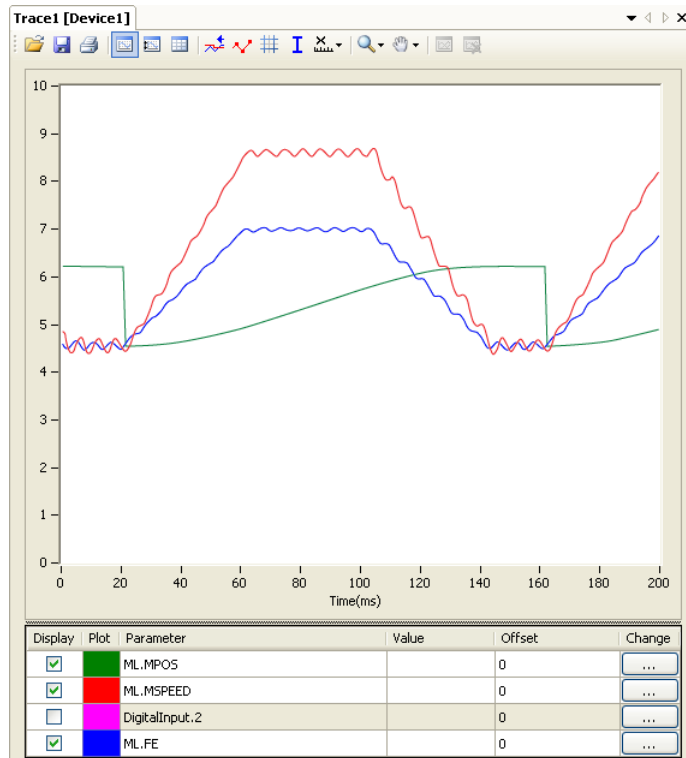

The value of the parameter **P\_GAIN** two times the value in example 1. The Following Error is half, but there is vibration due to the excessive gains. The parameter values for the example are:

| Motion Parameter values |
|-------------------------|
| <b>P_Gain=262144</b>    |
| <b>VFF_GAIN=0</b>       |
| <b>Fn001=6</b>          |

Example 5

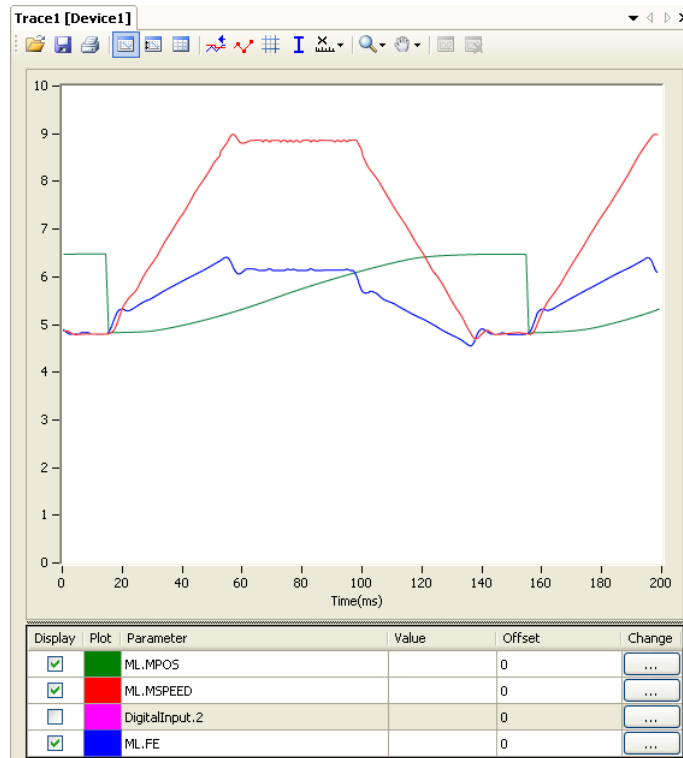

The value of the parameter **P\_GAIN** is set to the value in example 1. The value of **VFF\_GAIN** is increased. The Following Error is reduced without a reduction to the stability. The Following Error is not proportional to the speed. The parameter values for the example are:

| Motion Parameter values |
|-------------------------|
| <b>P_Gain=131072</b>    |
| <b>VFF_GAIN=1400000</b> |
| <b>Fn001=6</b>          |

Example 6

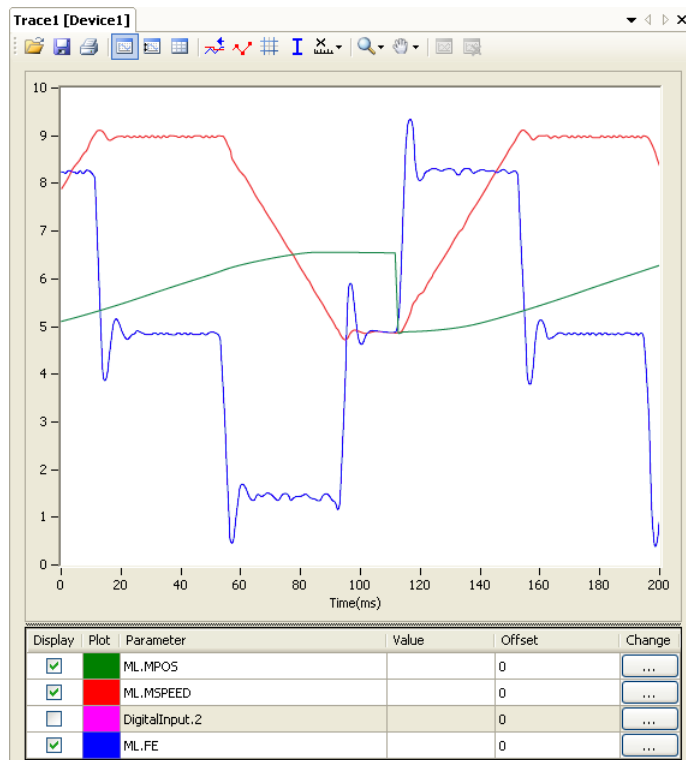

With this value of VFF\_GAIN the Following Error is proportional to the acceleration, and smaller than with just proportional gain (the scaling is 20 units/division). The Following Error approaches zero during constant speed. The negative effect of this set of values is the overshoot and undershoot when the acceleration changes; this can be reduced but not eliminated by increasing the speed loop gain, if the mechanical system can cope with a high gain. The parameter values for the example are:

| Motion Parameter values |
|-------------------------|
| P_Gain=131072           |
| VFF_GAIN=1573500        |
| Fn001=6                 |



Example 7

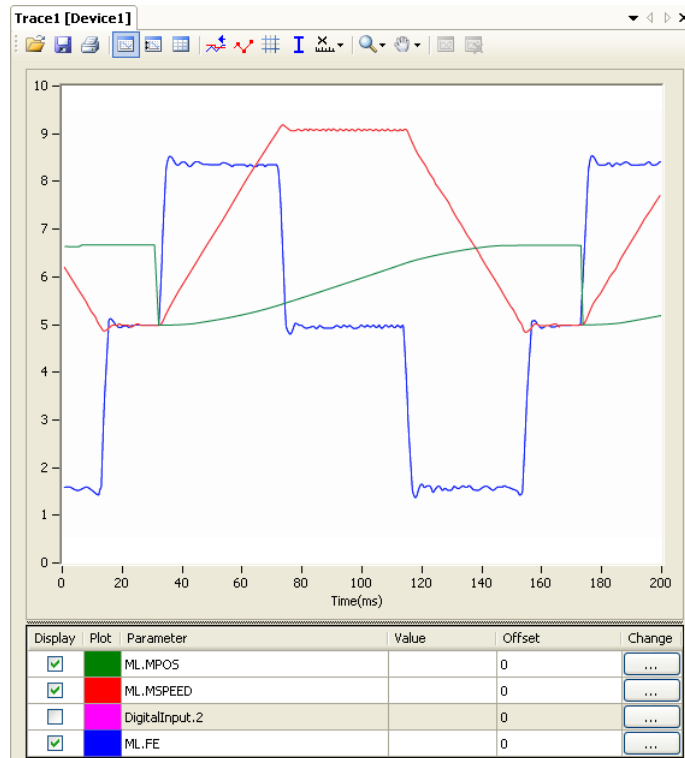

The value of the rigidity is increased from 6 to 8. The overshoot/undershoot is smaller but the motor has more vibration.  
 The parameter values for the example are:

| Motion Parameter values |
|-------------------------|
| P_Gain=131072           |
| VFF_GAIN=1573500        |
| Fn001=8                 |

Example 8

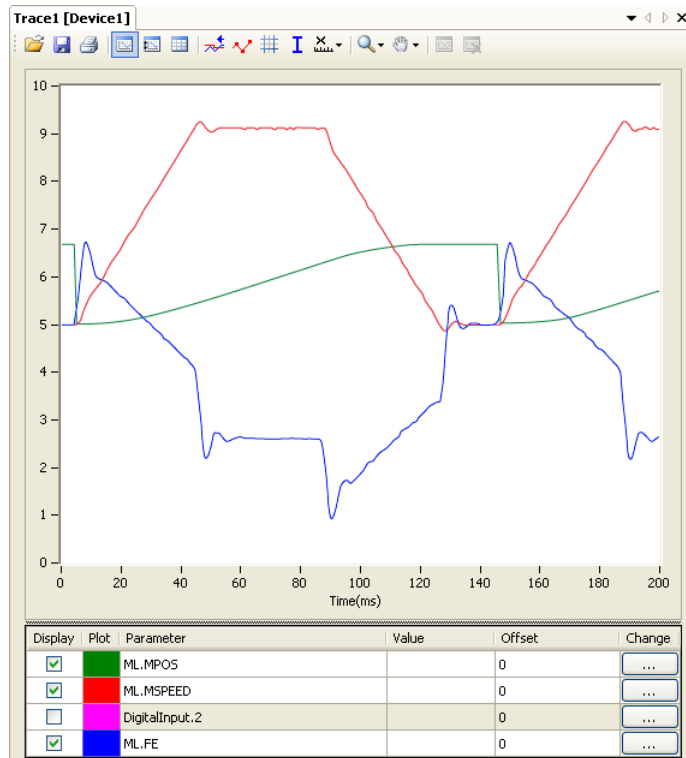

Opposite to the P\_GAIN, where the higher, the better (the limit is when the mechanical system starts vibrating), for the VFF\_GAIN there is an optimum value (the one in test 6), values higher than this value has an error proportional to the speed/acceleration but with different sign. The required correction is too large.

The parameter values for the example are:

| Motion Parameter values |
|-------------------------|
| P_Gain=131072           |
| VFF_GAIN=1650000        |
| Fn001=6                 |

5-1-2-2 Position mode examples

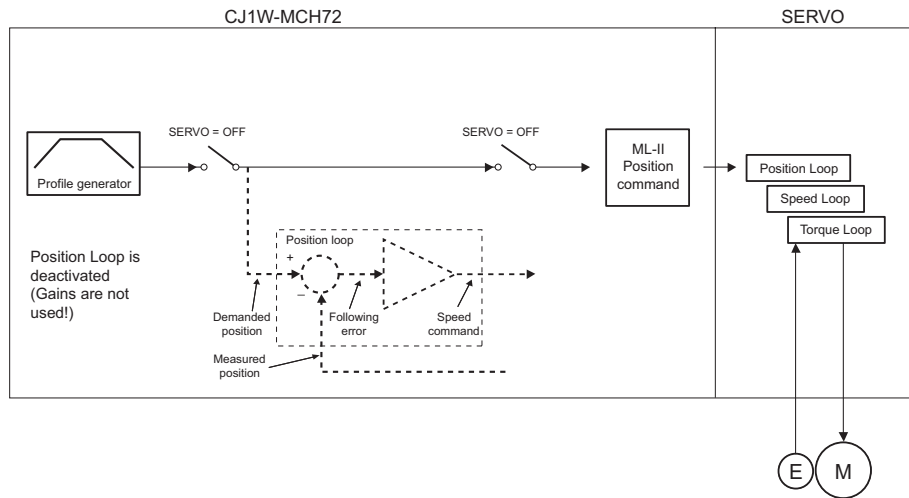

In this mode the position and speed loop are closed in the Servo Driver. The CJ1W-MCH72 sends the position command through the MECHATROLINK-II network to the Servo Driver, and reads the position feedback.

Note that this system has no sample delay as compared to the position loop in the Servo Driver, the Demanded Position in cycle "n" with the Measured Position in cycle "n".

The CJ1W-MCH72, for the internal handling, continues to use its own position loop, so the Following Error that read in the Axis parameter in the CJ1W-MCH72 is not the real one in the Servo Driver. To read the correct Following Error use DRIVE\_MONITOR.

Adjust the rigidity of the servo, the speed loop gain and the position loop gain at the same time using just proportional position gain. The results are similar to the MECHATROLINK-II Speed mode with the advantages:

- The tuning is more simple, only the rigidity (Fn001) and, if necessary, the feedforward gain (Pn109) needs to be set.
- The position loop in the servo is faster (250µs) than in the CJ1W-MCH72 and it is turned together with the speed loop.
- There is no sample time delay between "Target position" and "Measured position".

To do a finetune the different gain parameters can be changed individually.

```

BASE (0)
ATYPE=41 'MECHATROLINK Position mode
SERVO=1
DRIVE_CONTROL=2 'To monitor the Following Error in
 'DRIVE_MONITOR

WDOG=1
DEFPOS (0)
loop:
 MOVE (81920)
 WAIT IDLE
 WA (100)
 DEFPOS (0)
GOTO loop

```

Example 1

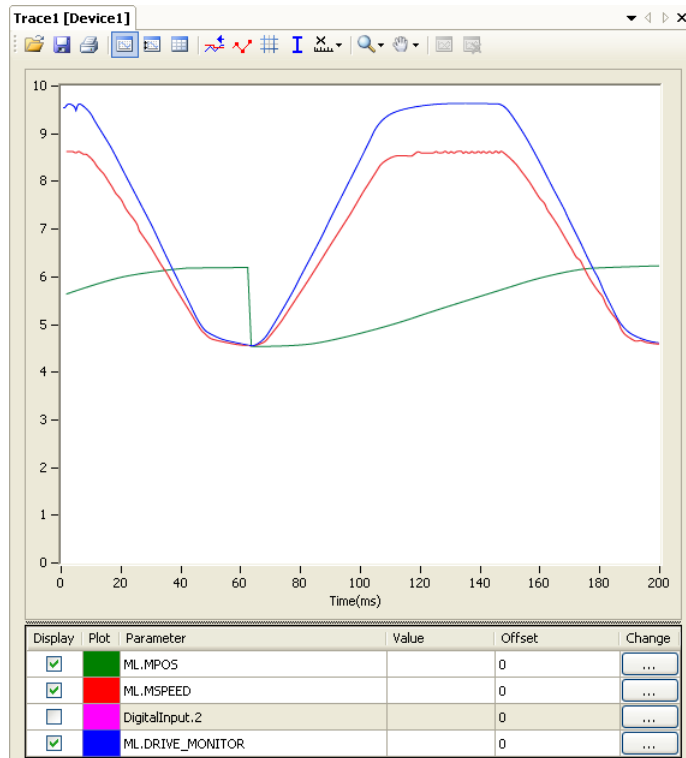

The Following Error is proportional to the speed. There is a "soft profile" due to the low rigidity setting (low gain).

**Note**

The colours and scale of the oscilloscope for position mode are as follows:  
 Red: MSPEED (Measured Axis speed). Units is 50 units/ms/division  
 Blue: DRIVE\_MONITOR (set as Following Error in the Servo Driver). Units is depending on the graph  
 Green: MPOS (Measured Axis position). 50000 units/division

The parameter values for the example are:

|                                |
|--------------------------------|
| <b>Motion Parameter values</b> |
| <b>Fn001=4</b>                 |
| <b>Pn109=0</b>                 |

Example 2

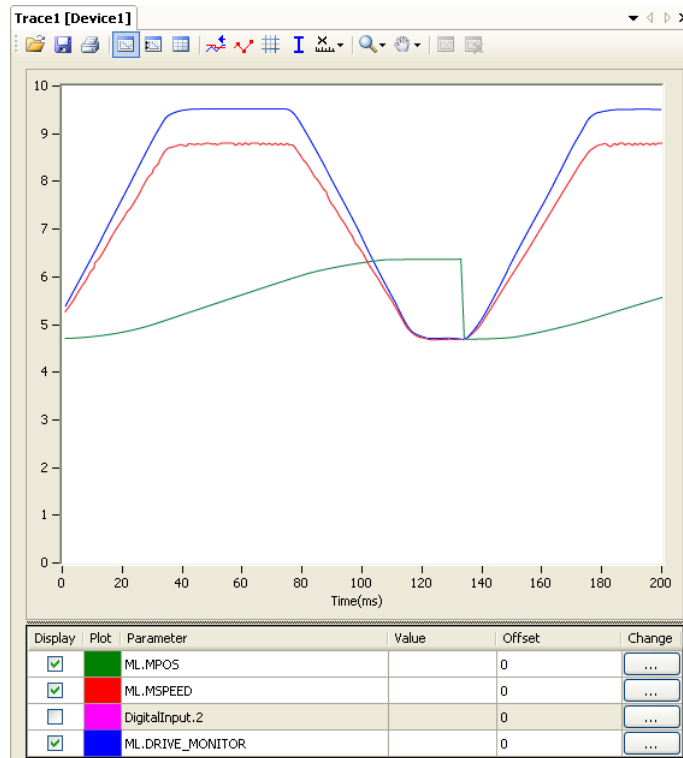

The Following Error reduces as the rigidity increases.  
 The parameter values for the example are:

| Motion Parameter values |
|-------------------------|
| <b>Fn001=6</b>          |
| <b>Pn109=0</b>          |

Example 3

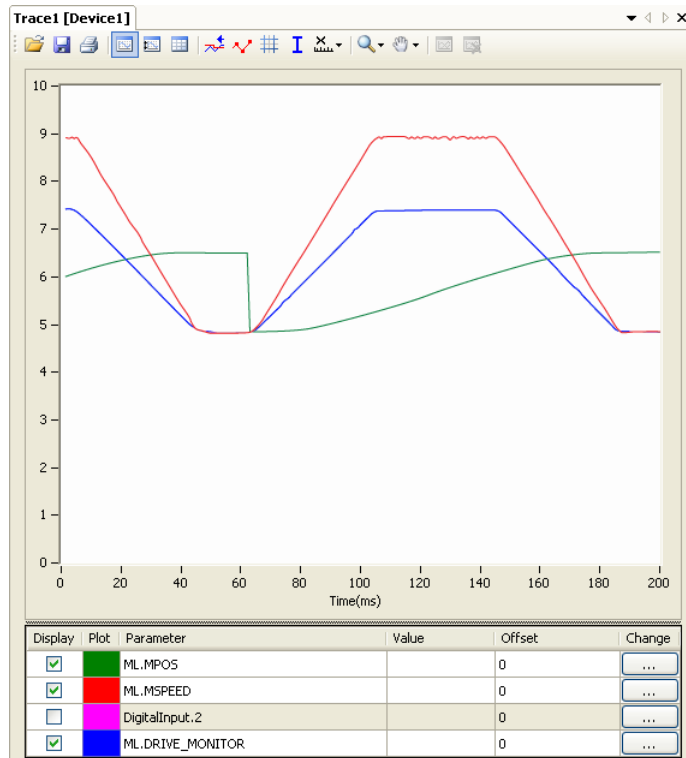

With high gain the motor starts to vibrate but the profile is more stable than in MECHATROLINK-II Speed mode.

The parameter values for the example are:

| Motion Parameter values |
|-------------------------|
| <b>Fn001=8</b>          |
| <b>Pn109=0</b>          |

Example 4

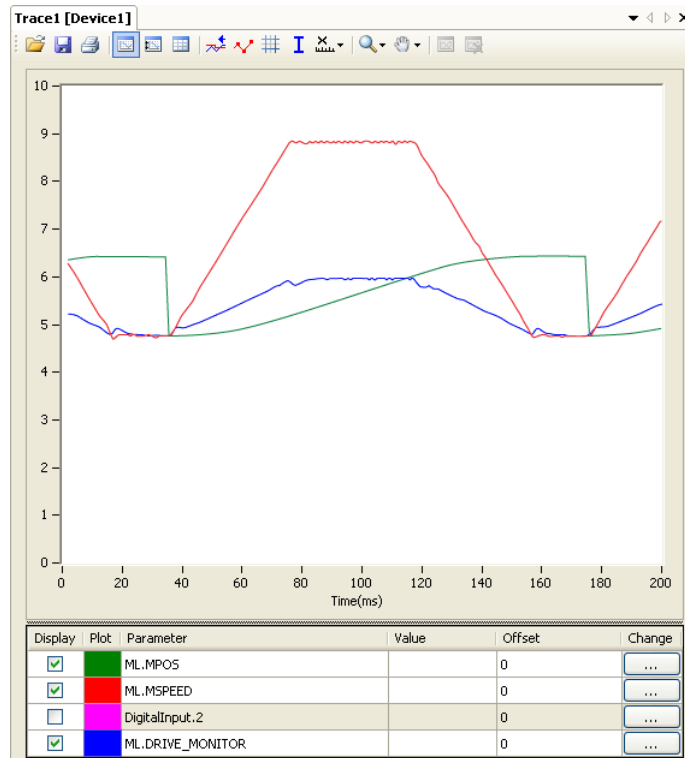

The effect of the Feedforward gain is that the Following Error is reduced and the effect is proportional to the acceleration.  
 The parameter values for the example are:

| Motion Parameter values |
|-------------------------|
| <b>Fn001=6</b>          |
| <b>Pn109=95</b>         |

Example 5

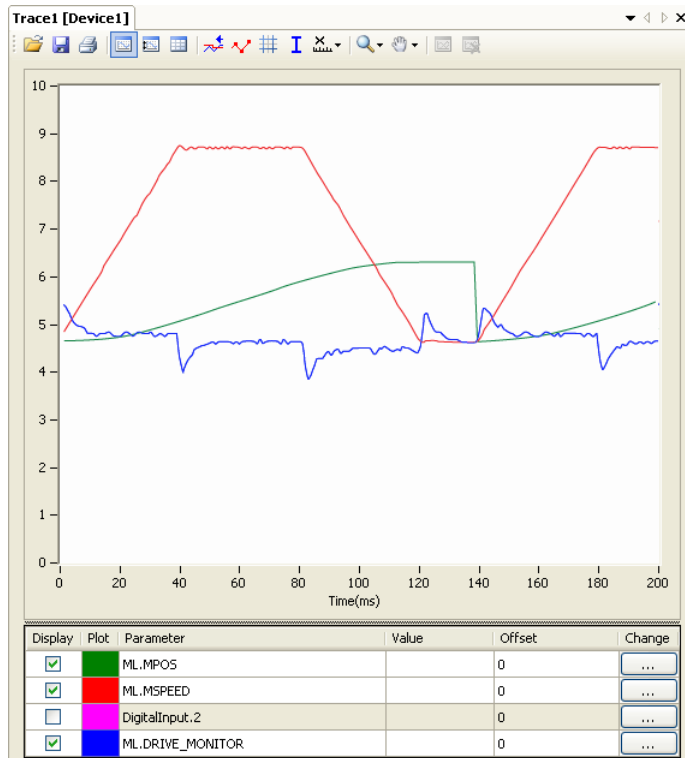

With the feedforward set to 100%, the Following Error is very small and proportional to the acceleration. The optimum value of 100% correction is the maximum value that can be set. The parameter value of Pn109 is easier to set than the parameter value of VFF\_GAIN.  
 The parameter values for the example are:

|                                |
|--------------------------------|
| <b>Motion Parameter values</b> |
| <b>Fn001=6</b>                 |
| <b>Pn109=100</b>               |

5-1-3 Setting the UNITS axis parameter and gear ratio

In controlling the mechanical axis with the CJ1W-MCH72, a Servo Driver and a servo motor, the only measurement units that the hardware understands are encoder counts. All commands to the driver to move an axis are expressed in encoder counts. All feedback information about axis positions is also expressed in encoder counts. When writing programs in BASIC to achieve movements or a sequence of movements, a user can prefer to work with user defined units, such as millimeter, centimeter, meter, degree of angle, "product", "rotation", "stations". The **UNITS** axis parameter contains the conversion factor between encoder counts and user defined units. All axis parameters related to motion and arguments of axis commands that determine the amount of motion are expressed in these user units. This parameter enables the user to define the most convenient units to work with. For example, for a moving part that makes a linear motion, you can prefer mm, or fraction of mm. For a moving part that makes a rotation motion, you can prefer a degree of angle or its fraction. For more information on the **UNITS** axis parameter, see section 4-2-250.



However, the user must be aware that not only the **UNITS** axis parameter matters in the conversion between encoder counts and user defined units. Certain Servo Driver parameters and some characteristics of the mechanical system are also important. The following sections describe which Servo Driver parameters are important for this conversion. We also give examples of how to set those parameters and the **UNITS** axis parameter, taking the characteristics of the mechanical system into account.

**5-1-3-1 Conversion between encoder counts and user defined units**

Two very important parameters of the Servo Drivers for conversion of encoder counts into user units are the electronic gear ratio numerator and the electronic gear ratio denominator. The table below gives these parameters for the Servo Drivers.

| Servo Driver | Numerator | Denominator |
|--------------|-----------|-------------|
| Sigma-II     | Pn202     | Pn203       |
| Sigma-V      | Pn20E     | Pn210       |
| Junma        | Pn20E     | Pn210       |
| G-series     | Pn205     | Pn206       |

**Note** The remainder of this section uses the parameters of the Sigma-II Servo Driver, that is, Pn202 and Pn203. If you use a Sigma-V, a Junma or G-series Servo Driver, you must use the corresponding parameters.

If a servo motor with an absolute encoder is used, setting parameter Pn205 (Multiturn limit) is also necessary.

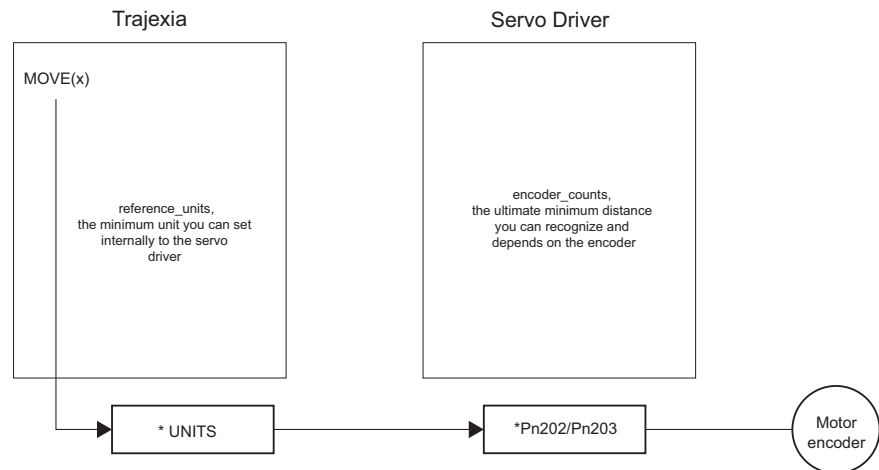

Parameter Pn202 is the electronic gear ratio denominator (G1). Parameter Pn203 is the electronic gear ratio numerator (G2). The servo motor rotates using the value of the position command signal sent by the CJ1W-MCH72, multiplied by the electronic gear (Pn202, Pn203). On the output (servo motor) side, the signal is expressed in number of encoder pulses. For more information on Servo Driver parameters Pn202 and Pn203, see the Sigma-II Servo Driver manual.

The UNITS axis parameter effectively expresses the ratio between user units that the user wants to use in the program and the position sent to the Servo Driver via the MECHATROLINK-II bus. Taking the electronic gear setting into account, the equation expressing the relation between user units, the **UNITS** parameter, parameters Pn202 and Pn203, encoder pulses and mechanical measurement units is:

$$\frac{Pn202}{Pn203} \cdot UNITS = \frac{y \cdot \text{encoder\_counts}}{x \cdot \text{user\_units}}$$

where y is the number of encoder counts and x is the amount in user units.

5-1-3-2 Example 1

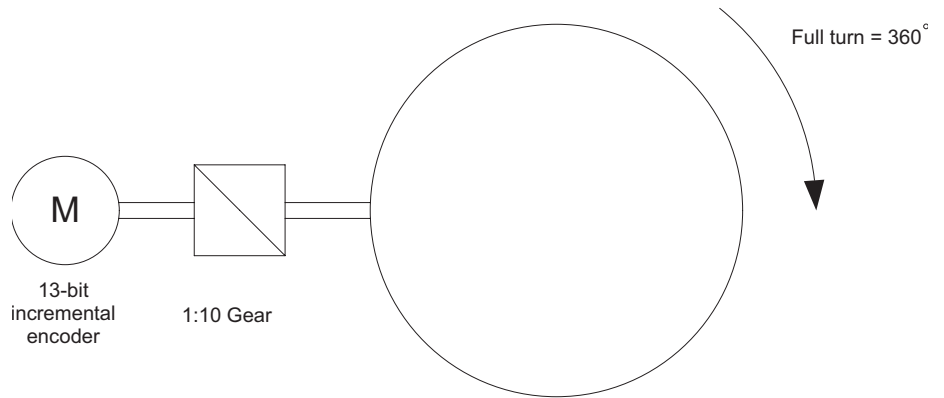

The mechanical system consists of a simple rotary table. A servo motor with 13-bit incremental encoder is used. The gear ratio of the gearbox is 1:10. The desired user units are degree of angle. This system can be described with the following equations:

$$1 \cdot \text{motor\_revolution} = 2^{13} \cdot \text{encoder\_counts}$$

$$10 \cdot \text{motor\_revolution} = 1 \cdot \text{machine\_cycle}$$

$$1 \cdot \text{machine\_cycle} = 360^\circ$$

The combination of these equations results in:

$$\frac{Pn202}{Pn203} \cdot UNITS = \frac{2^{13} \cdot \text{encoder\_counts}}{1 \cdot \text{motor\_revolution}} \cdot \frac{10 \cdot \text{motor\_revolution}}{1 \cdot \text{machine\_revolution}} \cdot \frac{1 \cdot \text{machine\_revolution}}{360^\circ} = \frac{2^{13} \cdot 10 \text{ encoder\_counts}}{360 \text{ degree}}$$

And therefore:

$$\frac{Pn202}{Pn203} \cdot UNITS = \frac{2^{13} \cdot 10}{360}$$

From this equation, we can derive the values for Pn202, Pn203 and **UNITS**, given the following restrictions and recommendations:

- 1 Pn202 and Pn203 are integers.
- 2 UNITS must not have an infinite number of decimal digits. This can create rounding errors that result in small position errors that add up to large accumulative position errors.
- 3 For reasons of stability, it is necessary to avoid situations where Pn202/Pn203 is less than 0.01 or greater than 100. It is recommended that Pn202/Pn203 is approximately 1.

We can now rewrite the last equation to:

$$\text{UNITS} \cdot \frac{\text{Pn202}}{\text{Pn203}} = 2^{13} \frac{10}{360}$$

One solution to this equation is:

$$\begin{aligned} \text{UNITS} &= 2^{13} = 8192 \\ \text{Pn202} &= 10 \\ \text{Pn203} &= 360 \end{aligned}$$

When we consider the third recommendation from the above list (avoid situations where Pn202/Pn203 is less than 0.01 or greater than 100), we can rewrite the last equation to:

$$\text{UNITS} \cdot \frac{\text{Pn202}}{\text{Pn203}} = 2^{13} \frac{10}{360} = 2^8 \frac{2^5}{36} = 2^8 \frac{32}{36}$$

This gives us the solution:

$$\begin{aligned} \text{UNITS} &= 2^8 = 256 \\ \text{Pn202} &= 32 \\ \text{Pn203} &= 36 \end{aligned}$$

With these values, the command **MOVE(28)** rotates the table 28 degrees in positive direction.

### 5-1-3-3 Absolute encoder setting

The absolute encoder keeps the current motor position, even if there is no power supplied. The absolute encoder gives the position within one turn (that is, a fraction from 0 to and excluding 1), and it has a multiturn counter. You can set the multiturn behaviour of the absolute encoder with the parameter Pn205 of the Sigma-II Servo Driver. This parameter adjusts the maximum number of turns that the counter counts before it has an overflow. For more information on Servo Driver parameter Pn205, see the Sigma-II Servo Driver manual. Taking this parameter value into account, the maximum position value the encoder can signal is:

$$\text{max\_encoder\_count\_value} = (\text{Pn205} + 1) \cdot \text{encoder\_counts} - 1$$

which makes it Pn205 complete turns, plus the position within one turn (the fraction from 0 to and excluding 1). When the MECHATROLINK-II connection is established with the drive, the absolute encoder position is read from the drive and the value is written in **MPOS** (after the conversion: **UNITS** × Pn202/Pn203). When the mechanical system has a limited travel distance to move, like in a ball screw, the value of the parameter Pn205 should be set large enough to have an overflow of the counter out of the effective position. This is

called limited axis or finite axis. A typical example of a limited axis is a ball screw, as shown in . When the mechanical system always moves in the same direction, it reaches the overflow of the multiturn counter. In this case, the value of Pn205 must guarantee that the overflow always occurs in the same position with respect to the machine. This is called unlimited axis and a typical example of it is a turntable shown in . It can be achieved with the following equation: the smallest value of  $m$  such that:

$$n \cdot \text{machine\_cycles} = m \cdot \text{motor\_revolution}$$

Because  $n$  and  $m$  are integers:  $\text{Pn205} = m - 1$ . This setting is explained in the following example.

**5-1-3-4 Example 2**

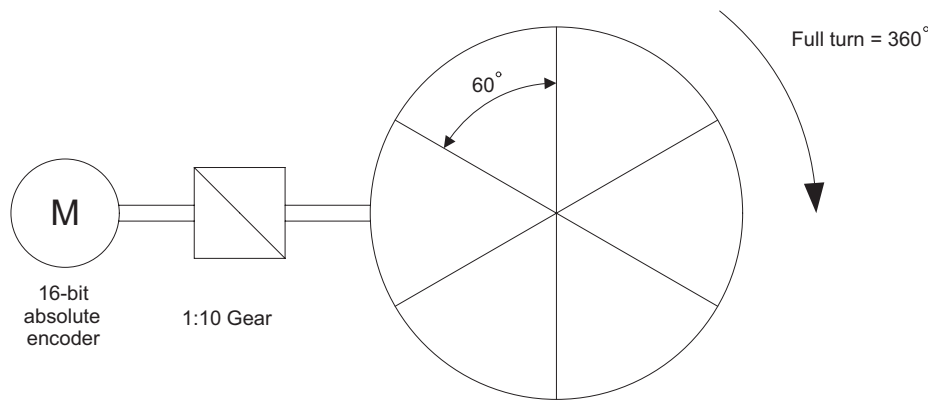

The mechanical system consists of simple rotary table shown in the figure. A servo motor with 16-bit absolute encoder is used. The gear ratio of the gearbox is 1:10. The desired user units are degree of angle. The rotary table is divided in six sections of 60 degrees each. Therefore the machine\_cycle is 60 degrees.

When we apply the last equation to the above, we get:

$$10 \cdot \text{motor\_revolution} = 1 \cdot \text{machine\_revolution} = 6 \cdot \text{machine\_cycle}$$

Simplification of this equation gives:

$$5 \cdot \text{motor\_revolution} = 3 \cdot \text{machine\_cycle}$$

This results in:

$$\text{Pn205} = 5 - 1 = 4$$

We calculate the parameters as we did in example 1. This gives:

$$\begin{aligned} \text{UNITS} &= 2^{11} = 2048 \\ \text{Pn202} &= 32 \\ \text{Pn203} &= 36 \end{aligned}$$

To guarantee the correct overflow both in the CJ1W-MCH72 and in the Servo Driver, we must set two additional axis parameters: **REP\_DIST** = 60, and **REP\_OPTION** = 1. With these settings, the command **MOVE(35)** rotates the table 35 degrees in positive direction. The range of possible **MPOS** and **DPOS** values is from 0 degrees to 60 degrees.

**Caution** You must initialize the absolute encoder before you use it for the first time, when the battery is lost during power off and when the multiturn limit setting in the parameter Pn205 is changed. The initialization can be done on the display of the Servo Driver or with the software tool. For more detail on initialising absolute encoder, please see the Sigma-II Servo Driver manual.

**Caution** It is possible to reset the multiturn counter, but it is not possible to reset the position within one turn (the fraction from 0 to and excluding 1). To adjust zero offset, use the parameter Pn808. For more details see the NS115 MECHATROLINK-II Interface Unit manual.

**Caution** At power up, the absolute encoder position is read from the motor and written to **MPOS** using the following conversion:

- For **MPOS**:

$$\text{Absolute\_MPOS} = \text{abs\_position\_encoder} \cdot \frac{1}{\text{UNITS}} \cdot \frac{\text{Pn203}}{\text{Pn202}}$$

- This is correct if

$$(\text{Pn205} + 1) \cdot \frac{\text{Pn203}}{\text{Pn202}} \cdot \text{encoder\_counts} < 2^{24}$$

- If this value is greater than  $2^{24}$ , **MPOS** can have incorrect values at start-up. To avoid this problem, add the program code **DEFPOS = ENCODER/UNITS** after all **UNITS** initializations.

**Caution** To make sure that the absolute position is always correct, you must make sure that

$$(\text{Pn205} + 1) \cdot \text{encoder\_resolution} < 2^{32}$$

and that

$$(\text{Pn205} + 1) \cdot \text{encoder\_resolution} \cdot \frac{\text{Pn203}}{\text{Pn202}} < 2^{32}$$

Note that this is not obvious for the high-resolution encoders of the Sigma-V and G-Series motors.

5-1-3-5 Example 3

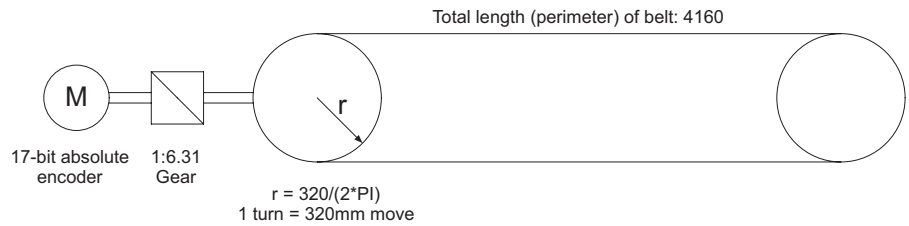

The mechanical system uses a servo motor with an 17-bit absolute encoder. The mechanical gear ratio of the gearbox is 1:6.31. One rotation of the pulley moves the moving part on the belt 320 mm. The total length of the belt, and therefore the total moving range of the motion part, is 4160 mm. The mechanical measurement units must be mm. This means that all axis parameters and commands given to the CJ1W-MCH72 are expressed in mm. Using the same procedure as in example 1, the equation expressing the relationship between user units and encoder counts is:

$$\frac{Pn202}{Pn203} \text{ UNITS} = \frac{2^{17} \cdot \text{encoder\_counts}}{1 \cdot \text{motor\_revolution}} \cdot \frac{6.31 \cdot \text{motor\_revolution}}{1 \cdot \text{pulley\_revolution}} \cdot \frac{1 \cdot \text{pulley\_revolution}}{320\text{mm}} =$$

$$\frac{2^{17} \cdot 6.31}{320} \frac{\text{encoder\_counts}}{\text{mm}}$$

Therefore:

$$\frac{Pn202}{Pn203} \text{ UNITS} = \frac{2^{17} \cdot 6.31}{320} = \frac{2^{17} \cdot 631}{2^5 \cdot 1000} = 2^{12} \frac{631}{8.125} = 2^{12} \frac{631}{2^3 \cdot 125} = 2^9 \frac{631}{125}$$

One solution is:

$$\begin{aligned} \text{UNITS} &= 2^9 = 512 \\ Pn202 &= 631 \\ Pn203 &= 125 \end{aligned}$$

Note that we have not used the pulley radius in the calculation. This is to avoid the use of  $\pi$ , which cannot be expressed as a fractional number). In toothed pulleys, the number of teeth and mm per tooth is commonly used.

The calculation of the multiturn limit setting is:

$$\begin{aligned} m \cdot \text{motor\_revolution} &= n \cdot \text{machine\_cycle} \\ m \cdot \text{motor\_revolution} &= n \cdot \text{machine\_cycle} \frac{4160 \cdot \text{pulley\_revolution}}{320 \cdot \text{machine\_cycle}} = n \cdot 13 \cdot \text{pulley\_revolution} \\ &= n \cdot 13 \frac{6 \cdot 31 \text{ motor\_revolution}}{1 \text{ pulley\_revolution}} = n \cdot 82.03 \cdot \text{pulley\_revolution} \\ m &= n \cdot 82.03 \end{aligned}$$

The smallest integer  $m$  for which this equation is valid is 8203. This results in Pn205 = 8202.

In addition, to limit the motion units range to the moving range of the motion part, the following axis parameters must be set: **REP\_DIST = 4260**, and **REP\_OPTION = 1**. With these settings, executing **MOVE(38)** moves the moving part 38 mm in forward direction. The range of possible **MPOS** and **DPOS** values is 0 mm to 4160 mm.

5-1-3-6 Example 4

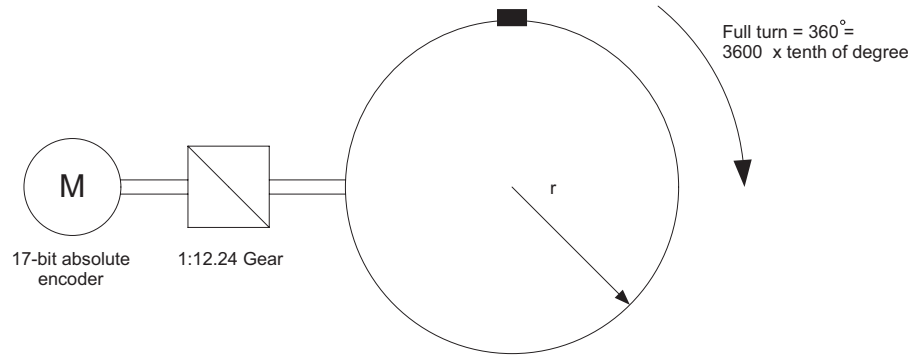

The mechanical system uses a servo motor with a 17-bit absolute encoder. The mechanical gear ratio of the gearbox is 1:12.24. The mechanical measurement units must be tenths of an angle degree. Therefore the total repeat distance for the full turn of the moving part is 3600 tenths of an angle degree.

With the same procedure as in example 1, we have:

$$\begin{aligned} \frac{Pn202}{Pn203} \text{ UNITS} &= \frac{2^{17} \cdot \text{encoder\_counts}}{1 \cdot \text{motor\_revolution}} \cdot \frac{12.24 \cdot \text{motor\_revolution}}{1 \cdot \text{machine\_revolution}} \cdot \frac{1 \cdot \text{pulley\_revolution}}{3600 \text{ tenth of degree}} = \\ &= \frac{2^{17} \cdot 12.24}{3600} \frac{\text{encoder\_counts}}{\text{tenth of degree}} \end{aligned}$$

Therefore:

$$\text{UNITS} = \frac{Pn202}{Pn203} = 2^{17} \frac{1224}{360000}$$

One solution is:

$$\begin{aligned} \text{UNITS} &= 2^{17} = 131072 \\ Pn202 &= 1224 \\ Pn203 &= 360000 \end{aligned}$$

Because the greatest common divisor of Pn202 and Pn203 must be 1, we get: Pn202 = 17 and Pn203 = 500. Therefore, the parameters are:

$$\begin{aligned} \text{UNITS} &= 131072 \\ Pn202 &= 17 \\ Pn203 &= 500 \\ Pn205 &= 16 \\ \text{REP\_DIST} &= 3600 \\ \text{REP\_OPTION} &= 1 \end{aligned}$$

To calculate the multiturn limit setting Pn205, we have:

$$m \cdot \text{motor\_revolution} = n \cdot \text{machine\_cycle} = n \cdot 12.24 \cdot \text{motor\_revolution}$$

The evident solution is:  $n = 100$  and  $m = 1224$ . Or, when we simplify the factors:  $n = 25$  and  $m = 306$ . Therefore:  $\text{Pn205} = m - 1 = 305$ . With these settings, executing **MOVE(180)** moves the moving part 180 tenths of an angle degree or 18 angle degrees in forward direction.

5-1-3-7 Example 5

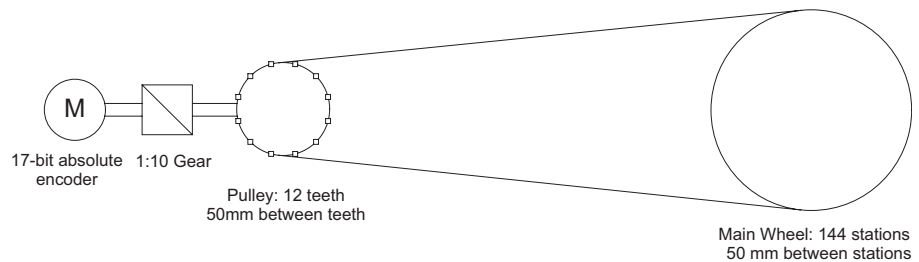

The mechanical system uses a servo motor with a 17-bit absolute encoder. The mechanical gear ratio of the gearbox is 1:10. The pulley has got 12 teeth, and each two are 50 mm apart. One complete turn of the pulley equals 144 stations on the main wheel. The distance between two stations is 50 mm. The mechanical measurement units must mm. Total repeat distance must be the distance between two stations, 50mm.

With the same procedure as in example 1, we have:

$$\begin{aligned} \frac{\text{Pn202}}{\text{Pn203}} \text{ UNITS} &= \\ \frac{2^{17} \cdot \text{encoder\_counts}}{1 \cdot \text{motor\_revolution}} \cdot \frac{10 \cdot \text{motor\_revolution}}{1 \cdot \text{pulley\_revolution}} \cdot \frac{1 \cdot \text{pulley\_revolution}}{12 \cdot \text{station}} \cdot \frac{1 \cdot \text{station}}{50\text{mm}} &= \\ = \frac{2^{17} \cdot 10}{12 \cdot 50} \frac{\text{encoder\_counts}}{\text{mm}} & \end{aligned}$$

Therefore, if we use the mechanical system to set the electronic gear ratio, we have:

$$\text{UNITS} \frac{\text{Pn202}}{\text{Pn203}} = \frac{2^{17}}{50} \frac{10}{12}$$

One possible solution is:

$$\begin{aligned} \text{UNITS} &= \frac{2^{17}}{50} \\ \text{Pn202} &= 5 \\ \text{Pn203} &= 6 \\ \text{Pn205} &= 4 \end{aligned}$$

Because  $2^{17}/50$  is a number with an infinite number of decimal digits, we can choose the following:

$$\text{UNITS} \frac{\text{Pn202}}{\text{Pn203}} = 2^{17} \frac{10}{50 \cdot 12} = 2^{17} \frac{10}{600} = 2^{17} \frac{1}{60} = 2^{17} \frac{1}{2^2 \cdot 15} = 2^{15} \frac{1}{15}$$

Therefore, the parameters are:



UNITS =  $2^{15}$  = 32768  
 Pn202 = 1  
 Pn203 = 15  
 Pn205 = 4  
 REP\_DIST = 50  
 REP\_OPTION = 1

With these settings, executing **MOVE(50)** moves the moving part 50 mm, or one station.

**5-1-3-8 Example 6**

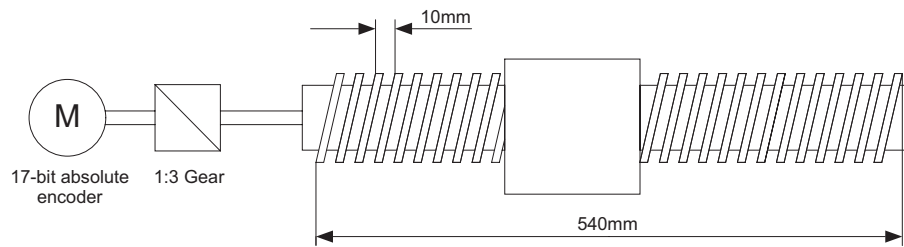

The mechanical system consists of a ball screw. It uses a servo motor with a 17-bit absolute encoder. The mechanical gear ratio of the gearbox is 1:3. The screw pitch of the ball screw is 10mm per revolution. The total travel distance of the ball screw is 540 mm. The mechanical measurement units must be mm. With the same procedure as in example 1, we have:

$$\begin{aligned}
 \frac{Pn202}{Pn203} \text{ UNITS} &= \frac{2^{17} \cdot \text{encoder\_counts}}{1 \cdot \text{motor\_revolution}} \cdot \frac{3 \cdot \text{motor\_revolution}}{1 \cdot \text{ballscrew\_revolution}} \cdot \frac{1 \cdot \text{ballscrew\_revolution}}{10\text{mm}} = \\
 &= \frac{2^{17} \cdot 3}{10} \frac{\text{encoder\_counts}}{\text{mm}}
 \end{aligned}$$

Therefore:

$$\frac{Pn202}{Pn203} \text{ UNITS} = 2^{17} \frac{3}{10} = 2^{17} \frac{3}{2 \cdot 5} = 2^{16} \frac{3}{5}$$

One solution is:

UNITS =  $2^{16}$  = 65536  
 Pn202 = 3  
 Pn203 = 5

The calculation of the multiturn limit setting parameter Pn205 is not needed in this case because the ball screw is a system with a fixed (limited) axis. It is enough to set this value large enough to have the overflow of the counter out of the effective position. Also, because of the axis is finite, it is not important to set the **REP\_OPTION** parameter, because **REP\_DIST** must be set large enough so it is outside of the maximum effective position (540 mm). One solution is: **REP\_DIST** = 1000 and **REP\_OPTION** = 0.

With these setting, executing **MOVE(17)** moves the ball screw 17 mm in forward direction.

### 5-1-4 Mapping Servo Driver inputs and outputs

The CJ1W-MCH72 has got a digital I/O space that consists of 256 digital inputs and 256 digital outputs.

The digital outputs range has four parts:

- Digital outputs 0 - 7.  
These outputs do not physically exist on the CJ1W-MCH72. If you write these outputs, nothing happens. If you read these outputs, they return 0.
- Digital outputs 8 - 15.  
These outputs physically exist on the CJ1W-MCH72. You can physically access them on the 28-pin screwless connector on the front side of the CJ1W-MCH72. If you write these outputs, they become active and give a 24 VDC signal. If you read these outputs, they return their current status. Use the command **OP** to write and read these outputs.
- Digital outputs 16 - 255.  
These outputs can be mapped to the PLC memory. If they are not mapped, they are software outputs only. They do not physically exist on the CJ1W-MCH72, but you can write them and read their correct status. You use these outputs mostly in BASIC programs to accomplish some control sequences that require outputs which do not need to be physical. Use the command **OP** to write and read these outputs.

All outputs are unique to the controller. They are not accessed per axis.

The digital input range has three parts:

- Digital inputs 0 - 15.  
These inputs physically exist on the CJ1W-MCH72. You can physically access them on the 28-pin screwless connector on the front side of the CJ1W-MCH72. These inputs are active (ON) when a 24 VDC signal is applied to them. When you read them, they return their current status. Use the command **IN** to read these inputs.
- Digital inputs 16 - 255.  
These inputs can be mapped to the PLC memory. If they are not mapped, they are software inputs only. They do not physically exist on the CJ1W-MCH72, but you can read them. You use them mostly in BASIC programs to accomplish some control sequences that require inputs which do not need to be physical. Use the command **IN** to read these inputs.

All inputs are unique to the controller. They are not accessed per axis.

#### 5-1-4-1 MECHATROLINK-II Servo Drivers inputs in the CJ1W-MCH72 I/O space

With the BASIC command **IN** you can access the physical controller inputs only. To read the inputs in the Servo Driver the BASIC command **DRIVE\_INPUTS** must be used.

Servo Drivers can have additional inputs that are located on their I/O connectors. These inputs can be used as forward and/or reverse limit switches or origin switches. They are mapped into the CJ1W-MCH72 I/O space. Thus, they can be accessed from BASIC programs. The CJ1W-MCH72 only supports this for Servo Drivers connected to the CJ1W-MCH72 system via the MECHATROLINK-II bus. It is not supported for Flexible Axis Servo Drivers.

| CJ1W-MCH72 input | Servo Driver input signal |         |       |          | Description          |
|------------------|---------------------------|---------|-------|----------|----------------------|
|                  | Sigma-II                  | Sigma-V | Junma | G-Series |                      |
| 16               | P_OT                      | P_OT    | P_OT  | P_OT     | Forward limit switch |
| 17               | N_OT                      | N_OT    | N_OT  | N_OT     | Reverse limit switch |

| CJ1W-MCH72 input | Servo Driver input signal |          |          |          | Description                                                                            |
|------------------|---------------------------|----------|----------|----------|----------------------------------------------------------------------------------------|
|                  | Sigma-II                  | Sigma-V  | Junma    | G-Series |                                                                                        |
| 18               | DEC                       | DEC      | /DEC     | DEC      | Zero point return deceleration                                                         |
| 19               | PA                        | PA       | Not used | Not used | Encoder A phase signal                                                                 |
| 20               | PB                        | PB       | Not used | Not used | Encoder B phase signal                                                                 |
| 21               | PC                        | PC       | Not used | PC       | Encoder Z phase signal                                                                 |
| 22               | EXT1                      | EXT1     | /EXT1    | EXT1     | First external latch signal                                                            |
| 23               | EXT2                      | EXT2     | Not used | EXT2     | Second external latch signal                                                           |
| 24               | EXT3                      | EXT3     | Not used | EXT3     | Third external latch signal                                                            |
| 25               | BRK                       | BRK      | /BRK     | BRK      | Brake output                                                                           |
| 26               | Reserved                  | HBB      | E-STP    | E-STP    | Emergency stop switch                                                                  |
| 27               | Reserved                  | Reserved | Not used | SI2      | General input 2                                                                        |
| 28               | IO12                      | IO12     | Not used | PCL      | General input 12 (Sigma-II and Sigma-V), Torque limit input in positive direction (GN) |
| 29               | IO13                      | IO13     | Not used | NCL      | General input 13 (Sigma-II and Sigma-V), Torque limit input in negative direction (GN) |
| 30               | IO14                      | IO14     | Not used | SI0      | General input 14 (Sigma-II and Sigma-V), General input 0 (GN)                          |
| 31               | IO15                      | IO15     | Not used | SI1      | General input 15 (Sigma-II and Sigma-V), General input 1 (GN)                          |

The inputs in the table above are located on the CN1 I/O connector of the respective Servo Driver. The pin arrangement of this connector is different for the respective Servo Drivers. For the Sigma-II and Sigma-V Servo Drivers, the input signals P\_OT, N\_OT, DEC, EXT1, EXT2, EXT3, BRK, IO12, IO13, IO14 and IO15 can be mapped to pins of the CN1 I/O connector. To do this, you must set the appropriate parameter of the Servo Driver. The table below shows the possible settings and parameter values.

| Input signal - Parameter name                                                                | Parameter setting | CN1 pin number |          |
|----------------------------------------------------------------------------------------------|-------------------|----------------|----------|
|                                                                                              |                   | Sigma-II       | Sigma-V  |
| P_OT (active high) - Pn50A.3<br>N_OT (active high) - Pn50B.0<br>DEC (active high) - Pn511.0  | 0                 | 40 (SI0)       | 13 (SI0) |
|                                                                                              | 1                 | 41 (SI1)       | 7 (SI1)  |
|                                                                                              | 2                 | 42 (SI2)       | 8 (SI2)  |
|                                                                                              | 3                 | 43 (SI3)       | 9 (SI3)  |
|                                                                                              | 4                 | 44 (SI4)       | 10 (SI4) |
|                                                                                              | 5                 | 45 (SI5)       | 11 (SI5) |
|                                                                                              | 6                 | 46 (SI6)       | 12 (SI6) |
|                                                                                              | 7                 | Always ON      |          |
|                                                                                              | 8                 | Always OFF     |          |
| /P_OT (active low) - Pn50A.3<br>/N_OT (active low) - Pn50B.0<br>/DEC (active low) - Pn511.0  | 9                 | 40 (SI0)       | 13 (SI0) |
|                                                                                              | A                 | 41 (SI1)       | 7 (SI1)  |
|                                                                                              | B                 | 42 (SI2)       | 8 (SI2)  |
|                                                                                              | C                 | 43 (SI3)       | 9 (SI3)  |
|                                                                                              | D                 | 44 (SI4)       | 10 (SI4) |
|                                                                                              | E                 | 45 (SI5)       | 11 (SI5) |
|                                                                                              | F                 | 46 (SI6)       | 12 (SI6) |
| /EXT1 (active low) - Pn511.1<br>/EXT2 (active low) - Pn511.2<br>/EXT3 (active low) - Pn511.3 | 0-3               | Always OFF     |          |
|                                                                                              | 4                 | 44 (SI4)       | 10 (SI4) |
|                                                                                              | 5                 | 45 (SI5)       | 11 (SI5) |
|                                                                                              | 6                 | 46 (SI6)       | 12 (SI6) |
|                                                                                              | 7                 | Always ON      |          |
|                                                                                              | 8, 9-C            | Always OFF     |          |
| EXT1 (active high) - Pn511.1<br>EXT2 (active high) - Pn511.2<br>EXT3 (active high) - Pn511.3 | D                 | 44 (SI4)       | 10 (SI4) |
|                                                                                              | E                 | 45 (SI5)       | 11 (SI5) |
|                                                                                              | F                 | 46 (SI6)       | 12 (SI6) |
| /BRK (active low) - Pn50F.2                                                                  | 0                 | Always OFF     |          |
|                                                                                              | 1                 | 25             | 1        |
|                                                                                              | 2                 | 27             | 23       |
|                                                                                              | 3                 | 29             | 25       |
| IO12 - Pn81E.0<br>IO13 - Pn81E.1<br>IO14 - Pn81E.2<br>IO15 - Pn81E.3                         | 0                 | Always OFF     |          |
|                                                                                              | 1                 | 40 (SI0)       | 13 (SI0) |
|                                                                                              | 2                 | 41 (SI1)       | 7 (SI1)  |
|                                                                                              | 3                 | 42 (SI2)       | 8 (SI2)  |
|                                                                                              | 4                 | 43 (SI3)       | 9 (SI3)  |
|                                                                                              | 5                 | 44 (SI4)       | 10 (SI4) |
|                                                                                              | 6                 | 45 (SI5)       | 11 (SI5) |
|                                                                                              | 7                 | 46 (SI6)       | 12 (SI6) |

For the Junma Servo Driver, all input signals are mapped to a fixed location on the CN1 I/O connector. The table below shows the input signals and pin numbers.

| Input signal        | CN1 pin number |
|---------------------|----------------|
| P_OT (active high)  | 4              |
| N_OT (active high)  | 3              |
| DEC (active low)    | 1              |
| EXT1 (active low)   | 2              |
| BRK (active low)    | 13             |
| E-STP (active high) | 6              |

For the G-Series Servo Driver, all input signals are mapped to a fixed location on the CN1 I/O connector. The table below shows the input signals and pin numbers.

| Input signal        | CN1 pin number |
|---------------------|----------------|
| P_OT (active high)  | 19             |
| N_OT (active high)  | 20             |
| DEC (active high)   | 21             |
| EXT1 (active high)  | 5              |
| EXT2 (active high)  | 4              |
| EXT3 (active high)  | 3              |
| E-STP (active high) | 2              |
| SI0 (active high)   | 22             |
| SI1 (active high)   | 23             |
| SI2 (active high)   | 6              |
| PCL (active high)   | 7              |
| NCL (active high)   | 8              |

For more information on the CN1 I/O connector pins on the Servo Drivers, refer to the Sigma-II Servo Driver manual, the Sigma-V Servo Driver manual, the Junma series Servo Driver manual and the G-Series series Servo Driver manual.

Servo Driver inputs that are mapped into the CJ1W-MCH72 I/O space like this are accessed within the program per axis and cannot be accessed in the usual way with the **IN** command. The only way you can use these inputs in the program is to assign them to the axis parameters **DATUM\_IN**, **FHOLD\_IN**, **FWD\_IN** and **REV\_IN**. The inputs of the axis Servo Driver are used, depending on the axis of which the parameters are set.

Example: We have a Sigma-II and a Junma driver assigned to controller axes 0 and 3. For the Sigma-II driver, we want to use input signal EXT1 (mapped to CN1-44 if Pn511.2 is set to 4) to serve as reverse limit input for axis 0. For the Junma driver, we want to use input signal EXT1 (CN1-2) as reverse limit for axis 3. We can do this with these commands:

```

REV_IN AXIS(0) = 22
REV_IN AXIS(3) = 22

```

Note that even though **REV\_IN** parameters for both axes have the same value, the real inputs used are not the same. For axis 0 the input on CN1-44 of the Sigma-II driver (assigned to axis 0) is used, but for axis 3 the input on CN1-41 of the Junma driver (assigned to axis 3) is used. Therefore we say that those inputs are accessed per axis, they are not unique for the whole controller. In general, these two inputs have a different status at the same time. Also note that neither of these two inputs can be accessed using the command **IN**. For example the command **IN(22)** returns the status of controller software input 22 (unique for all axes), which has a different status than Servo Driver inputs mapped to the same number. However, the command **INVERT\_IN(22)** inverts the status of input 22 read by the controller. It affects not only the unique software input 22, which is accessible with the **IN** command, but all axis-specific inputs 22, which in this example are the EXT1 inputs of the connected Servo Drivers.

**Note** If a forward limit, reverse limit and origin input signal are used for an axis, it is strongly recommended to use the following settings for the axis:

**BASE(axis\_number)**

DAT\_IN=18

' /DEC input in the corresponding Servo Driver is  
' assigned

FWD\_IN=16

INVERT\_IN(16,ON)

' P\_OT input in the corresponding Servo Driver is  
' assigned. It is necessary to invert the signal  
' because a Normally Closed input is expected.

REV\_IN=17

INVERT\_IN(17,ON)

' N\_OT input in the corresponding Servo Driver is  
' assigned. It is necessary to invert the signal  
' **because a Normally Closed input is expected**

Also note that **INVERT\_IN** inverts the selected input in all axes.

### 5-1-5 Origin search

The origin search or homing functionality is often seen as a particular sequence of movements of an axis at the start-up phase of the machine. This sequence is done automatically in most cases, without the input from the operator of the machine. In general, an origin search procedure couples a position to a specific axis. It depends on the encoders used (absolute or relative), on the system used (linear or circular), and on the mechanical construction of the machine. Absolute encoders do not need a movement during the origin search procedure, because the exact positions are transferred directly to the system. For other encoder types, a movement is necessary, since there is no knowledge of the exact position within the system. Basically, this movement is at low speed in some direction until a certain measuring point is reached. Such a measuring point can be scanned from both directions to increase the precision.

At startup, the current positions of the axes using incremental encoders are 0. Because these positions do not match with the mechanical 0 of the machine, it is necessary to execute the homing sequence. If an absolute encoder is used, the absolute position is read at startup from the encoder and homing is not necessary. In this case, a startup sequence must be executed one time during the machine commissioning.

In practice there are several different origin search sequences. They are different in these areas:

- The means used to detect limit positions of the moving part (sensors, switches, etc.)
- Origin (home) position or reference.
- Possible positions of the moving part related to limit positions and origin position.

The CJ1W-MCH72 includes some pre-defined basic homing sequences:

- **DATUM(0)**  
This is not really an origin search. This command sets **DPOS=MPOS** and cancels the axis errors.
- **DATUM(1)**  
This does an origin search in forward direction using the Z mark of an encoder as homing switch.
- **DATUM(2)**  
Does an origin search in reverse direction using the Z mark of an encoder as homing switch.
- **DATUM(3)**  
Does an origin search in forward direction using the input selected in **DATUM\_IN** as homing switch.
- **DATUM(4)**  
Does an origin search in reverse direction using the input selected in **DATUM\_IN** as homing switch.
- **DATUM(5)**  
Does an origin search in forward direction using the input selected in **DATUM\_IN** as homing switch and searches the next Z mark of an encoder.
- **DATUM(6)**  
Does an origin search in reverse direction using the input selected in **DATUM\_IN** as homing switch and searches the next Z mark of an encoder.

For more details on these pre-defined homing sequences, see section 4-2-65. In some situations, more complex homing sequences are required:

- Absolute switch origin search plus limit switches.
- Origin search against limit switches.
- Origin search against hardware parts blocking movement.

- Origin search using encoder reference pulse "Zero Mark".
- Static origin search, forcing a position from a user reference.
- Static origin search, forcing a position from an absolute encoder.

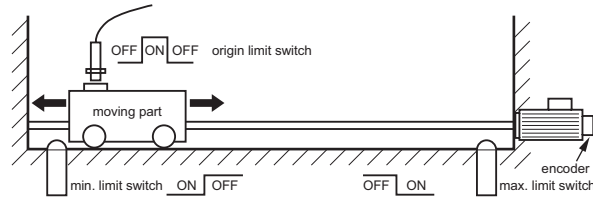

The figure shows a general origin search scenario. This simple origin search sequence has 3 steps:

- 1 Search for a signal.
- 2 Search for another signal.
- 3 Move the axis to a predefined position.

**Note**

For safety reasons, limit switches are normally closed. For this reason, in this figure and in the following figures in this section, the low signal level is indicated as ON, and the high signal level is indicated as OFF.

It is important to note that, before any homing procedure is executed, it is necessary to set the axis parameters **UNITS**, **REP\_DIST** and **REP\_OPTION**, and Servo Driver parameters Pn202, Pn203 and Pn205 properly and in accordance with the mechanical system and desired measurement units used in programming. Those parameters have influence to the origin search, especially if an absolute encoder is used. For more information on setting these parameters, see section 5-1-2.

**5-1-5-1 Absolute switch origin search plus limit switches**

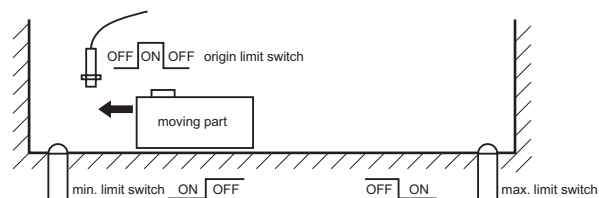

The origin search function is performed by searching for an external limit switch that is positioned absolutely and the position of which defines the origin position. The example for this homing procedure is shown in the figure.



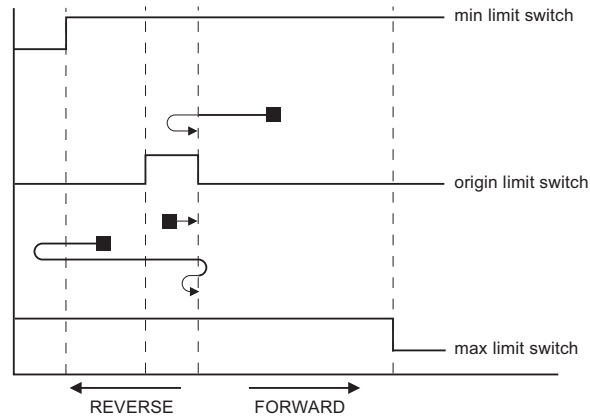

The figure shows the possible scenarios for absolute origin search plus limit switches. These scenarios depend on the position of the moving part when the power comes on.

The program example that does this origin search sequence is given below.

```
'Absolute origin switch: IN0
'Left limit switch: IN1
'Right limit switch: IN2
BASE (0)
DATUM_IN=0
FWD_IN=2
REV_IN=1
SERVO=ON
WDOG=ON
DATUM (4)
WA (1)
WAIT UNTIL MTYPE=0 OR IN (1)=OFF
IF IN (1)=ON
 FORWARD
 WAIT UNTIL IN (0)=ON
 WAIT UNTIL IN (0)=OFF
 CANCEL
 DATUM (4)
 WA (1)
 WAIT IDLE
ENDIF
```

5-1-5-2 Origin search against limit switches

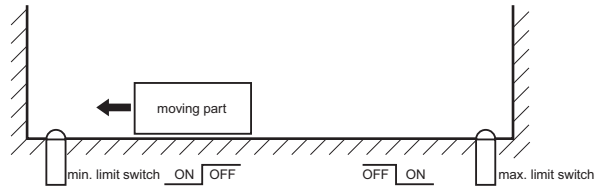

This origin search function is performed by searching for an external sensor using limit switches only. The example for this homing procedure is shown in the figure.

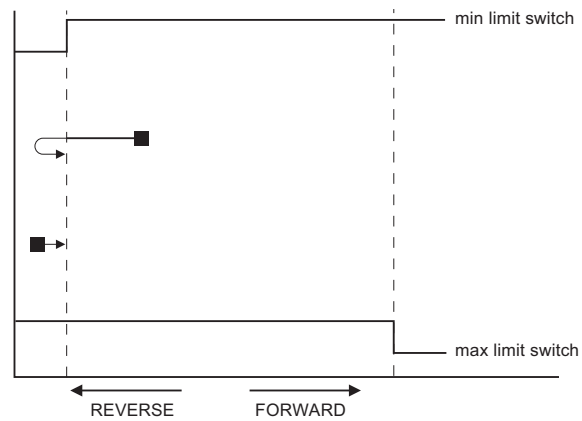

The possible scenarios for origin search against limit switches, depending on the position of the moving part on power on, are shown in the figure. The program example that does this origin search sequence is given below.

```
'Origin and left limit switch: IN0
'Right limit switch: IN1
BASE(0)
DATUM_IN=0
SERVO=ON
WDOG=ON
DATUM(4)
WA(1)
WAIT IDLE
```

### 5-1-5-3 Origin search against hardware parts blocking movement

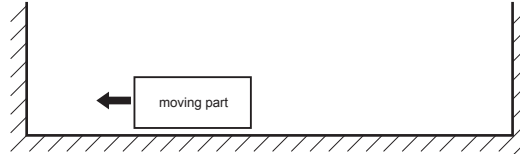

This origin search procedure performs origin search against a physical object and mechanically blocks the movement. There are no limit switches, no absolute position switch and no reference pulses. The origin position is detected by detecting a particular amount of torque against the blocking objects. An adequate torque limit is required in order not to damage the mechanics during the origin search process. The example for this homing procedure is shown in the figure.

The program example that does this origin search sequence is given below.

```

BASE(0)
DRIVE_CONTROL=11 'Monitor torque with DRIVE_MONITOR
SERVO=ON
WDOG=ON
SPEED=CREEP
REVERSE
WA(1)
WAIT UNTIL DRIVE_MONITOR < -100
 'Wait for particular amount of applied torque
CANCEL
DEFPOS(0)
MOVEABS(10) 'This is necessary, otherwise the position
 'is kept pushing the hardware limit of the
 'machine and the motor trips by overload

```

### 5-1-5-4 Origin search using encoder reference pulse “Zero Mark”

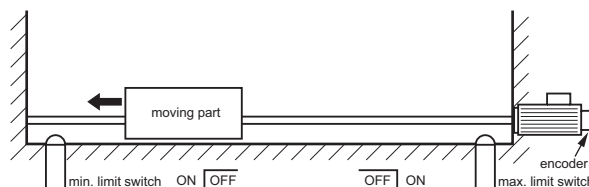

This origin search procedure performs origin search by searching for the "Zero Mark" signal of the encoder. This signal is also known as "marker" or "reference pulse". It appears one time per full encoder revolution. The example for this homing procedure is shown in the figure.

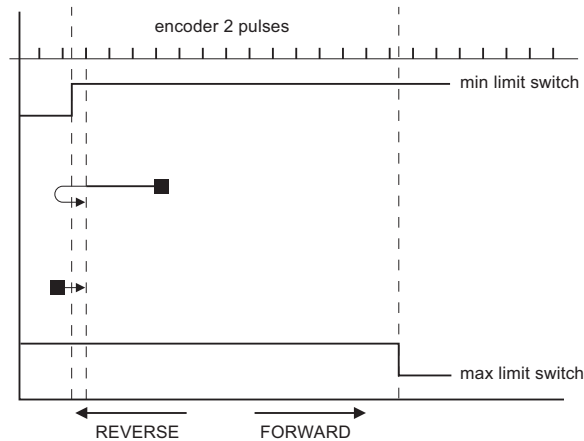

The possible scenarios for origin search using encoder reference pulse "Zero Mark", depending on the position of the moving part on power on, are shown in the figure.

The program example that does this origin search sequence is given below.

```
'Origin and left limit switch: IN0
'Right limit switch: IN1
REV_IN=-1
BASE(0)
DATUM_IN=0
SERVO=ON
WDOG=ON
DATUM(6)
WA(1)
WAIT IDLE
```

#### 5-1-5-5 Static origin search, forcing a position from a user reference

This origin search procedure performs a static origin search by directly forcing an actual position. It does not perform any physical move.

```
DATUM(0)
```

#### 5-1-5-6 Static origin search, forcing a position from an absolute encoder

This origin search procedure sets the actual position to the position of an absolute encoder. It does not perform any physical move. It is only possible with an axis with an absolute encoder in a control loop.

### 5-1-6 Registration

Registration, also called 'latch' or 'print registration', is about real-time storing of the position of an axis when an external input is activated. The information that is registered, i.e. stored, is processed later, not in real time, by the application program.

Registration is different from processing an interrupt input or signal. With registration, no event is generated when the registration input is activated. Also, the normal execution of the application program is not disturbed or

interrupted. Only the position of an axis is stored. This information can be used, like other parameters or values, in a program. The registration information is available to a program immediately after the registration.

The advantage of registration is that it is done very quickly. Therefore, the axis position that is stored is very accurate. To achieve this speed and accuracy, registration is implemented with hardware, and the registration input must be on the same board as the encoder input that provides information on the axis position.

Capturing and storing the axis position is done in real time by the hardware. Processing this information is done not in real time by the application program.

### 5-1-6-1 The REGIST axis command

In Trajexia, you do a registration with the **REGIST** axis command. This command takes one argument. This argument determines which external input is registered, whether the registration is executed on the rising edge or on the falling edge of the input signal, whether the windowing function is used, and other options. For more information on the **REGIST** command, refer to section 4-2-200.

The registration differs for different axes depending on their connection to the system. If an axis is connected via the MECHATROLINK-II bus, the registration is done in the Servo Driver hardware. If an axis is connected via the Encoder Interface, the registration is done in the hardware of the CJ1W-MCH72.

The different registrations are described below.

### 5-1-6-2 Registration in the Sigma-II and Sigma-V Servo Driver

Registration in the Sigma-II and Sigma-V Servo Driver occurs when an axis assigned to this Servo Driver is connected to the Trajexia system via the MECHATROLINK-II bus. There are three registration inputs on these Servo Drivers, but only one hardware latch, so only one input can be used at a time. For Sigma-II Servo Drivers the physical inputs are in pins CN1-44, CN1-45 and CN1-46 on the 50-pins CN1 connector. For Sigma-V Servo Drivers the physical inputs are in pins CN1-10, CN1-11 and CN1-12 on the 26-pins CN1 connector. Trajexia uses logical inputs EXT1, EXT2 and EXT3 to associate the physical inputs to logical ones. This association is done by setting the parameter Pn511 of the Servo Driver. For more information on setting this association and Pn511 parameter, refer to section 4-2-200, table 1. The input used for registration is determined by the argument of the **REGIST** command.

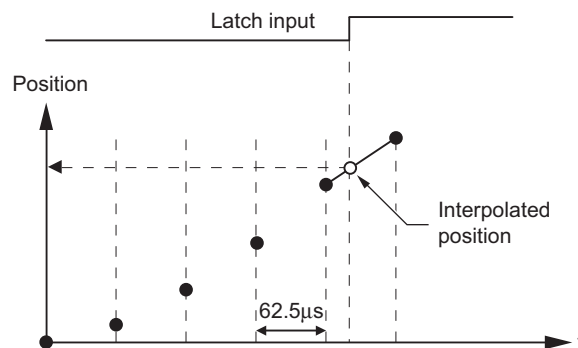

The delay in the capture in the Sigma-II Servo Driver is about 3  $\mu\text{s}$ . As the encoder information is refreshed every 62.5  $\mu\text{s}$ , it is necessary to make interpolation to obtain the right captured position value (see the picture). Since the motor speed cannot change much during 62.5  $\mu\text{s}$ , the resulting accuracy is very high.

The delays in transmission of the information are:

- Delay in triggering the registration: 0.625 ms to 4 ms.
- Delay in receiving the registration: 3.5 ms.
- Delay in capturing the registration: 3  $\mu\text{s}$ .

It is also possible to use the encoder Z-mark to register an axis position. This is also done with the argument of the **REGIST** command.

### 5-1-6-3 Registration in the Junma Servo Driver

Registration in the Junma Servo Driver is the same as registration in the Sigma-II Servo Driver, with one difference: There is only one physical input and one logical latch too, so no settings of Servo Driver parameters are necessary. The physical input is associated to logical latch EXT1, and only the rising signal edge can be used for registration.

### 5-1-6-4 Registration in the G-Series Servo Driver

Registration in the G-Series Servo Driver is the same as registration in the Sigma-II Servo Driver, with one difference: There are three physical inputs but only one can be activated at a time. The physical input is associated to logical latch EXT1, EXT2 and EXT3, but the corresponding locations on the CN1 connector are fixed, so no settings of Servo parameters are necessary. Only the rising signal edge can be used for registration.

In contrast with all other types Servo Drivers, the G-series Servo Drivers do not support executing registration while it is in base-block state. The registration can be executed on G-Series Servo Drivers only when **WDOG** is set to ON. If registration is required when the G-Series Servo Driver is in base-block state, this workaround can be used: put the G-Series Servo Driver in torque mode with zero torque by executing:

- `ATYPE=42`
- `T_REF=0`

and then perform registration.

### 5-1-6-5 Registration in the Encoder Interface

The CJ1W-MCH72 has three physical registration inputs (two registration inputs, see section 2-1-1, and encoder Z-mark input, see section 2-2-2), and two latch circuits, which can be used independently. Therefore two independent registration inputs can be used at the same time. For more information on how to use both registration inputs of the CJ1W-MCH72 at the same time, refer to sections 4-2-152, 4-2-153, 4-2-198, 4-2-199 and 4-2-200. The delay in the capture is 0.5  $\mu\text{s}$ . Because the encoder position is read continuously from the line-drive encoder input, interpolation is not necessary. The delay for the transmission of the captured information is just one **SERVO\_PERIOD** cycle.

5-1-6-6 Using registration in application programs

There is one axis command (**REGIST**), and two axis parameters (**MARK** and **REG\_POS**). With these commands and parameter, you can control and use the registration functionality in BASIC programs.

- **REGIST** captures the axis position when a registration signal is detected. The available settings depend on the axis type. Refer to section 4-2-200.
- **MARK** is a flag that signals whether the position has been captured or not. For the second registration input of the Encoder Interface, the parameter **MARKB** is also available. For more information, refer to sections 4-2-152 and 4-2-153.
- **REG\_POS** holds the captured axis position. Only if the **MARK** flag signals that the position was captured successfully, you can regard the **REG\_POS** value as valid. For the second registration input of the Encoder Interface, the parameter **REG\_POSB** is also available. For more information, refer to sections 4-2-198 and 4-2-199.

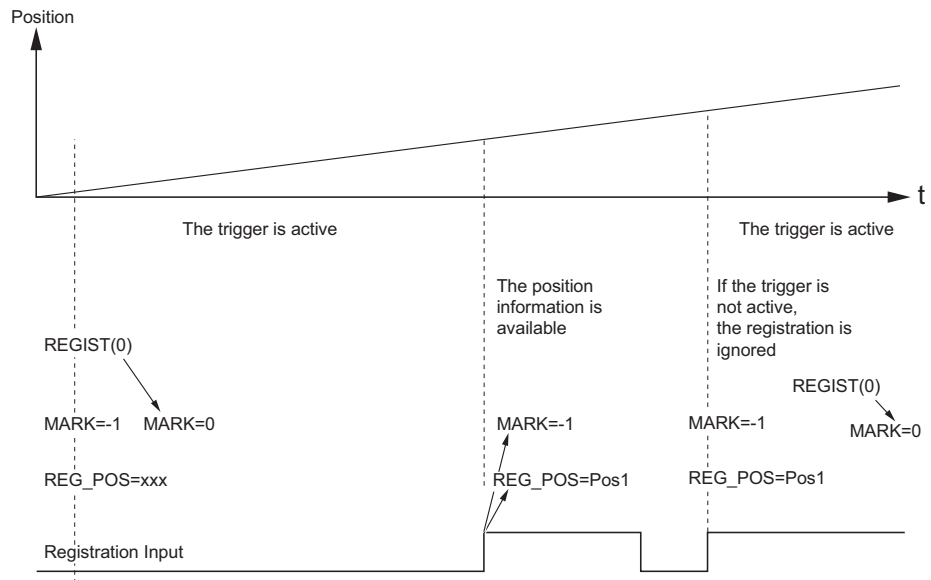

The picture gives the sequence of executing the commands and the registrations of the sample program below.

```

BASE (N)
REGIST (0)
WAIT UNTIL MARK=0
loop:
 WAIT UNTIL MARK=-1
 PRINT "Position captured in: "; REG_POS
 REGIST (0)
 WAIT UNTIL MARK=0
GOTO loop

```

### 5-1-6-7 Registration and windowing function

The windowing function enables for registration to occur only within a specified range of axis positions. This function is selected by giving the right value as an argument for the **REGIST** command. The windowing function is controlled by two axis parameters, **OPEN\_WIN** and **CLOSE\_WIN**. For more information on **REGIST**, **OPEN\_WIN** and **CLOSE\_WIN**, refer to sections 4-2-200, 4-2-178 and 4-2-51.

There are two types of windowing:

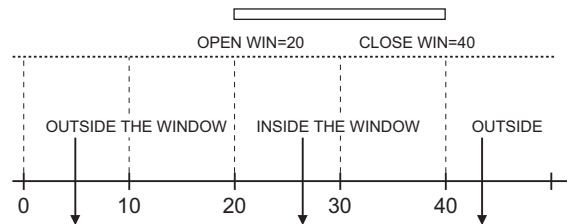

- Inclusive windowing allows the registration to occur only within the specified window of axis positions. With this windowing function, registration events are ignored if the axis measured position is less than the **OPEN\_WIN** axis parameter or greater than the **CLOSE\_WIN** parameter.
- Exclusive windowing allows the registration to occur only outside the specified window of axis positions. With this windowing function, the registration events are ignored if the axis measured position is greater than the **OPEN\_WIN** axis parameter or less than the **CLOSE\_WIN** parameter.

When the windowing function is used, the internal process is as follows:

- 1 **REGIST** + window is executed in the program.
- 2 **MARK** = 0 and the latch is triggered.
- 3 The position is captured and transmitted to the Trajexia processor.
- 4 Is the captured position inside the inclusive window or outside the exclusive window?
  - If yes, **MARK** = -1 and **REG\_POS** is updated.
  - If not, return to point 2 (trigger the latch again transparently to the user).



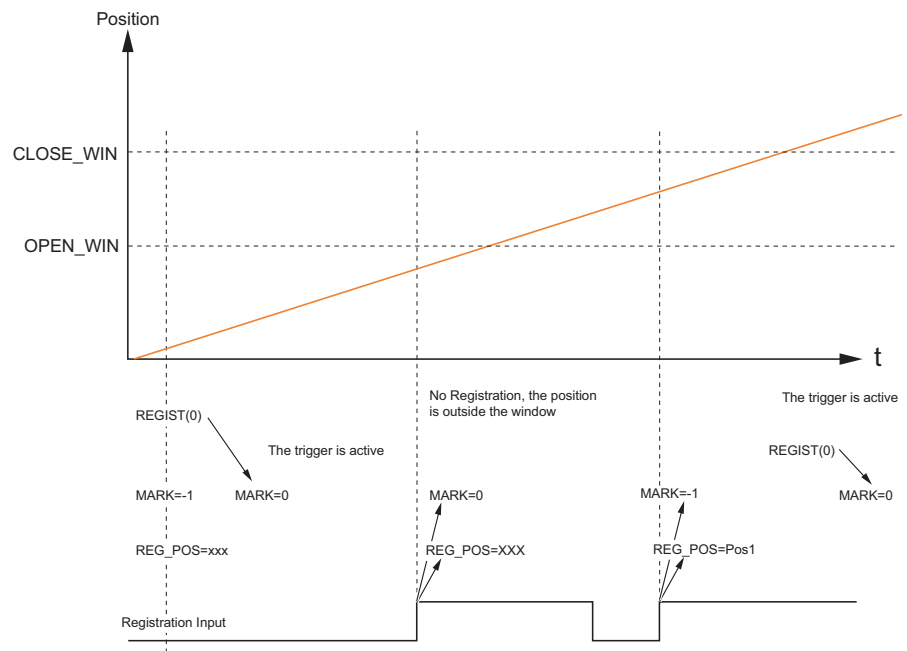

The figure shows the sequence of execution of the above commands and the occurrence of registration events when you use inclusive windowing.

There are delays between these events:

- Trajexia receives the latch.
- Trajexia decides to trigger the latch again.
- The latch is triggered.

Because of these delays, there is an uncertainty in the edges of the window when marks may be detected near the edges. This is more notable for axes connected to the system via the MECHATROLINK-II bus due to bus delays. To compensate for these delays, a user must set the window margins large enough.

5-1-6-8 Example: Correcting the position of an axis

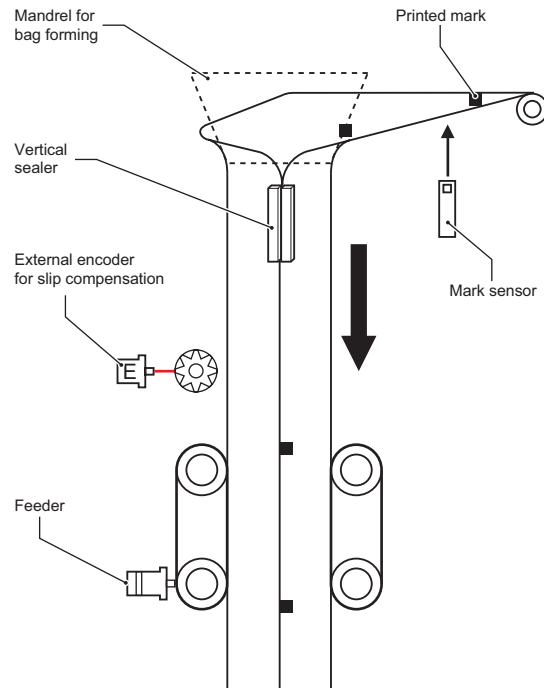

The picture shows the vertical fill and seal machine for packaging products into bags. The bag material comes from a plastic film coil that is unwinded, then it is shaped into the tube by a mechanical mandrel and at the same time the tube is sealed vertically. The feeder movement is intermittent and the feed length corresponds with the bag length. Once the bag is fed, the horizontal sealer closes the bag, so it can be filled with the product. After that, the process starts again, feeding the new bag.

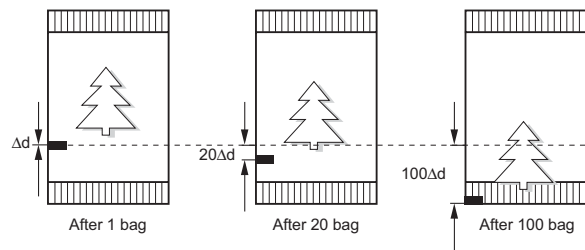

The feeder can work in two modes: without registration mark; and with registration mark. Working without the registration mark is a simple point-to-point incremental movement. In this case, there is no guarantee that the feeder moves exactly the same distance as the design pattern. For example, suppose the bag length that needs to be fed is 200 mm, but the real pattern is 200.1 mm. With simple point-to-point incremental movement without

correction, an error of 0.1 mm per bag is accumulated. With a small number of bags the difference is not visible, but after 500 bags the error is 50 mm, which is a 25% of the bag length.

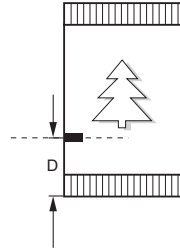

When working with registration marks, the motion controller executes an incremental movement to a certain position. If during the positioning the registration mark is detected, the target position is changed on the fly in order to finish the movement at a defined position after the registration mark. Therefore, the same distance in respect to the registration mark is always guaranteed.

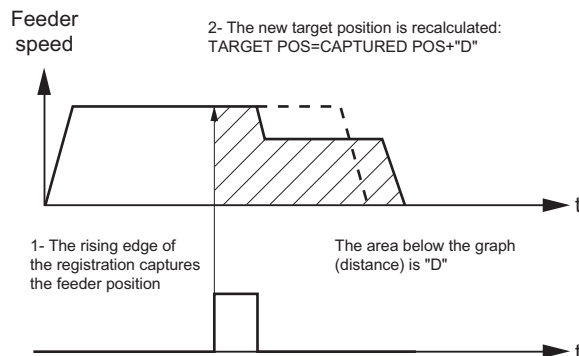

The motion profile and its modification due to the registration mark are shown in .

The BASIC program for this example is:

```

DEFPOS (0)
REGIST(3) 'Trigger the mark registration
MOVE(bag_length) 'Move to the theoretical distance
WA(1)
WAIT UNTIL MARK OR MTYPE=0
IF MARK THEN
 end_position=REG_POS+distance_after_mark
 MOVEMODIFY(end_position)
 'Correct the distance according to the mark
ENDIF

```

5-1-6-9 Example: Starting a slave axis in precise position of a master axis

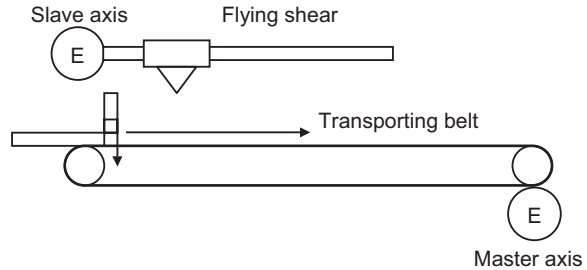

The picture shows a flying shear cutting the "head" of wood tables. When the wood comes, the edge of the wood is detected by the photocell and, at the exact moment, the movement of the flying shear starts to be synchronized with the right position on the wood.

If the movement is started by the program, upon detecting a signal from the photocell, there is always at least one **SERVO\_PERIOD** of time of uncertainty. Instead, the movement is started using the **MOVELINK** command with **link\_option=1**, which means that the link to the master axis starts when the registration event occurs on link (master) axis.

The corresponding program sequence is:

**REGIST(2) AXIS(master)**

**MOVELINK(dst,lnk\_dst,lnk\_acc,lnk\_dec,master,1) AXIS(slave)**

For more information on the **MOVELINK** command and the **link\_option** argument, refer to section 4-2-162.

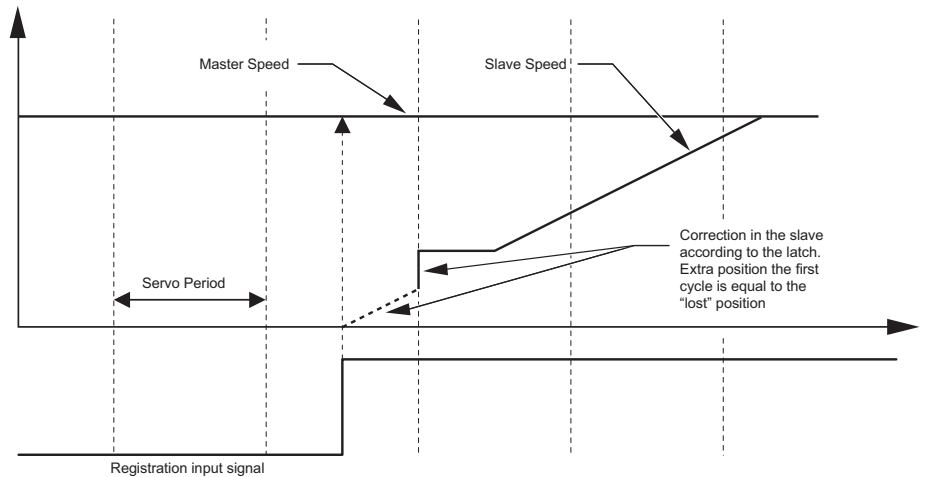

The picture shows how the position of the slave axis is corrected using the registration event on the master axis to start the movement of the slave axis. The influence of **SERVO\_PERIOD** and the fact that the registration event can happen at any time inside the **SERVO\_PERIOD** is completely eliminated.

## 5-1-7 Tracing and monitoring

### 5-1-7-1 Oscilloscope functionality in Trajexia Studio

The software oscilloscope is a standard part of Trajexia Studio. The oscilloscope can be used to trace and graphically represent axis and system parameters. This can help you with development, commissioning and troubleshooting of the motion system. For more information on the software oscilloscope and its features and capabilities, refer to the Trajexia Studio manual.

You can trigger the oscilloscope to start tracing given axis and system parameters in two ways: manually or by a program. Triggering manually is done using the data trace. The parameters are stored in the Table memory of the controller. The range of the Table memory where the parameters are stored can be set in the **Memory Manager** of the device configuration (see the Trajexia Studio manual). With manual triggering, the user can see the changes of axis and system parameters in real time, as the system runs. A change in parameter values is graphically represented as soon as the change happens. The limitation of manual triggering is that it requires user interaction, which means that the start of tracing is not synchronized with the movement that is analyzed. Also, with manual triggering the tracing range is limited to 200 samples per channel.

### 5-1-7-2 Using the oscilloscope

The alternative, triggering by a program, does not have the limitations of manual triggering of the tracing. Triggering by a program stores the axis and system parameters in the memory of the CJ1W-MCH72. Later, the parameters are given to the oscilloscope for graphical representation. The axis and system parameters are stored in the Table memory. The memory range used is defined by the parameters of the **SCOPE** command. When the parameters are in the Table memory, the oscilloscope can be configured to show a range of Table memory locations instead of axis and system parameters. The exact moment when the tracing is started can be exactly determined because it is controlled by the **TRIGGER** command. This means the start of tracing is synchronized with the movement. There is no limitation of 200 samples per channel, the oscilloscope shows as many samples (Table entries) as configured.

### 5-1-7-3 Example

This section gives you a practical example on the use of the **SCOPE** and **TRIGGER** commands, and how to use them in combination with the oscilloscope to monitor axis parameters and troubleshoot the system. For more information on the **SCOPE** and **TRIGGER** commands, refer to sections 4-2-218 and 4-2-245.

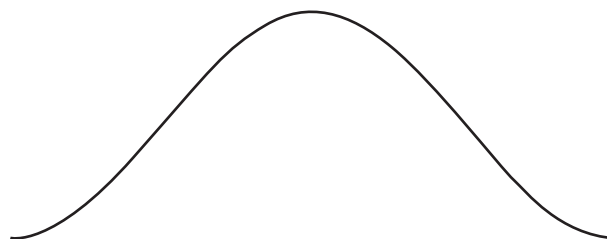

Suppose the motion system consists of two axis, **AXIS(0)** and **AXIS(1)**. **AXIS(0)** is the master axis. It makes a simple forward movement. **AXIS(1)** is the slave axis. It must follow the master axis in accordance to cosine rule:

$$x_1 = end\_pos \cdot \frac{1}{2} \left( 1 - \cos \left( \frac{2\pi \cdot x_0}{999} \right) \right)$$

where  $x_0$  is the position of the master **AXIS(0)**, and  $x_1$  is the position of the slave **AXIS(1)**. You can link the two axis with the **CAMBOX** command. For more details, refer to section 4-2-44. Suppose furthermore that the parameter **end\_pos** is not constant, but it can change due to different conditions of the motion system. The part of the program that creates the CAM table is:

```
'Initial CAM values
VR(end_pos)=15
current_end_pos=VR(end_pos)
FOR i=0 TO 999
 TABLE(i, VR(end_pos)*(1-COS(2*PI*i/999))/2)
NEXT i
...
loop:
IF VR(end_pos)<>current_end_pos THEN
'Recalculate the CAM Table
 FOR i=0 TO 999
 TABLE(i, VR(end_pos)*(1-COS(2*PI*i/999))/2)
 NEXT i
 current_end_pos=VR(end_pos)
ENDIF
...
GOTO loop
```

The **VR(end\_pos)** value can be changed from some other program or externally from another controller using FINS messaging. In this case, the **CAM** table must be recalculated.

The creation of the CAM table is complete. The initialization of the desired axis and system parameters for tracing is:

```
'Initializations
FOR i=0 TO 1
 BASE(i)
 ATYPE=40
 UNITS=8192
 REP_DIST=20
 REP_OPTION=1
 FE_LIMIT=1
 DRIVE_CONTROL=11
 SPEED=8
 ACCEL=50
 DECEL=50
 DEFPOS(0)
 SERVO=ON
 CANCEL
NEXT i
WDOG=ON
BASE(1)
'Scope settings:
```

```

'1 sample each 2 servo cycles
'Information stored in TABLE(1000) to TABLE(4999)
'Because we capture 4 channels, we have 1000 samples per
channel.
'MPOS AXIS(0) is stored in TABLE(1000) to TABLE(1999)
'DPOS AXIS(1) is stored in TABLE(2000) to TABLE(2999)
'Torque reference for AXIS(1) is stored in
'TABLE(3000) to TABLE(3999)
'MSPEED AXIS(1) is stored in TABLE(4000) to TABLE(4999)
'The capture covers 1000 samples * 2ms / sample = 2seconds
SCOPE(ON,2,1000,4999,MPOS
AXIS(0),DPOS,DRIVE_MONITOR,MSPEED)
FORWARD AXIS(0) 'Move the master axis forward
TRIGGER 'Start tracing and storing of parameters
WHILE NOT MOTION_ERROR
 'Cambox that will start in AXIS(0) position 1
 CAMBOX(0,999,UNITS,10,0,2,1)
 WAIT UNTIL MPOS AXIS(0)<1
 'The capture will start when the master axis is in
 'a position Between 0 and 1. Additional conditions
 'are:
 '- The previous capture has finished
 '(SCOPE_POS=1000)
 '- We have the permission (VR(activate_trigger)=ON)
 IF SCOPE_POS=1000 AND VR(activate_trigger)=ON THEN
 TRIGGER
 PRINT "Triggered"
 ENDIF
 WAIT IDLE
WEND
HALT

```

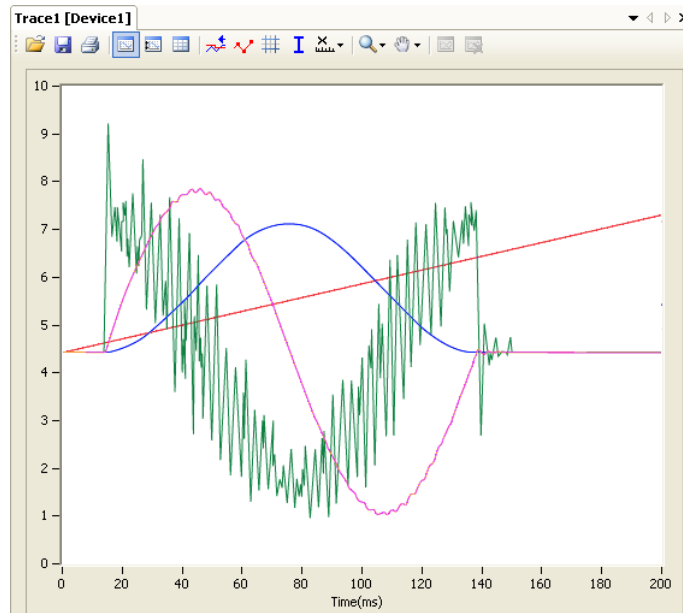

The result is given in the figure.

In the example given above, the value of the **UNITS** parameter is set to encoder counts. The position of the master axis **MPOS AXIS(0)** is given in red. The position increases linearly, because the speed of the master axis is constant.

The demanded position of the slave axis **DPOS AXIS(1)** is given in blue. This graph is a cosine curve. It corresponds to the created CAM table.

The measured speed of the slave axis **MSPEED AXIS(1)** is given in yellow. This graph is a sinusoidal curve, because the speed is a derivative of the position, and the derivative of the cosine is the sine. At high speeds, there are some ripples.

The green graph is the torque of the motor for the slave axis set with **DRIVE\_COMMAND=11** as a percentage of the nominal torque. The torque is proportional to the acceleration. Because the acceleration is a derivative of the speed and the speed is sinusoidal curve, the acceleration (and also the torque) is a cosine curve. There is one peak at the start and another peak at the stop because there is a discontinuity in the acceleration. There is also a high frequency oscillation in the torque curve, suggesting a resonance frequency that can be eliminated using the notch filter settings in the Sigma-II Servo Driver. The high frequency is reinforced, because it is also reflected in the speed curve. For more information on notch-filter settings, refer to the Sigma-II Servo Driver manual.

#### 5-1-7-4 Troubleshooting with the oscilloscope

When the desired data is captured and recorded into the Table memory entries, you can use the oscilloscope to visualize this data. This can help you when you commission and troubleshoot the system. This section gives an example of how a bug, which is difficult to analyze, can be clearly explained and solved using the captured data and the oscilloscope.

The parameter **end\_pos**, which defines the values in the CAM table, depends on external conditions of the system. Therefore a program that runs in another task or even a controlling device using FINS communication, can change it while the main program that links two axis runs. Suppose that these changes in conditions, which result in a change of the **end\_pos** parameter, happen most of the time when the axes are not linked, i.e. when the **CAMBOX** command is not executed. Suppose furthermore that very rarely the condition changes when the axes are linked. The change of the **end\_pos** parameter triggers the recalculation of the CAM table while the **CAMBOX** command is executed. The consequence is that the part of the demanded position of the slave axis follows the profile before the change, and the other part follows the profile after the change. In the end this leads to a discontinuation of the profile, which causes an indefinite speed of the axis and ends up with this error: the WDOG goes off, and all axes stop.

The scenario above is hard to analyze when you do not know what happens. The only thing that the user sees is that the slave axis has an error once every few hours or even less often. But the oscilloscope can clearly show where the problem is. In order to be able to use the oscilloscope, all desired parameters must be captured at the time of an error. This can be achieved by arranging the application programs in a certain way. The good programming practice suggests to have a separate start-up program that is set to run automatically on power-up of the system and checks the integrity of the system, whether all the expected slaves are connected and initialized. For an example of a start-up program see section 5-1-1. It is recommended to let the start-up program, when it is finished, start only one program that takes care of the safety and



integrity of the application and execution of all other application programs. This program is usually referred to as a SHELL program. For more information on designing a SHELL program, see section 5-2-1.

Suppose that program is designed in a way the it contains a following fraction of code:

```
'When there is an error, we stop all programs. No new
'oscilloscope captures are done. And we have stored in
'the selected TABLES the last data trace in which the
'error has occurred. Therefore, we can recover this
'trace and analyze it.
loop:
 IF MOTION_ERROR<>0 THEN HALT
GOTO loop
```

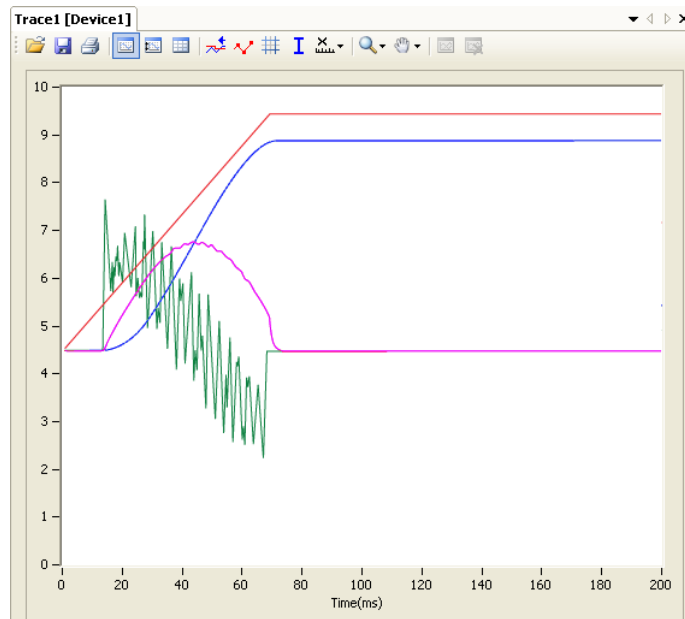

This programming code causes all the programs and tracing to stop when an error happens on any axis. The data is already captured in the Table memory, and we can start using the oscilloscope to see the status of the desired parameters at the moment the error occurred.

The measured position of the master axis, given in red, does not seem to be the cause, because there is no discontinuity on it. We discard a mechanical problem as well, because the torque, given in green, has low values. An the moment of the problem the speed of the slave axis, given in yellow, was smooth and low, therefore this is no problem either.

The next step is to analyze the CAM table, to see which values were used for demanding the position of the slave axis. To do that, we change the data trace to show a block of values from Table(0) to Table(999) in red, because these entries are where the CAM table is created (see the part of the program that creates the CAM table above). The changed configuration is shown in the figure.

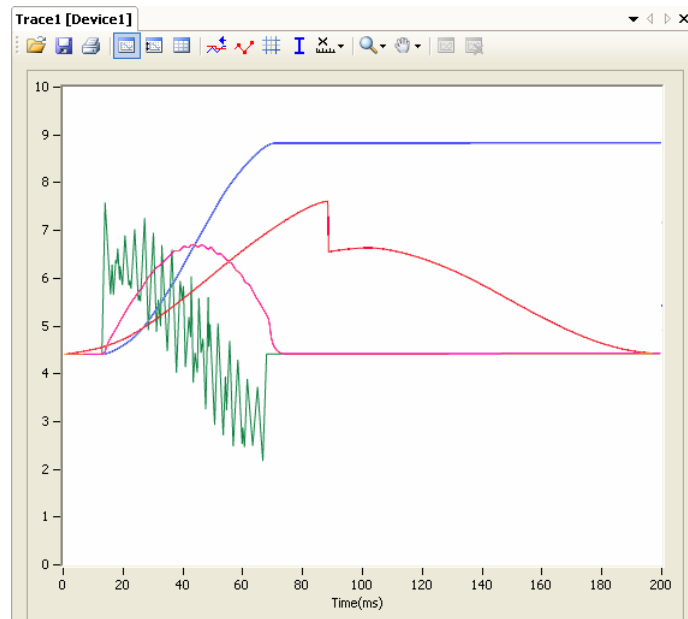

The result is given in the figure. The red graph clearly shows a discontinuity in the position values that the slave axis must follow. Because the speed is a derivative of the position, at the point of discontinuity of the position curve the speed gets a high value. (This value equals infinity in theory, in practice the value is just very big). This causes the error. The red graph shows where the root of the problem is. The amplitude of the cosine curve, and therefore the **end\_pos** parameter, has been changed during the execution of the **CAMBOX** command. The solution is simple: A change of the **end\_pos** parameter during **CAMBOX** execution must be prevented. To do this, either modify the programs in Trajexia, or in some other controller (if the parameter is changed outside of the scope of the application programs, for example by a FINS message).

**Note**

The time base of the CAM TABLE points is not the same as the capture of the other signals. The discontinuity in the CAM (red graph) coincides in time with the interruption of the movement. To analyze this, check the position values individually with a spreadsheet program. To analyze the point values in detail, you can export the TABLE points to a spreadsheet program for a more complex analysis.

## 5-2 Practical examples

### 5-2-1 SHELL program

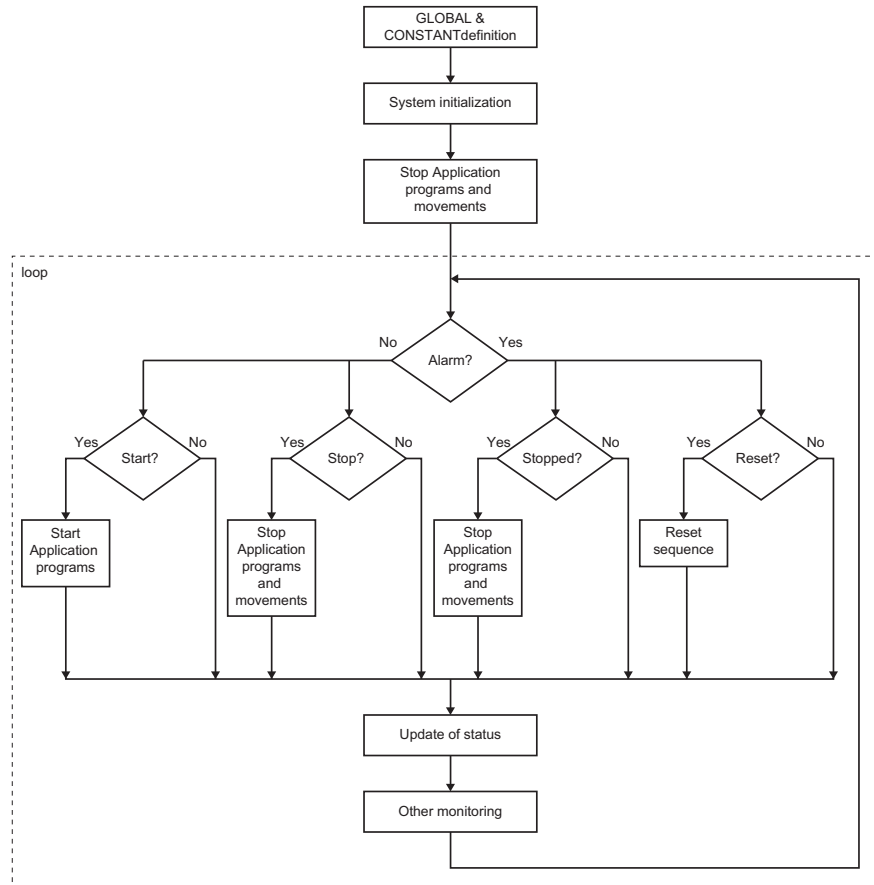

Good programming practice requires a good SHELL program. A SHELL program starts, stops and resets the application programs. The SHELL program is not necessary, but gives structure to the applications and makes the method to program the motion controller more effective.

The purpose of the SHELL program is to ensure the proper initialization of your system and the integrity of your machine. The example in the next section can be used as a template and can be modified if required.

A SHELL program needs to ensure the next operations:

- the declaration of constants and global variables
- the correct initialization of the system by checking if the correct hardware is used and by initializing all necessary parameters in the drives and controller
- the error handling to start, stop and reset the application programs and to report the status to the user.

### 5-2-1-1 SHELL programs and Trajexia Studio

Trajexia Studio helps the user to create a proper SHELL program.

When a new project is created, a SHELL program with the basic structure is created automatically (see 5-1-1).

When you define the hardware and set the parameters for the application, you can select to add your changes to the SHELL program so, the user do not have to type it manually.

Use the example SHELL program as a template to start, stop and reset your machine and adjust the rest of the SHELL program according to the requirements.

The SHELL program is automatically selected to start at POWER-ON in low-priority task 1.

### 5-2-2 SHELL program example

The example program below is a typical SHELL program created by Trajexia studio.

```

=====
'This SHELL program is an example that OMRON provide as
'recommended. This program should be modified for the
'particular user application.
=====

'Reserved symbol area for SHELL program handling.
'Do not use these areas in your application programs:

'VR(900) - "status_word" reports about the status of the
'system
' =0 during initialization
' =1 application stopped with no error
' =2 errors in the system
' =3 application running

'VR(901) - VR(status_bits) reports next status
' Bit0 Alarm flag
' Bit15 ML communication error with one slave

'VR(902) - "action" send messages to the upper controller
' =0 during initialization
' =1 Push RESET to restart
' =2 Resetting
' =3 System healthy

'VR(903) - VR(diag01) gives feedback of the MECHATROLINK
'initialisation
' Bit0 Could not get the ML slave number
' Bit1 Slave number is uncorrect
' Bit15 Detection OK

'VR(904) - VR(diag02) gives feedback of the MECHATROLINK
'Slaves
' Bitn Slave n not detected

'VR(905) - VR(diag03) gives feedback forUnit detection
' Bitn Unit n detected

```

```
'VR(906) - VR(system01) used in system detection

'VR(907) - VR(signal_state) gives feedback on signal state

'VR(908) - "sys_error" system error detected

'VR(909) - "first_error" gives the axis number causing a
'motion error

'VR(910,912 ... 940) - VR(servo_status+axis_n*2) stores
'AXISSTATUS to report
'
' to upper controller

'VR(911,913 ... 941) - VR(servo_alarm+axis_n*2) stores the
'alarm code of
'
' the servo

'Omron Auto Generated - Symbols
'Warning: Automated code section - any manual code changes
will be lost.
```

**First action is to declare the GLOBAL variables and CONSTANTS and make other initialization**

```
'Omron Auto Generated - Globals
GLOBAL "length",0
GLOBAL "lot_n",1
GLOBAL "product_type",2
GLOBAL "machine_speed",3
GLOBAL "status_word",900 'SHELL
GLOBAL "action",902 'SHELL
GLOBAL "sys_error",908 'SHELL
GLOBAL "first_error",909 'SHELL

'Omron Auto Generated - Constants
CONSTANT "max_axis",15 'SHELL
CONSTANT "status_bits",901 'SHELL
CONSTANT "diag01",903 'SHELL
CONSTANT "diag02",904 'SHELL
CONSTANT "diag03",905 'SHELL
CONSTANT "system01",906 'SHELL
CONSTANT "signal_state",907 'SHELL
CONSTANT "servo_status",910 'SHELL
CONSTANT "servo_alarm",911 'SHELL

'ETHERNET Settings
ETHERNET(1,-1,12,9600) 'FINS port number
ETHERNET(1,-1,7,0) 'Modbus TCP Mode
ETHERNET(1,-1,9,0) 'Modbus TCP Data Configuration

'Omron Auto Generated - CAM TABLE

'Omron Auto Generated - Symbols End

'Omron Auto Generated - Local Variables
alarm_bit=0
```

```

i=0 'Servo Parameters
res=0 'Servo Parameters
res_act=0
res_ant=0
res_bit=0
run_act=0
run_ant=0
run_bit=0
stop_act=0
stop_ant=0
stop_bit=0
'Omron Auto Generated - Local Variables End

```

```
VR(signal_state) = 0
```

**This subroutine tests whether the detected hardware is the expected one or not. If the right hardware is detected, it sets the right values to the axes and servo drives**

```

At least the right system needs to be properly detected
'once
GOSUB system_detection

```

**This subroutine stops all possible running programs and movements.**

```

'Stop all potential programs movements
GOSUB stop_all

status_word=1

```

**The main loop of the program handles the fault handling: run application programs, stop application programs, reset the system and report the status.**

```

loop:

 IF alarm_bit THEN
 action=1 ' Alarm, push RESET to restart

 IF status_word<>2 THEN
 PRINT "Stop with Alarm"
 GOSUB stop_all
 status_word=2 'Programs stopped with error
 ENDIF

 IF res_bit=1 THEN
 action=2 'Resetting
 PRINT "Resetting"
 GOSUB reset_all
 status_word=1 'Programs stopped NO error
 ENDIF
 ELSE
 action=3 'OK

 IF run_bit=1 THEN
 PRINT "Start application"

```

```

 GOSUB start_app
 status_word=3 'Application running
 ENDIF

 IF stop_bit=1 AND status_word=3 THEN
 PRINT "Stop by command"
 GOSUB stop_all
 status_word=1
 ENDIF
ENDIF

'Evaluates rising edge in RUN, STOP & RESET bits
GOSUB sequence

'Checks for alarms in the system and monitors the
'system status
GOSUB alarm_sequence

'Upgrade values for showing in the HMI & PLC
GOSUB monitoring

'Reports and reset warnings in servodrive
GOSUB warning_seq

GOTO loop

'-----
sequence:

'Define here your signals to STOP/START/RESET

'This example uses the following signals:
'Rising edge of bit 0 of VR(signal_state) as RUN signal
'Rising edge of bit 1 of VR(signal_state) as STOP signal
'Rising edge of bit 2 of VR(signal_state) as RESET signal

'RUN
run_ant=run_act
run_act=READ_BIT(0,signal_state)
run_bit=run_act AND NOT run_ant

'STOP
stop_ant=stop_act
stop_act=READ_BIT(1,signal_state)
stop_bit=stop_act AND NOT stop_ant

'RESET
res_ant=res_act
res_act=READ_BIT(2,signal_state)
res_bit=res_act AND NOT res_ant

RETURN

'-----

```

```

alarm_sequence:

'Alarm notification
IF SYSTEM_ERROR=0 AND MOTION_ERROR=0 AND
READ_BIT(15,diag01)=1 THEN
 alarm_bit=0
ELSE
 IF MOTION_ERROR<>0 THEN
 SET_BIT(0,status_bits) 'Motion error flag
 first_error=ERROR_AXIS
 ENDIF
 alarm_bit=1
ENDIF

'MECHATROLINK axis alarm monitoring
FOR i=0 TO max_axis
 BASE(i)
 VR(servo_status+i*2)=AXISSTATUS
 'if stopped by alarm, notify the alarm code
 IF ATYPE>=40 AND ATYPE<=42 THEN
 IF status_word=2 THEN
 'if no response, notify "communication alarm"
 IF (AXISSTATUS AND 4)<>0 THEN
 VR(servo_alarm+i*2)=$E6
 ELSEIF NOT DRIVE_ALARM(servo_alarm+i*2) THEN
 VR(servo_alarm+i*2)=$E6
 ELSEIF VR(servo_alarm+i*2)=0 THEN
 VR(servo_alarm+i*2)=$bb
 ENDIF
 'if no alarm, notify RUN=$99 or BaseBlock=$BB
 ELSEIF(DRIVE_STATUS AND 8) THEN
 VR(servo_alarm+i*2)=$99
 ELSE
 VR(servo_alarm+i*2)=$bb
 ENDIF
 ENDIF
 ENDIF
NEXT i

 sys_error=SYSTEM_ERROR
RETURN

'-----

stop_all:

'In this example, if the application program is stopped
'suddenly all the movements are cancelled and all the axes
'are set to BaseBlock. Modify this section if you require
'a different STOP procedure

STOP "APPLICATION"
WDOG=0

FOR i= 0 TO max_axis
 BASE(i)
 IF MARK=0 THEN REGIST(-1)

```



```

 AXIS_ENABLE=0
 SERVO=0
 CANCEL(1) 'Cancel NTYPE
 WA(1)
 CANCEL(1) 'Cancel possible program buffer
NEXT i

RAPIDSTOP 'Cancel MTYPE
RETURN

'-----

start_app:

'Add all the application programs that should be started
'with the START signal

RUN "APPLICATION"

RETURN

'-----

reset_all:

'Uncorrect system setting
IF READ_BIT(15,diag01)=0 THEN GOSUB system_detection

'MECHATROLINK axes reset sequence
FOR i=0 TO max_axis
 BASE(i)
 IF ATYPE>=40 AND ATYPE<=42 THEN
 'Reset sequence for MECHATROLINK communication error
 IF (AXISSTATUS AND 4)<>0 THEN
 PRINT "Resetting ML alarm"
 GOSUB system_detection
 ENDIF
 'Reset sequence for DRIVE errors
 IF (AXISSTATUS AND 8)<>0 THEN
 IF VR(servo_alarm+i*2)=$81 OR
VR(servo_alarm+i*2)=$CC THEN
 GOSUB absencoder
 ELSE
 'Pending to handle diferently those alarms that cannot
 'be resetted with DRIVE_CLEAR
 DRIVE_CLEAR
 ENDIF
 ENDIF
 ENDIF
NEXT i

'Reset sequence for AXIS error
DATUM(0)
CLEAR_BIT(0,status_bits)

'MECHATROLINK devices reset sequence

```

```
IF (SYSTEM_ERROR AND $40000)<>0 THEN

'Omron Auto Generated - ML IO
'Warning: Automated code section - any manual code changes
'will be lost.

'Omron Auto Generated - ML IO End

 'Same with the other IO devices
ELSEIF SYSTEM_ERROR<>0 THEN
 'Other system error needs initialisation of the system
 EX
ENDIF

RETURN

'-----

warning_seq:

IF READ_BIT(15,diag01) THEN
 'Clear servodrive warning if any
 IF res_bit=1 THEN
 FOR i=0 TO max_axis
 BASE(i)
 IF ATYPE>=40 AND ATYPE<=42 THEN
 IF (DRIVE_STATUS AND 2)>0 THEN DRIVE_CLEAR
 ENDIF
 NEXT i
 ENDIF
ENDIF

RETURN

'-----

monitoring:

'Add monitoring depending on the application
RETURN

'-----

absencoder:
'To be implemented in the future
RETURN

'-----

system_detection:

status_word=0
action=0
VR(status_bits)=0
```

```
'Omron Auto Generated - Units
'Warning: Automated code section - any manual code changes
'will be lost.

'Unit Variables reset
VR(diag01)=0
VR(diag02)=0
VR(diag03)=0
VR(system01)=0

'Unit Detection
' ML04 Unit
IF COMMSTYPE SLOT(0) <> 36 THEN
 PRINT "Error Comms Type for unit 0 is not ML04"
 SET_BIT(0,diag03)
ENDIF

' FL Unit
IF COMMSTYPE SLOT(1) <> 33 THEN
 PRINT "Error Comms Type for unit 1 is not FL"
 SET_BIT(1,diag03)
ENDIF

'Start Mechatrolink Section

'MECHATROLINK device detection for ML04 unit 0
IF READ_BIT(0,diag03) = 0 THEN
 'Initialise Mechatrolink
 MECHATROLINK(0,0)

 ' Device count
 IF NOT MECHATROLINK(0,3,system01) THEN
 PRINT "Error getting device count for ML04 unit 0"
 SET_BIT(0,diag01)
 ELSEIF VR(system01) <> 2 THEN
 PRINT "Incorrect device count for ML04 unit 0"
 SET_BIT(1,diag01)
 ENDIF

 ' Check SJDE-02ANA-OY address
 IF NOT MECHATROLINK(0,4,0,system01) THEN
 PRINT "Error getting address for ML04 unit 0, station 0"
 SET_BIT(0,diag02)
 ELSEIF VR(system01) <> $43 THEN
 PRINT "Incorrect address for ML04 unit 0, station 0"
 SET_BIT(0,diag02)
 ENDIF

 ' Check SJDE-02ANA-OY address
 IF NOT MECHATROLINK(0,4,1,system01) THEN
 PRINT "Error getting address for ML04 unit 0, station 1"
 SET_BIT(1,diag02)
 ELSEIF VR(system01) <> $44 THEN
 PRINT "Incorrect address for ML04 unit 0, station 1"
 SET_BIT(1,diag02)
 ENDIF
```

```

ENDIF

'Stop Mechatrolink Section

'Detection OK
IF VR(diag01)=0 AND VR(diag02)=0 AND VR(diag03)=0 THEN
SET_BIT(15,diag01)

'Invert input channels
INVERT_IN(16,OFF) 'POT
INVERT_IN(17,OFF) 'NOT

'Omron Auto Generated - Units End

'Start Standard Section

IF READ_BIT(15,diag01)=1 THEN

'Drive Parameters

BASE(2)
'Parameter data param_n/param_v/mask/size
TABLE(0,$20E,32,$FFFFFF,4)
TABLE(4,$210,45,$FFFFFF,4)
TABLE(8,$515,$800,$FFF0FF,2)
TABLE(12,-1)
MECHATROLINK(0,20,$43) 'SJDE-02ANA-OY
REGIST(-1)
VR(system01)=0
i=0
res=0
WHILE TABLE(i)<>-1
 IF NOT DRIVE_READ(TABLE(i),TABLE(i+3),system01) THEN
 SET_BIT(0,diag02)
 ELSE
 IF TABLE(i+2)=$FFFFFF THEN
 IF VR(system01)<>TABLE(i+1) THEN
 IF NOT DRIVE_WRITE(TABLE(i),TABLE(i+3),TABLE(i+1),1) THEN
 SET_BIT(1,diag02)
 ELSE
 res=1
 ENDIF
 ENDIF
 ELSE 'Parameter set using Mask
 IF (VR(system01) AND NOT TABLE(i+2))<>TABLE(i+1) THEN
 VR(system01)=(VR(system01) AND TABLE(i+2)) OR TABLE(i+1)
 IF NOT DRIVE_WRITE(TABLE(i),TABLE(i+3),VR(system01),1)
 THEN
 SET_BIT(1,diag02)
 ELSE
 res=1
 ENDIF
 ENDIF
 ENDIF
ENDIF
ENDIF
ENDIF

```

```

 i=i+4
WEND
'Reset drive if necessary
IF res=1 THEN
 IF NOT DRIVE_RESET THEN SET_BIT(0,diag02)
ENDIF

BASE(3)
'Parameter data param_n/param_v/mask/size
TABLE(0,$20E,32,$FFFFFF,4)
TABLE(4,$210,45,$FFFFFF,4)
TABLE(8,$50A,$8000,$FF0FFF,2)
TABLE(12,$50B,$8,$FFFFFF0,2)
TABLE(16,$515,$800,$FFF0FF,2)
TABLE(20,-1)
MECHATROLINK(0,20,$44) 'SJDE-02ANA-OY
REGIST(-1)
VR(system01)=0
i=0
res=0
WHILE TABLE(i)<>-1
 IF NOT DRIVE_READ(TABLE(i),TABLE(i+3),system01) THEN
 SET_BIT(0,diag02)
 ELSE
 IF TABLE(i+2)=$FFFFFF THEN
 IF VR(system01)<>TABLE(i+1) THEN
 IF NOT DRIVE_WRITE(TABLE(i),TABLE(i+3),TABLE(i+1),1) THEN
 SET_BIT(1,diag02)
 ELSE
 res=1
 ENDIF
 ENDIF
 ELSE 'Parameter set using Mask
 IF (VR(system01) AND NOT TABLE(i+2))<>TABLE(i+1) THEN
 VR(system01)=(VR(system01) AND TABLE(i+2)) OR TABLE(i+1)
 IF NOT DRIVE_WRITE(TABLE(i),TABLE(i+3),VR(system01),1)
 THEN
 SET_BIT(1,diag02)
 ELSE
 res=1
 ENDIF
 ENDIF
 ENDIF
 ENDIF
 i=i+4
WEND
'Reset drive if necessary
IF res=1 THEN
 IF NOT DRIVE_RESET THEN SET_BIT(0,diag02)
ENDIF

' Axis Parameters

BASE(0) 'Axis Name: Flex00
ATYPE=44 'Axis Type: Flexible_Servo
UNITS=1024.0000

```

```
REP_DIST=5000000.0000
REP_OPTION=0
ERRORMASK=268
AXIS_ENABLE=0
DRIVE_CONTROL=0
P_GAIN=1.0000
I_GAIN=0.0000
D_GAIN=0.0000
OV_GAIN=0.0000
VFF_GAIN=0.0000
SPEED=50.0000
ACCEL=100.0000
DECEL=100.0000
CREEP=100.0000
JOGSPEED=100.0000
FE_LIMIT=10.0000
SERVO=0
FWD_IN=-1.0000
REV_IN=-1.0000
DATUM_IN=-1.0000
FHOLD_IN=-1.0000
FS_LIMIT=20000000.0000
RS_LIMIT=-20000000.0000
FASTDEC=0.0000
FHSPEED=1000.0000
OUTLIMIT=1.0000
FE_RANGE=0.0000
DAC=0.0000
```

```
BASE(1) 'Axis Name: Flex01
ATYPE=44 'Axis Type: Flexible_Servo
UNITS=1024.0000
REP_DIST=5000000.0000
REP_OPTION=0
ERRORMASK=268
AXIS_ENABLE=0
DRIVE_CONTROL=0
P_GAIN=1.0000
I_GAIN=0.0000
D_GAIN=0.0000
OV_GAIN=0.0000
VFF_GAIN=0.0000
SPEED=50.0000
ACCEL=100.0000
DECEL=100.0000
CREEP=100.0000
JOGSPEED=100.0000
FE_LIMIT=10.0000
SERVO=0
FWD_IN=-1.0000
REV_IN=-1.0000
DATUM_IN=-1.0000
FHOLD_IN=-1.0000
FS_LIMIT=20000000.0000
RS_LIMIT=-20000000.0000
```

```
FASTDEC=0.0000
FHSPEED=1000.0000
OUTLIMIT=1.0000
FE_RANGE=0.0000
DAC=0.0000
```

```
BASE(2) 'Axis Name: Down
ATYPE=40 'Axis Type: Mechatro_Position
UNITS=32.0000
REP_DIST=360000.0000
REP_OPTION=0
ERRORMASK=268
AXIS_ENABLE=0
DRIVE_CONTROL=0
SPEED=3600.0000
ACCEL=36000.0000
DECEL=36000.0000
CREEP=100.0000
JOGSPEED=100.0000
FE_LIMIT=90.0000
SERVO=0
FWD_IN=16.0000
REV_IN=17.0000
DATUM_IN=-1.0000
FHOLD_IN=-1.0000
FS_LIMIT=20000000.0000
RS_LIMIT=-20000000.0000
FASTDEC=0.0000
FHSPEED=1000.0000
OUTLIMIT=1.0000
FE_RANGE=0.0000
```

```
BASE(3) 'Axis Name: Up
ATYPE=40 'Axis Type: Mechatro_Position
UNITS=32.0000
REP_DIST=360.0000
REP_OPTION=1
ERRORMASK=268
AXIS_ENABLE=0
DRIVE_CONTROL=0
SPEED=3600.0000
ACCEL=36000.0000
DECEL=36000.0000
CREEP=100.0000
JOGSPEED=100.0000
FE_LIMIT=90.0000
SERVO=0
FWD_IN=-1.0000
REV_IN=-1.0000
DATUM_IN=-1.0000
FHOLD_IN=-1.0000
FS_LIMIT=20000000.0000
RS_LIMIT=-20000000.0000
FASTDEC=0.0000
```

```

FHSPEED=1000.0000
OUTLIMIT=1.0000
FE_RANGE=0.0000

ENDIF

' Variables

' TABLE DATA

'Stop Standard Section

RETURN

```

### 5-2-3 Initialization program

The Initialization program sets the parameters for the axes. These parameters are dependant upon the Motor Encoder resolution and the motor maximum speed.

**Note** Refer to the Servo Driver and the motor data sheet for this information.

```

'=====
'EXAMPLE OF INITIALIZATION PROGRAM
'THIS VERSION IS DESIGNED FOR MECHATROLINK-II SERVOS
'ADAPT THIS PROGRAM ACCORDING TO YOUR APPLICATION
'=====
BASE(x)
restart=0
inertia_ratio=set_load_inertia_ratio

'-----
'EXAMPLE 1
'SGMAH-01AAA61D-OY motor data
'-----
enc_resolution=2^13 '13 bit encoder
max_speed=5000 '5000 rpm max. speed

'-----
'EXAMPLE 2
'SGMAH-01A1A61D-OY motor data
'-----
enc_resolution=2^16 '16 bit encoder
max_speed=5000 '5000 rpm max. speed

'-----
'WRITE PARAMETERS IN THE SERVO
'-----
DRIVE_WRITE($103,2,inertia_ratio) 'Write inertia ratio
DRIVE_READ($110,2,10)
IF VR(10)<>$0012 THEN
 DRIVE_WRITE($110,2,$0012,1)
 'Pn110=0012h (autotuning disabled)
 restart=1
ENDIF
DRIVE_READ($202,2,10)
IF VR(10)<>1 THEN

```



```

DRIVE_WRITE($202,2,1,1)
'Pn202=1 (gear ratio numerator in the drive. Default
'is 4)
restart=1
ENDIF
DRIVE_READ($511,2,10)
IF VR(10)<>$6548 THEN
DRIVE_WRITE($511,2,$6548,1)
'Pn511 set the registration inputs in the Servo Driver
restart=1
ENDIF
DRIVE_READ($81E,2,10)
IF VR(10)<>$4321 THEN
DRIVE_WRITE($81E,2,$4321,1)
'Pn81E=$4321 To make the Digital inputs in the Servo
Driver
'available for reading through DRIVE_INPUTS word
restart=1
ENDIF
IF restart=1 THEN DRIVE_RESET

'-----
'Initial gains For MECHATROLINK_SPEED
'-----
'By experience this setting is a good starting point
P_GAIN=INT(214748.3648*max_speed/enc_resolution)
'This is the optimum value. Set if needed
VFF_GAIN=INT(60000*1073741824/enc_resolution/max_speed)

'-----
'Initial gains For MECHATROLINK_POSITION mode
'-----
'Change the rigidity (Fn001) according to the mechanical
'system
'Change feedforward gain Pn109 if required

'-----
'Initial parameter of the AXIS
'-----
'If set to 1 (and Pn202=Pn203=1) the UNITS are
'encoder counts
UNITS=1
'Theoretical FE we will have running the motor
'at "max_speed"
'without VFF_GAIN in MECHATROLINK SPEED
FE_LIMIT=1073741824/P_GAIN/UNITS
'SPEED is set to 1/3 of "max_speed"
SPEED=(max_speed73)*enc_resolution/60/UNITS
'ACCEL in 200ms from 0 to "max_speed"
ACCEL=SPEED/0.2
'DECEL in 200ms from "max_speed" to 0
DECEL=SPEED/0.2

```

### 5-2-4 Single axis program

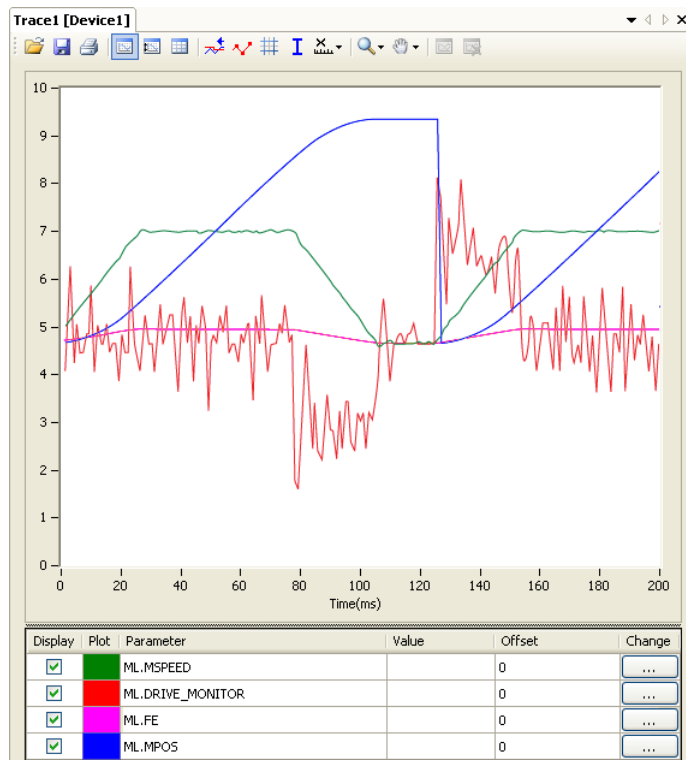

This program is a simple program to run one axis only.

#### 5-2-4-1 Example

```
'GOSUB homing
BASE (0)
DEFPOS (0)
WA (100)
loop:
 MOVE (1440)
 WAIT IDLE
 WA (100)
GOTO loop
```

The units are degrees in this example, therefore:

- 13-bit encoder
- Pn202=32
- Pn203=45
- **UNITS=32**

The graph in the figure is typical for this point-to-point movement with linear acceleration). Note the following:

- During linear acceleration, the graph of the position is parabolic (because the speed is a derivative of the position).
- During constant speed, the graph of the position is straight.
- During linear deceleration, the graph of the position is counter-parabolic.
- During stop, the graph of the position is constant.
- When an overflow occurs (**MPOS>=REP\_DIST**), the position jumps to 0 if **REP\_OPTION=1** or to **-REP\_DIST** if **REP\_OPTION=0**.

- The Following Error is proportional to the speed if you use only Proportional Gain in the position loop.
- The torque, which is given by **DRIVE\_MONITOR** as a percentage of the nominal torque of the motor when you set **DRIVE\_CONTROL=11**) is proportional to the acceleration according to the formula:

$$Torquetotal = Jtotal \times a + Torquefriction$$

where  $Torque_{friction}$  is usually small,  $a$  is the angular acceleration, and  $J$  the inertia of the system.

### 5-2-5 Position with product detection

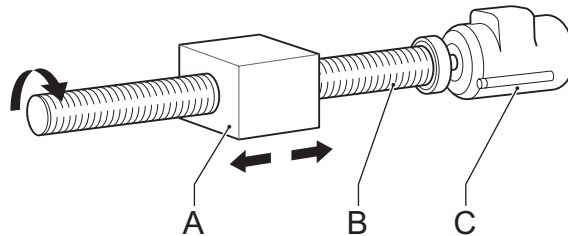

A ballscrew moves forward at a creep speed until it reaches a product, a microswitch (IN(2)) turns on. The ballscrew is stopped immediately, the position at which the product is sensed is indicated and the ballscrew returns at a rapid speed back to the start position.

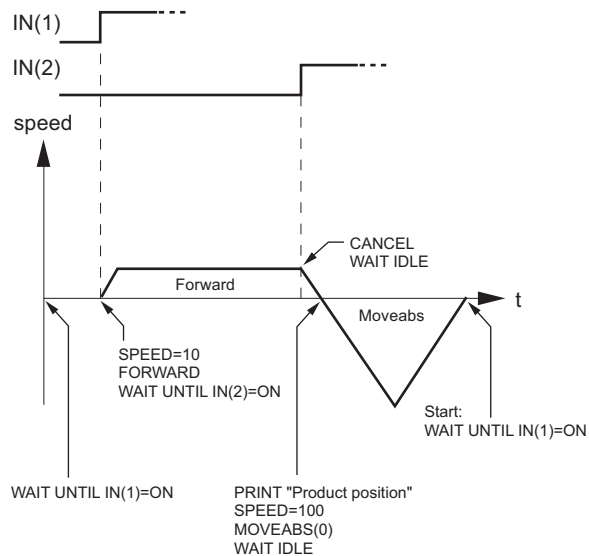

#### 5-2-5-1 Example

```
start:
 WAIT UNTIL IN(1)=ON
```

```
SPEED=10
FORWARD
WAIT UNTIL IN(2)=ON
prod_pos=MPOS
CANCEL
WAIT IDLE
PRINT "Product Position : "; prod_pos
SPEED=100
MOVEABS(0)
WAIT IDLE
GOTO start
```

### 5-2-6 Position on a grid

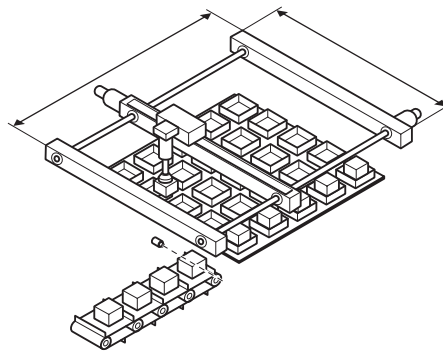

A square palette has sides 1m long. It is divided into a 5 x 5 grid, and each of the positions on the grid contains a box which must be filled using the same square pattern of 100mm by 100mm. A dispensing nozzle controlled by digital output 8 must be turned on when filling the box and off at all other times.

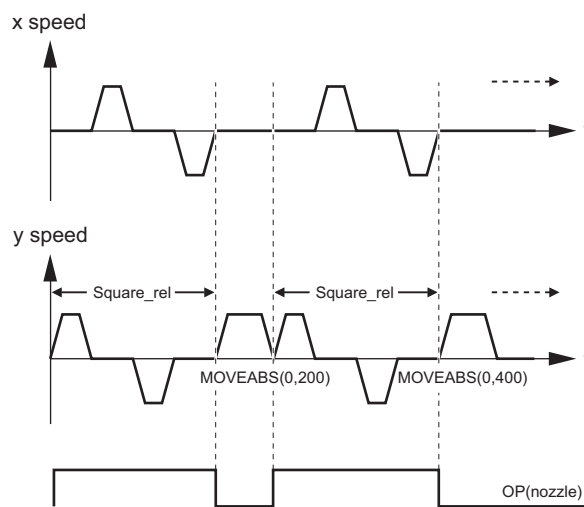
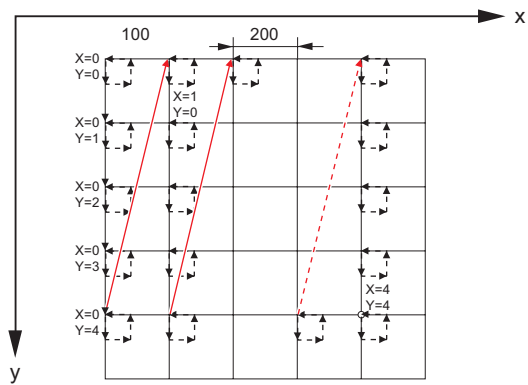

5-2-6-1 Example

```

nozzle = 8
start:
 FOR x = 0 TO 4
 FOR y = 0 TO 4
 MOVEABS(x*200, y*200)
 WAIT IDLE
 OP(nozzle, ON)
 GOSUB square_rel
 OP(nozzle, OFF)
 NEXT y
 NEXT x
GOTO start
square_rel:
 MOVE(0, 100)
 MOVE(100, 0)
 MOVE(0, -100)
 MOVE(-100,0)
 WAIT IDLE
 WA(1000)
RETURN

```

5-2-7 Bag feeder program

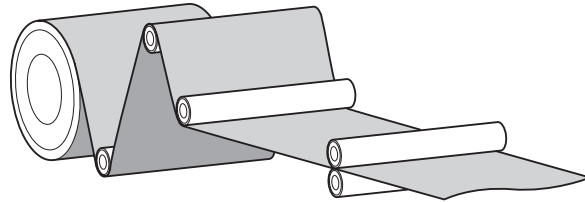

A bag feeder machine feeds plastic film a fixed distance that is set by the operator. The figure shows a typical bag feeder that is part of the machine.

Bag feeder machines have two modes.

- Without mark: Forward feeds the film a set distance, for films of a flat colour
- With mark: Forward feeds the film to a printed mark on the film.

The program in this section shows the typical code for a bag feeder machine.

5-2-7-1 Example

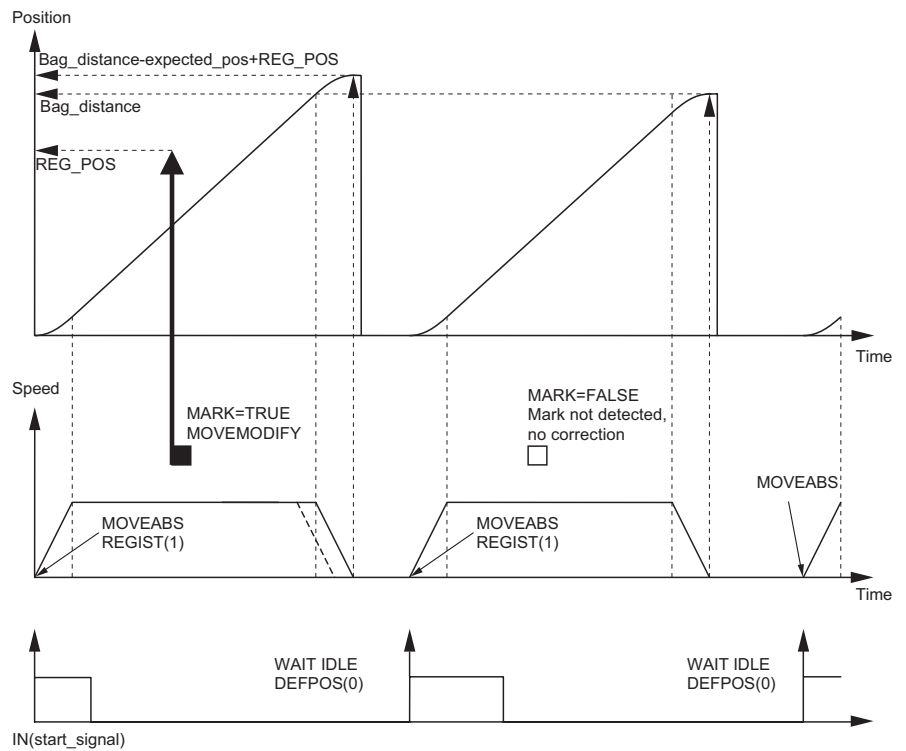

```
'-----
'BAG FEEDER program
```

```

'=====
'Working with marks, if any mark is missing, feed the
'theoretical distance. But if the mark is missing for
'a number of consecutive bags, stop the operation.
'A digital output is activated a certain time to cut
'the bag.
'=====

'Variable initialisation
start_signal=7
max_fail=3
program_alarm=0
failed=0
feeder_axis=2
BASE(feeder_axis)
'Position counter (MPOS,DPOS) goes from 0 to 999999
'and 0 again
UNITS=27
SPEED=100
ACCEL=1000
DECEL=1000
REP_DIST=1000000
REP_OPTION=1
SERVO=ON
WDOG=ON

'Main program
loop:
 'Define current position as zero
 DEFPOS(0)

 'Wait for rising edge in Digital Input
 "start_signal"
 WAIT UNTIL IN(start_signal)=0
 WAIT UNTIL IN(start_signal)=1

 'Move bag length
 MOVEABS(bag_distance)
 WAIT UNTIL MTYPE=2 'To verify that the MOVEABS is
'being executed

 'If we work with Mark, activate the trigger
 'MARK=FALSE when triggered and TRUE when not triggered
 IF work_with_mark AND MARK THEN
 REGIST(1)
 WAIT UNTIL MARK=0
 ENDIF

 'Wait until movement finished or mark detected
 WAIT UNTIL MTYPE=0 OR (MARK AND work_with_mark)

 'Working with mark
 IF work_with_mark THEN
 IF MARK THEN 'If the mark has been detected, the
'position is corrected
 MOVEMODIFY(bag_distance-expected_pos+REG_POS)

```

```

failed=0

ELSE 'If the mark has not been detected
PRINT "Mark not detected"
failed=failed+1
IF failed>max_fail THEN 'After several
'consecutive misdetection stop the application
PRINT "Mark definitely lost"
program_alarm=3
STOP
ENDIF
ENDIF
ENDIF

'Wait until the feed movement has finished
WAIT IDLE
GOTO loop

```

### 5-2-8 CAM table inside a program

It shows how to create a CAM table inside a program, and use the **CAMBOX** motion command.

The profile used is the COS square one. This is a quite typical profile for feeder-type applications as:

- The motion provides a smooth acceleration without sudden acceleration changes, so the material slip is minimized
- It gives a fast deceleration so the cycle time is reduced. During deceleration there is no material slip and the friction helps to the stop to zero.

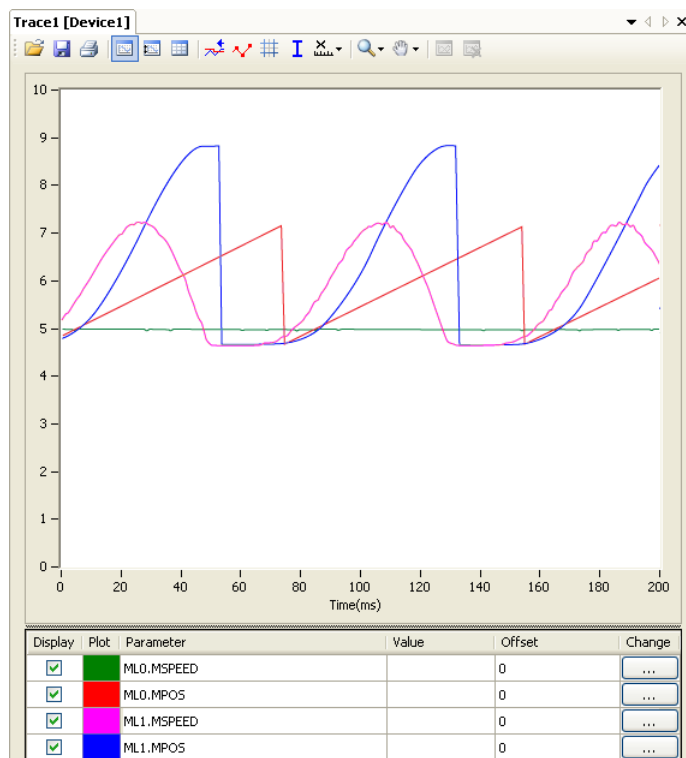



## 5-2-8-1 Example

```
start:
 GOSUB filltable
 WDOG=1 'Set servos to RUN
 BASE(1)
 SERVO=1 'Enable position loop in axis 1
 BASE(0)
 SERVO=1 'Enable position loop in axis 0
 'The position counter counts from 0 to 11999
 'and then back to 0 again
 REP_OPTION=1
 REP_DIST=12000
 SPEED=200
 FORWARD

BASE(1)
loop:
 CAMBOX(in_tbl,end_tbl,1,lnk_dst,master,opt,start)
 WAIT IDLE
GOTO loop

filltable:
 'The shape of the CAM is stored in TABLE(0) to
 'TABLE(360)
 npoints=360
 in_tbl=0
 end_tbl=in_tbl+npoints
 'Distance of the master to make the CAM
 lnk_dst=10000
 'Master axis
 master=0
 'The CAM start exactly when the master reaches
 'position "start"
 opt=2
 start=1000

 k=100
 'Fill the TABLE with the suitable waveform
 FOR i= in_tbl TO end_tbl
 TABLE(i, (k*(COS(PI*i/npoints)-1))^2)
 NEXT i
RETURN
```

5-2-9 Flying shear program

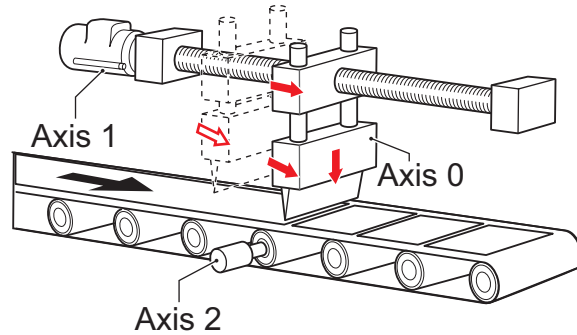

An example of the Flying shear program. In this application there are three axes:

- Axis 0, shear\_axis, the advancement of the shear.
- Axis 1, flying\_axis, is the flying shear.
- Axis 2, line\_axis, transports the material.

5-2-9-1 Example

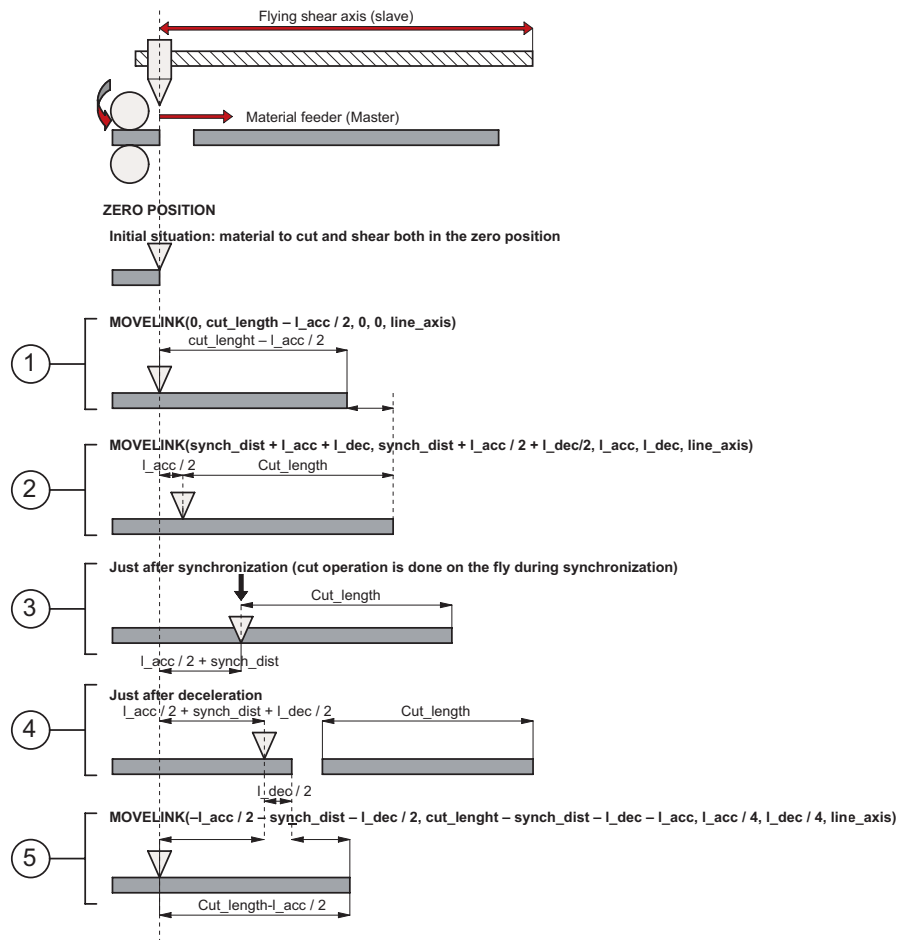

```

'FLYING SHEAR program
'=====
'Typical example of a flying shear application.
'One axis (line_axis) transport the material
'Second axis (flying_axis) is the flying shear itself
'Third axis (shear_axis) is the shear advancement
'The distance in synchronization must be long enough
'to allow the cut at maximum speed.
'The return of the flying shear is done at such a
'speed that the wait time is zero (optimization of
'the movement).
'Again it is assumed that everithing has been
'calculated to not exceed the maximum motor speed at
'maximum line speed
'=====
cut_counter=0
line_axis=2
shear_axis=0
flying_axis=1

SERVO AXIS(line_axis)=ON
SERVO AXIS(flying_axis)=ON
SERVO AXIS(shear_axis)=ON
WDOG=ON

'FIRST CYCLE

'Make a first material cut
MOVEABS(end_pos) AXIS(shear_axis)
WAIT UNTIL MTYPE AXIS(shear_axis)=2
WAIT IDLE AXIS(shear_axis)

'First time we have a certain wait time because the
'material has been just been cut
wait_distance=cut_lenght-l_acc/2
MOVELINK(0,wait_distance,0,0,line_axis) AXIS(flying_axis)
WAIT UNTIL MTYPE AXIS(flying_axis)=22

'We start the line
FORWARD AXIS(line_axis)

loop:

'Update the line speed every cycle
SPEED AXIS(line_axis)=line_speed

'Cutting movement at synchronized speed
line_cut=synch_dist+l_acc+l_dec
shear_cut=synch_dist+l_acc/2+l_dec/2
MOVELINK(shear_cut,line_cut,l_acc,l_dec,line_axis)
AXIS(flying_axis)
WAIT UNTIL MPOS AXIS(flying_axis)>l_acc/2

'Activate the shear when it is in synchronization with
'the line
'Slow speed to cut

```

```

SPEED AXIS(shear_axis)=cut_speed
MOVEABS(end_pos) AXIS(shear_axis)
MOVEABS(0) AXIS(shear_axis)
WAIT UNTIL NTYPE AXIS(shear_axis)=2
'Fast speed to return
WAIT LOADED AXIS(shear_axis)
SPEED AXIS(shear_axis)=return_speed

cut_counter=cut_counter+linch

'Return back synchronized with the master in
'such a way that there is no wait time
line_back=cut_length-synch_dist-l_dec-l_acc
shear_cut=l_acc/2+synch_dist+l_dec/2
MOVELINK(-shear_cut,line_back,l_acc/4,l_dec/
4,line_axis) AXIS(flying_axis)

GOTO loop

```

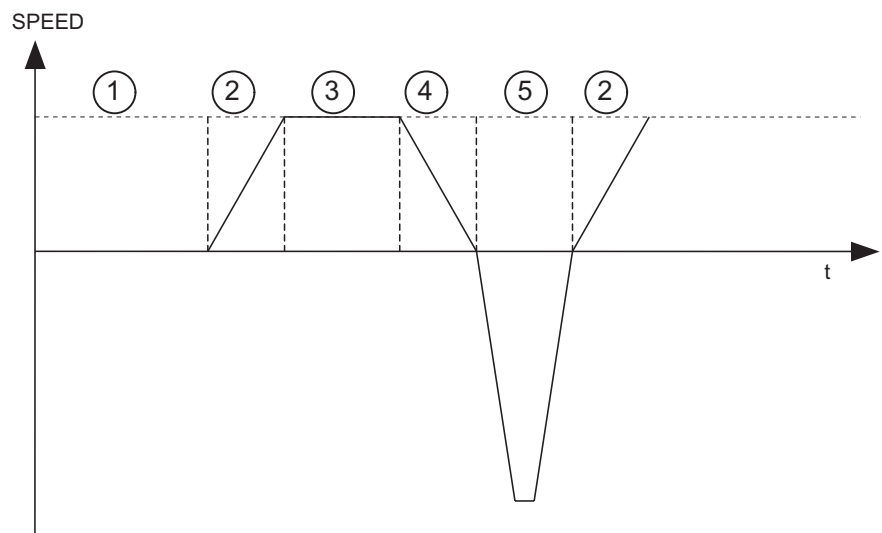

- The speed-time graph shows the steps of the above example. The steps are:
- 1 The initial cycle: the slave waits for the right length in the product to cut ( $cut\_length - distance\_to\_accelerate / 2$ ). It is necessary to divide  $distance\_to\_accelerate$  when we use the **MOVELINK** command, because when we synchronize, the master moves twice the distance of the slave.
  - 2 The slave accelerates to synchronize with the master. When the acceleration finishes, the relative distance between the edge of the product and the shear is  $cut\_length$ .
  - 3 This is the synchronization part: the relative distance between the edge of the product and the shear remains the same. The cut in the material is made. This gives a new material edge.
  - 4 The deceleration part: the material continues, and the shear stops.
  - 5 Move back at high speed: the distances are calculated such that when the slave reaches its original position, the edge of the product is in the correct position to start a new cut.

A new movement starts (step 2).

### 5-2-10 Correction program

This application is for a rotary labeller. The constants are:

- The product arrives on a conveyor (master axis) that runs at a constant speed.
- A rotary labeller that is synchronized 1:1 to the conveyor, attaches the labels.
- The distance between products is fixed and mechanically guaranteed.

The distance between labels is never exactly constant so, a correction is needed. This is done by superimposing a virtual axis onto the movement of the labeller.

The difference between the expected position and the actual position is measured with a photocell. This is the correction factor.

Every time a correction is made, the origin position is updated accordingly.

#### 5-2-10-1 Example

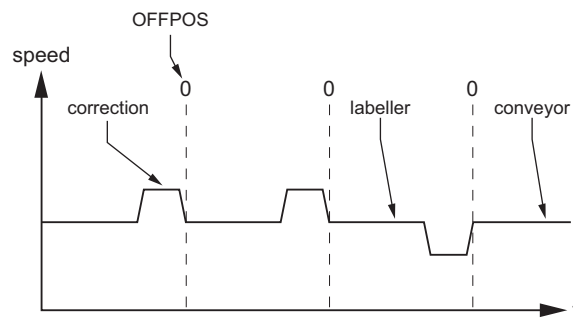

```

conveyor=0
labeller=1
virtual=15
SERVO AXIS(conveyor)=1
SERVO AXIS(labeller)=1
WDOG=1

BASE(labeller)
CONNECT(1,conveyor)
ADDAX(virtual)
FORWARD AXIS(conveyor)
REGIST(1)
WAIT UNTIL MARK=0

loop:
 WAIT UNTIL MARK
 correction=REG_POS+expected_pos
 MOVE(correction) AXIS(virtual)
 WAIT IDLE AXIS(virtual)
 OFFPOS=-label_length+correction
 REGIST(1)
 WAIT UNTIL MARK=0
GOTO loop

```

## **SECTION 6 Troubleshooting**

This section provides tables to refer to when a particular problem occurs. The tables provide a general description of the nature of various potential problems, the probable cause, items to check, and suggested countermeasures.

## 6-1 Items to Check First

If a problem occurs, investigate the problem after checking the following items first.

| Category                 | Items to check                                                                           |
|--------------------------|------------------------------------------------------------------------------------------|
| Installation environment | Is the environment dusty?                                                                |
|                          | Are there any conducting materials in the environment that could get into the equipment? |
|                          | Is the ambient temperature in a range shown in the unit specification?                   |
| Wiring                   | Is there excessive moisture (from humidity, water usage , etc.)?                         |
|                          | Are signal lines and power lines placed in separate ducts?                               |
|                          | Is the proper grounding provided?                                                        |
| Recent changes           | Is there too much electric noise and if so does the power supply have a noise filter?    |
|                          | Has there been changes to the system?                                                    |
|                          | Has there been changes to the system configuration?                                      |
|                          | Has there been changes to application (including programs)?                              |

## 6-2 Error Indicators

The unit's status LED indicators indicate the following errors:

### 6-2-1 Errors During Initialisation

| Status                                           | LED: | ON: Lit  | OFF: Not lit | FLASH: Flashing | --: Not changed |
|--------------------------------------------------|------|----------|--------------|-----------------|-----------------|
|                                                  | RUN  | ERC      | ERH          | WDOG            | BF              |
| Initial hardware test error                      | OFF  | Flashing | OFF          | OFF             | OFF             |
| Error log access error                           | OFF  | ON       | OFF          | OFF             | OFF             |
| PLC watchdog timeout error                       | OFF  | OFF      | OFF          | OFF             | OFF             |
| Communication error between the unit and the PLC | OFF  | OFF      | ON           | OFF             | OFF             |
| Other CPU error                                  | OFF  | OFF      | ON           | OFF             | OFF             |
| Unit No. setting error                           | OFF  | OFF      | ON           | OFF             | OFF             |
| I/O table configuration error                    | OFF  | OFF      | ON           | OFF             | OFF             |

### 6-2-2 Errors During Operation

| Status                                           | LED: | ON: Lit  | OFF: Not lit | FLASH: Flashing | --: Not changed |
|--------------------------------------------------|------|----------|--------------|-----------------|-----------------|
|                                                  | RUN  | ERC      | ERH          | WDOG            | BF              |
| Low or empty battery error                       | --   | Flashing | --           | --              | --              |
| Error log access error                           | --   | ON       | --           | --              | --              |
| PLC watchdog timeout error                       | OFF  | --       | --           | --              | --              |
| Communication error between the unit and the PLC | --   | --       | ON           | --              | --              |
| CPU fatal error (FALS)                           | --   | --       | --           | OFF             | --              |
| CPU non-fatal error (FAL)                        | --   | --       | --           | --              | --              |
| Mechatrolink-II bus error                        | --   | --       | --           | OFF             | ON              |
| BASIC program error                              | --   | --       | --           | --              | --              |
| Axis error                                       | --   | --       | --           | --              | --              |
| Other errors                                     | --   | --       | --           | --              | --              |



## 6-3 Troubleshooting Errors

### 6-3-1 Initial Hardware Test Error

| Problem                                                                         | Solution                                                                                             |
|---------------------------------------------------------------------------------|------------------------------------------------------------------------------------------------------|
| FLASH error, RAM error, CPU error, System software error during initialization. | Turn off the PLC system and then turn it back on. If the error persist, replace the CJ1W-MCH72 unit. |

### 6-3-2 Error Log Access Error

| Problem                                                                   | Solution                                                                                             |
|---------------------------------------------------------------------------|------------------------------------------------------------------------------------------------------|
| Error log has been detected to be corrupt or error log cannot be written. | Turn off the PLC system and then turn it back on. If the error persist, replace the CJ1W-MCH72 unit. |

### 6-3-3 PLC Watchdog Timeout Error

| Problem                                        | Solution                                                                                          |
|------------------------------------------------|---------------------------------------------------------------------------------------------------|
| PLC CPU stalled, not servicing watchdog timer. | Turn off the PLC system and then turn it back on. If the error persist, replace the PLC CPU unit. |

### 6-3-4 Communication Error Between the PLC CPU unit and the CJ1W-MCH72 unit

| Problem                                                                                                                                                                                                                                                                                                                                                                                              | Solution                                          |
|------------------------------------------------------------------------------------------------------------------------------------------------------------------------------------------------------------------------------------------------------------------------------------------------------------------------------------------------------------------------------------------------------|---------------------------------------------------|
| The communication on the backplane of the PLC system has not been refreshed in a timely manner, backplane communication signal failure.                                                                                                                                                                                                                                                              | Turn off the PLC system and then turn it back on. |
| Additional actions to take:                                                                                                                                                                                                                                                                                                                                                                          |                                                   |
| When this error happens during operation, a user can take any additional action if necessary in BASIC program. The occurrence of this error during operation can be checked by reading bit 0 of the value returned by the <b>PLC_STATUS(0)</b> BASIC command and value returned by the <b>PLC_STATUS(1)</b> BASIC command (see section 4-2-185 for more details on <b>PLC_STATUS</b> BASIC command). |                                                   |

### 6-3-5 Other CPU Error

| Problem                                | Solution                                                                                             |
|----------------------------------------|------------------------------------------------------------------------------------------------------|
| Other error occurred in the units CPU. | Turn off the PLC system and then turn it back on. If the error persist, replace the CJ1W-MCH72 unit. |

### 6-3-6 Unit No. Setting Error

| Problem                                                                    | Solution                                                                                                                       |
|----------------------------------------------------------------------------|--------------------------------------------------------------------------------------------------------------------------------|
| Unit number set does not match setting in the PLC I/O table configuration. | Set unit number according to the I/O table configuration downloaded in the PLC CPU.                                            |
| Duplicate unit numbers in the PLC system                                   | Set the unit number using the rotary switch on the front of the case so there are no duplicated unit numbers in the PLC system |

### 6-3-7 I/O Table Configuration Error

| Problem                                                                                                                                            | Solution                                                                                                                                                                                                                                                                                                                                                                                          |
|----------------------------------------------------------------------------------------------------------------------------------------------------|---------------------------------------------------------------------------------------------------------------------------------------------------------------------------------------------------------------------------------------------------------------------------------------------------------------------------------------------------------------------------------------------------|
| Unit types, unit numbers, their order on the PLC backplane or the total number of units does not match setting in the PLC I/O table configuration. | <p>Set the whole PLC system configuration, including unit types, unit numbers, total number of units and their order in the PLC system so the configuration matches I/O table configuration in the PLC CPU.</p> <p>Define and set your PLC configuration and then create I/O table configuration that match actual configuration and download it in the PLC CPU using CX-Programmer software.</p> |

### 6-3-8 Low or Empty Battery Error

| Problem                                                                                                                                                                                                                                                                                                                                                                                                                      | Solution             |
|------------------------------------------------------------------------------------------------------------------------------------------------------------------------------------------------------------------------------------------------------------------------------------------------------------------------------------------------------------------------------------------------------------------------------|----------------------|
| The unit's battery level is low, or the battery is empty (bit 1 of the <b>SYSTEM_ERROR</b> system parameter is high, see section 4-2-232 for more details on this parameter).                                                                                                                                                                                                                                                | Replace the battery. |
| Additional actions to take:                                                                                                                                                                                                                                                                                                                                                                                                  |                      |
| A user can always check whether the battery is low or empty using the <b>BATTERY_LOW</b> system parameter or bit 1 of the <b>SYSTEM_ERROR</b> system parameter (for more information on <b>BATTERY_LOW</b> BASIC command see section 4-2-41). The battery status can also be checked from the PLC ladder program by checking "Battery Low" status bit in the allocated CIO memory area (see section 3-3-1 for more details). |                      |

### 6-3-9 CPU Fatal Error (FALS)

| Problem                                                                                                              | Solution                                                                                        |
|----------------------------------------------------------------------------------------------------------------------|-------------------------------------------------------------------------------------------------|
| A fatal error (FALS) generated by the PLC CPU, either by the system or programmatically (from a PLC ladder program). | Remove the cause of the problem in the PLC, if it wasn't generated programmatically on purpose. |
| Additional actions to take:                                                                                          |                                                                                                 |

| <b>Problem</b>                                                                                                                                                                                                                                                                                                                                                                                    | <b>Solution</b> |
|---------------------------------------------------------------------------------------------------------------------------------------------------------------------------------------------------------------------------------------------------------------------------------------------------------------------------------------------------------------------------------------------------|-----------------|
| When this error occurs, the WDOG goes automatically off and all current motion is stopped. If necessary, a user can take additional actions in BASIC programs when this error happen. The occurrence of this error can be checked for by reading bit 2 of the value returned by the <b>PLC_STATUS(0)</b> BASIC command (see section 4-2-185 for more details on <b>PLC_STATUS</b> BASIC command). |                 |

### 6-3-10 CPU Non-Fatal Error (FAL)

| Problem                                                                                                                                                                                                                                                                                                                                                                                                                    | Solution                                                                                        |
|----------------------------------------------------------------------------------------------------------------------------------------------------------------------------------------------------------------------------------------------------------------------------------------------------------------------------------------------------------------------------------------------------------------------------|-------------------------------------------------------------------------------------------------|
| A non-fatal error (FAL) generated by the PLC CPU, either by the system or programmatically (from a PLC ladder program).                                                                                                                                                                                                                                                                                                    | Remove the cause of the problem in the PLC, if it wasn't generated programmatically on purpose. |
| Additional actions to take:                                                                                                                                                                                                                                                                                                                                                                                                |                                                                                                 |
| When this error occurs, the unit continues operation normally as no error has occurred. If any action on this error is necessary, a user can take additional actions in BASIC programs when this error happen. The occurrence of this error can be checked for by reading bit 3 of the value returned by the <b>PLC_STATUS(0)</b> BASIC command (see section 4-2-185 for more details on <b>PLC_STATUS</b> BASIC command). |                                                                                                 |

### 6-3-11 MECHATROLINK-II Bus Error

| Problem                                                                                                                                                                                                                                              | Solution                                                                                                                                                                                                              |
|------------------------------------------------------------------------------------------------------------------------------------------------------------------------------------------------------------------------------------------------------|-----------------------------------------------------------------------------------------------------------------------------------------------------------------------------------------------------------------------|
| Cable failure on the MECHATROLINK-II bus.                                                                                                                                                                                                            | Check MECHATROLINK-II cables between stations connected to the unit for interruptions and irregularities (short circuit between communication lines A and B, short circuit of any communication line with shielding). |
| MECHATROLINK-II bus terminator is missing or damaged (bit 17 of the <b>SYSTEM_ERROR</b> system parameter is high, see section 4-2-234 for more details on this parameter).                                                                           | Fit a MECHATROLINK-II bus terminator on the last station in the chain or replace it.                                                                                                                                  |
| The MECHATROLINK-II station connected to the unit is lost due to power off or MECHATROLINK-II interface failure at the station (bit 18 of the <b>SYSTEM_ERROR</b> system parameter is high, see section 4-2-234 for more details on this parameter). | Check the power and MECHATROLINK-II interface of the station that caused the problem. Replace the station if necessary.                                                                                               |
| The MECHATROLINK-II The CJ1W-MCH72 is defective.                                                                                                                                                                                                     | Replace the CJ1W-MCH72 unit.                                                                                                                                                                                          |

### 6-3-12 BASIC Program Error

| Problem                                                                                                                                                                                  | Solution                                                                                                                                                                                                                                                                                                                                                                                                      |
|------------------------------------------------------------------------------------------------------------------------------------------------------------------------------------------|---------------------------------------------------------------------------------------------------------------------------------------------------------------------------------------------------------------------------------------------------------------------------------------------------------------------------------------------------------------------------------------------------------------|
| BASIC program stopped working during operation due to runtime error (bit 0 of the <b>SYSTEM_ERROR</b> system parameter is high, see section 4-2-234 for more details on this parameter). | Using BASIC command <b>RUN_ERROR</b> determine the error type that caused runtime error. Using BASIC command <b>ERROR_LINE</b> find a line in the BASIC program which caused runtime error. Modify found line causing an error to prevent it from happening in the future (see section 4-2-214 for more details on <b>RUN_ERROR</b> and section 4-2-97 for more details on <b>ERROR_LINE</b> BASIC commands). |
| BASIC program cannot be run due to compilation or syntax error.                                                                                                                          | Use Trajexia Studio Software to edit and compile BASIC programs. Editor of the software will automatically highlight locations of possible compile errors and provide all necessary debugging information while compiling the program.                                                                                                                                                                        |

### 6-3-13 Axis Error

| Problem                                                                                                                        | Solution                                                                                                                                                                                                                                                                                                                                             |
|--------------------------------------------------------------------------------------------------------------------------------|------------------------------------------------------------------------------------------------------------------------------------------------------------------------------------------------------------------------------------------------------------------------------------------------------------------------------------------------------|
| Not all physically present axes are initialised. Some of them are virtual (ATYPE = 0) or have illegal axis number -1 assigned. | Wrong setting of the <b>SERVO_PERIOD</b> system parameter for a given number of MECHATROLINK-II stations and axes. Correct the <b>SERVO_PERIOD</b> value and restart the unit (see section 4-2-222 for more information on valid <b>SERVO_PERIOD</b> value depending on number of connected stations).                                               |
| Present axis has illegal axis number (-1) assigned to it, Encoder Interface axis is in error.                                  | Confliction axis number for MECHATROLINK-II axis and Encoder Interface axis. This can happen if a new MECHATROLINK-II axis is added to the system and the MECHATROLINK-II bus is reinitialized using BASIC command <b>MECHATROLINK(0, 0)</b> , but the unit is not restarted. After adding new MECHATROLINK-II axis to the system, restart the unit. |

| Problem                                                                          | Solution                                                                                                                                                                                                                                                                                                                                                                                                                                                                                                                                                                                                                                                                                                                   |
|----------------------------------------------------------------------------------|----------------------------------------------------------------------------------------------------------------------------------------------------------------------------------------------------------------------------------------------------------------------------------------------------------------------------------------------------------------------------------------------------------------------------------------------------------------------------------------------------------------------------------------------------------------------------------------------------------------------------------------------------------------------------------------------------------------------------|
| <p>Axis error due to a motion error, no error signalization on servo drives.</p> | <p>Using <b>ERROR_AXIS</b> and <b>MOTION_ERROR</b> system parameters determine axis or axes which caused motion error. Using <b>AXISSTATUS</b> axis parameter determine the type of the axis error (see section 4-2-96 for more information on valid <b>ERROR_AXIS</b>, section 4-2-158 for <b>MOTION_ERROR</b> and section 4-2-35 for <b>AXISSTATUS</b> BASIC commands).In necessary, modify application or motion system so the axis error doesn't happen in the future.</p>                                                                                                                                                                                                                                             |
| <p>Axis error due to an error in the servo drive.</p>                            | <p>Using <b>ERROR_AXIS</b> and <b>MOTION_ERROR</b> system parameters determine axis or axes which caused motion error (see section 4-2-96 for more information on <b>ERROR_AXIS</b> and section 4-2-158 for <b>MOTION_ERROR</b> basic commands). Using <b>DRIVE_ALARM</b> and <b>DRIVE_STATUS</b> axis parameter check for alarm code. It can be also determined by checking the operation panel of the drive (see section 4-2-74 for more information on <b>DRIVE_ALARM</b> and section 4-2-81 for <b>DRIVE_STATUS</b> BASIC commands).Remove the cause of the alarm/error and restart the system if necessary (for more details on alarm codes and possible cause of the alarms, see servo driver Operation Manual).</p> |

6-4 Miscellaneous

| Problem                                                                                                                            | Solution                                                                                                                                                                                                                                                                                 |
|------------------------------------------------------------------------------------------------------------------------------------|------------------------------------------------------------------------------------------------------------------------------------------------------------------------------------------------------------------------------------------------------------------------------------------|
| A connection with the unit from Trajexia Studio software cannot be established.                                                    | Check connection cable between the PLC and the Personal Computer running the software. Check that configuration settings (network type, IP address, unit number, ...) in the software matches the one of the unit. Check there is no other software or device using the same connection. |
| There is no axis nor motion error in the system, but the WDOG cannot be set ON. The command WDOG = ON is accepted, but no changes. | Check the "Enable Watchdog" bit of the unit status area in the allocated CIO memory of the PLC (see section 3-3-1 for more details). If this bit is OFF, turning on the WDOG is disabled.                                                                                                |
| Programs are correct and compiled correctly, but they cannot be started.                                                           | Check the "Enable Program Run" bit of the unit status area in the allocated CIO memory of the PLC (see section 3-3-1 for more details). If this bit is OFF, running BASIC programs is disabled.                                                                                          |
| Outputs cannot be turned ON.                                                                                                       | Check the LOAD OFF bit (A500.15) of the PLC. If this bit is set on, the setting ON the unit's outputs is disabled.                                                                                                                                                                       |

## A

Absolute  
  EnDat, 28  
  SSI, 28  
Absolute encoder  
  Wiring, 46  
Architecture, 16  
Axis sequence, 24  
Axis type, 25

## B

Bag feeder program example, 339  
BASIC commands, 73  
BASIC program, 3  
Battery, 37  
  Replace, 38  
Buffer types, 31  
Buffers, 16, 31

## C

CAM table example, 341  
Command  
  Axis, 73  
  Communication, 77  
  I/O, 78  
  Program, 79  
  Program control, 80  
  System, 81  
  Task, 83  
Communication, 16  
Complex profile, 26  
Components  
  CJ1W-MCH72, 35  
Configuration examples, 20  
Connector  
  Encoder, 39  
  I/O, 39  
  MECHATROLINK-II, 39  
Constants, 77  
Correction example, 346  
CPU task, 3  
Cycle time, 2, 17

## D

Data exchange, 59

Configurable data, 64  
Configuration, 61  
Control data, 62  
Memory areas, 60  
Status data, 62

### Definition

CPU task, 3  
Cycle time, 2  
Motion sequence, 2  
Process, 3  
Program, 3  
Servo period, 2

Description Motion buffers, 16

## E

Encoder connector, 39  
  Wiring, 43  
Encoder output, 28  
EnDat, 28  
Example  
  Bag feeder program, 339  
  CAM table, 341  
  Configuration, 20  
  Correction program, 346  
  Flying shear program, 343  
  Gain settings, 270  
  Homing, 300  
  Initialization program, 333  
  Motion buffers, 32  
  Multi-tasking, 23  
  Origin search, 300  
  Position mode, 280  
  Position on a grid, 337  
  Position with product detection, 336  
  Registration, 305  
  Servo Driver characteristics, 295  
  Servo period, 18  
  Setting units, 285  
  Shell program, 320  
  Single axis program, 335  
  Speed mode, 271  
  Startup program, 268  
  Tracing and monitoring, 314  
Explanation  
  Communication, 16  
  Cycle time, 17  
  Motion buffers, 31  
  Motion sequence, 16, 23  
  Multi-tasking, 22  
  Peripherals, 16  
  Program control, 16  
  Servo period, 17



## F

FINS, 65  
  Error Data Read, 71  
  Parameter Area Read, 68  
  Parameter Area Write, 68  
  Read, 66  
  Run, 70  
  Stop, 71  
  Write, 67  
Flying shear example, 343  
Function  
  I/O, 78  
  Mathematical, 78  
  System, 81

## G

Gain example, 270

## H

Homing example, 300

## I

I/O connector, 39  
  Wiring, 40  
Incremental encoder  
  Hardware PSWITCH, 45  
  Input, 44  
  Output, 46  
  Registration, 45  
  Wiring, 44  
Inertia ratio, 33  
Initialization example, 333  
Installation, 50

## M

MECHATROLINK-II  
  Connecting slaves, 53  
  Inverter as axis, 29  
  Position control, 26  
  Specifications, 56  
  Speed control, 27  
  Torque control, 27  
MECHATROLINK-II connector, 39  
Modifier  
  Slot, 80  
Motion buffers, 16, 31

Motion control, 4  
  Continuous path, 7  
  Electronic gearing, 9  
  Point-to-point, 4  
Motion sequence, 2, 16  
MTYPE, 31  
Multi-tasking example, 23

## N

NTYPE, 31

## O

Operand, 78  
  Mathematical, 78  
Origin search example, 300

## P

Parameter  
  Axis, 74  
  Communication, 77  
  I/O, 78  
  Slot, 80  
  System, 82  
  Task, 83  
Peripherals, 16  
Position control, 26  
Position loop algorithm, 24  
Position mode example, 280  
Position on a grid example, 337  
Position reference, 28  
Position with product detection example, 336  
Priority  
  Program control, 22  
Process, 3  
Process 0, 22  
Process buffer, 31  
Profile generator, 24  
Program control, 16  
Program control priority, 22

## R

Registration example, 305  
Resonant frequency, 33  
Rigidity, 33

## S

Servo axis, 28  
Servo Driver characteristics example, 295  
Servo period, 2  
    Examples, 18  
    Rules, 19  
Servo system, 13  
    CJ1W-MCH72 operation, 13  
    Motion control algorithm, 14  
    Semi-closed loop, 13  
Shell example, 320  
Single axis example, 335  
Specifications  
    Dimensions, 55  
    Encoder connector, 43  
    Encoder interface, 57  
    I/O connector, 41  
    MECHATROLINK-II, 56  
    System, 56  
    Unit, 55  
Speed control, 27  
Speed mode example, 271  
Speed reference, 28–29  
    EnDat, 28  
    SSI, 28  
SSI, 28  
Startup example, 268  
Status LEDs, 35, 37, 52  
Stepper output, 28  
System architecture, 16

## T

Torque control, 27  
Tracing and monitoring example, 314

## U

Unit components, 35  
Unit number, 37  
    Create I/O table, 52  
    Setting, 51  
Units example, 285

## V

Virtual axis, 26

## W

Wiring, 40  
Word allocations, 37



## Revision history

A manual revision code appears as a suffix to the catalog number on the front cover of the manual.

Cat. No. I55E-EN-01



The following table outlines the changes made to the manual during each revision.

| Revision code | Date          | Revised content                                                                                                                                                                                                                                                                                                                           |
|---------------|---------------|-------------------------------------------------------------------------------------------------------------------------------------------------------------------------------------------------------------------------------------------------------------------------------------------------------------------------------------------|
| 01            | August 2008   | First version                                                                                                                                                                                                                                                                                                                             |
| 02            | February 2009 | Specified additional command bits and status bits in the Data Exchange section, specified additional bits in the <b>PLC_STATUS</b> command, Added the BASIC commands <b>FLASHVR</b> and <b>INTEGER_READ</b> , and added servo driver I/O mapping and registration for G-Series Servo Drivers.<br>The section troubleshooting is improved. |
| 03            | April 2009    | For UL certified applications an external Class 2 power supply is required (see section 2-2-1-1).                                                                                                                                                                                                                                         |



# OMRON

**Authorized Distributor:**