

E5EK

Digital Controller CompoBus/D (DeviceNet) Type

USER'S MANUAL

The OMRON logo is displayed in white, bold, uppercase letters on a blue background. The letter 'O' is a solid circle, while the 'M' has a distinctive shape with a gap in the middle. The 'R' is a simple, blocky letter, and the 'N' is also blocky with a small gap at the top.

Preface

This high-function digital controller uses CompoBus/D (DeviceNet) as the communications function on a regular E5EK controller. From here on, the E5EK-□□□-DRT controller that supports the CompoBus/D (DeviceNet) communications function is abbreviated to E5EK-DRT.

- Use the CompoBus/D (DeviceNet) for communications.
- Select from many types of temperature and analog input (multiple input)
- Select output functions such as control output or alarm (output assignment)
- Use the HBA (heater burnout alarm) function.
- Use remote SP input.
- Monitor the control loop by LBA (Loop Break Alarm)
- Calibrate input
- It also features a watertight construction (NEMA4: equivalent to IP66)

This User's Manual describes how to use the E5EK-DRT digital controller.

Before using your E5EK-DRT, thoroughly read and understand this manual in order to ensure correct use.

PRECAUTIONS IN USING THE PRODUCT

When the product is used under the circumstances or environment below, ensure adherence to limitations of the ratings and functions. Also, take countermeasures for safety precautions such as fail-safe installations.

- (1) Use under circumstances or environments which are not described in this user's manual.
- (2) Use for nuclear power control, railway, air craft, vehicle, incinerator, medical equipment, entertainment equipment, safety device, etc.
- (3) Use for applications where death or serious property damage is possible and extensive safety precautions are required.

This product has been tested by ODVA's authorized Independent Test Lab and found to comply with ODVA Conformance Test Software Version 2.0-1.00.

About this manual

© OMRON, 1997

- (1) All rights reserved. No part of this publication may be reproduced, stored in a retrieval system, or transmitted, in any form, or by any means, mechanical, electronic, photocopying, recording, or otherwise, without the prior written permission of OMRON.
- (2) No patent liability is assumed with respect to the use of the information contained herein.
- (3) Moreover, because OMRON is constantly striving to improve its high-quality products, the information in this manual is subject to change without notice. Every precaution has been taken in the preparation of this manual. Nevertheless, OMRON assumes no responsibility for errors or omissions. Neither is any liability assumed for damages resulting from the use of the information contained in this publication.

Conventions Used in This Manual

+ Meanings of Abbreviations

Sometimes the following abbreviations are used in parameter names, figures and in text explanations. These abbreviations mean the following.

Abbreviation	Term
PV	Process value
SP	Set point
RSP	Remote set point
LSP	Local set point
LBA	Loop break alarm
HB	Heater burnout
AT	Auto-tuning
EU	Engineering unit *1

*1 °C, m, g and other units are indicated for scaled data. However, “EU” is used as the minimum unit for the data. For example, for “50.02 (m)”, 1EU is taken as the minimum unit 0.01 (m).

+ How to Read Display Symbols

The following tables show the correspondence between the symbols displayed on the displays and alphabet characters.

A	b	C	d	E	F	G	H	I	J	K	L	M
A	B	C	D	E	F	G	H	I	J	K	L	M

n	o	P	q	r	S	t	U	v	w	x	y	z
N	O	P	Q	R	S	T	U	V	W	X	Y	Z

+ “Reference” mark

This mark indicates that extra, useful information follows, such as supplementary explanations and how to apply functions.

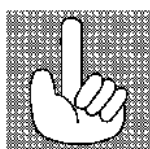

+ How this Manual is Organized

Purpose	Title	Description
<ul style="list-style-type: none"> ● Learning about the general features of the E5EK-DRT 	Chapter 1 Introduction	This chapter describes the features of the E5EK-DRT, names of parts, and typical functions.
<ul style="list-style-type: none"> ● Setting up 	Chapter 2 Preparations	This chapter describes the operations that you must carry out (e.g. installation, wiring and switch settings) before you can use the E5EK-DRT.
<ul style="list-style-type: none"> ● Basic E5EK-DRT operations 	Chapter 3 Basic Operation Chapter 5 Parameters	These chapters describe how to use the front panel keys and how to view the display when setting the parameters of the major functions for the E5EK-DRT.
<ul style="list-style-type: none"> ● Applied E5EK-DRT operations 	Chapter 4 Applied Operation Chapter 5 Parameters	These chapters describe the important functions of the E5EK-DRT and how to use the parameters for making full use of the E5EK-DRT.
<ul style="list-style-type: none"> ● CompoBus/D (DeviceNet) communication 	Chapter 6 Using the CompoBus/D (DeviceNet)	This chapter mainly describes using for the E5EK-DRT on the CompoBus/D (DeviceNet).
<ul style="list-style-type: none"> ● Calibration 	Chapter 7 Calibration	This chapter describes how the user should calibrate the E5EK-DRT.
<ul style="list-style-type: none"> ● Troubleshooting 	Chapter 8 Troubleshooting	This chapter describes what to do if any problems occur.

PRECAUTIONS ON SAFETY

● Marks For Ensuring Safe Use and Their Meanings

This manual uses the following marks to indicate precautions for ensuring that the E5EK-DRT is used safely.

The precautions indicated below describe important information regarding safety. Be sure to follow the instructions described in these precautions.

WARNING

Indicates information that, if not heeded, could possibly result in loss of life or serious injury.

CAUTION

Indicates information that, if not heeded, could result in relatively serious or minor injury, damage to the product, or faulty operation.

● Warning Symbols

WARNING

Do not touch the terminals while the power is ON.
This may cause an electric shock.

CAUTION

- The life expectancy of the output relay varies considerably according to its the output relay within its rated load and electrical life expectancy, if the output relay is used beyond its life expectancy, its contacts may become fused or burned.
- Do not allow metal fragments or lead wire scraps to fall inside this product.
This may cause electric shock, fire or malfunction.
- Never disassemble, repaire or modify the product.
This may cause electric shock, fire or malfunction.
- Use the product within the rated load.
This may cause damage or burning.
- Use this product within the rated supply voltage.
This may cause damage or burning.
- Tighten the terminal screws properly. Tightening torque:0.78N•m
Loose screws might cause malfunction.

Correctly set the settings on this product matched to the control target.

If the settings are not compatible with the control target, the product might operate in an unexpected manner, resulting in damage to the product or an accident.

- To maintain safety in the event of a product malfunction, we recommend taking safety measures, for example, installing an excessive temperature rise prevention alarm on a separate line.
If malfunction prevents control, this may result in a major accident.
- Use a screwdriver or similar tool to remove the output unit if it is hard to remove.
If you attempt to remove it by applying excessive force, you may be injured by pointed pins.

NOTICE

Be sure to observe these precautions to ensure safe use.

- (1) Do not wire the terminals which are not used.
- (2) Be sure to wire properly with correct polarity of terminals.
- (3) To reduce induction noise, separate the high-voltage or large-current power lines from other lines, and avoid parallel or common wiring with the power lines when you are wiring to the terminals. We recommend to use separating pipes, ducts, or shielded lines.
- (4) Do not use this product in the following places:
 - Places subject to dust or corrosive gases (in particular, sulfide gas and ammonia gas)
 - Places subject to high humidity, condensation or freezing.
 - Places subject to direct sunlight.
 - Places subject vibration and large shocks.
 - Places subject to splashing liquid or oil atmosphere.
 - Places directly subject to heat radiated from heating equipment.
 - Places subject to intense temperature changes.
 - Places subject to flammable or explosive gas.
- (5) To allow heat to escape, do not block the area around the product. (Ensure enough space for heat to escape.)
- (6) If you remove the controller from its case, never touch nor apply shock to the electronic parts inside.
- (7) Cleaning: Do not use paint thinner or the equivalent. Use standard grade alcohol to clean the product.
- (8) Use specified size (M3.5, width 7.2mm or less) crimped terminals for wiring.
- (9) Allow as much space as possible between the controller and devices that generate a powerful high-frequency (e.g. high-frequency welders, high-frequency sewing machines) or surge.

PRECAUTIONS FOR ENSURING CORRECT USE

- Use a 100 to 240 V AC (50/60 Hz), 24 VAC (50/60 Hz) or 24 VDC power supply matched to the power specifications of the E5EK-DRT. Also, make sure that rated voltage is attained within two seconds of turning the power ON.
- Attach a surge suppressor or noise filter to peripheral devices that generate noise (in particular, motors, transformers, solenoids, magnetic coils or other equipment that have an inductance component).
- When mounting a noise filter on the power supply, be sure to first check the filter's voltage and current capacity, and then mount the filter as close as possible to the controller.
- Insert a noise filter (TDK ZCB2206-11 or equivalent) on the AC power line to satisfy conducted emission rating (FCC Regulation Class A EN50081-2-compliant).
- Use within the following temperature and humidity ranges:
 - Temperature: -10 to 55°C, Humidity: 35 to 85% (with no icing or condensation)If the E5EK-DRT is installed inside a control board, the ambient temperature must be kept to under 55°C, including the temperature around the controller.
If the controller is subjected to heat radiation, use a fan to cool the surface of the controller to under 55°C.
- Store within the following temperature and humidity ranges:
 - Temperature: -25 to 65°C, Humidity: 35 to 85% (with no icing or condensation)
- Never place heavy objects on, or apply pressure to the controller that may cause it to deform and deteriorate during use or storage.
- Avoid using the controller in places near a radio, television set, or wireless installation. These devices can cause radio disturbances which adversely affect the performance of the controller.

Table of Contents

Preface	I
Conventions Used in This Manual	II
Precautions on Safety	IV
CHAPTER 1 INTRODUCTION	1-1
This chapter introduces the E5EK-DRT. First-time users should read this chapter without fail. For details on how to use the controller and parameter settings, see Chapters 2 onwards.	
1.1 Names of parts	1-2
1.2 Input and Output	1-4
1.3 Parameters and Menus	1-6
1.4 About the Communications Function for the CompoBus/D (DeviceNet) Network	1-9
1.5 About Calibration	1-10
CHAPTER 2 PREPARATIONS	2-1
This chapter describes the operations you should carry out before turning the E5EK-DRT ON.	
2.1 Setting up	2-2
2.2 Installation	2-4
2.3 Wiring Terminals	2-7
CHAPTER 3 BASIC OPERATION	3-1
This chapter describes an actual example for understanding the basic operation of the E5EK-DRT.	
3.1 Convention Used in this Chapter	3-2
3.2 Setting Input Specifications	3-4
3.3 Setting Output Specifications	3-7
3.4 Setting Alarm Type	3-10
3.5 Protect Mode	3-13
3.6 Starting and Stopping Operation	3-14
3.7 Adjusting Control Operation	3-15
CHAPTER 4 APPLIED OPERATION	4-1
This chapter describes each of the parameters required for making full use of the features of the E5EK-DRT. Read this chapter while referring to the parameter descriptions in chapter 5.	
4.1 Selecting the Control Method	4-2
4.2 Operating Condition Restrictions	4-4
4.3 How to Use the Remote SP	4-7
4.4 How to Use the Heater Burnout Alarm	4-9
4.5 LBA	4-11
CHAPTER 5 PARAMETERS	5-1
This chapter describes the parameters of the E5EK-DRT. Use this chapter as a reference guide.	
Conventions Used in this Chapter	5-2
Protect Mode	5-3
Manual Mode	5-5
Level 0 Mode	5-6

Level 1 Mode	5-10
Level 2 Mode	5-17
Setup Mode	5-24
Expansion Mode	5-31
Option Mode	5-36
Calibration Mode	5-42
CHAPTER 6 USING COMPOBUS/D (DEVICENET)	6-1
This chapter describes use of the E5EK-DRT as a slave on the CompoBus/D (DeviceNet) network.	
6.1 Outline of CompoBus/D (DeviceNet)	6-2
6.2 Data Refreshing by Communications	6-4
6.3 Setting the Communications Conditions	6-6
6.4 Data Assignments	6-8
6.5 Data Structure	6-10
6.6 Data Timing	6-13
6.7 Sample Ladder	6-14
CHAPTER 7 CALIBRATION	7-1
This chapter describes procedures for each calibration operation. Read this chapter only when the controller must be calibrated.	
7.1 Structure of Parameters	7-2
7.2 Calibrating Thermocouple	7-4
7.3 Calibrating Platinum Resistance Thermometers	7-7
7.4 Calibrating Current Input	7-9
7.5 Calibrating Voltage Input	7-10
7.6 Checking Indication Accuracy	7-12
CHAPTER 8 TROUBLESHOOTING	8-1
This chapter describes how to find out and remedy the cause if the E5EK-DRT does not function properly.	
8.1 Initial Checks	8-2
8.2 How to Use the Error Display	8-3
8.3 How to Use Error Output	8-5
8.4 Checking Operation Restrictions	8-6
APPENDIX	
SPECIFICATIONS	A-2
ABOUT CURRENT TRANSFORMER (CT)	A-5
CONTROL BLOCK DIAGRAM	A-6
Setting and Monitoring Parameter List	A-7
PARAMETER OPERATIONS LIST	A-11
Using the E5EK-DRT in Multi-vendor Applications	A-13

INDEX

K CHAPTER 1

INTRODUCTION

This chapter introduces the E5EK-DRT. First-time users should read this chapter without fail.

For details on how to use the controller and parameter settings, see Chapters 2 onwards.

1.1	Names of parts	1-2
	Main parts	1-2
	Front panel	1-2
	About the displays	1-3
	How to use keys	1-3
1.2	Input and Output	1-4
	Input	1-4
	Output	1-5
1.3	Parameters and Menus	1-6
	Parameter types	1-6
	Selecting modes	1-7
	Selecting parameters	1-8
	Fixing settings	1-8
1.4	About the Communications Function for the CompoBus/D (DeviceNet) Network	1-9
1.5	About Calibration	1-10

1.1 Names of parts

+ Main parts

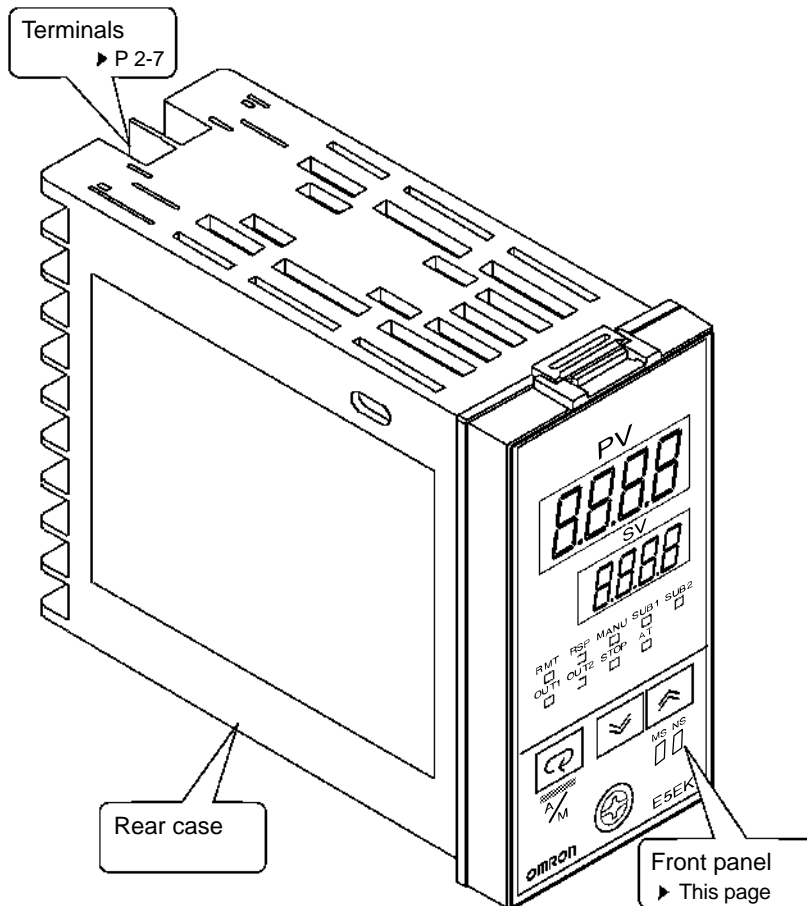

+ Front panel

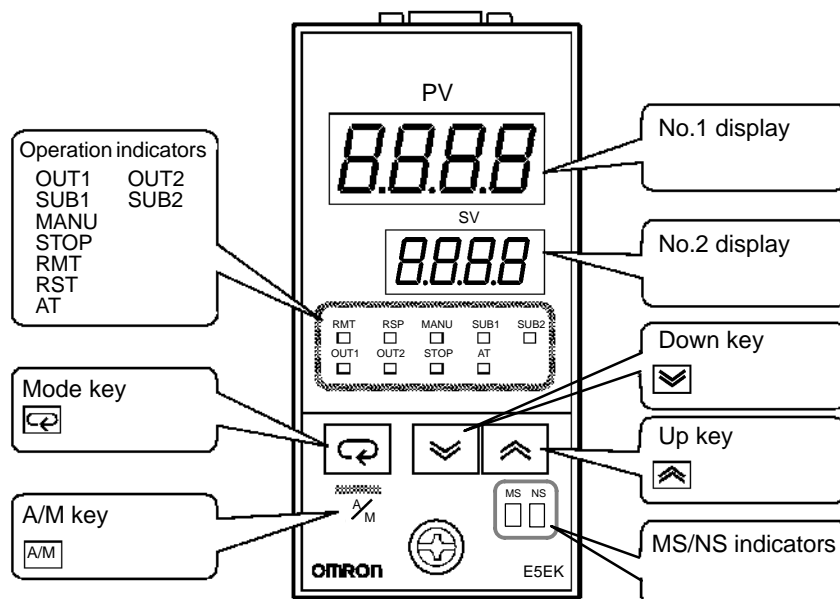

+ About the displays

- ' **No.1 display** Displays the process value or parameter symbols.

- ' **No.2 display** Displays the set point, manipulated variable or parameter settings.

- ' **Operation indicators**
 - OUT1 : Lits when the pulse output function assigned to “control output 1” is ON.
 - OUT2 : Lits when the pulse output function assigned to “control output 2” is ON.
 - SUB1 : Lits when the output function assigned to “auxiliary output 1” is ON.
 - SUB2 : Lits when the output function assigned to “auxiliary output 2” is ON.
 - MANU : Lits in the manual operation mode.
 - STOP : Lits when operation has stopped.
 - RMT : Lits during remote operation.
 - RSP : Lits during remote SP operation.
 - AT : Flashes during auto-tuning.





- ' **MS/NS indicators** Indicates the CompoBus/D (DeviceNet) status.
For details on indicated statuses, see “Chapter 8, 8.1 Initial Checks.” (page 8-2).



+ How to use keys

The following describes basic key operations.

- '  **key** Each press of this key switches between the auto and manual operations.

- '  **key** The functions of this key change according to how long it is pressed. If the key is pressed for less than one second, the parameters are switched. If the key is pressed for one second or more, the menu display appears. In key operations from here on, “press the key” refers to pressing the key for less than one second.
For details on parameter switching and menu display items, see pages 1-7 and 1-8.

- '   **key** Each press of the  key increments or advances the values or settings on the No.2 display, while each press of the  key decrements or returns the values or settings on the No.2 display.

Functions vary, for example, when the  key is held down simultaneously with  key, or a key is held down continuously. For details, see page 1-8. Also, chapters 3 and 4 describe examples using various key combinations.

1.2 Input and Output

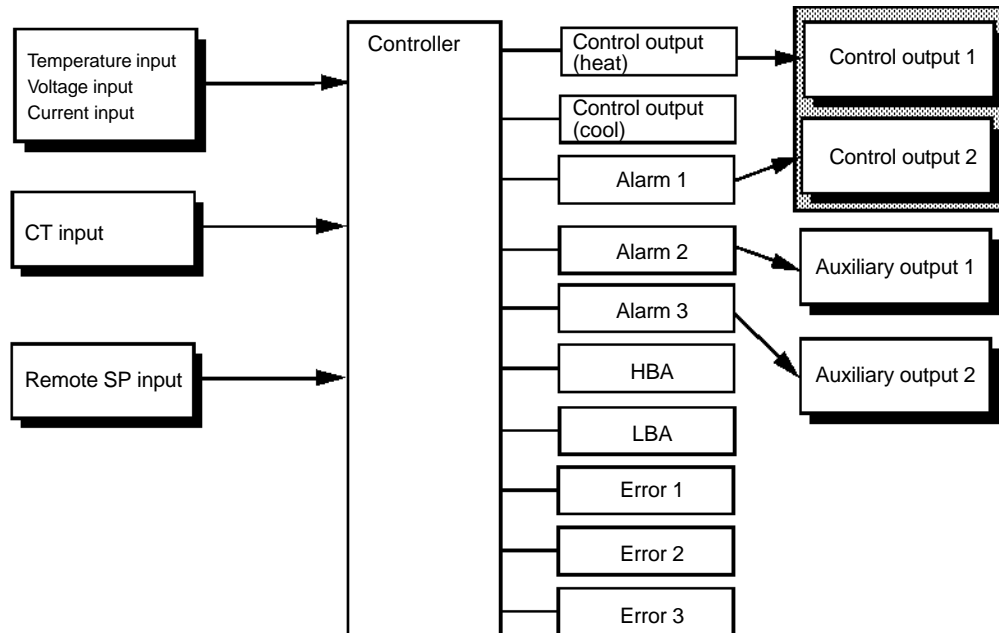

+ Input

The E5EK-DRT supports following inputs: temperature input, current input, voltage input, CT input and remote SP input.

' Temperature input/Voltage input/Current input

- Only one of temperature input, voltage input and current input can be selected and connected to the controller. The above figure shows temperature input connected to the controller.
- The following input sensors can be connected for temperature input:
Thermocouple: K, J, T, E, L, U, N, R, S, B, W, PLII
Platinum resistance thermometer: JPt100, Pt100
- The following currents can be connected for current input:
4 to 20 mA, 0 to 20 mA
- The following voltages can be connected for voltage input:
1 to 5 VDC, 0 to 5 VDC, 0 to 10 VDC

' CT input

- Connect CT input when using the HBA (heater burnout alarm) function. Note that the HBA function cannot be used simultaneously with the linear output unit.

' Remote SP input

- When the remote SP function is enabled, inputs within the range 4 to 20 mA are used as the remote SP.

+ Output

The E5EK-DRT supports the following four outputs.

- Control output 1
- Control output 2
- Auxiliary output 1
- Auxiliary output 2

When using control outputs 1 and 2, set the output unit (sold separately). Nine output units are available to suit the output circuit configuration.

Note: The output functions of the E5EK-DRT do not operate for five seconds after the E5EK-DRT is turned ON.

' Output assignments

The E5EK-DRT supports the following ten output functions.

- Control output (heat)
- Control output (cool)
- Alarms 1 to 3
- HBA
- LBA
- Error 1 (input error)
- Error 2 (A/D converter error)
- Error 3 (RSP input error)

Assign these output functions to control output 1, control output 2, auxiliary output 1, and auxiliary output 2.

There are restrictions on how assignment destinations (control output 1, control output 2, auxiliary output 1, and auxiliary output 2) can be used. For details, see 3.3 Setting Output Specifications.

In the example on the previous page, “control output (heat)” is assigned to “control output 1”, “alarm 1” is assigned to “control output 2”, “alarm 2” is assigned to “auxiliary output 1”, and “alarm 3” is assigned to “auxiliary output 2”. Accordingly, the configuration is such that heating control output is connected to control output 1, and alarm output is connected to control output 2 and auxiliary outputs 1 and 2.

Control outputs 1 and 2 are used depending on the differences in control method as follows.

Control Method	Control Output 1/ Control Output 2
Standard control	Control output (heat)/Alarm, etc.,.
Heating and cooling control	Control output (heat) / Control output (cool)

1.3 Parameters and Menus

+ Parameter types

E5EK-DRT parameters are distributed between the following nine modes.

Protect mode
Manual mode
Level 0 mode
Level 1 mode
Level 2 mode
Setup mode
Expansion mode
Option mode
Calibration mode

The settings of parameters in each of seven modes (excluding the protect mode and manual mode) can be checked and modified by selection on the menu display.

- ' **Protect mode** This mode is used to limit use of the keys. The protect function is for preventing unwanted modification of parameters and switching between the auto and manual operation.
- ' **Manual mode** In this mode, the controller can be switched manual operation. The manipulated variable can be manipulated manually only in this mode.
- ' **Level 0 mode** Set the controller to this mode during normal operation. In this mode, you may change the set point during operation, and stop and start operation. You can also monitor (not change) the process value, ramp SP and manipulated variable.
- ' **Level 1 mode** This is the main mode for adjusting control. In this mode, you can execute AT (auto-tuning), and set alarm values, the control period, PID parameters and heater burnout alarm (HBA) conditions.
- ' **Level 2 mode** This is the auxiliary mode for adjusting control. In this mode, you can set the parameters for limiting the manipulated variable, switch between the remote and local modes, switch between the SP modes, and set the loop break alarm (LBA), alarm hysteresis and the digital filter value of inputs.
- ' **Setup mode** This is the mode for setting the basic specifications. In this mode, you can set parameters that must be checked or set before operation such as the input type, scaling, output assignments and direct/reverse operation.
- ' **Expansion mode** This is the mode for setting expanded functions. In this mode, you can set, SP setting limiter, selection of 2-PID control or ON/OFF control, specification of the standby sequence resetting method, time for automatic return to the monitoring display.



Differences from
General-purpose
Models

New function	Functions not supported
CompoBus/D (DeviceNet)	Serial communications Position-proportional control Event input Multi-SP Transfer output Self-tuning (ST)

- **Option mode** This is the mode for setting option functions. CompBus/D (DeviceNet) communications conditions, heater burnout alarm function, and remote SP scaling parameters are also located in this mode.
- **Calibration mode** This mode is provided so that the user can calibrate inputs. When calibrating input, the selected input type is calibrated.

+ **Selecting modes** The following diagram shows the order in which modes are selected.

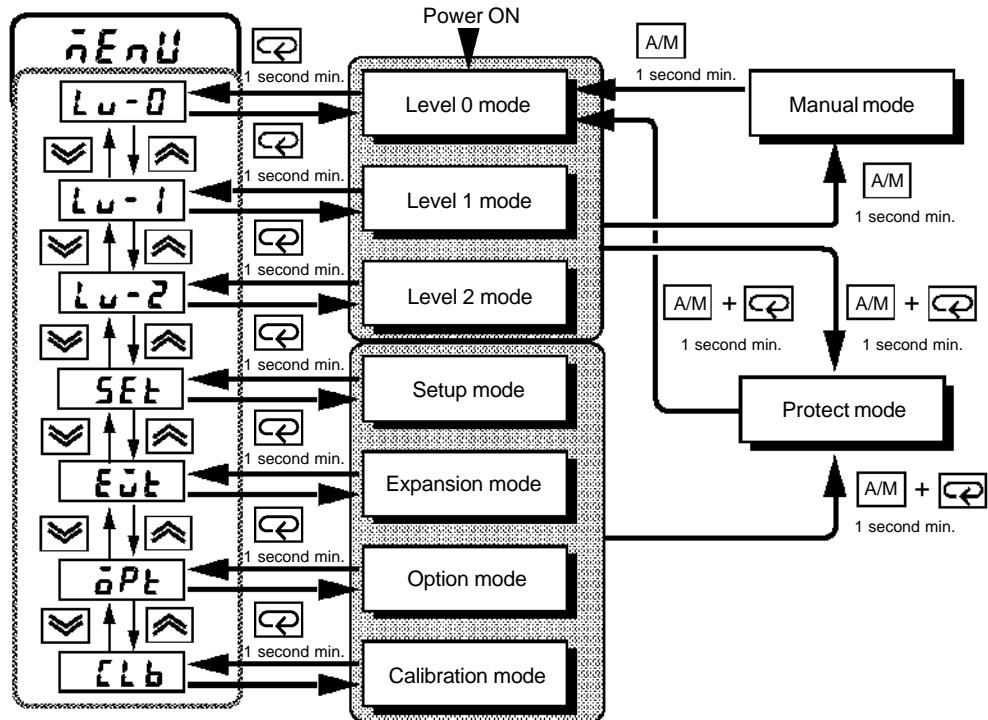

- **Menu display**
 - To select the menu display in any of the above modes (excluding the protect mode and the manual mode), press the [Enter] key for 1 second minimum. The previously specified mode is selected. For example, if you selected the menu display while in the level 0 mode, the No.2 display change to [Lv-0] as shown on the left.
 - If you select the destination mode using the [Up] or [Down] keys and press the [Enter] key for 1 second minimum when you have selected the menu display, the top parameter in the specified mode is selected.
 - Protected modes cannot be selected. Also, the menu display does not appear when modes are protected up to the level 1 mode.
- **Level 0 to 2 modes**
 - If you select [Lv-0] [Lv-1] or [Lv-2] in the menu display, the level 0, level 1 and level 2 modes, respectively, are selected.
 - These modes are selected with control still continuing.
- **Setup mode**
- **Expansion mode**
- **Option mode**
- **Calibration mode**
 - If you select [SEt] [EwE] [oPE] or [CLb] in the menu display, the setup, expansion, option and calibration modes, respectively, are selected. When these modes are selected, the control is reset. So, control outputs and auxiliary output are turned OFF. When another mode is selected while in these modes, reset is canceled.



- **Protect mode**
 - To set the controller to the protect mode or to return to the level 0 mode from the protect mode, press the **A/M** key and **↶** key for 1 second minimum simultaneously.
- **Manual mode**
 - To set the controller to the manual mode, press the **A/M** key for 1 second minimum in the level 0 to 2 mode. To return to the level 0 mode from the manual mode, press the **A/M** key for 1 second minimum.

+ **Selecting parameters**

- When not in the manual mode, each press of the **↶** key switches the parameter.
- If you press the **↶** key when at the final parameter, the display returns to the first parameter.

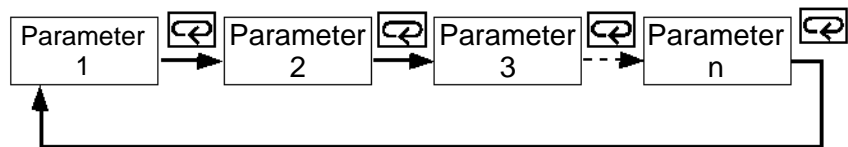

+ **Fixing settings**

- If you press the **↶** key when at the final parameter, the display returns to the first parameter.
- When you have changed a parameter setting, specify the parameter using the **↗** or **↘** keys, and either leave the setting for at least two seconds or press the **↶** key. This fixes the setting.
- When another mode is selected, the content of the parameters before the mode was selected is fixed.
- When turning the power OFF, you must first fix the settings and parameter contents (by pressing the **↶** key or selecting another mode). The settings and parameter contents are sometimes not changed by merely pressing the **↗** or **↘** keys.

1.4 About the Communications Function for the CompoBus/D (DeviceNet) Network

The E5EK-DRT operates as a slave on the CompoBus/D (DeviceNet) network. Items (parameters, operation instructions and statuses) that have been assigned as communication data on the E5EK-DRT can be uploaded and downloaded between masters and slaves.

16 read and write operations can be assigned as communication data, and can be assigned.

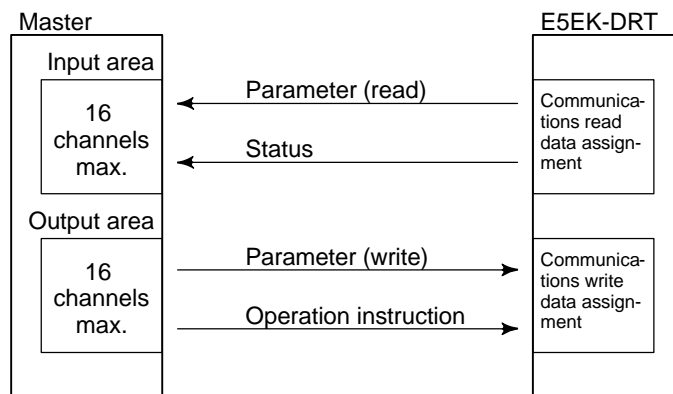

As the data structure is flexible like this, communications is possible using numerous parameter configurations, and the number of parameters can be limited to increase processing speed.

For details on the type of communication data and how to assign data, see Chapter 6 Using CompoBus/D (DeviceNet).

For details on cable connections on the CompoBus/D (DeviceNet) network, see Chapter 2 Preparations, 2.3 Wiring Terminals (page 2-7).

For details on CompoBus/D (DeviceNet) such as the network configuration and related system devices, see the CompoBus/D (DeviceNet) Operation Manual (catalog No.: W267).

1.5 About Calibration

The E5EK-DRT controller is calibrated before shipment from the factory. So, the user need not calibrate the E5EK-DRT controller during regular use.

However, if the E5EK-DRT controller must be calibrated by the user, use the parameters provided for user to calibrate temperature input, analog input (voltage, current). In this case, note that the results of calibration will not be assured.

Also, note that calibration data is updated to the latest value each time the E5EK-DRT controller is calibrated. Calibration data set before shipment from the factory cannot be returned to after calibration by the user.

Calibrating inputs

The input type selected in the parameter is the item to be calibrated. The E5EK-DRT is provided with the following four calibration parameters.

- Thermocouple
- Platinum resistance thermometer
- Current input
- Voltage input

Two parameters are provided for thermocouple, platinum resistance thermometer and voltage input.

Registering calibration data

When calibrating each item, the calibration data is temporarily registered. This data can be registered as final calibration data only when all items have been newly calibrated. So, all items must be temporarily registered when calibrating the E5EK-DRT controller.

When registering data, information regarding whether or not calibration has been carried out is also registered.

To calibrate these items, the user must prepare separate measuring devices and equipment. For details on handling these measuring devices and equipment, refer to the respective manuals.

For details, see chapter 7 Calibration.

K CHAPTER 2

PREPARATIONS

This chapter describes the operations you should carry out before turning the E5EK-DRT ON.

2.1	Setting up	2-2
	Draw-out	2-2
	Setting up the output unit	2-3
2.2	Installation	2-4
	Dimensions	2-4
	Panel cutout	2-4
	Mounting	2-5
2.3	Wiring Terminals	2-7
	Terminal arrangement	2-7
	Precautions when wiring	2-7
	Wiring	2-7

2.1 Setting up

- Set up the output units for control outputs 1 and 2 before mounting the controller.
- When setting up the output units, draw out the internal mechanism from the housing and insert the output units into the sockets for control outputs 1 and 2.

+ Draw-out

When drawing out the internal mechanism from the housing, prepare a phillips screwdriver matched to the size of the screw on the lower part of the front panel.

- (1) Press down strongly on the hook on the top of the front panel, and turn the Phillips screws to the left to loosen the screw on the lower part of the front panel.

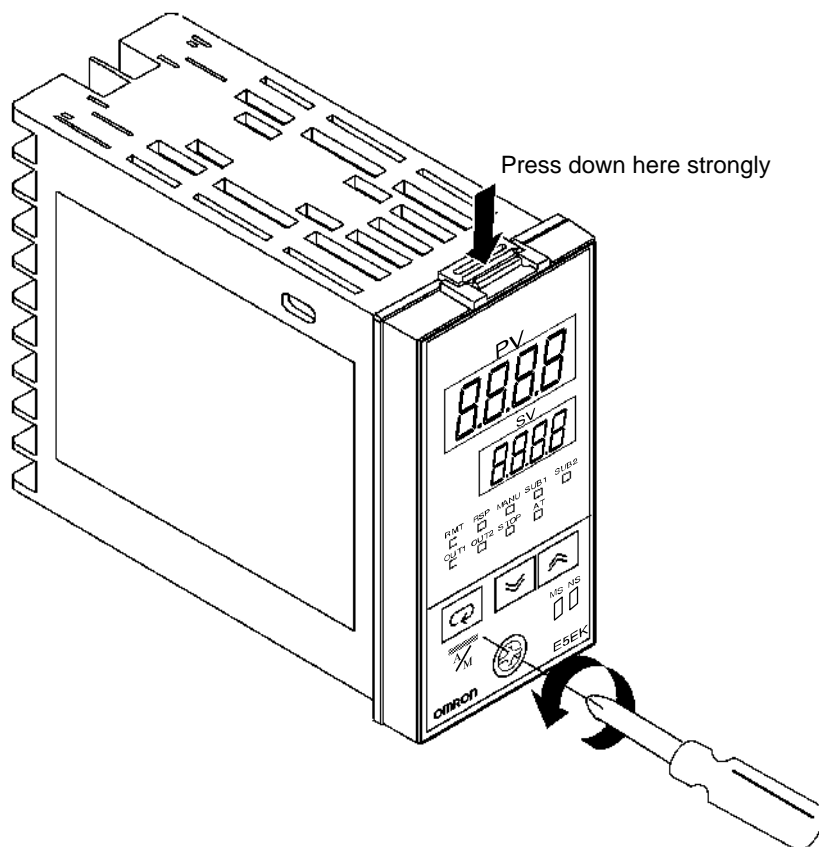

- (2) Draw out the internal mechanism towards you holding both sides of the front panel.



Fixing Screw for Front Panel

Tighten this screw by a torque of 0.3 to 0.5 N·m.

+ Setting up the output unit

· Before setup

- Check the type of the output unit you are about to set up.
- For details on types of output unit and main specifications, see page 2-8.

· Procedure

- (1) Check the positions of the sockets you are about to insert the output units into as shown in the following diagram.

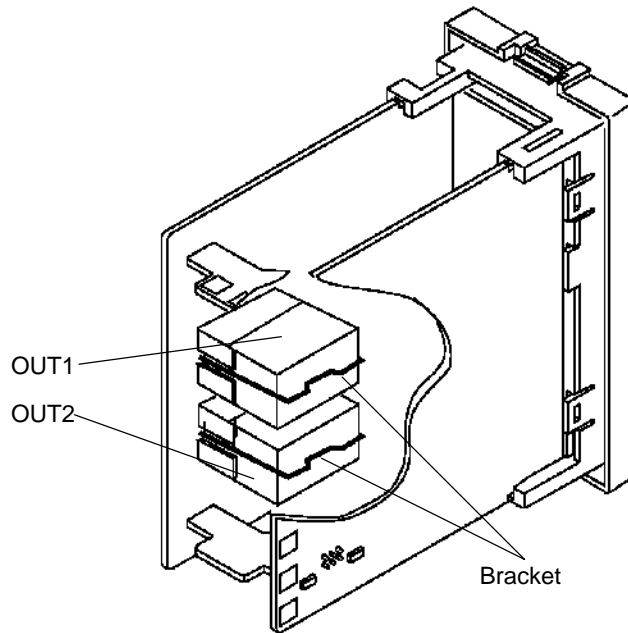

- (2) Remove the power board in the direction of the arrow shown in the figure. The power board is connected to the control board by a center connector. Remove this connector taking care not to bend the connector pins.

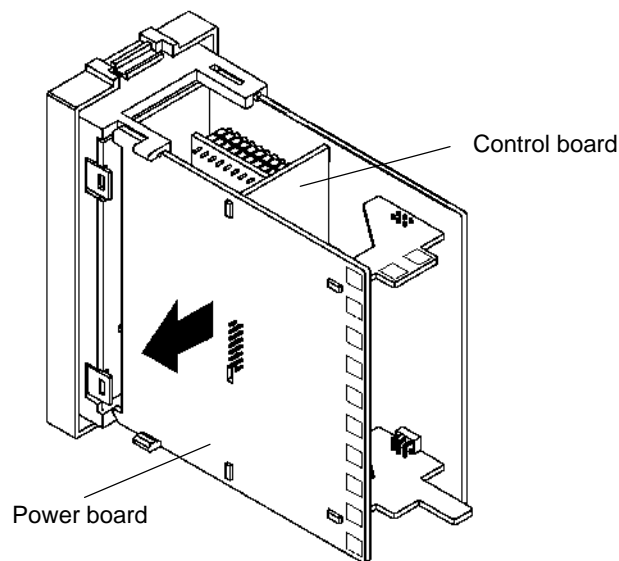

- (3) Insert the output unit for control output 1 into the socket "OUT1" and the output unit for control output 2 into the socket "OUT2".
- (4) Fasten the output units with the bracket (accessory).
- (5) Return the power board to its original position.

2.2 Installation

+ Dimensions

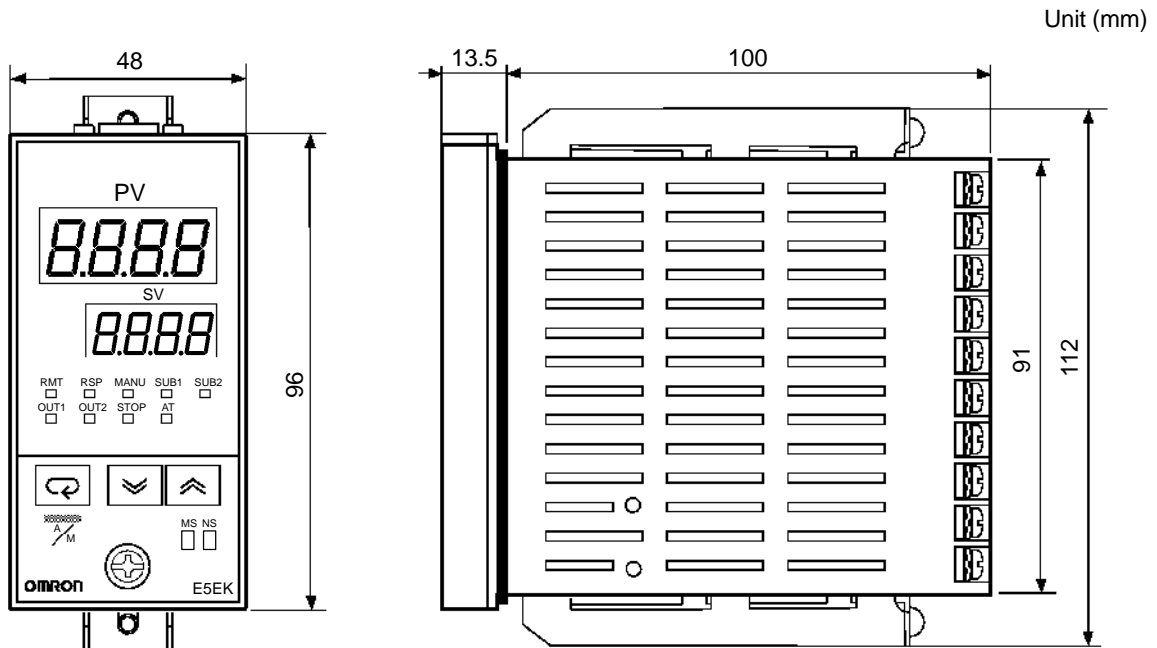

- The width of the rear case is 44 mm.

+ Panel cutout

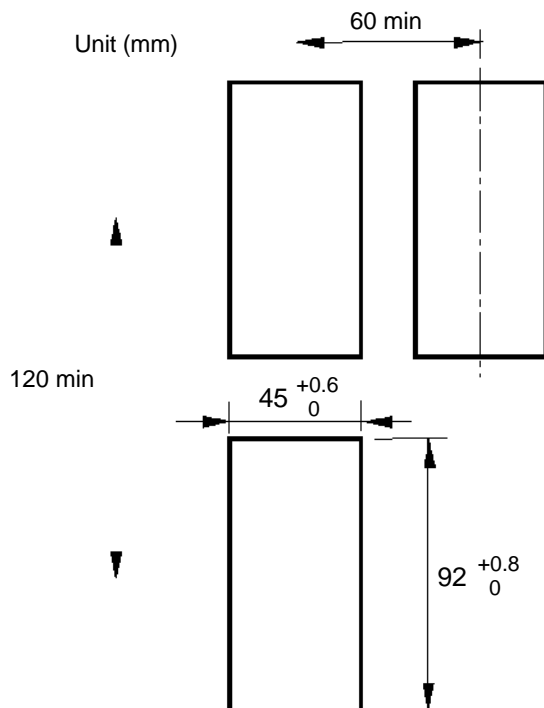

- Recommended panel thickness is 1 to 8 mm.
- Maintain the specified vertical and horizontal mounting space between each controller.

Controllers must not be closely mounted vertically or horizontally.

+ Mounting

- (1) Insert the E5EK-DRT controller into the mounting hole in the panel.
- (2) Fit the mounting bracket (accessory) into the fixing slots on the top and bottom of the rear case.

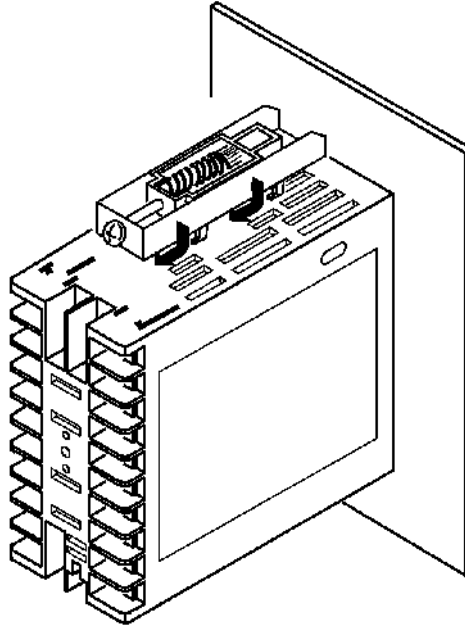

- (3) Tighten the mounting bracket screws alternately a little at a time until the ratchet start to slide.

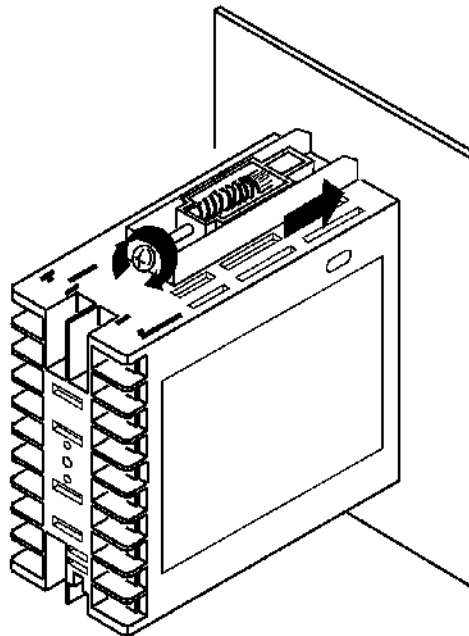

Setting up the terminal covers

- Fasten the terminal cover (E53-COV08) to protect terminals.
- E5EK-AA2-DRT-500 controller is provided with terminal covers.
- Fasten the terminal cover as follows by using the snap pins.

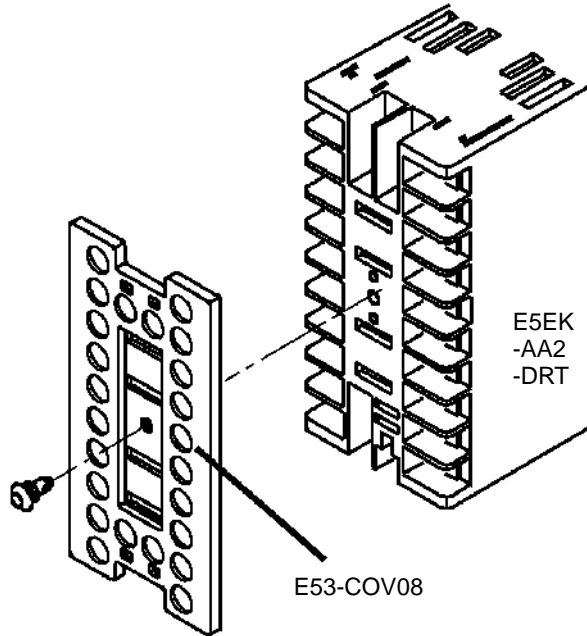

- To remove the terminal cover, pull the edges of the snap pins.

2.3 Wiring Terminals

+ Terminal arrangement

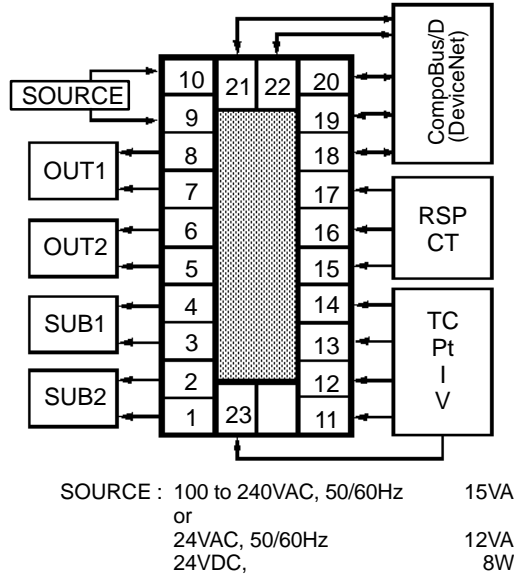

+ Precautions when wiring

- Use ducts to separate input leads and power lines in order to protect the controller and its lines from external noise.
- We recommend using solderless terminals when wiring the controller.
- Tighten the terminal screws using a torque no greater than 0.78 N·m. Take care not to tighten the terminal screws too tightly.
- Do not connect anything to unused terminals.
- Use the following type of solderless terminals for M3.5 screws.

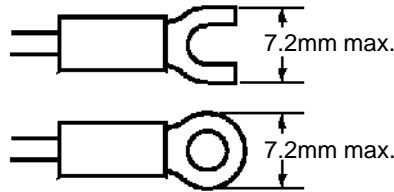

+ Wiring

Power supply

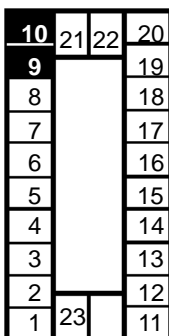

In the following wiring diagrams, the left side of the terminal Nos. indicates the inside of the controller

- Input power to terminal Nos. 9 and 10. Power specifications are as follows:
 100 to 240VAC, 50/60Hz, 15VA
 or
 24VAC, 50/60Hz, 12VA
 24VDC, 8W (Terminals 9 and 10 have no polarities.)
- When using an AC power supply, connect the noise filter (TDK ZCB2206-11 or equivalent) as shown in the figure below.

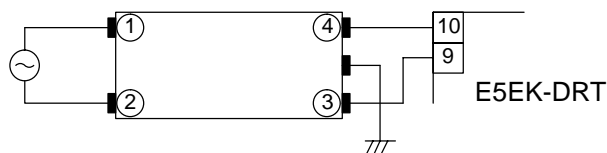

Sensor input

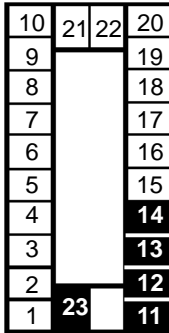

- Connect the sensor input to terminal Nos. 11 to 14 and 23 as follows according to the input type.

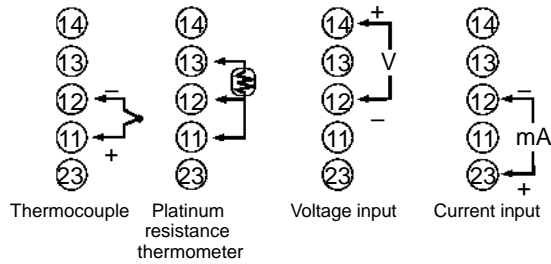

Control output

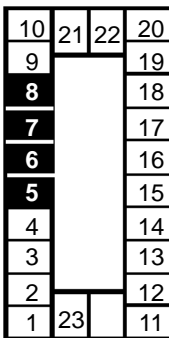

- Terminal Nos. 7 and 8 are for control output 1 (OUT1), and terminal Nos. 5 and 6 are for control output 2 (OUT2). The following diagrams show the available output units and their internal equalizing circuits.

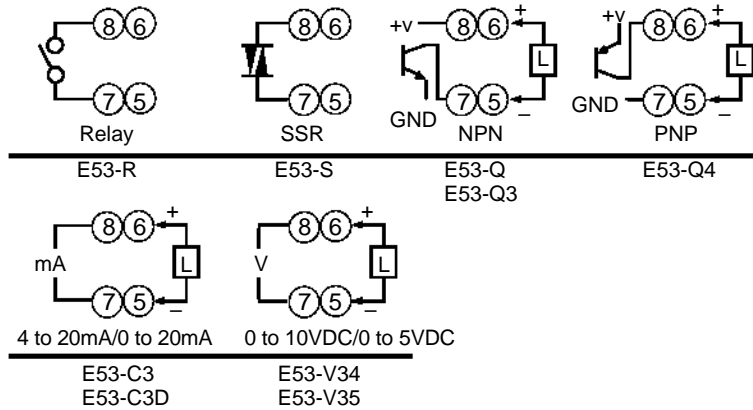

- With E53-V□□ output units, about 2VDC is output for one second after the power is interrupted.
- The following table shows the specifications for each output unit.

Model	Output Type	Output Method	Specifications
E53-R	Relay	Pulse	250 VAC, 5 A
E53-S	SSR	Pulse	75 to 250 VAC, 1 A
E53-Q E53-Q3 E53-Q4	Voltage (NPN) Voltage (NPN) Voltage (PNP)	Pulse Pulse Pulse	NPN : 12 VDC, 40 mA (with short-circuit protection) NPN : 24 VDC, 20 mA (with short-circuit protection) PNP : 24 VDC, 20 mA (with short-circuit protection)
E53-C3 E53-C3D	4 to 20 mA 0 to 20 mA	Linear Linear	4 to 20 mA, Permissible load impedance: 600 Ω max., Resolution: Approx. 2600 0 to 20 mA, Permissible load impedance: 600 Ω max., Resolution: Approx. 2600
E53-V34 E53-V35	0 to 10 VDC 0 to 5 VDC	Linear Linear	0 to 10 VDC, Permissible load impedance: 1 kΩ min., Resolution: Approx. 2600 0 to 5 VDC, Permissible load impedance: 1 kΩ min., Resolution: Approx. 2600

Auxiliary output

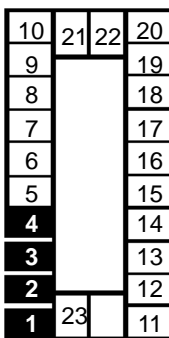

- Terminal Nos.3 and 4 are for auxiliary output 1 (SUB1) and terminal Nos.1 and 2 are for auxiliary output 2 (SUB2).
- The internal equalizing circuits for the auxiliary outputs are as follows:

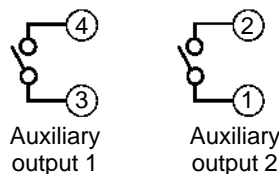

- Output specifications are as follows:
SPST-NO, 250VAC, 3A

CT input

10	21	22	20
9			19
8			18
7			17
6			16
5			15
4			14
3			13
2			12
1	23		11

- When using the HBA function connect CT input (CT) to terminal Nos.15 to 17.

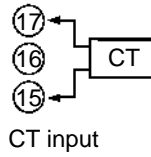

- For details on CT inputs, see Appendix, about current transformer.

Remote SP input

10	21	22	20
9			19
8			18
7			17
6			16
5			15
4			14
3			13
2			12
1	23		11

- Connect an input (RSP) to be used as the remote SP to terminal Nos.15 and 16.
- Only 4 to 20 mA inputs can be connected. Connect the input as follows:

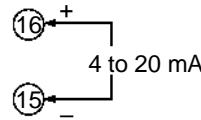

Communications

10	21	22	20
9			19
8			18
7			17
6			16
5			15
4			14
3			13
2			12
1	23		11

- Connect the solderless terminal of the CompoBus/D (DeviceNet) 5-core cable to terminal Nos. 18 to 22. Connect each of the inputs as follows:

- ⑱ Red (V+)
- ⑲ White (CAN H)
- ⑳ (shield)
- ㉑ Blue (CAN L)
- ㉒ Black (V -)

- For details on the meaning of signals and wiring precautions, see the “CompoBus/D (DeviceNet) Operation Manual (W267).”



About the power blocks

The E5EK-DRT has independent power supplies for each of the terminal blocks shown on the right.

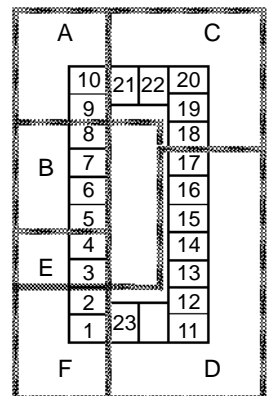

K CHAPTER 3

BASIC OPERATION

This chapter describes an actual example for understanding the basic operation of the E5EK-DRT.

3.1	Convention Used in this Chapter	3-2
3.2	Setting Input Specifications	3-4
	Input type	3-4
	Temperature input	3-5
	Analog input	3-5
3.3	Setting Output Specifications	3-7
	Output assignments	3-7
	Direct/reverse operation	3-8
	Control period	3-8
3.4	Setting Alarm Type	3-10
	Alarm type	3-10
	Alarm value	3-10
	Alarm hysteresis	3-11
	Close in alarm/open in alarm	3-11
3.5	Protect Mode	3-13
	Security	3-13
	A/M key protect	3-13
3.6	Starting and Stopping Operation	3-14
3.7	Adjusting Control Operation	3-15
	Changing the set point	3-15
	Manual operation	3-15
	Auto-tuning (A.T.)	3-17

3.1 Convention Used in this Chapter

This chapter describes basic E5EK-DRT operations such as how to set up parameters, start and stop operation, and adjusting control operation. For more complex control examples, refer to Chapter 4 Applied Operation and Chapter 5 Parameters.

Basic Operation Flow

The following diagram shows the basic operation flow.

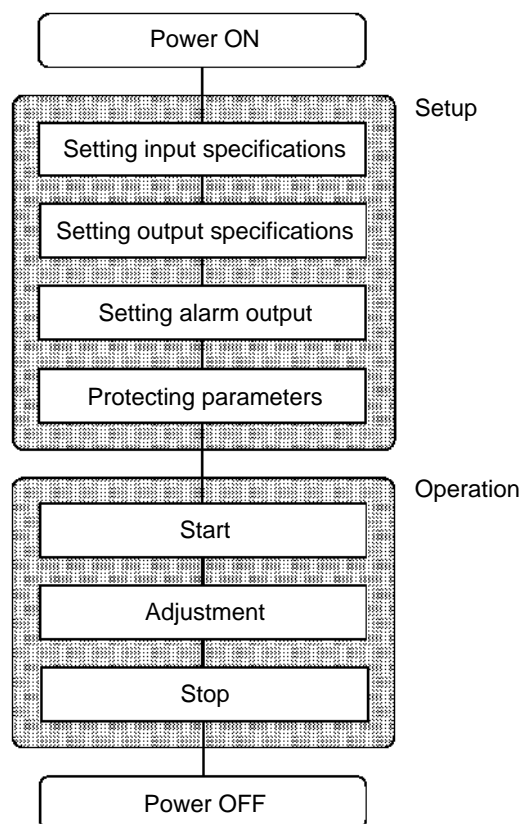

This chapter describes basic operation according to this flow. Examples of operation for each of these items are described at the end of the setting examples for the parameter in question. However, you must proceed to the first parameter of the subsequent item.

For example, to perform “setting output specifications” after completing “setting input specifications,” proceed to the first parameter of “setting output specifications” from the final parameter of “setting input specifications.” For details on moving parameters between items, follow the procedures in “Selecting modes” and “Selecting parameters” described on pages 1-7 and 1-8.

Setup

The following are examples of how to set up each of the items. These examples assume that the controller is operated at the factory defaults.

The main specifications of the setup examples in this chapter are as follows:

- A K thermocouple is connected to the controller.
- The control output (heat) function is assigned to control output 1, and the alarm 2 function is assigned to auxiliary output 1. A relay output unit is also attached to control output 1.
- The upper limit alarm is set. In this example, alarm 2 is set. An alarm is output when the temperature exceeds 10°C of the set point.

The control example that is configured based upon the setup example is as follows:

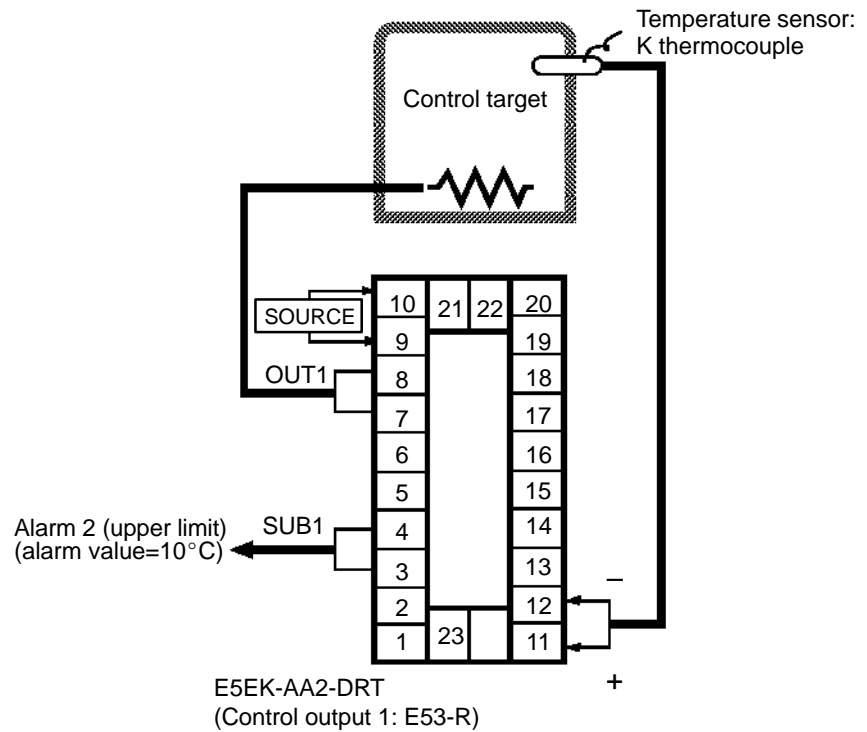

3.2 Setting Input Specifications

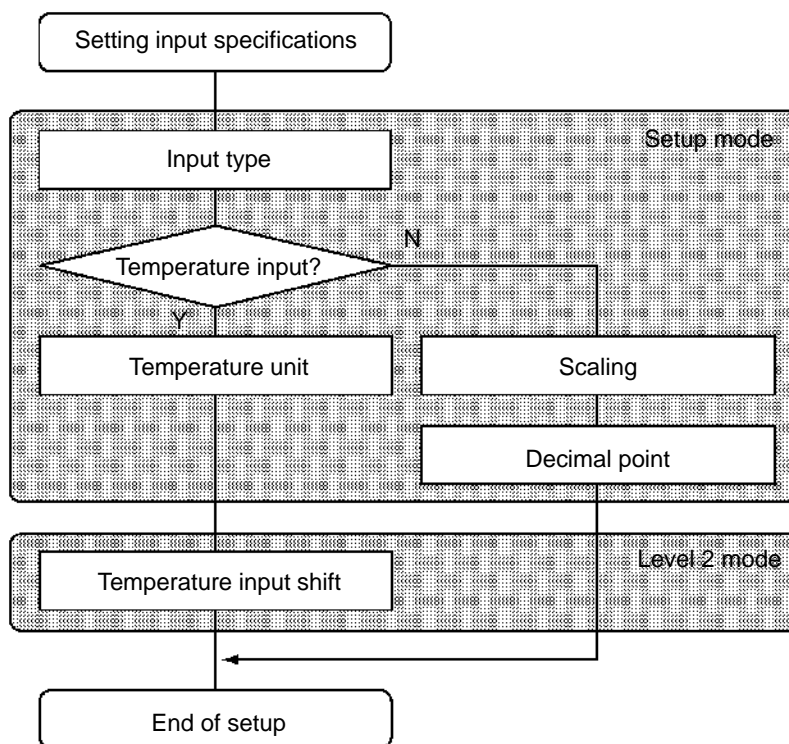

- With temperature input, scaling and decimal point parameters need not be set as this information is determined by the input (sensor) type. (These parameters are not displayed.) Note that temperature unit and temperature input shift parameters need to be set.
- With analog input, the “scaling upper limit”, “scaling lower limit” and “decimal point” parameters need to be set.

+ Input type

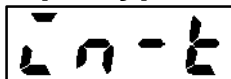

- Set the type No. (0 to 22) in the “input type” parameter (Set up mode). The factory setting is “2: K (thermocouple).”
- For details on input types and setting ranges, see page 5-25.

+ Temperature input

' Temperature unit

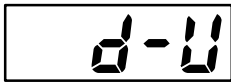

- To switch the temperature unit from “°C” to “°F” when input is temperature, switch the “°C/°F selection” parameter (setup mode) from “ C ” to “ F ”.

' Temperature input shift

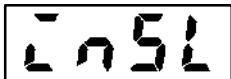

- When input is temperature input, the upper and lower limit values of the sensor can be shifted linearly. For example, if both the upper and lower limit values are shifted by 1.2°C, the process value (before shift) is regarded as 201.2°C after shift when input is 200°C before shift.
- To set input shift, set shift values in the “input shift upper limit” and “input shift lower limit” parameters (level 2 mode).

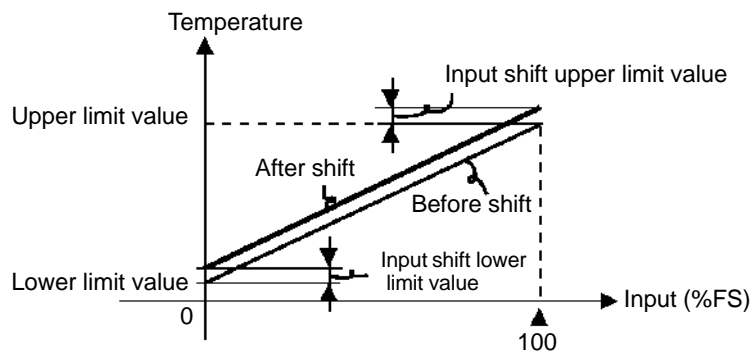

+ Analog input

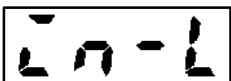

- When the analog input (the voltage input and current input) is selected, scaling matched to the control is available.
- The “scaling upper limit”, “scaling lower limit” and “decimal point” parameters (setup mode) are used for scaling. These parameters cannot be used when the temperature input type is selected.
- The “scaling upper limit” parameter sets the physical quantity to be expressed by the upper limit value of input, and the “scaling lower limit” parameter sets the physical quantity to be expressed by the lower limit value of input. The “decimal point” parameter sets the number of digits past the decimal point.
- The following figure shows a scaling example of 4 to 20 mA input. After scaling, the humidity can be directly read. In this case, the “decimal point” parameter is set to “1”.

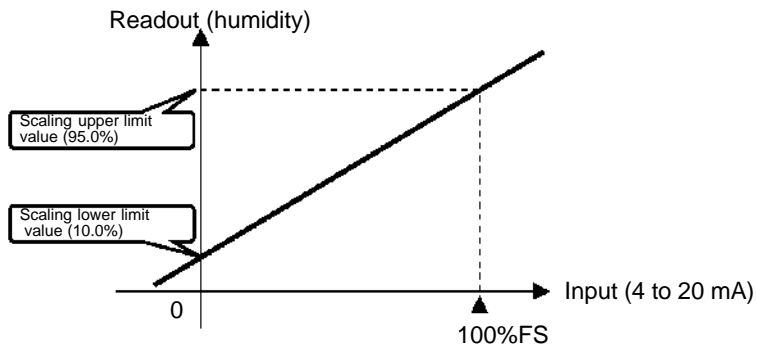

Setting Example

In this example, let's check the input type and temperature units, and shift the lower limit by 1°C and the upper limit by 3°C.

“input type” = “2: K”
 “temperature unit” = “°C”
 “input shift upper limit” = “3.0”
 “input shift lower limit” = “1.0”

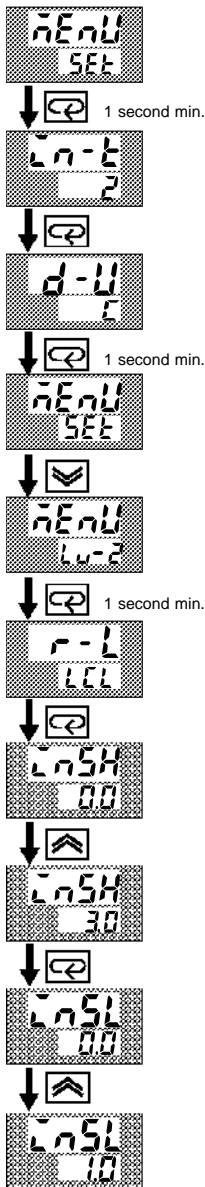

- (1) Select the menu display, and select “ SET : setup mode” using the or keys. For details on selecting the menu display, see page 1-7.
- (2) Press the key for one second minimum to enter the setup mode. The top parameter in the setup mode “ I-T : input type” is displayed. This parameter is factory-set to “2: K”.
- (3) Press the key to fix the set value. The display changes to “ d-U : °C/°F selection” parameter. This parameter is factory-set to “°C”.
- (4) Select the menu display, and select “ L-R : level 2 mode” using the or keys.
- (5) Press the key for one second minimum to enter the level 2 mode. The top parameter in the level 2 mode [L-R] (“local/remote” parameter) is displayed.
- (6) Press the key until [LW-2] (“input shift upper limit” parameter) is selected. This parameter is factory-set to “0.0”.
- (7) Press the key until “3.0” is displayed.
- (8) Press the key until [L-L] (“input shift lower limit” parameter) is selected. This parameter is factory-set to “0.0”.
- (9) Press the key until “1.0” is displayed. This sets the “input shift upper limit” and “input shift lower limit” values.

3.3 Setting Output Specifications

+ Output assignments

- Ten output are supported.
These functions are assigned to control outputs 1 and 2, and auxiliary output 1 and 2.
- Restrictions on assignment destination are placed on some of the outputs. The following table shows where outputs may be assigned to.

Output Function \ Assignment Destination	Control Output		Auxiliary Output	
	1	2	1	2
Control output (heat)	●	●		
Control output (cool)	●	●		
Alarm 1	●	●	●	●
Alarm 2	●	●	●	●
Alarm 3	●	●	●	●
HBA	●	●	●	●
LBA	●	●	●	●
Error 1; Input error			●	●
Error 2; A/D converter error			●	●
Error 3; RSP input error			●	●

With control output (cool), the conditions for switching from standard control to heating and cooling control are reached when the output function is assigned at the cooling side during heating and cooling control.

In other words, heating and cooling control is carried out when control output (cool) is assigned, and standard control is carried out when output is not assigned. For details on heating and cooling control, see 4.1 Selecting the Control Method (page 4-2).

- Factory settings are as follows:
 - control output 1 = Control output (heat)
 - control output 2 = Alarm 1
 - auxiliary output 1 = Alarm 2
 - auxiliary output 2 = Alarm 3.
- Output assignments are set in the “control output 1 assignment”, “control output 2 assignment”, “aux output 1 assignment” and “aux output 2 assignment” parameters (setup mode).

+ Direct/reverse operation



- “Direct operation” (or normal operation) refers to control where the manipulated variable is increased according to the increase in the process value. Alternatively, “reverse operation” refers to control where the manipulated variable is decreased according to the decrease in the process value.

For example, when the process value (PV), is lower than the set point (SP), in a heating control system, the manipulated variable increases by the difference between the PV and SP values.

Accordingly, this becomes “reverse operation” in a heating control system. Alternatively, this becomes “direct operation” in a cooling control system.

- Direct/reverse operation is set in the [$\bar{d}r - r$] “direct/reverse operation” parameter (setup mode).

+ Control period

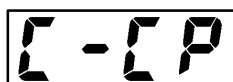
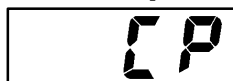

- When the output unit is pulse output such as relay output, set the pulse output cycle (control period). Though a shorter pulse period provides better control performance, the control period should be set taking the life expectancy of the output unit into consideration when the output unit is relay. It is recommended that the control period be set to longer than 20 seconds.
- The control period is set in the “control period (heat)” parameter (level 1 mode). Factory setting is “20:20 seconds.”
- The “control period (cool)” output function is not allocated. So, the “control period (cool)” parameter cannot be set.

Setting Example

In this example, let's set the parameters as follows:

- “control output 1 assignment” = “control output (heat)”
- “control output 2 assignment” = “alarm output 1”
- “direct/reverse operation” = “reverse operation”
- “control period” = “20 sec.”

All of the above settings in this example are factory settings. So, in this example, we are only going to check the parameter settings.

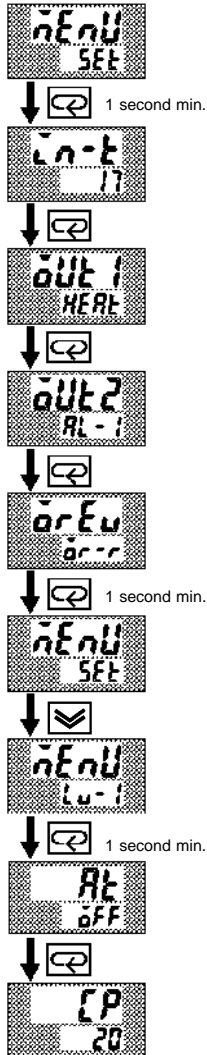

- (1) Select the menu display, and select [**SET**] (setup mode) using the or keys. For details on selecting the menu display, see page 1-7.
- (2) Press the key for one second minimum to enter the setup mode. The top parameter in the setup mode [**IN-T**] “input type” is displayed. In this example, the parameter setting is “17: 4 to 20 mA.”
- (3) Press the key until [**OUT 1**] (“control output 1 assignment” parameter) is displayed. The parameter default is [**HEAT**].
- (4) As the setting in this example is to be left as it is, press the key. The display changes to [**OUT 2**] (“control output 2 assignment” parameter). The parameter default is [**AL - 1**].
- (5) As the setting in this example is to be left as it is, press the key until [**OR-E**] (“direct/reverse operation” parameter) is displayed. The parameter default is [**OR - R**].
- (6) As the setting in this example is to be left as it is, press the or keys to select [**L - 1**] (level 1 mode).
- (7) Press the key for one second minimum to enter the level 1 mode. The top parameter in the level 1 mode [**AL**] “AT execute/cancel” is displayed.
- (8) Press the key until [**CP**] (“control period” parameter) is displayed. The parameter default is “20”. As the setting in this example is to be left as it is, quit key operation.

3.4 Setting Alarm Type

- Three alarm outputs are supported: alarms 1 to 3. Of these, only the alarm assigned as the output can be used.
- Alarm output conditions are determined according to the combination of the “alarm type”, “alarm value” and “alarm hysteresis” parameter settings.
- The contact conditions when alarm output is ON can be set to “open” or “closed” in the “close in alarm/open in alarm” parameter.
- The following table shows the alarm types supported by the E5EK-DRT controller and their respective operations.

+ Alarm type

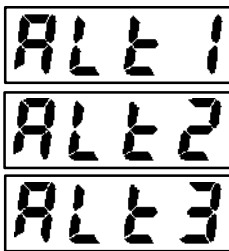

Alarm Type		Alarm Output Operation	
		When X is positive	When X is negative
1	Upper-and lower-limit alarm (deviation)	ON OFF	Always ON
2	Upper-limit alarm (deviation)	ON OFF	ON OFF
3	Lower-limit alarm (deviation)	ON OFF	ON OFF
4	Upper-and-lower-limit range alarm (deviation)	ON OFF	Always OFF
5	Upper-and-lower-limit alarm with standby sequence (deviation)	ON OFF	Always OFF
6	Upper-limit alarm with standby sequence (deviation)	ON OFF	ON OFF
7	Lower-limit alarm with standby sequence (deviation)	ON OFF	ON OFF
8	Absolute-value upper-limit alarm	ON OFF	ON OFF
9	Absolute-value lower-limit alarm	ON OFF	ON OFF
10	Absolute-value upper-limit alarm with standby sequence	ON OFF	ON OFF
11	Absolute-value lower-limit alarm with standby sequence	ON OFF	ON OFF

- Alarm types are set independently for each alarm in the “alarm 1 to 3” parameters (setup mode). Factory setting is “2: Upper-limit alarm (deviation)”.
- Alarm values are indicated by “X” in the table above. Alarm output operation differs according to whether the value of the alarm is positive or negative.
- Alarm values are set independently for each alarm in the “alarm value 1 to 3” parameters (level 1 mode). Factory setting is “0”.

+ Alarm value



+ Alarm hysteresis

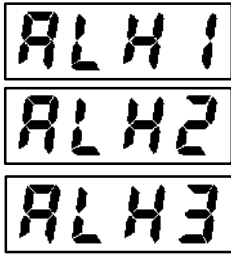

- The hysteresis of alarm outputs when alarms are switched ON/OFF can be set as follows.

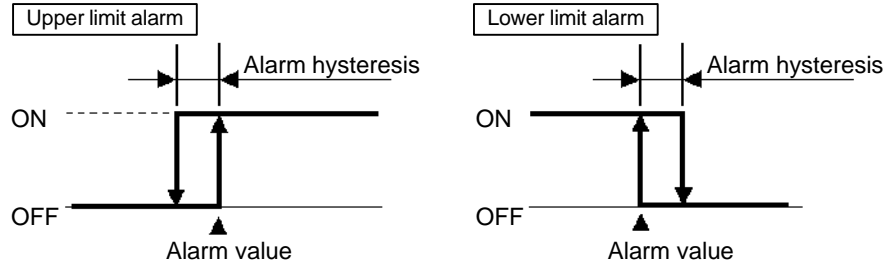

' Standby sequence

- Alarm hysteresis is set independently for each alarm in the “alarm 1 to 3 hysteresis” parameters (level 2 mode). Factory setting is “0.02: 0.02%FS”.
- “Standby sequence” is a function for unconditionally turning alarm output OFF when the process value has left the alarm range once and it next enters the alarm range.
- For example, when the alarm type is set to “deviation lower limit,” generally the process value is within the alarm range, and alarm output become ON as it is as the process value when the power is turned ON is smaller than the set point. However, if the alarm type is set to “deviation lower limit with standby sequence”, alarm output first becomes ON when the process value exceeds the alarm setting value to leave the alarm range and once again falls below the alarm value.
- When an alarm is output, the standby sequence is canceled. For details on the standby sequence reset conditions, see “Chapter 5, Expansion Mode, Standby sequence reset method” on page 5-34.

+ Close in alarm/open in alarm



- When the controller is set to “close in alarm,” the status of the alarm output function is output as it is. When set to “open in alarm,” the status of the alarm output function is output inverted.

	Alarm	Output	Output LED
Close in alarm	ON	ON	Lit
	OFF	OFF	Not lit
Open in alarm	ON	OFF	Lit
	OFF	ON	Not lit

- Alarm type and close in alarm (normally open)/open in alarm (normally close) can be set independently for each alarm.
- Close in alarm/open in alarm is set in the “alarm 1 to 3 open in alarm” parameters (setup mode). Factory setting is [n - 0] “close in alarm”.

' Summary of alarm operations

The figure below visually summarizes the above description of alarm operations (when alarm type is set to “lower limit alarm (deviation) with standby sequence”):

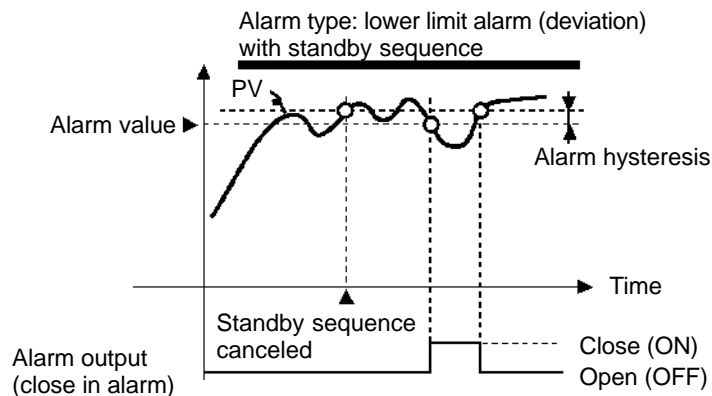

Setting Example

When a set point for a temperature exceeds $\pm 10\%$, alarm1 will be output.

In this example, let's set the parameters as follows:

- “alarm type 1” = “1: (deviation upper-and lower-limit)”
- “alarm value 1” = “10”
- “alarm hysteresis” = “0.20”
- “close in alarm/open in alarm” = “ $\bar{a} - \bar{a}$: close in alarm”

Meanings of parameters, “alarm hysteresis” and “open in alarm/close in alarm” are the same settings at the shipment, so settings for operations are omitted.

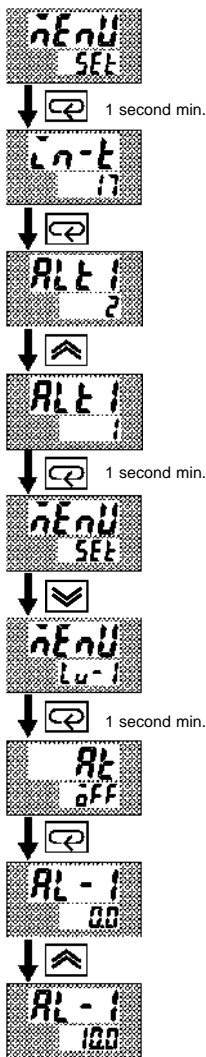

- (1) Select the menu display, and select [SET] (setup mode) using the or keys. For details on selecting the menu display, see page 1-7.
- (2) Press the key for one second minimum to enter the setup mode. The top parameter in the setup mode [L u - l] “input type” is displayed. In this example, the parameter setting is “17: 4 to 20 mA”.
- (3) Press the key until [AL - 1] (“alarm type 1” parameter) is displayed. The parameter default is “2: deviation upper limit”.
- (4) Press the key to return to “1: deviation upper-and-lower limit”.
- (5) Select the menu key, and select [L u - l] (level 1 mode) using the or keys.
- (6) Press the key for one second minimum to enter the level 1 mode. The top parameter in the level 1 mode [AL - 1] “AT execute/cancel” is displayed.
- (7) Press the key until [AL - 1] (“alarm value 1” parameter) is displayed.
- (8) In this example, the parameter setting is “0.0” so press the key until “10.0” is displayed.



About the Decimal Point of the Alarm Value

The decimal point of the alarm value conforms to the setting of the “decimal point” parameter (setup mode). (During temperature input, the decimal point of the alarm value conforms to the set sensor.)

3.5 Protect Mode

+ Security



- This parameter allows you to protect until start of operation parameters that do not change during operation to prevent unwanted modification.
- The range of usable parameters is specified by the set value of the “security” (protect) parameter.
- The following table shows which modes are protected by this set value:

Mode	Set Value						
	0	1	2	3	4	5	6
Calibration	●						
Option	●	●					
Expansion	●	●					
Setup	●	●					
Level 2	●	●	●				
Level 1	●	●	●	●			
Level 0	●	●	●	●	●	*2	*1

● Indicates operable (unprotected) modes.

*1 The “PV/SP” parameter can only be displayed.

*2 Only the “PV/SP” parameter can be used.

- When “0” is set, parameters are not protected.
- When “5” is set, only the “PV/SP” parameter can be used.
- When “6” is set, the “PV/SP” parameter can only be monitored.
- Default is “1”.

+ A/M key protect



- This parameter disables use of the **A/M** key during operation. For example, if you protect use of the **A/M** key by the “A/M key protect” parameter (protect mode) during auto operation, the controller cannot be set to the manual mode, preventing manual operation of the controller during operation.

Setting Example

- Let’s protect the setup, expansion, option and calibration modes. Set the parameters as follows:

“security” = “2: Usable only in level 0 to 2 modes”

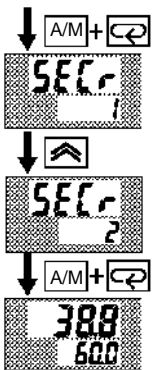

- (1) Press for 1 second minimum the **A/M** and **→** keys simultaneously, the controller enters the protect mode.
- (2) In the protect mode, the top parameter in the protect mode “security” is displayed. The parameter default is “1”. Press the **↑** key to change the parameter setting to “2”.
- (3) Press for 1 second minimum the **A/M** and **→** keys simultaneously, the display changes to the “PV/SP monitor” parameter (level 0 mode).

3.6 Starting and Stopping Operation



- You can start and stop operation by changing the setting of the “run/stop” parameter (level 0 mode).
- You can switch the RUN/STOP function up to 100,000 times.
- To stop operation, set the “run/stop” parameter to [5 t 0 P] (stop). In a stop state, the “STOP” LED lights.
- Operation cannot be stopped during auto-tuning.

Manipulated variable at stop

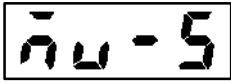

- Specify the manipulated variable (-5.0 to 105.0%) in the “MV at stop” parameter (level 2 mode) to output the manipulated variable during stop.
Factory-set to “0.0 : 0.0%”

Setting Example

The following example describes the procedure to follow to stop control during operation of the controller.

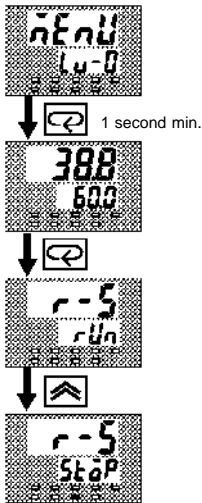



- (1) Select the menu display, and select [L - 0] (level 0 mode) using the or keys. For details on selecting the menu display, see page 1-7.
- (2) Press the key for one second minimum to enter the level 0 mode. The PV and SP are displayed.
- (3) Press the key until [r - 5] (“run/stop” parameter) is displayed.
- (4) Press the key to select [5 t 0 P] (stop). The “STOP” LED lights, and operation stops.

To resume operation, follow the above procedure to select [r ū n] (“run”). The “STOP” LED goes out and operation starts.

3.7 Adjusting Control Operation

+ Changing the set point

- You can change the set point in the “set point” parameter (level 0 mode).
- However, note that you cannot change the set point when the “security” parameter (protect mode) is set to “6”.
- To change the set point, press the  or  keys to select the desired value. If you leave the setting for two seconds, the set point is updated to the new setting.

Setting Example



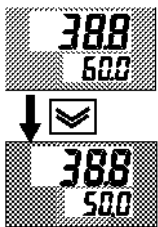

In the following example, let's change the temperature set point from “60°C” to “50°C”.

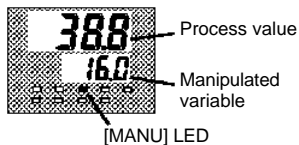

- (1) Select the PV/SP monitor display.
- (2) Press the  key to change the setting to “50.0: 50.0°C”.

+ Manual operation



- The manipulated variable is controlled.
- To set manual operation and manually set the manipulated variable or the valve opening, press for 1 second minimum the  key. The controller enters the manual mode.
To end the manual mode, press the  key for 1 second minimum. The mode returns to the level 0 mode.
- The process value is displayed on the No.1 display, and the manipulated variable is displayed on the No.2 display.
- To change the manipulated variable, press the  or  keys. After two seconds, the manipulated variable is updated to the new setting.
- Other modes cannot be selected while in the manual mode. To select other modes, quit the manual mode.
- The automatic return of display function does not work while in the manual mode.
- When switching between manual and auto operation, the manipulated variable is subject to balance-less, bump-less operation.
- If the power is interrupted during manual operation, manual operation is resumed at the manipulated variable at power interruption when the power is reset.
- You can switch the AUTO/MANUAL function up to 100,000 times.



Balance-less,
Bump-less
Operation

To prevent sudden changes in the manipulated variable when switching between manual and auto operation, operation is resumed using the value that was active immediately before operation was switched, and the value is brought gradually closer to the value immediately after operation was switched.

The following diagram summarizes manual operation.

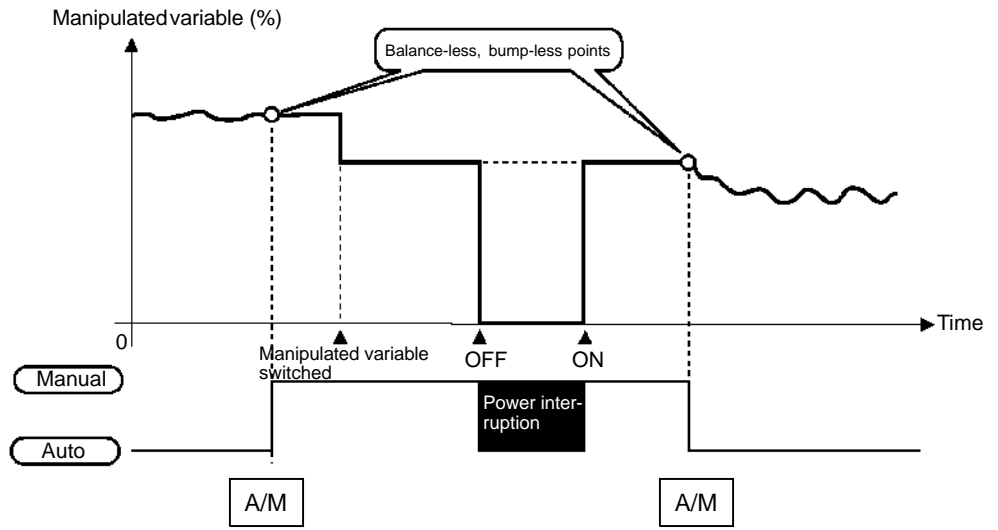

+ Auto-tuning (A.T.)



- AT (auto-tuning) cannot be executed while operation is canceled or during ON/OFF control.
- When you execute auto-tuning, the optimum PID parameters for the current set point at execution are automatically set by forcibly changing the manipulated variable to calculate the characteristics (called the “limit cycle method”) of the control target. During auto-tuning, the AT LED flashes.
- 40%AT or 100%AT can be selected by the limit cycle of MV change width. Specify [AT - 1] or [AT - 2], respectively, in the “AT execute/cancel” parameter (level 1 mode).
- During heating and cooling control, only 100%AT can be executed. (So, [AT - 1] (40%AT) will not be displayed.)
- To cancel AT execution, specify [OFF] (“AT cancel”).

' 40%AT



In order to set the limit cycle of MV change width to 40%, select 40%AT to execute auto-tuning with fluctuations in the process value kept to a minimum. However, note that auto-tuning takes longer time to execute compared with 100%AT.

The timing by which limit cycles are generated varies according to whether or not the deviation (DV) at the start of AT execution is 10% full-scale or less.

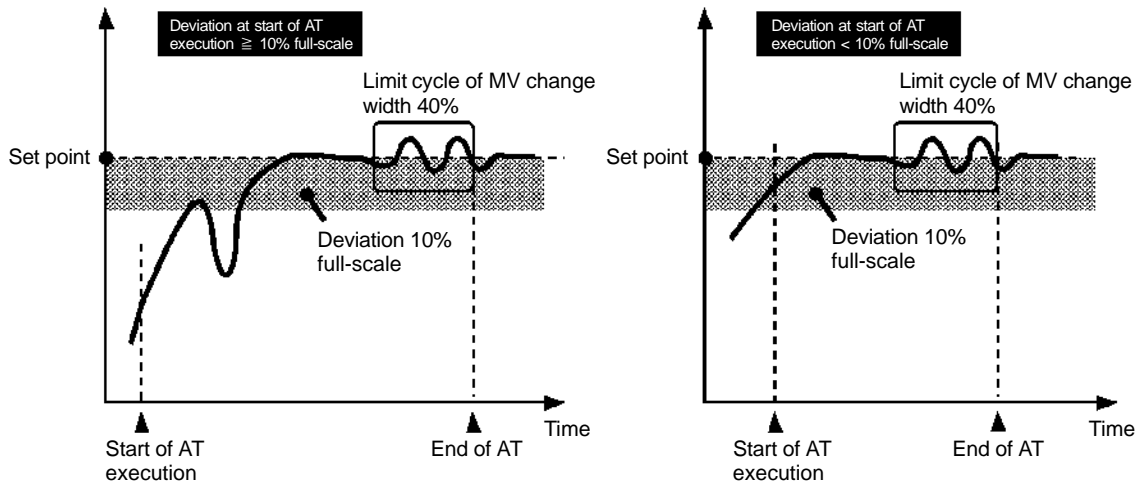

' 100%AT



In order to set the limit cycle of MV change width to 100%, select 100% AT to shorten the AT execution time without worrying about fluctuations in the process value.

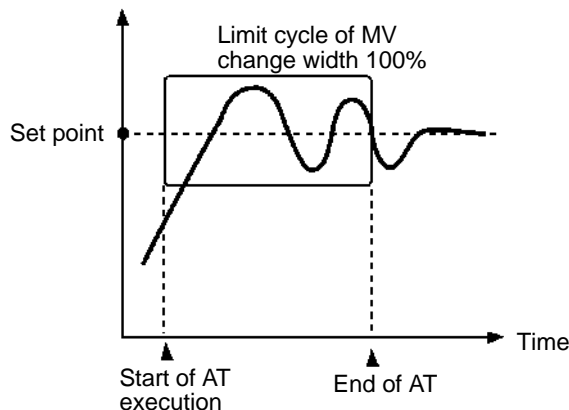

Setting Example

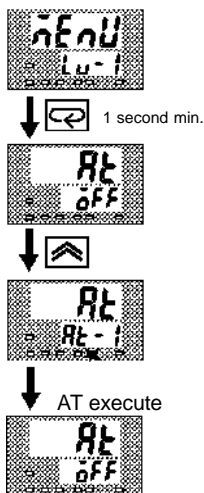

In this example, let's execute 40%AT.

- (1) Select [Lv - 1] (level 1 mode) using the or keys. For details on selecting the menu display, see page 1-7.
- (2) Press the key for one second minimum to enter the level 1 mode. The top parameter in the setup mode [AT] “AT execute/cancel” is displayed. In this example, the parameter setting is [OFF] “AT cancel”
- (3) Press the key to specify [AT - 1].
- (4) The AT LED flashes, and AT execution starts. When the AT LED goes out (end of AT execution), the parameter automatically returns to [OFF] (“AT cancel”).



About PID Parameters

When control characteristics are already known, the PID parameters can be set directly to adjust control.

PID parameters are set in the “proportional band” (P), “integrated time” (I) and “derivative time” (D) parameters (level 1 mode).

For details on the setting ranges of these parameters, see chapter 5 Level 1 Mode (page 5-12).

K CHAPTER 4

APPLIED OPERATION

This chapter describes each of the parameters required for making full use of the features of the E5EK-DRT. Read this chapter while referring to the parameter descriptions in chapter 5.

4.1	Selecting the Control Method	4-2
	Heating and cooling control	4-2
	ON/OFF control	4-3
4.2	Operating Condition Restrictions	4-4
	Manipulated variable restrictions	4-4
	Set point limiter	4-5
	SP ramp	4-5
4.3	How to Use the Remote SP	4-7
	Scaling	4-7
	SP mode	4-7
	Remote SP monitor	4-8
	SP tracking	4-8
	Operating conditions	4-8
4.4	How to Use the Heater Burnout Alarm ...	4-9
	Heater burnout detection	4-9
	Operating conditions	4-9
	How to calculate the heater burnout set value	4-10
4.5	LBA	4-11

4.1 Selecting the Control Method

+ Heating and cooling control

When selecting the control method, set the parameters according to the following table. (Parameters are factory-set to heating control.)

Parameter / Control Method	Control output 1 assignment	Control output 2 assignment	Direct/Reverse operations
Heating control (Standard)	Control output (heat)	-	Reverse operation
Cooling control (Standard)	Control output (heat)	-	Direct operation
Heating and cooling control	Control output (heat)	Control output (cool)	Reverse operation

For details on how to assign outputs, see 3.3 Setting Output Specifications (page 3-7).

- When heating and cooling control is selected, the “deadband” and “cooling coefficient” parameters can be used.

′ Dead band

The dead band is set with the set point as its center. The dead band width is the set value of the “dead band” parameter (level 1 mode). Setting a positive value produces a dead band, while setting a negative value produces an overlap band. Default is set to “0.00: 0.00% FS.”

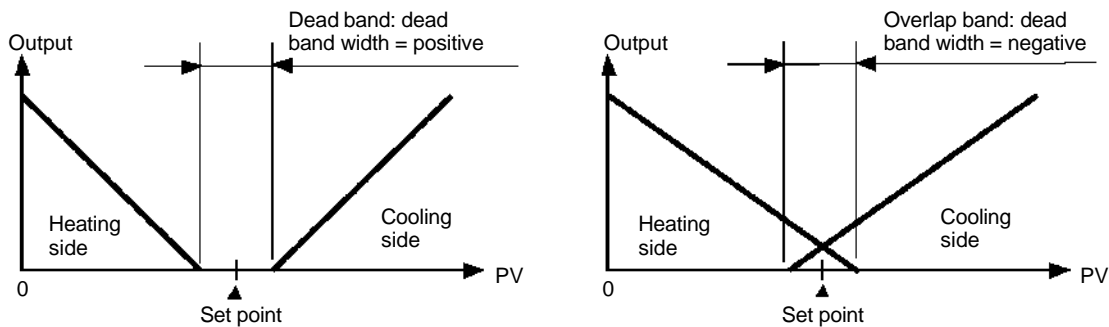

′ Cooling coefficient

If the heating and cooling characteristics of the control target greatly differ, preventing satisfactory control characteristics from being obtained by the same PID parameters, adjust the proportional band (P at cooling side) using the cooling coefficient to balance control between the heating and cooling sides. In heating and cooling control, P at the heating or cooling side is calculated by the following formula:

$$\text{Heating side P} = P; \text{Cooling side P} = \text{cooling coefficient} \times P$$

′ Manipulated variable at stop

- In heating and cooling control, the manipulated variable output that is output when controller operation is stopped is dependent on the set value of the “MV at stop” parameter (level 2 mode) in the same way as for standard control.
- However, note that in heating and cooling control, the manipulated variable at the cooling side is treated as a negative value for the sake of convenience. When the manipulated variable at STOP is a negative value, the manipulated variable is output to only the cooling side, and when a positive value, the manipulated variable is output to only the heating side. The factory setting is “0”. If the controller is operated using the factory setting, the manipulated variable is not output to both the heating and cooling sides.



Switching with Manual operation

When the overlap band is set, the bumpless function that operates when switching between manual and automatic operation may not work.

+ ON/OFF control

' Hysteresis

- Switching between 2-PID control and ON/OFF control is carried out by the “PID/ON/OFF” parameter (expansion mode). When this parameter is set to [P L d], 2-PID control is selected, and when set to [a n a F], ON/OFF control is selected. Default is [P L d].
- In ON/OFF control, hysteresis is provided in the program when switching between ON and OFF to stabilize operation. The hysteresis width provided during ON/OFF control is simply referred to as “hysteresis.” Control output (heat) and control output (cool) functions are set in the “hysteresis (heat)” and “hysteresis (cool)” parameters, respectively.
- In standard control (heating or cooling control), hysteresis can be set only for the heating side.

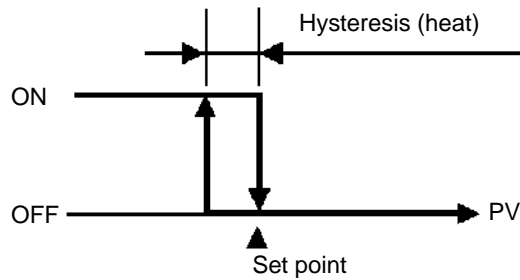

- In heating and cooling control, a dead band can be set. So, 3-position control is made possible.

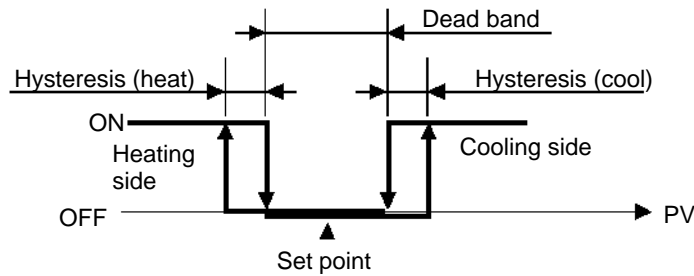

Parameters

Symbol	Parameter Name: Mode	Description
ãÙt 1	Control output 1 assignment : Setup	For specifying control method
ãÙt 2	Control output 2 assignment : Setup	For specifying control method
ãrEu	Direct/Reverse operation : Setup	For specifying control method
[-db	Dead band : Level 1	Heating and cooling control
[-S[-	Cooling coefficient : Level 1	Heating and cooling control
ãu-S	MV at stop : Level 2	Manipulated variable when control operation is stopped
ãu-E	MV at PV error : Level 2	Manipulated variable when control operation is PV error
HYS	Hysteresis (heat) : Level 1	ON/OFF control
[HYS	Hysteresis (cool) : Level 1	ON/OFF control
[nEL	PID / ON/OFF : Expansion	ON/OFF control

4.2 Operating Condition Restrictions

+ Manipulated variable restrictions

The upper-and lower-limit values of the manipulated variable can be restricted by the MV limiter, and the change rate of the manipulated variable can be restricted by the MV change rate limiter.

· MV limiter

The upper-and lower-limit values of the manipulated variable are set in the “MV upper limit” and “MV lower limit” parameters (level 2 mode). When the manipulated variable calculated by the E5EK-DRT is outside of the range of the MV limiter, actual outputs are dependent on the set value of these parameters.

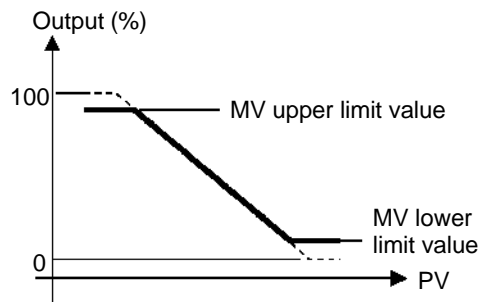

In heating and cooling control, the manipulated variable at the cooling side is treated as a negative value for the sake of convenience. The upper limit is set for the heating side (positive value), and the lower limit is set for the cooling side (negative value) as shown in the following figure.

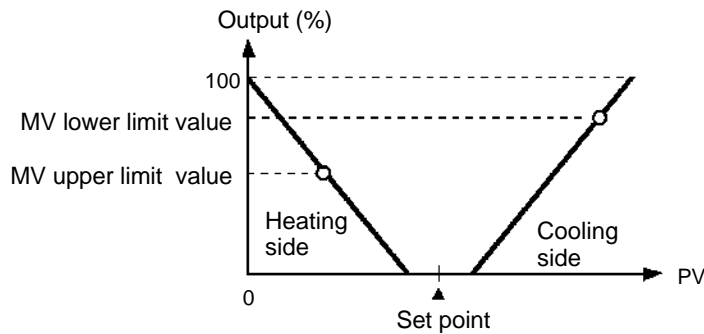

· MV change rate limiter

The “MV change rate limit” parameter (level 2 mode) sets the maximum permissible change width per second of the manipulated variable. If a change in the manipulated variable exceeds this parameter setting, the value calculated by the E5EK-DRT is reached while changing the value by the per-second value set in this parameter.

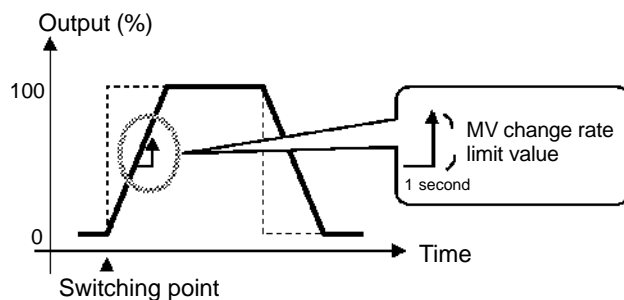

’ Limiter operation conditions

The limiters are invalid or cannot be set when any of the following conditions occurs:

- During ON/OFF control
- During AT execution (only by MV change rate limiter)
- During manual operation
- When operation is stopped
- When an error has occurred.

+ Set point limiter

The setting range of the set point is limited by the set point limiter. The upper-and lower-limit values of this set point limiter are set in the “Set point upper limit” and “Set point lower limit” parameters (expansion mode), respectively. However, note that when the set point limiter is reset, the set point is forcibly changed to the upper-or lower-limit value of the set point limiter if the set point is out of the limiter range. Also, when the input type, temperature unit and scaling (sensor) range are changed, set point limiter is forcibly reset to the scaling (sensor) range.

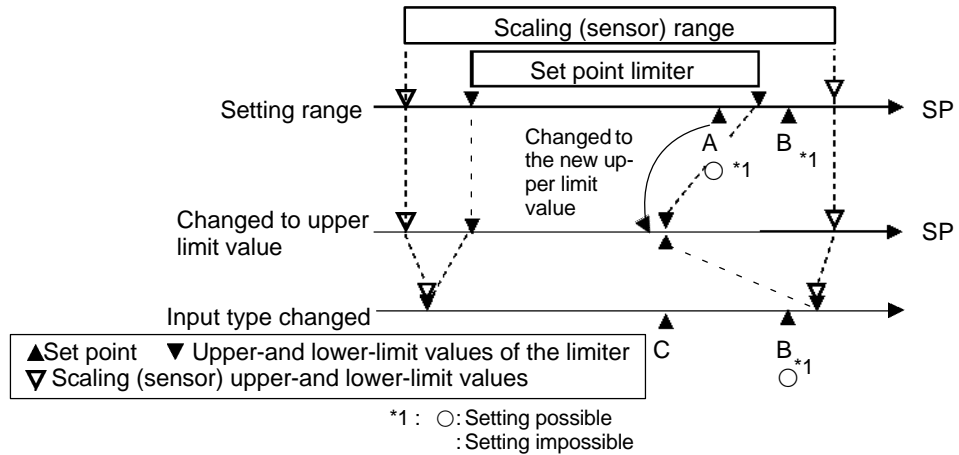

+ SP ramp

With the SP ramp function, the controller operates according to the value (set point during SP ramp) limited by a change rate, instead of the changed set point when set point is changed. The interval in which the set point during SP ramp is limited is referred to as the “SP ramp”.

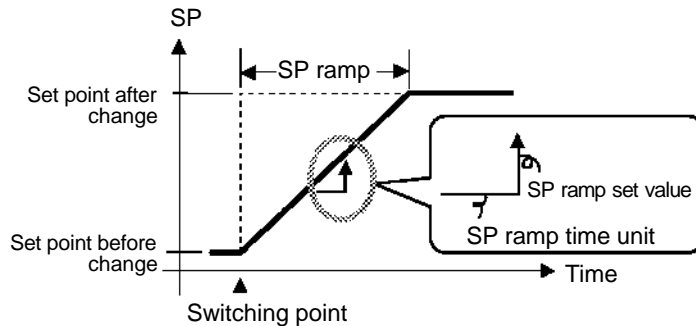

The change rate during the SP ramp is specified by the “SP ramp set value” and “SP ramp time unit” parameters. At the “SP ramp set value” default “0”, the SP ramp function is disabled.

The set point changing in SP ramp can be monitored in the “Set point during SP ramp” parameter (level 0 mode).

Operation at start

The limiters are invalid or cannot be set when any of the following conditions occurs:

If the SP ramp function is enabled when the power is turned ON, and when “run” is switched to from “stop,” process value may reach the set point after SP ramp in the same way as when the set point is changed. In this case, operation is carried out with the process value regarded as the set point before the change was made.

The direction of the SP ramp changes according to the relationship between the process value and the set point.

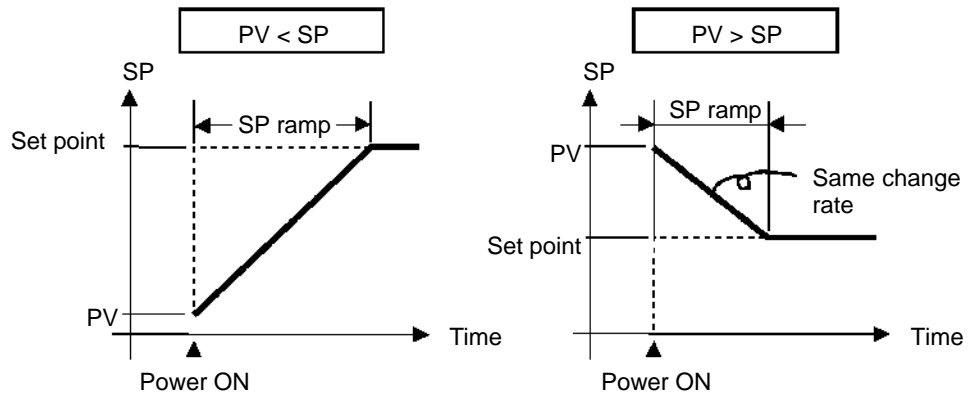

Restrictions during SP ramp

- Execution of auto-tuning starts after the end of SP ramp.
- When the controller is switched to the manual mode, the set point changes continuously until SP ramp ends.
- When the controller is in the stop state or an error occurs, the SP ramp function becomes invalid.

Parameters

Symbol	Parameter Name: Mode	Description
$\bar{o}L-H$	MV upper limit : Level 2	Manipulated variable restrictions
$\bar{o}L-L$	MV lower limit : Level 2	Manipulated variable restrictions
$\bar{o}rL$	MV change rate limit : Level 2	Manipulated variable restrictions
$S\bar{L}-H$	SP setting upper limit: Expansion	SP setting restrictions
$S\bar{L}-L$	SP setting lower limit : Expansion	SP setting restrictions
$SPr\bar{t}$	SP ramp set value : Level 2	SP changing restrictions
$SPr\bar{u}$	SP ramp time unit : Level 2	SP changing restrictions

4.3 How to Use the Remote SP

+ Scaling

- Taking a remote SP input (4 to 20 mA) as the set point is referred to as the “remote SP” function. The remote SP function is enabled only when the “remote SP (RSP) enable” parameter (option mode) is set to “ON”.
- Remote SP upper-and lower-limit values can be set by scaling.
- Inputs within the range 4 to 20 mA (-10 to 110%) are allowed as remote SP inputs. Inputs not within this range are regarded as out-of-range input values. In this case, input is clamped at the remote SP lower or upper limit values, and the “RSP” LED blinks.
- If the output function “RSP input error” is assigned for when an out-of-range remote SP is input, the “RSP input error” output is turned ON. Control output also switches to the setting of the “MV at PV error” parameter.
- Set the upper limit value in the “remote SP upper limit” parameter and the lower limit value in the “remote SP lower limit” parameter (option mode).

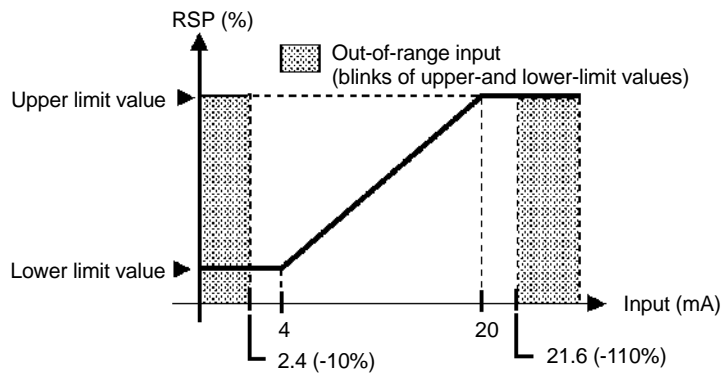

Relationship with set point limiter

- When the “SP setting upper limit” or “SP setting lower limit” parameters are changed, the remote SP upper-and lower-limit values are forcibly changed to the set point upper-and lower-limit values. The following example shows how the remote SP upper-and lower-limit values are changed when the set point upper limit value is changed from A to B.

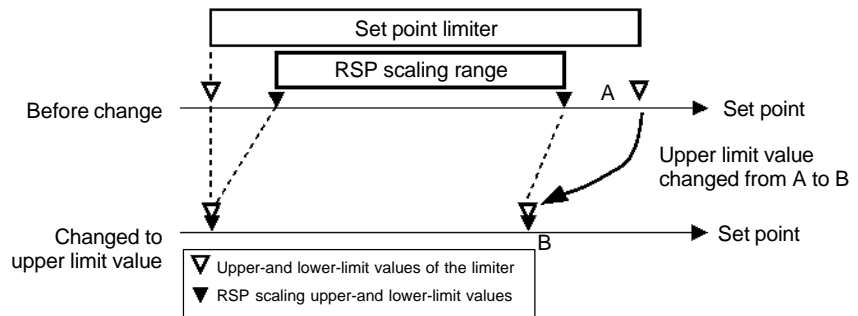

+ SP mode

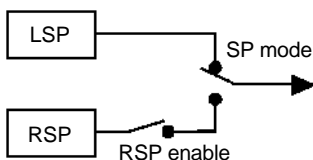

- The set point held internally by the E5EK-DRT controller is referred to as the “local SP (LSP).”
- Use the “SP mode” parameter to switch between the remote SP and local SP. When the SP mode parameter is set to “RSP” (remote SP), the “RSP” LED lights. When the SP mode parameter is set to “LSP”, the controller is in the local SP.

+ **Remote SP monitor**

- In the remote SP mode, the remote SP can be monitored on the No.2 display for PV/SP. In the local SP mode, the remote SP can be monitored in the “remote SP monitor” parameter.

+ **SP tracking**

- When the local SP is switched to from the remote SP when the SP tracking function is enabled, the local SP is changed so that the remote SP value is held at the SP value used immediately before switching. To use the SP tracking function, set the “SP tracking” parameter to “ON”.
- The following figure shows how SP tracking works when the SP mode is switched.

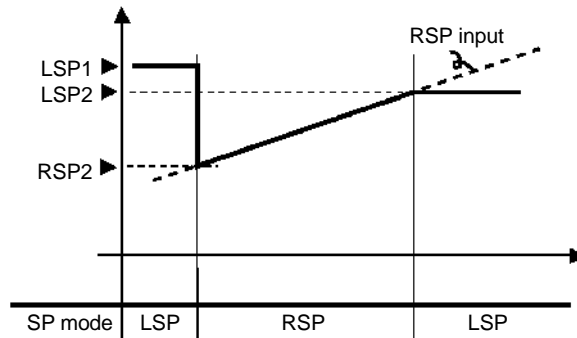

- (1) When the remote SP is switched to when the set point is “LSP1”, the SP is switched to “RSP2”.
 - (2) The SP shifts according to remote SP input.
 - (3) When the local SP is switched to, the set point becomes “LSP2” if the SP tracking function is enabled. If this function is disabled, the SP will be switched to “LSP1”.
- When the local SP is switched to the remote SP, the SP ramp will operate if the SP ramp function is enabled.

+ **Operating conditions**

- During auto-tuning, remote SP input is not accepted. Auto-tuning is executed on the set point at the start of auto-tuning.
- Remote SP is not subject to the standby sequence reset conditions.

Parameters

Symbol	Parameter Name: Mode	Application
<i>rSPU</i>	Remote SP enable : Option	Remote SP function
<i>rSPH</i>	Remote SP upper limit : Option	RSP scaling
<i>rSPL</i>	Remote SP lower limit : Option	RSP scaling
<i>SPnd</i>	SP mode : Level 2	LSP/RSP switching
<i>SPtr</i>	SP tracking : Option	SP tracking

4.4 How to Use the Heater Burnout Alarm

+ Heater burnout detection

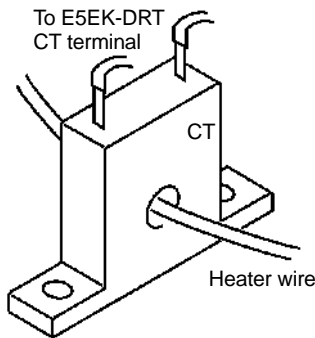

' HBA latch/release

+ Operating conditions

- On a standard type controller, the HBA (heater burnout alarm) function can be used only when the assignment destination of the output function “control output (heat)” is set to pulsed output.
- When using the HBA function, assign output function “heater burnout (HB) alarm” to control output 1 or 2, auxiliary outputs 1 or 2.
- Heater burnout detection works as follows.
 - (1) Connect the current transformer (CT) to terminal Nos.15 and 17, and insert the heater lead through the CT hole.
 - (2) When current flows through this lead, the current transformer generates AC current proportional to the current value. The E5EK-DRT measures this AC current to calculate the current flowing to the heater.
 - (3) If heater is burned out, the current measured at the current transformer decreases. This value is compared with the value set as the heater burnout set value and is output as the heater burnout alarm.
- Set the heater burnout set value in the “heater burnout alarm” parameter. To check the current value of the current transformer, use the “heater current monitor” parameter.
- When you are not using the HBA function, set the “heater burnout alarm” parameter to “0.0 (disabled)”.
- When the HBA latch function is set to “ON”, the heater burnout alarm is held until either of the following measures is taken:
 - a Set the heater burnout set value to “0.0A” (default).
 - b Reset the controller.
(Turn the controller’s power OFF then back ON again.)
- To enable the HBA latch function, set the “HBA latch” parameter to “ON”.
- Turn the heater power supply ON at the same time as or before turning the E5EK-DRT power supply ON. If the heater power supply is turned ON after turning the E5EK-DRT power supply On, the heater burnout alarm is output.
- Control is continued even when the heater burnout alarm is output. (That is, the controller attempts to control the heater as if the heater burnout alarm has not occurred.) So, remedy the condition such as repairs which are caused by the heater burnout alarm.
- The heater burnout alarm is detected only if the control output is continuously ON for 190 ms or more.
- The rated current value may sometimes differ slightly from the actual current value flowing to the heater. Check the current value in an actual operating status in the “heater current monitor” parameter.
- If there is little difference between the current in a normal status and the current in a burnout status, detection may become unstable. On a heater of current 10.0 A or less, maintain a difference of 1.0 A or more. On a heater of current 10.0 A or more, maintain a difference of 2.5 A or more.
- Heater burnout alarm function cannot be used when controlling the heater by a phase control method or by a cycle control method. Also, 3-phase heaters cannot be used.

When detecting heater burnout on a 3-phase heater, use the K2CU-F□□A-□GS (with gate input terminal). (For details, see the respective data sheet.)

+ How to calculate the heater burn-out set value

- Calculate the set value by the following formulæ:

$$\text{Set value} = \frac{(\text{current value at normal operation} + \text{current value at burnout})}{2}$$
- Set the current value at burnout when two or more heaters are connected to the CT to the value at the time that the heater having the smallest current value burns out (the value when one of the heaters burns out with all heaters at the same current).
- Make sure that the following condition is satisfied:
 Heater of current 10.0 A or less
 Current value at normal operation – current value at heater burnout ≥ 1 A
 When resultant current is less than 1 A, detection is unstable.
 Heater of current 10.0 A or more
 Current value at normal operation – current value at heater burnout ≥ 2.5 A
 When resultant current is less than 2.5 A, detection is unstable.
- The setting range is 0.1 to 49.9 A. Heater burnout is not detected when the setting is “0.0” or “50.0”. When the setting is “0.0”, the heater burnout alarm is set to “OFF”, and when the setting is “50.0”, the heater burnout alarm is set to “ON”.
- Set the total current value at normal heater operation to 50 A or less. When set to 55.0 A or more, [F F F] is displayed in the “heater current monitor” parameter.

Examples of use

Example 1 : when using a 200 VAC, 1 kW heater

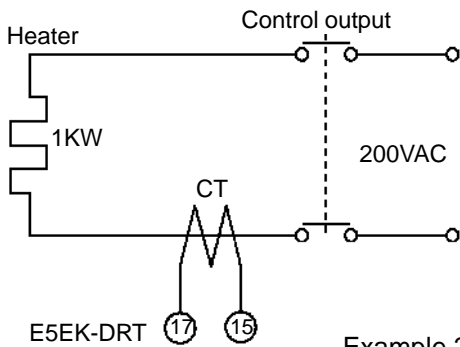

Current at normal operation = $\frac{1000}{200} = 5\text{A} (<10\text{A})$

Current at heater burnout = 0A

Set value = $\frac{5+0}{2} = 2.5\text{A}$

(current at normal operation-current at heater burnout = $5 - 0 = 5\text{A} (\geq 1\text{A})$)

Example 2 : when using three 200 VAC, 1 kW heaters

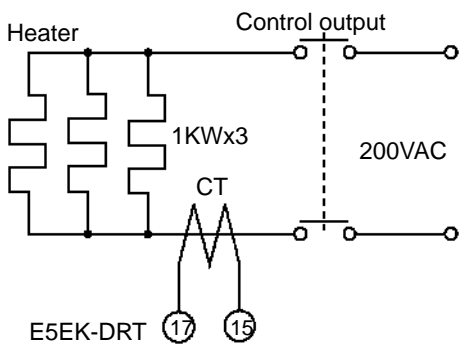

Current at normal operation = $\frac{1000}{200} \times 3 = 15\text{A} (\geq 10\text{A})$

Current at burnout of one heater = $\frac{1000}{200} \times 2 = 10\text{A}$

Set value = $\frac{15+10}{2} = 12.5\text{A}$

(current at normal operation-current at heater burnout = $15 - 10 = 5\text{A} (\geq 2.5\text{A})$)

Parameters

Symbol	Parameter Name: Mode	Application
<i>Ct</i>	Heater current monitor : Level 1	Heater current value monitor
<i>Hb</i>	Heater burnout : Level 1	Heater burnout detection
<i>HbL</i>	Heater burnout latch : Option	Heater burnout detection alarm latch

4.5 LBA

- The LBA function can be used only when assigned as an output. Also, the LBA function does not work when a memory error or A/D converter error results.
 - LBA (Loop Break Alarm) is a function for judging that an error has occurred somewhere on the control loop and outputting an alarm when the process value does not change with the manipulated variable at a maximum or minimum state. Accordingly, the LBA function can be used as a means for detecting a malfunctioning control loop.
- ′ **LBA detection time**
- Normally, when output is set to maximum or minimum, the process value rises or falls after the dead time has elapsed. LBA is output if the process value does not change in the predicted direction after a fixed amount of time has elapsed. This fixed amount of time is the “LBA detection time.”
- ′ **LBA detection width**
- LBA operation sometimes becomes unstable when the process value fluctuates considerably due to the control characteristics. The LBA detection width is provided so that changes with respect to output can be correctly detected. Changes smaller than the detection width due to LBA detection timing are not regarded as changes.
- ′ **LBA detection example**
- The following example describes what happens when a heater burnout at maximum output.

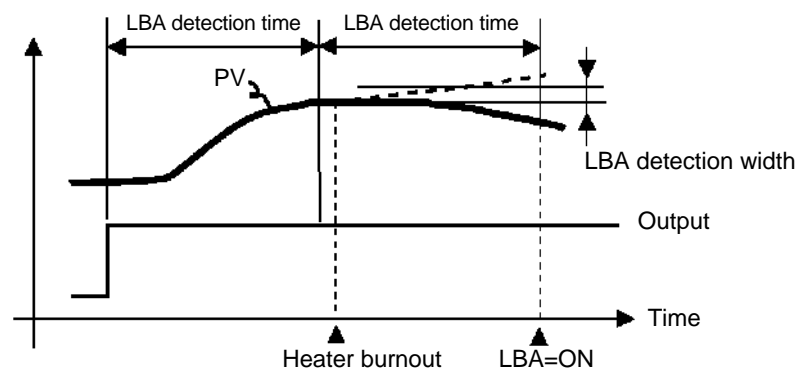

- LBA judgment is carried out at each LBA detection time from the point of maximum output. In above figure, the process value (PV) is changing greatly at the 1st judgment timing, so LBA remains OFF.
- At the 2nd judgment timing, the process value increases as indicated by the broken line of the process value is normal. This means that the change width exceeds the LBA detection width, and LBA output remains OFF.
- If the heater burns out at the point shown in the above figure, the process value “decreases.” Accordingly, it is judged that “the process value is not changing in the increasing direction” at the 2nd judgment timing and the LBA output becomes ON.

Setting the LBA detection time

- The LBA detection time is automatically set by auto-tuning (except in heating and cooling control).
- If the optimum LBA detection time cannot be obtained by auto-tuning, set the time in the “LBA detection time” parameter (level 2 mode).

Determining the LBA detection time

- Calculate the LBA detection time as follows:
 - (1) Set output to maximum.
 - (2) Measure the time it takes for the input change width to reach the LBA detection width (default: 0.2 % full-scale).
 - (3) Take a value twice that of the measurement time as the LBA detection time.

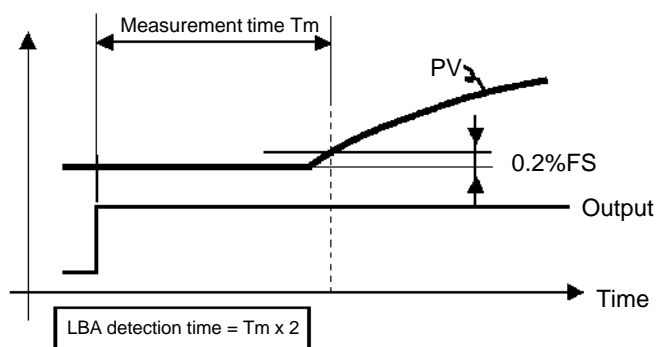

- (4) In the case of ON/OFF operation, set the LBA detection time to a value longer than the control period.

Parameters

Symbol	Parameter Name: Mode	Application
At	AT Execute/Cancel : Level 1	Automatic setting of LBA detection time
LbA	LBA detection time : Level 2	Setting of LBA detection time
LbAb	LBA detection width : Expansion	Changing of LBA detection width

K CHAPTER 5 PARAMETERS

This chapter describes the parameters of the E5EK-DRT. Use this chapter as a reference guide.

Conventions Used in this Chapter	5-2
Protect Mode	5-3
Manual Mode	5-5
Level 0 Mode	5-6
Level 1 Mode	5-10
Level 2 Mode	5-17
Setup Mode	5-24
Expansion Mode	5-31
Option Mode	5-36
Calibration Mode	5-42

Conventions Used in this Chapter

+ The meaning of icons used in this chapter



Function

Describes the functions of the parameter.



Comment

Describes the range and defaults of the parameter setting.



Monitor

Used for monitor-dedicated parameters.

Describes the range of the monitor values and monitor range.



Example
of use

Describes a procedure using parameters in operating instructions.



See

Describes related parameters and items.

+ About parameter display

Parameters are displayed on the E5EK-DRT indicator only when the “Conditions of Use” on the right of the parameter heading are satisfied. However, note that the settings of protected parameters are still valid, and are not displayed regardless of the conditions of use.

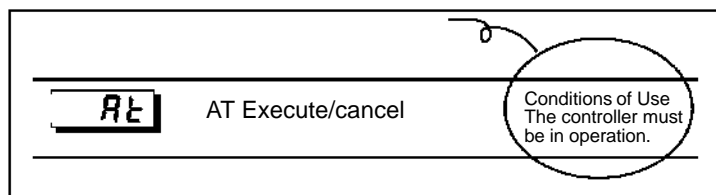

+ About the Order In Which Parameters Are Listed

Parameters are divided by mode.

The first page of each mode lists the contents of the parameters available in that mode. The name of parameters in the contents follows the order in which parameters are displayed on the controller.

Protect Mode

- This mode restricts (protects) key operation to prevent unwanted key operation. Before changing parameters in this mode, first make sure that protecting the menu key or **[A/M]** key will not cause any problems in operation.
- To select this mode, press the **[A/M]** key and **[↶]** key simultaneously for 1 second minimum. To exit this mode, press the **[A/M]** key and **[↷]** key down again simultaneously for 1 second minimum.
- The following table shows the parameters supported in this mode and the page where the parameter is described.

Symbol	Parameter Name	Page
SECr	Security	5-3
PEyP	[A/M] key protect	5-4

SECr Security



Function

- This parameter specifies which parameters are protected. However, note that the protect mode and manual mode cannot be protected.



Comment

- When this parameter is set to “0” to “3”, only the modes indicated by the “○” mark in the table below can be selected on the menu display. For example, when this parameter is set to “2”, only level 0 to 2 modes can be selected.

Mode	Set value			
	0	1	2	3
Calibration	○			
Option	○	○		
Expansion	○	○		
Setup	○	○		
Level 2	○	○	○	
Level 1	○	○	○	○
Level 0	○	○	○	○

- When this parameter is set to “4” to “6”, operations in only the level 0 mode can be selected, and the mode is not displayed on the menu display.
- When this parameter is set to “5”, only the “PV/SP” parameter in the level 0 mode can be used.
- When this parameter is set to “6”, only the “PV/SP” parameter in the level 0 mode can be displayed. (The set point cannot change.)
- Default is “1”. (Only the calibration mode is protected.)



See

- Related article
3.5 Protect Mode (page 3-13)

Protect Mode

PEYP

[A/M] key protect



Function

- Invalidate the function of the $\boxed{A/M}$ key. In other words, you cannot switch between the auto and manual operations by key operation.







Comment

- [$\bar{\alpha}n$] : $\boxed{A/M}$ key protect ON
- [$\bar{\alpha}FF$] : $\boxed{A/M}$ key protect canceled
- Default = [$\bar{\alpha}FF$]



See



- Related article
3.5 Protect Mode (page 3-13)

- In this mode, manual operations are possible, and the “MANU” LED lights.
- When this mode is selected, the manipulated variable that was active immediately before the mode was switched to is output. When changing the manipulated variable, change it using the  or  keys.
If this mode is switched to during auto-tuning, auto-tuning is canceled.
- To select this mode when in the level 0 to 2 modes, press the  key for 1 second minimum. To exit this mode, press the  key for 1 second minimum. The mode changes to the level 0 mode.
- “Manual MV” is the only parameter available in this mode.

Manual MV



Function

- Sets the manipulated variable for manual operation. When you press the  or  keys, the manipulated variable is changed.
- The process value is displayed on the No.1 display and the manipulated variable is displayed on the No.2 display.

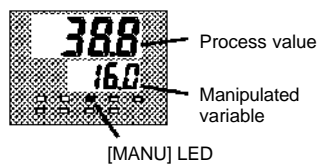

- The manual MV is held when the power is interrupted.



Comment







Control Method	Setting Range	Unit	Default
Standard	-5.0 to 105.0	%	0.0
Heating and cooling	-105.0 to 105.0	%	0.0



See

- Related article
3.7 Adjusting Control Operation (page 3-15)

Level 0 Mode

- The parameters in this mode can be used only when the “security” parameter (protect mode) is set to “0” to “4”.
- The “PV/SP” parameter can be used when the “security” parameter is set to “5” or “6”. However, note that the SP cannot be changed when it is set to “6”.
- This mode is used for changing the SP value and starting or stopping operation. The mode can also be used for monitoring the PV value, set point during SP ramp, or MV value, but cannot be used for changing them.
- To select this mode when in the levels 1 and 2, setup, expansion, option and calibration modes, press the  key for 1 second minimum. The display changes to the menu display. If you select [L u - 0] using the  key then press  key for 1 second minimum, the controller enters the level 0 mode.
- To select parameters in this mode, press the  key. To change parameter settings, use the  or  keys.
- The following table shows the parameters supported in this mode and the page where the parameter is described.

Symbol	Parameter Name	Page
	PV/SP	5-7
r-SP	Remote SP monitor	5-8
SP - r	Set point during SP ramp	5-8
o	MV monitor (heat)	5-9
[- o	MV monitor (cool)	5-9
r - S	Run/Stop	5-9

PV/SP



Function

- The process value is displayed on the No.1 display, and the set point is displayed on the No.2 display. The set point can be set.
- Either of the local SP or remote SP is displayed as the set point depending on the SP mode. In the remote SP mode, the set point is only monitored.

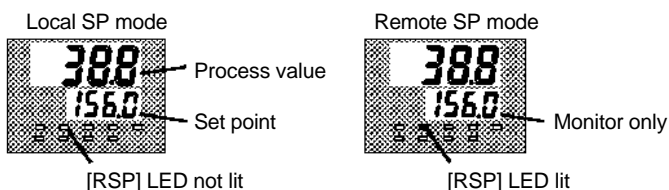

- The decimal point position is dependent on the selected sensor during temperature input and on the results of scaling during analog input.



Comment

- Process value

Monitor Range	Unit
Scaling lower limit -10%FS to scaling upper limit +10%FS	EU

During temperature input, the range of the currently selected sensor is taken as the monitor range.

- Set point

Setting Range/Monitor Range	Unit	Default
Local SP : Local SP lower setting limit to local SP setting upper limit	EU	0
Remote SP: Remote SP lower setting limit to remote SP upper limit	EU	-



See

- Related article
3.7 Adjusting Control Operation (page 3-15)
- Related parameters
“Input type” “Scaling upper limit” “Scaling lower limit” “Decimal point” (setup mode)
“SP setting upper limit” “SP setting lower limit” (expansion mode)
“SP mode” (level 2 mode)
“Remote SP enable” “Remote SP upper limit” “Remote SP lower limit” (option mode)

Level 0 Mode

r-SP

Remote SP monitor

Conditions of Use

The controller must be in the local SP mode with the remote SP function enabled.



Function

- Monitors remote SP in the local SP mode.



Monitor

Monitor Range	Unit
Remote SP lower limit to Remote SP upper limit	EU



See

- Related article
4.2 Operating Condition Restrictions/SP ramp (page 4-5)
- Related parameters
“SP mode” (level 2 mode)
“Remote SP enable” “Remote SP lower limit” “Remote SP upper limit” (option mode)

SP-r

Set point during SP ramp

Conditions of Use

The remote SP function must be enabled or the SP ramp function must be enabled.



Function

- Monitors the set point during SP ramp
- Matches the set point of the “PV/SP” parameter when the set point is not during SP ramp.



Monitor

Monitor Range	Unit
Local SP : Local SP setting lower limit to local SP setting upper limit	EU
Remote SP : Remote SP lower limit to remote SP upper limit	EU



See

- Related article
4.2 Operating Condition Restriction/SP ramp (page 4-5)
- Related parameters
“PV/SP” (level 0 mode)
“SP ramp time unit” “SP ramp set value” (level 2 mode)
“SP setting upper limit” “SP setting lower limit” (expansion mode)
“SP mode” (level 2 mode)
“Remote SP enable” “Remote SP upper limit” “Remote SP lower limit” (option mode)



MV monitor (heat)

Conditions of Use

Control must be standard control or heating and cooling control.



MV monitor (cool)



Function

- This parameter cannot be set.
- Monitors the manipulated variable on the heating or cooling side.
- The manipulated variable in a standard control system is checked in the “MV monitor (heat)” parameter.
- The “MV monitor (cool)” parameter can be used only during heating and cooling control.



Monitor

- MV monitor (heat)

Control	Monitor Range	Unit
Standard	-5.0 to 105.0	%
Heating and cooling	0.0 to 105.0	%

- MV monitor (cool)

Control	Monitor Range	Unit
Heating and cooling	0.0 to 105.0	%



Run/Stop





Function

- This parameter is used for checking the operating status of the controller, and for specifying start and stop of operation.



Example of use







- To start operation, set this parameter to [rUn] press the  or  keys. To stop operation, set this parameter to [StōP]. When operation is stopped, the “STOP” LED lights.
- Default is [rUn]



See

- Related article
3.6 Starting and Stopping Operation (page 3-14)

Level 1 Mode

- The parameters in this mode can be used only when the “security” parameter (protect mode) is set to “0” to “3”.
- This mode contains the main parameters for adjusting control. These parameters include parameters for executing AT (auto-tuning), setting the alarm values, setting the control period, and setting PID parameters.
- To select this mode when in the levels 0 and 2, setup, expansion, option and calibration modes, press the  key for 1 second minimum. The display changes to the menu display. If you select [L u - !] using the   key then press the  key for 1 second minimum, the controller enters the level 1 mode.
- To select parameters in this mode, press the  key. To change parameter settings, use the  or  keys.
- The following table shows the parameters supported in this mode and the page where the parameter is described.

Symbol	Parameter Name	Page
At	AT Execute/Cancel	5-11
AL - 1	Alarm value 1	5-11
AL - 2	Alarm value 2	5-11
AL - 3	Alarm value 3	5-11
P	Proportional band	5-12
I	Integral time	5-12
d	Derivative time	5-12
[- SC	Cooling coefficient	5-12
[- db	Dead band	5-13
oF - r	Manual reset value	5-13
HYS	Hysteresis (heat)	5-14
[HYS	Hysteresis (cool)	5-14
CP	Control period (heat)	5-15
[- CP	Control period (cool)	5-15
[t	Heater current monitor	5-15
Hb	Heater burnout	5-16

AT

AT Execute/Cancel

Conditions of Use

The controller must be in operation with 2-PID control.



Function

- Selects the limit cycle of MV change width (40% or 100%) for execution. After AT execution, the “PID” and the “LBA detection time” (LBA: Loop Break Alarm) parameters are set automatically.
- During heating and cooling control, only 100%AT can be executed.



Example of use

- When this parameter is selected, the setting becomes [0FF].
- To execute 40%AT, select [AT - 1], and to execute 100%AT, select [AT - 2]. During execution of auto-tuning, the AT LED flashes. However, note that during heating and cooling control, [AT - 1] is not displayed.
- When AT execution ends, the parameter setting automatically returns to [0FF].



See

- Related article
3.7 Adjusting Control Operation (page 3-15)
- Related parameters
“Run/Stop” (level 0 mode)
“Proportional band” “Integral time” “Derivative time” (level 1 mode)
“LBA detection time” (level 2 mode)

AL - 1

Alarm value 1

Conditions of Use

Alarms must be assigned as outputs. For example, if alarm outputs 1 and 2 only are assigned as outputs, the “alarm value 3” parameter cannot be used.

AL - 2

Alarm value 2

AL - 3

Alarm value 3



Function

- This parameter is used for monitoring or changing the alarm values of alarm outputs 1 to 3.
- During temperature input, the decimal point position is dependent on the currently selected sensor, and during analog input on the results of scaling.



Comment

Setting Range	Unit	Default
-1999 to 9999	EU	0



See

- Related article
3.4 Setting Alarm Type (page 3-10)
- Related parameters
“Input type” “Scaling upper limit” “Scaling lower limit” “Decimal point” “Control output 1 assignment” “Control output 2 assignment” “Auxiliary output 1 assignment” “Auxiliary output 2 assignment” “Alarm 1 type” “Alarm 2 type” “Alarm 3 type” “Alarm 1 open in alarm” “Alarm 2 open in alarm” “Alarm 3 open in alarm” (setup mode)
“Alarm 1 hysteresis” “Alarm 2 hysteresis” “Alarm 3 hysteresis” (level 2 mode)
“Standby sequence reset method” (expansion mode)

Level 1 Mode



Proportional band

Conditions of Use
Control must be 2-PID control.



Integral time



Derivative time



Function

- Sets the PID parameters. However, note that the PID parameter settings are changed to optimum values when auto-tuning is executed.



Comment

Parameter	Setting Range	Unit	Default
Proportional band	0.1 to 999.9	%FS	10.0
Integral time	0 to 3999	Second	233
Derivative time	0 to 3999	Second	40



See

- Related parameter
“AT Execute/Cancel” (level 1 mode)

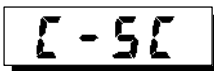

Cooling coefficient

Conditions of Use
The control must be either heating and cooling control, or 2-PID control.



Function

- In heating and cooling control, P at the cooling side is calculated by the following formula:
Cooling side P = cooling coefficient × P



Comment

Setting Range	Unit	Default
0.01 to 99.99	None	1.00



See

- Related article
4.1 Selecting the Control Method (page 4-2)
- Related parameter
“Proportional band” (level 1 mode)

C - db

Dead band

Conditions of Use

The control system must be heating and cooling control.



Function

- Sets the output dead band width in a heating and cooling control system. A negative setting sets an overlap band.



Comment

Setting Range	Unit	Default
-19.99 to 99.99	%FS	0.00



See

- Related article
4.1 Selecting the Control Method (page 4-2)

oF - r

Manual reset value

Conditions of Use

The control must be either standard control or 2-PID control, and the “integral time” parameter must be set to “0”.



Function

- Sets the required manipulated variable to remove offset during stabilization of P or PD control.



Comment

Setting Range	Unit	Default
0.0 to 100.0	%	50.0

Level 1 Mode

HYS

Hysteresis (heat)

Conditions of Use

The control system must be ON/OFF control.

CHYS

Hysteresis (cool)



Function

- Sets the hysteresis for ensuring stable operation at ON/OFF switching.
- In standard control, use the “hysteresis (heat)” parameter. The “hysteresis (cool)” parameter cannot be used.
- In heating and cooling control, the hysteresis can be set independently for heating and cooling. Use the “hysteresis (heat)” parameter to set the heating side hysteresis, and use the “hysteresis (cool)” parameter to set the cooling side hysteresis.



Comment

Parameter	Setting Range	Unit	Default
Hysteresis (heat)	0.01 to 99.99	%FS	0.10
Hysteresis (cool)	0.01 to 99.99	%FS	0.10



See

- Related article
4.1 Selecting the Control Method / ON/OFF control (page 4-3)
- Related parameters
“Control output 1 assignment” “Control output 2 assignment” (setup mode)
“PID / ON/OFF” (expansion mode)

CP

Control period (heat)

Conditions of Use

Relay, SSR or voltage output must be set as the outputs, and the control must be set to 2-PID control, standard control or heating and cooling control.

C-CP

Control period (cool)



Function

- Sets the pulse output period. Set the control period taking the control characteristics and life expectancy of the controller into consideration.
- In standard control, use the “control period (heat)” parameter. The “control period (cool)” parameter cannot be used.
- In heating and cooling control, the control period can be set independently for heating and cooling. Use the “control period (heat)” parameter to set the heating side control period, and use the “control period (cool)” parameter to set the cooling side control period.



Comment

Parameter	Setting Range	Unit	Default
Control period (heat)	1 to 99	Second	20
Control period (cool)	1 to 99	Second	20



See

- Related article
3.3 Setting Output Specifications (page 3-7)
- Related parameters
“Control output 1 assignment” “Control output 2 assignment” (setup mode)

CT

Heater current monitor

Conditions of Use

The HBA output function must be assigned.



Function

- Measures the current value of the heater from CT input.
- This parameter is not displayed when the linear output unit (E53-C□, E53-V□) is mounted.



Monitor

Monitor Range	Unit
0.0 to 55.0	A

- [FFFF] is displayed when 55.0 A is exceeded.



See

- Related article
4.4 How to Use the Heater Burnout Alarm (page 4-9)
- Related parameters
“Heater burnout” (level 1 mode) “HBA latch” (option mode)

Level 1 Mode



Heater burnout

Conditions of Use

The HBA output function must be assigned.



Function

- Outputs the heater burnout alarm when the heater current value falls below this parameter setting.
- When the set value is “0.0”, the heater burnout alarm is “OFF”. When the set value is “50.0”, the heater burnout alarm is “ON”.



Comment







Setting Range	Unit	Default
0.0 to 50.0	A	0.0



See

- Related article
4.4 How to Use the Heater Burnout Alarm (page 4-9)
- Related parameters
“Heater current monitor” (level 1 mode) “HBA latch” (option mode)

Level 2 Mode

- The parameters in this mode can be used only when the “security” parameter (protect mode) is set to “0” to “2”.
- This mode contains the auxiliary parameters for adjusting control. These parameters include parameters for limiting the manipulated variable and set point, parameters for switching between remote and local operation, and parameters for setting the LBA (Loop Break Alarm), alarm hysteresis, and input digital filter values.
- To select this mode when in the levels 0 and 1, setup, expansion, option and calibration modes, press the  key for 1 second minimum. The display changes to the menu display. If you select [L u - 2] using the   key then press the  key for 1 second minimum, the controller enters the level 2 mode.
- To select parameters in this mode, press the  key. To change parameter settings, use the  or  keys.
- The following table shows the parameters supported in this mode and the page where the parameter is described.

Symbol	Parameter Name	Page
r - L	Remote/Local	5-18
SP ã d	SP mode	5-18
SP r U	SP ramp time unit	5-19
SP r t	SP ramp set value	5-19
L b A	LBA detection time	5-20
ã u - S	MV at stop	5-20
ã u - E	MV at PV error	5-20
õ L - H	MV upper limit	5-21
õ L - L	MV lower limit	5-21
õ r L	MV change rate limit	5-21
ã n F	Input digital filter	5-22
AL H 1	Alarm 1 hysteresis	5-22
AL H 2	Alarm 2 hysteresis	5-22
AL H 3	Alarm 3 hysteresis	5-22
ã n S H	Input shift upper limit (temperature)	5-23
ã n S L	Input shift lower limit (temperature)	5-23

Level 2 Mode



Remote/Local



Function

- Switches between remote and local operation.
- To change the parameter setting during remote operation, use the communications function. To change the parameter setting during local operation, change the setting on the E5EK-DRT controller.

You can check the parameter setting by both communications and on the E5EK-DRT controller regardless of whether the controller is switched to remote or local operation.



Comment

Setting Range	Default
[<i>r</i> <i>L</i>]: remote / [<i>L</i> <i>L</i>]: local	[<i>L</i> <i>L</i>]



See

- Related article
Chapter 6 Using the CompoBus/D (DeviceNet)
- Related parameters
“Communication speed” “Node address” (Option mode)



SP mode

Conditions of Use

The remote SP function must be enabled.



Function

- Switches between remote SP and local SP.



Comment

Setting Range	Default
[<i>r</i> <i>SP</i>]: Remote SP/[<i>L</i> <i>SP</i>]: Local SP	<i>L</i> <i>SP</i>



See

- Related article
4.3 How to Use the Remote SP (page 4-7)
- Related parameters
“Remote SP enable”

SP-r-U SP ramp time unit

SP-r-t SP ramp set value



Function

- Specifies the change rate during SP ramp operation. Set the maximum permissible change width per unit of time (minute or hour) as the “SP ramp set value”. However, note that when set to “0”, the SP ramp function is disabled.
- The time unit and SP ramp set value are independent of each other. For example, when setting “30 per minute”, set the “SP ramp set value” parameter to “30” and the “SP ramp time unit” parameter to [**M**] (“minute”). However, if you change the time unit only to [**H**] (“hour”), the set time becomes “30 per hour.”
- During temperature input, the decimal point position of the SP ramp set value is dependent on the currently selected sensor, and during analog input on the results of scaling.



Comment

Parameter	Setting Range	Unit	Default
SP ramp time unit	[M]: minute/ [H : hour	None	M
SP ramp set value	0 to 9999	EU	0

During temperature input, the range of the currently selected sensor is taken as the setting range for the “SP ramp set value” parameter.



See

- Related article
4.2 Operating Condition Restrictions/SP ramp (page 4-5)
- Related parameters
“Input type” “Scaling upper limit” “Scaling lower limit” “Decimal point” (setup mode)

Level 2 Mode

LBA

LBA detection time

Conditions of Use

The LBA (Loop Break Alarm) function must be assigned as an output.



Function

- This parameter is automatically set by AT execution (excluding AT execution in a ON/OFF control).
- The LBA is output if the change width of the process value falls below 0.2 %full-scale of the time preset to this parameter when the manipulated variable is set in the “MV upper limit” or “MV lower limit” parameters.
- The LBA function is disabled when this parameter is set to “0”.



Comment

Setting Range	Unit	Default
0 to 9999	Second	0



See

- Related article
4.5 LBA (page 4-11)
8.3 How to Use Error Output (page 8-5)
- Related parameters
“AT Execute/Cancel” (level 1 mode)
“Control output 1 assignment” “Control output 2 assignment” “Auxiliary output 1 assignment” “Auxiliary output 2 assignment” (setup mode)

MV-5

MV at stop

Conditions of Use

2-PID control

MV-E

MV at PV error



Function

- The “MV at stop” sets the manipulated variable when operation stops. The “MV at PV error” sets the manipulated variable when an input error occurs.



Comment

Control Method	Setting Range	Unit	Default
Standard	-5.0 to 105.0	%	0.0
Heating and cooling	-105.0 to 105.0	%	0.0

The manipulated variable at the cooling side during heating and cooling control is expressed as a negative value.



See

- Related articles
MV at stop : 3.6 Starting and Stopping Operation (page 3-14)
MV at PV error : 8.2 How to Use the Error Display (page 8-3)

ōL-H

MV upper limit

Conditions of Use

The control must be 2-PID control

ōL-L

MV lower limit

ōrL

MV change rate limit



Function

- The “MV upper limit” and “MV lower limit” parameters set the upper and lower limits of the manipulated variable. When the manipulated variable calculated by the E5EK-DRT controller is outside of the upper-and lower-limit range, the upper limit or lower limit set to these parameters is output, respectively.
- The “MV change rate limit” parameter sets the maximum permissible change width per second of the manipulated variable. If a change in the manipulated variable causes this parameter setting to be exceeded, the calculated value is reached while changing the value by the per-second value set in this parameter. This function is disabled when the set value is “0.0”.



Comment

- **MV upper limit**
The setting ranges during standard control and heating and cooling control are different. Also, the manipulated variable at the cooling side during heating and cooling control is expressed as a negative value.

Control Method	Setting Range	Unit	Default
Standard	MV lower limit +0.1 to 105.0	%	105.0
Heating and cooling	0.0 to 105.0	%	105.0

- **MV lower limit**
The setting ranges during standard control and heating and cooling control are different. Also, the manipulated variable at the cooling side during heating and cooling control is expressed as a negative value.

Control Method	Setting Range	Unit	Default
Standard	-5.0 to MV upper limit -0.1	%	-5.0
Heating and cooling	-105.0 to 0.0	%	-105.0

- **MV change rate limit**

Setting Range	Unit	Default
0.0 to 100.0	%/S	0.0



See

- **Related article**
4.2 Operating Condition Restrictions/Manipulated variable restrictions (page 4-4)

Level 2 Mode

INF

Input digital filter



Function

- Sets the time constant of the input digital filter. The following figures shows the effect on data after passing through the digital filter.

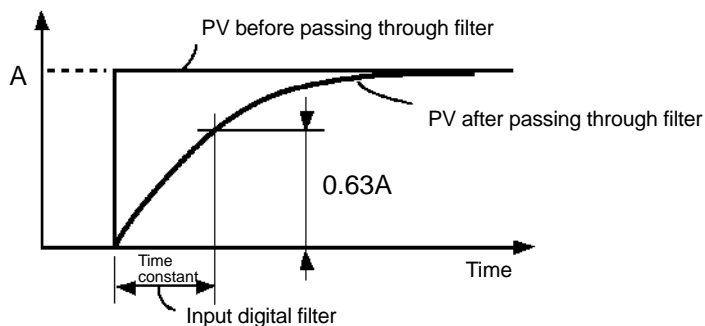

Comment

Setting Range	Unit	Default
0 to 9999	Second	0

ALH1

Alarm 1 hysteresis

ALH2

Alarm 2 hysteresis

ALH3

Alarm 3 hysteresis

Conditions of Use

Alarms must be assigned as outputs. For example, if alarm outputs 1 and 2 only are assigned as outputs, the “alarm 3 hysteresis” parameter cannot be used.



Function

- This parameter is for setting the hysteresis of alarm outputs 1 to 3.



Comment

Setting Range	Unit	Default
0.01 to 99.99	%FS	0.02



See

- Related article
3.4 Setting Alarm Type (page 3-10)
- Related parameters
“Alarm 1 type” “Alarm 2 type” “Alarm 3 type” “Alarm 1 open in alarm” “Alarm 2 open in alarm” “Alarm 3 open in alarm” (setup mode)
“Alarm value 1” “Alarm value 2” “Alarm value 3” (level 1 mode)

INSH

Input shift upper limit

INSL

Input shift lower limit

Conditions of Use

The input type must be set to temperature input (thermocouple or platinum resistance thermometer).



Function

- Sets each of the shift amounts for the input shift upper limit and lower limit values.



Comment







Setting Range	Unit	Default
-199.9 to 999.9	°C or °F	0.0











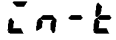
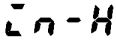
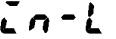

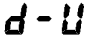
See

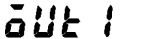
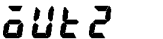
- Related article
3.2 Setting Input Specifications (page 3-4)
- Related parameter
“Input type” (setup mode)

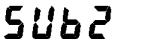
Setup Mode

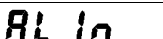
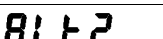
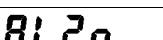
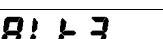
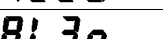
- The parameters in this mode can be used only when the “security” parameter (protect mode) is set to “0” and “1”.
- This mode contains the parameters for setting the basic specifications of the E5EK-DRT controller. These parameters include parameters for specifying the input type, scaling, output assignments, and direct/reverse operation.
- To select this mode when in the levels 0 to 2, expansion, option and calibration modes, press the  key for 1 second minimum. The display changes to the menu display. If you select [5E] using the   key then press the  key for 1 second minimum, the controller enters the setup mode.
- To select parameters in this mode, press the  key. To change parameter settings, use the  or  keys.
- The following table shows the parameters supported in this mode and the page where the parameter is described.

Symbol	Parameter Name	Page
	Input type	5-25
	Scaling upper limit	5-26
	Scaling lower limit	5-26
	Decimal point	5-26
	°C/°F selection	5-27
	Parameter initialize	5-26
	Control output 1 assignment	5-27
	Control output 2 assignment	5-27
	Auxiliary output 1 assignment	5-28
	Auxiliary output 2 assignment	5-28
	Alarm 1 type	5-29
	Alarm 1 open in alarm	5-30
	Alarm 2 type	5-29
	Alarm 2 open in alarm	5-30
	Alarm 3 type	5-29
	Alarm 3 open in alarm	5-30
	Direct/Reverse operation	5-30

Ln-k

Input type



Function

- Sets the sensor type by the code.



Comment

- Set the code according to the following table. Default is “2: K thermocouple (-200 to 1300°C)”.

Set value	Input Type	Input Type	
0	JPt100	-199.9 to 650.0 (°C) /-199.9 to 999.9 (°F)	Platinum resistance thermometer
1	Pt100	-199.9 to 650.0 (°C) /-199.9 to 999.9 (°F)	
22		-100.0 to 100.0 (°C) /-150.0 to 250.0 (°F)	
2	K	-200 to 1300 (°C) /-300 to 2300 (°F)	Thermocouple
3		0.0 to 500.0 (°C) /0.0 to 900.0 (°F)	
4	J	-100 to 850 (°C) /-100 to 1500 (°F)	
5		0.0 to 400.0 (°C) /0.0 to 750.0 (°F)	
6	T	-199.9 to 400.0 (°C) /-199.9 to 700.0 (°F)	
7	E	0 to 600 (°C) /0 to 1100 (°F)	
8	L	-100 to 850 (°C) /-100 to 1500 (°F)	
9		0.0 to 400.0 (°C) /0.0 to 750.0 (°F)	
10	U	-199.9 to 400.0 (°C) /-199.9 to 700.0 (°F)	
11	N	-200 to 1300 (°C) /-300 to 2300 (°F)	
12	R	0 to 1700 (°C) /0 to 3000 (°F)	
13	S	0 to 1700 (°C) /0 to 3000 (°F)	
14	B	100 to 1800 (°C) /300 to 3200 (°F)	
15	W (W5Re/W26Re)	0 to 2300 (°C) /0 to 4100 (°F)	
16	PLII (PLATINEL)	0 to 1300 (°C) /0 to 2300 (°F)	
17	4 to 20mA		Current input
18	0 to 20mA		
19	1 to 5VDC		Voltage input
20	0 to 5VDC		
21	0 to 10VDC		



See

- Related article
3.2 Setting Input Specifications (page 3-4)

- Related parameters

When input type is set to temperature input:

“°C/°F selection” (setup mode)

When input type is set to voltage input or current input:

“Scaling upper limit” “Scaling lower limit” “Decimal point” (setup mode)

Setup Mode

Ln-H

Scaling upper limit

Conditions of Use

Ln-L

Scaling lower limit

The input type must be set to analog input (voltage or current input).

dP

Decimal point



Function

- This parameter can be used only when voltage input or current input is selected as the input type.
- When voltage input or current input is selected as the input type, scaling is carried out. Set the scaling upper limit in the “scaling upper limit” parameter and the scaling lower limit in the “scaling lower limit” parameter.
- The “decimal point” parameter specifies the decimal point position of parameters (set point, etc.) whose unit is set to EU (Engineering Unit).



Comment

- Scaling upper limit, Scaling lower limit

Parameter	Setting Range	Unit	Default
Scaling upper limit	Scaling lower limit +1 to 9999	EU	100
Scaling lower limit	-1999 to scaling upper limit -1	EU	0

- Decimal point : default : 0 (0 digits past decimal point)

Set Value	Setting	Example
0	0 digits past decimal point	1234
1	1 digit past decimal point	123.4
2	2 digits past decimal point	12.34
3	3 digits past decimal point	1.234



See

- Related article
3.2 Setting Input Specifications (page 3-4)
- Related parameter
“Input type” (setup mode)

Init

Parameter initialize



Function

- Returns parameter settings to their defaults. However, note that the following parameters are not affected by execution of this parameter: “input type”, “scaling upper limit”, “scaling lower limit”, “decimal point”, “baud rate”, “node address” and “°C/°F selection”.



Example of use

- When this parameter is selected, [nō] (“no”) is first displayed. To initialize parameters, press the key to specify [yēs] (“yes”).

d-U °C/°F selection

Conditions of Use

The input type must be set to temperature input (thermocouple or platinum resistance thermometer).



Function

- This parameter can be used when thermocouple or platinum resistance thermometer is selected as the input type.
- Set the temperature input unit to either of “°C” or “°F”.



Comment

Setting Range	Default
[] : °C / [] : °F	[]



See

- Related article
3.2 Setting Input Specifications (page 3-4)
- Related parameter
“Input type” (setup mode)

OUT 1

Control output 1 assignment

Conditions of Use

The control must be standard control or heating and cooling control.

OUT 2

Control output 2 assignment



Function

- Assigns the output functions to either of control output 1 or 2.
- The following seven output functions can be assigned as outputs:
Control output (heat), Control output (cool), Alarms 1 to 3, HBA, and LBA.
- Errors 1, 2 and 3 cannot be assigned as outputs.
- When the output function assigned to control output 1 or control output 2 is ON, the “OUT1” or “OUT2” LED lights. However, note that the LED does not light when control output (heat) or control output (cool) are assigned to linear outputs such as current and voltage.
- When the output function assigned to control output 2 is ON, the “OUT2” LED lights.



Comment

Symbol	HEAT	COOL	AL-1	AL-2	AL-3	HbA	LbA
Function	Control output (heat)	Control output (cool)	Alarm 1	Alarm 2	Alarm 3	HBA	LBA

Defaults:

“Control output 1” = [HEAT], “Control output 2” = [AL-1]



See

- Related article
3.3 Setting Output Specifications (page 3-7)
- Related parameters
 - Alarm-related parameters
 - Heating and cooling related parameter
“LBA detection time” (level 2 mode)

Setup Mode

SUB1

Auxiliary output 1 assignment

SUB2

Auxiliary output 2 assignment



Function

- Assigns output functions to either of auxiliary output 1 or 2.
- The following eight output functions can be assigned as outputs:
Alarms 1 to 3, HBA, LBA, Error 1 (input error), Error 2 (A/D converter error), and Error 3 (remote SP input error).
- Control output (heat) and control output (cool) cannot be assigned as outputs.
- Error 3 can be assigned only when the remote SP function is enabled.
- When the output function assigned to auxiliary output 1 or auxiliary output 2 is ON, the “SUB1” or “SUB2” LED lights.



Comment

Symbol	<i>AL-1</i>	<i>AL-2</i>	<i>AL-3</i>	<i>HbA</i>	<i>LbA</i>	<i>S.Err</i>	<i>E333</i>	<i>rSEr</i>
Function	Alarm 1	Alarm 2	Alarm 3	HBA	LBA	Error 1	Error 2	Error 3

Defaults: “Auxiliary output 1” = [*AL-2*], “Auxiliary output 2” = [*AL-3*]



See

- Related article
3.3 Setting Output Specifications (page 3-7)
- Related parameter
- Alarm-related parameter
“LBA detection time” (level 2 mode)

AL1

Alarm 1 type

AL2

Alarm 2 type

AL3

Alarm 3 type

Conditions of Use

Alarms must be assigned as outputs. For example, if alarm outputs 1 and 2 only are assigned as outputs, the “alarm 3 type” parameter cannot be used.



Function



Comment

- “Alarm 1 to 3 type” parameters specify the operation of the alarm by the one of the set values in the following table. For details of operation at an alarm, see page 3-10.

Set Value	Settings	Set Value	Settings
1	Upper-and lower-limit alarm (deviation)	7	Lower-limit alarm with standby sequence (deviation)
2	Upper-limit alarm (deviation)	8	Absolute-value upper-limit alarm
3	Lower-limit alarm (deviation)	9	Absolute-value lower-limit alarm
4	Upper-and lower-limit range alarm (deviation)	10	Absolute-value upper-limit alarm with standby sequence
5	Upper-and lower-limit alarm with standby sequence (deviation)	11	Absolute-value lower-limit alarm with standby sequence
6	Upper-limit alarm with standby sequence (deviation)		

Defaults: 2 (Deviation upper limit)



See

- Related article
3.4 Setting Alarm Type (page 3-10)
- Related parameters
“Alarm value 1” “Alarm value 2” “Alarm value 3” (level 1 mode)
“Alarm 1 hysteresis” “Alarm 2 hysteresis” “Alarm 3 hysteresis” (level 2 mode)
“Alarm 1 open in alarm” “Alarm 2 open in alarm” “Alarm 3 open in alarm” “Control output 1 assignment” “Control output 2 assignment” “Auxiliary output 1 assignment” “Auxiliary output 2 assignment” (setup mode)

Setup Mode

AL1n

Alarm 1 open in alarm

AL2n

Alarm 2 open in alarm

AL3n

Alarm 3 open in alarm

Conditions of Use

Alarms must be assigned as outputs. For example, if alarm outputs 1 and 2 only are assigned as outputs, the “alarm 3 open in alarm” parameter cannot be used.



Function

- Selects the output states of alarms 1 to 3.
- When the controller is set to “close in alarm,” the status of the alarm output function is output as it is. When set to “open in alarm,” the status of the alarm output function is output inverted. The following table shows the relationship between alarm output functions, output and output LEDs.

	Alarm	Output	Output LED
Close in alarm	ON	ON	Lit
	OFF	OFF	Not lit
Open in alarm	ON	OFF	Lit
	OFF	ON	Not lit



Comment

Setting Range	Default
[n - ā] : Close in alarm/ [n - ĩ] : Open in alarm	[n - ā]



See

- Related article
3.4 Setting Alarm Type (page 3-10)
- Related parameters
“Alarm value 1” “Alarm value 2” “Alarm value 3” (level 1 mode)
“Alarm 1 hysteresis” “Alarm 2 hysteresis” “Alarm 3 hysteresis” (level 2 mode)
“Alarm 1 type in alarm” “Alarm 2 type in alarm” “Alarm 3 type in alarm”
“Control output 1 assignment” “Control output 2 assignment” “Auxiliary output 1 assignment” “Auxiliary output 2 assignment”(setup mode)

ōrEu

Direct/Reverse operation



Function

- “Direct operation” (or normal operation) refers to control where the manipulated variable is increased according to the increase in the process value. Alternatively, “reverse operation” refers to control where the manipulated variable is increased according to the decrease in the process value.



Comment









Setting Range	Default
[ār - r] : Reverse operation/ [ār - d] : Direct operation	[ār - r]









See

- Related article
3.3 Setting Output Specifications/Direct/reverse operation (page 3-8)

Expansion Mode

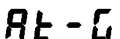
- The parameters in this mode can be used only when the “security” parameter (protect mode) is set to “0” and “1”.
- This mode contains the parameters for setting expanded functions. These parameters, for example, are for selecting the SP setting limiter, 2-PID and ON/OFF, specifying the standby sequence reset method, and setting the automatic return to the monitoring display.
- To select this mode when in the levels 0 to 2, setup, option and calibration modes, press the  key for 1 second minimum. The display changes to the menu display. If you select [] using the   key then press the  key for 1 second minimum, the controller enters the expansion mode.
- To select parameters in this mode, press the  key. To change parameter settings, use the  or  keys.
- The following table shows the parameters supported in this mode and the page where the parameter is described.

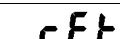
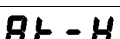
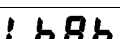
Symbol	Parameter Name	Page
	SP setting upper limit	5-32
	SP setting lower limit	5-32
	PID / ON/OFF	5-32
	α	5-33
	AT calculated gain	5-33
	Standby sequence reset method	5-34
	Automatic return of display mode	5-34
	AT hysteresis	5-35
	LBA detection width	5-35

Expansion Mode

SL-H

SP setting upper limit

SL-L

SP setting lower limit



Function

- Limits the upper and lower limits of the set point. When the set point exceeds the settings of the “SP setting upper limit” and “SP setting lower limit” parameters, the E5EK-DRT controller regards the settings of the “Set point upper limit” and “Set point lower limit” parameters as the set points.
- When the input type or temperature unit is changed, the values will be force-set to the sensor’s upper and lower limits.
- During temperature input, the decimal point position is dependent on the currently selected sensor, and during analog input on the results of scaling.



Comment

Parameter	Setting Range	Unit	Default
SP setting upper limit	SP setting lower limit +1 to scaling upper limit	EU	1300
SP setting lower limit	Scaling lower limit to SP setting upper limit -1	EU	-200

During temperature input, the range becomes the range of use of the selected sensor instead of the scaling upper and lower limit values.



See

- Related article
4.2 Operating Condition Restrictions (page 4-4)
- Related parameters
“Input type” “Scaling upper limit” “Scaling lower limit” “Decimal point” (setup mode)

Ctrl

PID / ON/OFF

Condition of Use

Control must be standard control or heating and cooling control.



Function

- Selects 2-PID control or ON/OFF control.



Comment

Setting Range	Default
[P I D] : 2-PID/ [O N O F] : ON/OFF	[P I D]



See

- Related article
4.1 Selecting the Control Method/ON/OFF control (page 4-3)
- Related parameters
“Hysteresis (heat)” “Hysteresis (cool)” (level 1 mode)

Expansion Mode

ALFA α

Conditions of Use
The control must be 2-PID control.



Function

- Usually use the default value.
- Sets 2-PID control parameter α .



Comment

Setting Range	Unit	Default
0.00 to 1.00	None	0.65



See

- Related parameter
“PID / ON/OFF” (expansion mode)

AL-G

AT calculated gain

Conditions of Use
The control must be 2-PID control.



Function

- Usually use the default value.
- Sets the gain when adjusting the PID parameters by auto-tuning.
- To give priority to response, decrease the set value of this parameter. To give priority to stability, increase the set value of this parameter.



Comment

Setting Range	Unit	Default
0.1 to 10.0	None	1.0



See

- Related parameters
“AT Execute/Cancel” (level 1 mode)
“PID / ON/OFF” (expansion mode)

Expansion Mode

r ESt

Standby sequence reset method



Function

- Selects the conditions for enabling reset after the standby sequence of the alarm has been canceled.
- Condition A:
Control started (including power ON), and, alarm value, input shift value or set point (except for changing SP mode or during Remote SP) changed.
- Condition B:
Power ON
- The following illustration shows an operation example for the lower-limit alarm with standby sequence.

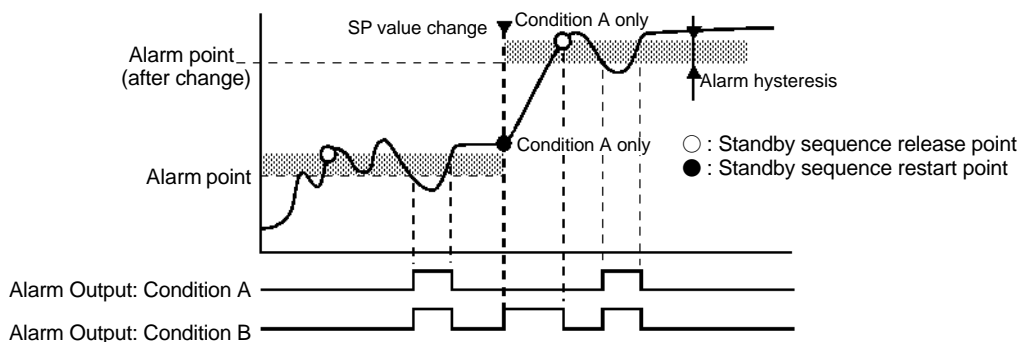

Comment

Setting Range	Default
0: Condition A / 1: Condition B	0



See

- Related parameters
“Alarm 1 type” “Alarm 2 type” “Alarm 3 type” (setup mode)

r Et

Automatic return of display mode



Function

- If you do not operate any of the controller keys for the time set in this parameter when in levels 0 to 2 modes, the display automatically returns to the PV/SP display.
- When this parameter is set to “0”, this function is disabled. (The screen will not change automatically.)
- This parameter is invalid while the menu is displayed.



Comment

Setting Range	Unit	Default
0 to 99	Second	0

Expansion Mode

AT-H

AT hysteresis

Conditions of Use

The control must be 2-PID control.



Function

- Usually Use the default value.
- The levels of limit cycle operations during AT execution are given hysteresis at event ON/OFF switching. This parameter sets this hysteresis width.



Comment

Setting Range	Unit	Default
0.1 to 9.9	%FS	0.2

LbAb

LBA detection width

Conditions of Use

The LBA (Loop Break Alarm) function must be assigned as an output.



Function









- This parameter can be used when LBA is assigned as an output.
- When the change width of the manipulated variable is below the width set in this parameter, the controller regards this as detection of an LBA.











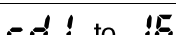
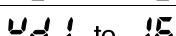

Comment

Setting Range	Unit	Default
0.0 to 999.9	%FS	0.2

Option Mode

- The parameters in this mode can be used only when the “security” parameter (protect mode) is set to “0” and “1”.
- You can display this mode only on controller models that support the option functions. In this mode, you set communications conditions and communications data assignment parameters to match the type of option function.
- To select this mode when in the levels 0 to 2, setup, expansion and calibration modes, press the  key for 1 second minimum. The display changes to the menu display. If you select [] using the   key then press the  key for 1 second minimum, the controller enters the option mode.
- To select parameters in this mode, press the  key. To change parameter settings, use the  or  keys.
- The following table shows the parameters supported in this mode and the page where the parameter is described.

Symbol	Parameter Name	Page
	Baud rate	5-37
	Node address	5-37
	Communication data format	5-37
	Operation at communication error	5-38
	Read data assignment 1 to 16	5-38
	Write data assignment 1 to 16	5-38
	HBA latch	5-39
	Remote SP enable	5-39
	Remote SP upper limit	5-40
	Remote SP lower limit	5-40
	SP tracking enable	5-41

bP5

Baud rate

nAdr

Node address



Function

- These parameters area valid when the power is turned ON again.
- Set the same baud rate to the master and other slaves on the network.
- Set the node addresses so that the same values are not set to the master and slaves.



Comment

- “Baud rate” parameter

Setting Range	Unit	Default
125, 250, 500	kbps	125

- “Node address” parameter

Setting Range	Unit	Default
0 to 63	None	0



See

- Related article
6.3 Setting the Communications Conditions (page 6-6)
- Related parameter
“Remote/Local” (level 2 mode)

dfnt

Communication data format



Function

- This parameter is valid when the power is turned ON again.
- When the communication data is a numerical value, specify its format.
- When minus sign numerical values are being entered, the signed binary format is expressed as a complement.

Numerical values are expressed as follows in the BCD format:

Numerical Value	BCD Symbol	[Example]
-0	F	-1500=“A500”, -15=“F015”
-1	A	



Comment

Setting Range	Unit	Default
[b $\bar{1}$ n] : Signed binary format/[b $\bar{1}$ d] : BCD format	None	b $\bar{1}$ n



See

- Related article
6.3 Setting the Communications Conditions (page 6-6)
- Related parameter
“Remote/Local” (level 2 mode)

Option Mode

ComE

Operation at communication error



Function



Comment



See

- Specifies operation when a communication error occurs.
- To continue operations other than communication functions, select “continue”. To stop operations, select “stop”.

Setting Range	Unit	Default
[0] : Continue/[1] : Stop	None	0

- Related article
6.3 Setting the Communications Conditions (page 6-6)
- Related parameter
“Remote/Local” (level 2 mode)

rd 1

to

rd 16

Read data assignment 1 to 16

wd 1

to

wd 16

Write data assignment 1 to 16



Function



Comment

- The communication data types (16 types each for read and write) that have been assigned to these parameters are sent and received from the CompoBus/D (DeviceNet) master.
- The assigned data type settings are successively sent and received via remote I/O channels.

- Communication data type
For details on parameters, operation instructions and statuses that are assigned as communication data, see Chapter 6 Using CompoBus/D (DeviceNet), 6.4 Data Assignments/Data Type List (page 6-9).

Set [0] (“not assigned”) to parameters to which communication data is not assigned.

- Default

Parameter	Assignment Data
Read data assignment 1	1 Process value
Read data assignment 2	3 Manipulated variable (heat)
Read data assignment 3	37 Status A
Read data assignment 4 to to Read data assignment 16	0 Not assigned
Write data assignment 1	5 Set point
Write data assignment 2	7 Alarm value 1
Write data assignment 3	8 Alarm value 2
Write data assignment 4	35 Operation instruction
Write data assignment 5 to to Write data assignment 16	0 Not assigned



See

- Related article
6.4 Data Assignments (page 6-8)
- Related parameter
“Remote/Local” (level 2 mode)

HbL

HBA latch

Conditions of Use

The HBA output function must be assigned.



Function

- When this parameter is set to ON, the heater burnout alarm is held until either of the following conditions is satisfied:
 - a The heater burnout set value is set to “0.0A”.
 - b The controller’s power OFF is turned OFF then back ON again.



Comment

Setting Range	Default
[$\bar{0}n$]: Enabled/[$\bar{0}FF$]: Disabled	[$\bar{0}FF$]



See

- Related article
 - 4.4 How to Use the Heater Burnout Alarm (page 4-9)
- Related parameters
 - “Control output assignment 1” “Control output assignment 2” “Auxiliary output assignments 1” “Auxiliary output assignments 2” (setup mode)

rSPU

Remote SP enable



Function

- When this parameter is set to “ON”, the remote SP and local SP can be switched for use. (That is, to the SP mode can be specified.) Also, the “set point during SP ramp” parameter is enabled at all times.
- When this parameter is set to “OFF”, only the local SP can be used. The set point during SP ramp is enabled only when the SP ramp function is enabled.



Comment

Setting Range	Default
[$\bar{0}n$]: Enabled/[$\bar{0}FF$]: Disabled	[$\bar{0}FF$]



See

- Related article
 - 4.3 How to Use the Remote SP (page 4-7)
- Relate parameters
 - “Set point during SP ramp” (level 0 mode)
 - “SP mode” (level 2 mode)

Option Mode

rSPH

Remote SP upper limit

Conditions of Use

The remote SP function must be enabled.

rSPL

Remote SP lower limit



Function

- Sets the remote SP upper and lower limit values. The upper limit value is equivalent to 20 mA, and the lower limit value is equivalent to 4 mA. Set the upper limit value in the “remote SP upper limit” parameter and the lower limit value in the “remote SP lower limit” parameter.

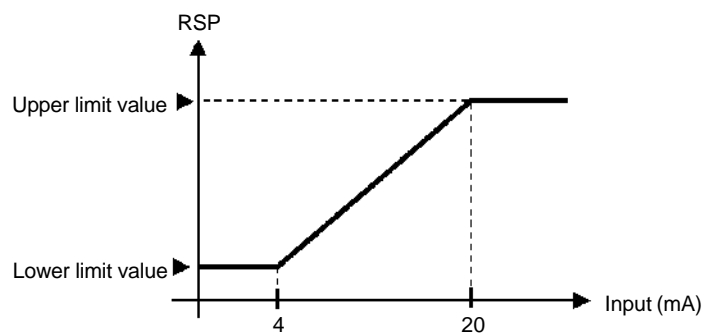

- When the “SP setting upper limit” and “SP setting lower limit” parameters are changed, the remote SP upper and lower limit values are forcibly changed to the SP setting upper and lower limit values.



Comment

Parameter	Setting Range	Unit	Default
Remote SP upper limit	SP setting lower limit to SP setting upper limit	EU	1300
Remote SP lower limit	SP setting lower limit to SP setting upper limit	EU	-200



See

- Related article
 - 4.3 How to Use the Remote SP (page 4-7)
- Related parameters
 - “Decimal point” (setup mode)
 - “SP setting upper limit” “SP setting lower limit” (expansion mode)
 - “Remote SP enable” (option mode)

SPTr

SP tracking enable

Conditions of Use

The remote SP function must be enabled.



Function

- Specifies the operation when the remote SP mode is switched to the local SP mode.
- When this parameter is set to “ON”, the local SP is changed to the remote SP value.
- When this parameter is set to “OFF”, the local SP is not influenced by the remote SP.



Comment





Setting Range	Default
[00]: Enabled/[0FF]: Disabled	[0FF]



See

- Related article
 - 4.3 How to Use the Remote SP (page 4-7)
- Related parameters
 - “Set point during SP ramp” (level 0 mode)
 - “SP mode” (level 2 mode)

Calibration Mode

- The parameters in this mode can be used only when the “security” parameter (protect mode) is set to “0”. When selecting this mode for the first time after the E5EK-DRT has left the factory, return the “security” parameter to “0”.
- This mode contains the parameters for user calibration of inputs. Only parameters relating to input types specified in the “input type” parameter (setup mode) can be used.
- To select this mode when in the levels 0 to 2, setup, expansion and option modes, press the  key for 1 second minimum. The display changes to the menu display. If you select [] using the   key then press the  key for 1 second minimum, the controller enters the calibration mode.
- For details on parameters in the calibration mode, see Chapter 7 Calibration.

K CHAPTER 6

USING CompoBus/D (DEVICENET)

This chapter describes use of the E5EK-DRT as a slave on the CompoBus/D (DeviceNet) network.

For details on the CompoBus/D (DeviceNet) network such as system configuration and cable connection conditions, see the CompoBus/D (DeviceNet) Operation Manual (catalog No.: W267).

6.1	Outline of CompoBus/D (DeviceNet)	6-2
	Communications defaults	6-2
	Data assignments	6-2
	Remote I/O communications	6-3
6.2	Data Refreshing by Communications	6-4
	Flow of Communications Processing	6-4
	E5EK-DRT Internal Processing Times	6-5
6.3	Setting the Communications Conditions	6-6
	Baud rate	6-6
	Node address	6-6
6.4	Data Assignments	6-8
	How to assign data	6-8
	Data format	6-9
	Operation at communication error	6-9
	Data type list	6-9
6.5	Data Structure	6-10
	Parameters	6-10
	Operation instructions	6-11
	Communication error status	6-12
	Status A	6-12
	Status B	6-12
6.6	Data Timing	6-13
	Writing parameters	6-13
	Executing operation instructions	6-13
6.7	Sample Ladder	6-14
	Setup Conditions	6-14

6.1 Outline of CompoBus/D (DeviceNet)

The E5EK-DRT operates as a slave on the CompoBus/D (DeviceNet) network.

The remote I/O functions of the E5EK-DRT allow data to be received and sent automatically between the master and the slave.

+ Communications defaults

The following shows the communications procedure when the E5EK-DRT is used as a slave on the CompoBus/D (DeviceNet) network.

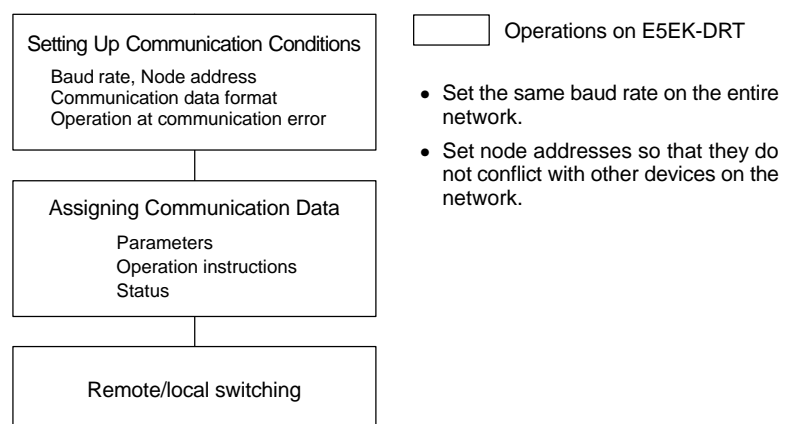

For details on how to turn the master and slaves ON, and the I/O tables on the master, see the CompoBus/D (DeviceNet) Operation Manual (catalog No.: W267).

+ Data assignments

On the E5EK-DRT, the communication data type must be assigned to the read/write areas with the master. Up to 16 channels can be used as read or write areas. The data of each of these channels is assigned in the “write data assignments 1 to 16” and “read data assignments 1 to 16” parameters.

Unused channels can also be specified. This is useful in securing reserved area for data type, and reducing the number of channels.

For details on how to assign data, see 6.4 Data Assignments (page 6–8).



About Writing Communication Data

The E5EK-DRT is set to the local mode before shipment from the factory. Writing of communication data is enabled only in the remote mode. So, before you assign communication write data, be sure to switch the E5EK-DRT to the remote mode.

+ **Remote I/O communications**

When communications is started, the data in the read/write tables is automatically written or read. To write data to the digital controller from the master, set the controller to the “remote mode.” Data cannot be written in the “local mode.” When the data assignment parameters are transmitted at their defaults, the write and read areas are configured as below;

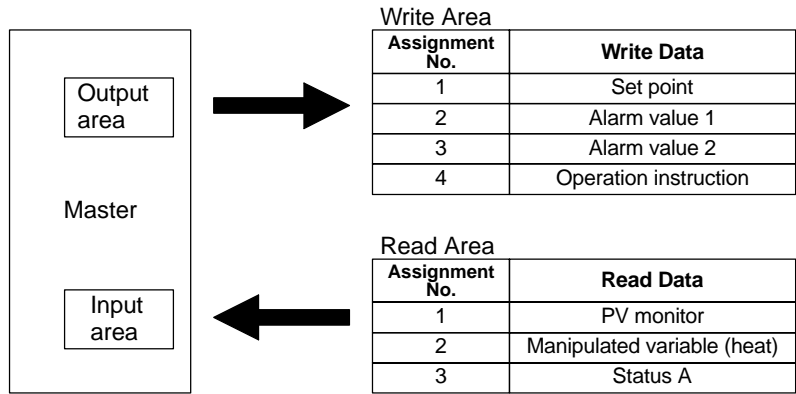

6.2 Data Refreshing by Communications

+ Flow of Communications Processing

The E5EK-DRT executes reading and writing of data by communications as shown in the following figure:

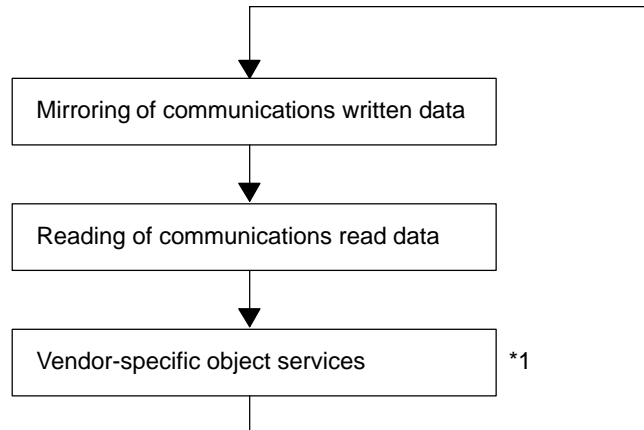

*1 : This process is executed when there is a request for appended vendor-specific services (page A-16) from the Configurator (option). Normally, this process is not executed.

When the master is a programmable controller, the general flow of data is as follows:

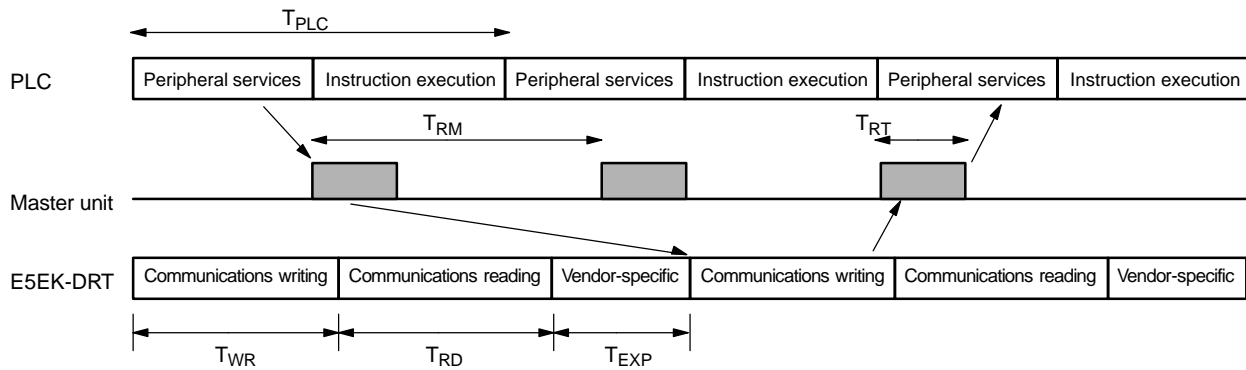

- T_{WR} : E5EK-DRT internal data write processing time
- T_{RD} : E5EK-DRT internal data read processing time
- T_{EXP} : E5EK-DRT internal vendor-specific object processing time
- T_{PLC} : Cycle time on programmable controller
- T_{RM} : Communications cycle time
- T_{RT} : One slave communications time

For details on the communications cycle time and the one slave communications times, refer to the CompoBus/D Operation Manual (W267). For details of the cycle time on the programmable controller, refer to the manual for the programmable controller that you are using.

+ **E5EK-DRT**

The E5EK-DRT internal processing times are as follows:

Internal Processing Times

' Data write processing time

- Writing of data other than operation instructions in the RAM write mode
0.5 ms per data item
- Writing of data other than operation instructions in the EEPROM backup mode
17 ms per data item
- Operation instructions: save RAM data
120 ms
- Operation instructions: instructions other than save RAM data
0.5 ms

' Data writing processing time

- 0.5 ms per data item

' Vendor-specific object processing time

- Get attribute single : 50 ms
- Set attribute single : 0.5 ms

' Example of actual calculation

- Let's assume that the E5EK-DRT is in the factory shipped state, that one E5EK-DRT is connected with a master unit (C200HW-DRM21) in a point-to-point configuration, and that the programmable controller scan time is 2 ms.

Baud rate	125 kbits/second
Write data assignments	4 channels (set point, alarm value 1, alarm value 2, operation instruction)
Read data assignments	3 channel (PV monitor, manipulated variable (heat), status A)
Backup mode	RAM write mode

When “change alarm value 1” and ”stop mode to run mode operation instruction” operations are executed simultaneously, the processing time it takes until the communications data is mirrored on the E5EK-DRT can be calculated as follows:

$$T = T_{PLC} + T_{RM} + T_{WR} + T_{RD} + T_{EXP}$$

$$= 2 + 2.426 + 1 + 1.5 + 0 = 6.926 \text{ms}$$

where,

$$T_{PLC} = 2 \text{ms}$$

$$T_{RM} = 2.426 \text{ms} \quad (\text{at above conditions})$$

$$T_{WR} = 0.5 \text{ms} + 0.5 \text{ms} \quad (\text{at alarm value 1 and operation instruction change})$$

$$T_{RD} = 0.5 \text{ms} + 0.5 \text{ms} + 0.5 \text{ms} \quad (\text{3 channels read at all times})$$

$$T_{EX} = 0 \text{ms} \quad (\text{During normal operation, vendor-specific object services are not processed.})$$

Note: In the above example, the actual processing time is sometimes extended by a maximum of about 80 ms when operation also involves key-switching between the remote and local modes. When keys are not operated (that is, only control processing and communications processing are executed), the actual processing time is sometimes extended by a maximum of about 10 ms. Please take this into consideration when calculating processing times under the worst conditions.

6.3 Setting the Communications Conditions

Set the parameters relating to the items described in this section before you start communications.

+ Baud rate

- The baud rate must be set to the same value over the entire network.
- Select the baud rate in the “baud rate” (option mode) parameter from among 125/250/500 (Kbit/s). Default is “125 (Kbit/s)”.
- Generally speaking, a slower baud rate enables communications over a longer communications path. So, take factors such as the size of the network into consideration when determining the baud rate. The following table shows the relationship between baud rate and network length:

Baud Rate	Max. Network Length		Max. Branch Line Length	Max. Total Branch Length
	Thick Cable	Thin Cable		
500kbit/s	100m max.	100m max.	6m max.	39m max.
250Kbit/s	250m max.			78m max.
125kbit/s	500m max.			156m max.

+ Node address

- Set the node addresses so that they do not conflict with other devices on the Network.
- Select the node address in the “node address” (option mode) parameter within the range 0 to 63. Default is “0”.
- On the E5EK-DRT, occupied channels are increased or decreased by assigning communication data. When you are using the OMRON PLC master, prevent occupied channels from overlapping other devices. For details on assigning channels, see the “CompoBus/D (DeviceNet) Operation Manual (W267).”

Setting example when two E5EK-DRTs are used

The following example is for when assignments are default allocated by OMRON PLC master C200HW-DRM21-V1 when two E5EK-DRTs are used at their factory settings (3 read channels and 4 write channels).

«**Example of Correct Setting**»

Set node addresses to “2” and “6”.

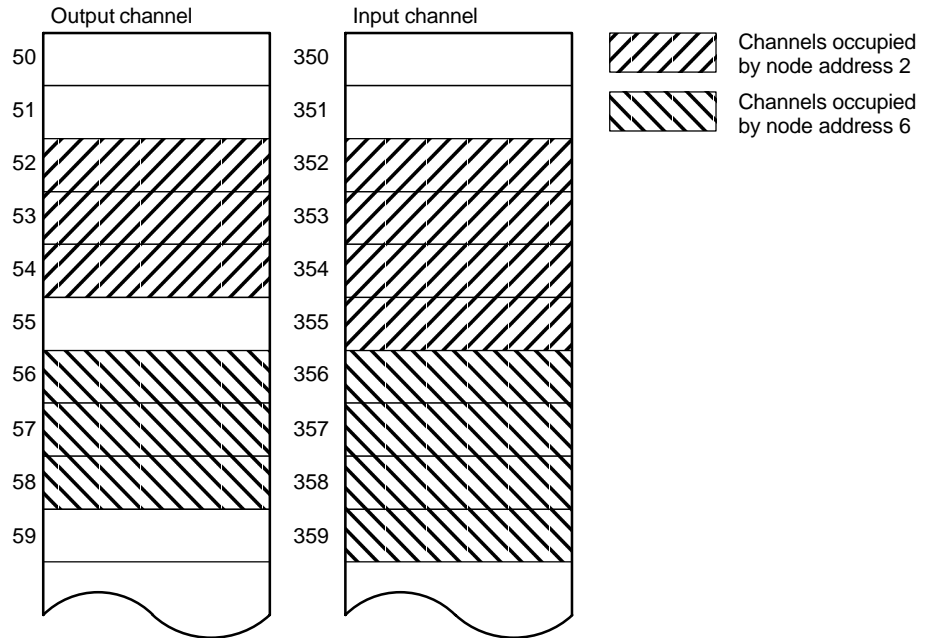

«**Example of Wrong Setting**»

Set node addresses to “2” and “5”.

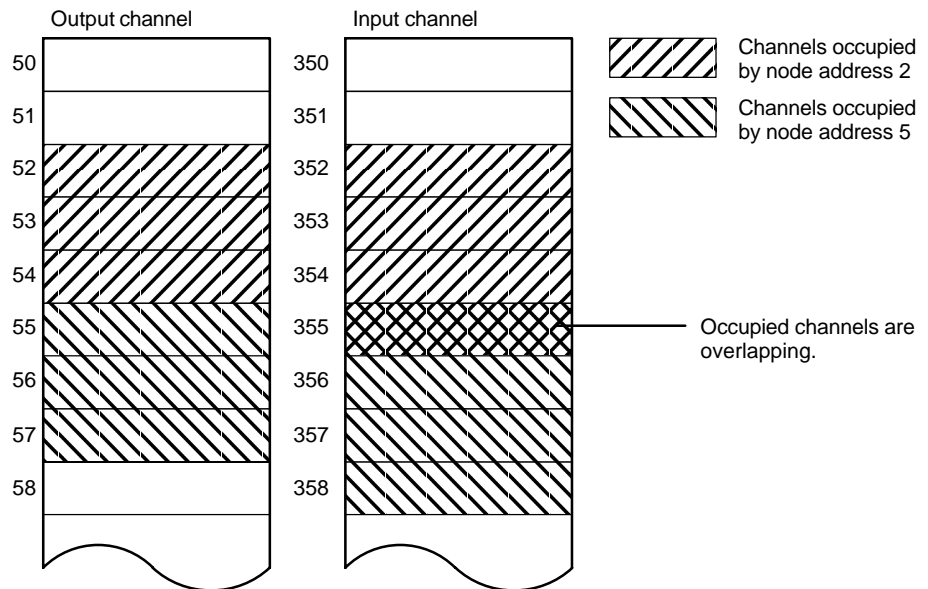

6.4 Data Assignments

+ How to assign data

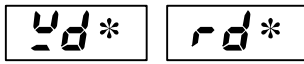

* : 1 to 15

- To assign data to the write area of the E5EK-DRT, set codes (1 to 40) corresponding to the desired data type in [Wd 1 to 15 : write data assignments 1 to 16], and to assign data to the read area, set codes in the [rd 1 to 15 : read data assignments 1 to 16]. Set [non] to unused channels.

- For details on parameters, see “Chapter 5 Parameters, Option Mode” on page 5-36.

Setting reserved channels

- To reserve data type, set [non] as follows. Data is handled as “0000” data.

Details of Assignment		Communication data	
Assignment No.	Data	Assignment No.	Data
1	5	1	0100
2	7	2	0010
3	non	3	0000
4	8	4	0020
5 to 15	non	5 to 15	0000
16	9	16	0030

Reserved channels

Transmitted as “0000”

Setting enabled channels

- To reduce the number of enabled channels, set [non] for the number of disabled channels in descending order from data assignment No.16 as follows.

Details of Assignment		Communication data	
Assignment No.	Data	Assignment No.	Data
1	5	1	0100
2	7	2	0010
3	8	3	0020
4	9	4	0030
5 to 16	non		

Disabled channels

- In this example, the assignments are transmitted as the data of four channels.
- A network error occurs if [non] is set to all channels.

Setup conditions

- If the same code is set to two or more channels, an error occurs when the power is turned ON. However, note that one of the same code can be set to each of the read data assignment and the write data assignment.
- If you attempt to set a read-only parameter to the write area, or alternatively attempt to set a write-only parameter to the read area, “r” or “W” is displayed before the setting code as follows. If this happens, set the parameter to the correct area.

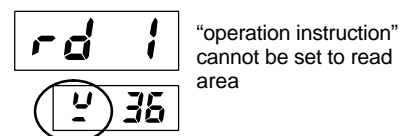
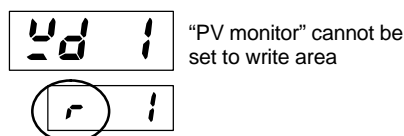

+ **Data format**

- Specify binary (BIN) or binary coded decimal (BCD) as the format of numerical value data in the “communication data format” (option mode) parameter. Default is “BIN”.
- Data is expressed according to the specified format. For example, “999 (decimal)” may be expressed as “270F (BIN)” or “9999 (BCD)”.

+ **Operation at communication error**

- Specify E5EK-DRT operation when a communication error occurs in the “operation at communication error” (option mode) parameter. To continue operations other than communication functions, select “continue”. To stop operations, select “stop”. Default is “continue.”
When the operation is stopped, “MV at stop” will be output.

+ **Data type list**

Assign data types using codes according to the following table:

Setting Value	Description	Read/Write	Setting Value	Description	Read/Write
1	PV monitor	Read	22	SP ramp time unit	Read/Write
2	SP monitor during SP ramp	Read	23	SP ramp set value	Read/Write
3	MV monitor (heat)	Read	24	LBA detection time	Read/Write
4	MV monitor (cool)	Read	25	MV at stop	Read/Write
5	Remote SP monitor	Read	26	MV at PV error	Read/Write
6	Set point	Read/Write	27	MV upper limit	Read/Write
7	Alarm value 1	Read/Write	28	MV lower limit	Read/Write
8	Alarm value 2	Read/Write	29	MV change rate limit	Read/Write
9	Alarm value 3	Read/Write	30	Input digital filter	Read/Write
10	Proportional band	Read/Write	31	Alarm 1 hysteresis	Read/Write
11	Integral time	Read/Write	32	Alarm 2 hysteresis	Read/Write
12	Derivative time	Read/Write	33	Alarm 3 hysteresis	Read/Write
13	Cooling coefficient	Read/Write	34	Input shift upper limit	Read/Write
14	Dead band	Read/Write	35	Input shift lower limit	Read/Write
15	Manual reset value	Read/Write	36	Operation instruction	Write
16	Hysteresis (heat)	Read/Write	37	Status A	Read
17	Hysteresis (cool)	Read/Write	38	Status B	Read
18	Control period (heat)	Read/Write	39	Status at read	Read
19	Control period (cool)	Read/Write	40	Status at write	Read
20	Heater current monitor	Read			
21	Heater burnout alarm	Read/Write	no	No assignment	Read/Write

6.5 Data Structure

Due to the nature of the data, the following description is divided between parameters (assignment Nos. “1” to “35”), operation instructions (assignment No. 36) and statuses (assignment Nos. “37” to “40”).

+ Parameters

- These descriptions cover parameters in levels 0 to 2 modes on the E5EK-DRT. Run/Stop, AT and SP mode (remote/local) parameters are handled as separate operation instruction data.
- Numerical values are expressed as binary (BIN) or binary coded decimal (BCD) according to the setting of the “communication data format” parameter. (Default is “BIN”.)
- When you are entering by BCD codes, express the MSB as follows:
A : -1, F : - (minus)
- When you are entering digits past the digital point, omit the decimal point:

[Example] -1500 = “A500”, -15 = “F015”

[Example] 10.0 = “0100”, 99.99 = “9999”

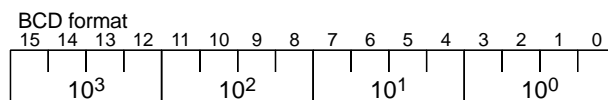
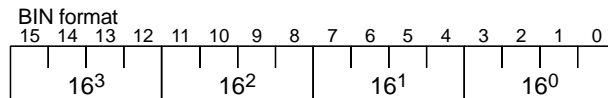

- “0000” is set when a read error occurs.

+ Operation instructions

Bit	Description	"1"	"0"
0	Run/Stop	Run	Stop
1	Remote/Local	Remote	Local
2	RAM write mode	Backup mode	RAM mode
3	RAM data save	Save execution	No processing
4	40% AT execution	40% AT execution	No processing
5	100% AT execution	100% AT execution	No processing
6	AT cancel	AT cancel	No processing
7			
8	SP mode	RSP	LSP
9			
10			
11			
12			
13			
14	Strobe 1	ON : Strobe 1="0" Strobe 2="1"	
15	Strobe 2		

- **Run/Stop (maximum number of writings: 100,000 operations)**
This instruction switches between controller run and stop operation. It cannot be issued in setting level 1.
- **Remote/Local (maximum number of writings: 100,000 operations)**
This instruction switches between remote and local operation.
- **RAM write mode (maximum number of writings: 100,000 operations)**
In the RAM write mode, parameters that are read and written by CompoBus/D (DeviceNet) communications are saved to RAM. In the backup mode, these parameters are saved to EEPROM.
- **RAM data save**
When this instruction is issued, the parameters that are read and written by CompoBus/D (DeviceNet) communications are saved to EEPROM.
- **40% AT Execution/100% AT Execution/AT Cancel**
This instruction executes or cancels AT.
- **SP mode (maximum number of writings: 100000 operations)**
This instruction switches between local SP (LSP) and remote SP (RSP).
- **Operation instructions are executed in order from the instruction having the lower bits only when strobes 1 and 2 are each set to "0" or "1".**
For details on how to use strobes 1 and 2, see 6.6 Data Timing (page 6–13).
- **Make sure that statuses A and B change as intended after an operating instruction is issued.**
- **When the RAM write mode is switched to the backup mode, and when the remote mode is switched to the local mode, the parameters that are read and written by CompoBus/D (DeviceNet) communications are saved to EEPROM.**

+ **Communication error status**

- Check whether or not channel data is being read or written correctly by “status at read” or “status at write”, respectively.
- The following shows the check bits of each channel. These bit assignments are the same for both “status at read” or ”status at write”.

15	14	13	12	11	10	9	8	7	6	5	4	3	2	1	0
CH	CH	CH	CH	CH	CH	CH	CH	CH	CH	CH	CH	CH	CH	CH	CH
16	15	14	13	12	11	10	9	8	7	6	5	4	3	2	1

- “0” indicates a normal channel, and “1” indicates a channel in error. For example, if channels 5 (CH5) and 3 (CH3) are in error, bits 4 and 2 become “1”. Data is expressed as “0014” (Hex).

+ **Status A**

- Check the internal status of E5EK-DRT by “status A” or “status B.”
- The following table shows the meanings of “status A” bits:

Bit	Description	“1”	“0”
0	Heating side output	ON	OFF *1
1	Cooling side output	ON	OFF *1
2	Alarm output 1	ON	OFF *2
3	Alarm output 2	ON	OFF *2
4	Alarm output 3	ON	OFF *2
5	LBA output	ON	OFF *2
6	HBA output	ON	OFF *2
7	Run/Stop	Run	Stop
8	Auto/Manual	Manual	Auto
9	Remote/Local	Remote	Local
10	SP mode	RSP	LSP
11	Auto-tuning	AT execution	OFF
12			
13			
14			
15			

*1 Always “OFF” at linear output

*2 Always “OFF” when output is not assigned

+ **Status B**

- The following table shows the meanings of “status B” bits:

Bit	Description	“1”	“0”
0			
1	RAM write mode	Backup	RAM
2	Control output 1 type	Linear	Pulse
3	Control output 2 type	Linear	Pulse
4	EEPROM	RAM≠EEPROM	RAM=EEPROM
5	Input error	ON	OFF
6	A/D converter error	ON	OFF
7	CT overflow	ON	OFF
8	CT hold	ON	OFF
9			
10	RSP input error	ON	OFF
11			
12			
13			
14			
15			

6.6 Data Timing

This section describes the conditions for internally retrieving the data from the E5EK-DRT input area.

+ Writing parameters

Parameter-related communication data is actually written as a parameter only when one of the following conditions is satisfied:

- (1) When the data differs with the previous data during remote operation
- (2) When the mode is switched to remote from local

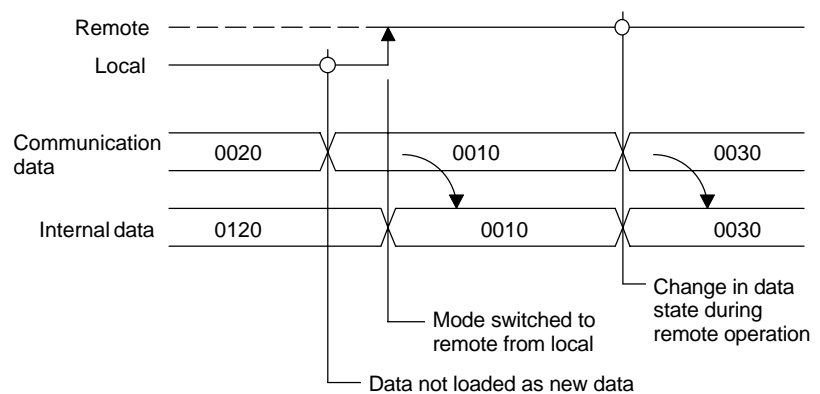

+ Executing operation instructions

Operation instruction data is executed according to the conditions set for the operation instruction only when strobe 1 (bit 14) is "0" and strobe 2 (bit 15) is "1".

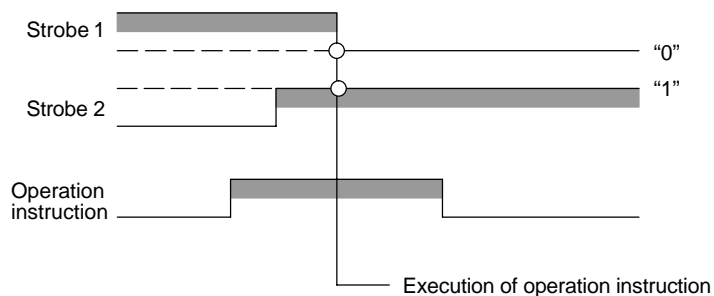

Setting the strobe to OFF (strobe 1 is "1" or strobe 2 is "0") prevents unwanted operation instructions from being executed.

6.7 Sample Ladder

The following sample program shows an example of how to run and stop the program, and how to start 100% AT (auto-tuning).

+ Setup Conditions [E5EK-DRT]

Set the communication conditions between the E5EK-DRT digital controller and the master unit (C200HW-DRM21) as follows:

Baud rate : 500 Kbit/s
 Node address : "3"
 Remote/local : Remote mode
 Controller status : Must be stopped when the power is turned ON and auto-tuning is turned OFF.

[C200H]

Use the C200HX programmable controller (PLC).

Remote I/O : Default remote I/O allocation
 I/O channel : Must be cleared to "0" (zero) when the PLC is turned ON.
 Master unit ID No. : "2"

The following table shows remote I/O assignments to the channels on the PLC.

53ch	Set point	120ch	Software switch
54ch	Alarm value 1	121ch	Master status area
55ch	Alarm value 2	122ch to 125ch	Registered slave data
56ch	Operation instruction	126ch to 129ch	Normal slave data
353ch	PV monitor		
354ch	Manipulated variable (heat)		
355ch	Status A		

For details on the settings on the C200H, see the "CompoBus/D (DeviceNet) Operation Manual (W267)" and "C200HE/HG/HX Operation Manual (W303)."

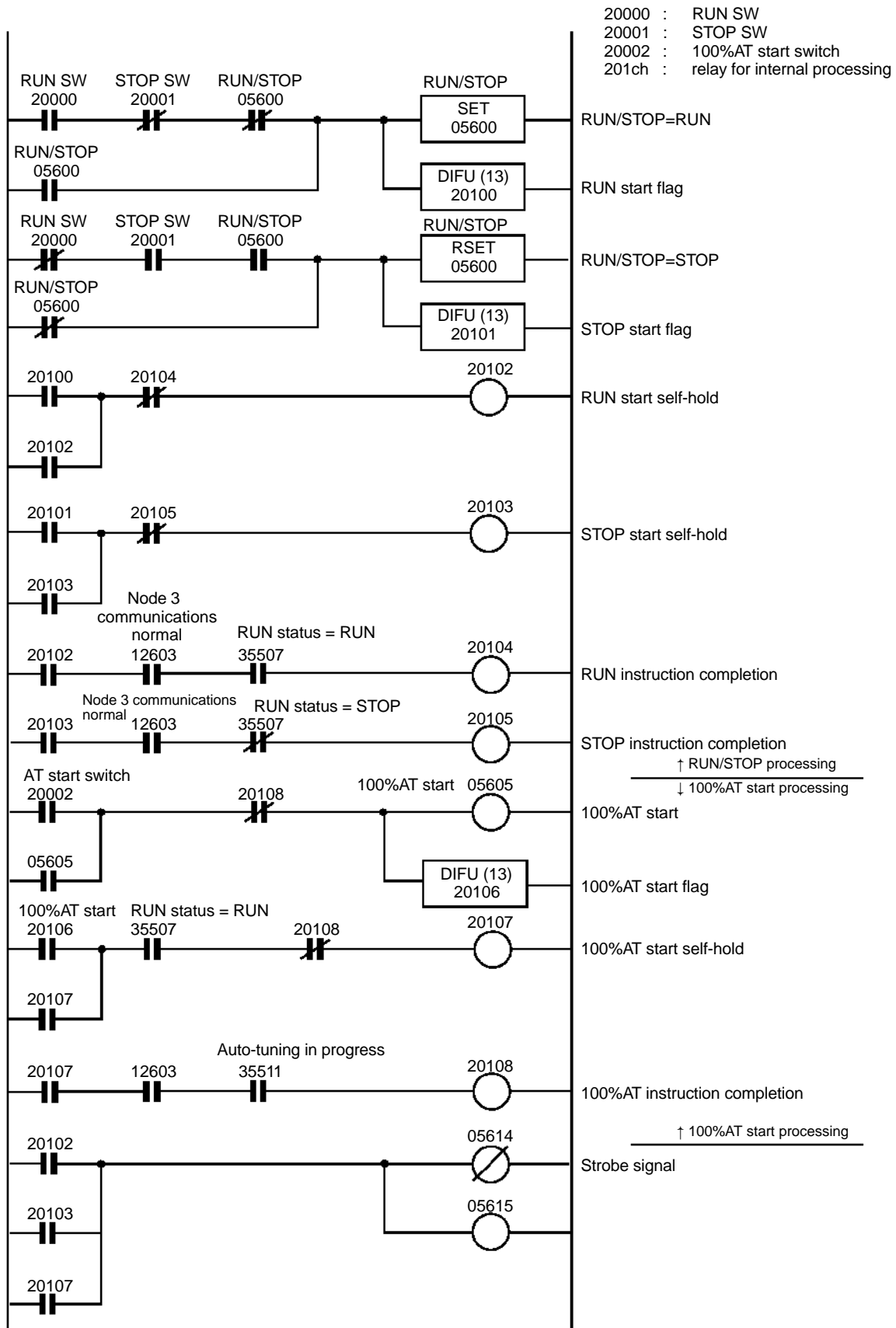

K CHAPTER 7

CALIBRATION

This chapter describes procedures for each calibration operation.
Read this chapter only when the controller must be calibrated.

7.1	Structure of Parameters	7-2
7.2	Calibrating Thermocouple	7-4
7.3	Calibrating Platinum Resistance Thermometers	7-7
7.4	Calibrating Current Input	7-9
7.5	Calibrating Voltage Input	7-10
7.6	Checking Indication Accuracy	7-12

7.1 Structure of Parameters

- To calibrate the E5EK-DRT controller, select [**Cal**] in the menu display to select the calibration mode. [**Adj**] is displayed.
- However, note that [**Cal**] may not be displayed on the menu display when, for example, the user is calibrating the E5EK-DRT controller for the first time. If this happens, [**Cal**] is displayed by changing the “security” parameter (protect mode) to “0”.
- The parameters in the calibration mode are configured as follows.

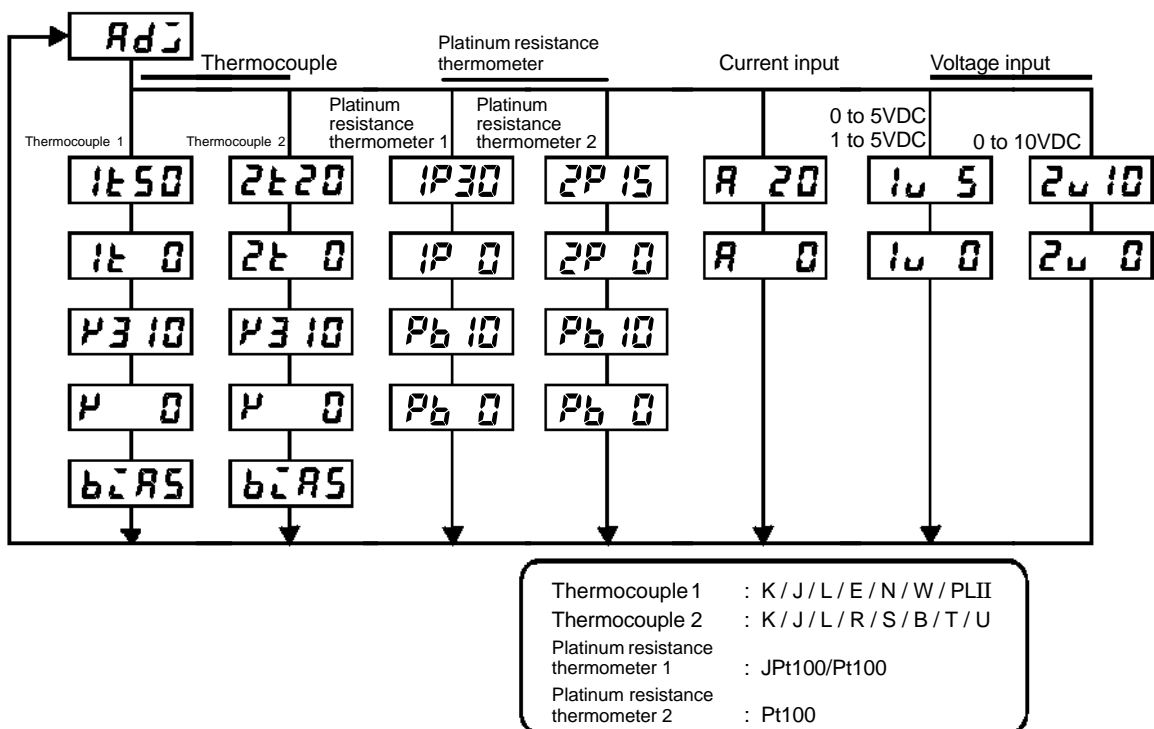

- To select the desired parameter, press the **↔** key. Parameters are displayed in the following order:
 Calibration of inputs → Saving of calibration data
- Only inputs that have been set in the “input type” parameter (setup mode) can be calibrated. To temporarily save data for each of the calibration parameters, press the **✓** key for 1 second.
- The data save menu is displayed only when all calibration items have temporarily been saved.
- After calibrating input, you must always check indication accuracy. For details, see page 7-12.

' Calibration item menu



Calibration item parameter
Process value

- Parameters are displayed on the No.1 display, and the process value is displayed in Hexadecimal on the No.2 display.
- Normally, the process value changes by several digits. The process value flashes, for example, when a sensor error causes the process value to stray from the calibration target range.
- When the process value display is flashing, the process value is not saved as data even if the  key is pressed.

' Calibration save mark



calibration save mark

- Once the E5EK-DRT controller has been calibrated by the user, [Ad.] is preceded by the “.” mark when the calibration mode is selected.

7.2 Calibrating Thermocouple

- Calibrate according to the type of thermocouple, thermocouple group 1 and 2.

Thermocouple group 1

K: -200 to 1300°C, J: -100 to 850°C, L: -100 to 850°C, E, N, W, PLII

Thermocouple group 2

K: 0.0 to 500.0°C, J: 0.0 to 400.0°C, L: 0.0 to 400.0°C, R, S, B, T, U

Preparations

- When calibrating, do not cover the bottom of the controller. Also, do not touch the input terminals (Nos.11 and 12) and compensating conductor on the E5EK-DRT.

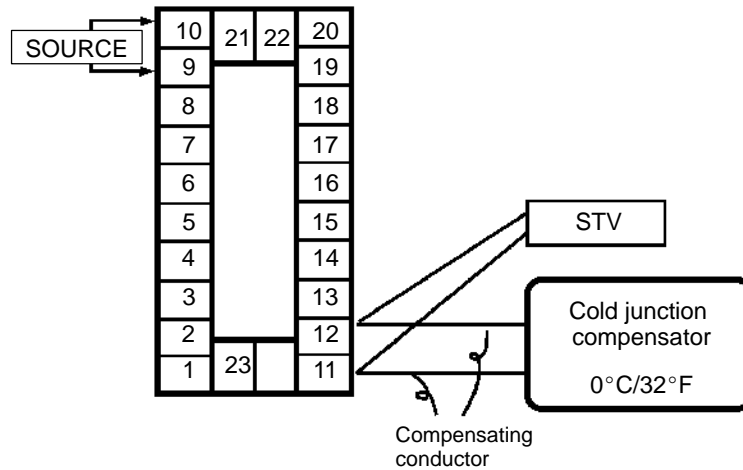

- Set the cold junction compensator to 0°C. However, make sure that internal thermocouples are disabled (tips are open).
- In the above figure, STV refers to a standard DC current/voltage source.
- Use the compensating conductor selected thermocouple. However, note that when thermocouple R, S, E, B, W or PLII is used, the cold junction compensator and the compensating conductor can be substituted with the cold junction compensator and the compensating conductor for thermocouple K.







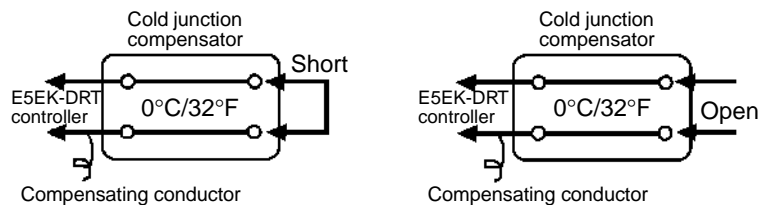



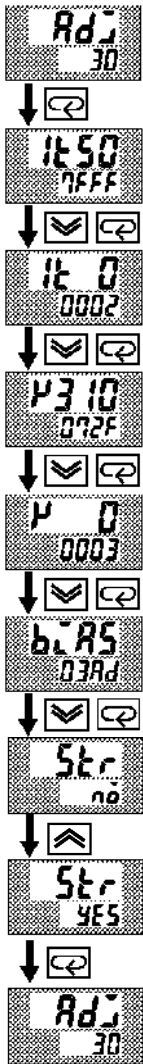





Connecting the Cold Junction Compensator

Correct process values cannot be obtained if you touch the contact ends of the compensating conductor during calibration of a thermocouple. Accordingly, short (enable) or open (disable) the tip of the compensating conductor inside the cold junction compensator as shown in the figure below to create a contact or non-contact state for the cold junction compensator.



Calibration: thermocouple 1



- (1) When [Adj] is displayed, the 30-minute timer is displayed on the No.2 display and counts down. This timer serves as a guide for the aging time when aging is required.
- (2) First, calibrate the main input. Press the  key to display [1E 50] (50mV calibration display). Set STV output to 50mV. When the value on the No.2 display has stabilized (changes of several digits max.), press the  key to temporarily save the calibration data.
- (3) Press the  key to display [1E 0] (0mV calibration display). Set STV output to 0mV. When the value on the No.2 display has stabilized (changes of several digits max.), press the  key to temporarily save the calibration data.
- (4) Next, calibrate the cold junction compensator. Press the  key to display [μ 3 10] (310mV calibration display). Set STV output to 310mV. When the value on the No.2 display has stabilized (changes of several digits max.), press the  key to temporarily save the calibration data.
- (5) Press the  key to display [μ 0] (0mV calibration display). Set STV output to 0mV. When the value on the No.2 display has stabilized (changes of several digits max.), press the  key to temporarily save the calibration data.
- (6) Finally, calibrate the bias compensation value. Disconnect the STV, and enable the thermocouple of the cold junction compensator. When carrying this out, make sure that the wiring on the STV is disconnected. Make sure that the cold junction compensator is set to 0°C and press the  key. The display changes to [b. AS] (calibration display for the bias compensation value). When the value on the No.2 display has stabilized (changes of several digits max.), press the  key to temporarily save the calibration data.
- (7) Press the  key until the display changes to the data save display. Press the  key. The No.2 display changes to [YES], and two seconds later the calibration data is saved to internal memory. If you press the  key when the No.2 display reads [no], the calibration data is invalidated.
- (8) This completes calibration of the thermocouple 1 group. Press the  key to return the display to [Adj].

Calibration:thermocouple 2

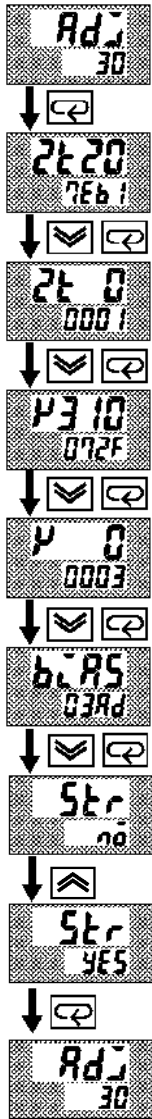

- (1) When [RDJ] is displayed, the 30-minute timer is displayed on the No.2 display and counts down. This timer serves as a guide for the aging time when aging is required.
- (2) First, calibrate the main input. Press the key to display [20mV] (20mV calibration display). Set STV output to 20mV. When the value on the No.2 display has stabilized (changes of several digits max.), press the key to temporarily save the calibration data.
- (3) Press the key to display [0mV] (0mV calibration display). Set STV output to 0mV. When the value on the No.2 display has stabilized (changes of several digits max.), press the key to temporarily save the calibration data.
- (4) Next, calibrate the cold junction compensator. Press the key to display [310mV] (310mV calibration display). Set STV output to 310mV. When the value on the No.2 display has stabilized (changes of several digits max.), press the key to temporarily save the calibration data.
- (5) Press the key to display [0mV] (0mV calibration display). Set STV output to 0mV. When the value on the No.2 display has stabilized (changes of several digits max.), press the key to temporarily save the calibration data.
- (6) Finally, calibrate the bias compensation value. Disconnect the STV, and enable the thermocouple of the cold junction compensator. When carrying this out, make sure that the wiring on the STV is disconnected. Make sure that the cold junction compensator is set to 0°C and press the key. The display changes to [500µV] (calibration display for the bias compensation value). When the value on the No.2 display has stabilized (changes of several digits max.), press the key to temporarily save the calibration data.
- (7) Press the key until the display changes to the data save display. Press the key. The No.2 display changes to [YES], and two seconds later the calibration data is saved to internal memory. If you press the key when the No.2 display reads [RD], the calibration data is invalidated.
- (8) This completes calibration of the thermocouple 2 group. Press the key to return the display to [RDJ].

7.3 Calibrating Platinum Resistance Thermometers

- The calibration procedure is divided into two descriptions, one for group 1 platinum resistance thermometers (Jpt100, Pt100 : -199.9 to 650.0°C) and group 2 platinum resistance thermometers (Pt100 : -100.0 to 100.0°C).

Preparation

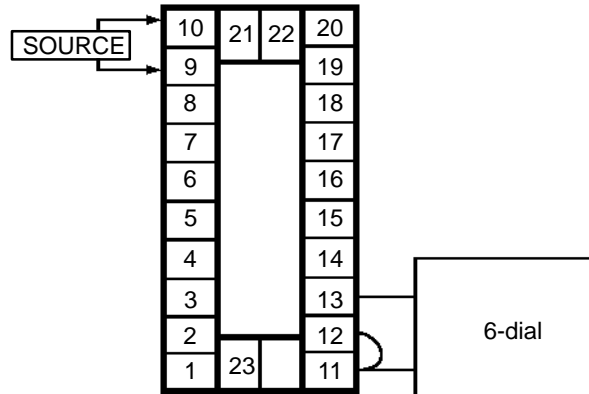

- Use leads of the same thickness when connecting to the platinum resistance thermometer.
- In the above figure, 6-dial refers to a precision resistance box.
- Connect (short) the leads from terminal Nos. 11 and 12.

Calibration: platinum resistance thermometer 1

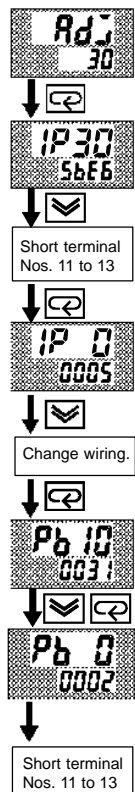

Continued on next page

- When [*Adj*] is displayed, the 30-minute timer is displayed on the No.2 display and counts down. This timer serves as a guide for the aging time when aging is required.
- First, calibrate the main input. Press the key to display [*IP 30*] (300Ω calibration display). Set the 6-dial to 300Ω. When the value on the No.2 display has stabilized (changes of several digits max.), press the key to temporarily save the calibration data.
- Press the key to switch to the [*IP 0*] (0Ω calibration) display. Short terminal Nos. 11 to 13. When the value on the No.2 display has stabilized (changes of several digits max.), press the key to temporarily store the calibration data.
- Next, calibrate the B-B' input. Change the wiring as follows. Make the connection across terminal Nos. 11 and 12 and the 6-dial as short as possible. Short terminal Nos. 11 and 13.

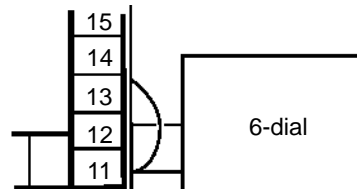

- Press the key to display [*Pb 10*] (10Ω calibration display). Set the 6-dial to 10Ω. When the value on the No.2 display has stabilized (changes of several digits max.), press the key to temporarily store the calibration data.
- Press the key to display [*Pb 0*] (0Ω calibration display). Short terminal Nos. 11 to 13. When the value on the No.2 display has stabilized (changes of several digits max.), press the key to temporarily store the calibration data.

From previous page

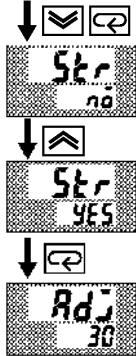

- (7) Press the key until the display changes to the data save display. Press the key. The No.2 display changes to [YES], and two seconds later the calibration data is saved to internal memory.
- (8) If you press the key when the No.2 display reads [no], the calibration data is invalidated.
- (9) This completes calibration of the platinum resistance thermometer 1. Press the key to return the display to [Adj].

Calibration: platinum resistance thermometer 2



- (1) When [Adj] is displayed, the 30-minute timer is displayed on the No.2 display and counts down. This timer serves as a guide for the aging time when aging is required.
- (2) First, calibrate the main input. Press the key to display [2P 15] (150Ω calibration display). Set the 6-dial to 150Ω. When the value on the No.2 display has stabilized (changes of several digits max.), press the key to temporarily save the calibration data.
- (3) Press the key to switch to the [2P 0] (0Ω calibration) display. Short terminal No. 11 to 13. When the value on the No.2 display has stabilized (changes of several digits max.), press the key to temporarily store the calibration data.
- (4) Next, calibrate the B-B' input. Change the wiring as follows. Make the connection across terminal Nos. 11 and 12 and the 6-dial as short as possible. Short terminal Nos. 11 and 13.

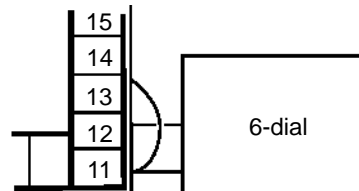

- (5) Press the key to display [Pb 10] (10Ω calibration display). Set the 6-dial to 10Ω. When the value on the No.2 display has stabilized (changes of several digits max.), press the key to temporarily store the calibration data.
- (6) Press the key to display [Pb 0] (0Ω calibration display). Short terminal Nos. 11 to 13. When the value on the No.2 display has stabilized (changes of several digits max.), press the key to temporarily store the calibration data.
- (7) Press the key until the display changes to the data save display. Press the key. The No.2 display changes to [YES], and two seconds later the calibration data is saved to internal memory.
- (8) If you press the key when the No.2 display reads [no], the calibration data is invalidated.
- (9) This completes calibration of the platinum resistance thermometer 2. Press the key to return the display to [Adj].

7.4 Calibrating Current Input

Preparation

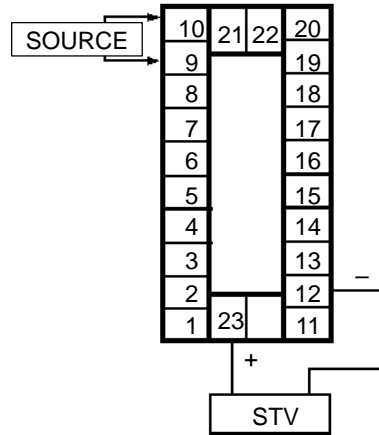

Calibration

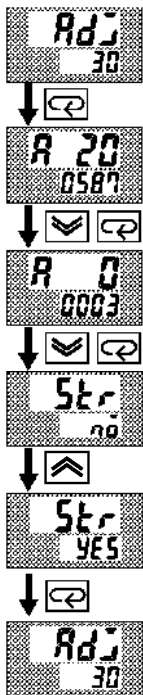

- In the above figure, STV refers to a standard DC current/voltage source.
- When [**Adj**] is displayed, the 30-minute timer is displayed on the No.2 display and counts down. This timer serves as a guide for the aging time when aging is required.
 - Press the \square key. The display changes to [**R 20**] (20mA calibration display). Set the STV output to 20mA. When the value on the No.2 display has stabilized (changes of several digits max.), press the \surd key to temporarily store the calibration data.
 - Press the \square key. The display changes to [**R 0**] (0mA calibration display). Set the STV output to 0 mA. When the value on the No.2 display has stabilized (changes of several digits max.), press the \surd key to temporarily store the calibration data.
 - Press the \square key until the display changes to the data save display. Press the \wedge key. The No.2 display changes to [**YES**], and two seconds later the calibration data is saved to internal memory. If you press the \square key when the No.2 display reads [**no**], the calibration data is invalidated.
 - This completes calibration of current input. Press the \square key to return the display to [**Adj**].

7.5 Calibrating Voltage Input

Preparation

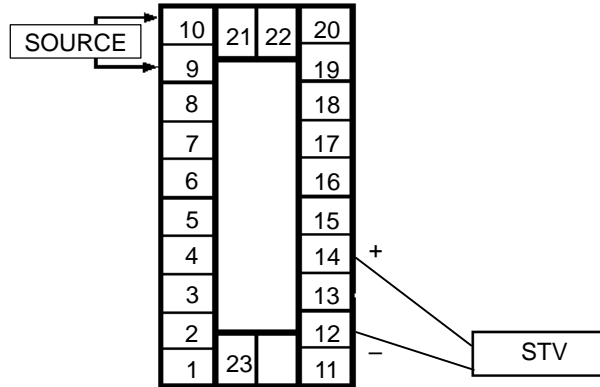

- In the above figure, STV refers to a standard DC current/voltage source.

Calibration: 0 to 5 VDC, 1 to 5 VDC

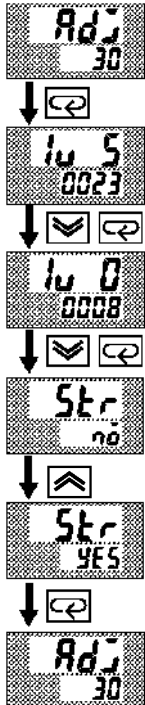

- (1) When [Adj] is displayed, the 30-minute timer is displayed on the No.2 display and counts down. This timer serves as a guide for the aging time when aging is required.
- (2) Press the key. The display changes to [5] (5VDC calibration display). Set the STV output to 5VDC. When the value on the No.2 display has stabilized (changes of several digits max.), press the key to temporarily store the calibration data.
- (3) Press the key. The display changes to [0] (0V calibration display). Set the STV output to 0V. When the value on the No.2 display has stabilized (changes of several digits max.), press the key to temporarily store the calibration data.
- (4) Press the key until the display changes to the data save display. Press the key. The No.2 display changes to [YES], and two seconds later the calibration data is saved to internal memory. If you press the key when the No.2 display reads [no], the calibration data is invalidated.
- (5) This completes calibration of voltage input (0 to 5VDC, 1 to 5VDC). Press the key to return the display to [Adj].

**Calibration :
0 to 10VDC**

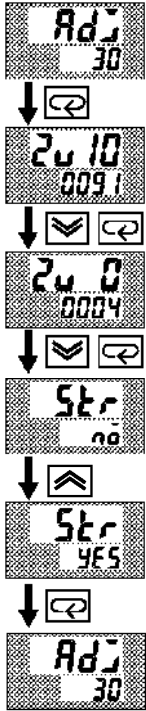

- (1) When [Adj] is displayed, the 30-minute timer is displayed on the No.2 display and counts down. This timer serves as a guide for the aging time when aging is required.
- (2) Press the key. The display changes to [20 10] (10VDC calibration display). Set the STV output to 10VDC. When the value on the No.2 display has stabilized (changes of several digits max.), press the key to temporarily store the calibration data.
- (3) Press the key. The display changes to [20 0] (0V calibration display). Set the STV output to 0V. When the value on the No.2 display has stabilized (changes of several digits max.), press the key to temporarily store the calibration data.
- (4) Press the key until the display changes to the data save display. Press the key. The No.2 display changes to [YES], and two seconds later the calibration data is saved to internal memory. If you press the key when the No.2 display reads [no], the calibration data is invalidated.
- (5) This completes calibration of voltage input (0 to 10VDC). Press the key to return the display to [Adj].

7.6 Checking Indication Accuracy

+ Checking Indication Accuracy

- After calibrating input, make sure that you check indication accuracy to make sure that the E5EK-DRT controller has been correctly calibrated.
- Operate the E5EK-DRT controller in the PV/SP monitor (level 0 mode) mode.
- Check the indication accuracy at the upper and lower limits and mid-point.

' Thermocouple

- Preparation

The following figure shows the required device connection. Make sure that the E5EK-DRT controller and cold junction compensator are connected by a compensating conductor for the input type that is to be used during actual operation.

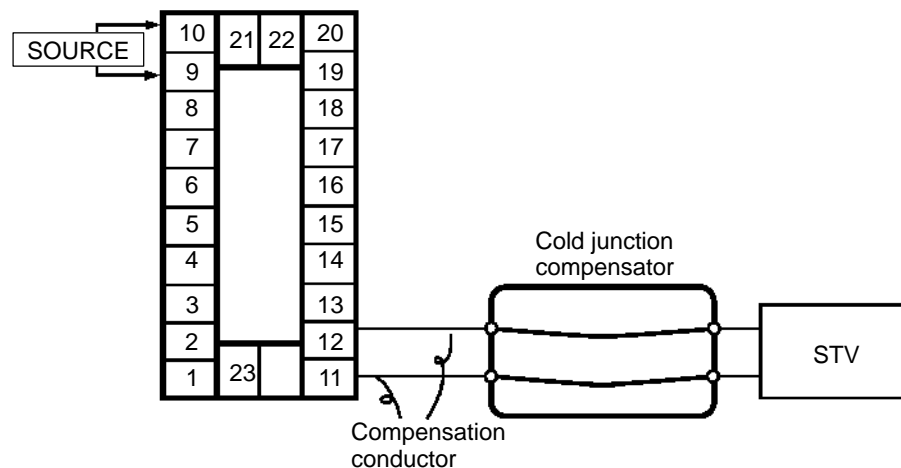

- Operation

Make sure that the cold junction compensator is at 0°C, and set STV output to the voltage equivalent to the starting power of the check value.

' Platinum resistance thermometer

- Preparation

The following figure shows the required device connection.

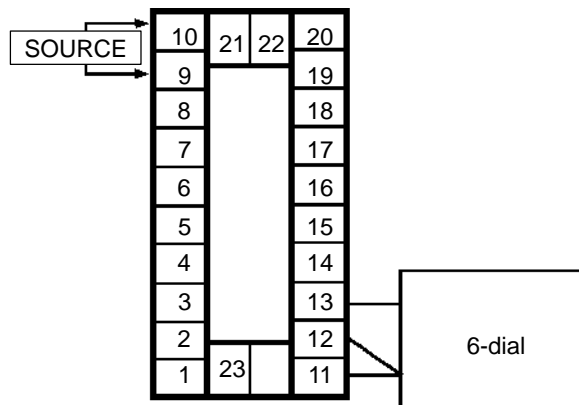

- Operation

Set the 6-dial to the resistance equivalent to the check value.

Current input

- Preparation

The following figure shows the required device connection.

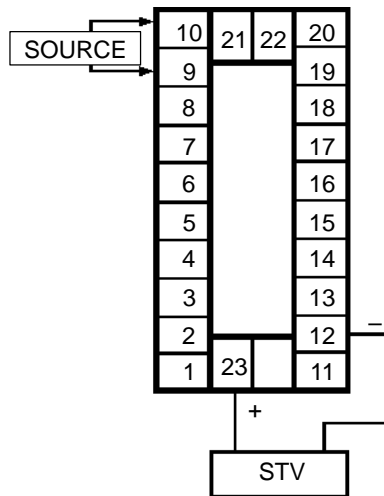

- Operation

Set the STV to the current value equivalent to the check value.

Voltage input

- Preparation

The following figure shows the required device connection.

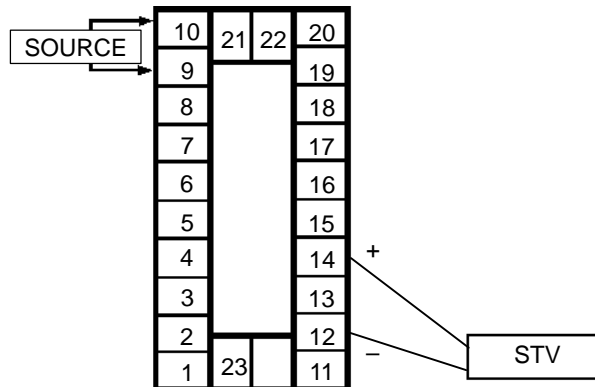

- Operation

Set the STV to the voltage value equivalent to the check value.

K CHAPTER 8

TROUBLESHOOTING

This chapter describes how to find out and remedy the cause if the E5EK-DRT does not function properly.

8.1	Initial Checks	8-2
8.2	How to Use the Error Display	8-3
8.3	How to Use Error Output	8-5
8.4	Checking Operation Restrictions	8-6

8.1 Initial Checks

If trouble occurs, first check items (1) to (3). Correct any problems you find according to the remedy described.

- (1) Power supply
Make sure that the power supply is ON. Also, make sure that the power supply is within the rated voltage range.
- (2) Wiring
Make sure that all cables are properly connected.
- (3) Communication conditions
 - When CompoBus/D (DeviceNet) is in use, make sure that the node addresses and baud rate conditions match, and that settings are within the specified ranges.
Make sure that communication data assignment, communication data format, operation at communication error, and remote/local selection are correctly set.

If, as a result of checking or processing, the trouble is not remedied, check the details, for example, on the error display.

MS/NS Indicator

When communications is being performed successfully, both the MS and NS indicators light green.

The E5EK-DRT is equipped with a function for monitoring the communications power supply.

For this reason, the MS lights green and NS blinks red when the E5EK-DRT power is being supplied with the communications power not being supplied.

MS (Module Status) Indicates the status of the node itself.

NS (Network Status) Indicates the status of the network.

LED Lighting Specifications

LED Status	Meaning (main error)
MS: Lights green NS: Lights green	In this state, the communications network and control are normal.
MS: Lights green NS: Blinks green	In this state, the communications connection with the master is not established.
MS: Lights green NS: Blinks red	A time-out has occurred in communications with the master, or the communications power supply may not be supplied.
MS: Lights green NS: Lights red	A duplicated node address error has occurred, or BusOff (communications stopped by frequently occurring data errors) has been detected.
MS: Lights red NS: Out	Unrecoverable fatal error has occurred. If this trouble persists even after the E5EK-DRT has been turned OFF and then ON again, repair is necessary.
MS: Blinks red NS: Current status	A CompoBus/D (DeviceNet) communications data assignment error has occurred. When a communications data assignment error occurs, change the settings using the keys on the front panel or a configurator. The NS indicator indicates the current status, and is controlled normally.

MS: Out	Power is not being supplied to the controller, or the controller is reset.
NS: Out	The controller is not on-line.

8.2 How to Use the Error Display

When an error has occurred, the No.1 display alternately indicates error codes together with the current display item.

This section describes how to check error codes on the display, and the actions you must be taken to remedy the problem.

E r r

Input error

- ′ **Meaning** Input is in error.
- ′ **Action** Check the wiring of inputs, disconnections, and shorts, and check the input type.
- ′ **Operation at error** For control output functions, output the manipulated variable matched to the setting of the “MV at PV error” parameter (level 2 mode). Alarm output functions are activated when the upper limit is exceeded.

E ! ! !

Memory error

- ′ **Meaning** Internal memory operation is in error.
- ′ **Action** First, turn the power OFF then back ON again. If the display remains the same, the E5EK-DRT controller must be repaired. If the display is restored to normal, then a probable cause can be external noise affecting the control system. Check for external noise.
- ′ **Operation at error** Control output functions turn OFF (2mA max. at 4 to 20mA output, and output equivalent to 0% in case of other outputs). Alarm output functions turn OFF.

E 3 3 3

A/D converter error

- ′ **Meaning** Internal circuits are in error.
- ′ **Action** First, turn the power OFF then back ON again. If the display remains the same, the E5EK-DRT controller must be repaired. If the display is restored to normal, then a probable cause can be external noise affecting the control system. Check for external noise.
- ′ **Operation at error** Control output functions turn OFF (2mA max. at 4 to 20mA output, and output equivalent to 0% in case of other outputs). Alarm output functions turn OFF.

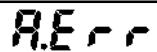

Calibration data error

This error is output only during temperature input, and is displayed for two seconds when the power is turned ON.

- ′ **Meaning** Calibration data is in error.
- ′ **Action** Must repair.
- ′ **Operation at error** Both control output functions and alarm output functions operate. However, note that readout accuracy is not assured.

Display range over

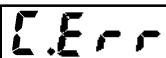
- ′ **Meaning** Though not an error, this is displayed when the process value exceeds the display range when the control range (setting range $\pm 10\%$) is larger than the display range (-1999 to 9999).
 - When less than “-1999” [c c c c]
 - When greater than “9999” [3 3 3 3]
- ′ **Operation** Control continues, allowing normal operation.

Communications error

- ′ **Meaning** The communications read/write data assignment is in error. This error occurs in the following instances:
 - When the same data is set to two or more channels
 - When write-only data is set to a read data assignment
 - When read-only data is set to a write data assignment
- ′ **Action** Check and reset the communications read/write data assignment data in the option mode. For details, see “6.4 Data Assignments.”
- ′ **Operation at error** Control output functions turn OFF (2mA max. at 4 to 20mA output, and output equivalent to 0% in case of other outputs). Alarm output functions turn OFF.

8.3 How to Use Error Output

The E5EK-DRT controller allows you to assign error output to terminals as outputs.

For details on output assignments, see 3.3 Setting Output Specifications (page 3-7).

- ‘ **LBA**

 - LBA (Loop Break Alarm) can be used as a means for detecting loop breaks when the control loop is not functioning normally. For details, see page 4-11.
 - LBA allows you to detect the following errors:
 - (1) Heater burnout
 - (2) Output error (contact weld, damaged transistors, etc.)
 - (3) Sensor error (constant input values, etc.)
 - If you use the LBA function, set the loop break detection time matched to the control characteristics in the “LBA detection time” parameter (level 2 mode).

- ‘ **Input errors**

 - If you assign error 1 as the output, an error can be output to auxiliary output 1 or auxiliary output 2 when input is in error. When this error occurs, remedy by following the description for “Input error” (page 8-3).

- ‘ **A/D converter error**

 - If you assign error 2 as the output, an error can be output to auxiliary output 1 or auxiliary output 2 when the A/D converter is in error. When this error occurs, remedy by following the description for “A/D converter error” (page 8-3).

- ‘ **Remote SP input error**

 - If you assign error 3 as the output, an error can be output to auxiliary output 1 or auxiliary output 2 when the remote SP input error occurs while the remote SP function is enabled. For details on error displays and meanings, see Chapter 4 Applied Operation/4.3 How to Use the Remote SP (page 4-7).
 - When an error occurs, check the state of the remote SP connection. If the lead is broken or disconnected, the remote SP scaling lower limit is displayed blinking on the PV/SP display or remote SP monitor display.

8.4 Checking Operation Restrictions

With the E5EK-DRT controller, auto-tuning sometimes does not operate depending on the way functions are combined. The table below summarizes the main operating restrictions.

If the E5EK-DRT controller is not operating properly, first check whether operating conditions violate the restrictions in this table.

Restriction	Inoperable or Invalid Functions		
	AT Execution	Limiter Function	Other
At heating and cooling control	40% AT impossible		
At ON/OFF control	Execution impossible	Manipulated variable MV change rate	
At AT execution		MV change rate	Parameter setting
At stop	Execution impossible	Manipulated variable MV change rate	

K APPENDIX

SPECIFICATIONS	A-2
ABOUT CURRENT TRANSFORMER (CT) ...	A-5
CONTROL BLOCK DIAGRAM	A-6
Setting and Monitoring Parameter List	A-7
PARAMETER OPERATIONS LIST	A-11
Using the E5EK-DRT in Multi-vendor Applications	A-13

SPECIFICATIONS

+ Ratings

Supply voltage	100 to 240 VAC, 50/60 Hz	24 VAC/DC, 50/60 Hz
Operating Voltage Range	85% to 110% of rated supply voltage	
Power Consumption	15 VA	12 VA, 8 W
Sensor Input	Thermocouple: K, J, T, E, L, U, N, R, S, B, W, PLII *1, *2 Platinum resistance thermometer: JPt100, Pt100 Current input: 4 to 20mA, 0 to 20 mA (input impedance 150Ω) Voltage input: 1 to 5VDC, 0 to 5VDC, 0 to 10VDC (input impedance 1MΩ)	
Sub-Input	CT input: E54-CT1, E54-CT3 Remote SP input: 4 to 20 mA (input impedance 150Ω)	
Control Output	According to output unit (see page 2-8)	
Auxiliary Output	1a 250 VAC, 3A (resistive load), electrical life: 100,000 operations	
Control Method	2-PID or ON/OFF control	
Setting Method	Digital setting using front panel keys	
Indication Method	7-segment digital display and LEDs	
Communications Method	CompoBus/D (DeviceNet)	
Ambient Temperature	-10 to 55°C (with no condensation or no icing)/3-year warranty period: -10 to 50°C	
Ambient Humidity	Relative humidity 35 to 85%	
Storage Temperature	-25 to 65°C (with no condensation or no icing)	
Storage humidity	Relative humidity 35 to 85%	
Altitude	2000 m max.	
Recommended fuse	T2A, 250 VAC, time lag, low-cutoff capacity	
CompoBus/D (DeviceNet)	Communications power voltage	11 to 25 VDC
	Power consumption	30 mA max.

*1 Thermocouple W is W/Re5-26.

*2 For details on the input setting ranges and indication ranges, see page A-4.

+ Communications Specifications

Communications path	Multi-drop, T-branch *1			
Baud rate	500/250/125 Kbit/s (set on front panel)			
Communications medium	Dedicated 5-lead cable (2 signal lines, 2 power lines, 1 shielded cable)			
Communications distance	Communications speed	Max. network length *2	Branch length	Total branch length
	500 Kbit/s	100 m *3	6 m max.	39 m max.
	250 Kbit/s	250 m *3	6 m max.	78 m max.
125 Kbit/s	500 m *3	6 m max.	156 m max.	
Maximum number of connected nodes	64 (including master. Hence, maximum number of connected slaves is 63)			
Error control	CRC, node address duplication check			

*1 External attachment of terminator is required.

*2 Distance between most distant nodes

*3 100 m when fine dedicated cable is used for the trunk

+ Characteristics

Indication Accuracy	Thermocouple: ($\pm 0.3\%$ of indication value or $\pm 1^\circ\text{C}$, whichever greater) ± 1 digit max. (*1) Platinum resistance thermometer: ($\pm 0.2\%$ of indication value or $\pm 0.8^\circ\text{C}$ whichever greater) ± 1 digit max. (*2) Analog input: $\pm 0.2\% \pm 1$ digit max. CT input: $\pm 5\% \text{FS} \pm 1$ digit max. Remote SP: $\pm 0.2\% \text{FS} \pm 1$ digit max.	
Hysteresis	0.01 to 99.99%FS (in units of 0.01%FS)	
Proportional Band (P)	0.1 to 999.9% FS (in units of 0.1%FS)	
Integral Time (I)	0 to 3999 s (in units of 1 second)	
Derivative Time (D)	0 to 3999 s (in units of 1 second)	
Control Period	1 to 99 s (in units of 1 second)	
Manual Reset Value	0.0 to 100.0% (in units of 0.1%)	
Alarm Setting Range	-1999 to 9999 (decimal point position dependent on input type or result of scaling)	
Sampling Period	Temperature input: 250 ms, Analog input: 100 ms, Sub-input : 1s	
Insulation Resistance	20 M Ω min. (at 500 VDC)	
Dielectric Strength	2000 VAC, 50/60Hz for 1 min (between terminals of different polarities)	
Vibration Resistance	Malfunction	10 to 55 Hz, 10 m/s ² for 10 min each in X, Y, and Z directions
	Destruction	10 to 55 Hz, 20 m/s ² for 2hrs each in X, Y, and Z directions
Shock Resistance	Malfunction	200 m/s ² min., 3 times each in 6 directions (100 m/s ² applied to the relay)
	Destruction	300 m/s ² min., 3 times each in 6 directions
Weight	Approx. 320 g, mounting bracket: approx. 65 g	
Enclosure Ratings	Front panel : NEMA4 for indoor use (equivalent to IP66) Rear case : IP20 Terminals : IP00	
Memory Protection	Non-volatile memory (number of writings : 100,000 operations)	

*1The indication accuracy of K thermocouples at a temperature of -200 to 1300°C, of T and N thermocouples at -100°C or less, and of U and L thermocouples at any temperature is $\pm 2^\circ\text{C} \pm 1$ digit maximum.
 The indication accuracy of the B thermocouple at a temperature of 400°C or less is unrestricted.
 The indication accuracy of R and S thermocouples at a temperature of 200°C or less is $\pm 3^\circ\text{C} \pm 1$ digit or less.
 The indication accuracy of the W thermocouple at a temperature of is ± 1 digit max. of whichever is the greater of $\pm 0.3\%$ or $\pm 3^\circ\text{C}$ of the indicated value.
 The indication accuracy of the PLII thermocouple at a temperature of is ± 1 digit max. of whichever is the greater of $\pm 0.3\%$ or $\pm 2^\circ\text{C}$ of the indicated value.

*2The indication accuracy of the Pt thermocouple in the -100.0 to 100.0°C range is $\pm 0.1\% \text{FS} \pm 1$ digit maximum.

' Heater Burnout Alarm

Max. heater current	Single-phase 50 A AC
Heater current value display accuracy	$\pm 5\% \text{FS} \pm 1$ digit max.
Heater burnout alarm setting range	0.1 to 49.9 A (in units of 0.1 A) 0.0 A : Heater burnout alarm output turns OFF. 50.0 A : Heater burnout alarm output turns ON.
Min. detection ON time	190 ms *1

*1 No heater burnout detection or heater current value measurement is possible if the control output is ON for less than 190 ms.

+ Setting range and Indication range of Sensor input

Input	Setting Range		Indication Range		Conventional indication
JPt100	-199.9 to 650.0(°C)	/-199.9 to 999.9(°F)	-199.9 to 735.0(°C)	/-199.9 to 999.9(°F)	JPt100
Pt100	-199.9 to 650.0(°C)	/-199.9 to 999.9(°F)	-199.9 to 735.0(°C)	/-199.9 to 999.9(°F)	Pt100
	-100.0 to 100.0(°C)	/-150.0 to 250.0(°F)	-120.0 to 120.0(°C)	/-190.0 to 290.0(°F)	
K	-200 to 1300(°C)	/-300 to 2300(°F)	-350 to 1450(°C)	/-560 to 2560(°F)	K1
	0.0 to 500.0(°C)	/0.0 to 900.0(°F)	-50.0 to 550.0(°C)	/-90.0 to 990.0(°F)	K2
J	-100 to 850(°C)	/-100 to 1500(°F)	-195 to 945(°C)	/-260 to 1660(°F)	J1
	0.0 to 400.0(°C)	/0.0 to 750.0(°F)	-40.0 to 440.0(°C)	/-75.0 to 825.0(°F)	J2
T	-199.9 to 400.0(°C)	/-199.9 to 700.0(°F)	-199.9 to 460.0(°C)	/-199.9 to 790.0(°F)	T
E	0 to 600(°C)	/0 to 1100(°F)	-60 to 660(°C)	/-110 to 1210(°F)	E
L	-100 to 850(°C)	/-100 to 1500(°F)	-195 to 945(°C)	/-260 to 1660(°F)	L1
	0.0 to 400.0(°C)	/0.0 to 750.0(°F)	-40.0 to 440.0(°C)	/-75.0 to 825.0(°F)	L2
U	-199.9 to 400.0(°C)	/-199.9 to 700.0(°F)	-199.9 to 460.0(°C)	/-199.9 to 790.0(°F)	U
N	-200 to 1300(°C)	/-300 to 2300(°F)	-350 to 1450(°C)	/-560 to 2560(°F)	N
R	0 to 1700(°C)	/0 to 3000(°F)	-170 to 1870(°C)	/-300 to 3300(°F)	R
S	0 to 1700(°C)	/0 to 3000(°F)	-170 to 1870(°C)	/-300 to 3300(°F)	S
B	100 to 1800(°C)	/300 to 3200(°F)	-70 to 1970(°C)	/10 to 3490(°F)	B
W	0 to 2300(°C)	/0 to 4100(°F)	-230 to 2530(°C)	/-410 to 4510(°F)	W
PLII	0 to 1300(°C)	/0 to 2300(°F)	-130 to 1430(°C)	/-230 to 2530(°F)	PLII
4 to 20mA 0 to 20mA 1 to 5VDC 0 to 5VDC 0 to 10VDC	One of following ranges depending on results of scaling -1999 to 9999 -199.9 to 999.9 -19.99 to 99.99 -1.999 to 9.999		-10 to 110% of setting range. Note, however that max. value is -1999 to 9999		

The standard applicable to each input type are as follows:

K, J, T, E, R, S, B : IEC 584-1 ; 1977

L : Fe-CuNi, DIN 43710-1985

U : Cu-CuNi, DIN 43710-1985

N : Nicrosi 1-NisiL, IEC584-1; 1977 Amendment No.1; 1989

W : W5Re/W26Re, ASTM E988-1990

PLII : According to the PLATINEL II Electromotive Force Tables from ENGELHARD

Jpt100: JIS C 1604-1989, JIS C 1606-1989

Pt100 : IEC751 ; 1983

+ Output Rating and Performance

These are according to the output unit mounted. For details on output unit ratings, see page 2-8.

ABOUT CURRENT TRANSFORMER (CT)

Specifications

Item	Specifications	
Type	E54-CT1	E54-CT3
Max. continuous heater current	50A	120A (*1)
Dielectric Streng	1000VAC (1min)	
Vibration Resistance	50Hz 98m/s ²	
Weight	Approx. 11.5g	Approx. 50g
Accessory	No	Armature (2) Plug (2)

*1 The maximum continuous current of the E5EK-DRT is 50 A.

Dimensions

E54-CT1

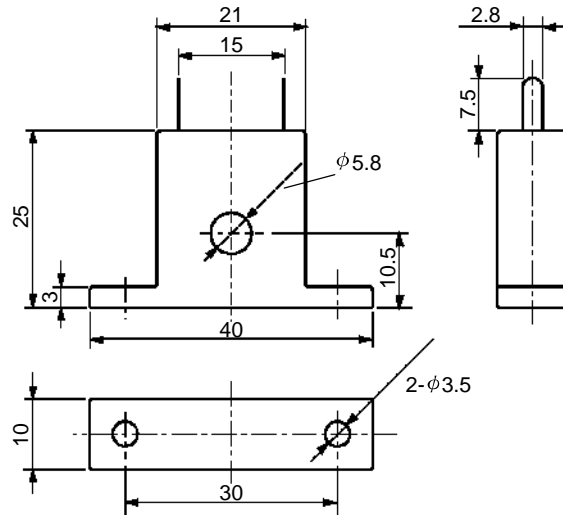

E54-CT3

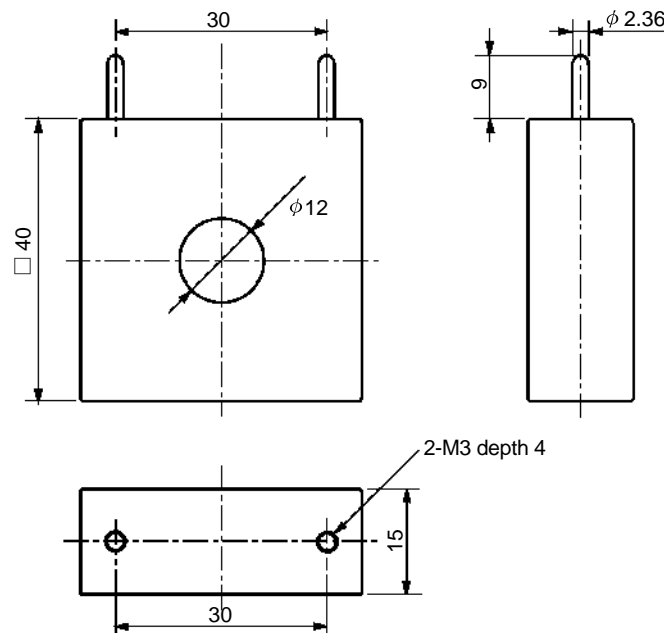

CONTROL BLOCK DIAGRAM

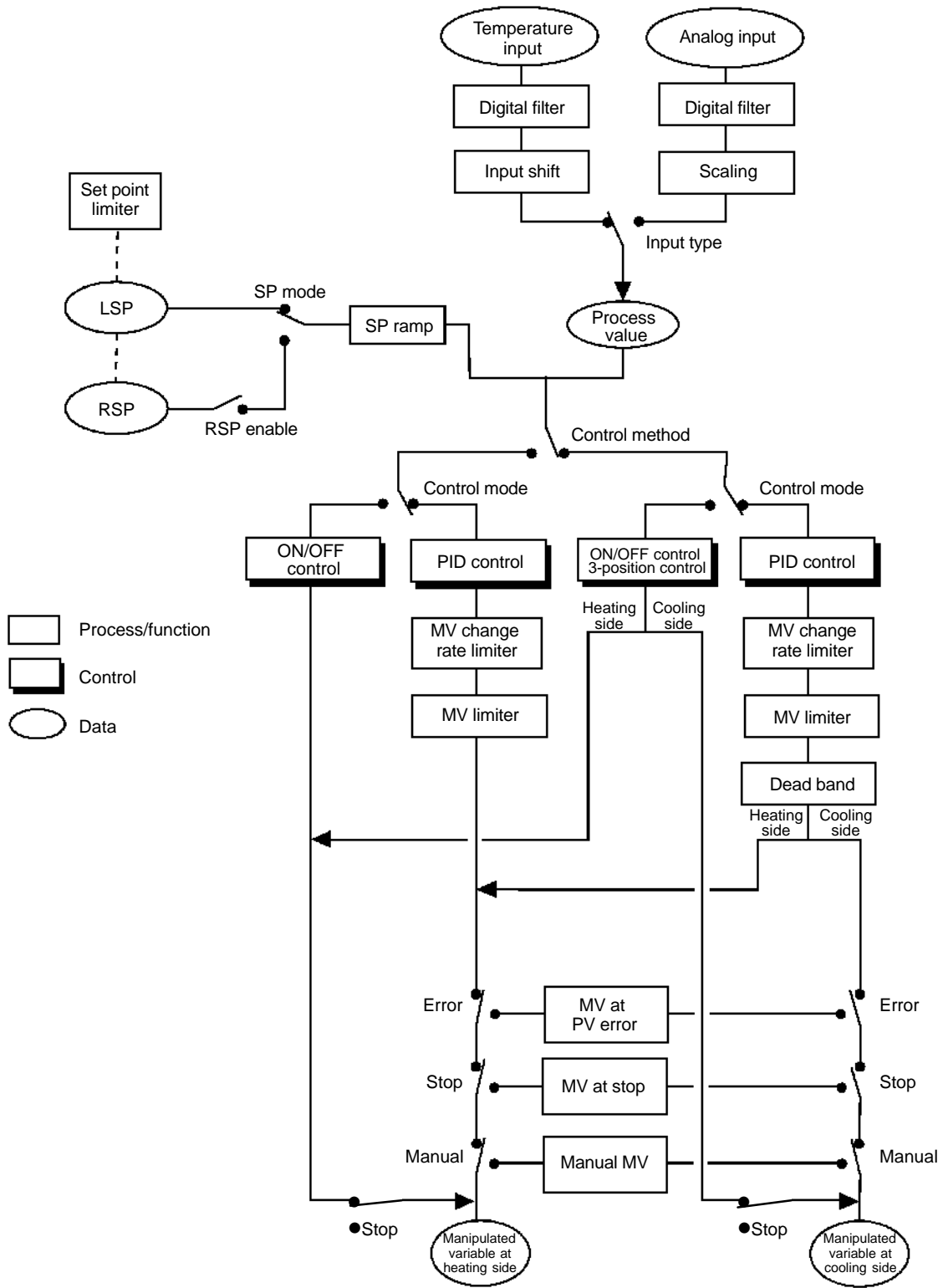

SETTING AND MONITORING PARAMETER LIST

Some parameters are not displayed depending on the protect mode setting and conditions of use.

Mode	Parameter Name	Setting Range	Unit	Default	Remarks	Setting
Protect	SECr Security	0 to 6	None	1		
	PEYp [A/M] key protect	ON/OFF	None	OFF		
Manual	Manual MV	-5.0 to 105.0 *1	%	0.0		
Level 0	PV		EU			
	Set point	SP setting lower limit to SP setting upper limit	EU	0		
	rSP Remote SP monitor		EU			
	SP-n Set point during SP ramp		EU			
	o MV monitor (heat)		%			
	[o MV monitor (cool)		%			
	r-S Run/Stop	RUN/STOP	None	RUN		
Level 1	At AT Execute/Cancel	OFF/AT-1/AT-2	None	OFF	During running	
	AL-1 Alarm value 1	-1999 to 9999	EU	0		
	AL-2 Alarm value 2	-1999 to 9999	EU	0		
	AL-3 Alarm value 3	-1999 to 9999	EU	0		
	P Proportional band	0.1 to 999.9	%FS	10.0		
	I Integral time	0 to 3999	sec	233		
	d Derivative time	0 to 3999	sec	40		
	[S[Cooling coefficient	0.01 to 99.99	None	1.00	At heating and cooling control	
	[-db Dead band	-19.99 to 99.99	%FS	0.00	At heating and cooling control	
	oF-r Manual reset value	0.0 to 100.0	%	50.0		
	HYS Hysteresis (heat)	0.01 to 99.99	%FS	0.10		
	[HYS Hysteresis (cool)	0.01 to 99.99	%FS	0.10	At heating and cooling control	
	[P Control period (heat)	1 to 99	sec	20		
	[-[P Control period (cool)	1 to 99	sec	20	At heating and cooling control	
	[t Heater current monitor		A			
Hb Heater burnout	0.0 to 50.0	A	0.0	Heater burnout detection		
Level 2	r-L Remote/Local	RMT/LCL	None	LCL		
	SPnd SP mode	RSP/LSP	None	LSP		
	SPrU SP ramp time unit	M (Minutes)/H (Hours)	None	M		
	SPrt SP ramp set value	0 to 9999	EU	0		
	LbR LBA detection time	0 to 9999	sec	0		
	nu-S MV at stop	-5.0 to 105.0 *1	%	0.0		
	nu-E MV at PV error	-5.0 to 105.0 *1	%	0.0		
	oL-H MV upper limit	MV lower limit + 0.1 to 105.0 *2	%	105.0		
	oL-L MV lower limit	-5.0 to MV upper limit -0.1 *3	%	-5.0		
	oRL MV change rate limit	0.0 to 100.0	%/sec	0.0		
	[nF Input digital filter	0 to 9999	sec	0		
	ALH1 Alarm 1 hysteresis	0.01 to 99.99	%	0.02		
	ALH2 Alarm 2 hysteresis	0.01 to 99.99	%	0.02		
	ALH3 Alarm 3 hysteresis	0.01 to 99.99	%	0.02		
	[nSH Input shift upper limit	-199.9 to 999.9	°C/°F	0.0	Temperature input	
[nSL Input shift lower limit	-199.9 to 999.9	°C/°F	0.0	Temperature input		

*1 During heat and cooling control, the lower limit becomes -105.0%.

*2 During heat and cooling control, the setting range becomes 0.0 to 105.0%.

*3 During heat and cooling control, the setting range becomes -105.0 to 0.0%.

SETTING AND MONITORING PARAMETER LIST

Mode	Parameter Name	Setting Range	Unit	Default	Remarks	Setting
Setup	IN-T Input type	0 to 22	None	2		
	IN-H Scaling upper limit	Scaling lower limit +1 to 9999 *4	None	100	Analog input	
	IN-L Scaling lower limit	-1999 to Scaling upper limit -1 *4	None	0	Analog input	
	dP Decimal point	0 to 3	None	0	Analog input	
	d-U °C/°F selection	C/F	None	C	Temperature input	
	INIT Parameter initialize	YES/NO	None	NO		
	OUT1 Control output 1 assignment	HEAT/COOL/AL-1 to AL-3/HBA/LBA	None	HEAT		
	OUT2 Control output 2 assignment	HEAT/COOL/AL-1 to AL-3/HBA/LBA	None	AL-1		
	SUB1 Auxiliary output 1 assignment	AL-1 to AL-3/HBA/LBA/S.ERR/ E333/RSER	None	AL-2		
	SUB2 Auxiliary output 2 assignment	AL-1 to AL-3/HBA/LBA/S.ERR/ E333/RSER	None	AL-3		
	AL1T Alarm 1 type	1 to 11	None	2	Output assignment needed	
	AL1n Alarm 1 open in alarm	N-O/N-C	None	N-O	Output assignment needed	
	AL2T Alarm 2 type	1 to 11	None	2	Output assignment needed	
	AL2n Alarm 2 open in alarm	N-O/N-C	None	N-O	Output assignment needed	
	AL3T Alarm 3 type	1 to 11	None	2	Output assignment needed	
	AL3n Alarm 3 open in alarm	N-O/N-C	None	N-O	Output assignment needed	
OR-EU Direct/Reverse operation	OR-R/OR-D	None	OR-R			
Expansion	SL-H SP setting upper limit	SP setting lower limit +1 to scaling upper limit	EU	1300	*4	
	SL-L SP setting lower limit	Scaling lower limit to SP setting upper limit -1	EU	-200	*4	
	ENTL PID/ON/OFF	PID/ON/OFF	None	PID		
	ALFA α	0.00 to 1.00	None	0.65		
	AT-G AT calculated gain	0.1 to 10.0	None	1.0		
	rEST Standby sequence reset setting method	0/1	None	0		
	rEt Automatic return of display mode	0 to 99	sec	0		
	AT-H AT hysteresis	0.1 to 9.9	%FS	0.2		
LbAb LBA detection width	0.0 to 999.9	%FS	0.2			

*4 When temperature input is selected, the sensor range selected in the “input type” parameter (setup mode) corresponds to the scaling upper and lower limit value.

Mode	Parameter Name	Setting Range	Unit	Default	Remarks	Setting
Option	<i>bP5</i> Baud rate	125/250/500	kbps	125		
	<i>nAdr</i> Node address	0 to 63	None	0		
	<i>dFnt</i> Communication data format	BIN/BCD	None	BIN		
	<i>ConE</i> Operation at communication error	CON/STOP	None	CON		
	<i>rd1</i> Read data assignment 1	1 to 40/NON *5	None	1		
	<i>rd2</i> Read data assignment 2	1 to 40/NON *5	None	3		
	<i>rd3</i> Read data assignment 3	1 to 40/NON *5	None	37		
	<i>rd4</i> Read data assignment 4	1 to 40/NON *5	None	NON		
	<i>rd5</i> Read data assignment 5	1 to 40/NON *5	None	NON		
	<i>rd6</i> Read data assignment 6	1 to 40/NON *5	None	NON		
	<i>rd7</i> Read data assignment 7	1 to 40/NON *5	None	NON		
	<i>rd8</i> Read data assignment 8	1 to 40/NON *5	None	NON		
	<i>rd9</i> Read data assignment 9	1 to 40/NON *5	None	NON		
	<i>rd10</i> Read data assignment 10	1 to 40/NON *5	None	NON		
	<i>rd11</i> Read data assignment 11	1 to 40/NON *5	None	NON		
	<i>rd12</i> Read data assignment 12	1 to 40/NON *5	None	NON		
	<i>rd13</i> Read data assignment 13	1 to 40/NON *5	None	NON		
	<i>rd14</i> Read data assignment 14	1 to 40/NON *5	None	NON		
	<i>rd15</i> Read data assignment 15	1 to 40/NON *5	None	NON		
	<i>rd16</i> Read data assignment 16	1 to 40/NON *5	None	NON		
	<i>wd1</i> Write data assignment 1	1 to 40/NON *5	None	6		
	<i>wd2</i> Write data assignment 2	1 to 40/NON *5	None	7		
	<i>wd3</i> Write data assignment 3	1 to 40/NON *5	None	8		
	<i>wd4</i> Write data assignment 4	1 to 40/NON *5	None	36		
	<i>wd5</i> Write data assignment 5	1 to 40/NON *5	None	NON		
	<i>wd6</i> Write data assignment 6	1 to 40/NON *5	None	NON		
	<i>wd7</i> Write data assignment 7	1 to 40/NON *5	None	NON		
	<i>wd8</i> Write data assignment 8	1 to 40/NON *5	None	NON		
	<i>wd9</i> Write data assignment 9	1 to 40/NON *5	None	NON		
	<i>wd10</i> Write data assignment 10	1 to 40/NON *5	None	NON		
	<i>wd11</i> Write data assignment 11	1 to 40/NON *5	None	NON		
	<i>wd12</i> Write data assignment 12	1 to 40/NON *5	None	NON		
	<i>wd13</i> Write data assignment 13	1 to 40/NON *5	None	NON		
	<i>wd14</i> Write data assignment 14	1 to 40/NON *5	None	NON		
	<i>wd15</i> Write data assignment 15	1 to 40/NON *5	None	NON		
	<i>wd16</i> Write data assignment 16	1 to 40/NON *5	None	NON		
	<i>HbL</i> HBA latch	ON/OFF	None	OFF		
	<i>rSPU</i> Remote SP enable	ON/OFF	None	OFF		
	<i>rSPH</i> Remote SP upper limit	SP setting lower limit to SP setting upper limit	EU	1300		
	<i>rSPL</i> Remote SP lower limit	SP setting lower limit to SP setting upper limit	EU	-200		
<i>SPtr</i> SP tracking	ON/OFF	None	OFF			

*5 For details on the correspondence between set values 1 to 40 and data types, see 6.4 Data Assignments/Data Type List (page 6-9).

PARAMETER OPERATIONS LIST

- Switching to modes other than manual or protect mode is carried out by mode selection in the menu display.
- The figure below shows all parameters in the order that they are displayed. Some parameters are not displayed depending on the protect mode setting and conditions of use.

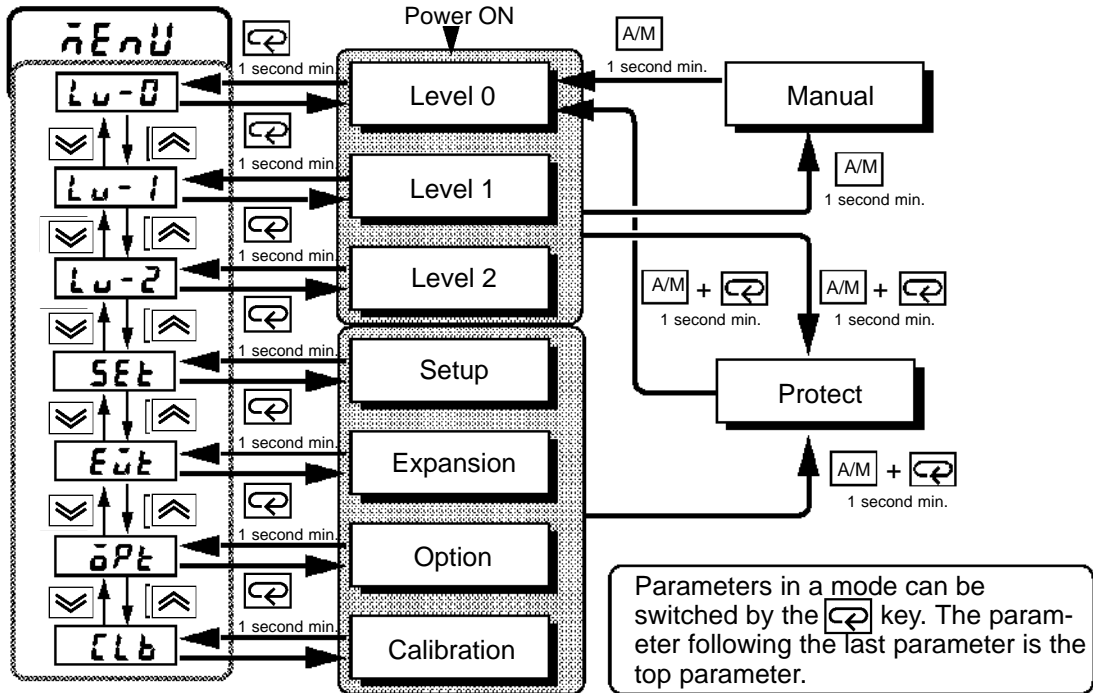

Level 0

- PV/SP
- Remote SP monitor
- Set point during SP ramp
- MV monitor (heat)
- MV monitor (cool)
- Run/Stop

Manual

- Manual MV

Protect

- Security
- [A/M] key protect

Level 1

- AT Execute/Cancel
- Alarm value 1
- Alarm value 2
- Alarm value 3
- Proportional band
- Integral time
- Derivative time
- Cooling coefficient
- Dead band
- Manual reset value
- Hysteresis (heat)
- Hysteresis (cool)
- Control period (heat)
- Control period (cool)
- Heater current monitor
- Heater burnout

Level 2

- Remote/Local
- SP mode
- SP ramp time unit
- SP ramp set value
- LBA detection time
- MV at stop
- MV at PV error
- MV upper limit
- MV lower limit
- MV change rate limit
- Input digital filter
- Alarm 1 hysteresis
- Alarm 2 hysteresis
- Alarm 3 hysteresis
- Input shift upper limit
- Input shift lower limit

Setup

in-t Input type
in-H Scaling upper limit
in-L Scaling lower limit
dP Decimal point
d-U °C/°F selection
inIt Parameter initialize
out 1 Control output 1 assignment
out 2 Control output 2 assignment
Sub 1 Auxiliary output 1 assignment
Sub 2 Auxiliary output 2 assignment
ALt 1 Alarm 1 type
AL in Alarm 1 open in alarm
ALt 2 Alarm 2 type
AL 2n Alarm 2 open in alarm
ALt 3 Alarm 3 type
AL 3n Alarm 3 open in alarm
orEw Direct/Reverse operation

Expansion

SL-H SP setting upper limit
SL-L SP setting lower limit
EntL PID/ON/OFF
ALFA α
At-G AT calculated gain
rEst Standby sequence reset method
rEt Automatic return of display mode
At-H AT hysteresis
LbAb LBA detection width

Option

bPS Baud rate
nAdr Node address
dFAE Communication data format
CoNE Operation at communication error
rd 1 Read data assignment 1
 |
 to
rd 16 Read data assignment 16
yd 1 Write data assignment 1
 |
 to
yd 16 Write data assignment 16
HbL HBA latch
rSPU Remote SP enable
rSPH Remote SP upper limit
rSPL Remote SP lower limit
SPt r SP tracking enable

Calibration mode

See Chapter 7 Calibration, 7.1 Structure of Parameters.

USING THE E5EK-DRT IN MULTI-VENDOR APPLICATIONS

Connecting to Another Vendor’s Master

Before you connect the E5EK-DRT to a master made by another vendor, fully understand the specifications in this manual and the device profile.

Connecting to Another Vendor’s Configurator

Before you use another vendor’s configurator, we recommend making full use of the E5EK-DRT’s file containing the parameters and operation information of the slaves.

Create the EDS file referring to the device profile described in this manual. For details on how to create EDS files, refer to the manual of the configurator you are using.

+ Slave Device Protocol

General data	Compatible DeviceNet Specifications	Volume I - Release 1.3 Volume II - Release 1.2	
	Vender name	OMRON Corporation	Header ID = 47
	Device protocol name	Slaves: Generic	Protocol number = 0
	Manufacturer catalog number	Manual number (H099)	
	Manufacturer revision	1.0	
Physical conformance data	Network current consumption	30mA max. (24VDC)	
	Connector type	Open hard wired	
	Physical insulation	Yes	
	Supported indicators	Module, Network	
	MAC ID setting	Soft setting	
	Default MAC ID	0	
	Baud rate setting	Soft setting	
	Supported baud rates	125 kbps, 250 kbps, and 500 kbps	
Communications data	Predefined Master/Slave connection set	Group 2 only server	
	Dynamic connection support (UCMM)	No	
	Explicit message fragmentation support	Yes	

+ **Object Mounting**

' **Identity Object (0x01)**

Object class	Attribute	Not supported
	Service	Not supported

Object instance	Attribute	ID Content	Get (read)	Set (write)	Value
		1	Vendor	Yes	No
2	Product type	Yes	No	0	
3	Product code	Yes	No	307	
4	Revision	Yes	No	1.3	
5	Status (bits supported)	Yes	No	Bit 0 only	
6	Serial number	Yes	No	Unique for each Unit	
7	Product name	Yes	No	E5EK-AA2-DRT	
8	State	No	No	---	
		DeviceNet service			
	Service	05	Reset		
		0E	Get_Attribute_Single		

' **Message Router Object (0x02)**

Object class	Attribute	Not supported
	Service	Not supported
Object instance	Attribute	Not supported
	Service	Not supported

' **DeviceNet Object (0x03)**

Object class		ID Content	Get (read)	Set (write)
	Attribute	1 Revision	Yes	No
	Service	Not supported		

Item	Section	ID Content	Get (read)	Set (write)	Value	
Object instance	Attribute	1	MAC ID	Yes	No	---
		2	Baud rate	Yes	No	---
		3	BOI	Yes	No	00 (hexadecimal)
		4	Bus Off counter	No	No	---
		5	Allocation information	Yes	No	---
		6	MAC ID switch changed	No	No	---
		7	Baud rate switch changed	No	No	---
		8	MAC ID switch value	No	No	---
		9	Baud rate switch value	No	No	---
	Service	DeviceNet service		Paramater Option		
0E		Get_Attribute_Single	No			
4B		Allocate_Master / Slave_Connection_Set	No			
4C		Release_Master / Slave_Connection_Set	No			

‘ **Assembly Objects (0x04)**

Object class	Attribute	Not supported
	Service	Not supported

Object instance	Attribute	ID Content	Get (read)	Set (write)
		3 Data	Yes	Yes
	Service	DeviceNet service	Parameter options	
		0E Get Attribute_Single	No	
		10 Get Attribute_Single	No	

‘ **Connection Object (0x05)**

Object class	Attribute	Not supported
	Service	Not supported
	Max. number of active connections	1

Item	Section	Information	Max. number of interfaces		
Object instance 1	Instance type	Explicit Message	1		
	Production trigger	Cyclic	---		
	Transport type	Server	---		
	Transport class	3	---		
	Attribute	ID Content	Get (read)	Set (write)	Value
		1 State	Yes	No	---
		2 Instance type	Yes	No	01 (hexadecimal)
		3 Transport class trigger	Yes	No	83 (hexadecimal)
		4 Produced connection ID	Yes	No	---
		5 Consumed connection ID	Yes	No	---
		6 Initial comm. characteristics	Yes	No	21 (hexadecimal)
		7 Produced connection size	Yes	No	37 (hexadecimal)
		8 Consumed connection size	Yes	No	37 (hexadecimal)
		9 Expected packet rate	Yes	Yes	---
		12 Watchdog time-out action	Yes	No	01
		13 Produced connection path length	Yes	No	00
		14 Produced connection path	Yes	No	---
		15 Consumed connection path length	Yes	No	00
		16 Consumed connection path	Yes	No	---
		17 Production_inhibit_time	Yes	No	---
Service		DeviceNet service	Parameter option		
	05 Reset	No			
	0E Get_Attribute_Single	No			
	10 Set_Attribute_Single	No			

Item	Section	Information	Max. number of instances			
Object instance 2	Instance type	Polled I/O	1			
	Production trigger	Cyclic	---			
	Transport type	Server	---			
	Transport class	2	---			
	Attribute	ID	Content	Get (read)	Set (write)	Value
		1	State	Yes	No	---
		2	Instance type	Yes	No	01 (hexadecimal)
		3	Transport class trigger	Yes	No	82 (hexadecimal)
		4	Produced connection ID	Yes	No	---
		5	Consumed connection ID	Yes	No	---
		6	Initial comm. characteristics	Yes	No	01 (hexadecimal)
		7	Produced connection size	Yes	No	*1
		8	Consumed connection size	Yes	No	*1
		9	Expected packet rate	Yes	Yes	---
		12	Watchdog time-out action	Yes	No	00
		13	Produced connection path length	Yes	No	06
		14	Produced connection path	Yes	No	24_04_24_01_30_03
		15	Consumed connection path length	Yes	No	06
		16	Consumed connection path	Yes	No	24_04_24_01_30_03
		17	Production_inhibit_time	Yes	No	---
Service		DeviceNet service		Parameter option		
	05	Reset	No			
	0E	Get_Attribute_Single	No			
	10	Set_Attribute_Single	No			

Item	Section	Information	Max. number of instances			
Object instance 3	Instance type	Bit strobed I/O	1			
	Production trigger	Cyclic	---			
	Transport type	Server	---			
	Transport class	2	---			
	Attribute	ID	Content	Get (read)	Set (write)	Value
		1	State	Yes	No	---
		2	Instance type	Yes	No	01 (hexadecimal)
		3	Transport class trigger	Yes	No	82 (hexadecimal)
		4	Produced connection ID	Yes	No	---
		5	Consumed connection ID	Yes	No	---
		6	Initial comm. characteristics	Yes	No	01 (hexadecimal)
		7	Produced connection size	Yes	No	*1
		8	Consumed connection size	Yes	No	0100H
		9	Expected packet rate	Yes	Yes	---
		12	Watchdog time-out action	Yes	No	00
		13	Produced connection path length	Yes	No	06
		14	Produced connection path	Yes	No	24_04_24_01_30_03
		15	Consumed connection path length	Yes	No	06
		16	Consumed connection path	Yes	No	24_04_24_01_30_03
		17	Production_inhibit_time	Yes	No	---
Service		DeviceNet service		Parameter option		
	05	Reset	No			
	0E	Get_Attribute_Single	No			
	10	Set_Attribute_Single	No			

*1 The connection sizes depend on the setting of E5EK-DRT : 00 to 20 (hexadecimal)

Vendor-specific Objects (0x94)

Object class	Attribute	Not supported
	Service	Not supported

Object instance	Attribute	ID	Content	Get (read)	Set (write)
		100	Set point	Yes	Yes
		101	Alarm value 1	Yes	Yes
		102	Alarm value 2	Yes	Yes
		103	Alarm value 3	Yes	Yes
		104	Proportional band	Yes	Yes
		105	Integral time	Yes	Yes
		106	Derivative time	Yes	Yes
		107	Cooling coefficient	Yes	Yes
		108	Dead band	Yes	Yes
		109	Manual reset value	Yes	Yes
		110	Hysteresis (heat)	Yes	Yes
		111	Hysteresis (cool)	Yes	Yes
		112	Control period (heat)	Yes	Yes
		113	Control period (cool)	Yes	Yes
		114	Heater current monitor	Yes	Yes
		115	SP ramp time unit	Yes	Yes
		116	SP ramp set value	Yes	Yes
		117	LBA detection time	Yes	Yes
		118	MV at stop	Yes	Yes
		119	MV at PV error	Yes	Yes
		120	MV upper limit	Yes	Yes
		121	MV lower limit	Yes	Yes
		122	MV change rate limit	Yes	Yes
		123	Input digital filter	Yes	Yes
		124	Alarm 1 hysteresis	Yes	Yes
		125	Alarm 2 hysteresis	Yes	Yes
		126	Alarm 3 hysteresis	Yes	Yes
		127	Input shift upper limit	Yes	Yes
		128	Input shift lower limit	Yes	Yes
		129	Input type	Yes	Yes
		130	Scaling upper limit	Yes	Yes
		131	Scaling lower limit	Yes	Yes
		132	Decimal point	Yes	Yes
		133	°C/°F selection	Yes	Yes
		134	Control output 1 assignment	Yes	Yes
		135	Control output 2 assignment	Yes	Yes
		136	Auxiliary output 1 assignment	Yes	Yes
		137	Auxiliary output 2 assignment	Yes	Yes
		138	Alarm 1 type	Yes	Yes
		139	Alarm 1 open in alarm	Yes	Yes
		140	Alarm 2 type	Yes	Yes
		141	Alarm 2 open in alarm	Yes	Yes
		142	Alarm 3 type	Yes	Yes
		143	Alarm 3 open in alarm	Yes	Yes
		144	Direct/Reverse operation	Yes	Yes
		145	SP setting upper limit	Yes	Yes
		146	SP setting lower limit	Yes	Yes
		147	PID/ON/OFF	Yes	Yes
		148	α	Yes	Yes
		149	AT calculation gain	Yes	Yes
		150	Standby sequence reset method	Yes	Yes
		151	Automatic return of display mode	Yes	Yes

Object instance	Attribute	ID	Content	Get (read)	Set (write)
		152	AT hysteresis	Yes	Yes
153	LBA detection width	Yes	Yes		
154	HBA latch	Yes	Yes		
155	Remote SP enable	Yes	Yes		
156	Remote SP upper limit	Yes	Yes		
157	Remote SP lower limit	Yes	Yes		
158	SP tracking	Yes	Yes		
159	Status A	Yes	No		
160	Status B	Yes	No		
161	Read data assignment 1	Yes	Yes		
162	Read data assignment 2	Yes	Yes		
163	Read data assignment 3	Yes	Yes		
164	Read data assignment 4	Yes	Yes		
165	Read data assignment 5	Yes	Yes		
166	Read data assignment 6	Yes	Yes		
167	Read data assignment 7	Yes	Yes		
168	Read data assignment 8	Yes	Yes		
169	Read data assignment 9	Yes	Yes		
170	Read data assignment 10	Yes	Yes		
171	Read data assignment 11	Yes	Yes		
172	Read data assignment 12	Yes	Yes		
173	Read data assignment 13	Yes	Yes		
174	Read data assignment 14	Yes	Yes		
175	Read data assignment 15	Yes	Yes		
176	Read data assignment 16	Yes	Yes		
177	Write data assignment 1	Yes	Yes		
178	Write data assignment 2	Yes	Yes		
179	Write data assignment 3	Yes	Yes		
180	Write data assignment 4	Yes	Yes		
181	Write data assignment 5	Yes	Yes		
182	Write data assignment 6	Yes	Yes		
183	Write data assignment 7	Yes	Yes		
184	Write data assignment 8	Yes	Yes		
185	Write data assignment 9	Yes	Yes		
186	Write data assignment 10	Yes	Yes		
187	Write data assignment 11	Yes	Yes		
188	Write data assignment 12	Yes	Yes		
189	Write data assignment 13	Yes	Yes		
190	Write data assignment 14	Yes	Yes		
191	Write data assignment 15	Yes	Yes		
192	Write data assignment 16	Yes	Yes		
193	Communication data format	Yes	Yes		
194	Operation at Communication error	Yes	Yes		
Service	DeviceNet service			Parameter option	
	0E Get_Attribute_Single			None	
	10 Set_Attribute_Single			None	

Symbols

[A/M] key protect, 5-4
°C/°F selection, 5-27

Numbers

100%AT, 3-17
40%AT, 3-17

A

A/D converter error, 8-3 , 8-5
A/M key, 1-3
A/M key protect, 3-13
About Calibration, 1-10
ABOUT CURRENT TRANSFORMER (CT), A-5
About parameter display, 5-2
About PID Parameters, 3-18
About the Communications Function for the CompoBus/D (DeviceNet) Network, 1-9
About the Decimal Point of the Alarm Value, 3-12
About the displays, 1-3
About the Order In Which Parameters Are Listed, 5-2
About the power blocks, 2-9
About Writing Communication Data, 6-2
Adjusting Control Operation, 3-15
Alarm 1 hysteresis, 5-22
Alarm 1 open in alarm, 5-30
Alarm 1 type, 5-29
Alarm 2 hysteresis, 5-22
Alarm 2 open in alarm, 5-30
Alarm 2 type, 5-29
Alarm 3 hysteresis, 5-22
Alarm 3 open in alarm, 5-30
Alarm 3 type, 5-29
Alarm hysteresis, 3-11
Alarm type, 3-10
Alarm value, 3-10
Alarm value 1, 5-11
Alarm value 2, 5-11
Alarm value 3, 5-11
Alfa, 5-33
Analog input, 3-5
Assembly Objects (0x04), A-15
AT calculated gain, 5-33
AT Execute/Cancel, 5-11
AT hysteresis, 5-35
Auto-tuning (A.T.), 3-17
Auto-turning key, 1-3
Automatic return of display mode, 5-34
Auxiliary output, 2-8
Auxiliary output 1 assignment, 5-28
Auxiliary output 2 assignment, 5-28

B

Balance-less, Bump-less Operation, 3-15
Basic Operation Flow, 3-2
Baud rate, 5-37 , 6-6
Before setup, 2-3

C

Calibrating Current Input, 7-9
Calibrating inputs, 1-10
Calibrating Platinum Resistance Thermometers, 7-7
Calibrating Thermocouple, 7-4
Calibrating Voltage Input, 7-10
Calibration, 7-9
Calibration : 0 to 10VDC, 7-11
Calibration data error, 8-4
Calibration item menu, 7-3
Calibration Mode, 1-7 , 5-42
Calibration save mark, 7-3
Calibration: 0 to 5 VDC, 1 to 5 VDC, 7-10
Calibration: platinum resistance thermometer 1, 7-7
Calibration: platinum resistance thermometer 2, 7-8
Calibration: thermocouple 1, 7-5
Calibration: thermocouple 2, 7-6
Changing the set point, 3-15
Characteristics, A-3
Checking Indication Accuracy, 7-12
Checking Operation Restrictions, 8-6
Close in alarm/open in alarm, 3-11
Communication data format, 5-37
Communication error status, 6-12
Communications, 2-9
Communications defaults, 6-2
Communications error, 8-4
Communications Specifications, A-2
Connecting the Cold Junction Compensator, 7-4
Connection Object (0x05), A-15
CONTROL BLOCK DIAGRAM, A-6
Control output, 2-8
Control output 1 assignment, 5-27
Control output 2 assignment, 5-27
Control period, 3-8
Control period (cool), 5-15
Control period (heat), 5-15
Convention Used in this Chapter, 3-2
Conventions Used in this Chapter, 5-2
Cooling coefficient, 4-2 , 5-12
CT input, 1-4 , 2-9
Current input, 1-4 , 7-13

D

Data Assignments, 6-8
Data assignments, 6-2
Data format, 6-9
Data Structure, 6-10

Data Timing, 6-13
 Data type list, 6-9
 Data write processing time, 6-5
 Data writing processing time, 6-5
 Dead band, 4-2 , 5-13
 Decimal point, 5-26
 Derivative time, 5-12
 Determining the LBA detection time, 4-12
 DeviceNet Object (0x03), A-14
 Differences from General-purpose Models, 1-6
 Dimensions, 2-4 , A-5
 Direct/Reverse operation, 3-8 , 5-30
 Display range over, 8-4
 Down key, 1-3
 Draw-out, 2-2

E

E5EK-DRT Internal Processing Times, 6-5
 Example of actual calculation, 6-5
 Examples of use, 4-10
 Executing operation instructions, 6-13
 Expansion Mode, 1-6 , 1-7 , 5-31

F

Fixing Screw for Front Panel, 2-2
 Fixing settings, 1-8
 Flow of Communications Processing, 6-4
 Front panel, 1-2

H

HBA latch, 5-39
 HBA latch/release, 4-9
 Heater burnout, 5-16
 Heater Burnout Alarm, A-3
 Heater burnout detection, 4-9
 Heater current monitor, 5-15
 Heating and cooling control, 4-2
 How to assign data, 6-8
 How to calculate the heater burnout set value, 4-10
 How to Use Error Output, 8-5
 How to use keys, 1-3
 How to Use the Error Display, 8-3
 How to Use the Heater Burnout Alarm, 4-9
 How to Use the Remote SP, 4-7
 Hysteresis, 4-3
 Hysteresis (cool), 5-14
 Hysteresis (heat), 5-14

I

Identity Object (0x01), A-14
 Initial Checks, 8-2
 Input and Output, 1-4
 Input digital filter, 5-22
 Input error, 8-3
 Input errors, 8-5

Input shift lower limit, 5-23
 Input shift upper limit, 5-23
 Input type, 3-4 , 5-25
 Installation, 2-4
 Integral time, 5-12

L

LBA, 4-11 , 8-5
 LBA detection example, 4-11
 LBA detection time, 4-11 , 5-20
 LBA detection width, 4-11 , 5-35
 Level 0 Mode, 1-6 , 1-7 , 5-6
 Level 1 Mode, 1-6 , 1-7 , 5-10
 Level 2 Mode, 1-6 , 1-7 , 5-17
 Limiter operation conditions, 4-5

M

Main parts, 1-2
 Manipulated variable at stop, 3-14 , 4-2
 Manipulated variable restrictions, 4-4
 Manual Mode, 1-6 , 1-8 , 5-5
 Manual MV, 5-5
 Manual operation, 3-15
 Manual reset value, 5-13
 Memory error, 8-3
 Menu display, 1-7
 Message Router Object (0x02), A-14
 Mounting, 2-5
 MS/NS Indicator, 8-2
 MS/NS indicators, 1-3
 MV at PV error, 5-20
 MV at stop, 5-20
 MV change rate limit, 5-21
 MV change rate limiter, 4-4
 MV limiter, 4-4
 MV lower limit, 5-21
 MV monitor (cool), 5-9
 MV monitor (heat), 5-9
 MV upper limit, 5-21

N

Names of parts, 1-2
 No.1 display, 1-3
 No.2 display, 1-3
 Node address, 5-37 , 6-6

O

Object Mounting, A-14
 ON/OFF control, 4-3
 Operating Condition Restrictions, 4-4
 Operating conditions, 4-8 , 4-9
 Operation at communication error, 5-38 , 6-9
 Operation at start, 4-6
 Operation indicators, 1-3
 Operation instructions, 6-11
 Option Mode, 1-7 , 5-36
 Outline of CompoBus/D, 6-2

Output assignments, 1-5 , 3-7
Output Rating and Performance, A-4

P

Panel cutout, 2-4
Parameter initialize, 5-26
PARAMETER OPERATIONS LIST, A-11
Parameter types, 1-6
Parameters, 6-10
Parameters and Menus, 1-6
PID / ON/OFF, 5-32
Platinum resistance thermometer, 7-12
Power supply, 2-7
Precautions when wiring, 2-7
Preparation, 7-7 , 7-9 , 7-10
Preparations, 7-4
Procedure, 2-3
Proportional band, 5-12
Protect Mode, 1-6 , 1-8 , 3-13 , 5-3
PV/SP, 5-7

R

Ratings, A-2
Read data assignment 1 to 16, 5-38
Registering calibration data, 1-10
Relationship with set point limiter, 4-7
Remote I/O communications, 6-3
Remote SP enable, 5-39
Remote SP input, 1-4 , 2-9
Remote SP input error, 8-5
Remote SP lower limit, 5-40
Remote SP monitor, 4-8 , 5-8
Remote SP upper limit, 5-40
Remote/Local, 5-18
Restrictions during SP ramp, 4-6
Run/Stop, 5-9

S

Sample Ladder, 6-14
Scaling, 4-7
Scaling lower limit, 5-26
Scaling upper limit, 5-26
Security, 3-13 , 5-3
Selecting modes, 1-7
Selecting parameters, 1-8
Selecting the Control Method, 4-2
Sensor input, 2-8
Set point during SP ramp, 5-8
Set point limiter, 4-5
Setting Alarm Type, 3-10
Setting and Monitoring Parameter List, A-7
Setting enabled channels, 6-8
Setting example when two E5EK-DRTs are used, 6-7
Setting Input Specifications, 3-4

Setting Output Specifications, 3-7
Setting range and Indication range of Sensor input, A-4
Setting reserved channels, 6-8
Setting the Communications Conditions, 6-6
Setting the LBA detection time, 4-12
Setting up, 2-2
Setting up the output unit, 2-3
Setting up the terminal covers, 2-6
Setup, 3-3
Setup Conditions, 6-14
Setup conditions, 6-8
Setup Mode, 1-6 , 1-7 , 5-24
Slave Device Protocol, A-13
SP mode, 4-7 , 5-18
SP ramp, 4-5
SP ramp set value, 5-19
SP ramp time unit, 5-19
SP setting lower limit, 5-32
SP setting upper limit, 5-32
SP tracking, 4-8
SP tracking enable, 5-41
SPECIFICATIONS, A-2
Specifications, A-5
Standby sequence, 3-11
Standby sequence reset method, 5-34
Starting and Stopping Operation, 3-14
Status A, 6-12
Status B, 6-12
Structure of Parameters, 7-2
Summary of alarm operations, 3-11
Switching with Manual operation, 4-2

T

Temperature input, 1-4 , 3-5
Temperature input shift, 3-5
Temperature unit, 3-5
Terminal arrangement, 2-7
The meaning of icons used in this chapter, 5-2
Thermocouple, 7-12

U

Up key, 1-3
Using the E5EK-DRT in Multi-vendor Applications, A-13

V

Vendor-specific object processing time, 6-5
Vendor-specific Objects (0x94), A-17
Voltage input, 1-4 , 7-13

W

Wiring, 2-7
Wiring Terminals, 2-7
Write data assignment 1 to 16, 5-38
Writing parameters, 6-13