

F158 *for C200H WEIGHTING CONTROLLER MODULE*

OPERATION MANUAL

UNIPULSE

25 APR. 2005
REV. 1.02

Introduction

We appreciate your kind purchase of F158 WEIGHING CONTROLLER MODULE.

To take full advantage of high performance of F158, thoroughly read this operating manual first before use and understand the explanations contained herein for correct operating procedures.



CAUTION

F158 cannot be used on remote I/O slave.

TABLE OF CONTENTS

1 . Brief of Contents	1
2 . Electrical Connction	2
2 - 1 . Connecting loadcells	2
2 - 1 - 1 . Signals to / from lodacells	2
2 - 1 - 2 . Connecting loadcells in parallel	3
2 - 2 . Connecting cables to terminal board	5
3 . Data Format	6
3 - 1 . Relation between data format and Machine No.assignment	6
3 - 2 . I/O Area	11
3 - 2 - 1 . I/O Area map (Normal mode)	11
3 - 2 - 2 . I/O Area map (Bit operation mode)	12
3 - 3 . I/O Area modes	13
3 - 3 - 1 . Normal mode	13
3 - 3 - 2 . Bit Operation Mode	19
3 - 4 . Exclusive DM Area	22
3 - 4 - 1 . Setpoint Registratio Area	22
3 - 4 - 2 . Setpoint Display Area	23
4 . Calibration	24
4 - 1 . Introduction to calibration	24
4 - 2 . Calibration under actual load	25
4 - 3 . Operation of calibration under actual load	26
4 - 3 - 1 . Calibration LOCK Release	26
4 - 3 - 2 . Connecting console	27
4 - 3 - 3 . Selecting decimal point	28
4 - 3 - 4 . Setting allowable maximum weighing value (capacity)	29
4 - 3 - 5 . Setting minimum scale	30
4 - 3 - 6 . Setting counterweight weiht	31
4 - 3 - 7 . Zero Calibration	32
4 - 3 - 8 . Span Calibration	35
4 - 3 - 9 . Calibration LOCK	37
5 . Reading of Weight Value and Status	38
5 - 1 . Gross Weight, Net Weight and Tare Weight	38
5 - 2 . Operating setting remoto console unit	39
5 - 2 - 1 . Operating C110	39
5 - 2 - 2 . Operating C120	48

6 . Available Functions	57
6 - 1 . Tree chart of setting modes (Setting remote console unit)	57
6 - 2 . Description of individual functions	60
6 - 2 - 1 . Tare Subtraction	60
6 - 2 - 2 . Tare Subtraction Reset	60
6 - 2 - 3 . Digital Tare Subtraction	61
6 - 2 - 4 . Digital Zero	63
6 - 2 - 5 . Digital Reset	63
6 - 2 - 6 . Motion Detect	64
6 - 2 - 7 . Zero Tracking	66
6 - 2 - 8 . Gravitational Acceleration Correction	68
6 - 2 - 9 . Digital Filter	70
6 - 2 - 1 0 . Net Over	71
6 - 2 - 1 1 . Gross Over	72
6 - 2 - 1 2 . Feed / Discharge Control Mode	73
6 - 2 - 1 3 . Final / SP1 / SP2 / SP3 / Over-Weight / Under-Weight	74
6 - 2 - 1 4 . Upper Limit / Lower Limit / Near Zero	77
6 - 2 - 1 5 . Final & Under- and Over-Weight Comparison Weight / Upper andLower Limits Comparison Weight / Near Zero Comparison Weight	78
6 - 2 - 1 6 . Under- and Over -Weight Comparison Mode	80
6 - 2 - 1 7 . Comparison Inhibit Timer/Judging Timer/Completion Timer	81
6 - 2 - 1 8 . Completion Output Mode	84
6 - 2 - 1 9 . Automatic Fall / Automatic Fall Control Value / Automatic Fall Timer / Automatic Fall coefficient	85
7 . Timing Chart	89
7 - 1 . Reading setpoint (Address for Machine No.0 in C200H Series)	89
7 - 2 . Writing setpoint and operating instructions	90
7 - 3 . Bit operation (Tare Subtraction)	91
8 . Ladder Chart	92
9 . List of Console Settings	97
9 - 1 . List of available ranges for settings	101
1 0 . Error Code	104
1 1 . Dimensions	106
1 2 . Specifications	107

1. Brief Description of the System

◇ Front Panel

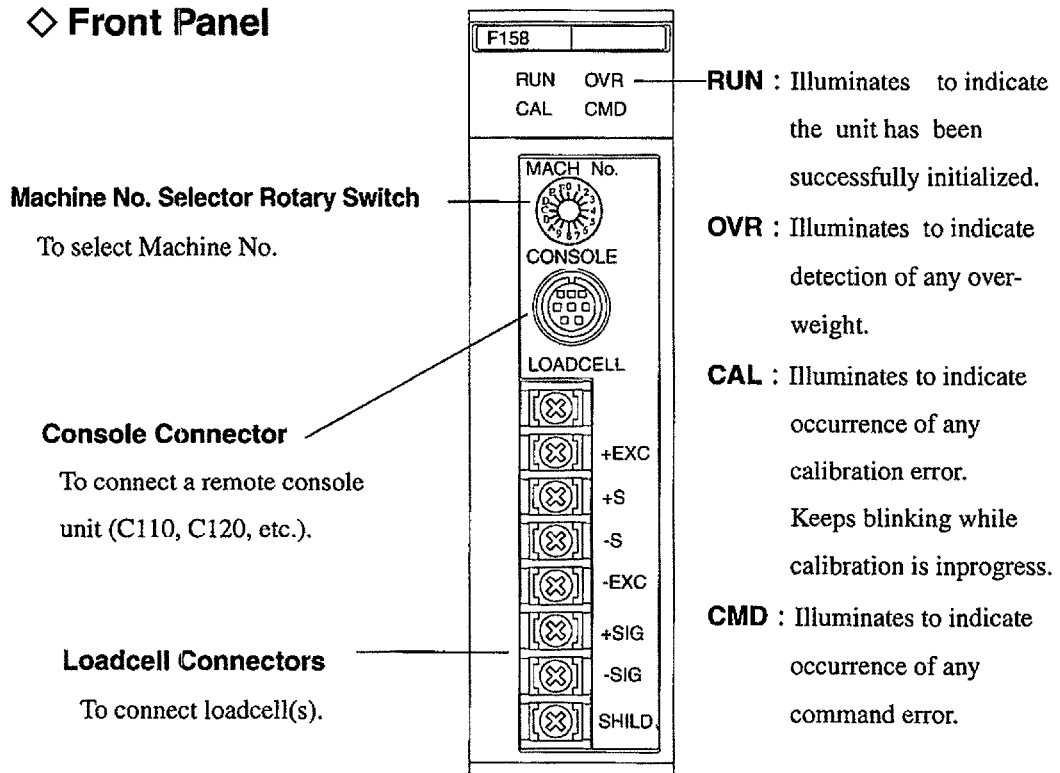

◇ Rear Panel

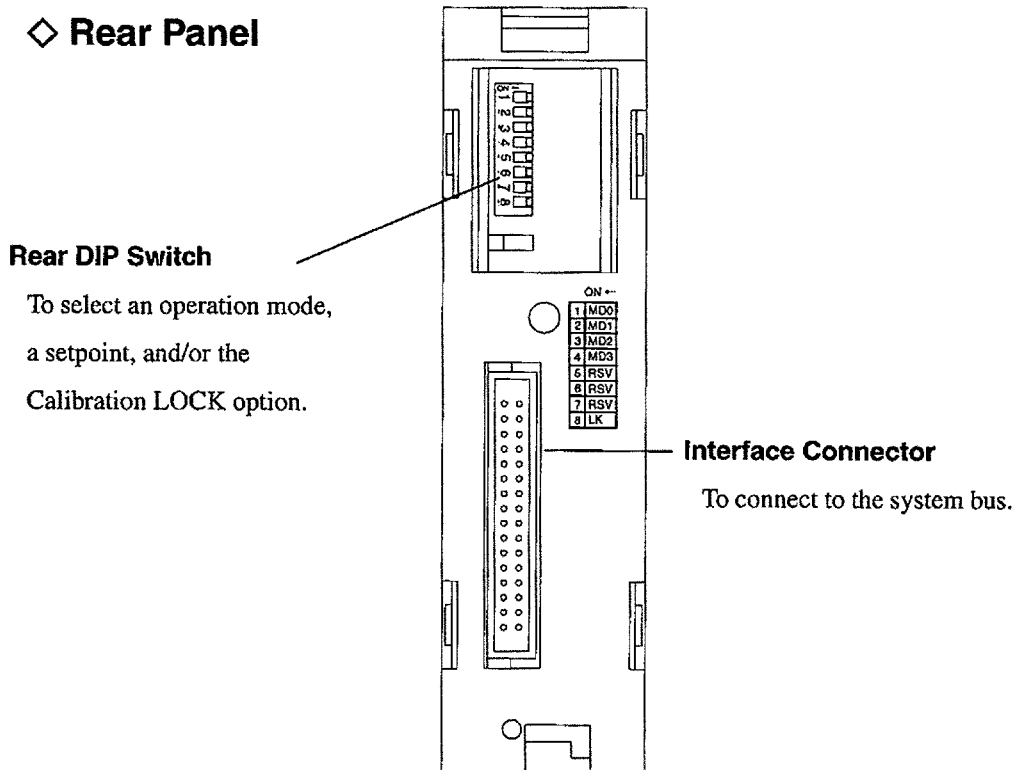

2. Electrical Connection

2-1. Connecting loadcells

Connect a loadcell to the corresponding Loadcell connector on F158.

F158	Loadcell Signal Name	
	6-Wire Type	4-Wire Type
+EXC	+EXC	+EXC
+S	+S	Connect to +EXC
-S	-S	Connect to -EXC
-EXC	-EXC	+EXC
SLD	SHIELD	SHIELD
+SIG	+SIG	+SIG
-SIG	-SIG	-SIG

2-1-1. Signals to/from loadcells

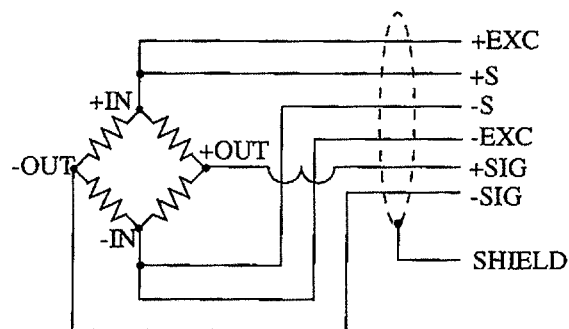

(The signals +S and -S are disabled for the 4-wire type.)

2-1-2. Connecting loadcells in parallel

In some industrial weighing machines, multiple loadcells may be connected in parallel to configure a hopper scale or a tank scale. Typical parallel connection of loadcells is shown in the diagram below.

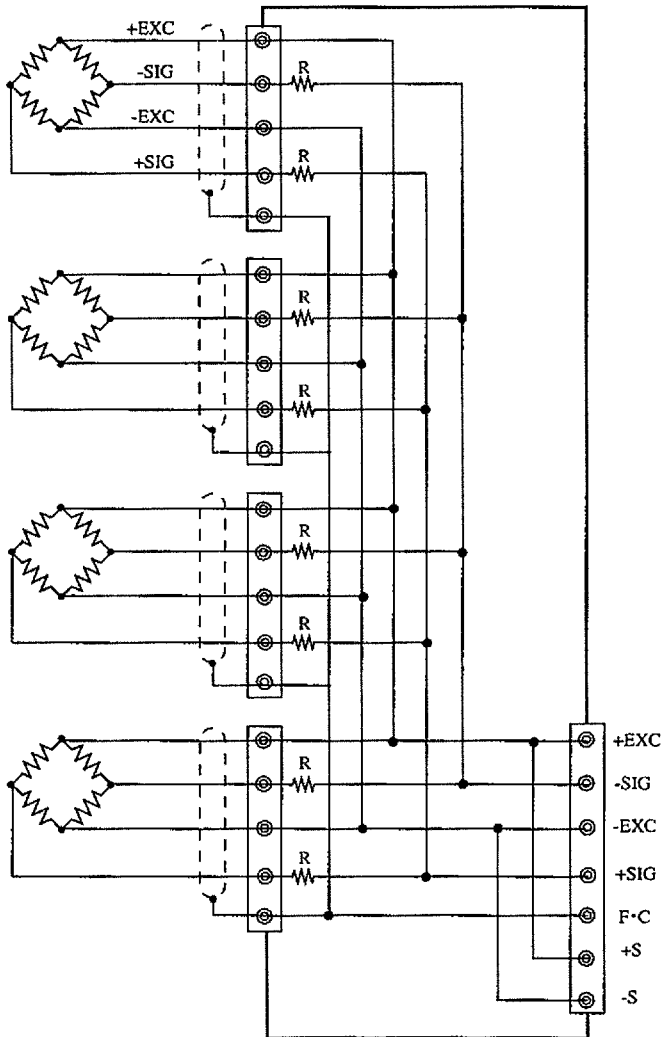

When viewed from this system, 'n' sets of loadcells connected in parallel to each other may be considered as a unit loadcell having a rated capacity 'n' times that of each connected loadcell and the same sensitivity as each loadcell. In this case, such an averaging resistance (R) is required that exhibits a resistance of 300 to 500 Ω , equal in relative ratio, and a higher temperature coefficient. When those loadcells designed for parallel connection are used, there is no need for incorporation of any averaging resistance.

 **CAUTION**

To configure the parallel connection, careful consideration should be given to the capacity of each loadcell with care that a sufficient allowance is provided for protection against possible overload due to any unbalanced load and/or impact.

 CAUTION

- * The F158 is designed to apply a voltage of 5 V to each connected loadcell. Then, do not connect such a loadcell having a maximum allowable applied voltage of 5 V or lower to prevent a risk of heat generation or failure.
- * When any 4-wire type loadcell is connected to F158, be sure to make connection between +EXC and +S, and -EXC and -S. Even if +S and -S is left unconnected, the system seemingly works properly, though the loadcell connected may be subjected to an excessive voltage, thereby causing a risk of heat generation or failure.

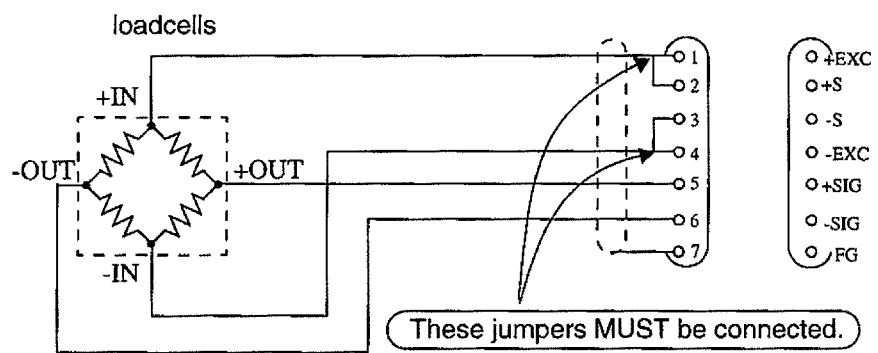

2-2. Connecting cables to terminal board

- ① Strip the sheath off from each connecting electric cable 5 to 6 mm in length at the connecting end, and then twist the conductor wires without any looseness.

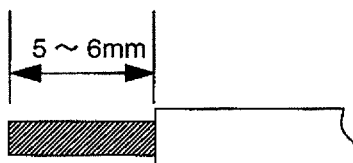

- ② Crimp the end of each electric cable with TMEV 1.25Y-3S or equivalent tool.



CAUTION

- * Be sure to use those electric cables having a section area of 0.2 to 2.5 mm² for connection.
- * To connect several electric cables, twist them together in advance.
- * To prevent malfunction, separate the system connection lines from any noise causing line or AC line.

3. Data Format

3-1. Relation between data format and Machine No. assignment

The F158 is assigned I/O Area to update weight values in CPU and DM Area to display and register setpoint values.

The starting address of I/O Area depends on Machine No. selected by the selector rotary switch on the front panel. For each machine, 10 channels (CH) are assigned as a dedicated area.

$(100 + 10 \times n)$ CH (n: Machine No.)

: For Machine Nos.0 through 9 (C200H Series)

$(400 + (n - 10) \times 10)$ CH : For Machine Nos.A through F (C200H Series)

$(2000 + 10 \times n)$ CH : (CS1 Series)

Example: For Machine No.0: 100 CH to 109 CH

Relation between Machine No. and I/O Area (C200H Series)

No.	I/O Area	No.	I/O Area
0	100CH ~ 109CH	8	180CH ~ 189CH
1	110CH ~ 119CH	9	190CH ~ 199CH
2	120CH ~ 129CH	A	400CH ~ 409CH
3	130CH ~ 139CH	B	410CH ~ 419CH
4	140CH ~ 149CH	C	420CH ~ 429CH
5	150CH ~ 159CH	D	430CH ~ 439CH
6	160CH ~ 169CH	E	440CH ~ 449CH
7	170CH ~ 179CH	F	450CH ~ 459CH

Relation between Machine No. and I/O Area (CS1 Series)

No.	I/O Area	No.	I/O Area
0	2000CH ~ 2009CH	8	2080CH ~ 2089CH
1	2010CH ~ 2019CH	9	2090CH ~ 2099CH
2	2020CH ~ 2029CH	A	2100CH ~ 2109CH
3	2030CH ~ 2039CH	B	2110CH ~ 2119CH
4	2040CH ~ 2049CH	C	2120CH ~ 2129CH
5	2050CH ~ 2059CH	D	2130CH ~ 2139CH
6	2060CH ~ 2069CH	E	2140CH ~ 2149CH
7	2070CH ~ 2079CH	F	2150CH ~ 2159CH

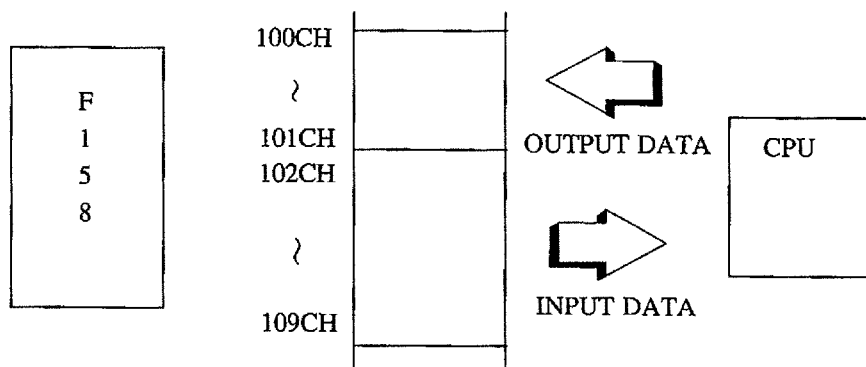

In addition to I/O Area, there is DM Area to display and register setpoint values. For display or registration of setpoint values, set the DIP switches MD0 and MD1 on the rear panel as follows.

Switch	Status	
MD0	ON	OFF
Operation	Enabled registration of settings in DM Area	Disabled registration of settings in DM Area

Switch	Status	
MD1	ON	OFF
Operation	Enabled display of settings in DM Area	Disabled display of settings in DM Area

Registration and display in DM Area are only available in the setting mode 0.

Addresses in DM Area are determined as follows.

DM Area is assigned a setpoint display area to display setpoint values in the F158 and a setpoint registration area to allow registration of data as setpoint.

Every address in this area must be 20 words, and the starting address may be set to any address determined based on Machine No.

Starting setpoint registration area: DM (1000 + 100 x n) (C200H Series)

Starting setpoint display area: DM (1000 + 100 x n + 1) (C200H Series)

(n: Machine No. to be registered in hexadecimal digits)

Starting setpoint registration area: DM (20000 + 100 x n) (CS1 Series)

Starting setpoint display area: DM (20000 + 100 x n + 1) (CS1 Series)

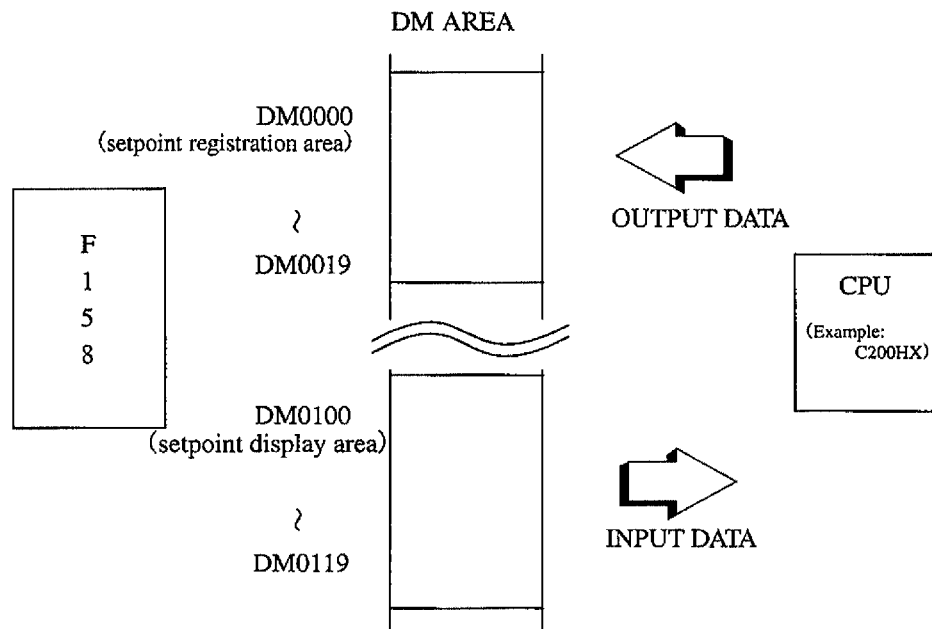

Example: For Machine No.0: 0000H is registered to DM1000
and 0100H is registered to DM1001 (C200H Series)

The two areas have a capacity of 20 words each as described above: then

- ◇ If values are registered across the areas (such as 0000H in DM1000 and 0010H in DM1001):
- ◇ If a value is registered in any inactive area (though depending on the type of PLC):

Relevant areas will be disabled for registration.

When the DIP SW setting is valid and the starting setpoint is a correct value, the bits "D in valid" and "D out valid" will be set ON.

(For the description in the bit operation mode, see Page 12 .)

- ◇ When it is unnecessary to view or register a setpoint:
- ◇ When it is necessary to prevent accidental changing of setpoint:

Set OFF the DIP switches MD0 and MD1.

Table : Available Starting Address Setting Range for Different PC Models

PC Model	Allowable Range for Starting Address	Allowable Range for Starting Address Registration Area (BCD)
C200H	DM0000 ~ DM0980	#0000 ~ #0980
C200HS SYSMAC α (C200HX C200HG C200HE)	※ DM0000 ~ DM6124	#0000 ~ #6124
CS1Series	DM00000 ~ DM06124	#0000 ~ #6124

※For C200HS and SYSMAC α , take care not to gain access to the high-performance I/O areas

Relation between Machine No. and Starting Address Registration Area (C200H Series)

No.	Starting Address Registration Area	No.	Starting Address Registration Area
0	DM1000, DM1001	8	DM1800, DM1801
1	DM1100, DM1101	9	DM1900, DM1901
2	DM1200, DM1201	A	DM2000, DM2001
3	DM1300, DM1301	B	DM2100, DM2101
4	DM1400, DM1401	C	DM2200, DM2201
5	DM1500, DM1501	D	DM2300, DM2301
6	DM1600, DM1601	E	DM2400, DM2401
7	DM1700, DM1701	F	DM2500, DM2501

Relation between Machine No. and Starting Address Registration Area (CS1 Series)

No.	Starting Address Registration Area	No.	Starting Address Registration Area
0	DM20000, DM20001	8	DM20800, DM20801
1	DM20100, DM20101	9	DM20900, DM20901
2	DM20200, DM20201	A	DM21000, DM21001
3	DM20300, DM20301	B	DM21100, DM21101
4	DM20400, DM20401	C	DM21200, DM21201
5	DM20500, DM20501	D	DM21300, DM21301
6	DM20600, DM20601	E	DM21400, DM21401
7	DM20700, DM20701	F	DM21500, DM21501

3-2. I/O Area

3-2-1. I/O Area map (Normal mode)

	15	14	13	12	11	10	9	8	7	6	5	4	3	2	1	0
nCH	Write Data 10 ³				Write Data 10 ²				Write Data 10 ¹				Write Data 10 ⁰			
	8	4	2	1	8	4	2	1	8	4	2	1	8	4	2	1
n+1CH	Area Selection	R/W		Demand	Command No. 10 ¹				Command No. 10 ⁰				Write Data 10 ⁴			
	8	4	2	1	8	4	2	1	8	4	2	1	8	4	2	1

	15	14	13	12	11	10	9	8	7	6	5	4	3	2	1	0
n+2CH	GrossWeight 10 ³				GrossWeight 10 ²				GrossWeight 10 ¹				GrossWeight 10 ⁰			
	8	4	2	1	8	4	2	1	8	4	2	1	8	4	2	1
n+3CH	Over	GO	Under	Complete	SP3	SP2	SP1	Near Zero	DecimalPoint Position	Gross Weight Sign	OFL3	GrossWeight 10 ⁴				
									2	1		8	4	2	1	
n+4CH	Net Weight 10 ³				Net Weight 10 ²				Net Weight 10 ¹				Net Weight 10 ⁰			
	8	4	2	1	8	4	2	1	8	4	2	1	8	4	2	1
n+5CH	Feed / Discharge	Tare Subtraction in Progress	HOLD in Progress	ZT in Progress	CZ	Stability	Upper Limit	Lower Limit	DecimalPoint Position	Net Weight Sign	OFL1	Net Weight 10 ⁴				
									2	1		8	4	2	1	
n+6CH		Normally ON	ERR ON	Cyclic bit					DIPSW							
									LK	RSV	RSV	RSV	MD3	MD2	MD1	MD0
n+7CH	Calibration Error	Weight Error	Zero Error	OFL3	OFL2	OFL1	+ LORD	- LORD	Error Auxiliary Code				Error Code			
									8	4	2	1	8	4	2	1
n+8CH	Reading Data 10 ³				Reading Data 10 ²				Reading Data 10 ¹				Reading Data 10 ⁰			
	8	4	2	1	8	4	2	1	8	4	2	1	8	4	2	1
n+9CH	Area Selection Response	R/W Response	NAK	ACK	Command ResponseNo.10 ¹				Command ResponseNo.10 ²				Reading Data 10 ⁴			
					8	4	2	1	8	4	2	1	8	4	2	1

n = 100 + 10 x Machine No. (For Machine Nos. 0 through 9) (C200H Series)
 400 + (Machine No. - 10) x 10 (For Machine Nos. A through F) (C200H Series)

n = 2000 + 10 x Machine No. (CS1 Series)

3-2-2. I/O Area map (Bit operation mode)

	15	14	13	12	11	10	9	8	7	6	5	4	3	2	1	0
nCH							Over/Under Weight Evaluation	AFC ON/OFF		Feed/Discharge Selection	Tare ON/OFF	HOLD	DZ OFF	DZ ON	TARE OFF	TARE ON
n+1CH	Area Selection															

	15	14	13	12	11	10	9	8	7	6	5	4	3	2	1	0
n+2CH	GrossWeight 10 ³ 8 4 2 1				GrossWeight 10 ² 8 4 2 1				GrossWeight 10 ¹ 8 4 2 1				GrossWeight 10 ⁰ 8 4 2 1			
n+3CH	Over	Go	Under	Complete	SP3	SP2	SP1	Near Zero	DecimalPoint Position 2 1		Gross Weight Sign	OFL3	GrossWeight 10 ⁴ 8 4 2 1			
n+4CH	Net Weight 10 ³ 8 4 2 1				Net Weight 10 ² 8 4 2 1				Net Weight 10 ¹ 8 4 2 1				Net Weight 10 ⁰ 8 4 2 1			
n+5CH	Feed / Discharge	Tare Subtraction in Progress	HOLD in Progress	ZT in Progress	CZ	Stability	Upper Limit	Lower Limit	DecimalPoint Position 2 1		Net Weight Sign	OFL1	Net Weight 10 ⁴ 8 4 2 1			
n+6CH		Normally ON	ERR ON	Cyclic bit						LK	RSV	RSV	DIPSW RSV MD3 MD2 MD1 MD0			
n+7CH	Calibration Error	Weight Error	Zero Error	OFL3	OFL2	OFL1	+ LORD	- LORD	Error Auxiliary Code 8 4 2 1				Error Code 8 4 2 1			
n+8CH							Over/Under-Weight Evaluation	AFC ON/OFF	SOFT LOCK	Feed/Discharge Selection	Tare ON/OFF	HOLD	DZ OFF	DZ ON	TARE OFF	TARE ON
n+9CH	Area Selection Response														D out Active	D in Active

n = 100 + 10 x Machine No. (For Machine Nos. 0 through 9) (C200H Series)
 400 + (Machine No. - 10) x 10 (For Machine Nos. A through F) (C200H Series)

n = 2000 + 10 x Machine No. (CS1 Series)

3-3. I/O Area modes

[OUTPUT] means those bits to be set in F158 from PLC. "PLC → F158"

[INPUT] means those bits to be entered in PLC from F158. "PLC ← F158"

Listed below are the addresses set in Machine No.0 of C200H Series. For comparison weight values, either net or gross weight may be selected.

3-3-1. Normal mode

Write Data 10⁰ to Write Data 10⁴ (10000 to 10103) [OUTPUT]

Used to register setpoint values. To be registered in BCD. Any data other than significant digits will be treated as zero (0) such as the upper two digits of a three-digit setpoint.

Command No.10⁰ to Command No.10¹ (10104 to 10111) [OUTPUT]

Provides instructions for setpoint reading or writing, or operation.

Demand (10112) [OUTPUT]

Issues a command in response to the startup of any demand bit.

R/W (10114) [OUTPUT]

To be set in 1 for reading or 0 for writing and operating instruction.

Area Selection (10115) [OUTPUT]

To be set in 0 in the normal mode or 1 in the bit operation mode. Selection of mode is only available while the both bits Demand and Response are set OFF.

Gross Weight 10⁰ to Gross Weight 10⁴ (10200 to 10303) [INPUT]

Displays a gross weight.

OFL3 (10304) [INPUT]

When Gross Weight > Gross Weight Over, 1 will be assigned.

Gross Weight Sign (10305) [INPUT]

When a gross weight is negative, 1 will be assigned.

Decimal Point Position (10306, 10307) [INPUT]

Indicates a decimal point position.

10307	10306	
ON	ON	0.000
ON	OFF	0.00
OFF	ON	0.0
OFF	OFF	0

Near Zero (10308) [INPUT]

When Weight Value \leq Near Zero setpoint, 1 will be assigned.

SP1 (10309) [INPUT]

When Weight Value \geq Final setpoint - SP1 setpoint, 1 will be assigned.

SP2 (10310) [INPUT]

When Weight Value \geq Final setpoint - SP2 setpoint, 1 will be assigned.

SP3 (10311) [INPUT]

When Weight Value \geq Final setpoint - SP3 setpoint, 1 will be assigned.

Completion (10312) [INPUT]

When weight measurement is completed (weight value reaches Final setpoint and becomes stable), 1 will be assigned. With the time-up in the completion timer, 0 will be assigned.

Underweight (10313) [INPUT]

When Weight Value \leq Final setpoint - Underweight setpoint, 1 will be assigned.

GO Weight (10314) [INPUT]

When a weight value is correct without any under- or over-weight, 1 will be assigned.

Overweight (10315) [INPUT]

When Weight Value \geq Final setpoint + Overweight setpoint, 1 will be assigned.

Net Weight 10⁰ to Net Weight 10⁴ (10400 to 10503) [INPUT]

Displays a net weight.

OFL1 (10504) [INPUT]

When Weight Value > Net weight Over, 1 will be assigned.

Net Weight Sign (10505) [INPUT]

When a net weight is negative, 1 will be assigned.

Decimal Point Position (10506, 10507) [INPUT]

Displays a decimal point position similarly as 10307 and 10306.

Lower Limit (10508) [INPUT]

When Weight Value < Lower Limit setpoint, 1 will be assigned.

Upper Limit (10509) [INPUT]

When Weight Value > Upper Limit setpoint, 1 will be assigned.

Stability (10510) [INPUT]

When a weight value becomes stable, 1 will be assigned. The definition of stability is determined based on the motion detect.

CZ [Center Zero] (10511) [INPUT]

When a gross weight falls within a scale of center $\pm 1/4$ for each value, 1 will be assigned.

ZT in Progress [Zero Tracking in Progress] (10512) [INPUT]

When the zero tracking is active, 1 will be assigned.

HOLD in Progress (10513) [INPUT]

When a weight value is held, 1 will be assigned.

Tare Subtraction in Progress (10514) [INPUT]

When the subtraction of tare weight is in progress (tare weight $\neq 0$), 1 will be assigned.

Feed / Discharge (10515) [INPUT]

For feed control, 0 will be assigned, and for discharge control, 1 will be assigned.

DIPSW (10600 - 10607) [INPUT]

Displays the status of the rear DIP Switch at the power-on sequence.

Cyclic bit (10612) [INPUT]

Every about one second, 0 and 1 are changed alternately.

ERR ON (10613) [INPUT]

When any error is detected (Error Code $\neq 0$), 1 will be assigned.

Normally ON (10614) [INPUT]

Normally 1 will be assigned.

Error Code (10700 - 10703) [INPUT]

Indicates the status of any error in conjunction with Error Auxiliary Code. When there is no error, 0 will be assigned.

Error Auxiliary Code (10704 - 10707) [INPUT]

Indicates the status of any error in conjunction with Error Code. When there is no error, 0 will be assigned. See the description of Error Code.

-LOAD (10708) [INPUT]

When the input voltage to loadcell becomes excessive in the negative side.

+LOAD (10709) [INPUT]

When the input voltage to loadcell becomes excessive in the positive side.

OFL1 (10710) [INPUT]

When Net Weight > Net Over setpoint.

OFL2 (10711) [INPUT]

When Gross Weight > Allowable Maximum Weighing Value + 9 scale.

OFL3 (10712) [INPUT]

When Gross Weight > Gross Weight Over setpoint.

Zero Error (10713) [INPUT]

When zero (0) results in a range beyond Digital Zero Control Value during the Digital Zero or Zero Tracking, 1 will be assigned.

With selection of Calibration mode or resetting of Digital Zero, 0 will be assigned.

Weight Error (10714) [INPUT]

When any of the above 10708 to 10713 applies, 1 will be assigned.

The "OVR" LED will illuminate.

Calibration Error (10715) [INPUT]

When any calibration error occurs, 1 will be assigned.

The "CAL" LED will illuminate.

Reading Data 10⁰ to Reading Data 10⁴ (10800 to 10903) [INPUT]

Allows viewing of data when the reading of setpoint is set active.

Command Response 10¹ to Command Response 10⁰ (10904 to 10911) [INPUT]

Provides a command in response to Demand set ON.

ACK (10912) [INPUT]

When the Demand command is correctly processed, 1 will be assigned.

When Demand is set OFF, 0 will be assigned.

NAK (10913) [INPUT]

When the Demand command fails to be executed for some reasons, 1 will be assigned.

The "CMD" LED will illuminate. When Demand is set OFF, 0 will be assigned.

R/W Response (10914) [INPUT]

Returns the status of R/Wbit when the demand is set ON.

Area Selection Response (10915) [INPUT]

In the normal mode, 0 will be assigned.

3-3-2. Bit Operation Mode

TARE ON (10000) [OUTPUT]

Executes the Tare Subtraction in response to ON Edge.

TARE OFF (10001) [OUTPUT]

Resets the Tare Subtraction in response to ON Edge.

DZ ON (10002) [OUTPUT]

Executes Digital Zero in response to ON Edge.

DZ OFF (10003) [OUTPUT]

Resets Digital Zero in response to OFF Edge.

Zero Failure will be also cleared.

HOLD (10004) [OUTPUT]

Holds a weight value.

Tare ON/OFF (10005) [OUTPUT]

This bit sets the presence/absence of tare weight (Setting Mode 2-4).

When this bit is set in 1, tare weight setting is set active, and when this bit is set in 0, tare weight setting is set inactive.

Feed / Discharge Selection (10006) [OUTPUT]

This bit allows selection between feed and discharge (Setting Mode 2-3).

When this bit is set in 1, discharge is under control, and when this bit is set in 0, feed is under control.

Automatic Fall Compensation ON/OFF (10008) [OUTPUT]

This bit sets ON/OFF the automatic Fall Compensation (Setting Mode 2-5).

When this bit is set in 1, automatic Fall Compensation is set active, and when this bit is set in 0, automatic Fall Compensation is set inactive.

Over/Under-Weight Evaluation (10009) [OUTPUT]

This bit evaluates overweight or under-weight (Setting Mode 2-7).

When this bit is set in 1, comparison is set ON, and when this bit is set in 0, comparison is set OFF.

The addresses 10200 through 10715 are same as those in the normal mode.

TARE ON Response (10800) [INPUT]

Returns the status of 10000.

TARE OFF Response (10801) [INPUT]

Returns the status of 10001.

DZ ON Response (10802) [INPUT]

Returns the status of 10002.

DZ OFF Response (10803) [INPUT]

Returns the status of 10003.

HOLD ON Response (10804) [INPUT]

Returns the status of 10004.

Tare ON/OFF Response (10805) [INPUT]

Returns the status of 10005.

Feed / Discharge Selection Response (10806) [INPUT]

Returns the status of 10006.

SOFT LOCK (10807) [INPUT]

When SOFT LOCK is set ON, this bit is assigned 1 (value in Setting Mode 49).

Automatic Fall Compensation ON/OFF Response (10808) [INPUT]

Returns the status of 10008.

Over/Under Evaluation Response (10809) [INPUT]

Returns the status of 10009.

D in Active (10900) [INPUT]

When MD0 of DIP SW is set ON and setting in DM Area is set active, registration of setpoint in DM Area becomes active and this bit is assigned 1.

D out Active (10901) [INPUT]

When MD1 of DIP SW is set ON and setting in DM Area is set active, registration of setpoint in DM Area becomes active and this bit is assigned 1.

Area Selection Response (10915) [INPUT]

When the bit operation mode is set active, this bit is assigned 1.

3-4. Exclusive DM Area

3-4-1. Setpoint Registration Area

F 1 5 8 ← PLC

	MSB			LSB
DM(m)	10^3	10^2	10^1	10^0
DM(m+1)	(Final)			10^4
DM(m+2)	10^3	10^2	10^1	10^0
DM(m+3)	(SP1)			10^4
DM(m+4)	10^3	10^2	10^1	10^0
DM(m+5)	(SP2)			10^4
DM(m+6)	10^3	10^2	10^1	10^0
DM(m+7)	(SP3)			
DM(m+8)		10^2	10^1	10^0
DM(m+9)	(Over-Weight)			
DM(m+10)		10^2	10^1	10^0
DM(m+11)	(Under-Weight)			
DM(m+12)	10^3	10^2	10^1	10^0
DM(m+13)	(Upper Limit)			10^4
DM(m+14)	10^3	10^2	10^1	10^0
DM(m+15)	(Lower Limit)			10^4
DM(m+16)	10^3	10^2	10^1	10^0
DM(m+17)	(Near Zero)			10^4
DM(m+18)	10^3	10^2	10^1	10^0
DM(m+19)	(Tare Setting)			10^4

3-4-2. Setpoint Display Area

F 1 5 8 → P L C

	MSB			LSB
DM(k)	10 ³	10 ²	10 ¹	10 ⁰
DM(k+1)	(Final)			10 ⁴
DM(k+2)	10 ³	10 ²	10 ¹	10 ⁰
DM(k+3)	(SP1)			10 ⁴
DM(k+4)	10 ³	10 ²	10 ¹	10 ⁰
DM(k+5)	(SP2)			10 ⁴
DM(k+6)	10 ³	10 ²	10 ¹	10 ⁰
DM(k+7)	(SP3)			
DM(k+8)		10 ²	10 ¹	10 ⁰
DM(k+9)	(Over-Weight)			
DM(k+10)		10 ²	10 ¹	10 ⁰
DM(k+11)	(Under-Weight)			
DM(k+12)	10 ³	10 ²	10 ¹	10 ⁰
DM(k+13)	(Upper Limit)			10 ⁴
DM(k+14)	10 ³	10 ²	10 ¹	10 ⁰
DM(k+15)	(Lower Limit)			10 ⁴
DM(k+16)	10 ³	10 ²	10 ¹	10 ⁰
DM(k+17)	(Near Zero)			10 ⁴
DM(k+18)	10 ³	10 ²	10 ¹	10 ⁰
DM(k+19)	(Tare Setting)			10 ⁴

Address registered in m = DM(1000 + 100 x Machine No.) (C200H Series)

Address registered in k = DM(1000 + 100 x Machine No. + 1) (C200H Series)

Address registered in m = DM(1000 + 100 x Machine No.) (CS1 Series)

Address registered in k = DM(1000 + 100 x Machine No. + 1) (CS1 Series)

4. Calibration

4-1. Introduction to calibration

The operation for matching between F158 and loadcells is called 'calibration.' In practice, calibration means the adjustment that F158 can accurately register a reading of 100.00 kg when an actual load (or counterweight) of 100 kg is applied on a loadcell (weighing machine) on a weighing machine connected to F158. This process is called calibration under the actual load..

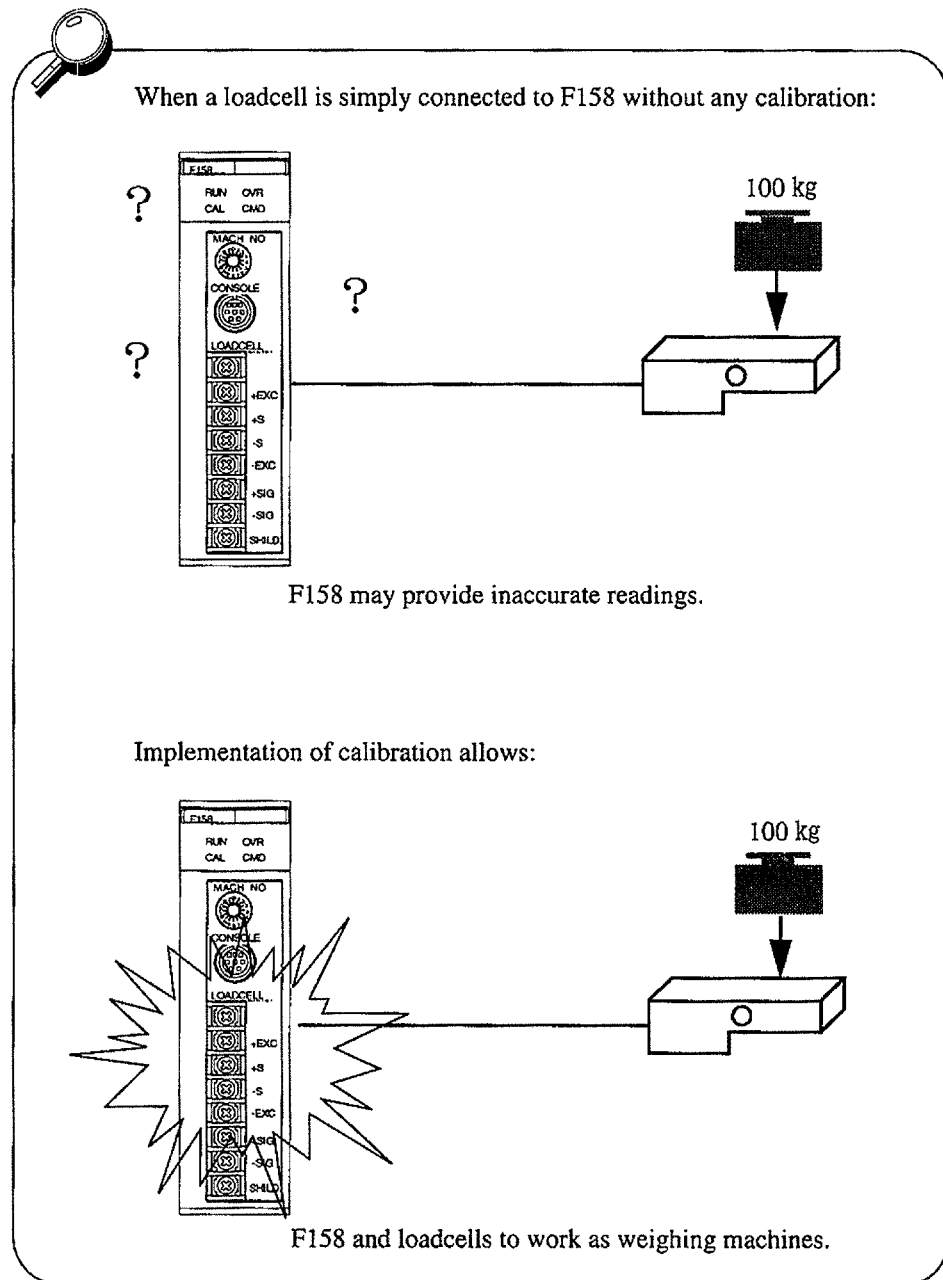

4-2. Calibration under actual load

For the calibration under the actual load, follow the steps below.

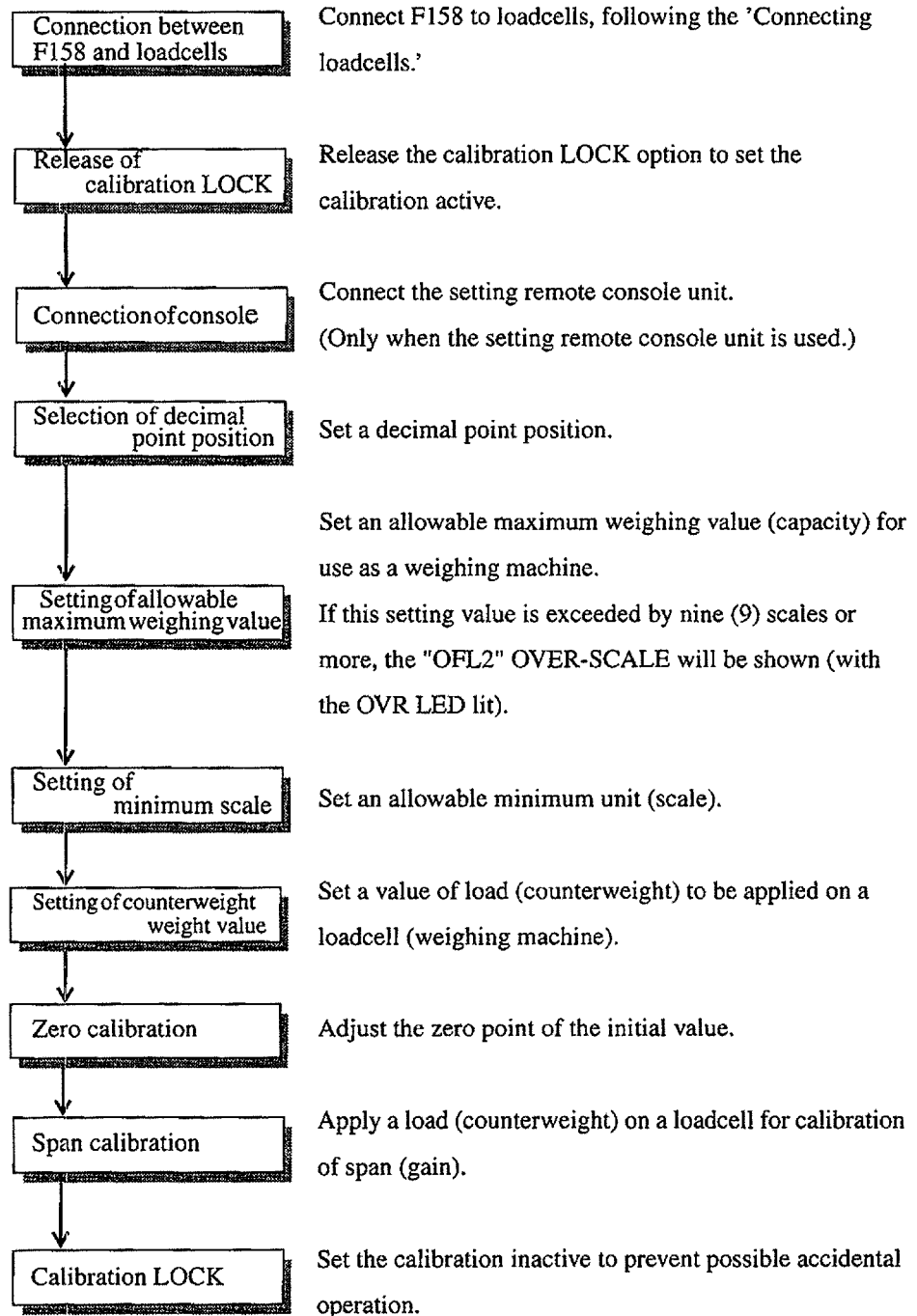

4-3. Operation of calibration under actual load

4-3-1. Calibration LOCK Release

The F158 is designed to disable any change of calibrated values, thereby preventing accidental changing of calibrated values (this is called calibration LOCK function). To set calibration active, release the LOCK function as follows.

- 1) Remove F158 from PLC.

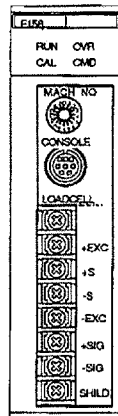

- 2) Set OFF No.8 of setting DIP SW on the rear.

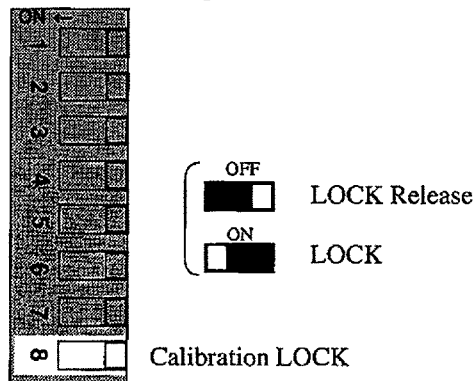

- 3) Set the setting mode 4-9 'Setpoint LOCK' (SOFT LOCK) to "0."

- 4) At this point of time, the calibration LOCK is successfully reset.



CAUTION

When the calibration LOCK switch is set ON, changing of initial setting items is also set disabled.

For items set disabled for setting, see the List of Setpoint Values.

4-3-2. Connecting console

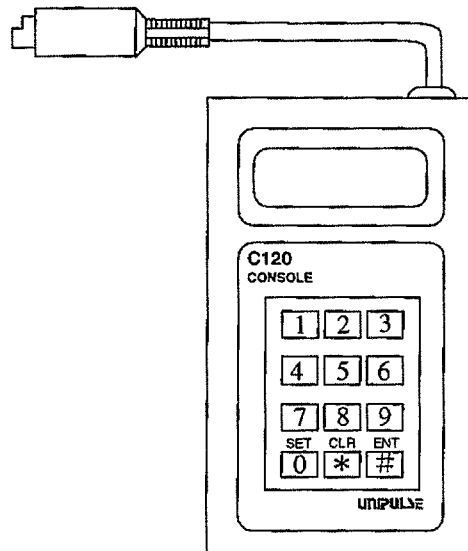
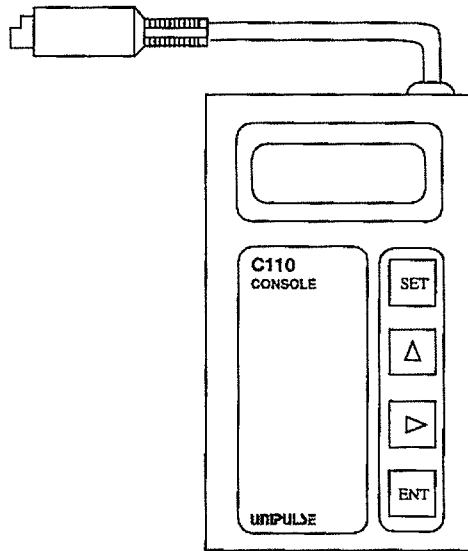
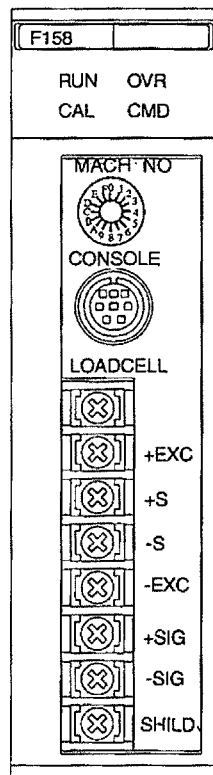

For calibration using the setting remote console unit (C110, C120), use the CONSOLE connector on the F158 to connect the remote console unit. (For detail, see Pages 39 and 48.)



4-3-3. Selecting decimal point (Capacity)

Select a decimal point position from 0.0.0.0.0

Selection of Decimal Point Position

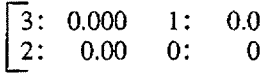
- 1) Select the setting mode 4. 
- 2) Select the setting item 6. 
- 3) Press the ENT key to set the decimal point position. 
- 4) After setting the decimal point position, remember to press the ENT key again to store the selected decimal point position. 

I/O Area

“Normal mode”

	b15	b12 b11	b8 b7	b4 b3	b0
n CH				2	
n+1CH		4	6		



The register addresses in F158 cannot identify any decimal point for all numerical values including weight values. Then, to select an allowable maximum weighing value of 100.00 and a minimum scale of 0.01 for example, enter 10000 and 1 then select a decimal point position of 2: 0.00.

4-3-4. Setting allowable maximum weighing value

Set an allowable maximum value for use as a weighing machine. If any weight value exceeds this setting value by 9 or more scales, "OFL2" over-scale will result (with the OVR LED lit).

Setting of Allowable maximum Weighing Value

1) Select the setting mode 4. 40 100.00

2) Select the setting item 1. 41 100.00

3) Press the ENT key to set an allowable maximum weighing value. 41 100.00

4) After setting is completed, remember to press the ENT key again to store the selected allowable maximum weighing value.

} 100.00

 maximum weighing value
 (Max 5digits)

I/O Area



“Normal mode”

	b15	b12 b11	b8 b7	b4 b3	b0
n CH	0	0	0	0	
n+1CH		4	1	1	

4-3-5. Setting minimum scale

Set a minimum unit (scale) for weighing. The value (allowable maximum weighing value / minimum scale) means the resolution of displaying. For the displaying resolution, select a value of 10000 or smaller.

Setting of Minimum Scale

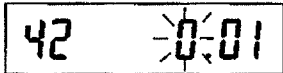
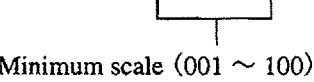
- 1) Select the setting mode 4. 
- 2) Select the setting item 2. 
- 3) Press the ENT key to set a minimum scale. 
- 4) After setting is completed, remember to press the ENT key again. 

I/O Area

“Normal mode”

	b15	b12	b11	b8	b7	b4	b3	b0
n CH			0		0		1	
n+1CH			4		2			

4-3-6. Setting counterweight weight

Set a value of load (counterweight) to be applied to a loadcell during the span calibration.

Setting of Counterweight Weight Value

1) Select the setting mode 4. 41 100.00

2) Select the setting item 0. 40 100.00

3) Press the ENT key to set a counterweight weight value. 40 > 100.00

4) After setting is completed, remember to press the ENT key again to store the selected counterweight weight value.
40 > 100.00
└───┘
 Counterweight weight
 (Max5digits)

I/O Area

“Normal mode”

	b15	b12 b11	b8 b7	b4 b3	b0
n CH	0	0	0	0	
n+1CH		4	0	1	

4-3-7. Zero Calibration

Make fine adjustment of the initial zero point.

Zero Point Adjustment

- 1) Select the setting mode 9. 91 0
- 2) Select the setting item 0. 90 0
- 3) Press the ENT key to make fine adjustment of zero point. c.2Err 0
- 4) When the fine adjustment of zero point is successfully completed, c.2Err 0

d0 0 (weight value) will be displayed for a few seconds

then the display returns to 90 0

I/O Area

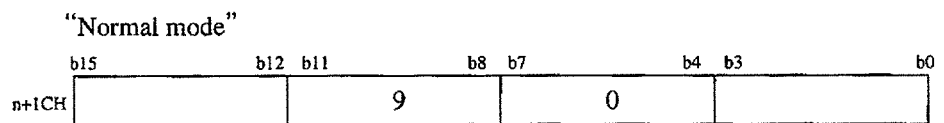

If any calibration error is displayed, follow the corresponding error message to take corrective action, and then repeat the zero-point adjustment.

cErr2 ...The initially deleted tare weight exceeds the zero-point adjustment range.

Insert a resistance of a proper value between the terminals +EXC and -SIG in the loadcell to shift the zero point, and then repeat the zero-point adjustment.

cErr3 ...The initially deleted tare weight is in the negative side. Check the load applied to the loadcell for correct direction or the cable connection between +SIG and -SIG for any reverse wiring. Then, repeat the zero-point adjustment.

cErr9 ...The weight value is unstable. Adjust the motion detect parameters and check that the status of "Stability" is set in 1, then repeat the zero-point adjustment.



* As a guideline, relation between resistance and input signal is summarized in the table below.

Resistor		Strain	
Ideal	Approx	μ -STRAIN	mV/V
875 K Ω	866 K Ω	200	0.1
437 K Ω	442 K Ω	400	0.2
291 K Ω	294 K Ω	600	0.3
219 K Ω	221 K Ω	800	0.4
175 K Ω	174 K Ω	1000	0.5
146 K Ω	147 K Ω	1200	0.6
125 K Ω	124 K Ω	1400	0.7
109 K Ω	110 K Ω	1600	0.8
97 K Ω	97.6 K Ω	1800	0.9
87.3 K Ω	86.6 K Ω	2000	1.0
79.4 K Ω	78.7 K Ω	2200	1.1
72.7 K Ω	73.2 K Ω	2400	1.2
67.1 K Ω	66.5 K Ω	2600	1.3
62.3 K Ω	61.9 K Ω	2800	1.4
58.2 K Ω	57.6 K Ω	3000	1.5
54.5 K Ω	54.9 K Ω	3200	1.6
51.3 K Ω	51.1 K Ω	3400	1.7
48.4 K Ω	48.7 K Ω	3600	1.8
45.9 K Ω	46.4 K Ω	3800	1.9
43.6 K Ω	43.2 K Ω	4000	2.0
41.5 K Ω	41.2 K Ω	4200	2.1
39.6 K Ω	39.2 K Ω	4400	2.2
37.9 K Ω	38.3 K Ω	4600	2.3
36.3 K Ω	36.5 K Ω	4800	2.4
34.8 K Ω	34.8 K Ω	5000	2.5

* The values listed in the table are applied for 350 Ω series loadcells.

* The temperature coefficient of resistance directly affects the accuracy of F158. Use a resistance having a temperature coefficient of 50 ppm/ $^{\circ}$ C or more (recommended value of about 5 ppm/ $^{\circ}$ C).

4-3-8. Span Calibration

Fine-adjust the span.

Fine-adjustment the span

- 1) Select the setting mode 9. 90 0
- 2) Select the setting item 1. 91 0
- 3) Press the ENT key to start the fine-adjustment of span.

↓ ENT
 c.SPAN 0
 ↓ ENT
 c.SPAN 0
- 4) When the span calibration is successfully completed,

00 0 will be displayed for a few seconds, and then the display returns to 91 0.

I/O Area

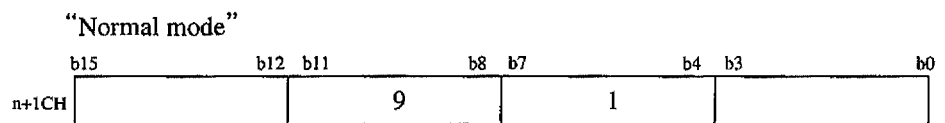

If any calibration error is displayed, follow the corresponding error message to take corrective action, and then repeat the span calibration.

cErr1 ...Recalibration of zero point is necessary.
Repeat the zero calibration.

cErr4 ...The counterweight weight value is set larger than the allowable maximum weighing value.
Set the counterweight weight value smaller than the allowable maximum weighing value.

cErr5 ...The counterweight weight value is set in "00000."
Set a correct value for the counterweight weight.

cErr6 ...The output of loadcell does not reach the span adjustment range. Check the output of loadcell if it reaches the span adjustment range of F158

cErr7 ...The output of loadcell is in the negative side. Check if the cable between +SIG and -SIG is in the reverse direction.

cErr8 ...The output of loadcell is beyond the span adjustment range. Check the output of loadcell if it falls within the span adjustment range of F158.

cErr9 ...The weight value is unstable. Adjust the motion detect parameter, check that the status of Stability is set in 1, and then repeat the calibration.

To identify any calibration error number (number in an error message) during the zero calibration or span calibration, check the error code in the I/O map.

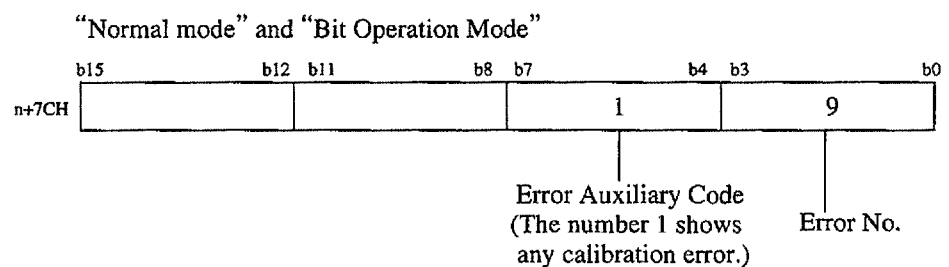

4-3-9. Calibration LOCK

After completion of zero calibration and span calibration, set the change of calibrated values disabled to prevent accidental changing of calibrated values.

1) Remove the F158 from PLC, then set ON No.8 of setting DIP SW on the rear.

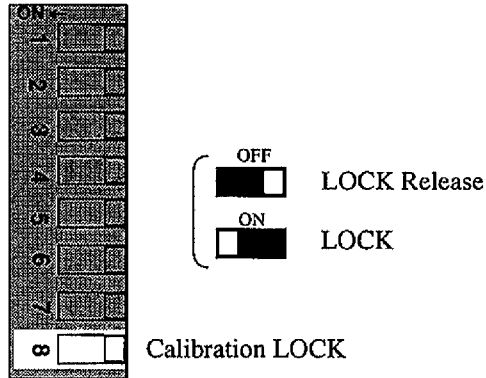

2) Otherwise, set the setting mode 4-9 'Setpoint LOCK' (SOFT LOCK) to "1."

3) At this point of time, changing of calibrated values is set disabled.



CAUTION

When the calibration LOCK switch is set ON, changing of initial setting items is also disabled.

For items disabled to change relevant values, see the List of Setpoint Values.

5. Reading of Weight Value and Status

5-1. Gross Weight, Net Weight and Tare Weight

F158 is designed to allow independent measurement of gross weight and net weight. Gross weight and net weight hold a relationship shown below.

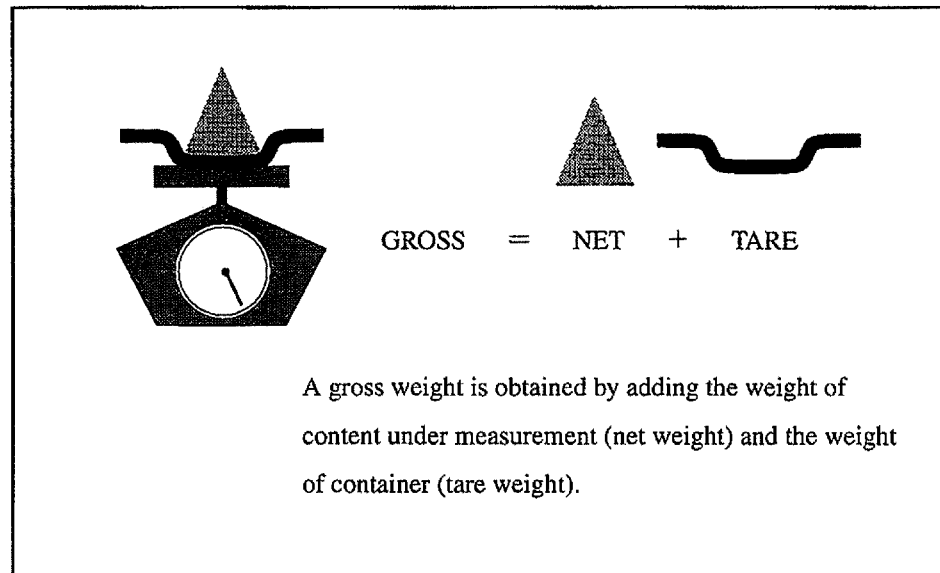

5-2. Operating setting remote console unit

The setting remote console unit shows readings of gross weight, net weight, or tare weight.

5-2-1. Operating C110

Monitor Mode

d0 100.00	Gross Weight (-sign,5digits,decimal point,zerosupless)
d1 100.00	Net Weight (-sign,5digits,decimal point,zerosupless)
d2 0.00	Tare Weight (-sign,5digits,decimal point,zerosupless)
d3 10dt	I/Odata Monitor (4digits, hexa decimal)
d4 d1	DM Area Monitor (Input data) (4digits, hexa decimal)
d5 do	DM Area Monitor (Output data) (4digits, hexa decimal)
d6	
d7	
d8 1.00	Rom Version
d9 FFFF	Rom Sum

Setpoint Mode

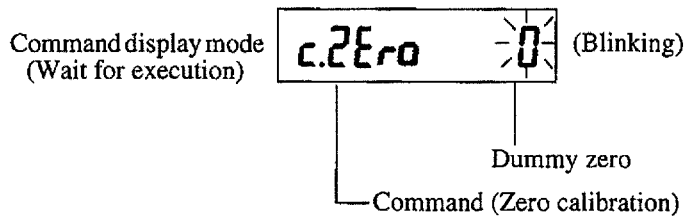
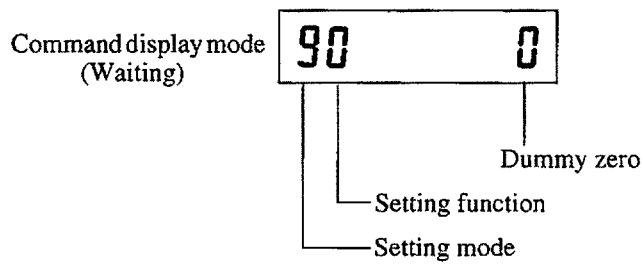
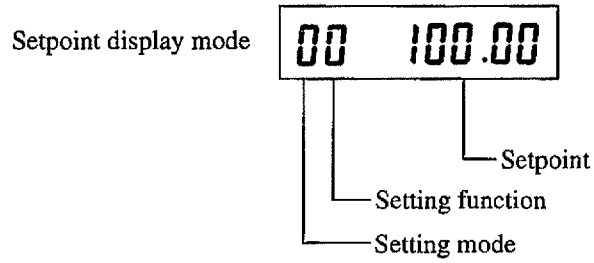

Operation of Monitor

Use the [▲] key to change the content of display. While d3, d4, or d5 is displayed, press the [ENT] key to enter the monitor mode. Then press the [▶] key to change the addresses.

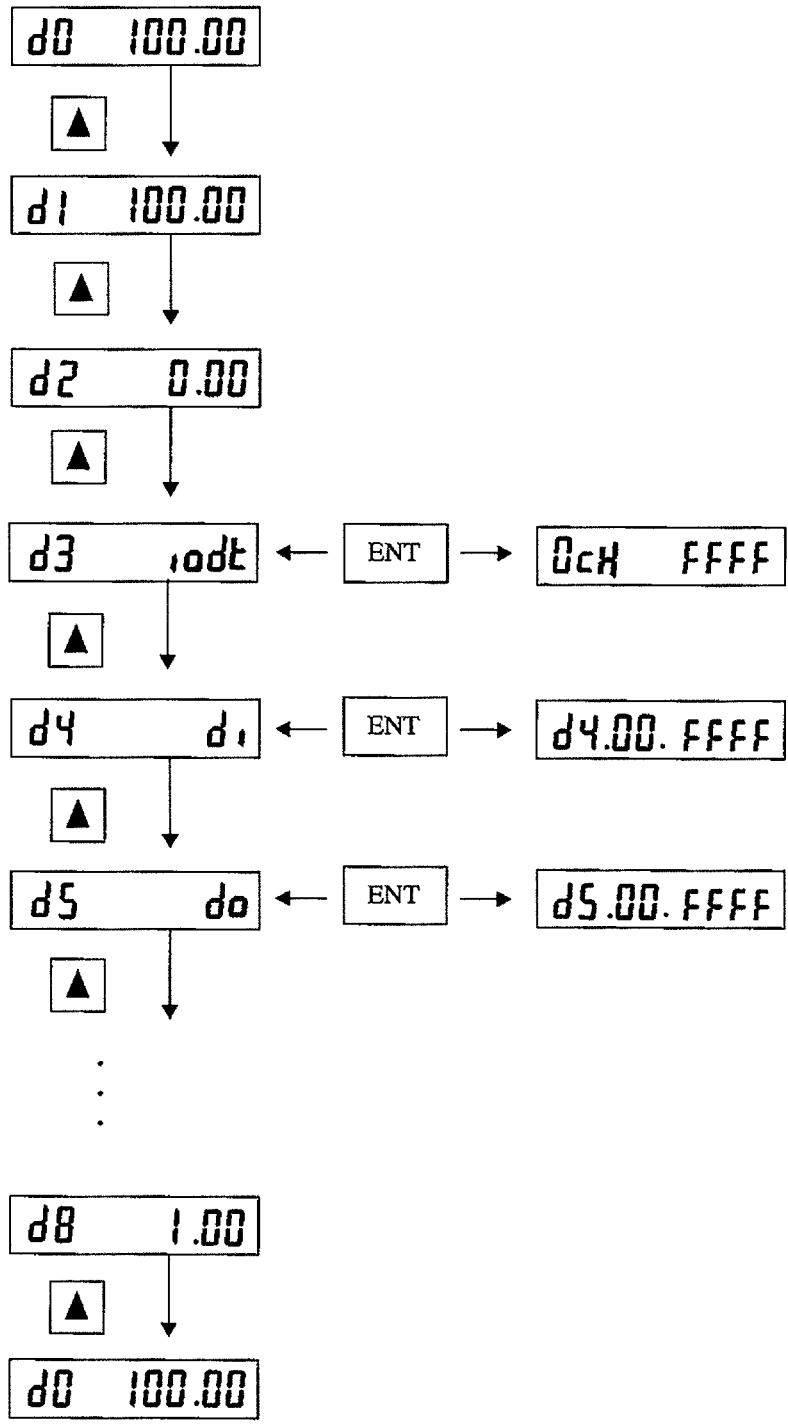

Monitoring of d3 (I/O Data)

The starting address of I/O data depends on Machine No.

Area available for monitoring is determined as follows.

$(100 + n \times 10)$ CH through $(100 + n \times 10 + 9)$ CH

(For Machine Nos. 0 through 9) (C200H Series)

or,

$(400 + (n - 10) \times 10)$ CH through $(400 + (n - 10) \times 10 + 9)$ CH

(For Machine Nos. A through F) (C200H Series)

$(2000 + n \times 10)$ CH through $(2000 + n \times 10 + 9)$ CH

(CS1 Series)

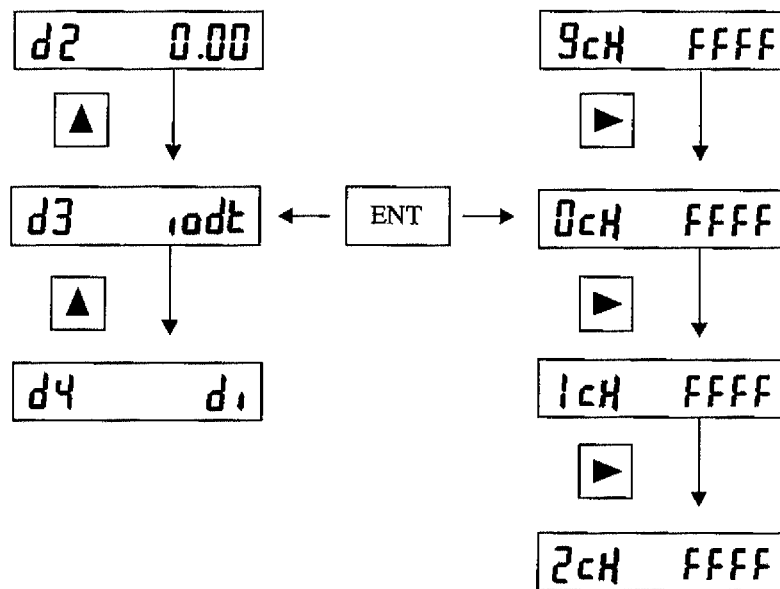

Relation between Machine No. and I/O Area (C200H Series)

No.	I/O Area	No.	I/O Area
0	100CH ~ 109CH	8	180CH ~ 189CH
1	110CH ~ 119CH	9	190CH ~ 199CH
2	120CH ~ 129CH	A	400CH ~ 409CH
3	130CH ~ 139CH	B	410CH ~ 419CH
4	140CH ~ 149CH	C	420CH ~ 429CH
5	150CH ~ 159CH	D	430CH ~ 439CH
6	160CH ~ 169CH	E	440CH ~ 449CH
7	170CH ~ 179CH	F	450CH ~ 459CH

Relation between Machine No. and I/O Area (CS1 Series)

No.	I/O Area	No.	I/O Area
0	2000CH ~ 2009CH	8	2080CH ~ 2089CH
1	2010CH ~ 2019CH	9	2090CH ~ 2099CH
2	2020CH ~ 2029CH	A	2100CH ~ 2109CH
3	2030CH ~ 2039CH	B	2110CH ~ 2119CH
4	2040CH ~ 2049CH	C	2120CH ~ 2129CH
5	2050CH ~ 2059CH	D	2130CH ~ 2139CH
6	2060CH ~ 2069CH	E	2140CH ~ 2149CH
7	2070CH ~ 2079CH	F	2150CH ~ 2159CH

Monitoring of d4 and d5 (DM Area)

In C200H Series, DM area is allocated to the starting address registered in DM (1000 + 100 x n) and DM (1000 + 100 x n+1). (The letter n means Machine No.)

Area available for monitoring is from DM (m) to (m + 19) and from DM (k) to (k + 19). (The letters m and k mean the starting addresses.)

In CS1 Series, $m=20000 + 100 \times n$
 $k=20000 + 100 \times n + 1$

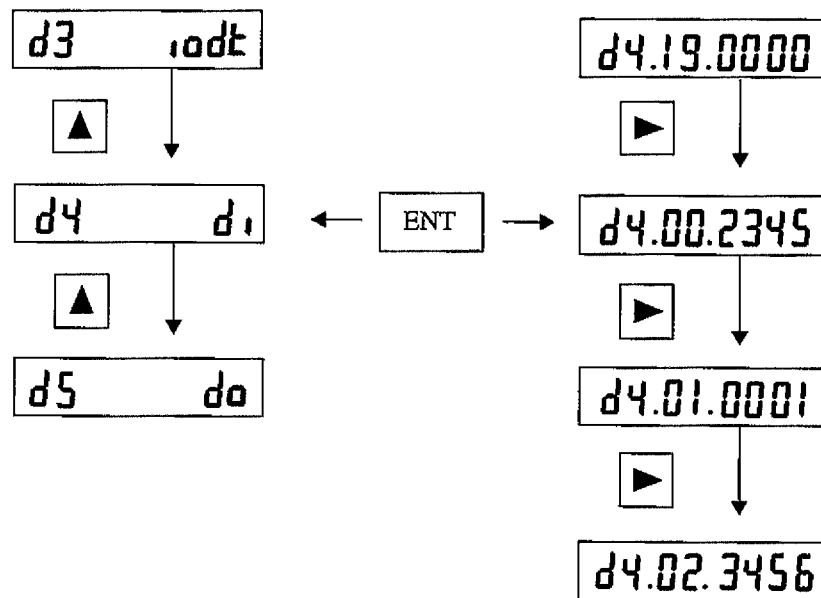

Relation between Machine No. and Starting Address Registration Area
(C200H Series)

No.	Starting Address Registration Area	No.	Starting Address Registration Area
0	DM1000, DM1001	8	DM1800, DM1801
1	DM1100, DM1101	9	DM1900, DM1901
2	DM1200, DM1201	A	DM2000, DM2001
3	DM1300, DM1301	B	DM2100, DM2101
4	DM1400, DM1401	C	DM2200, DM2201
5	DM1500, DM1501	D	DM2300, DM2301
6	DM1600, DM1601	E	DM2400, DM2401
7	DM1700, DM1701	F	DM2500, DM2501

Relation between Machine No. and Starting Address Registration Area (CS1 Series)

No.	Starting Address Registration Area	No.	Starting Address Registration Area
0	DM20000, DM20001	8	DM20800, DM20801
1	DM20100, DM20101	9	DM20900, DM20901
2	DM20200, DM20201	A	DM21000, DM21001
3	DM20300, DM20301	B	DM21100, DM21101
4	DM20400, DM20401	C	DM21200, DM21201
5	DM20500, DM20501	D	DM21300, DM21301
6	DM20600, DM20601	E	DM21400, DM21401
7	DM20700, DM20701	F	DM21500, DM21501

Reading of Setpoint

Press the [SET] key to toggle the mode between Monitor and Setpoint.

Use the [▲] key to select a setting function, and then use the [▶] key to change the setting mode.

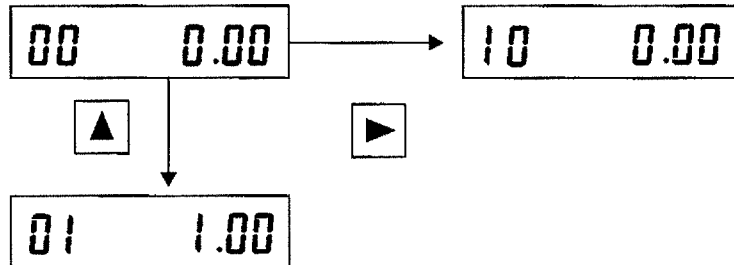

Changing of Setpoint

For any setpoint, press the [ENT] key to start changing of value, use the [▶] key to move through the digits, use the [▲] key to change the value, and press the [SET] key to cancel the changing.

After setting any changed value, press the [ENT] key to enter the changed value.

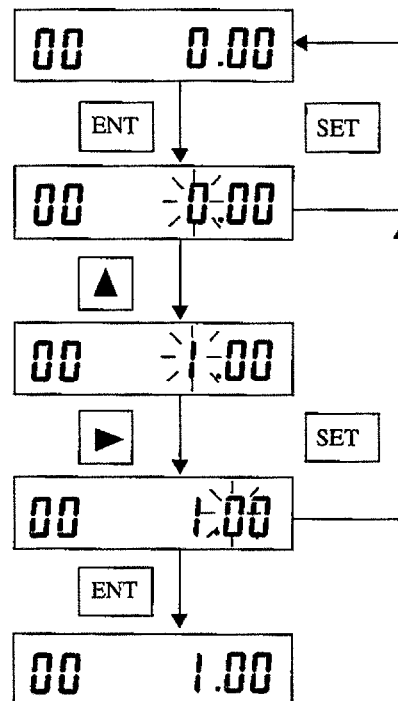

Execution of Command (In the case of zero calibration)

Press the [ENT] key then [ENT] key again to execute a command.

To cancel the command, press the [SET] key.

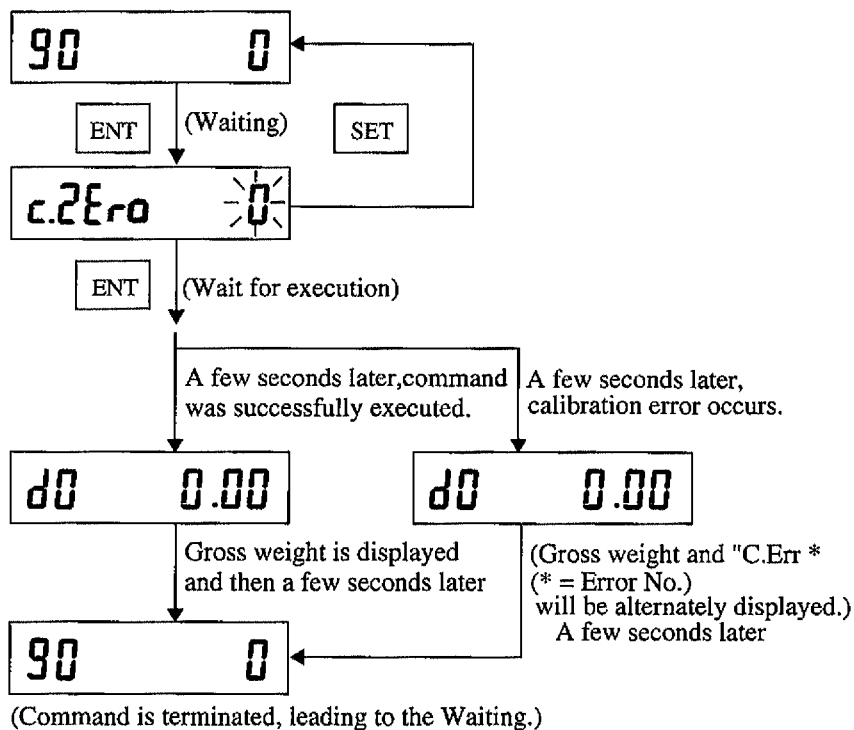

5-2-2. Operating C120

Monitor Mode

d0	100.00	Gross weight (-sign,5digits,decimal point,zerosupless)
d1	100.00	Net Weight (-sign,5digits,decimal point,zerosupless)
d2	0.00	Tare Weight (-sign,5digits,decimal point,zerosupless)
d3	iodt	I/Odata Monitor (4digits, hexa decimal)
d4	d1	DM Area Monitor (Input data) (4digits, hexa decimal)
d5	do	DM Area Monitor (Output data) (4digits, hexa decimal)
d6		
d7		
d8	1.00	Rom version
d9	FFFF	Rom Sum

Setpoint Mode

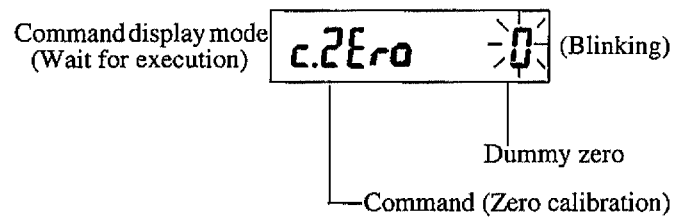
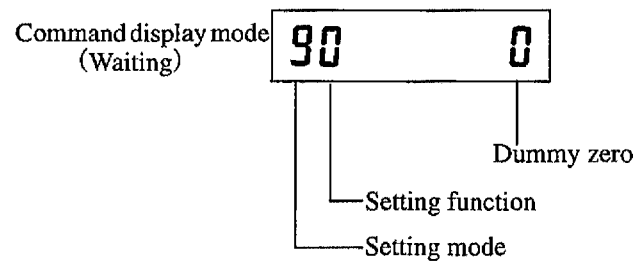
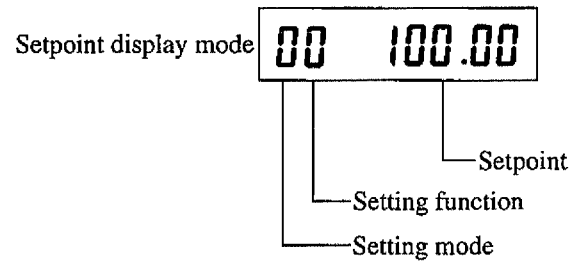

Operation of Monitor

Use the numerical keys [0] through [9] to change the content for monitoring. For d3, d4, or d5, use the [#] to change the content for monitoring.

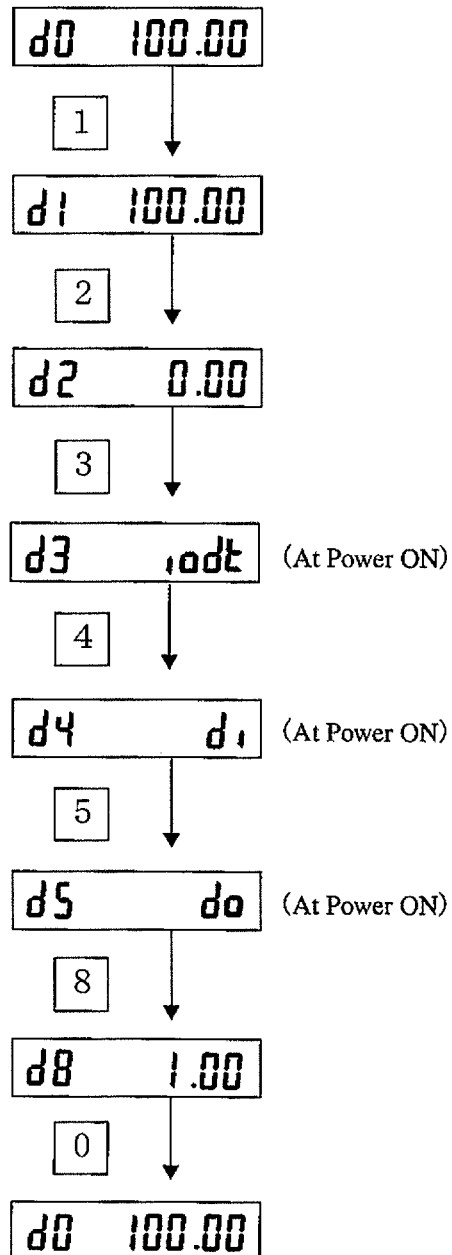

Monitoring of d3 (I/O Data)

The starting address of I/O data depends on Machine No.

Area allowed to monitor is determined as follows.

$(100 + n \times 10)$ CH through $(100 + n \times 10 + 9)$ CH

(For Machine Nos. 0 through 9) (C200H Series)

or,

$(400 + (n - 10) \times 10)$ CH through $(400 + (n - 10) \times 10 + 9)$ CH

(For Machine Nos. A through F) (C200H Series)

$(2000 + n \times 10)$ CH through $(2000 + n \times 10 + 9)$ CH

(CS1 Series)

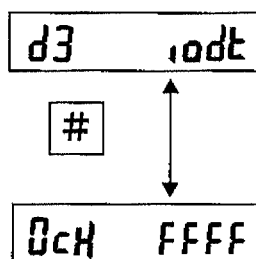

Use the numerical keys [0] through [9] to change the addresses.

Relation between Machine No. and I/O Area (C200H Series)

No.	I/O Area	No.	I/O Area
0	100CH ~ 109CH	8	180CH ~ 189CH
1	110CH ~ 119CH	9	190CH ~ 199CH
2	120CH ~ 129CH	A	400CH ~ 409CH
3	130CH ~ 139CH	B	410CH ~ 419CH
4	140CH ~ 149CH	C	420CH ~ 429CH
5	150CH ~ 159CH	D	430CH ~ 439CH
6	160CH ~ 169CH	E	440CH ~ 449CH
7	170CH ~ 179CH	F	450CH ~ 459CH

Relation between Machine No. and I/O Area (CS1 Series)

No.	I/O Area	No.	I/O Area
0	2000CH ~ 2009CH	8	2080CH ~ 2089CH
1	2010CH ~ 2019CH	9	2090CH ~ 2099CH
2	2020CH ~ 2029CH	A	2100CH ~ 2109CH
3	2030CH ~ 2039CH	B	2110CH ~ 2119CH
4	2040CH ~ 2049CH	C	2120CH ~ 2129CH
5	2050CH ~ 2059CH	D	2130CH ~ 2139CH
6	2060CH ~ 2069CH	E	2140CH ~ 2149CH
7	2070CH ~ 2079CH	F	2150CH ~ 2159CH

Monitoring of d4 and d5 (DM Area)

In C200H Series, DM area is allocated to the starting address registered in DM (1000 + 100 x n) and DM (1000 + 100 x n+1). (The letter n means Machine No.)

Area available for monitoring is from DM (m) to (m + 19) and from DM (k) to (k + 19). (The letters m and k mean the starting addresses.)

In CS1 Series, $m=20000 + 100 \times n$
 $k=20000 + 100 \times n + 1$

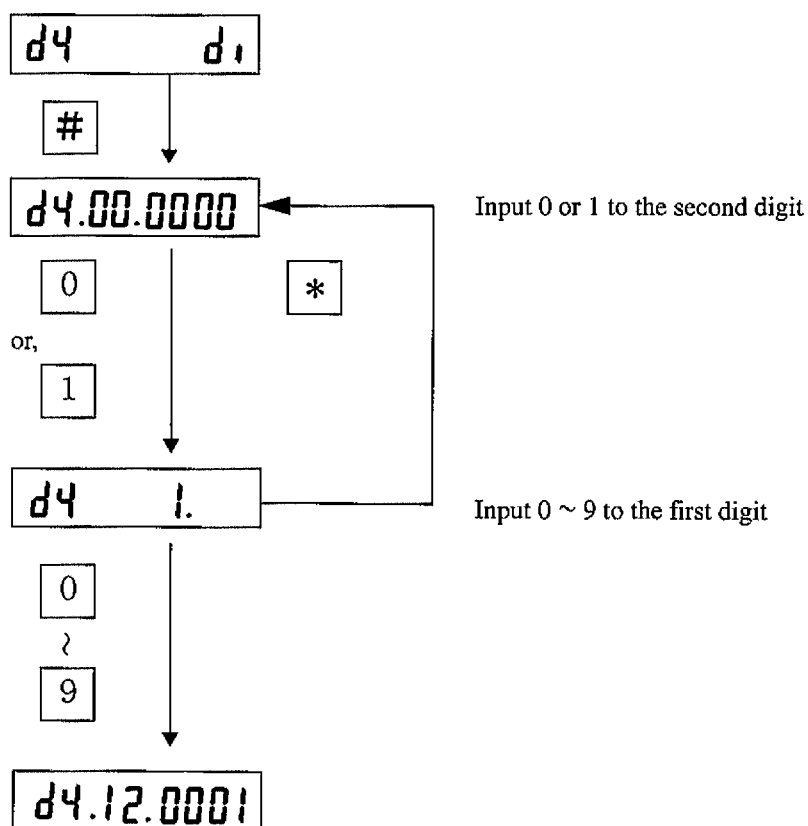

Relation between Machine No. and Starting Address Registration Area
(C200H Series)

No.	Starting Address Registration Area	No.	Starting Address Registration Area
0	DM1000、DM1001	8	DM1800、DM1801
1	DM1100、DM1101	9	DM1900、DM1901
2	DM1200、DM1201	A	DM2000、DM2001
3	DM1300、DM1301	B	DM2100、DM2101
4	DM1400、DM1401	C	DM2200、DM2201
5	DM1500、DM1501	D	DM2300、DM2301
6	DM1600、DM1601	E	DM2400、DM2401
7	DM1700、DM1701	F	DM2500、DM2501

Relation between Machine No. and Starting Address Registration Area (CS1 Series)

No.	Starting Address Registration Area	No.	Starting Address Registration Area
0	DM20000、DM20001	8	DM20800、DM20801
1	DM20100、DM20101	9	DM20900、DM20901
2	DM20200、DM20201	A	DM21000、DM21001
3	DM20300、DM20301	B	DM21100、DM21101
4	DM20400、DM20401	C	DM21200、DM21201
5	DM20500、DM20501	D	DM21300、DM21301
6	DM20600、DM20601	E	DM21400、DM21401
7	DM20700、DM20701	F	DM21500、DM21501

Reading of Setpoint

Press the [*] key to change the mode between Monitor and Setpoint.

To select a setting mode or setting function, remember to press the corresponding numerical key two times.

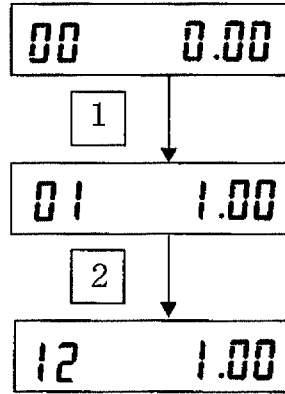

Changing of Setpoint

For setpoint values, press the [#] key to start the changing. Press the numerical keys to register a value and move through the digits. Press the [*] key to cancel the changing. After setting a changed value, remember to press the [#] key to enter the changed value.

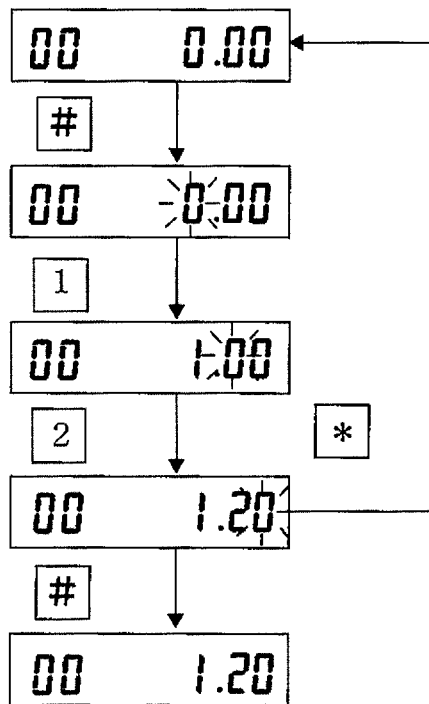

Execution of Command (In the case of zero calibration)

Press the [#] key then [#] key again to execute a command.

To cancel the command, press the [*] key.

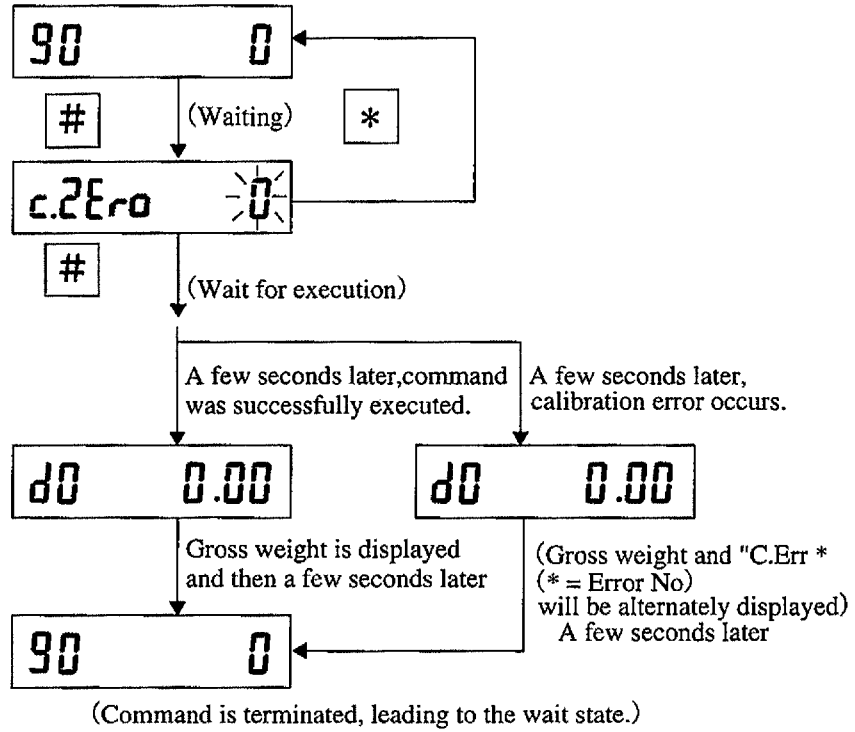

6.Available Functions

6-1. Tree chart of setting modes (Setting remote console unit)

(See Page 97 .)

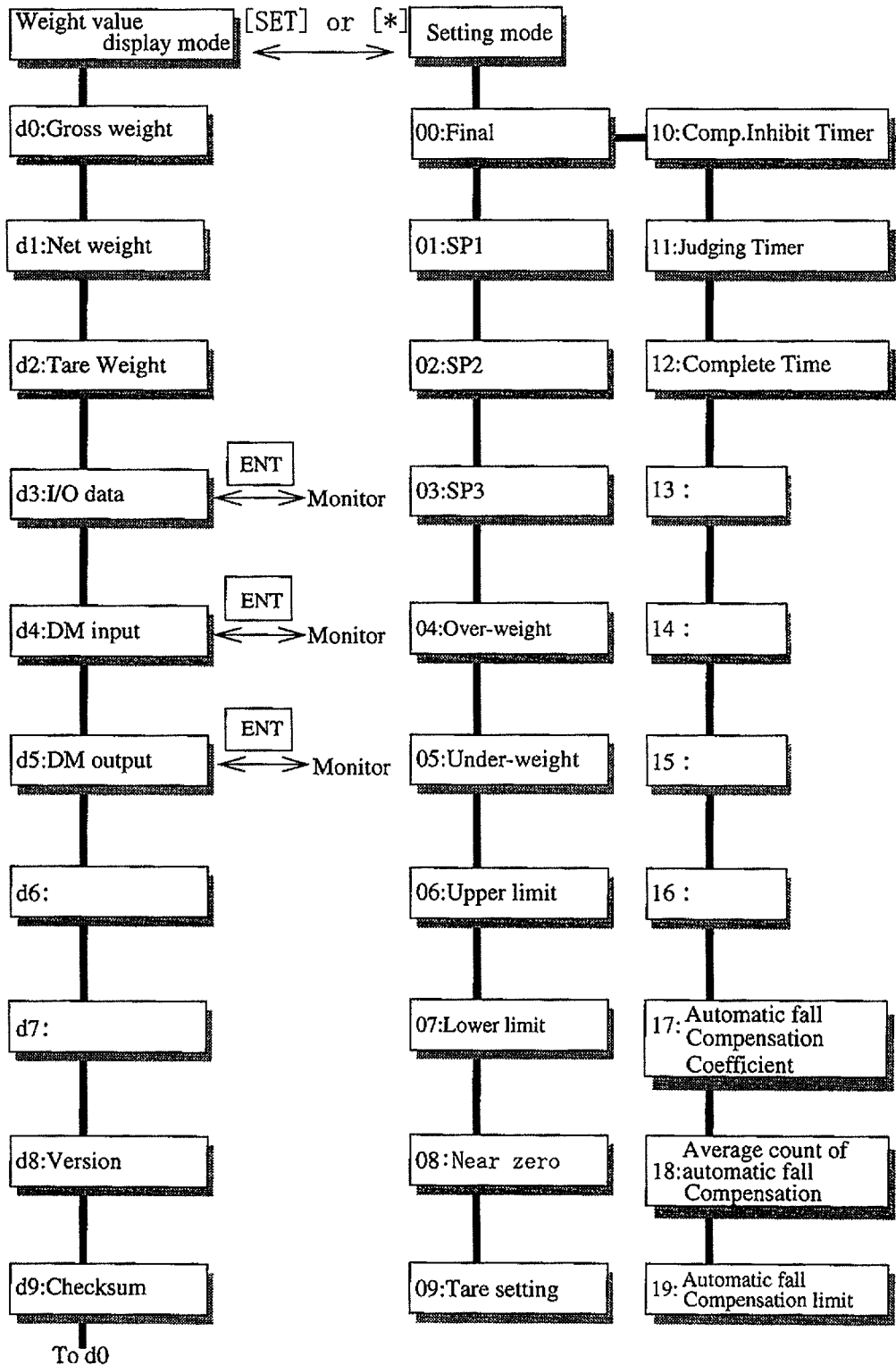

* To move along the line —, use the [▲] and [►] keys (C110 Series). To follow the line —, use the numerical keys (C120 Series).

* The flowcharts in this section 'Available Functions' assume the use of optional setting remote console unit (C110, or C120).

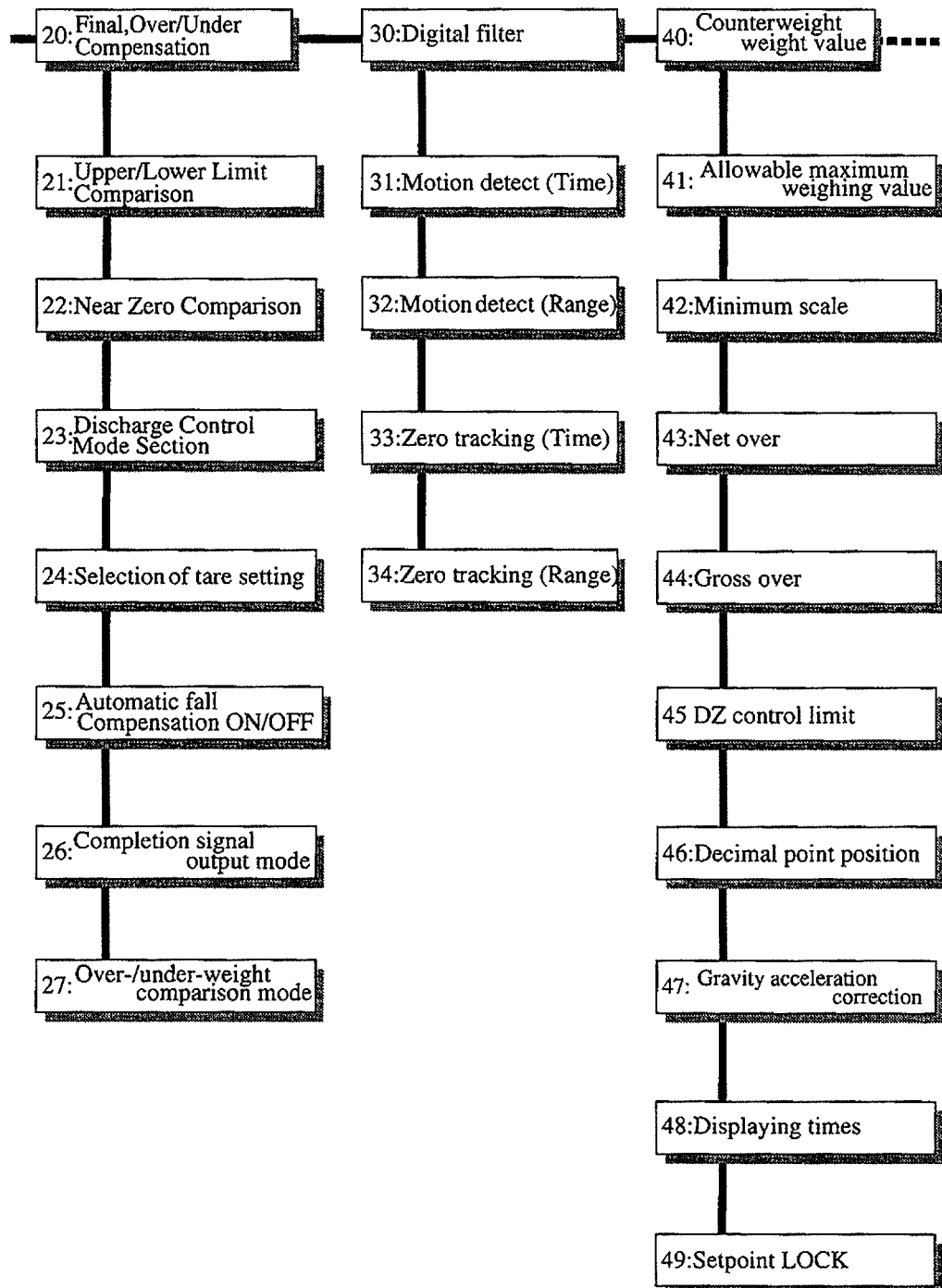

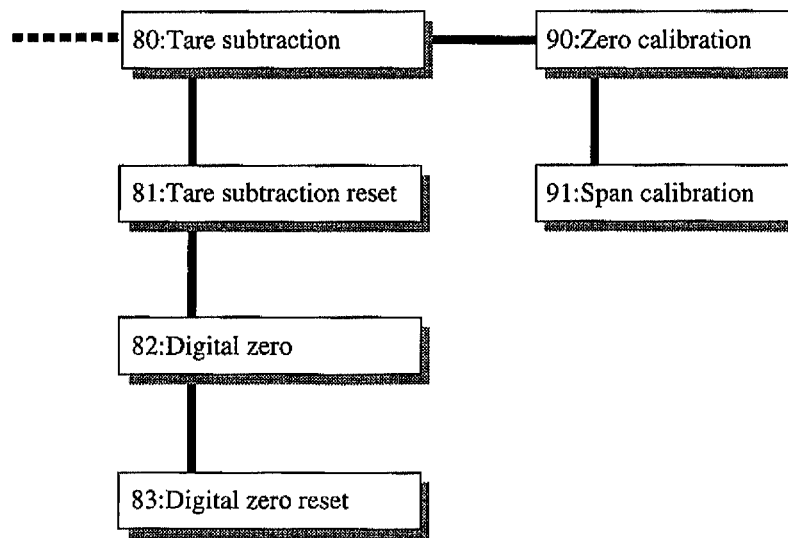

6-2. Description of individual functions

6-2-1. Tare Subtraction

This function allows clearing of net weight to zero. Gross weight remains unchanged. To set this function active, set ON the TARE ON relay or set the Tare Subtraction command.

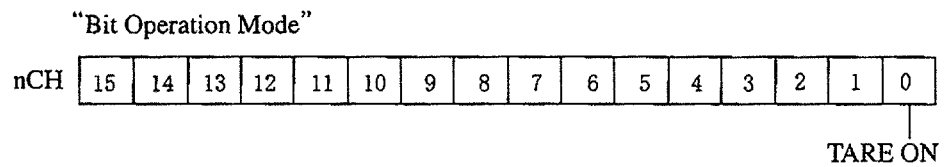

• Operation command

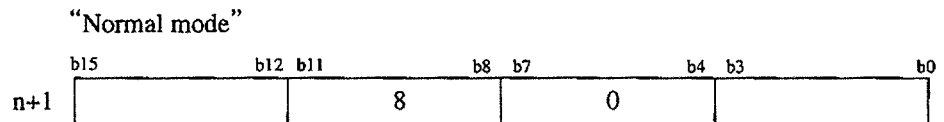

6-2-2. Tare Subtraction Reset

This function resets the tare subtraction. This function brings a net weight and a gross weight back to the same value.

To set this function active, set ON the TARE OFF relay or set the Tare Subtraction Reset command.

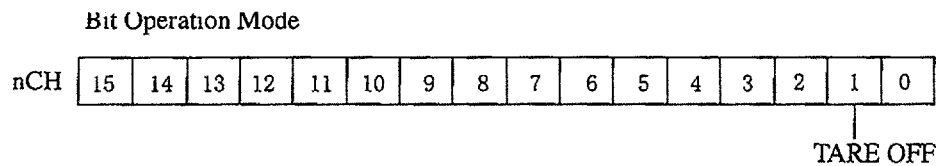

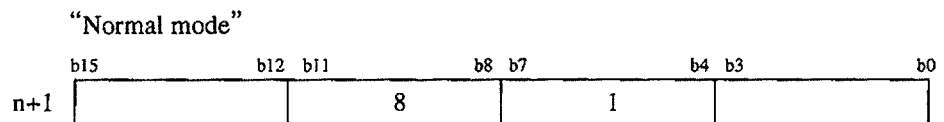

• Operation command



6-2-3. Digital Tare Subtraction

This function subtracts any predetermined tare weight value from a net weight value. To set this function active, enter a weight value in the tare weight setting field in the setting mode 0, and set active the tare weight setting in the setting mode 2.

Setting of Tare Weight

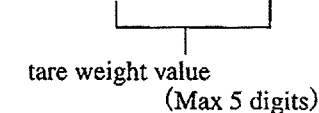
- 1) Select the setting mode 0. 
- 2) Select the setting item 9. 
- 3) Press the ENT key and enter a tare weight value. 
- 4) Remember to press the ENT key to accept the entered tare weight value. 

I/O Area

“Normal mode”

	b15	b12 b11	b8 b7	b4 b3	b0
n CH	0	0	0	0	
n+1CH		0	9	0	

Digital Tare Subtraction

- 1) Select the setting mode 2. 20 0
- 2) Select the setting item 4. 24 0
- 3) Press the ENT key and enter a Digital Tare Subtraction. 24 
- 4) Remember to press the ENT key to accept the entered tare weight value. Digital Tare Subtraction.
0:Inactive 1:Active
2:Relay Selection

I/O Area

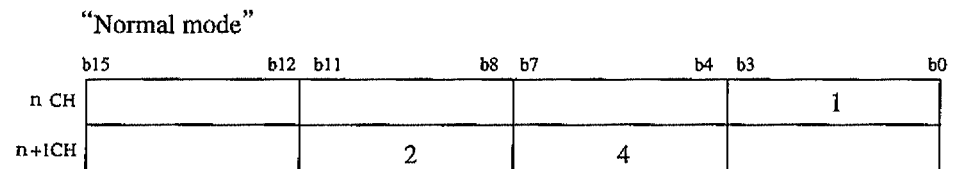

When the option 2 "Relay Selection" is selected, select an option for the "Presence / Absence of Tare Weight" in the bit 5 of bit operation mode.

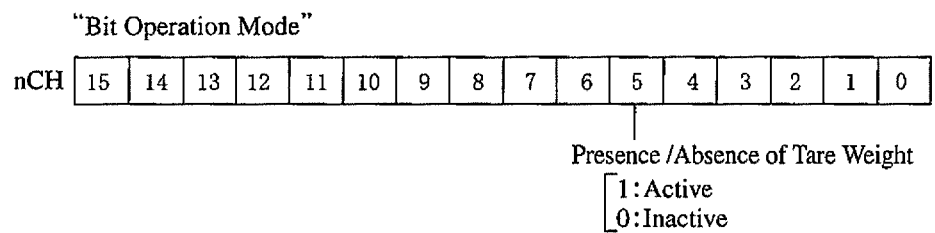

6-2-4. Digital Zero

This function automatically resets a gross weight value to zero (0). In practice, however, if this function is set active for any weight value exceeding DZ control limit specified in the setting mode 4, the status of "Zero Error" will be set ON.

Net weight value changes according to the equation (net weight) = (gross weight) - (tare weight). To set this function active, set ON the DZ ON relay or set the digital zero command.

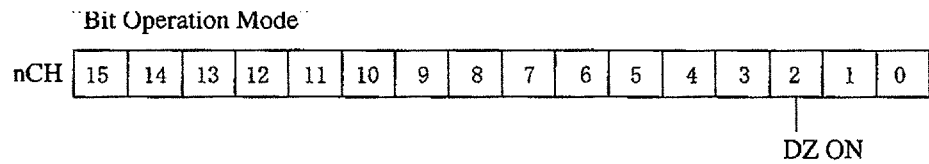

• Operation command

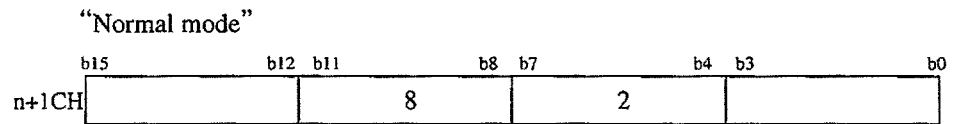

6-2-5. Digital Reset

This function resets the digital zero option. When this function is set active while the status of "Zero Error" is ON, the digital zero option will be cleared and the status of "Zero Failure" becomes OFF. To set this function active, set ON the DZ OFF relay or set the digital zero reset command.

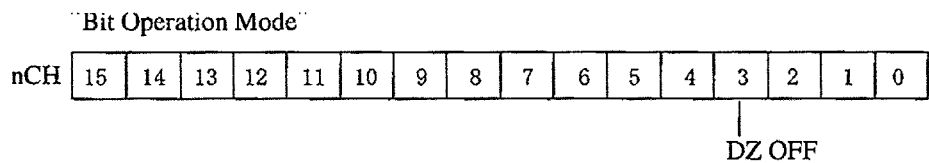

• Operation command

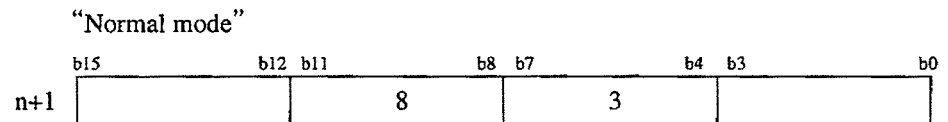

6-2-6. Motion Detect

To identify whether a weight value is stable or not, set a parameter.

When variations of any weight value fall within a predetermined range, and such condition persists for a predetermined period of time, the weight value is considered as stable, and the status of stability will be set ON.

In each A/D conversion, comparison is made between D in the diagram below and a predetermined range. When D is found larger than the predetermined width, the status of stability is set OFF.

* D means a difference between the current weight value and the 100 ms before weight value.

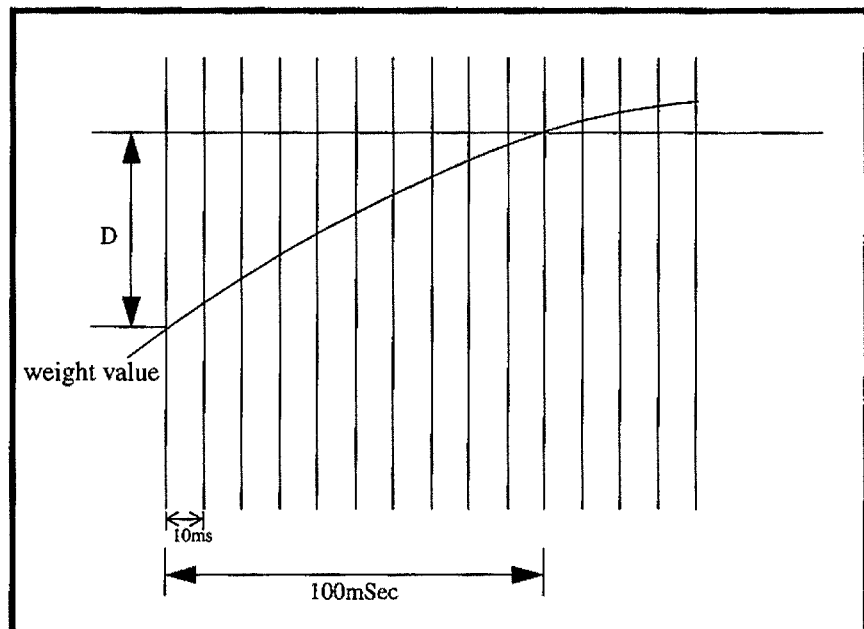

Motion Detect

1) Select the setting mode 3.

30 4

2) Select the setting item 1.

31 1.5

3) Press the ENT key and enter Motion Detect.

31 1.5

4) Remember to press the ENT key to accept the entered tare weight value.

I/O Area

“Normal mode”

	b15	b12	b11	b8	b7	b4	b3	b0
n CH						1		5
n+1CH			3		1			

6-2-7. Zero Tracking

This function automatically corrects any gradual slow zero drift or slight zero point dislocation due to weighing chips.

Zero Tracking

- 1) Select the setting mode 3. 30 4
- 2) Select the setting item 3. 33 0.0
- 3) Press the ENT key and enter Zero Tracking.
- 4) Remember to press the ENT key to accept the entered Zero Tracking. 33 0.0

I/O Area

“Normal mode”

	b15	b12	b11	b8	b7	b4	b3	b0
n CH				0				0
n+1CH			3		3			



- * The zero tracking option automatically sets to zero any zero-point dislocation smaller than a predetermined range at a specified interval.
- * Time (tracking delay) may be selected in a range of 0.1 to 9.9 seconds. Range (tracking band) may be selected in steps of 1/4 scale of weight value reading. <A setting value of 02 corresponds to 0.5 scales, and 12 to 3 scales. (A width of 4 is equivalent to one minimum scale.)> When the time is set in 0.0 second and the range in 00, the zero tracking is set disabled.

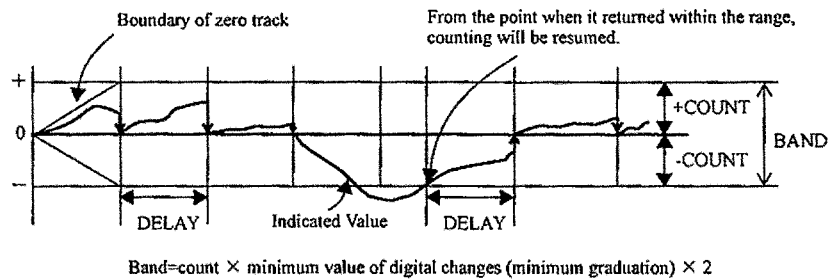

CAUTION

- * The zero tracking is designed to work even while a gross weight is zero (0), and thus it fails to work if the weight already exceeds the tracking band. Adjust the zero point by the digital zero or zero calibration.
- * If the zero correction amount (deviation from the zero calibrated point) by the digital zero and zero tracking exceeds DZ control limit, zero correction is not carried out and the status of zero error is set ON.

6-2-8. Gravitational Acceleration Correction

When a weighing machine is calibrated and installed in different places, weight error must be corrected according to different gravitational accelerations in different places. When a weighing machine is calibrated and installed in the same place, this correction is not necessary.

Identify a place number (01 - 16) for the place where the actual load calibration is to be carried out from the gravitational acceleration correction table, and enter the number before calibration under the actual load.

Then, identify the place where the weighing machine is actually installed from the table, and enter the place number. At this point of time, any difference in gravitational acceleration between the places for calibration and installation may be successfully corrected.

Gravitational Acceleration Correction

1) Select the setting mode 4. 40 100.00

2) Select the setting item 7. 47 09

3) Press the ENT key and enter Gravitational Acceleration Correction. 47 09

4) Remember to press the ENT key to accept the entered Gravitational Acceleration Correction. Gravitational Acceleration Correction

I/O Area

"Normal mode"

	b15	b12	b11	b8	b7	b4	b3	b0
n CH				0			9	
n+1CH			4		7			

01	9.806	02	9.805	03	9.804	04	9.803
05	9.802	06	9.801	07	9.800	08	9.799
09	9.798	10	9.797	11	9.796	12	9.795
13	9.794	14	9.793	15	9.792	16	9.791



Amsterdam	9.813m/s ²	Ottawa	9.806m/s ²
Athens	9.800m/s ²	Paris	9.809m/s ²
Auckland NZ	9.799m/s ²	Rio de Janeiro	9.788m/s ²
Bangkok	9.783m/s ²	Rome	9.803m/s ²
Birmingham	9.813m/s ²	San Francisco	9.800m/s ²
Brusseles	9.811m/s ²	Singapore	9.781m/s ²
Buenos Aires	9.797m/s ²	Stockholm	9.818m/s ²
Calcutta	9.788m/s ²	Sydney	9.797m/s ²
Capetown	9.796m/s ²	Taichung	9.789m/s ²
Chicago	9.803m/s ²	Tainan	9.788m/s ²
Copenhagen	9.815m/s ²	Taipei	9.790m/s ²
Cyprus	9.797m/s ²	Tokyo	9.798m/s ²
Djakarta	9.781m/s ²	Vancouver,BC	9.809m/s ²
Frankfurt	9.810m/s ²	Washington DC	9.801m/s ²
Glasgow	9.816m/s ²	Wellington NZ	9.803m/s ²
Havana	9.788m/s ²	Zurich	9.807m/s ²
Helsinki	9.819m/s ²		
Kuwait	9.793m/s ²		
Lisbon	9.801m/s ²		
London (Greenwich)	9.812m/s ²		
Los Angeles	9.796m/s ²		
Madrid	9.800m/s ²		
Manila	9.784m/s ²		
Melbourne	9.800m/s ²		
Mexico City	9.779m/s ²		
Milan	9.806m/s ²		
New York	9.802m/s ²		
Oslo	9.819m/s ²		

6-2-9. Digital Filter

This function moving-averages A/D-converted data to suppress any fluctuation of weight values. Moving-averaging may be performed two times up to 32 times. The more the times of moving-averaging, the more the weight value becomes stable, though the slower the response. On the contrary, the less the times of moving-averaging, the faster the response, though the more the weight value becomes fluctuating. Select an optimum value according to the type of weighing.

Digital Filter

- 1) Select the setting mode 3
- 2) Select the setting item 4.
- 3) Press the ENT key and enter Digital Filter.
- 4) Remember to press the ENT key to accept the entered Digital Filter.

5: 32 times	2: 4 times
4: 16 times	1: 2 times
3: 8 times	0: OFF

I/O Area

“Normal mode”

	b15	b12	b11	b8	b7	b4	b3	b0
n CH							4	
n+ICH			3		0			

6-2-10. Net Over

If a net weight or a gross weight exceeds a predetermined limit value, an alarm is provided.

Conditional expressions and available displays are listed below.

	Conditional Expression
Net Over	Net weight > Net over setpoint
Gross Over	Gross weight > Gross over setpoint

Net Over

1) Select the setting mode 4. 40 100.00

2) Select the setting item 3. 43 999.99

3) Press the ENT key and enter Net Over.

4) Remember to press the ENT key to accept the entered Net Over. 43 ~~999.99~~

Net Over weight values
(Max 5 digits)

I/O Area

“Normal mode”

	b15	b12	b11	b8	b7	b4	b3	b0
n CH	9		9		9		9	
n+1CH			4		3		9	

6-2-11. Gross Over

Gross Over

- 1) Select the setting mode 4. 40 100.00
- 2) Select the setting item 4. 44 999.99
- 3) Press the ENT key and enter Net Over. 44 ~~999.99~~
- 4) Remember to press the ENT key to accept the entered Net Over.

Net Over weight values
(Max 5 digits)

I/O Area

"Normal mode"

	b15	b12	b11	b8	b7	b4	b3	b0
n CH	9		9		9		9	
n+1CH			4		4		9	

6-2-12. Feed / Discharge Control Mode

■ Selection of Feed / Discharge Control

The Feed / Discharge control is intended to feed / Discharge raw materials in sequence at a fixed quantity from a tank in a hopper.

Accurate feed / Discharge of a fixed quantity may be available by a proper combination of control setting of final, SP2, SP1, or SP3, evaluation setting of over, under, or correct, and timer setting of disabled comparison or evaluation.

Feed / Discharge is available in two methods, weighing at feed and weighing at discharge.

Cutout Control

1) Select the setting mode 2. 29 0

2) Select the setting item 3. 23 0

3) Press the ENT key to set a Feed / Discharge Control. 23 0

4) Remember to press the ENT key to accept the entered Feed / Discharge control.

Feed / Discharge Control

2 : Relay Selection

1 : Discharge Control

0 : Feed Control

I/O Area

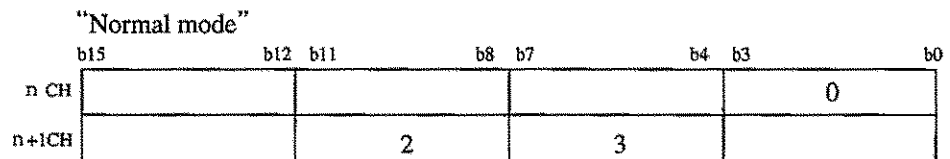

When the option 2 "relay Selection" is selected, select an option for the bit 6 "Selection of Feed or Discharge." in the bit operation mode.

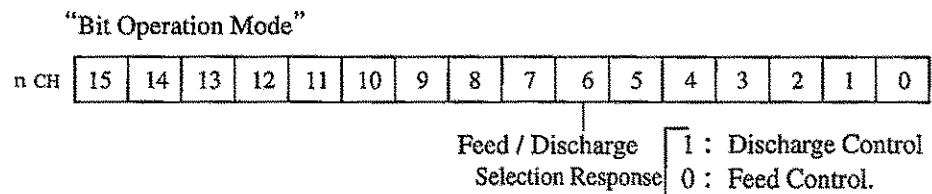

6-2-13. Final / SP1 / SP2 / SP3 / Over-Weight / Under-Weight

There are many options available for control or evaluation of fixed quantity cutout.

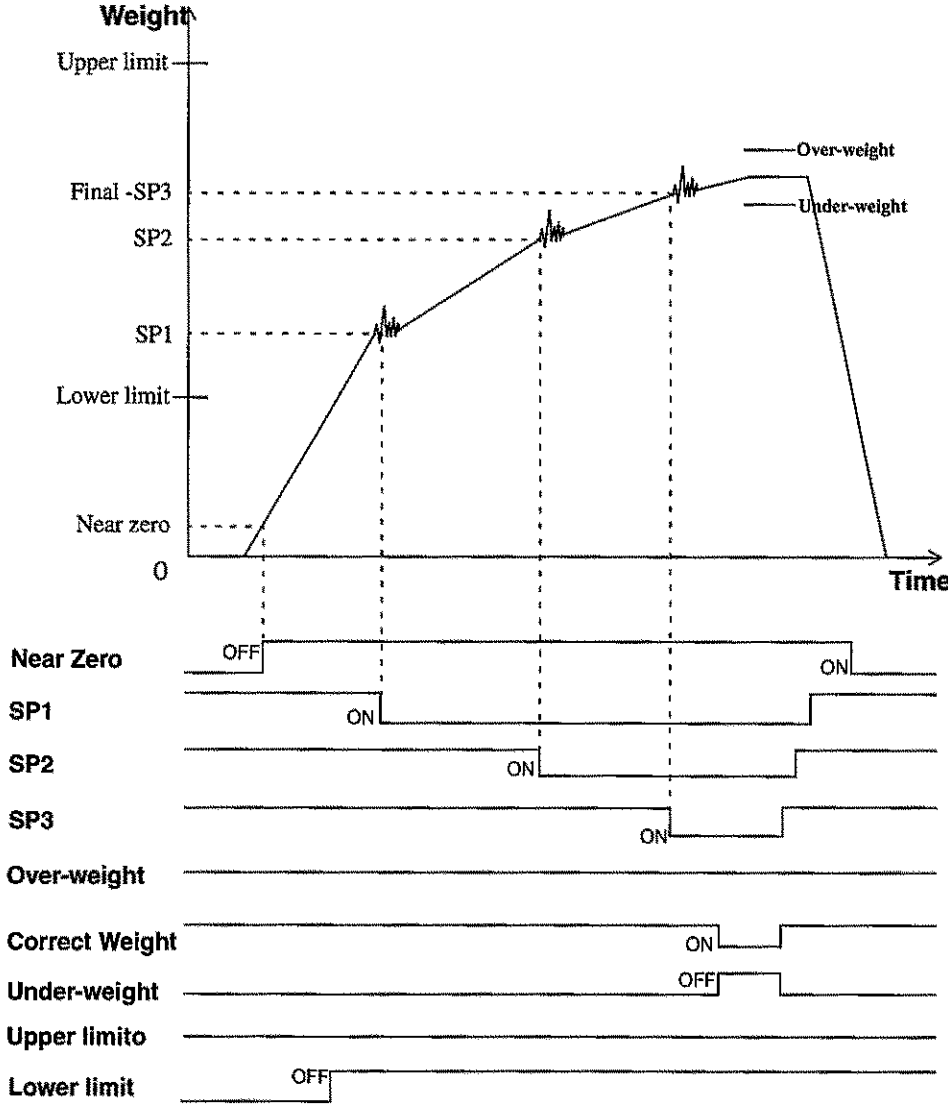

Fixed Quantity Cutout Setpoint

Setting	Equation for Evaluation
Near zero	Weight value \leq Near zero setpoint
SP1 output	value \geq Final setpoint - SP1 setpoint
SP2 output	Weight value \geq Final setpoint - SP2 setpoint
SP3 output	Weight value \geq Final setpoint - SP3 setpoint
Underweight	Weight value $<$ Fixed quantity setpoint - Underweight setpoint
Overweight	Weight value $>$ Fixed quantity setpoint + Overweight setpoint
Correct weight	Fixed quantity setpoint + Overweight setpoint \geq Weight value \geq Fixed quantity setpoint - Underweight setpoint
Upper limit	Weight value $>$ Upper limit setpoint
Lower limit	Weight value $<$ Lower limit setpoint

Final / SP1 / SP2 / SP3 / Over-Weight / Under-Weight

1) Select the setting mode 0.

00 000.00

2) Setting item0

Setting item1 00 000.00 Final

Setting item2 01 000.00 SP1

Setting item3 02 000.00 SP2

Setting item4 03 00.00 SP3

Setting item5

3) Press the ENT key and enter setting.

04 0.00 Over-Weight

05 0.00 Under-Weight

4)Remember to press the ENT key to accept the entered setting.

I/Oalles

"Normal mode"

	b15	b12	b11	b8	b7	b4	b3	b0
n CH	0		0		0		0	
n+1CH			0		0		0	

(Example:Final)

6-2-14. Upper Limit / Lower Limit / Near Zero

Upper Limit / Lower Limit / Near Zero

1) Select the setting mode 0. 00 000.00

2) setting item 6 06 000.00 Upper Limit
 setting item 7
 setting item 8 07 000.00 Lower Limit

3) Press the ENT key and enter those setting. 08 000.00 Near Zero

4) Remember to press the ENT key to accept the entered those setting.

I/O Area

“Normal mode”

	b15	b12	b11	b8	b7	b4	b3	b0
n CH	0		0		0		0	
n+1CH			0		6		0	

(Example:Upper Limit)

6-2-15. Final & Under- and Over-Weight Comparison Weight / Upper and Lower Limits Comparison Weight / Near Zero Comparison Weight

For comparison points for Fianl, reference weight (gross weight or net weight) and timing may be selected. Four options are available as listed below.

- 1) Reference weight value for Fianl and over/under comparison
Select a reference weight value for comparison of Fianl and over/under weight. (Setting mode 2-0)
- 2) Reference weight value for upper and lower limit comparison
Select a reference weight value for comparison of upper and lower limits. (Setting mode 2-1)
- 3) Reference weight value for near zero comparison
Select a reference weight value for comparison of near zero. (Setting mode 2-2)
- 4) Under/over comparison mode
Select the timing at which under/over comparison is carried out. (Setting mode 2-7)

Final & Under- and Over-Weight Comparison Weight / Upper and Lower Limits Comparison Weight / Near Zero Comparison Weight

- 1) Select the setting mode 2. 20 0
- 2) Select the setting item 0 or 1 or 2. 20 0
- 3) Press the ENT key and set those setting. 20 0
- 4) Remember to press the ENT key to accept theset those setting.

21 0

Reference weight value for upper and lower limit comparison

2 : Reference OFF
1 : Net Weight
0 : Gross Weight

23 0

Reference weight value for near zero comparison

2 : Reference OFF
1 : Net Weight
0 : Gross Weight

Final & Under- and Over-Weight Comparison

2 : Reference OFF
1 : Net Weight
0 : Gross Weight

I/O Area

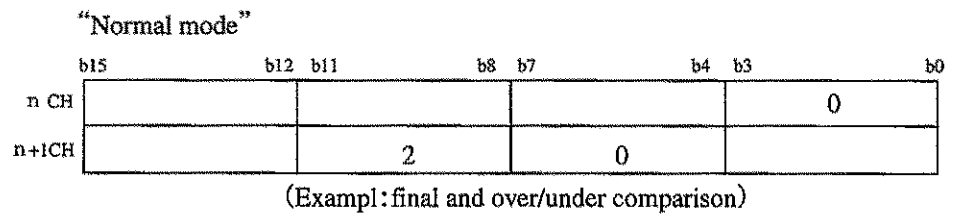

6-2-16. Under- and Over-Weight Comparison Mode

Under- and Over-Weight Comparison Mode

1) Select the setting mode 2. 20 0

2) Select the setting item 7 27 0

3) Press the key to set a Comparison Mode 27 0

4) Remember to press the ENT key to accept the set Under- and Over Weight Comparison Mode.

Over/Under Comparison Mode

3: Comparison is made with the completion output set ON, while holding weight values.

2: Relay evaluation

1: Comparison is made with the completion output set ON.

0: Comparison is consistently made.

I/O Area

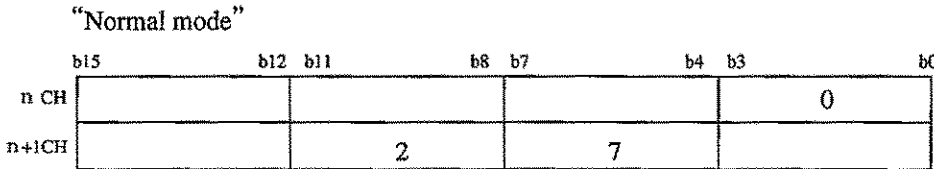

When the option 2 "Relay Evaluation" is selected, select an option for the bit 9 "Over/Under Evaluation" in the bit operation mode.

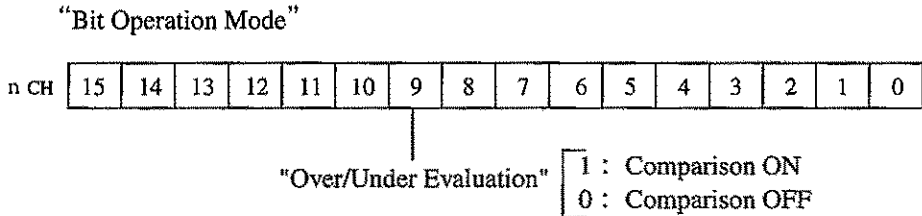

6-2-17. Comparison Inhibit Timer / Judging Timer / Completion Timer

Comparison OFF Timer / Judging Time

Comparison may be set disabled for a certain period of time to prevent any incorrect control or judging due to the vibration of mechanical system resulting from valve opening/closing.

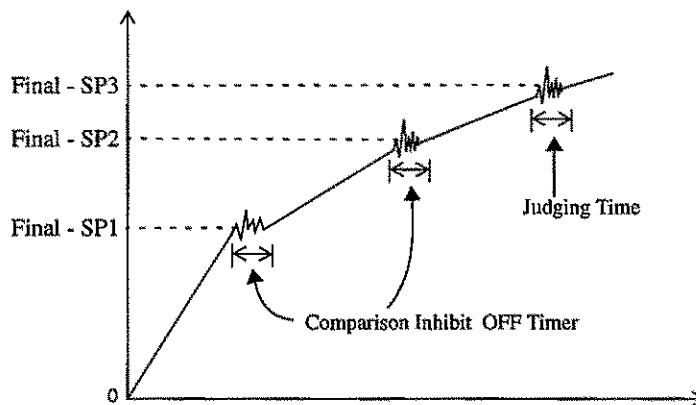

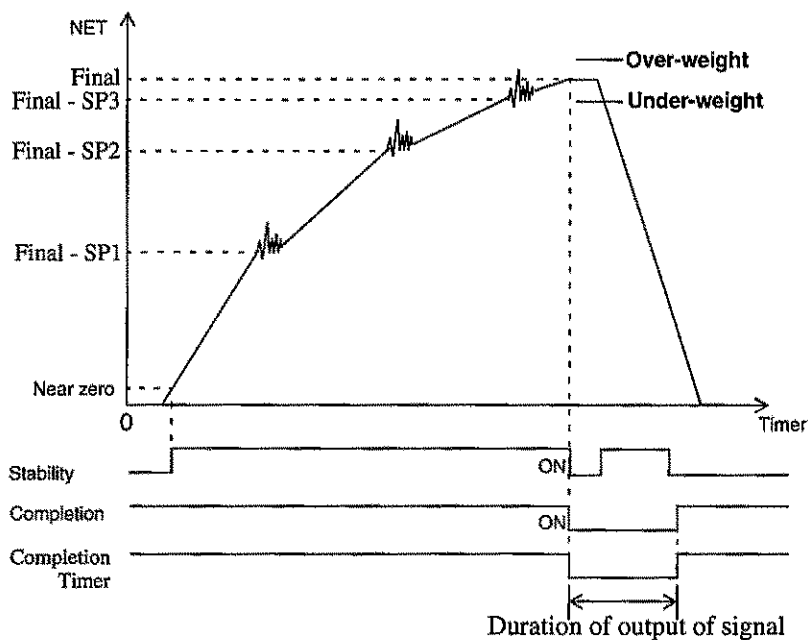

Completion Timer

The duration of output of completion signal (completion relay) provided at the end of weighing may be selected.

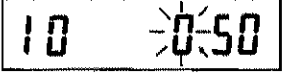

Comparison OFF Timer

- 1) Select the setting mode 1. 
- 2) Select the setting item 0. 
- 3) Press the ENT key and enter Comparison OFF Timer. 
- 4) Remember to press the ENT key to accept the entered Comparison OFF Timer.

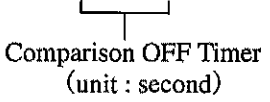

 Comparison OFF Timer
 (unit : second)

I/O Area

“Normal mode”

	b15	b12	b11	b8	b7	b4	b3	b0
n CH			0			5		0
n+1CH			1			0		

Judging Timer / Completion Timer

1) Select the setting mode 1. 10 0.50

2) Select the setting item 1 or 2. 11 1.50

3) Press the ENT key and enter those setting. 11 1.50
Judging Timer (unit : second)

4) Remember to press the ENT key to accept the entered those setting. 12 1.50
completion Timer

I/O Area

“Normal mode”

	b15	b12	b11	b8	b7	b4	b3	b0
n CH			1			5		0
n+1CH			1			1		

6-2-18. Completion Output Mode

Select the timing to output the completion signal.

For selection of timing, two parameters are involved, judging timer and stability signal.

Completion Output Mode

- 1) Select the setting mode 2. 20 0.50
- 2) Select the setting item 6. 26 0
- 3) Press the ENT key to set a Completion Output Mode. 26 0
- 4) Remember to press the ENT key to accept the entered a Completion Output Mode.

Completion Output Mode 0

2: Only the completion timer is output after the SP3 signal is set ON and a preset time has elapsed in the evaluation timer, or after weight values become stable.

1: Only the completion timer is output after the SP3 signal is set ON and a preset time has elapsed in the evaluation timer and weight values become stable.

0: Only the completion timer is output after the SP3 signal is set ON and a preset time has elapsed in the evaluation timer.

I/O Area

“Normal mode”

	b15	b12 b11	b8 b7	b4 b3	b0
n CH				0	
n+1CH		2	6		

6-2-19. Automatic Fall Compensation / Automatic Fall Compensation Control Value / Automatic Fall - CompensationTimes / Automatic fall Compensation Coefficient

The automatic fall compensation option is intended to automatically correct any variation in fall, one of the major causes of weighing error, for accurate weighing. This section describes the setting of parameters for the automatic fall compensation.

Principle of Automatic Fall Compensation

Difference (D) between a preset fixed quantity value and the actual weighed values is recorded (predetermined) times (A) to obtain an average value. The value obtained by multiplying the average value by a correction coefficient (C) is added or subtracted to/ from difference setpoint.

$$\text{Value added / subtracted to / from fall setpoint} = \frac{(D1 + D2 + D3 \cdots DA)}{A} \times C$$

To minimize possible error, a control limit may be preset for the value D (D1, D2, D3, ...DA).

Example) Final setpoint: 20.000
 Automatic fall compensation limit: 0.100
 Automatic fall compensation times: 4
 Automatic fall compensation coefficient: 2/4

Weighing times	Actual weighed value	Weighing error	Fall correction counter	Difference
0			0	← At power-on sequence
1	20.050	+0.050	1	0.500
2	20.040	+0.040	2	0.500
3	20.070	+0.070	3	0.500
4	20.080	+0.080	4 → 0	0.500
		$+0.240/4 = 0.060$		
		$0.060 \times 2/4 = 0.030$		→ Correction calculated value
5	20.020	+0.020	1	0.530
6	20.000	0.000	2	0.530
7	20.010	+0.010	3	0.530
8	20.110	(+0.110)	← × 3	0.530
9	20.010	+0.010	4 → 0	0.530
		$+0.040/4 = 0.010$		
		$0.010 \times 2/4 = 0.005$		→ Correction calculated value
10	19.880	(-0.120)	← × 1	0.535
11	19.990	-0.010	1	0.535
12	20.010	+0.010	2	0.535
13	20.000	0.000	3	0.535
14	19.980	0.020	4 → 0	0.535
		$-0.020/4 = -0.005$		
		$-0.005 \times 2/4 = -0.003$		→ Correction calculated value
				0.532



Selection of Automatic Fall Compensation Coefficient

Automatic fall compensation coefficient may be selected among 1/4, 2/4, 3/4, and 1.

For determination of difference correction value at a greater accuracy, select 1 for the weighing in which almost consistent weight values are obtained every weighing cycle, or select 1/4 or 2/4 for the weighing involving varying weight values in different weighing sequences.

◇ Selection of Automatic Fall Compensation Parameters

Setting mode 2-5 Automatic fall compensation ON/OFF

Select whether or not the automatic difference correction function is used.

Setting mode 1-9 Automatic fall compensation control limit

Set a control limit to prevent a possibility of extremely large (or small) correction value.

Setting mode 1-8 Automatic fall compensation times

Set the number of times of recording of weight values for determination of an average value.

Setting mode 1-7 Automatic fall compensation coefficient

Select a factor smaller than unit for multiplication to prevent any varying correction value.

Automatic Difference / Automatic Difference Times / Automatic Difference Fact

1) Select the setting mode 1. 10 0.50

2) Select the setting item 7 or 8 or 9. 17 0

3) Press the ENT key and enter those setting. 17 0

4) Remember to press the ENT key to accept the entered those setting.

17 0

Automatic fall coefficient

3 : 1 1 : 2/4

2 : 3/4 0 : 1/4

18 4

Automatic fall Times

0 ~ 9

19 098.00

Automatic fall Control Value
(00000 ~ 99999)

I/O Area

“Normal mode”

	b15	b12	b11	b8	b7	b4	b3	b0
n CH								0
n+ICH			1		7			

(Exempl: Automatic fall compensation coefficient)

Automatic Fall Compensation ON/OFF

1) Select the setting mode 2. 20 0

1) Select the setting mode 5. 25 1

3) Press the ENT key and enter Automatic fall compensation ON/OFF 25 

4) Remember to press the ENT key to accept the set Automatic fall compensation ON/OFF. 25 1

Automatic fall compensation

2 : Relay Selection

1 : ON

0 : OFF

When the option 2 "Relay Selection" is selected, set an option in the bit 8 "Presence/Absence of Automatic Difference" in the bit operation mode.

“Bit Operation Mode”

n CH	15	14	13	12	11	10	9	8	7	6	5	4	3	2	1	0
------	----	----	----	----	----	----	---	---	---	---	---	---	---	---	---	---

Automatic fall compensation ON/OFF

1 : ON
0 : OFF

7 .Timing Chart

7-1. Reading setpoint (Address for Machine No.0 in C200H Series)

“In the normal mode ”

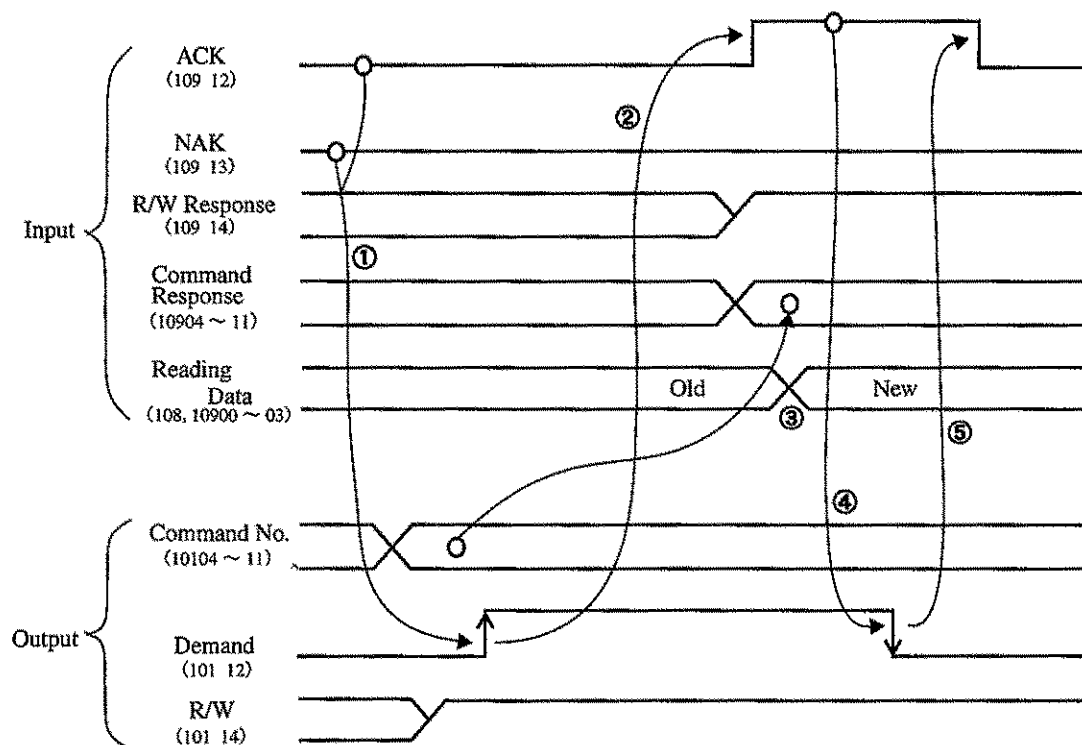

- ① Check that ACK and NAK are both set OFF, and then set Command No. and R/W and set ON Demand.
- ② Keep setting ON Demand until ACK becomes ON.
- ③ When ACK is set ON, data appears in Reading Data.
- ④ After ACK is set ON, set OFF Demand.
- ⑤ When Demand is set OFF, ACK will be set OFF.

7-2. Writing setpoint and operating instructions

“In the normal mode ”

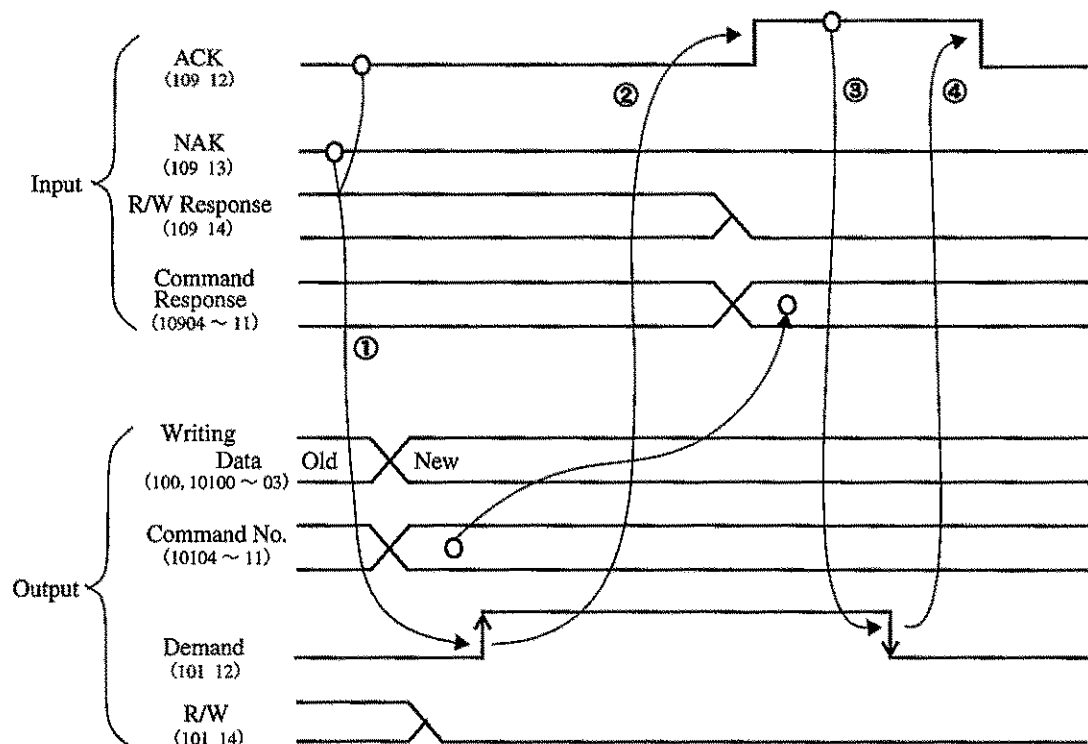

- ① Check that ACK and NAK are both set OFF, and then set Command No., Writing Data, and R/W and set ON Demand.
- ② Keep setting ON Demand until ACK becomes ON.
- ③ After ACK is set ON, set OFF Demand.
- ④ When Demand is set OFF, ACK will be set OFF.

7-3. Bit operation (Tare Subtraction)

"In the normal mode"

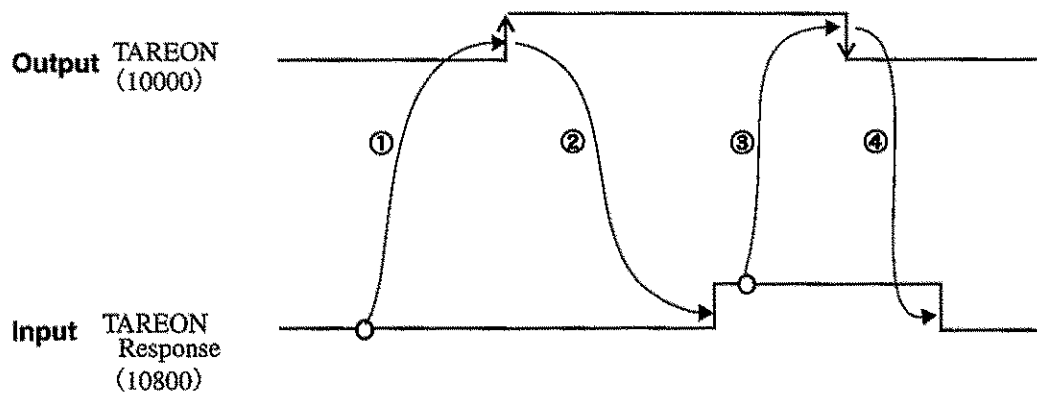

- ① Check that TAREON is set OFF, and set ON TAREON.
- ② Keep setting ON TAREON until ON response is available.
- ③ After ON response is available, set OFF TAREON.
- ④ After TAREON is set OFF, the response will be also set OFF.

8. Ladder Chart

A checking sample is shown below for writing and reading of fixed quantity value using Demand and Response (on the assumption that No.0 Machine, MD0 and MD1 are set OFF). (C200H Series)

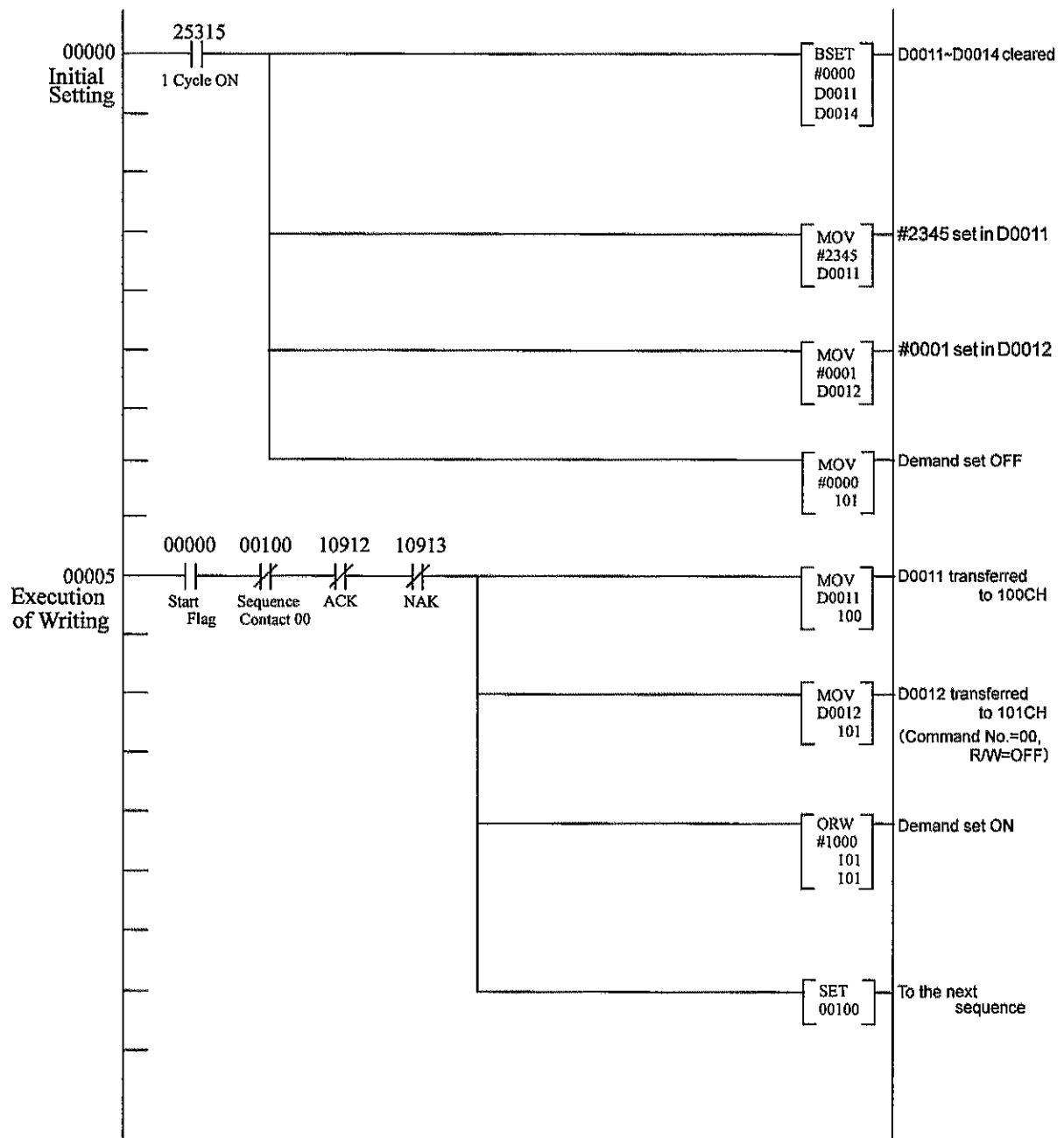

8.Ladder Chart

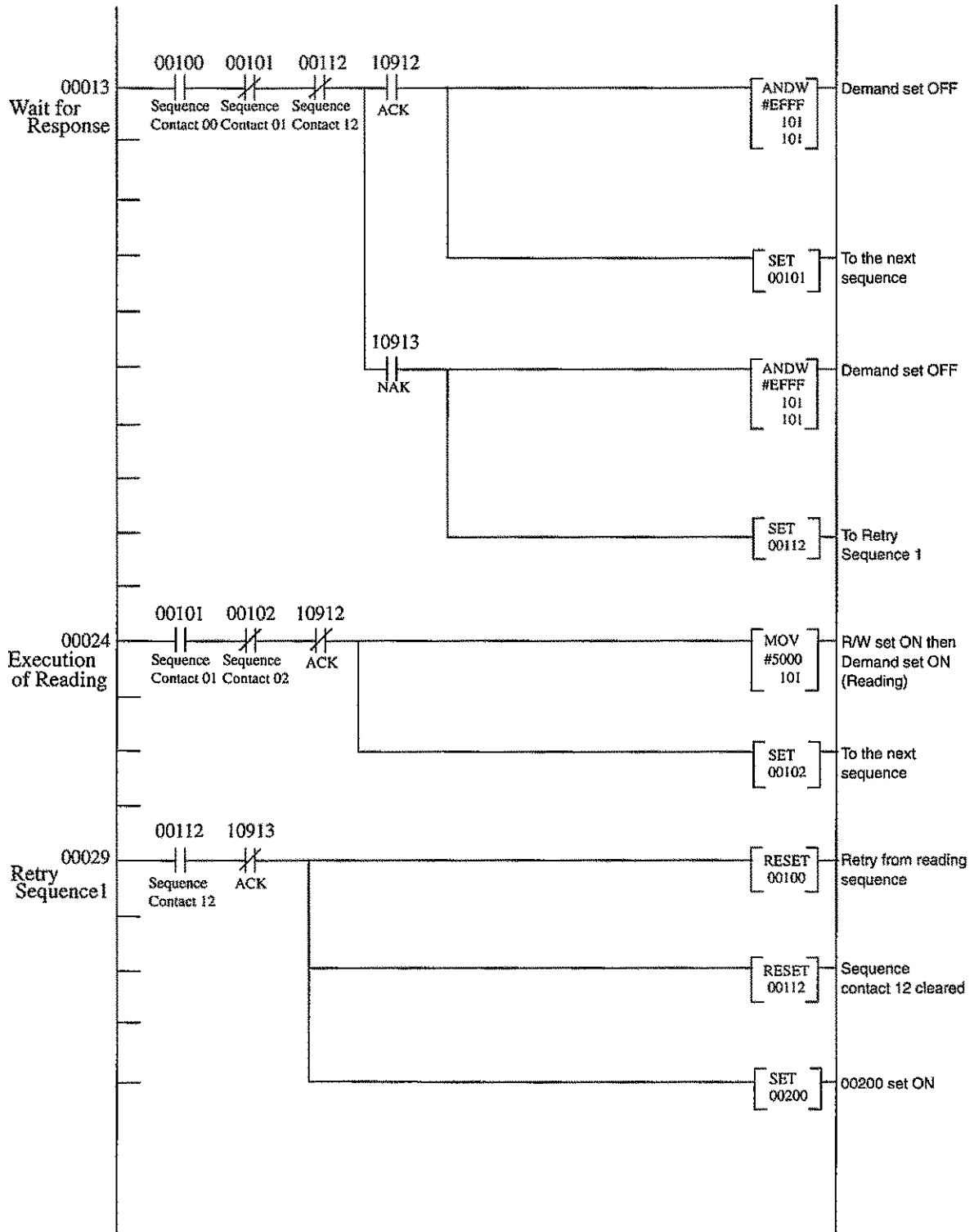

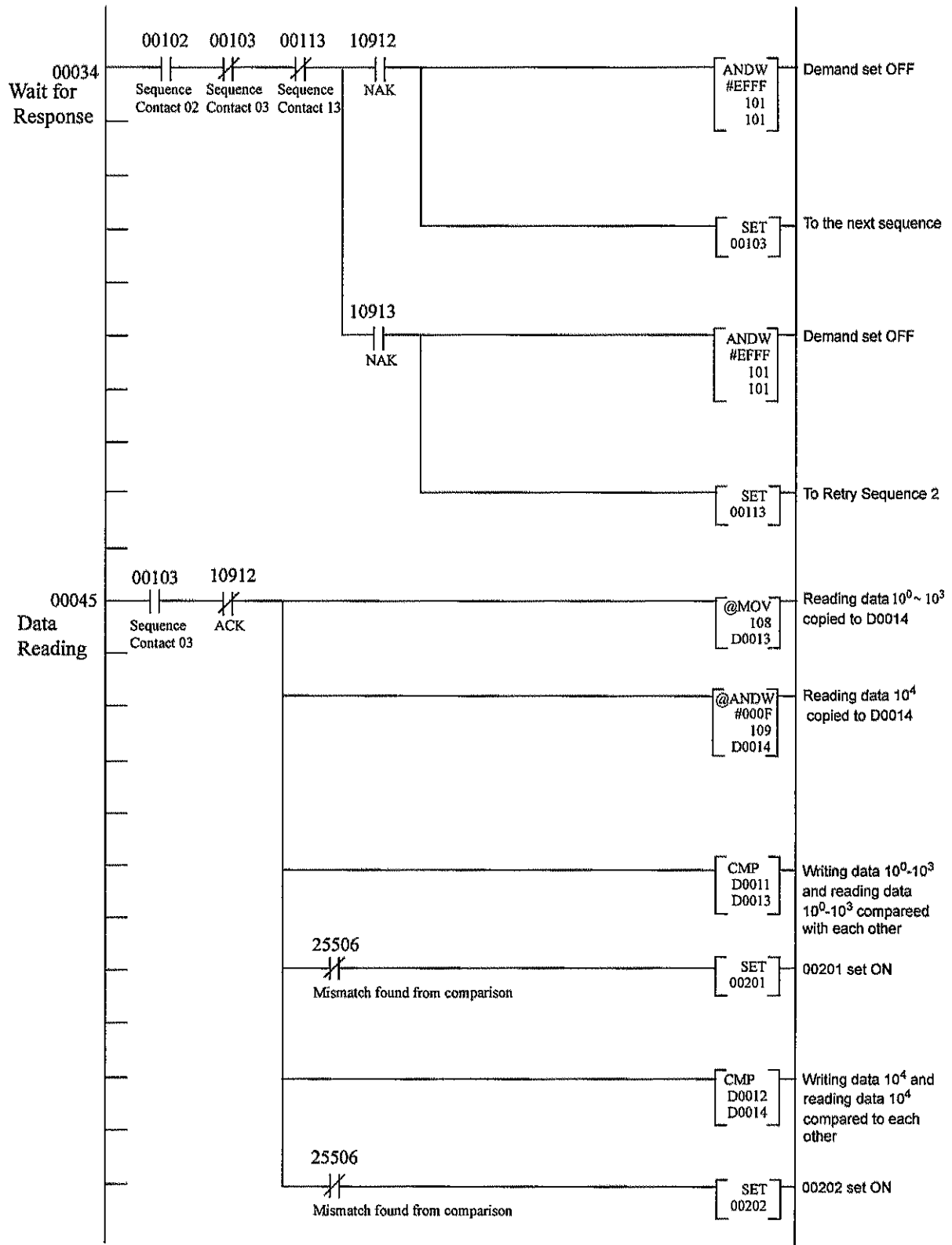

8.Ladder Chart

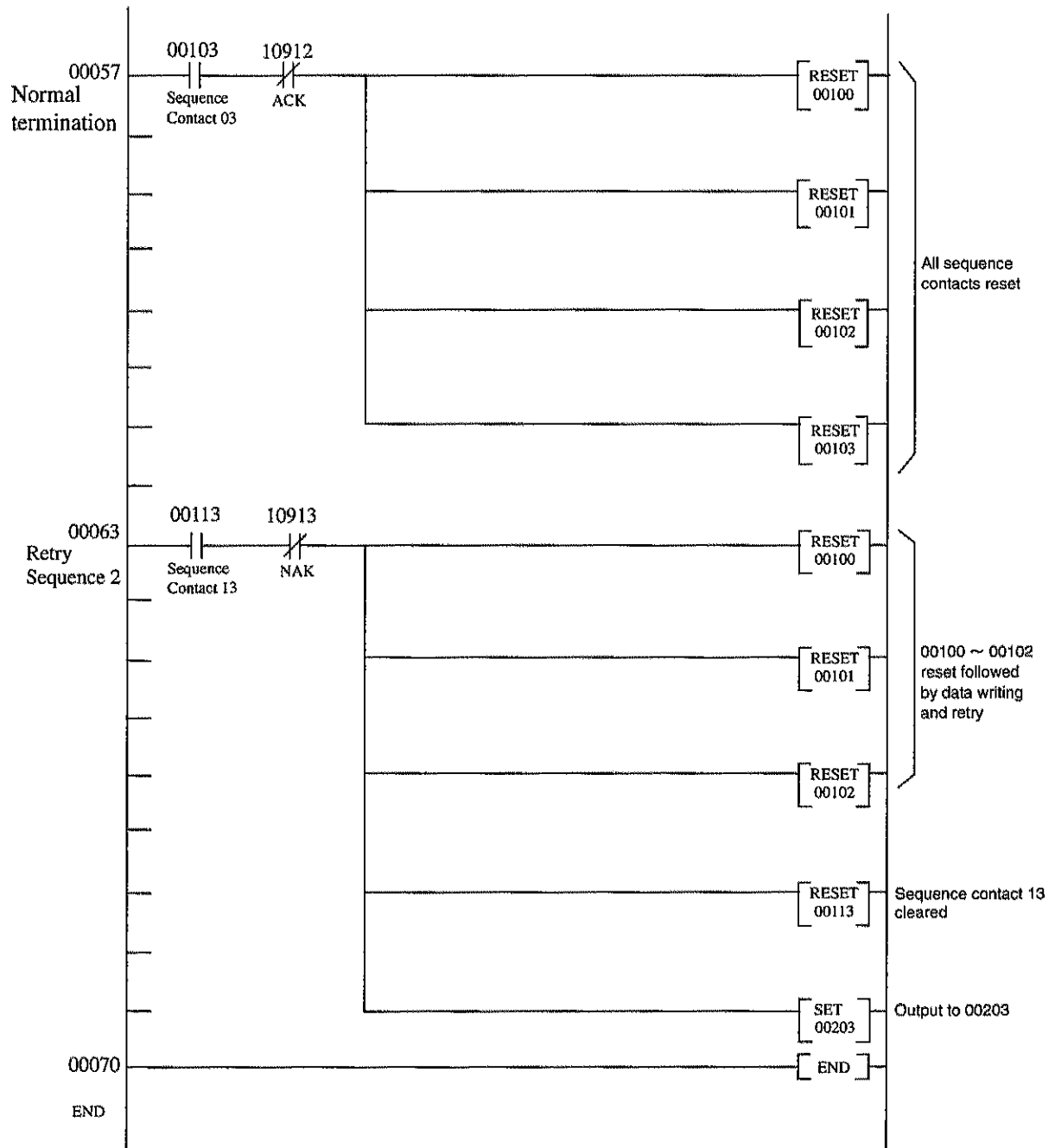

Sample Program Relay Assignment List

Channel No.	bit	USE
000	00	Conditions for Execution
001	00	Sequence Contact 00
001	01	Sequence Contact 01
001	02	Sequence Contact 02
001	03	Sequence Contact 03
001	12	Sequence Contact 12
001	13	Sequence Contact 13
002	00	Writing Error (Unusual Reply)
002	01	Writing / Reading Error (CMP Error)
002	02	Writing / Reading Error (CMP Error)
002	03	Reading Error (Unusual Reply)
D0011		Writing Data 1 (10 ⁰ to 10 ³)
D0012		Writing Data 2 (10 ⁴)
D0013		Reading Data 1 (10 ⁰ to 10 ³)
D0014		Reading Data 2 (10 ⁴)

9. List of Console Settings

◇ Setting Mode 0

Item	Name	Initial Value	SOFT LOCK	LOCKSW	Display Only
0	Final	000.00			
1	SP1	000.00			
2	SP2	000.00			
3	SP3	00.00			
4	Overweight	0.00			
5	Underweight	0.00			
6	Upper limit	000.00			
7	Lower limit	000.00			
8	Near zero	000.00			
9	Tare setting	000.00			

◇ Setting Mode 1

Item	Name	Initial Value	SOFT LOCK	LOCKSW	Display Only
0	Comparison inhibit time	0.50	○		
1	Judging time	1.50	○		
2	Completion time	3.00	○		
3		0			○
4		0			○
5		0			○
6		0			○
7	Automatic fall compensation coefficient	0	○		
8	Automatic fall compensation averaging times	4	○		
9	Automatic fall compensation limit	098.00	○		

◇ Setting Mode 2

Item	Name	Initial Value	SOFT LOCK	LOCK SW	Display only
0	Selection of comparisons for final and over/under	0	<input type="radio"/>		
1	Selection of comparison for upper/lower limits	0	<input type="radio"/>		
2	Selection of comparison for near zeros	0	<input type="radio"/>		
3	Feed/Discharge control mode	0	<input type="radio"/>		
4	Selection of tare weight setting	0	<input type="radio"/>		
5	Presence/absence of automatic fall compensation	1	<input type="radio"/>		
6	Completion signal output mode	0	<input type="radio"/>		
7	Over/under comparison mode	0	<input type="radio"/>		
8		0			<input type="radio"/>
9		0			<input type="radio"/>

◇ Setting Mode 3

Item	Name	Initial Value	SOFT LOCK	LOCK SW	Display only
0	Digital filter	4	<input type="radio"/>		
1	Motion detect (Time)	1.5	<input type="radio"/>		
2	Motion detect (Range)	10	<input type="radio"/>		
3	Zero tracking (Time)	0.0	<input type="radio"/>		
4	Zero tracking (Range)	00	<input type="radio"/>		
5		0			<input type="radio"/>
6		0			<input type="radio"/>
7		0			<input type="radio"/>
8		0			<input type="radio"/>
9		0			<input type="radio"/>

◇ Setting Mode 4

Item	Name	Initial Value	SOFT LOCK	LOCKSW	Display only
0	Counterweight weight value	100.00	<input type="radio"/>	<input type="radio"/>	
1	Allowable maximum weighing value (Capacity)	100.00	<input type="radio"/>	<input type="radio"/>	
2	Minimum scale	0.01	<input type="radio"/>	<input type="radio"/>	
3	Net over	999.99	<input type="radio"/>	<input type="radio"/>	
4	Gross over	999.99	<input type="radio"/>	<input type="radio"/>	
5	DZ control limit	02.00	<input type="radio"/>	<input type="radio"/>	
6	Decimal point position	2	<input type="radio"/>	<input type="radio"/>	
7	Gravitational acceleration correction	09	<input type="radio"/>	<input type="radio"/>	
8	Displaying times	3	<input type="radio"/>		
9	Setpoint LOCK (SOFT LOCK)	0		<input type="radio"/>	

◇ Setting Mode 8

Item	Name	Initial Value	SOFT LOCK	LOCKSW	Display only
0	Tare subtraction	-----			Instruction
1	Tare subtraction reset	-----			Instruction
2	Digital zero	-----			Instruction
3	Digital zero reset	-----			Instruction
4		0			<input type="radio"/>
5		0			<input type="radio"/>
6		0			<input type="radio"/>
7		0			<input type="radio"/>
8		0			<input type="radio"/>
9		0			<input type="radio"/>

◇ Setting Mode 9

Item	Name	初期値	Initial Value	LOCKSW	Display only
0	Zero calibration	-----	○	○	Instruction
1	Span calibration	-----	○	○	Instruction
2		0			○
3		0			○
4		0			○
5		0			○
6		0			○
7		0			○
8		0			○
9		0			○

※ LOCKSW means No.8 of DIP Switch on the rear. When this Switch is set ON, LOCK becomes active. SOFT LOCK means "Setpoint LOCK" in the setting mode 4-9. When this is set in "1," LOCK is set active.

9-1. List of available ranges for settings

◇ Setting Mode 0

Set Point		Command	Nnumber of digits
0.Final	00000 ~ 99999	00H	5digits with decimals
1.SP1	00000 ~ 99999	01H	5digits with decimals
2.SP2	00000 ~ 99999	02H	4digits with decimals
3.SP3	00000 ~ 99999	03H	3digits with decimals
4.Over-weight	000 ~ 999	04H	3digits with decimals
5.Under-weight	000 ~ 999	05H	3digits with decimals
6.Upper limit	00000 ~ 99999	06H	5digits with decimals
7.Lower limit	00000 ~ 99999	07H	5digits with decimals
8.Near zero	00000 ~ 99999	08H	5digits with decimals
9.Tare setting	00000 ~ 99999	09H	5digits with decimals

◇ Setting Mode 1

Set Point		Command	Number of digits
0.Comparison Inhibit Time	0.00 ~ 9.99	10H	3 digits
1.Judging Time	0.00 ~ 9.99	11H	3 digits
2.Completion time	0.00 ~ 9.99	12H	3 digits
7.Automatic fall compensation coefficient	0 ~ 3	17H	1 digit
8.Average automatic fall compensation times	1 ~ 9	18H	1 digit
9.Automatic fall correction limit	00000 ~ 99999	19H	5digits with decimals

◇ Setting Mode 2

Set Point		Com mand	Digits
0:Selection of comparison to final or over-/under-weight	0 ~ 2	2:Reference OFF 1:Net Weight 0:Gross weight	20H 1digit
1.Selection of comparison to upper and lower limits	0 ~ 2	2:Reference OFF 1:Net Weight 0:Gross weight	21H 1digit
2.Selection of comparison to near zero	0 ~ 2	2:Reference OFF 1:Net Weight 0:Gross weight	22H 1digit
3.Feed / Discharge control mode	0 ~ 2	2:Relay Selection 1:Unloading Control 0:Loading Control	23H 1digit
4.Selection of tare setting	0 ~ 2	2:Relay Selection 1:Active 0:Inactive	24H 1digit
5.Automatic fall compensation ON/OFF	0 ~ 2	2:Relay Selection 1:Active 0:Inactive	25H 1digit
6.Completion signal output mode	0 ~ 2	3:Judging Time is made with te completion output set ON,while holding weight values 2:Relay evaluation 1:Judging Time is made with the completion output set ON. 0:Judging Time is consistently made.	26H 1digit
7.Over-/under-weight comparison mode	0 ~ 3	2:Only the completion timer is output after the small loading signal is set ON and a preset time has elapsed in the judging timer, or after weight values become stable. 1:Only the completion timer is output after the small loading signal is set ON and a preset time has elapsed in the judging timer and weight values become stable. 0:Only the completion timer is output after the small loading signal is set ON and a preset time has elapsed in the judging timer.	27H 1digit

◇ Setting Mode 3

Set Point		Comm and	Number of digits
0.Digital filter	0 ~ 5	30H	1digit
5:32Times 4:16Times 3:8Times 2:4Times 1:2Times 0:OFF			
1.Motion detect (Time)	0.0 ~ 9.9	31H	2digits
2.Motion detect (Width)	00 ~ 99	32H	2digits
3.Zero tracking (Time)	0.0 ~ 9.9	33H	2digits
4.Zero tracking (Width)	00 ~ 99	34H	2digits

◇ Setting Mode 4

Set Point		Command	Number of digits
0.Counterweight weight value	00000 ~ 99999	40H	5digits with decimals
1.Allowable maximum weighing value (Capacity)	00000 ~ 99999	41H	5digits with decimals
2.Minimum scale	000 ~ 100	42H	3digits with decimals
3.Net over	00000 ~ 99999	43H	5digits with decimals
4.Gross over	00000 ~ 99999	44H	5digits with decimals
5.DZ control limit	00000 ~ 99999	45H	5digits with decimals
6.Decimal point position	0 ~ 3	46H	1digit
7.Gravity acceleration correction	01 ~ 16	47H	2digits
8.Displaying times	0 ~ 3	48H	1digit
9.Setpoint LOCK	0,1	49H	1digit

10. Error Code

Error Code and Error Auxiliary Code

When the both codes are zero (0), there is no error detected.

Error Auxiliary Code shows 1 for calibration error, 2 for incorrect weight, and 3 for command error.

Relevant error codes are listed below.

◇ Calibration Error (Error Auxiliary Code = 1) "CAL" LED will be lit.

Description of Calibration Error	Console Message	Error Code
Zero calibration must be repeated.	cErr1	1
Initial tare subtraction exceeds zero adjustment range.	cErr2	2
Initial tare subtraction exceeds zero adjustment range.	cErr3	3
Counterweight weight value exceeds allowable maximum weighing value.	cErr4	4
Counterweight weight value is set in "00000."	cErr5	5
Output of loadcell (weighing machine) does not reach span adjustment range.	cErr6	6
Output of loadcell (weighing machine) is in the negative (minus) side.	cErr7	7
Output of loadcell (weighing machine) is beyond span adjustment range.	cErr8	8
Weight is not stable and calibration is canceled.	cErr9	9

◇ Over Scale (Error Auxiliary Code = 2) "OVR" LED will be lit.

Description of Weight Failure	Console Message	Error Code
A/D converter input over	LoAd	1
A/D converter input minus over	-LoAd	2
Net weight>Net over setpoint	oFL1	3
Gross weight>Allowable Max. weighing value + 9	oFL2	4
Gross weight>Gross weight over setpoint	oFL3	5
Zero error	No specific message	6

◇ Command Error (Error Auxiliary Code = 3) "CMD" LED will be lit.

Command Error	Console Message	Error Code
Command does not exist in command list.	No specific message	1
An attempt was made to write in read only data. An attempt was made to read write only date. Writing was attempted during lock.	No specific message	2
Writing data is not BCD data.	No specific message	3

11. Dimensions

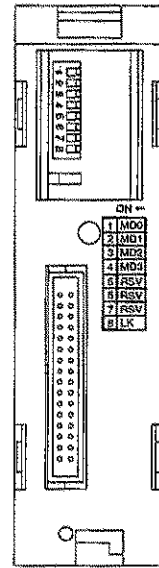
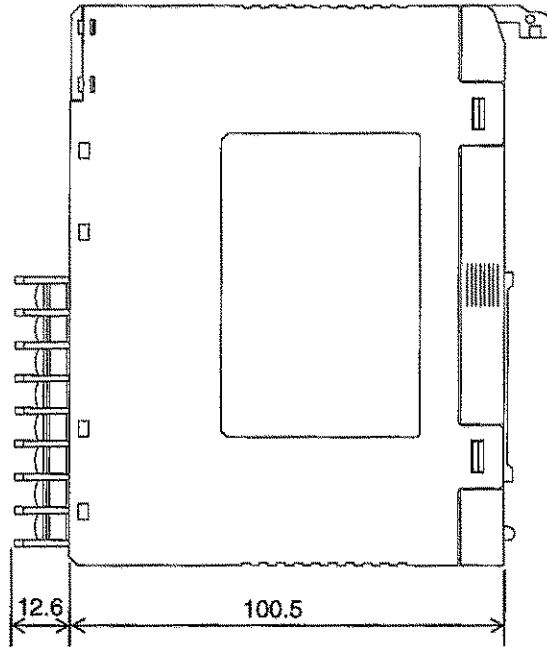
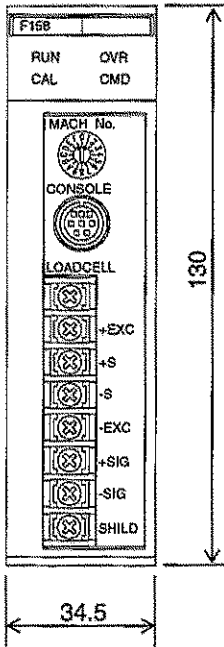
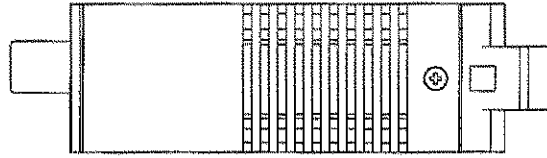

12. Specifications

Analog Section

[1] Terminal board input

6-wire type [+EXC, +S, -S, -EXC, SHIELD, +SIG, -SIG] (Ratio metric system)

[2] Loadcell power supply

DC 5 V \pm 5% Output current 60 mA or less

(Up to 4 sets of 350 Ω loadcells are allowed to connect in parallel.)

[3] Input range

0.0 to 2.2 mV/V

[4] Zero adjustable range

[Initial tare subtraction range] 0 to 2.0 mV/V

[5] Span adjustable range

[Comparison of slope] 0.3 to 2.0 mV/V

[6] Analog filter

Bessel type low-pass filter

Cutoff frequency 2 Hz

-12 dB/oct

[7] Minimum input sensitivity

0.15 (μ V/COUNT)

[8] Accuracy

Non-linearity	: < 0.01% FS.
Zero drift	: < 0.25 μ V/°C RTI.
Gain drift	: < 15 ppm/°C .

[9] A/D converter

Speed	: 100 times/sec.
Resolution	: 16 bit (binary)

[10] Minimum display resolution

1/10000

Display Section**Front Panel LED**

RUN: Illuminates to indicate the unit has been successfully initialized.

CAL: Illuminates to indicate any calibration error has occurred. Keeps blinking while calibration is in progress.

OVR: Illuminates to indicate the status of weight error is set ON.

CMD: Indicates any incorrect setting.

Setting Section**[1] Rear setting DIP SW**

1: MD0 [MODE0]	Sets active setting and registration.
2: MD1 [MODE1]	Sets active setting and displaying.
3: MD2 [MODE2]	Reserved
4: MD3 [MODE3]	Reserved
5: RSV [RESERVE] (Reserved)	
6: RSV [RESERVE] (Reserved)	
7: RSV [RESERVE] (Reserved)	

8: LK [LOCK]

(Disables calibration when set ON)

A combination of MD0 through MD3 allows selection of operation mode.

[2] Machine No. selector rotary switch

Selects Machine No. for high-performance I/O unit.

The switches in [1] and [2] become operative when the power is turned ON.

[3] Setpoint

(1) Calibration and setting method

Available from the setting remote console unit (compatible with C110 and C120) or PLC.

(2) Storage of setpoint

NOV RAM (Nonvolatile RAM)

(3) Protection of setpoint

Setting operation may be protected (LOCK) to prevent any accidental change of initial setting values or calibrated values.

(4) Setting items

Setting command

(Setting values not stored)

Upper limit / Lower limit / Near zero / Final / SP1 / SP2 / SP3 / Tare setting / Overweight / Underweight
(Setting values stored in NOV RAM)

Digital filter / Motion detect / Zero tracking / Counterweight weight value / Allowable maximum weighing value / Minimum scale / Digital zero control limit/ / Gravitational acceleration correction / Net over / Gross weight over / Compensation Inhibit Timer / Judging Timer / Complete Time / Decimal point position / Setpoint LOCK / Displaying times / Automatic fall compensation coefficient / Average count of fall compensation / Automatic fall compensation limit / Final,Over/Under comparison / Upper/Lower Limit comparison / Near Zero comparison / Discharge control mode section / Selection of tare weight setting / Automatic fall compensation ON/OFF / Completion signal output mode/ / Over/under comparison mode

Operation command

Zero calibration (Registration of initial tare subtraction) / Span calibration (Registration of inclination) / Tare subtraction / Tare subtraction reset / Digital zero / Digital zero reset

C110 and C120: Allows monitoring of gross weight / net weight / tare weight, changing and registration of all setting commands, and execution of all operation commands.

General Performance

[1] Current consumption

When four (4) sets of 350 Ω series loadcells are connected: Approx. 400 mA
(with setting remote console unit connected)

[2] Operating environment

Temperature: Operating temperature range: 0 °C - +40 °C

Storage temperature range: -20 °C - +75 °C

Humidity: 10% - 85% RH (No condensation)

[3] Outside dimensions

34.5 W x 130 H x 101 D (mm) (without projections included)

[4] Weight

Approx. 330 g



CAUTION

F158 cannot be used on remote I/O slave.

UNIPULSE

UNIPULSE Corporation

7-16-3 Ginza, Chuo-ku, Tokyo, 104-0061, JAPAN
Tel. 81-3-5148-3000 Fax. 81-3-5148-3001