

Indicator M22

22-dia. and 25-dia. Round Indicator Series

- Easy mounting and removal of Socket Unit.
- Use 25-dia. ring to install in 25-dia. panel cutouts.
- Finger protection mechanism on Lamp provided as a standard feature.
- UL and cUL approved (File No. E41515)

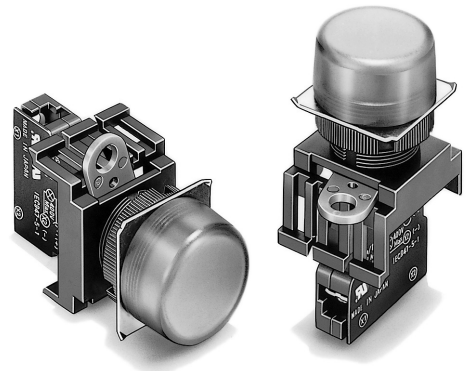

Model Number Structure

Model Number Legend

Completely Assembled

Shipped as a set which includes the Display, Lamp, and Socket Unit.

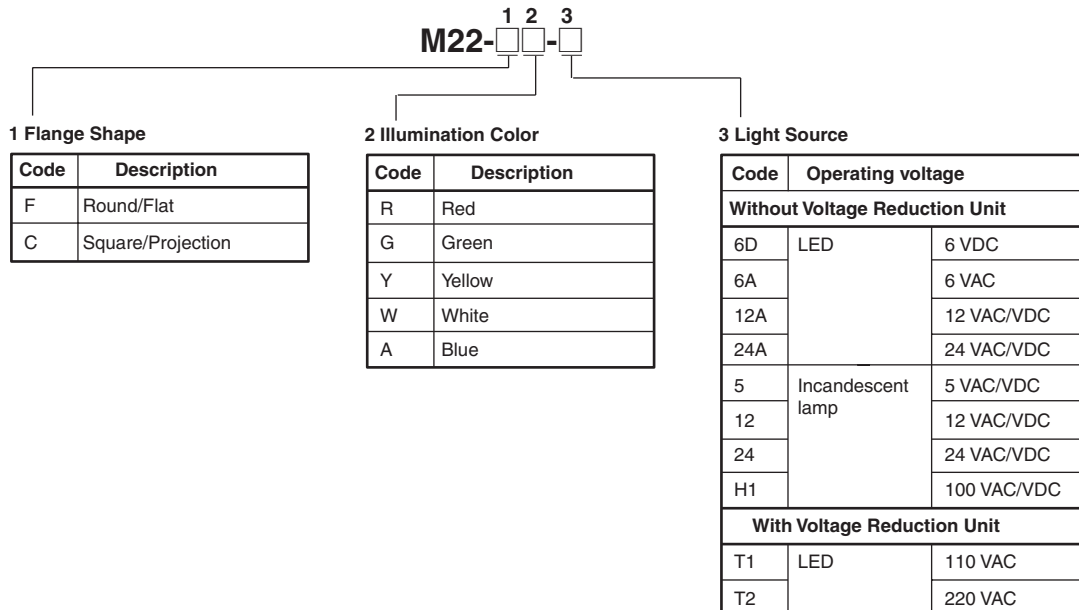

Note: The LED lamp (24 VAC/VDC) can be lit by directly applying 110 VAC/VDC (220 VAC/VDC) to the lamp terminal. LED incorporates the 24-VAC/VDC type.

Pushbutton Switches

Subassembled

The Display, Lamp, or Socket Unit can be ordered separately. Use them in combination for models that are not available as assembled Units. These can also be used as inventory for maintenance parts.

1. Display

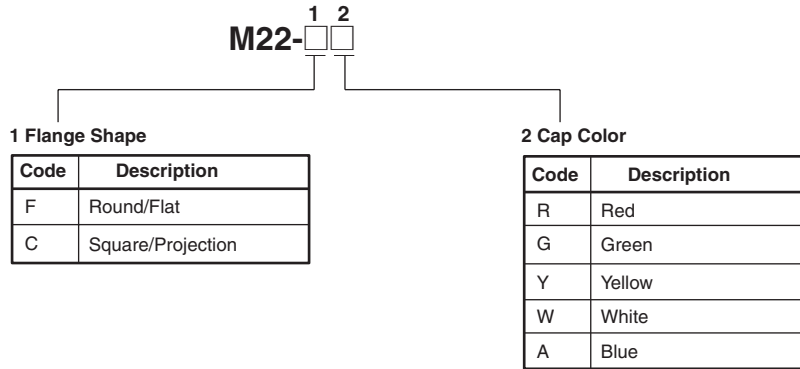

2. Lamp

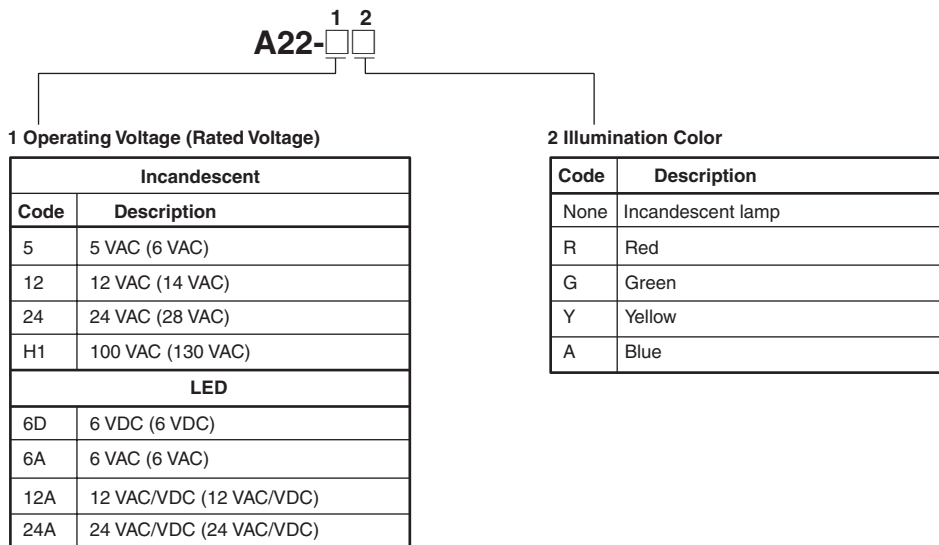

3. Socket Unit

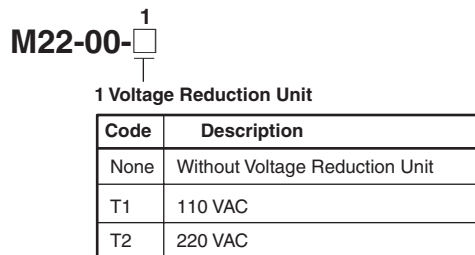





Ordering Information

■ List of Models

Completely Assembled



Indicator

Appearance	Lighting	Operating voltage	Model	Illumination color
Round/Flat without Voltage Reduction Unit  M22-F	LED	6 VDC	M22-F□-6D	Insert one of the following letters into the box □. R (red) Y (yellow) G (green) W (white) A (blue)
		6 VAC	M22-F□-6A	
		12 VAC/VDC	M22-F□-12A	
		24 VAC/VDC	M22-F□-24A	
Round/Flat with Voltage Reduction Unit  M22-F		110 VAC	M22-F□-T1	
		220 VAC	M22-F□-T2	
Square/Projection without Voltage Reduction Unit  M22-C		6 VDC	M22-C□-6D	
		6 VAC	M22-C□-6A	
		12 VAC/VDC	M22-C□-12A	
		24 VAC/VDC	M22-C□-24A	
Square/Projection with Voltage Reduction Unit  M22-C	110 VAC	M22-C□-T1		
	220 VAC	M22-C□-T2		

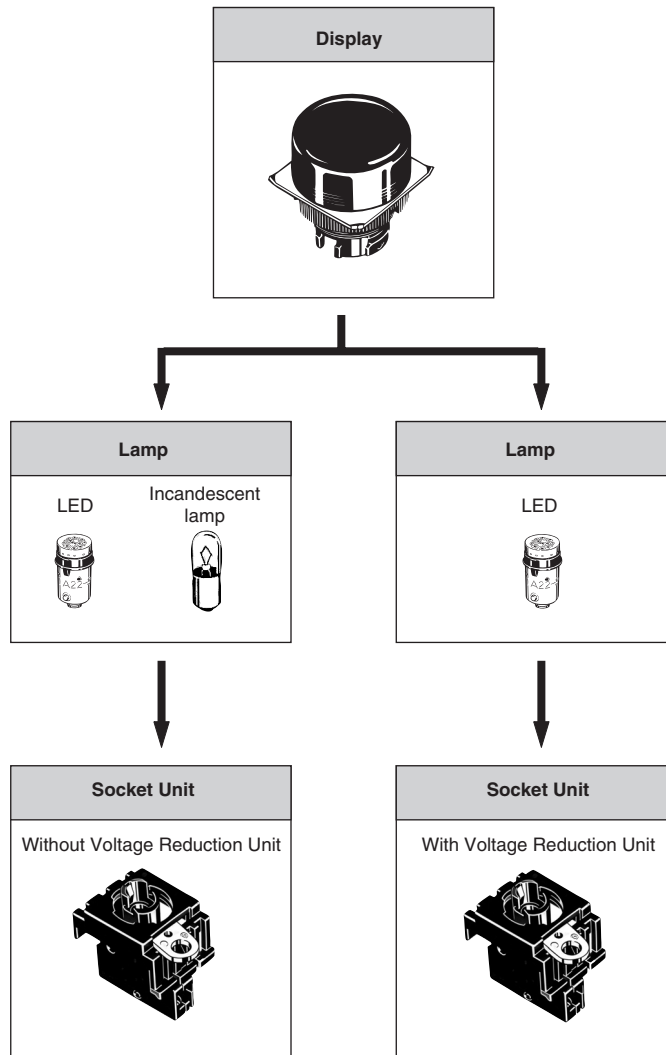
Subassembled



Display

Appearance	IP65 oil-resistant	
	Color of Display	Model
Round/Flat  M22-F	Red	M22-FR
	Green	M22-FG
	Yellow	M22-FY
	White	M22-FW
	Blue	M22-FA
Square/Projection  M22-C	Red	M22-CR
	Green	M22-CG
	Yellow	M22-CY
	White	M22-CW
	Blue	M22-CA

Lamp

LED

Appearance	Operating voltage		6 V	12 V	24 V	24 V Super-bright
	AC/DC	LED light	Model			
	AC	Red	A22-6DR	---	---	---
		Green	A22-6DG	---	---	---
		Yellow (see note 2)	A22-6DY	---	---	---
		Blue	A22-6DA	---	---	---
	DC	Red	A22-6AR	---	---	---
		Green	A22-6AG	---	---	---
		Yellow (see note 2)	A22-6AY	---	---	---
		Blue	A22-6AA	---	---	---
	AC and DC	Red	---	A22-12AR	A22-24AR	A22-24ASR
		Green	---	A22-12AG	A22-24AG	A22-24ASG
		Yellow (see note 2)	---	A22-12AY	A22-24AY	A22-24ASY
		Blue	---	A22-12AA	A22-24AA	A22-24ASA

Note: 1. For voltage-reduction lighting, use the A22-24A□.
 2. Used when the Display color is yellow or white.

Incandescent

Operating voltage	6 VAC/VDC	12 VAC/VDC	24 VAC/VDC	100 VAC/VDC
	A22-5	A22-12	A22-24	A22-H1

Case

Appearance	Type		Model
	IP40	Rectangular	A16-CJM
		Square	A16-CAM
		Round	A16-CTM
	IP65 oil-resistant	Rectangular	A165-CJM
		Square	A165-CAM
		Round	A165-CTM

Socket Unit

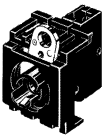
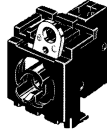
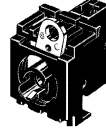
Voltage-reduction circuits		
Without Voltage Reduction Unit	With Voltage Reduction Unit	
		
Without Voltage Reduction Unit M22-00	With Voltage Reduction Unit (110 VAC) M22-00-T1	With Voltage Reduction Unit (220 VAC) M22-00-T2

Note: For voltage-reduction lighting, use the A22-24A□.

Accessories (Order Separately)

The M22 uses the same accessories as the A22. Refer to the relevant information in the corresponding section for the A22.

Specifications

■ Approved Standards

Recognized organization	Standards	File No.
UL, cUL (see note)	UL508	E41515

Note: cUL: CSA C22.2 No. 14

■ Approved Standard Ratings

UL, cUL (File No. E41515)

2-6W, 120 V max.

■ Ratings

LED Lamp

Rated voltage	Rated current	Operating voltage
6 VDC	60 mA (20 mA)	6 VDC±5%
6 VAC	60 mA (20 mA)	6 VAC±5%
12 VAC/VDC	30 mA (10 mA)	12 VAC/VDC±5%
24 VAC/VDC	15 mA (10 mA)	24 VAC/VDC±5%

Note: The values in parentheses are for blue indicators.

Super-bright LED Indicator

Rated voltage	Rated current	Operating voltage
24 VAC/VDC	15 mA	24 VAC/VDC±5%

Incandescent Lamp

Rated voltage	Rated current	Operating voltage
6 VAC/VDC	200 mA	5 V
14 VAC/VDC	80 mA	12 V
28 VAC/VDC	40 mA	24 V
130 VAC/VDC	20 mA	100 V

Voltage-reduction Lighting

Rated voltage	Operational voltage	Applicable lamp (BA9S/13□ gold)
110 VAC	95 to 115 VAC	LED lamp (A22-24□)
220 VAC	190 to 230 VAC	

■ Characteristics

Item	Indicator	
	M22	
Insulation resistance	100 MΩ min. (at 500 VDC)	
Dielectric strength	2,500 VAC, 50/60 Hz for 1 min between terminals of same polarity 2,500 VAC, 50/60 Hz for 1 min between terminals of different polarity and also between each terminal and ground	
Vibration resistance	Malfunction (See note 2.): 10 to 55 Hz, 1.5-mm double amplitude	
Shock resistance	Mechanical	1,000 m/s ²
	Malfunction (See note 2.)	600 m/s ² max.
Ambient temperature (See note 1.)	Operating: -20°C to 55°C Storage: -40°C to 70°C	
Ambient humidity	Operating: 35°C to 85°C	
Degree of protection	IP65	
Electric shock protection class	Class II	
PTI (tracking characteristic)	175	
Degree of contamination	3 (IEC947-5-1)	

Note: 1. With no icing or condensation.
2. Malfunction within 1 ms.

Nomenclature

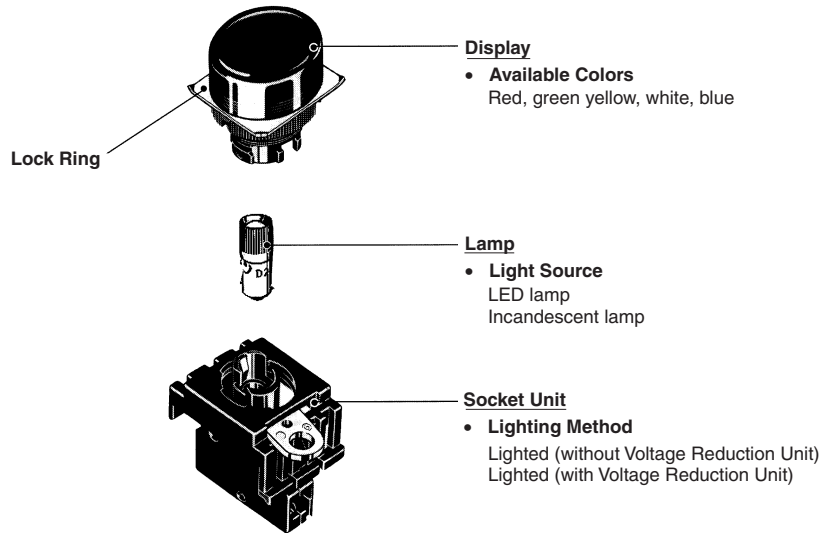

Dimensions

Note: All units are in millimeters unless otherwise indicated.

Indicators

Round/Flat

M22-F

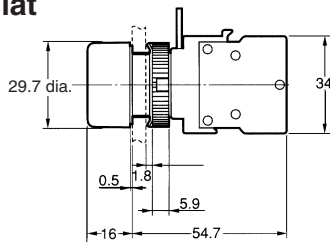

Square/Projection

M22-C

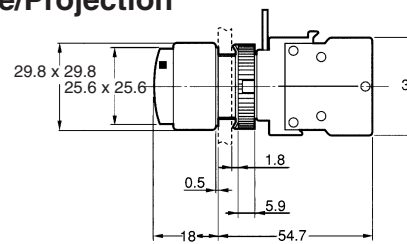

Accessories

The M22 uses the same accessories as the A22. Refer to the relevant information in the corresponding section for the A22.

Terminal Arrangement (Bottom View)

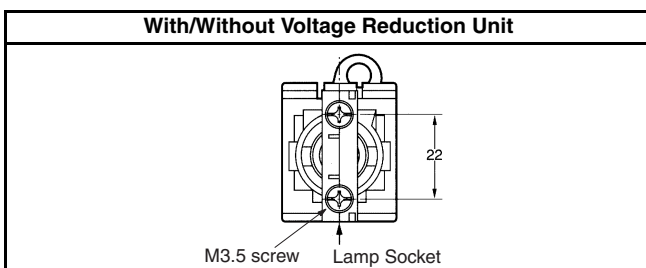

Terminal Connection

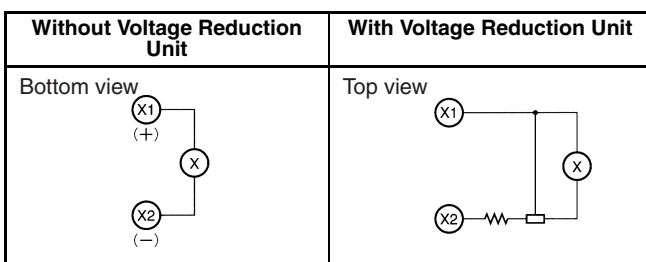

Panel Cutouts (Top View)

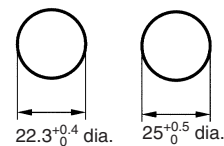

- Note:**
1. When applying coating such as paint to the panel, the dimensions should be those after the application of coating. Lock Ring is provided as a standard item.
 2. Recommended panel thickness: 1 to 5 mm.
 3. Use an A22Z-R25 Ring when mounting to a panel with 25-mm holes.

Installation

The M22 uses the same installation method as the A22. Refer to the relevant information in the *Installation* section for the A22.

Precautions

The precautions for the M22 are the same as those for the A22. Refer to the relevant information in the *Precautions* section for the A22 and the *Technical Information for Pushbutton Switches* (Cat. No. A143).

ALL DIMENSIONS SHOWN ARE IN MILLIMETERS.
To convert millimeters into inches, multiply by 0.03937. To convert grams into ounces, multiply by 0.03527.