

Network-Ready Vision System Series

F210ETN / F500ETN

*Ultimate Power - High Resolution (F500)
Network-Ready Vision System*

- Two digital camera ports, high resolution (1K x 1K) with F500ETN
- Advanced real time data logging and storage functions
- 10/100 Base TX Ethernet Port, USB, RS232/422, 33 digital I/O
- Optional VisionComposerNET for remote configuration/maintenance
- Security tools, audit trail creation in security sensitive environment



Ordering information

Name		Model	Remarks
Controller	Standard Resolution	F210-C10-ETN	NPN Input / Output
		F210-C15-ETN	PNP Input / Output
	High Resolution	F500-C10-ETN	NPN Input / Output
		F500-C15-ETN	PNP Input / Output
Camera	250 K Pixel	F210-S1	For F210ETN only
	1 M Pixel	F500-S1	For F500ETN only
Monitor		F150-M05L	5.5" color TFT LCD
		F500-M10L	10.4" color TFT LCD
Console		F150-KP	Standard Console
		F-160-KP	Console with additional function keys
Memory Cards		F160-N64S(S)	Memory capacity 64 MB
		F160-N256S	Memory capacity 256 MB
PC-Software		F500-CD3E	Optional remote configuration software (via ETN)
Application Software		F500-UM3ME	With macro function
		F500-UM3FE	Without macro function
High precision Lenses		F500-LE16	focal length 16 mm
		F500-LE25	focal length 25 mm
		F500-LE50	focal length 50 mm
Camera cable		F500-VS2	Available lenght 2 m, 5 m, 10 m
Monitor cable		F500-VM	Cable length 2 m
Parallel cable		F160-VP	Loose-wire cable for parallel I/O connectors. Cable length 2 m

Specifications

Controller

Model	F210-C10-ETN / F210-C15-ETN	F500-C10-ETN / F500-C15-ETN
Connected Camera	F210-S1	F500-S1
No. of connectable Cameras	2	2
Processing resolution	512x484 (HxV)	1024x1024 (HxV)
No. of scenes	32 (Can be increased using Memory Cards.)	32 (Can be increased using Memory Cards.)
Image memory function	35 images max.	35 images max.
Storage	64 MB non-volatile memory	256 MB non-volatile memory
Operation and settings	Measurement items installed using Applications Software. Menu operations used to combine measurement items. Vision Composer Net can be used for operation and settings.	Measurement items installed using Applications Software. Menu operations used to combine measurement items. Vision Composer Net can be used for operation and settings.
Menu language	Japanese or English (switchable)	Japanese or English (switchable)
Serial communications	USB series B: 1 channel RS-232C/422: 1 channel	USB series B: 1 channel RS-232C/422: 1 channel
Network communications	Ethernet 100Base-TX/10Base-T	Ethernet 100Base-TX/10Base-T
Parallel I/O	11 inputs, 22 outputs	11 inputs, 22 outputs
Monitor interface	Composite video output: 1 channel, S-VIDEO output: 1 channel	Composite video output: 1 channel, S-VIDEO output: 1 channel
Memory Card interface	Compact Flash card slot, 1 channel	Compact Flash card slot, 1 channel
Power supply voltage	20.4 to 26.4 VDC	20.4 to 26.4 VDC
Current consumption	2.1 A max. (with two F210-S1 Cameras connected)	2.1 A max. (with two F500-S1 Cameras connected)
Ambient temperature	Operating: 0 to +50 °C Storage: -25 to +65 °C with no icing or condensation	Operating: 0 to +50 °C Storage: -25 to +65 °C with no icing or condensation
Ambient humidity	Operating/storage: 35% to 85% with no condensation	Operating/storage: 35% to 85% with no condensation
Dimensions	100x198x134 mm (WxHxD) (without connectors and other protrusions)	100x198x134 mm (WxHxD) (without connectors and other protrusions)
Weight	Approx. 1.6 kg (Controller only)	Approx. 1.6 kg (Controller only)
Accessories	Ferrite core for Console (1) Setup Manual	Ferrite core for Console (1) Setup Manual

Digital Interface Cameras

Model	F210-S1	F500-S1
Imaging device	1/3-inch CCD	2/3-inch CCD
Pixel size	7.4x7.4 μm (HxW)	6.45x6.45μm (HxW)
Shutter	Electronic shutter, 8 shutter speeds (1/60 to 1/12,000 s), changed via menu	Electronic shutter, 10 shutter speeds (1/24 to 1/10,000 s), changed via menu
Partial function	Seven settings	Four settings
Communications interface	Conforms to Camera Link	Conforms to Camera Link
Ambient temperature	Operating: 0 to +50 °C Storage: -25 to +60 °C with no icing or condensation	Operating: 0 to +50 °C Storage: -25 to +60 °C with no icing or condensation
Ambient humidity	Operating/storage: 35% to 85% with no condensation	Operating /storage: 35% to 85% with no condensation
Dimensions	43x43x49 mm (WxHxD) (without connectors and other protrusions)	50x40x90 mm (WxHxD) (without connectors and other protrusions)
Weight	Approx. 110 g	Approx. 270 g
Accessories	Instruction Manual	Instruction Manual

















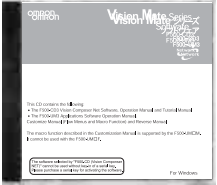

Monitor

Model	F500-M10L
Size in inches	10.4 inches
Type	LCD TFT
Resolution	640 x 480
Brightness	350 cdm/m (typical)
Input signal	NTSC composite video (1.0 V / 75 Ω termination), S-VIDEO
Power supply voltage	20.4 to 26.4 VDC
Current consumption	1.0 A max.
Ambient temperature	Operating: 0 to +50 °C Storage: -20 to +65 °C with no icing or condensation
Ambient humidity	Operating/storage: 30% to 80% with no condensation
Dimensions	285x225x49 mm (WxHxD)
Weight	Approx. 1.8 kg
Accessories	Instruction Manual, 4 mounting brackets

System Requirements for F500-CD3E Vision Composer Net

CPU	Pentium III 600 MHz min. (Pentium III 1 GHz min. recommended)	
OS	Windows 2000 Professional, Service Pack 4 or higher Windows XP Home Edition, Service Pack 2 or higher Windows XP Professional, Service Pack 2 or higher	
Memory	192 MB min. (256 MB min. recommended)	
Hard disk	300 MB min. available space	
Monitor	Resolution: 1,024 x 768 min. Display colors: High Color (16-bit) min. (True Color (32-bit) min. recommended)	
Network	10BaseT-compliant network (100Base-TX recommended)	
Vison Sensor	Controller	F210-C10-ETN/F210-C15-ETN, F500-C10-ETN / F500-C15-ETN
	Application software	F500-UM Version 3.00 or later

System Configuration

<p>CCTV Lenses^{*2}</p>  <p>3Z4S-LE C1614A</p>  <p>3Z4S-LE B2514D</p>  <p>3Z4S-LE B5014A</p>	<p>Controllers</p>  <p>F210-C10-ETN (NPN) F210-C15-ETN (PNP)</p>  <p>F500-C10-ETN (NPN) F500-C15-ETN (PNP)</p>	<p>Application Software</p>   <p>F500-UM3ME/3FE</p> <p>PC Support Software^{*1}</p>  <p>F500-CD3E</p>
<p>High-precision Lenses</p>  <p>F500-LE16</p>  <p>F500-LE25</p>  <p>F500-LE50</p>	<p>Monitors</p>  <p>F500-M10L</p>  <p>F150-M05L</p>	<p>Consoles</p>  <p>F150-KP</p>  <p>F160-KP</p>
<p>Digital Interface Cameras</p>  <p>F210-S1</p>  <p>F500-S1</p>		<p>Camera Cables^{*3}</p> <p>F500-VS2 2M</p>  <p>Monitor Cable</p> <p>F150-VM 2M</p> 

*1 Vision Composer Net and Vision Composer Watcher are bundled with personal computer software.
 *2 A variety of CCTV Lenses are available in addition to those shown above.
 *3 In addition to the standard 2-meter cable length, 5- and 10-meter lengths are available.

Software

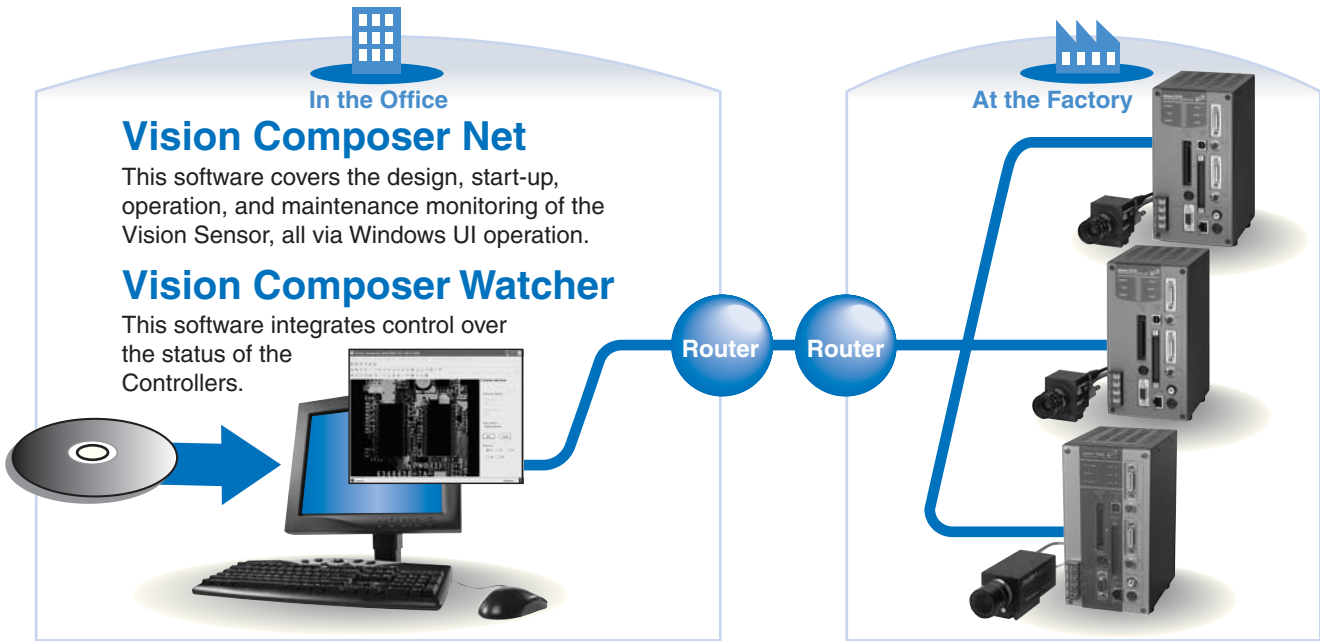

Vision Composer Net

Security Function

The security function allows you to classify the operations of registered users into three ranks (Administrator, Supervisor, or Operator) depending on their access privileges.

Administrator	Change system data Register users Add access privileges
Supervisor	Add model data Re-register models Change inspection items
Operator	Change criteria Change display screens Adjust inspection regions

Screen Captures

Previously, images were stored via a Compact Flash Card inserted into the Controller. It is now possible to capture network-transferred live images on a personal computer at any desired point in time.

Capture on personal computer

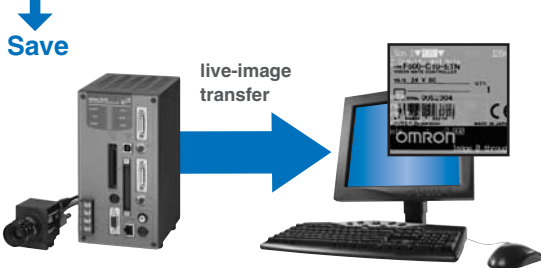

Recording

Live images sent by the Controller can be recorded by a personal computer using the AVI format. Effective for trend control.

Recorded by personal computer

Saved in AVI format

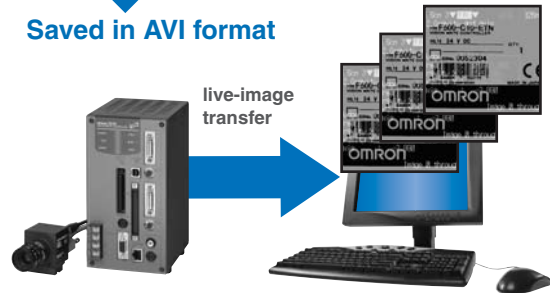

Logging

This function lets you accumulate a variety of production data, including images, measurement values, time stamps, production quantity, and defect rates. The macro function in the Controller then makes it possible to process this into the form of data that you need.

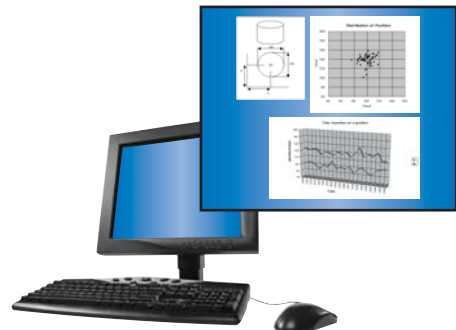

Dimensions

Controller

F210-C10-ETN / F210-C15-ETN
 F500-C10-ETN / F500-C15-ETN

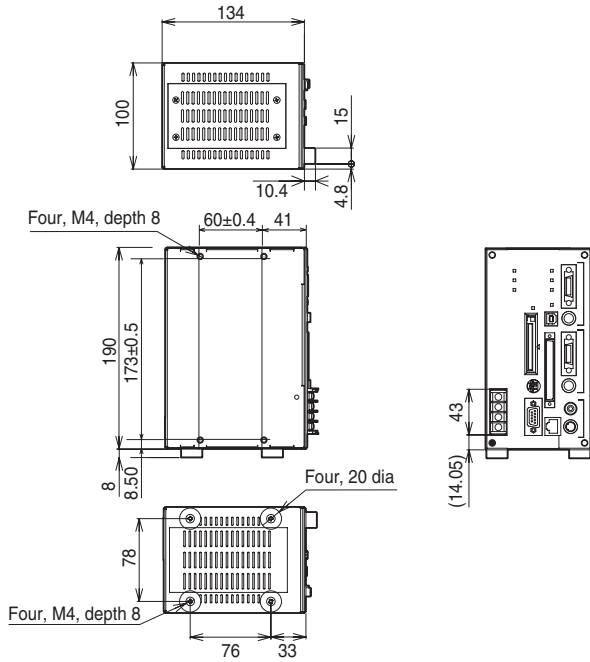

Cameras

F210-S1

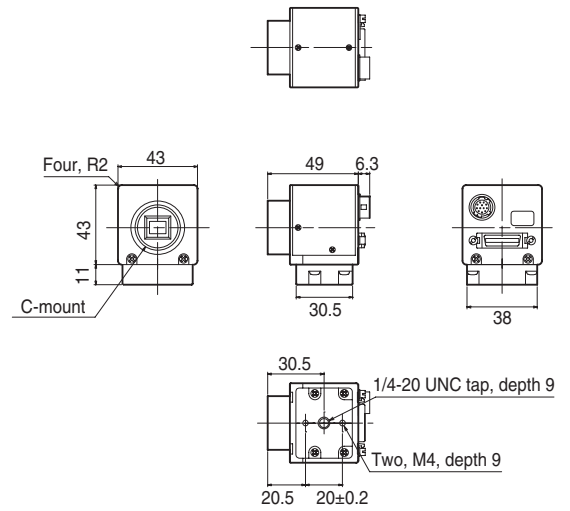

F500-S1

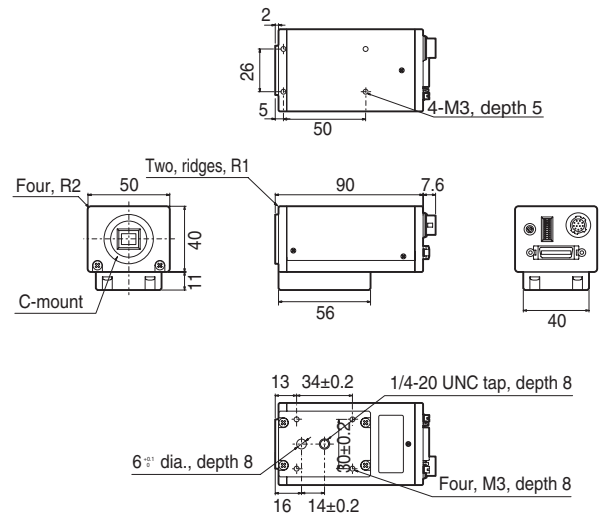

Cat. No. Q143-E2-01-X

In the interest of product improvement, specifications are subject to change without notice.

OMRON EUROPE B.V.

Wegalaan 67-69,
NL-2132 JD, Hoofddorp,
The Netherlands
Phone: +31 23 568 13 00
Fax: +31 23 568 13 88
www.eu.omron.com
